



# COMAND

## Operating Instructions

COMAND Operating Instructions



2515845682

Order no. 6515 6927 13 Part no. 251 584 56 82 Edition Edition A 2012



Mercedes-Benz

## **Welcome to the world of Mercedes-Benz**

Before you drive off, familiarize yourself with your COMAND control panel and read this manual. This will help you to obtain the maximum use from your COMAND control panel and to avoid endangering yourself and others.

Depending on the model and equipment level, the functions and equipment of your COMAND control panel may deviate from certain descriptions and illustrations.

Mercedes-Benz is constantly updating its systems to the state of the art and therefore reserves the right to introduce changes in design, equipment and technical features at any time.

You cannot, therefore, base any claims on the data, illustrations or descriptions in this manual.

Consult an authorized Mercedes-Benz Center if you have further questions.

This manual is an integral part of the vehicle. You should always keep it in the vehicle and pass it on to the new owner if you sell the vehicle.

The technical documentation team at Daimler AG wishes you safe and pleasant motoring.

<b>Index</b> .....	<b>4</b>	<b>At a glance</b> .....	<b>13</b>
<b>Introduction</b> .....	<b>11</b>	<b>System settings</b> .....	<b>35</b>
		<b>Navigation</b> .....	<b>45</b>
		<b>Telephone</b> .....	<b>93</b>
		<b>Audio</b> .....	<b>115</b>
		<b>Video</b> .....	<b>149</b>
		<b>Rear Entertainment System</b> .....	<b>159</b>
		<b>Voice Control</b> .....	<b>177</b>

## A

<b>Active partition (USB devices only)</b>	
Selecting .....	146
<b>Address book</b>	
Browsing .....	109
Calling up .....	109
Changing an entry .....	111
Connecting a call .....	111
Creating an entry .....	109
Deleting an entry .....	110
Details about an entry .....	110
Importing contacts .....	113
Searching for an entry .....	109
Starting route guidance .....	112
voice control with .....	191, 202, 206
Voice tag .....	112
<b>Address book entry</b>	
Adopting as a home address .....	77
Showing the details .....	110
<b>Address entry (example)</b> .....	49
<b>Address entry menu</b> .....	49
<b>Address of destination (See also Destinations)</b>	
entering with voice commands .....	185
<b>Alternative route</b> .....	70
<b>Area</b>	
Avoiding .....	85
<b>Audio</b>	
voice control .....	178
<b>Audio Aux (auxiliary)</b>	
voice commands for .....	199
<b>Audio AUX jack</b> .....	147
<b>Audio CD/DVD or MP3 mode</b>	
Switching to .....	129
<b>Audio DVD</b>	
Pause function .....	167
Stop function .....	131
<b>Audio format</b>	
Setting (audio DVD mode) .....	135
<b>Autostore</b> .....	118
<b>Auxiliary (Aux) operation</b>	
voice commands for .....	199
voice control with .....	204

## B

<b>Back button</b> .....	16
<b>Bird's-eye view</b> .....	83
<b>Bluetooth®</b>	
Activating/deactivating .....	40
Authorizing a device .....	41
Devices .....	41
External authorization .....	42, 97
General information .....	40
Interface .....	95
Settings .....	40
Telephony .....	94, 95
<b>Bluetooth® interface</b>	
Telephony .....	94
<b>Bluetooth® interface telephony</b>	
Conditions .....	95
<b>Bluetooth® telephone list</b> .....	96

## C

<b>Call</b>	
Accepting .....	100, 114
Connecting .....	100
Ending .....	114
Rejecting .....	100, 114
<b>Calling (See also Telephone)</b>	
voice control with .....	181, 193
<b>Call list</b>	
Opening and selecting an entry .....	106
<b>Call lists</b> .....	106
Displaying details .....	106
Saving an entry in the address book .....	107
Storing an entry which has not yet been stored .....	107
<b>Categories</b>	
satellite radio .....	195
<b>Category</b>	
Satellite radio .....	123
<b>CD</b>	
Copy protection .....	137
Data medium .....	137
General information .....	137
Multisession .....	136
Playback options .....	135
Selecting a medium .....	132
Selecting a track .....	132



- CD/DVD**  
 Ejecting (DVD drive) ..... 128  
 Inserting (DVD changer) ..... 127  
 Inserting (Rear Seat Entertainment System) ..... 164
- CD audio, main vehicle**  
 voice control with ..... 198, 203
- Changing direction**  
 Announcement phase ..... 66  
 Change of direction phase ..... 66  
 Preparation phase ..... 65
- Channel presets** ..... 117
- Channel selection (satellite radio)**  
 voice commands for ..... 196
- Character entry** ..... 22
- Characters**  
 Entering ..... 23, 25
- City**  
 Entering ..... 49
- City center, selecting as destination** ..... 187
- Clear button** ..... 16
- COMAND**  
 Basic functions ..... 26  
 Switching on/off ..... 26
- COMAND display** ..... 17  
 Setting ..... 36  
 Switching on/off ..... 27
- COMAND operating system** ..... 14
- Commands for voice control** ..... 199  
 for address book ..... 192, 202  
 for CD, DVD, MP3 ..... 198, 203  
 for navigation ..... 185, 200  
 for phone operation ..... 181, 200  
 for radio and satellite radio .... 194, 203  
 general commands ..... 199
- Copy protection (CD/DVD)** ..... 137
- Crosshair position**  
 Saving ..... 82
- D**
- Data carrier**  
 MUSIC REGISTER ..... 137  
 Video DVD ..... 153
- Data medium**  
 Audio DVD ..... 136, 165  
 CD/DVD ..... 137  
 MP3 ..... 136
- Date format**  
 Setting ..... 37
- Deleting**  
 Call lists ..... 108
- Destination**  
 Adopting from the list of previous destinations ..... 78
- Destination entry** ..... 48  
 Address ..... 48  
 Destination memory ..... 54  
 Intermediate stop ..... 57  
 Last destination ..... 55  
 Map ..... 56  
 Point of interest ..... 60
- Destination information** ..... 71
- Destination memory** ..... 77  
 Deleting an entry ..... 79  
 My address ..... 77  
 Storing a destination ..... 78
- Destination memory (See also Last Destinations)**  
 saving destinations to ..... 189  
 voice control for ..... 189
- Destinations**  
 saving to destination memory ..... 189  
 Search & Send ..... 59  
 voice control with ..... 185
- Dialog**  
 see Voice control
- Digital map**  
 Updating ..... 89
- Display, main**  
 with voice command ..... 180
- District, selecting as destination**  
 with voice commands ..... 187
- DTMF tones**  
 Sending ..... 101

- DVD**
- Copy protection ..... 137
  - Data medium ..... 137
  - Selecting a track ..... 132
- DVD audio, main vehicle**
- voice control with ..... 198, 204
- DVD menu** ..... 154
- DVD playback conditions** ..... 151
- DVD video**
- voice control with ..... 199, 205
- DVD-Video**
- Picture settings ..... 150
- DVD-Video Operation**
- Automatic picture shutoff ..... 150
- E**
- Entry**
- Deleting ..... 24
  - Saving ..... 26
  - Selecting ..... 104
- External audio or video devices**
- voice control with ..... 199
- External authorization** ..... 42
- F**
- First list entry**
- Accepting ..... 24
- Freeway information** ..... 88
- Frequency input**
- Manual ..... 117
- Full-screen map and change-of-direction display**
- Switching between ..... 65
- Function restrictions**
- Video DVD mode ..... 151
- G**
- Global voice control commands** ..... 179
- Google Maps®** ..... 59
- Gracenote Media Database** ..... 134
- H**
- Hands-free microphone**
- Switching on/off ..... 101
- Hard disk drive**
- voice control with ..... 204
- Harman/kardon® Logic 7®**
- Surround Sound system** ..... 28
- HD Radio™** ..... 120
- Help with voice control, general** ..... 208
- Home address** ..... 77
- Entering and saving ..... 52
- House numbers, entering for destination** ..... 188
- I**
- Incident (traffic report)** ..... 73
- Individualization** ..... 38
- Intermediate stop**
- Deleting ..... 58
  - Entering ..... 57
- Intersection (selecting)** ..... 187
- iPod®**
- Alphabetic track selection ..... 146
  - Connecting to the Media Interface ..... 142
  - Device version ..... 142
  - Selecting a category/playlist ..... 144
- iTunes®** ..... 146
- L**
- Lane recommendations** ..... 67
- Explanation ..... 68
  - Presentation ..... 68
- Last Destinations**
- voice control for ..... 189
- Lever for voice control** ..... 179
- List as selection list**
- Calling up ..... 24
- List entry**
- Selecting ..... 24
- Listing address book contents** ..... 193
- Local voice control commands** ..... 179
- Logic 7®**
- see harman/kardon® Logic 7® Surround Sound system

**M****Map**

- Arrival time/distance to destination ..... 84
- Calling up ..... 56
- Map display ..... 83
- Moving ..... 56, 82
- Showing geo-coordinates ..... 85
- Showing road names ..... 84

**Map display (also see navigation)**

- Traffic reports ..... 73

**Map information** ..... 84**Map orientation** ..... 83**Map scale**

- Adjusting ..... 81

**Media Interface**

- Active partition ..... 146
- Basic menu ..... 143
- Connection options ..... 141
- iPod® ..... 141
- Metadata ..... 145
- Mode ..... 141
- MP3 player ..... 142
- Selecting categories ..... 144
- Selecting folders ..... 144
- Selecting music files ..... 144
- Selecting playlists ..... 144
- Switching to ..... 143
- USB mass storage device ..... 141

**Media list** ..... 132, 153**Memory cards**

- voice control with ..... 199, 204

**Menu**

- Exiting ..... 29, 48
- Showing ..... 47
- Showing/hiding ..... 152
- System settings ..... 18

**Menu item**

- Selecting ..... 21

**Menu overview**

- COMAND ..... 17

**Messages**

- during voice command ..... 180

**Mobile phone**

- Connecting (Bluetooth® interface) ... 96
- De-authorizing ..... 98

- External authorization ..... 97
- Registering (authorizing) ..... 96

**MP3**

- Bit/sampling rates ..... 136
- Copyright ..... 137
- Data medium ..... 136
- File systems ..... 136
- Formats ..... 136
- Selecting a medium ..... 132

**MP3 mode, main vehicle**

- voice control with ..... 198, 204

**Multifunction steering wheel** ..... 19

- Selecting a track ..... 133
- Telephone ..... 113
- voice control button ..... 179

**Multisession CDs** ..... 136**Music Register**

- Copying music data ..... 138

**MUSIC REGISTER**

- Deleting all music files ..... 140
- Playback options ..... 141
- Switching to ..... 138

**My address**

- see Home address

**N****Navigation (also see route guidance)**

- Traffic report ..... 73

**Navigation (See also Route guidance)**

- voice control with ..... 183, 200

**Navigation announcements** ..... 68, 178

- Switching off ..... 27, 69
- Switching on ..... 69

**Navigation menu**

- Showing/hiding ..... 152, 169

**Navigation mode**

- Switching to ..... 47

**Navigation system displays**

- Multifunction display ..... 69

**North up orientation** ..... 83**Numbers, entering with voice command** ..... 180

## O

<b>Off-map</b> .....	72
<b>Off-road</b> .....	72
<b>Orientation in direction of travel</b> .....	83

## P

<b>Passcode</b>	
Entering .....	42, 97
<b>Pause function</b> .....	131
<b>Phone book</b>	
Adding a number to an address	
book entry .....	105
Calling up .....	102
Creating a new entry .....	104
Deleting an entry .....	104
Icon overview .....	103
voice control with .....	183
<b>Phone book entry</b>	
Searching .....	103
<b>Playback options</b> .....	135, 141, 147
<b>Point of interest</b>	
Category .....	61
Entering .....	60
Entering using the map .....	64
ZAGAT® rating service .....	63
<b>Point of interest icon</b>	
Setting .....	83
<b>Point of interest list</b> .....	62
With character bar .....	64
<b>Points of interest (POIs)</b>	
voice control for .....	188
<b>Previous destinations</b> .....	80
<b>Province of destination, selecting</b> ...	185

## R

<b>Radio</b>	
HD Radio™ .....	120
selecting stations .....	196
voice control with .....	194, 203, 208
<b>Radio mode</b>	
Switching to .....	116
<b>Read-aloud function</b> .....	73
<b>Read-aloud speed</b>	
Setting .....	38
<b>Real-time traffic reports</b> .....	73, 76
<b>Rear-compartment screens</b> .....	30

**Rear Seat Entertainment System**

AUX mode .....	31, 173
CD/DVD audio and MP3 mode .....	164
Changing the batteries .....	160
Cordless headphones .....	32
Multiple users .....	162
Operating with the headphones .....	161
Remote control .....	30
System settings .....	163
Using the main loudspeaker .....	161
Video DVD mode .....	169

**Redialing telephone**

voice control for .....	183
-------------------------	-----

**Redials** .....

.....	100
-------	-----

**Remote control**

Rear Seat Entertainment System .....	30
--------------------------------------	----

**Reset** .....

.....	43
-------	----

**Route browser** .....

.....	71
-------	----

**Route calculation**

Starting .....	51
----------------	----

**Route guidance** .....

Cancel .....	68
Continue .....	68
Continuing .....	68
Destination reached .....	68
Lane recommendations .....	67
navigation announcements .....	178
Off-road .....	72
Traffic reports .....	73
voice control for .....	190

**Route options**

Setting .....	47
---------------	----

## S

**Safety notes**

Audio CD/DVD and MP3	
mode .....	126, 164
Operating safety .....	11
Using the telephone .....	94
Video DVD mode .....	150

**Satellite radio**

category selection .....	196
selecting channels .....	196
voice control with .....	194, 203, 208

**SatRadio** .....

Displaying information .....	125
------------------------------	-----

- Registering ..... 122
  - Selecting a category ..... 123
  - Screen**
    - Selecting for remote operation ..... 31
  - SD memory card**
    - Ejecting ..... 129
    - Inserting ..... 129
  - Search & Send** ..... 59
  - Searching (See also Predictive speller)**
    - address book ..... 194
  - Selecting audio track**
    - voice commands for ..... 198
  - Skipping back**
    - CD/DVD mode ..... 133
  - Skipping forwards**
    - CD/DVD mode ..... 133
  - Sound**
    - Switching on/off ..... 27
  - Sound settings** ..... 27, 150
  - Spelling with voice command** ..... 180
  - State/province**
    - Selecting ..... 49
  - State of destination, selecting** ..... 185
  - Station**
    - Selecting ..... 117
    - Storing ..... 118
  - Station search** ..... 117
  - Station selection (radio)**
    - voice commands for ..... 196
  - Steering wheel** ..... 179
  - Storage options**
    - Selecting ..... 79
  - Street of destination, selecting** ..... 187
  - Summer and standard time**
    - Switching ..... 37
  - Surround sound** ..... 28
  - System language**
    - Setting ..... 43
- T**
- Telephone**
    - Ending an active call ..... 101
    - Entering phone numbers ..... 100
    - Incoming call ..... 100
    - Outgoing call ..... 100
    - Redialing ..... 100
    - Sending DTMF tones ..... 101
    - Single call ..... 101
    - Switching hands-free microphone on/off ..... 101
  - Telephone (See also Calling)**
    - voice control with ..... 181, 200
  - Telephone basic menu**
    - Bluetooth® interface ..... 99
  - Telephone number**
    - Entering ..... 100
  - Time**
    - Setting ..... 37
  - Time format**
    - Setting ..... 37
  - Time zone**
    - Setting ..... 37
  - Tone settings**
    - Balance and fader ..... 28
    - Treble and bass ..... 28
  - Town, selecting as destination** ..... 186
  - Track information** ..... 168
  - Track selection (audio)**
    - voice commands for ..... 198
  - Track selection (video)**
    - voice commands for ..... 198
  - Traffic jam function** ..... 70
  - Traffic Program**
    - Switching off ..... 27
  - Traffic report**
    - Real-time traffic report ..... 76
  - Traffic report read-aloud function** ..... 73
  - Traffic reports** ..... 73
  - Troubleshooting**
    - voice control ..... 206
- U**
- Using the telephone** ..... 100
- V**
- Video**
    - voice control with ..... 205
  - Video DVD**
    - Fast forward/rewind ..... 153
    - Operation ..... 150
    - Pause function ..... 153
    - Selecting a film/title ..... 154

- Selecting a scene/chapter ..... 153
- Stop function ..... 153
- Video DVD mode**
- Switching to ..... 151
- Voice control** ..... 178
- canceling the dialog ..... 180
- command list ..... 199
- creating voice tags ..... 192
- general operation ..... 178
- help function ..... 208
- interrupting the dialog ..... 180
- operating safety ..... 178
- starting the dialog ..... 180
- troubleshooting ..... 206
- with address book ..... 191, 206
- with DVD changer ..... 198
- with external equipment (Aux) ..... 199
- with navigation ..... 183
- with phone ..... 181
- with radio and satellite  
  radio ..... 194, 208
- Voice Control System**
- Individualization ..... 38
- Settings ..... 38
- Voice mail, voice control for** ..... 183
- Voice tags, creating** ..... 192
- Volume**
- Adjusting ..... 27
- Navigation announcements ..... 27
- Phone calls ..... 27
- Traffic reports ..... 27
- Volume (loudness)**
- voice command ..... 180

## W

### Waveband

- Switching (radio) ..... 117

## Z

- ZAGAT® rating service** ..... 63

## Operating safety

### General notes

#### **WARNING**

Any alterations of electronic components or software can cause malfunctions.

Radio, satellite radio, amplifier, DVD changer, navigation module, telephone and Voice Control systems are interconnected.

Therefore, if one of the components is not operational, or has not been removed/replaced properly, the function of other components could be impaired.

Such conditions might seriously impair the operating safety of your vehicle.

We recommend having any service work on electronic components carried out by an authorized Mercedes-Benz Center.

#### **WARNING**

In order to avoid distraction which could lead to an accident, the driver should enter system settings while the vehicle is at a standstill, and operate the system only when permitted by road, weather and traffic conditions.

Bear in mind that at a speed of just 30mph (approximately 50km/h), your car covers a distance of 44feet (approximately 14m) every second.

COMAND supplies you with information to help you select your route more easily and guide you conveniently and safely to your destination. For safety reasons, we encourage the driver to stop the vehicle in a safe place before answering or placing a call, or consulting the COMAND screen to read navigational maps, instructions, or downloaded information.

#### **WARNING**

While the navigation system provides directional assistance, the driver must remain focused on safe driving behavior, especially attention to traffic and street signs, and

should utilize the system's audio cues while driving.

The navigation system does not supply any information on stop signs, yield signs, traffic regulations or traffic safety rules. Their observance always remains in the driver's personal responsibility. DVD maps do not cover all areas nor all routes within an area.

**i Canada only:** This device complies with RSS-210 of Industry Canada. Operation is subject to the following two conditions:

1. This device may not cause interference, and
2. this device must accept any interference received, including interference that may cause undesired operation of the device.

Any unauthorized modification to this device could void the user's authority to operate the equipment.

**i USA only:** This device complies with Part 15 of the FCC Rules. Operation is subject to the following two conditions:

1. This device may not cause harmful interference, and
2. this device must accept any interference received, including interference that may cause undesired operation.

Any unauthorized modification to this device could void the user's authority to operate the equipment.

#### **WARNING**

Change or modification not expressly approved by the party responsible for compliance could void the user's authority to operate this equipment.

**!** Note: This equipment has been tested and found to comply with the limits for a Class A digital device, pursuant to Part 15 of the FCC Rules. These limits are designed to provide reasonable protection against harmful interference when the equipment is operated in a commercial environment. This equipment generates, uses and can



radiate radio frequency energy and, if not installed and used in accordance with the instruction manual, may cause harmful interference to radio communications.

#### **WARNING**

This equipment complies with FCC radiation exposure limits set forth for uncontrolled equipment and meets the FCC radio frequency (RF) Exposure Guidelines in Supplement C to OET65.

This equipment has very low levels of RF energy that is deemed to comply without maximum permissive exposure evaluation (MPE). But it is desirable that it should be installed and operated with at least 8 inches (20 cm) and more between the radiator and a person's body (excluding extremities: hands, wrists, feet and legs.)

#### **Correct use**

Observe the following information when using COMAND:

- the safety notes in this manual
  - all road traffic regulations
- i** Improper work on electronic components or other systems (such as radio, DVD changer) and their software may result in malfunction or failure. Even systems that have not been modified could be affected because the electronic systems are connected. Electronic malfunctions can seriously jeopardize the operational safety of your vehicle.
- i** Only have work or changes to electronic components carried out at a qualified specialist workshop which has the necessary specialist knowledge and tools to carry out the work required. Daimler recommends that you use an authorized Mercedes-Benz Center for this purpose. In particular, work relevant to safety or on safety-related systems must be carried out at a qualified specialist workshop.

- i** Protection against theft: this device is equipped with technical provisions to protect it against theft. Further information on protection against theft can be obtained from an authorized Mercedes-Benz Center.

#### **COMAND features**

These Operating Instructions describe all standard and optional equipment available for your COMAND system at the time of purchase. Country-specific deviations are possible. Please note that your COMAND system may not be equipped with all the features described. This includes safety-related systems and functions. Therefore, the equipment on your COMAND system may differ from that in the descriptions and illustrations. The original purchase agreement lists all systems installed in your vehicle. Contact an authorized Mercedes-Benz Center if you have any questions about equipment or operation.

#### **Function restrictions**

For safety reasons, some COMAND functions are restricted or unavailable while the vehicle is in motion. You will notice this, for example, because you will either not be able to select certain menu items or because COMAND will display a message to this effect.

To protect the integrated hard disk, COMAND deactivates it at very high temperatures and at extreme altitudes. The following functions will be temporarily unavailable:

- navigation system
- Voice Control System
- address book
- MUSIC REGISTER

COMAND operating system .....	14
Multifunction steering wheel .....	19
Operating COMAND .....	19
Basic functions of COMAND .....	26
Rear Entertainment System .....	30
Rear view camera .....	33

## COMAND operating system

## Overview



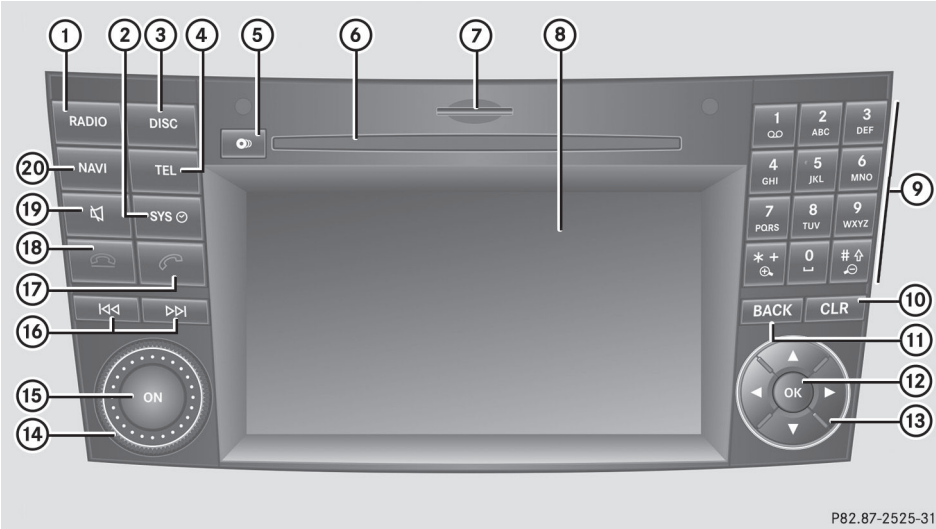













At a glance



P82.87-2525-31

	Function	Page
①	<b>RADIO</b> Switches to radio mode Switches wavebands	116 117
②	<b>SYS</b> Calls up the system menu	17
③	<b>DISC</b> Switches to audio CD/DVD or MP3 mode Switches to video DVD mode	129
④	<b>TEL</b> Calls up the telephone basic menu or the address book	109
⑤	<b>Load/eject button</b>	128

	Function	Page
⑥	<b>Disc slot</b> To insert CDs/DVDs To eject CDs/DVDs Map software updates	127 128 89
⑦	<b>SD memory card slot</b> To insert an SD memory card To eject an SD memory card	129 129
⑧	COMAND display	17

	Function	Page		Function	Page	
⑨	<b>Number pad</b>		⑬	 /  /  / 		
	Selects stations via the station presets	117		Selects a station	117	
	Stores stations manually	117		Selects a track	132	
	Passkey entry	42		Selects a menu item or list entry	21	
	Telephone number entry	100		Exits a menu or list	29	
	Sends DTMF tones	101		Moves the map	56	
	 + 		⑭	Adjusts the volume	27	
	Sets the map scale (zooms in)	81	⑮	Switches COMAND on/off	26	
	 # 		⑯	 / 		
	Sets the map scale (zooms out)	81		Selects a station using the station search function	117	
⑩				Selects the next/previous track	132	
	<b>Press briefly:</b> deletes individual characters	24	Fast rewind/fast forward	133		
	<b>Press and hold:</b> deletes an entire entry	24	⑰			
⑪				Accepts a call	100	
	<b>Press briefly:</b> exits menu and switches to the next menu level up	16	Redials	100		
	<b>Press and hold:</b> switches to the basic display for the currently selected operating mode	16	⑱			
	⑫				Rejects a call	100
<b>Press briefly:</b> Confirms selection or entry		21	Ends an active call	101		
Stores settings	28	⑲				
Shows/hides the menu system	47		Mute	27		
<b>Press and hold:</b> adopts a list entry	24	Switches off navigation announcements	27	⑳		
		Switches to navigation mode	47			

### Back button

- ▶ **To move up one menu level:** briefly press the **BACK** back button.  
COMAND changes to the next higher menu level in the current operating mode.
- ▶ **To switch to the basic display:** press and hold the **BACK** back button.  
COMAND changes to the basic display of the current operating mode.

### Clear button

- ▶ **To delete an individual character:** press the **CLR** clear button briefly.  
COMAND deletes the first character to the left of the cursor from the entry line.
- ▶ **To delete an entire entry:** press and hold the **CLR** clear button.  
COMAND deletes all characters to the left of the cursor from the entry line.

### Function overview

You can use COMAND to operate the following main functions:

- the navigation system
- the audio functions in radio, HD Radio™, SatRadio, audio CD/DVD and MP3 mode (disc, SD memory card), MUSIC REGISTER mode, Media Interface mode and audio AUX mode
- the telephone and the address book
- the video function with video DVD and video AUX modes
- the system settings

You can call up the main functions as follows:

- using the corresponding function buttons
- using the main function bar in the COMAND display

## COMAND display

### Display overview

The COMAND display shows the function currently selected and its associated menus. The COMAND display is divided into several areas.

The radio display is shown in the example.

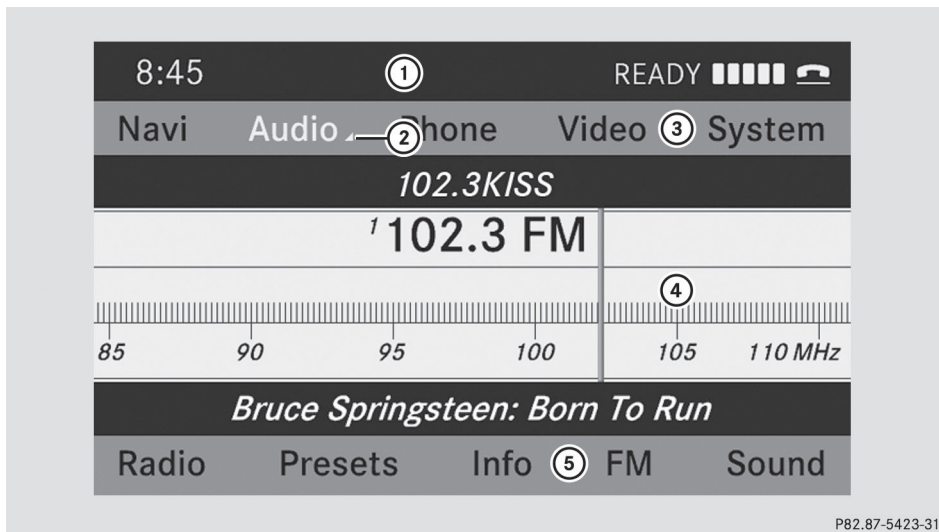

- ① Status bar
- ② Calls up the audio menu
- ③ Main function bar
- ④ Display/selection window
- ⑤ Radio menu bar

Status bar ① shows the time and the current settings for radio and telephone operation.

The main functions, navigation, audio, telephone and video feature additional menus. This is indicated by triangle ②. The following table lists the available menu items.

Main function bar ③ allows you to call up the desired main function.

In the example, the audio main function is set to radio mode and display/selection window ④ is active.

Radio menu bar ⑤ allows you to operate the radio functions.

### Menu overview

The table lists the menus available after calling up the main function navigation, audio, telephone or video in the main function bar.

Navi	Audio	Telephone	Video	System
Map display	Radio	Telephone	AUX	Calls up the system menu
Sets route calculation mode	SatRadio	Address book	Video DVD	
Avoids an area	Disc			
Selects the "Record route" function	Memory card			
Information on map	MUSIC REGISTER			
<input checked="" type="checkbox"/> Freeway information	Media Interface			
<input checked="" type="checkbox"/> Reads out the TMC messages automatically	Rear			
<input checked="" type="checkbox"/> Volume limiter	AUX			

### System menu overview

Settings	Time	Display off
Setting the language	Setting the time	Switching off the display
Display settings	Setting the format	
Read-aloud settings	Setting the time zone	
Voice-operated control settings		
Rear view camera		
Activating/deactivating Bluetooth®		
Resetting COMAND		

If the function is activated and COMAND is switched on, the image of the rear view camera is automatically shown in the COMAND display when reverse gear is engaged.



**Multifunction steering wheel**

**⚠ WARNING**

A driver's attention to the road and traffic conditions must always be his/her primary focus when driving.

For your safety and the safety of others, selecting features through the multifunction steering wheel should only be done by the driver when traffic and road conditions permit it to be done safely.

Bear in mind that at a speed of just 30 mph (approximately 50 km/h), your vehicle is covering a distance of 44 feet (approximately 14 m) every second.

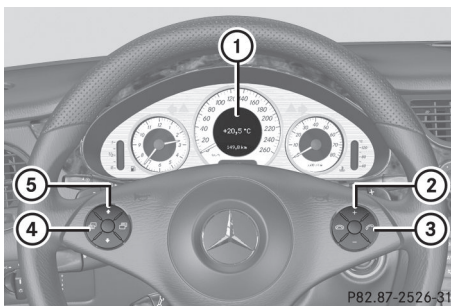

At a glance

	Function	Page
①	Multifunction display	69
②	Increases the volume	27
	Decreases the volume	27
③	Accepts a call	100
	Rejects or ends a call	100
④	Selects a menu	
	Scrolls up	
	Scrolls down (see vehicle Operator's Manual)	
⑤	Selects a submenu or list entry	
	Scrolls up	
	Scrolls down (see vehicle Operator's Manual)	

**Operating COMAND**

**Selecting a main function**

**Initial situation**

You would like to switch from navigation mode (address input menu) to the system settings, for example.

- **To switch to navigation mode:** press the function button.

- ▶ **To show the menu:** press the **OK** button.
- ▶ Select **Destination** using the **▼** **◀** **▶** buttons and press the **OK** button to confirm.
- ▶ Select **Address Entry** and press the **OK** button to confirm.  
The address entry menu appears.

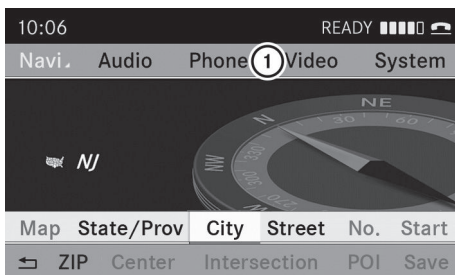

P82.87-5399-31

Address entry menu

- ① Main function bar
- ▶ Press the **▲** button to switch to main function bar ①.
- ▶ Select **System** in the main function bar using the **◀** **▶** buttons and press the **OK** button to confirm.  
The system menu appears.

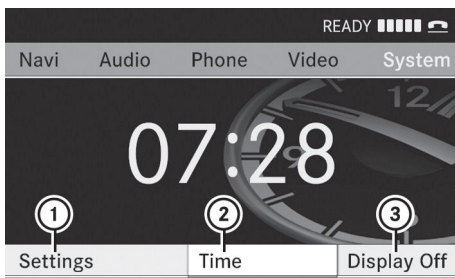

P82.87-3427-31

- ① Settings menu
- ② To set the time
- ③ To switch off the display

### Calling up the menu of a main function

If one of the main functions – navigation, audio, telephone or video – is switched on, triangle ① appears next to the entry. You can now select an associated menu.

The example describes how to call up the audio menu from audio CD mode. Insert a CD/DVD (▷ page 127).



P82.87-5400-31

- ① To call up the audio menu
- ② Main function bar
- ▶ Select **Audio** in the main function bar using the **▲** button and press the **OK** button to confirm.  
The Audio menu appears.



P82.87-3421-31

- ① Dot • indicates the current mode
- ② Main function bar
- ③ Audio menu

The • dot indicates the current audio mode.

- ▶ Select another audio mode, e.g. **Radio**, using the **▲** **▼** buttons and press the **OK** button to confirm.

### Selecting a menu item

The example describes how to select a station from the station presets in radio mode.

- ▶ Press the **RADIO** function button.
- ▶ Select **Presets** using the **▼** **◀** **▶** buttons and press the **OK** button to confirm. The station preset memory appears.

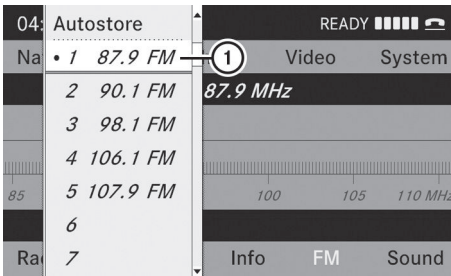

P82.87-3422-31

- ① Selection bar
- ▶ Select a channel using the **▲** **▼** buttons and press the **OK** button to confirm. The station is set.
- ▶ **To exit a menu without making a selection:** press the **◀** or **▶** button.

### Example of operation

#### Initial situation

You would like to switch from the system function to radio mode and select a station from the station list, for example.

The operating example describes how to:

- call up the audio function
- switch on radio mode
- select a station from the station list

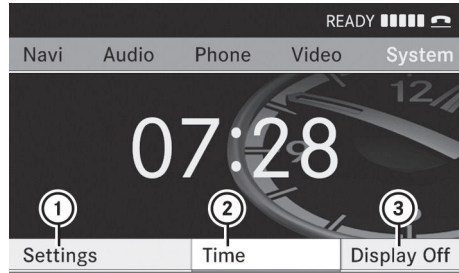

P82.87-3427-31

System menu

- ① Settings menu
- ② To set the time
- ③ To switch off the display

### Calling up the audio function

- ▶ Select **Audio** in the main function bar using the **▲** **◀** **▶** buttons and press the **OK** button to confirm.

The basic display of the current audio operating mode, e.g. audio CD, appears.

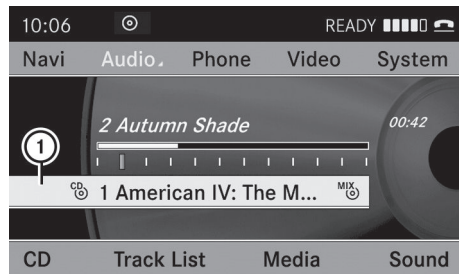

P82.87-2456-31

- ① Selection bar



### Switching to radio mode

#### Option 1

- ▶ Press the **RADIO** function button. The radio display appears.

- ① Repeatedly pressing the **RADIO** function button switches between the FM, MW, SW and LW wavebands in that order.

**Option 2**

- ▶ Select **Audio** again using the  button and press the  button to confirm. The Audio menu appears. **Radio** is highlighted.





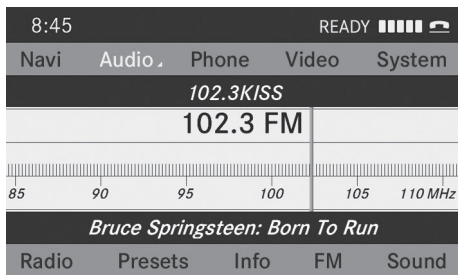

P82.87-3424-31

- ▶ Press the  button to confirm **Radio**. The radio basic display appears showing the previously selected waveband (FM in the example).



P82.87-3425-31

**Calling up the station list**

- ▶ Select **Radio** using the , , and  buttons and press the  button to confirm. The radio menu appears. **Station list** is highlighted.

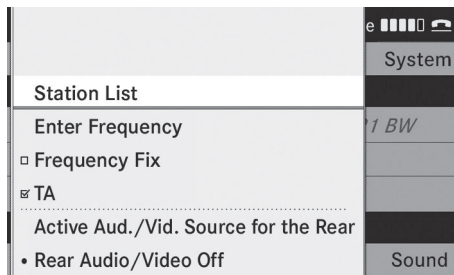

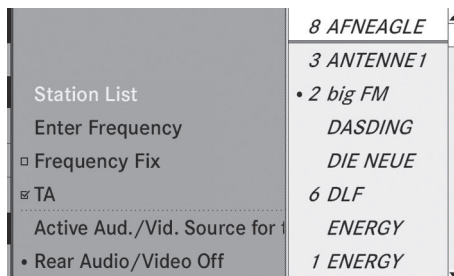

P82.87-5401-31

- ▶ Confirm **Station list** by pressing the  button. The station list appears.



P82.87-5402-31

- ▶ Select a station using the ,  buttons and press the  button to confirm. The selected station is played. The radio basic display appears.

**Entering characters in navigation mode (entering a city)****General information**

The following sections explain character input using the example of city entry for the city **MODEL CITY**.

If you want to use the address entry menu (> page 49) to enter a city, a street or a house number, for example, COMAND provides either a list with a character bar (option 1) or a selection list (option 2). You can enter the characters using either the character bar or the number keypad. In the

selection list, you select an entry to copy it to the address entry menu.

**Option 1: city list with the character bar**

- ▶ Call up the city list with character bar (> page 49).  
The alphabetically sorted city list shows the first available entries.

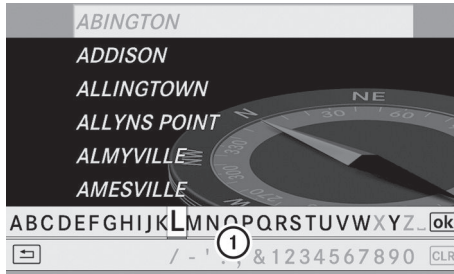

P82.86-9955-31

- ① Character bar

**Entering characters using the character bar**

- ▶ Select **M** using the buttons and press the button to confirm.
- ▶ Select **O** and press the button to confirm.

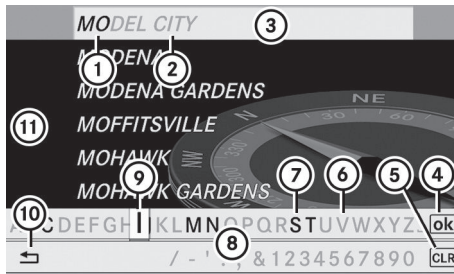

P82.86-9991-31

- ① Character **MO** entered by the user
- ② Characters **DEL CITY** automatically filled in by COMAND
- ③ List entry that most closely resembles the current entry be the user
- ④ To switch to the selection list
- ⑤ To delete an entry

- ⑥ Characters not currently available
- ⑦ Characters currently available
- ⑧ Character bar
- ⑨ Currently selected character
- ⑩ To cancel an entry
- ⑪ List

List ⑪ displays all available city names beginning with **MO**. The list entry that is best suited to previous user entries ③ is always highlighted in the first position (**MODEL CITY** in this example).

All characters previously entered are shown in black; in the example, letter **MO** ①. Letters filled in by COMAND are shown in gray ② (**DEL CITY** in the example).

Character bar ⑧ shows the letters still available for selection in black ⑧. These can be selected; in the example, the letter **I** is highlighted ⑪. Which characters remain available depends on the characters already entered by the user and on the data stored on the digital map. Characters that are no longer available are shown in gray ⑦.

- ▶ Select **D, E, L, C, I, T, Y** one after the other and confirm each with the .

**Entering characters using the number keypad**

- ▶ Press the button once to enter the letter **M**.

After it is pressed, the character display appears on the lower edge of the display. The first available letter is highlighted.

You see which characters you can enter with that button. Each time the key is pressed, the next character is selected.







Example: key :

- press once = M
- press twice = N
- press three times = O

- ▶ Wait until the character display goes out. The entries matching your input are shown in the list.



- ▶ Enter **O, D, E, L, CI, T, Y** using the appropriate buttons.

### Further functions in the list with character bar

- ▶ **To delete a character:** select the  icon at the bottom right in the character bar using the     buttons and press the  button to confirm.



or



- ▶ Press the  button.

- ▶ **To delete an entry:** select  and press and hold the  button until the entire entry has been deleted.

or

- ▶ Press and hold the  button until the entire entry is deleted.

- ▶ **To switch the character set:** select  and press the  button to confirm. This switches between the Latin and the Cyrillic character set.

- ▶ **To cancel an entry:** select the  icon in the bottom left of the character bar and press the  button to confirm.

or

- ▶ Press the  back button. The address entry menu appears.

- ▶ **To accept the first list entry:** press and hold the  button until the address entry menu appears. The accepted list entry is shown there.

### Calling up the list as a selection list

Select the desired city from the selection list.





If there are several entries for a city or if several cities of the same name are stored, then  is highlighted in the character bar.

- ▶ Press the  button.

It is also possible to switch the city list to the selection list at any time during character input.

- ▶ Press the  button repeatedly until the city list appears as a selection list.

or

- ▶ Select the  icon in the character bar using the    buttons and press the  button to confirm.



### Option 2: city list as selection list

COMAND either shows the selection list automatically or you can call up the selection list from the list with character bar.

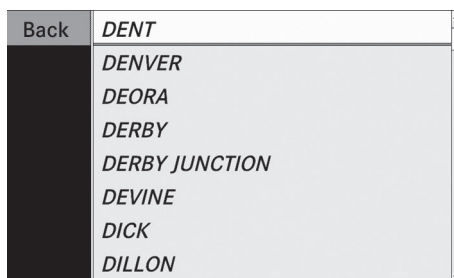
The example shows the selection list after entering the city **DENT**. The entry is highlighted automatically.



P82.87-2455-31

- ▶ Select a list entry using the   buttons and press the  button to confirm. The address entry menu appears. You can now enter a street, for example.

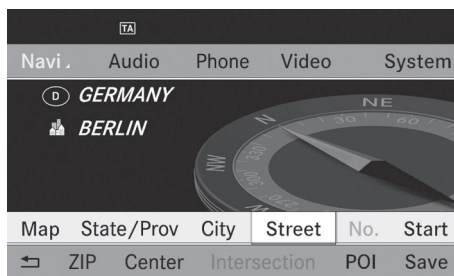

P82.87-5403-31

- i** You will find further information in the "Destination entry" section (▶ page 48).

## Entering characters in the address and the phone book

### Introduction

The following section describes how to enter characters in the phone book (▷ page 102) and the address book (▷ page 109) when creating a new entry.

### Creating a new entry in the phone book

- ▶ Call up the input menu with data fields (▷ page 104).

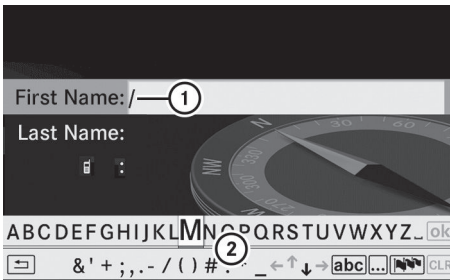

P82.87-2130-31

Phone book: input menu with data fields

- ① Selected data field with cursor
- ② Character bar

### Creating a new entry in the address book

- ▶ Call up the input menu with data fields (▷ page 109).

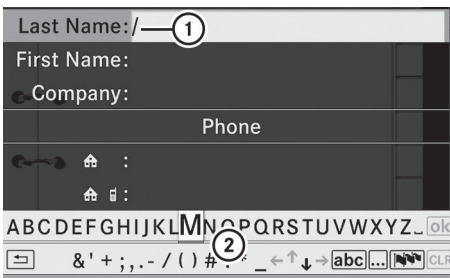

P82.87-2142-31

Input menu with data fields

- ① Selected data field with cursor
- ② Character bar

- ❗ If COMAND is not equipped with a hard disk, you can only edit data fields with telephone numbers.

### Entering characters

The example describes how to enter the surname **Schulz**.

- ▶ Select **S** using the ◀ ▶ ▲ ▼ buttons and press the **OK** button to confirm. **S** is entered into data field ①. All characters are shown in black and can always be selected in character bar ②.

The character bar offers characters corresponding to the respective data field (letters or digits).

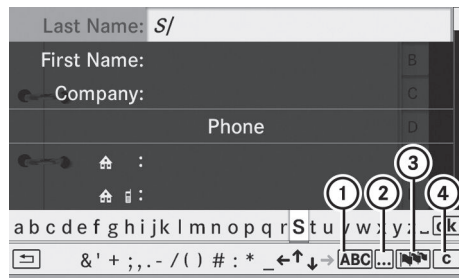

P82.87-5404-31

- ① To switch the character bar to lower-case letters
- ② To switch the character bar from upper/lower-case letters to digits
- ③ To change the language of the character bar
- ④ To delete a character/an entry

- ▶ Select **c** and press the **OK** button to confirm. The letter **c** is added to **S** in the data field.
- ▶ Repeat the process until the name has been entered in full.

- ▶ **To enter a phone number:** select the digits for the respective data field one by one using the ◀ ▶ ▲ ▼ buttons and press the **OK** button to confirm.



### Switching the data field

If you want to enter a first name after you have entered a surname, for example, proceed as follows to switch between the data fields:

#### Option 1

- ▶ Select or in the character bar and press the button to confirm. The input menu displays the data field selected.

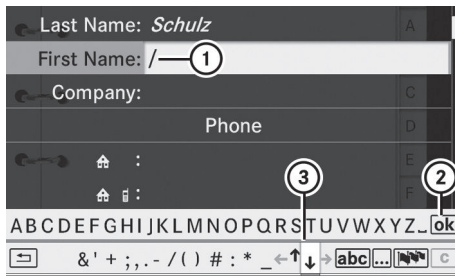

P82.87-5405-31

- ① Cursor in the next data field
- ② To store an entry
- ③ and icons to select a data field

#### Option 2

- ▶ Press the button repeatedly until the character bar disappears.
- ▶ Select a data field using the buttons and press the button to confirm.

### Further functions available in the character bar

- ▶ **To switch the character bar between upper/lower-case characters:** select or and press the button to confirm.
- ▶ **To switch the character set:** select and press the button to confirm. The character set switches between upper/lower-case letters and digits.

- ▶ **To change the language of the character bar:** select and press the button to confirm.
- ▶ Select a language using the or button and press the button to confirm.
- ▶ **To reposition the cursor within the data field:** select or and press the button to confirm.

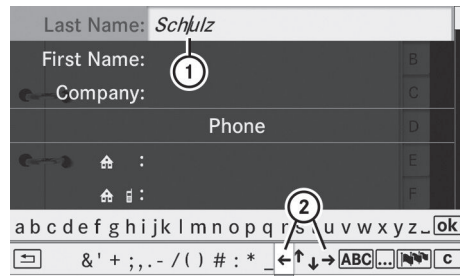

P82.87-5406-31

- ① Cursor (repositioned)
  - ② and icon to reposition the cursor
- ▶ Delete the character/entry (> page 24).

### Storing an entry

- ▶ Select the icon using the buttons and press the button to confirm. The entry is stored in the address book.

## Basic functions of COMAND

### Switching COMAND on/off

- ▶ Press the control knob. A warning message appears. COMAND calls up the previously selected menu.
- ▶ **i** If you switch off COMAND, playback of the current audio or video source will also be switched off.

### Switching the COMAND display on/off

- ▶ Press the **sys** function button.
- or
- ▶ Select **System** in the main function bar using the **▲** **◀** **▶** buttons and press the **OK** button to confirm. In both cases, the system menu appears.
- ▶ **To switch off:** select **Display off** and press the **OK** button to confirm.
- ▶ **To switch on:** press the **ON** or **↔** back button.

### Mute

#### Switching audio and video sources on/off

- ▶ Press the **🔇** button.  
The sound from the respective audio or video source is switched on or muted.
- i** When the sound is off, the system displays the **🔇** icon in the status line. When you change the audio or video source, or adjust the volume, sound automatically switches on again.
- i** Even if the sound is switched off, you will still hear traffic and navigation system announcements.

#### Switching off traffic program and navigation announcements completely

- ▶ **Traffic program:** press and hold the **🔇** button until the **TA** display disappears from the status bar of the display.
- ▶ **Navigation announcements:** press the **🔇** button during the announcement.
- i** Navigation announcements can be turned on again after COMAND has been switched on or off with the **ON** control knob.

### Adjusting the volume

#### Audio and video source volume

- ▶ Turn **ON** the control knob.
- or
- ▶ Press the **+** or **-** button on the multifunction steering wheel.  
The volume of the currently selected audio or video source changes.

#### Adjusting the volume for traffic announcements and navigation announcements

- i** You can set the volume of traffic and navigation announcements relative to the volume of the audio or video source.

During traffic or navigation announcements:

- ▶ Turn **ON** the control knob.
- or
- ▶ Press the **+** or **-** button on the multifunction steering wheel.

#### Adjusting the volume for phone calls

You can adjust the volume for hands-free mode during a telephone call.

- ▶ Turn **ON** the control knob.
- or
- ▶ Press the **+** or **-** button on the multifunction steering wheel.

### Adjusting the sound settings

#### Calling up the sound menu

You can make various sound settings for the different audio and video sources. This means that it is possible to set more bass for radio mode than for CD mode, for example. You can call up the respective sound menu from the menu of the desired mode.

The example describes how to call up the sound menu in radio mode.

- ▶ Press the **RADIO** function button.  
The radio display appears. You will hear the last station played on the last waveband.
- ▶ Select **Sound** using the **▼** **◀** **▶** buttons and press the **OK** button to confirm.  
You can now set the treble and bass or the balance and fader for radio mode.

### Adjusting treble and bass

- ▶ Select **Treble** or **Bass** in the sound menu using the **▼** **◀** **▶** buttons on the remote control and press the **OK** button to confirm.  
An adjustment scale appears.

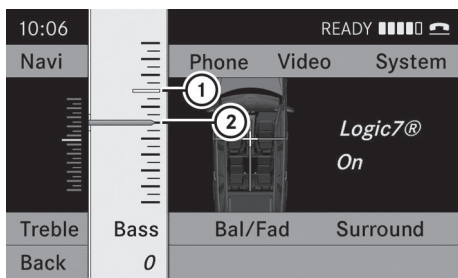

P82.86-9963-31

Setting the bass

- ① Last setting selected
  - ② Current setting
- ▶ Select a setting using the **▲** **▼** buttons and press the **OK** button to confirm.  
The setting is stored and you exit the menu.

### Adjusting balance and fader

With the Balance function, you can control whether the sound is louder on the driver's or front-passenger side.

The Fade function is used to control whether the sound is louder in the front or the rear of the vehicle.

- i** The fader cannot be set on Roadster vehicles.

- ▶ Select **Bal/Fad** (balance/fader) in the sound menu using the **▼** **◀** **▶** buttons and press the **OK** button to confirm.

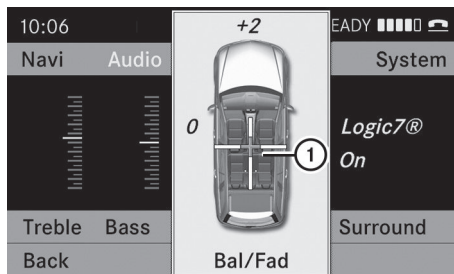

P82.86-9964-31

Adjusting balance and fader

- ① Current setting
- ▶ Select a setting using the **◀** **▶** **▲** **▼** buttons and press the **OK** button to confirm.  
The setting is stored and you exit the menu.

### Surround sound

#### General information

If your vehicle is equipped with the harman/kardon®Logic 7® surround sound system, you can set the optimum surround sound for every passenger.

The harman/kardon®Logic 7® surround sound system is available for the following operating modes:

- radio (FM only)
- HD Radio
- SatRadio
- audio CD
- audio DVD (MLP, dts, PCM and Dolby Digital audio formats)
- MP3 (including SD memory card)
- video DVD (PCM, dts and Dolby Digital audio formats)
- AUX

Because some DVDs contain both stereo and multichannel audio formats, it may be

necessary to set the audio format (▷ page 135).

**i** The **Logic7® On** function creates a surround sound experience for every passenger when playing, for example, stereo recordings. It enables optimum playback of music and films on CD, audio DVD or video DVD with multichannel audio formats, such as MLP, dts or Dolby Digital. This results in sound characteristics like those intended by the sound engineer when the original was recorded.

**i** If you select **Logic7® Off**, all permissible formats are played as stored on the medium. Due to the design of the passenger compartment, an optimum audio experience cannot be guaranteed for all passengers.

**i** Discs which support the audio formats mentioned have the following logos:



P82.87-2986-31

Dolby Digital



P82.86-9782-31

dts



P82.86-7603-31

MLP

## Switching surround sound on/off

Example: switching on surround sound for radio mode

- ▶ Press the **RADIO** function button.  
The radio display appears. You will hear the last station played on the last waveband.
- ▶ Select **Sound** using the **▼** **◀** **▶** buttons and press the **OK** button to confirm.
- ▶ Select **3D sound** and press the **OK** button to confirm.

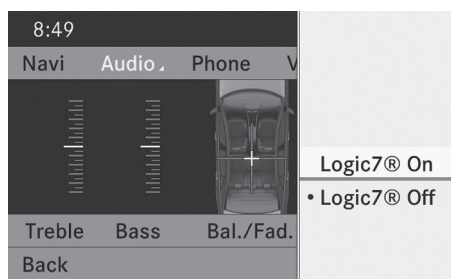

P82.87-3426-31

- ▶ Select **Logic7® on** or **Logic7® off** using the **▲** **▼** buttons and press the **OK** button to confirm.  
Depending on your selection, surround sound is switched on or off and the menu is exited.
- ▶ **To exit a menu without storing:** press the **↶** back button or the **◀** button.

**i** Please bear the following in mind:

For the optimum audio experience for all passengers when LOGIC7® is switched on, the balance and fader settings should be set to the center of the passenger compartment.

You will achieve the best sound results by playing high-quality audio and video DVDs. MP3 tracks should have a bit rate of at least 128 kbit/s.

If radio reception is poor, e.g. in a tunnel, you should switch off Logic 7®, as it may otherwise switch between stereo and

mono and cause temporary sound distortions.

On some stereo recordings, the sound characteristics may differ from conventional stereo playback.

## Rear Entertainment System

### Components

#### Overview

The Rear Seat Entertainment System comprises:

- two rear-compartment screens behind the front-seat head restraints
- the remote control
- a CD/DVD drive
- AUX jacks on both screens (display AUX) and on the CD/DVD drive (drive AUX)
- two sets of cordless headphones

### Rear-compartment screens

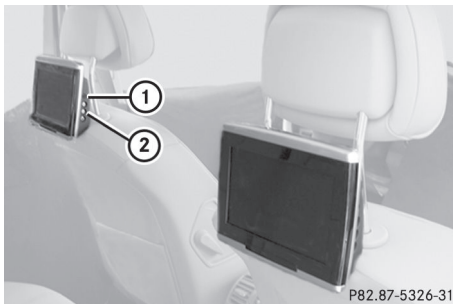

P82.87-5326-31

- ① Socket for corded headphones
- ② AUX jacks; for a detailed view, see CD/DVD drive (▶ page 31)

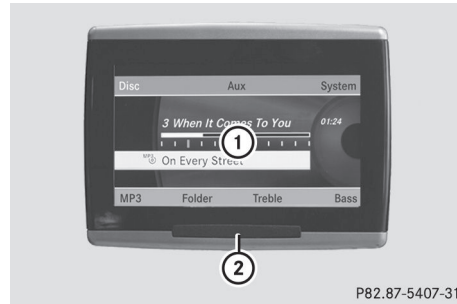

P82.87-5407-31

- ① Display
- ② IR receiver diodes

### Remote control

#### Overview



P82.87-2052-31

- ① Switches the screen on/off
- ② Switches the button lighting on/off

- ③ Selects the screen for the remote control
- ④ Selects a menu or menu item
- ⑤ Confirms a selection or setting
- ⑥ Switches sound on/off (for corded headphones)
- ⑦ Adjusts the volume (for corded headphones)
- ⑧ Skips to a track, fast-forward/fast-rewind
- ⑨ Selects a track; direct entry
- ⑩ Exits a menu (back)

### Selecting the screen for the remote control

You can use the remote control to operate one of the two rear screens at a time. To do so, you must switch the remote control to the desired screen.

- ▶ To select the left-hand screen: turn thumbwheel ③ until "REAR L" is highlighted in the window.
- ▶ To select the right-hand screen: turn thumbwheel ③ until "REAR R" is highlighted in the window.

### Switching the screen on/off

If the SmartKey is in position **0** or **1** in the ignition lock (see the vehicle Operator's Manual), or the SmartKey is not inserted, the screens in the rear will switch off after 30 minutes. Before the screens switch off, they show a message to this effect.

You can switch the screens back on. However, this will discharge the starter battery.

- ▶ Point the remote control at the rear-compartment screen which has been selected for remote operation.
- ▶ Press button ① on the remote control. The respective rear screen switches on or off.
- ❗ You can only switch the screens on using the remote control if the ignition is switched on.

### Switching the button lighting on/off





- ▶ Press button ② on the remote control. Depending on the previous status, the button lighting is switched on or off.

❗ If you do not use the remote control for about 15 seconds, the button lighting switches off automatically.

### Switching the sound on/off (corded headphones only)

- ▶ Press button ⑥ on the remote control. The sound is switched on/off.

### Selecting a menu/menu item and confirming your selection

- ▶ Select a menu/menu item using the     buttons and press the  button to confirm.

### CD/DVD drive and AUX jacks

The CD/DVD drive is located in the center behind the front seats.

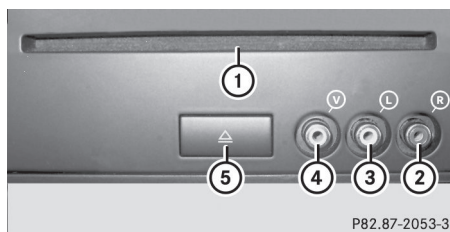

- ① CD/DVD slot
- ② AUX, right-hand (R) jack for audio signal
- ③ AUX, left-hand (L) jack for audio signal
- ④ AUX, jack for video signal (V)
- ⑤ CD/DVD eject button

The AUX jacks shown are for the AUX drive. Identical jacks can be found on the right-hand side of the rear-compartment screens (display AUX), (▶ page 30).

## Cordless headphones

## Overview

At a glance



- ① Volume control
- ② Selects a screen for the headphones
- ③ Battery compartment cover
- ④ Switches the cordless headphones on/off
- ⑤ Indicator lamp, differing displays (▷ page 32)

- ▶ Open both sides of the headphones and adjust the fit of the headphones by pulling the headphone band in the direction of the arrow.

### Switching the cordless headphones on/off

- ▶ Press button ④.

Depending on the previous status, the headphones are switched on or off. To preserve the batteries, the headphones automatically switch off if they have not received an IR signal for approximately three minutes.

### Adjusting the volume of the headphones

- ▶ Turn volume control ① until the desired volume has been set.

- ❗ If you have connected corded headphones to a rear-compartment screen, you can adjust the volume by pressing buttons ⑦ on the remote control (▷ page 30).

### Selecting a screen for the headphones

- ▶ Move push slider ② to **L** (left-hand screen) or **R** (right-hand screen).

### Indicator lamp displays

The color of the indicator lamp shows whether the headphones are switched on or off and indicates the charge level of the batteries inserted.

P82.87-2576-31



Display	Status
Green	The headphones are switched on and the batteries are fully charged.
Red	The headphones are switched on and the batteries are almost discharged.
No display (dark)	The headphones are switched off, or the batteries are empty, incorrectly inserted or not inserted.

- ▶ Press the **sys** function button. The system menu appears.
- ▶ Select **Settings** and press the **OK** button to confirm.
- ▶ Select **Rear View Camera** and press the **OK** button to confirm.
- ▶ Select **Activation by R gear** and press the **OK** button to confirm. The function is switched on  or off , depending on the previous status.

### Connecting additional headphones

You can connect one additional set of corded headphones to each of the two rear screens (▷ page 30). The connection socket is for headphones with 1/8 inch stereo jack plugs and an impedance of 32 ohms.

### Changing batteries

Batteries are required for the remote control and for the two sets of cordless headphones. For changing batteries, see (▷ page 160).

### Rear view camera

The rear view camera is only available for the M-Class and the R-Class.

#### **WARNING**

The rear view camera is merely an aid. Please observe the corresponding notes in your vehicle's Operator's Manual.

If your vehicle is equipped with a rear view camera, its image is automatically relayed to the COMAND display if the function is activated and you engage reverse gear.

If the function is activated, the COMAND display will automatically switch back to the previously selected display as soon as you shift out of reverse gear.



COMAND features .....	36
Display settings .....	36
Time settings .....	36
Text reader settings .....	38
Voice Control System settings .....	38
Bluetooth® settings .....	40
System language settings .....	43
Reset function .....	43

### COMAND features

These Operating Instructions describe all standard and optional equipment available for your COMAND system at the time of purchase. Country-specific deviations are possible. Please note that your COMAND system may not be equipped with all the features described.

### Display settings

#### Setting the brightness

The brightness detected by the COMAND light sensor affects the setting options for this function.

- ▶ Press the **sys** button.
- ▶ Select **Settings** using the **▼** **◀** **▶** buttons and press the **OK** button to confirm.
- ▶ Select **Display** and press the **OK** button to confirm.
- ▶ Select **Brightness** and press the **OK** button to confirm.

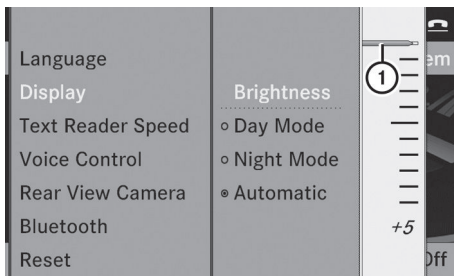

P82.87-3430-31

① Current setting

- ▶ Adjust the brightness using the **▲** **▼** buttons and press the **OK**, **◀** or **BACK** button to confirm.

#### Display design

- ▶ Press the **sys** button.

- ▶ Select **Settings** using the **▼** **◀** **▶** buttons and press the **OK** button to confirm.
- ▶ Select **Display** and press the **OK** button to confirm.
- ▶ Select **Day Mode**, **Night Mode** or **Automatic** using the **▲** **▼** buttons and press the **OK** button to confirm. The **●** icon indicates the current setting.

**i** When the **Automatic** setting is selected, COMAND evaluates the readings from the automatic vehicle light sensor and switches between the display designs automatically.

### Time settings

#### General information

If COMAND is equipped with a navigation system and has GPS reception, COMAND automatically sets the time and date. You can also adjust the time yourself in 30-minute increments, but the date cannot be changed.

**i** If you set the time in 30-minute increments, any time zone settings and settings for changing between summer and standard time are lost (▷ page 37).

If your vehicle is not equipped with a navigation system, you can set the minutes exactly.

**i** The following functions require the time, time zone and summer/standard time to be set correctly in order to work properly:

- route guidance on routes with time-dependent traffic guidance
- calculation of expected time of arrival
- time information for received and outgoing phone calls

### To set the time

- ▶ Press the **sys** button.
- ▶ Select **Time** using the **▼** **◀** **▶** buttons and press the **OK** button to confirm.
- ▶ Select **Set Time** and press the **OK** button to confirm.



P82.87-3429-31

- ① To set the time
- ② Current date

- ▶ Set the time using the **▲** **▼** buttons and press the **OK** button to confirm.

The following operational steps depend on whether the navigation system has GPS reception.

### Setting the time/date format

- ▶ Press the **sys** button.
- ▶ Select **Time** using the **▼** **◀** **▶** buttons and press the **OK** button to confirm.
- ▶ Select **Format** and press the **OK** button to confirm.

Abbreviation	Meaning
DD/MM/YYYY	Day/Month/Year (date format)
HH/MM	Hours/Minutes (time format)

You can set the 24-hour or the AM/PM format.

- ▶ Select a format using the **▲** **▼** buttons and press the **OK** button to confirm.

### Setting the time zone and switching between summer and standard time

- ▶ **To set a time zone:** press the **sys** button.
- ▶ Select **Time** using the **▼** **◀** **▶** buttons and press the **OK** button to confirm.
- ▶ Select **Time Zone** and press the **OK** button to confirm.  
The country list appears. The • dot indicates the current setting.
- ▶ Select the country you are presently in using the **▲** **▼** buttons and press the **OK** button to confirm.  
Depending on the country you select, a time zone list may also appear.
- ▶ Select a time zone using the **▲** **▼** buttons and press the **OK** button to confirm.

Further steps depend on whether the navigation system currently has GPS reception and on which country you have selected.

You have the following two options:

- ▶ **To change manually:** select **Daylight Saving Time (Summer)** or **Standard Time (Winter)** and press the **OK** button to confirm.
- ▶ **To switch automatic changeover on/off:** select **Auto. Daylight Saving Time On** or **Auto. Daylight Saving Time Off** using the **▲** **▼** buttons and press the **OK** button to confirm.  
The • dot indicates the current setting.

- ❗ If you have switched off the automatic changeover function, you must change from summer to standard time and vice versa manually using "Set time" (> page 37).

## Text reader settings

### Setting the read-aloud speed

- ▶ Press the **sys** button.
- ▶ Select **Settings** using the **▼** **◀** **▶** buttons and press the **OK** button to confirm.
- ▶ Select **Text Reader Speed** and press the **OK** button to confirm.  
A list appears. The **•** dot indicates the current setting.
- ▶ Select a setting using the **▲** **▼** buttons and press the **OK** button to confirm.

## Voice Control System settings

### General notes

This function is available if COMAND features an integrated hard disk.

To protect the integrated hard disk, COMAND deactivates it at very high temperatures and at extreme altitudes. The Voice Control System will then be temporarily unavailable.

### Opening/closing the help window

- ▶ Press the **sys** button.
- ▶ Select **Settings** using the **▼** **◀** **▶** buttons and press the **OK** button to confirm.
- ▶ Select **Voice Control** and press the **OK** button to confirm.
- ▶ Select **Help window** and press the **OK** button to confirm.  
You have switched the help window on  or off .

**i** The help window provides information in addition to the audible instructions during individualization as well as later, when you are using voice control.

## Individualization

### Introduction

Using individualization, you can fine tune the Voice Control System to your own voice and thus improve voice recognition. This means that other users' voices will not be recognized as easily, and therefore this function can be deactivated (> page 39).

Individualization comprises two parts and takes approximately 5 minutes. It consists of training the system to recognize a certain number of digit sequences and voice commands.

### Starting new individualization

Individualization can only be started when the vehicle is stationary. Before starting, switch off all devices or functions which could interfere, such as the radio or the navigation system. After starting the session, the system guides you through the training with spoken instructions.

- ▶ Press the **sys** button.
- ▶ Select **Settings** using the **▼** **◀** **▶** buttons and press the **OK** button to confirm.
- ▶ Select **Voice Control** and press the **OK** button to confirm.
- ▶ Select **Start new individualization** and press the **OK** button to confirm.  
You will see and hear a prompt, asking whether you would like further information.
- ▶ Select **Yes** or **No** and press the **OK** button to confirm.  
If you select **No**, the first part of individualization begins. You will be asked whether you would like to train digits or voice commands.  
If you select **Yes**, you will see and hear information on the individualization

process. The first part of individualization then begins automatically.

or

- ▶ **To close the display:** press the **OK** button. You will be asked whether you would like to train digits or voice commands.

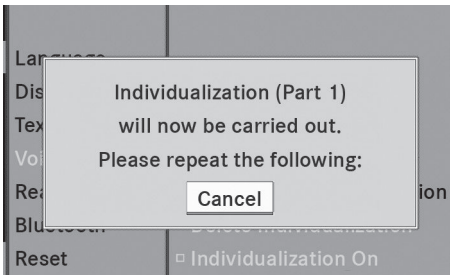

P82.87-3431-31

At the end of the first part, a prompt will appear asking whether you wish to begin the second part.

- ▶ Select **Yes** or **No** and press the **OK** button to confirm. If you select **No**, individualization will be canceled. The data from the first part is stored automatically. If you select **Yes**, the second part will begin.

Individualization is completed at the end of the second part. You will see a message to this effect. The data from the second part is stored automatically.

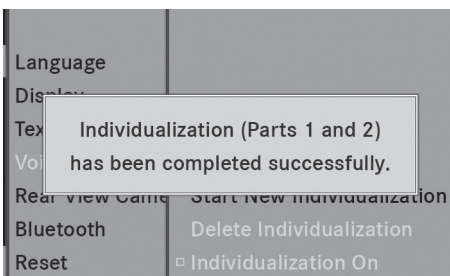

P82.87-3432-31

### Canceling the first or second part of individualization

- ▶ Select **Cancel** and press the **OK** button to confirm. A prompt appears asking whether you really wish to cancel.
- ▶ Select **Yes** or **No** and press the **OK** button to confirm. If you select **Yes**, the voice training will be canceled. The data from the part during which you exited is not stored. If you select **No**, the current part begins again.

### Deleting existing individualization data

- ▶ Press the **sys** button.
- ▶ Select **Settings** using the **▼** **◀** **▶** buttons and press the **OK** button to confirm.
- ▶ Select **Voice Control** and press the **OK** button to confirm.
- ▶ Select **Delete Individualization** and press the **OK** button to confirm. A prompt appears asking whether you really wish to delete.
- ▶ Select **Yes** or **No** and press the **OK** button to confirm. If you select **No**, the process will be aborted. If you select **Yes**, the individualization is deleted. You will see a message to this effect.

### Activating/deactivating individualization

- ▶ Press the **sys** button.
- ▶ Select **Settings** using the **▼** **◀** **▶** buttons and press the **OK** button to confirm.
- ▶ Select **Voice Control** and press the **OK** button to confirm.

- ▶ Select **Individualization on** and press the **OK** button to confirm. Individualization is activated  or deactivated .

## Bluetooth® settings

### General information about Bluetooth®

Bluetooth® technology is the standard for short-range wireless data transmission of up to approximately 10 meters. Bluetooth® allows, for example, the exchange of vCards.

Bluetooth® is a registered trademark of Bluetooth Special Interest Group (SIG) Inc.



### Requirements for a Bluetooth® connection

You can connect mobile phones, laptops and PDAs with COMAND.

To do so, the following conditions need to be met:

- Bluetooth®-capable devices, e.g. mobile phones, need to comply with a certain profile in order to be connected to COMAND (▶ page 95). Every Bluetooth® device has its own specific Bluetooth® name.
- Bluetooth® must be activated in COMAND and on the respective Bluetooth® device; see the separate operating instructions.
- the Bluetooth® device must be "visible" to COMAND in order for COMAND to find and display it. For the setting procedures, please see the operating instructions for the Bluetooth® device.

- i** Once a mobile phone has been connected, reception and transmission volume may change.
- i** Further information on suitable mobile phones and on connecting a Bluetooth®-capable mobile phone to COMAND can be obtained online under <http://www.mbusa-mobile.com> or by telephone at the Mercedes-Benz Customer Assistance Center under 1-800-FOR-MERCEDES (1-800-367-6372) (US) or at Customer Relations under 1-800-387-0100 (Canada).

### Activating/deactivating Bluetooth®

- ▶ Press the **sys** button. The system menu appears.
- ▶ Select **Settings** in the system menu using the **▼**, **◀**, **▶** buttons and press the **OK** button to confirm.
- ▶ Select **Bluetooth** and press the **OK** button to confirm.
- ▶ Select **Activate Bluetooth** and press the **OK** button to confirm. This switches Bluetooth® on  or off .

### Connecting Bluetooth® devices

Before using your Bluetooth® device with COMAND for the first time, you will need to connect it.

Connecting comprises:

- searching for a Bluetooth® device
  - subsequently authorizing it
- i** You can connect up to ten devices to COMAND.

You can obtain more detailed information about suitable mobile phones and about connecting Bluetooth®-capable mobile phones to COMAND from your authorized Mercedes-Benz Center or on the Internet



(<http://www.mercedes-benz.com/connect>).

### Searching for Bluetooth® devices

- ▶ Select **Settings** in the system menu using the buttons and press the button to confirm.
- ▶ Select **Bluetooth** and press the button to confirm.
- ▶ Select **Bluetooth device list** and press the button to confirm.
- ▶ Select **Update** and press to confirm. COMAND searches for Bluetooth® devices within range. After a short while, the Bluetooth® device list appears.

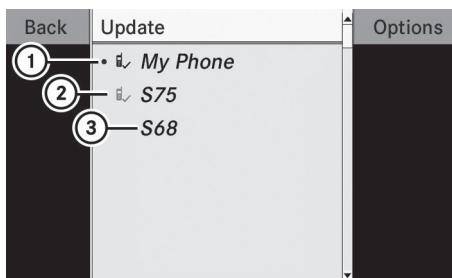

P82.86-9972-31

Example of display: Bluetooth® device list

- ① Currently connected and authorized device (here: mobile phone )
- ② Device not within range but previously authorized ( appears in gray)
- ③ Newly detected device within range but not yet authorized (no icon)

The Bluetooth® device list shows all devices within range and all previously authorized devices, whether or not they are in range. If the Bluetooth® device list is already full, you will be requested to deauthorize a device (▷ page 42). If COMAND does not detect your Bluetooth® device, external authorization may be necessary (▷ page 42).

- i** When subsequently called up again, the list may no longer show all devices, for example because a device has been removed from the vehicle in the meantime. In this case, start a new search to update the device list.

### Authorizing a Bluetooth® device (registering)

#### Option 1

- ▶ Select the as yet unauthorized device in the Bluetooth® device list using the buttons.
- ▶ Select **Options** using the button and press the button to confirm.
- ▶ Select **Authorize** and press the button to confirm.

#### Option 2

- ▶ Select the as yet unauthorized device in the Bluetooth® device list using the buttons and press the button to confirm. Irrespective of the option, the passcode input menu appears.

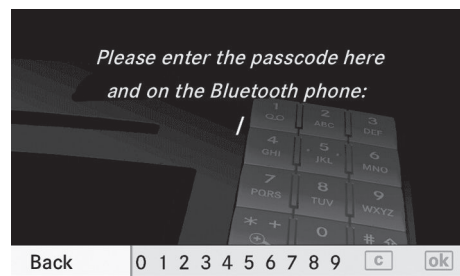

P82.87-2463-31

The passcode is any one to sixteen-digit number combination which you can choose yourself. You must enter the same number combination in COMAND and in the Bluetooth® device to be authorized (see the mobile phone operating instructions).

- i** Some mobile phones require a passcode with four or more digits.

- i** If you want to reauthorize a device following de-authorization (▷ page 42), you can select a different passcode.
- ▶ **To enter the passcode in COMAND:** press number keys, such as  ABC, one after the other.
    - is highlighted after the first number has been entered.
  - or
  - ▶ Select the digits using the   buttons and press the  button to confirm. Then, select .
  - ▶ **To confirm an entry in COMAND:** press the  button.
  - ▶ Enter the same passcode into the Bluetooth® device (see the operating instructions for the respective device). The device is authorized.

### External authorization

- If COMAND does not detect your Bluetooth® device, this may be due to particular security settings on your Bluetooth® device. In this case, check whether your Bluetooth® device can locate the COMAND system. The Bluetooth® device name of COMAND is "MB Bluetooth".
- ▶ Select **Authorize** in the Bluetooth® device list using the   buttons.
  - ▶ Select **Options** using the  button and press the  button to confirm.
  - ▶ Select **External authorization** and press the  button to confirm.
  - ▶ Start the Bluetooth® scan process on the Bluetooth® device (see the separate operating instructions of the respective device).
  - ▶ Select COMAND ("MB Bluetooth").
  - ▶ When prompted, enter the passcode on the Bluetooth® device and then on COMAND.

### Displaying the details of a Bluetooth® device

- ▶ Select the desired device in the Bluetooth® device list using the   buttons.
- ▶ Select **Options** using the  button and press the  button to confirm.
- ▶ Select **Details** and press  to confirm. The detailed display for this device appears.
- ▶ **To close the detailed display:** press the  or  button.

### De-authorizing (de-registering) a Bluetooth® device

- Mercedes-Benz recommends that you deauthorize devices, e.g. mobile phones, both in COMAND and on the respective Bluetooth® device itself. Subsequent authorization may otherwise fail.
- ▶ Select an authorized device in the Bluetooth® device list using the   buttons.
  - ▶ Select **Options** using the  button and press the  button to confirm.
  - ▶ Select **Deauthorize** and press the  button to confirm. A prompt appears asking whether you really wish to deauthorize this device.
  - ▶ Select **Yes** or **No**.
    - If you select **Yes**, the authorization for the device will be revoked.
    - If you select **No**, the process will be aborted.
- i** If a Bluetooth® device has been de-authorized and is out of range, when a new search is carried out it will not appear in the Bluetooth® device list.

### System language settings

This function allows you to determine the language for the menu displays and the navigation messages. The selected language affects the characters available for entry.

- ▶ Press the **sys** button.
- ▶ Select **Settings** using the **▼** **◀** **▶** buttons and press the **OK** button to confirm.
- ▶ Select **Language** and press the **OK** button to confirm.  
The list of languages appears. The **•** dot indicates the current setting.
- ▶ Select a language using the **▲** **▼** buttons and press the **OK** button to confirm.  
COMAND loads the selected language and sets it.

**i** If you select the **Synchronize Languages** setting, COMAND sets the same language as is already set in the multifunction display.

- ▶ Select **Settings** using the **▼** **◀** **▶** buttons and press the **OK** button to confirm.
- ▶ Select **Reset** and press the **OK** button to confirm.  
A prompt appears asking whether you wish to reset.
- ▶ Select **Yes** or **No** and press the **OK** button to confirm.  
If you select **No**, the process will be canceled.  
If you select **Yes**, a prompt will appear again asking whether you really wish to reset.
- ▶ Select **Yes** or **No** and press the **OK** button to confirm.  
If you select **Yes**, a message will be shown. COMAND is reset and restarted.  
If you select **No**, the process will be canceled.

### Reset function

You can reset COMAND to the factory settings. Amongst other things, this will delete all personal data (e.g. station presets, address book entries, entries in the destination memory and in the list of previous destinations in the navigation system). Resetting is recommended before selling or transferring ownership of your vehicle, for example.

Data on the internal hard drive, e.g. music files in the MUSIC REGISTER, will not be deleted. You can delete these music files from the MUSIC REGISTER using the "Delete all music files" (▷ page 140) function.

- ▶ Press the **sys** function button.



COMAND features .....	46
Introduction .....	46
Basic settings .....	47
Destination entry .....	48
Entering a point of interest .....	60
Route guidance .....	65
Traffic reports .....	73
Destination memory .....	77
Previous destinations .....	80
Map operation and settings .....	81
Additional settings .....	85
Problems with the navigation system .....	91

## COMAND features

These Operating Instructions describe all standard and optional equipment available for your COMAND system at the time of purchase. Country-specific deviations are possible. Please note that your COMAND system may not be equipped with all the features described.

## Introduction

### Safety note

#### WARNING

For safety reasons, only enter a new destination when the vehicle is stationary. You may otherwise be distracted from the traffic conditions, cause an accident and injure yourself and others.

COMAND calculates the route to the destination without taking account of the following, for example:

- traffic lights
- stop and give way signs
- parking or stopping restrictions
- lane narrowing
- other road and traffic rules and regulations

COMAND may give incorrect driving recommendations if the data on the digital map does not correspond to the actual conditions. For example, a route may have been diverted or the direction of a one-way street may have changed.

For this reason, you must always observe the respective road and traffic rules and regulations during your journey. Road and traffic rules and regulations always have priority over system driving recommendations.

#### WARNING

Navigation announcements are intended to direct you while driving without diverting your attention from the road and driving.

Please always use this feature instead of consulting the map display for directions. Consulting the symbols or map display for directions may cause you to divert your attention from driving and increase your risk of an accident.

## General information

### Operational readiness of the navigation system

In vehicles for certain countries, the navigation system is not operational immediately after delivery because the digital map is not pre-installed.

If this is the case, the following message appears in the display after you switch to navigation mode:

**Please insert the map DVD to activate navigation.**

► **To install the map software:** proceed as described in the "Updating the digital map" section (▷ page 89).

The navigation system must determine the position of the vehicle before first use or whenever operational status is restored. Therefore, you may have to drive for a while before precise route guidance is possible.

### GPS reception

Correct functioning of the navigation system depends, amongst other things, on GPS reception. In certain situations, GPS reception may be impaired, there may be interference or there may be no reception at all, e.g. in tunnels or parking garages.

### Entry restriction

On vehicles for certain countries, there is a restriction on entering data.

The restriction is active above a vehicle speed of about 3 mph. The restriction is deactivated as soon as the vehicle speed drops below about 2 mph.

When the restriction is active, certain entries cannot be made. This will be indicated by the fact that certain menu items are grayed out and cannot be selected.

The following entries are not possible, for example:





- entering the destination city and street
- entering a destination via the map
- entering points of interest in the vicinity of a city or via a name search
- editing entries
- using the number keypad for direct entry

Other entries are possible, such as entering points of interest in the vicinity of the destination or current position.

### Switching to navigation mode

- ▶ Press the **NAVI** function button.

or

- ▶ Select **Navi** in the main function bar using the    buttons and press the  button to confirm.

In both cases, you will see the map either with or without the menu shown.

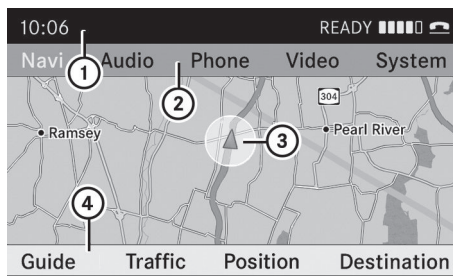

P82.87-2465-31

Map showing the menu; route guidance inactive

- ① Status bar
- ② Main function bar
- ③ Current vehicle position
- ④ Navigation menu bar



P82.87-3893-31



Map without the menu; route guidance inactive

- ① Current vehicle position
- ② Map orientation selected
- ③ Map scale selected

"Route guidance active" means that you have entered a destination and that COMAND has calculated the route. The display shows the route, changes of direction and lane recommendations. Navigation announcements guide you to your destination.

"Route guidance inactive" means that no destination has been entered and that no route has been calculated.

### Showing/hiding the menu





- ▶ **To hide the menu:** press the  button and confirm the **Full screen** menu item by pressing the  button. The map can be seen in the full-screen display.
- ▶ **To show the menu:** press the  button when the map is shown in full-screen.

## Basic settings

### Route mode

#### Setting route options

- ▶ **To call up the route mode menu:** press the **NAVI** function button.

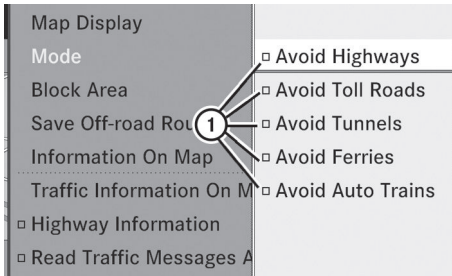

- ▶ Select **Navi** in the main function bar using the    buttons and press the  button to confirm.
- ▶ Select **Mode** and press the  button to confirm.



P82.87-3435-31

Route mode menu

## ① Route options



- ▶ Select the route option(s) using the   buttons and press the  button to confirm.  
The route options are switched on  or off , depending on the previous status.

**i** If you change the route options while route guidance is active (a route has been calculated), COMAND will calculate a new route.

If you change the route options while route guidance is inactive (no destination has been entered yet), COMAND uses the new settings for the next route guidance.

**i** The route calculated may, for example, include ferry connections, even if the **Avoid Ferries** route option is switched on.

In some cases, e.g. when calculating particularly long routes, COMAND may not be able to take all the selected route options into account.

- ▶ **To exit the menu:** press the  or  button.

## Destination entry

## Introduction to destination entry

 **WARNING**

For safety reasons, only enter a new destination when the vehicle is stationary. You could otherwise be distracted from the traffic conditions, cause an accident and injure yourself and others.

The following destination entry options are available:

- entering a destination by address
- selecting a destination from the destination memory (e.g. My address)
- selecting a destination from the list of last destinations
- entering a destination using the map
- entering an intermediate stop
- entering a point of interest
- entering a destination using Search & Send (▶ page 59)

## Entering a destination by address

## Introduction

When entering an address as the destination, you have the following options:

- entering the state/province, city/ZIP code and street
- entering the state/province, city/ZIP code and center
- entering the state/province, city/ZIP code, street and house number
- entering the state/province, city/ZIP code, street and intersection
- entering the state/province, street, city and house number
- entering the state/province, street and house number
- entering the state/province, street and intersection









### Example: entering an address

The following is a step-by-step example of how to enter an address. The destination address is as follows:

Germany  
Berlin  
Unstrutstraße 1

You can of course enter any country, city, street and house number desired and enter, for example, your home address (My address).

### Calling up the address entry menu

- ▶ **To switch to navigation mode:** press the  function button.
- ▶ **To show the menu:** press the  button.
- ▶ Select **Destination** using the    buttons and press the  button to confirm.
- ▶ Select **Address Entry** and press the  button to confirm.  
The address entry menu appears. If you have previously entered a destination, this will be shown in the display.

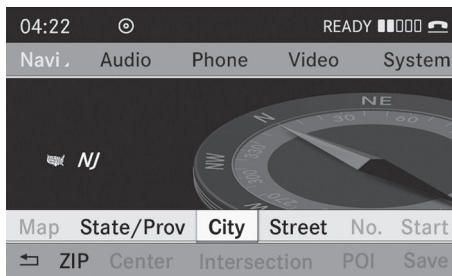

P82.86-9990-31

Address entry menu











- ▶ **i** Some menu items will not be available, or not be available yet, depending on the letters entered for the address or the digital map data.

Example:





After you have entered the state/province, the **No.**, **Center**, **Intersection**, **Save** and

**Start** menu items are not yet available; the **ZIP** menu item is not available if the digital map does not contain ZIP codes.

### Selecting a state/province

- ▶ **i** The state/province in which the vehicle is located is selected by default.
- ▶ Select **State/Prov** in the address entry menu using the     buttons and press the  button to confirm. A menu with the available lists appears:
  - **Last States/Provinces**
  - **States (U.S.A.)**
  - **Provinces (Canada)**
- ▶ **To select the list:** press the  or  button and press the  button to confirm. The list of selected states/provinces appears.
- ▶ **To select the state/province:** press the  or  button and press the  button to confirm. The address entry menu appears again. The state/province selected is entered automatically.

### Entering a city

- ▶ **i** Entering a city will delete a previously entered ZIP code.
- ▶ Select **City** in the address entry menu using the     buttons and press the  button to confirm. You will see the city list either with the character bar (option 1) or as a selection list (option 2).

#### Option 1: city list with the character bar

- ▶ Enter **BERLIN**. Instructions for entering characters can be found in the "Entering characters in navigation mode (entering a city)" section (▶ page 22).



P82.87-5324-31

### Option 2: city list as selection list

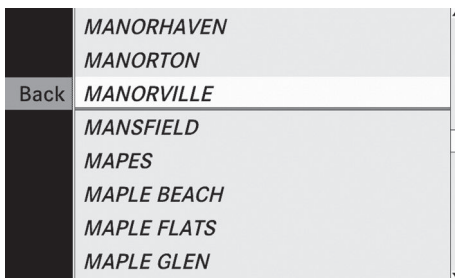

P82.87-2477-31

#### ① Selection marker

- ▶ Press the or button repeatedly until the desired city is selected (**MANORVILLE** in the example).
- ▶ Irrespective of the option, press the button to confirm your selection. The address entry menu appears again. **MANORVILLE** has now been entered.

### Entering a street name

- i** Entering the name of a street deletes a previously entered center name.
- ▶ Select **Street** in the address entry menu using the , , , buttons and press the button to confirm. You will see the street list either with the character bar (option 1) or as a selection list (option 2).

#### Option 1: street list with character bar

- ▶ Enter **ACCESS BLVD**. Instructions for entering characters can be found in the

"Entering characters in navigation mode (entering a city)" section (▷ page 22).

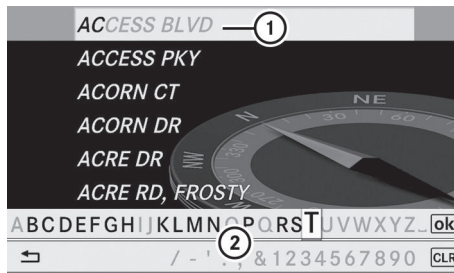

P82.86-9995-31

- ① List entry most closely resembling the characters entered
- ② Character bar

### Option 2: street list as selection list







P82.86-9996-31

#### Street list

- ▶ Press the or button repeatedly until **A EXT, AVENUE** is selected.
- ▶ Irrespective of the option, press the button to confirm your selection. The address entry menu appears again. **A EXT, AVENUE** has now been entered.

### Entering the house number

- i** Entering a house number will delete a previously entered intersection. Entering an intersection will delete a previously entered house number.

- ▶ Select **No.** in the address entry menu using the     buttons and press the  button to confirm. You will see the house number list either with the character bar (option 1) or as a selection list (option 2).

### Option 1: house number list with character bar

- ▶ Enter **1**. Instructions for entering characters can be found in the "Entering characters in navigation mode (entering a city)" section (▷ page 22).

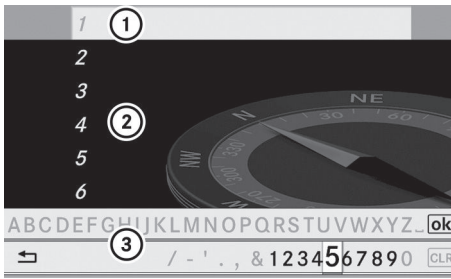

P82.86-9998-31

- ① Entry most closely resembling the characters entered so far
- ② List
- ③ Character bar

### Option 2: house number list as selection list

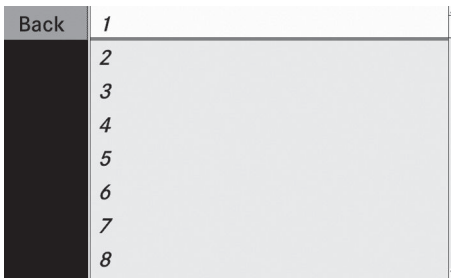

P82.86-9999-31

House number list

- ▶ Press the  or  button repeatedly until **1** is selected.

- ▶ Irrespective of the option, press the  button to confirm your selection. The address entry menu appears again. **1** has now been entered.

### Starting route calculation

You can now have COMAND calculate the route to the address entered or save the address first, e.g. as your home address (My address) (▷ page 52).

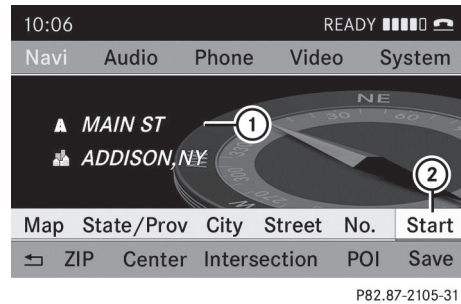

P82.87-2105-31

Address entry menu with destination address

- ① Destination address
- ② Starting route calculation

- ▶ In the address entry menu, confirm **Start** by pressing the  button. If no other route has been calculated, route calculation starts immediately (Option 1). If another route has already been calculated (route guidance is active), a prompt appears (option 2).

**Option 1 – no route guidance active:** route calculation starts. While route calculation is in progress, an arrow will indicate the direction to your destination. Below this, you will see the message **Calculating Route**, for example.

Once the route has been calculated, route guidance begins. If the vehicle is traveling on a non-digitized road, the linear distance to the destination is shown. In this case, the display will be grayed out.

**Option 2 – route guidance is already active:** if route guidance is already active, a prompt will appear asking whether you wish

to terminate the currently active route guidance.

- ▶ Select **Yes** or **No** and press the **OK** button to confirm.

If you select **Yes**, COMAND will stop route guidance and start route calculation for the new destination.

If you select **No**, COMAND will continue with the active route guidance.

- ❗ **Route calculation takes a certain amount of time.** The time depends on the distance from the destination, for example. COMAND calculates the route using the digital map data. The calculated route may differ from the ideal route, e.g. due to roadwork or incomplete map data.

## Entering and saving your home address

### Entering your home address for the first time

- ▶ Enter the address as a destination, e.g. in the form of a city, street and house number (▷ page 49).
- ▶ After entering the address in the address entry menu, select **Save** using the **◀ ▶ ▲ ▼** buttons and press the **OK** button to confirm.
- ▶ Select **Save as "My Address"** and press the **OK** button to confirm. COMAND stores your home address as **My Address** in the destination memory.

### Changing a previously entered home address

- ▶ Proceed as described under "Entering your home address for the first time". A prompt appears asking whether the current home address should be overwritten.

- ▶ Select **Yes** and press the **OK** button to confirm. After selecting **Yes**, the **Saving Procedure Successful** message appears.

## Entering a ZIP code

- ❗ Entering a ZIP code will delete a previously entered city.
- ▶ Select **ZIP** in the address entry menu using the **◀ ▶ ▲ ▼** buttons and press the **OK** button to confirm. You will see the ZIP code list either with the character bar (option 1) or as a selection list (option 2).

### Option 1: ZIP code list with character bar

- ▶ Enter a ZIP code. Instructions for entering characters can be found in the "Entering characters in navigation mode (entering a city)" section (▷ page 22).

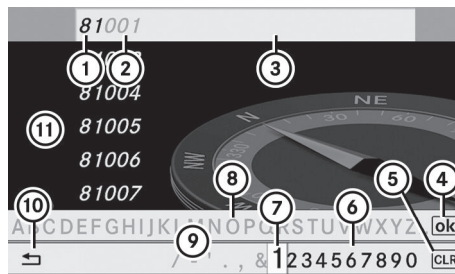

P82.86-9993-31

- ① Digits entered by the user
- ② Digits automatically added by the system
- ③ List entry most closely resembling the characters entered so far
- ④ To switch to the list without the character bar
- ⑤ To delete the entire entry: press and hold; to delete the last character: press briefly
- ⑥ Available characters
- ⑦ Selected character
- ⑧ Unavailable characters
- ⑨ Character bar

- ⑩ To cancel an entry
- ⑪ List
- ▶ Complete the entry and call up the list as a selection list (▷ page 24).

### Option 2: ZIP code list as selection list

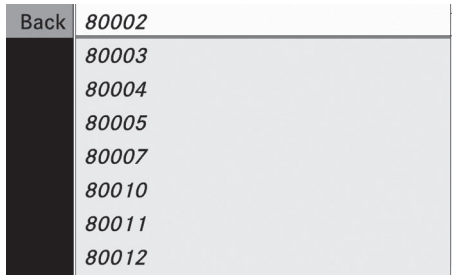

P82.86-9994-31

ZIP code list

- ▶ Press the or button repeatedly until the desired ZIP code has been selected.
- ▶ Irrespective of the option, press the button to confirm your selection. If COMAND is able to assign the ZIP code unambiguously to a specific address, the address entry menu appears again. The ZIP code appears in place of the city's name. If COMAND cannot assign the ZIP code unambiguously to a specific address, the address entry menu also appears again. The ZIP code is automatically entered. You can now enter the street for a more precise location. Only streets in the area covered by the entered ZIP code are available.
- ▶ Start route calculation (▷ page 51).

### Entering a center

- ▶ Select **Center** in the address entry menu using the , , , buttons and press the button to confirm. You will see the center list either with the character bar (option 1) or as a selection list (option 2).

#### Option 1: center list with character bar

- ▶ Enter a center. Instructions for entering characters can be found in the "Entering characters in navigation mode (entering a city)" section (▷ page 22).

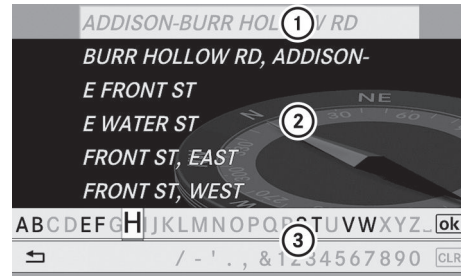

P82.87-2103-31

- ① List entry most closely resembling the characters entered so far
- ② List
- ③ Character bar
- ▶ Complete the entry and call up the list as a selection list (▷ page 24).

#### Option 2: center list as selection list







P82.86-9997-31

- ▶ Select a center using the buttons.
- ▶ Irrespective of the option, press the button to confirm your selection. The address entry menu appears again. The center selected has been entered.
- ▶ Start route calculation (▷ page 51).

### Entering an intersection name

Entering an intersection will delete a previously entered house number.

- ▶ Select **Intersection** in the address entry menu using the     buttons and press the  button to confirm. You will see the intersection list either with the character bar (option 1) or as a selection list (option 2).

#### Option 1: intersection list with character bar

- ▶ Enter an intersection. Instructions for entering characters can be found in the "Entering characters in navigation mode (entering a city)" section ([▷ page 22](#)).

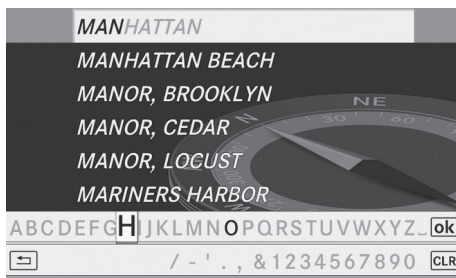



P82.87-5460-31

- ① List entry most closely resembling the characters entered so far
  - ② List
  - ③ Character bar
- ▶ Complete the entry and call up the list as a selection list ([▷ page 24](#)).

#### Option 2: intersection list as selection list









P82.87-2478-31

- ▶ Select an intersection using the   buttons.
- ▶ Irrespective of the option, press the  button to confirm your selection. The address entry menu appears again. The intersection selected has been entered.
- ▶ Start route calculation ([▷ page 51](#)).

### Selecting a destination from the destination memory (e.g. My address)

#### Introduction

The destination memory always contains an entry named "My address". You may wish to assign your home address to this entry, for example, and select it for route guidance. This entry is always located at the top of the list in the destination memory.

- ▶ **To switch to navigation mode:** press the  function button.
- ▶ **To show the menu:** press the  button.
- ▶ Select **Destination** in the navigation menu bar using the    buttons and press the  button to confirm.
- ▶ Select **From Memory** and press the  button to confirm. You will see the destination memory list either with the character bar (option 1) or as a selection list (option 2).

#### Option 1: destination memory list with character bar

- ▶ Select a destination by entering characters in navigation mode (entering a city) ([▷ page 23](#)), e.g. the **My Address** entry.



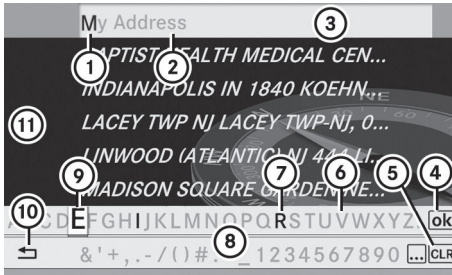

P82.87-2106-31

- ① Character entered by the user
- ② Characters automatically added by the system
- ③ List entry that most closely matches the current input string
- ④ To switch to the selection list
- ⑤ To delete an entry
- ⑥ Characters not currently available
- ⑦ Characters currently available
- ⑧ Character bar
- ⑨ Currently selected character
- ⑩ To cancel an entry
- ⑪ Destination memory list

**Option 2: destination memory list as selection list**

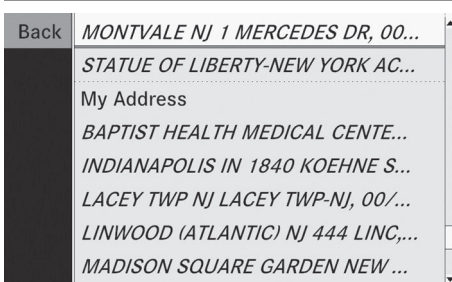

P82.87-2107-31

Destination memory list

- ▶ Press the or button repeatedly until the desired entry, e.g. **My Address**, is selected.

- ▶ Irrespective of the option, press the button to confirm your selection. The address entry menu appears again. "My address" has been entered.

- ▶ **To start route calculation:** select **Start** and press the button to confirm. Once the route has been calculated, route guidance begins (▷ page 65).

**Selecting a destination from the list of last destinations**

- ▶ **To switch to navigation mode:** press the function button.
- ▶ **To show the menu:** press the button.
- ▶ Select **Destination** in the navigation menu bar using the buttons and press the button to confirm.
- ▶ Select **From Last Destinations** and press the button to confirm. If the destination memory contains more than eight entries, you will see the list of previous destinations with the character bar. Otherwise, the list will be shown as a selection list.

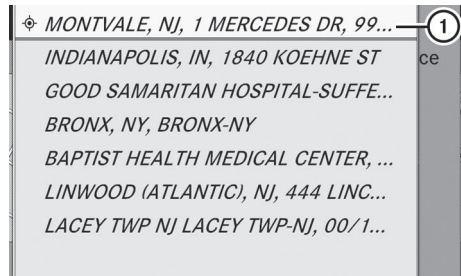

P82.87-2108-31

"Last destinations" list

- ① Last destination
- ▶ Press the or button repeatedly until the desired destination has been selected.

- ▶ Irrespective of the option, press the **OK** button to confirm your selection. The address entry menu appears again. The destination address selected has been entered.

- i** Further information on "Last destinations" memory can be found on (> page 80).

### Entering a destination using the map

#### Calling up the map

- ▶ **To switch to navigation mode:** press the **NAVI** function button.
- ▶ **To show the menu:** press the **OK** button.
- ▶ Select **Destination** in the navigation menu bar using the **◀ ▶ ▼** buttons and press the **OK** button to confirm.
- ▶ Select **Using Map** and press the **OK** button to confirm. You see the map with the crosshair.

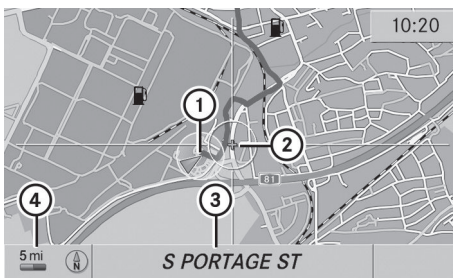

P82.87-2468-31

Map with crosshair

- ① Current vehicle position
- ② Crosshair
- ③ Details of the crosshair position
- ④ Map scale selected

Display ③ depends on the settings selected in "Information on map" (> page 84). The current street name can be shown, provided the digital map contains the necessary data, or the coordinates of the crosshair if the geo-

coordinate display is switched on and the GPS signal is strong enough.

#### Moving the map and selecting the destination

- ▶ Scroll the map using the **◀ ▶ ▲ ▼** button.
- ▶ **To set the map scale:** press the **#+** or **#** button. The scale bar appears.
- ▶ Press the **#+** button to zoom out of the map.
- ▶ Press the **#** button to zoom in on the map.
- ▶ **To select a destination:** press the **OK** button. If the crosshair is located outside the digital map, it is not possible to calculate a route to this destination. You will see the **The crosshair is off the map** message. If the crosshair is located over a body of water, you will see the message: **The destination is in a body of water. Please select another destination.**
- ▶ Select **OK** and press the **OK** button to confirm. If the destination is within the limits of the digital map, COMAND attempts to assign the destination to the map. If the destination can be assigned, you will see the address entry menu with the address of the destination. If not, you will see the entry **Destination From Map**.
- ▶ **To start route calculation:** select **Start** and press the **OK** button to confirm.



## Entering an intermediate stop

### Introduction

When route guidance is active, you can enter an intermediate stop. Intermediate stops can be predefined destinations from the following categories that COMAND offers for selection:

- Mercedes-Benz Service
- Hospital
- Gas Station
- Parking Lot
- Restaurant

However, you can also enter destinations other than the predefined ones. To do this select the menu item **Other**.

You can use the intermediate stop function to influence route guidance to the main destination. When you have reached your intermediate stop, COMAND automatically recalculates the route to the main destination.

### Entering predefined destinations

- ▶ **To switch to navigation mode:** press the **NAVI** function button.
- ▶ **To show the menu:** press the **OK** button.
- ▶ Select **Destination** in the navigation menu bar using the **▼** **◀** **▶** buttons and press the **OK** button to confirm.
- ▶ Select **Stopover** and press the **OK** button to confirm.

**Option 1: no intermediate stop has been entered yet.**

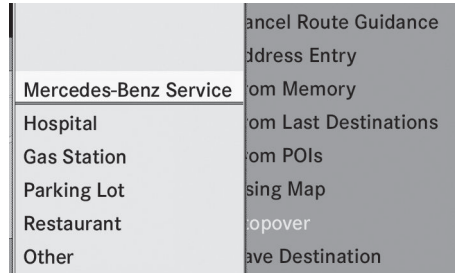

P82.87-5419-31

Intermediate stop categories

- ▶ Select a category.

**Option 2: an intermediate stop has already been entered.**

- ▶ Select **Change Stopover** and press the **OK** button to confirm.
- ▶ Select a category using the **▲** **▼** buttons and press the **OK** button to confirm. COMAND first searches in the selected category for destinations along the route. If there are no destinations available there, COMAND searches for destinations within a radius of 100 km of the vehicle position. If COMAND finds destinations, a list appears on the right-hand side of the display.



P82.87-5421-31

Example of display with "gas station" category selected

- ① Intermediate stop highlighted on the map
- ② Current distance to and name of the intermediate stop

The list shows intermediate stop destinations **On The Route** and **In the area**.

The intermediate stops are listed according to increasing distance from the current vehicle position.

- ▶ **i** For intermediate stops that are not located along the calculated route, the linear distance is shown.

If COMAND does not find any destinations, you will see a message to this effect.

- ▶ Confirm **OK** by pressing the **OK** button.
- ▶ Select a different category.
- ▶ Select the intermediate stop using the **▲** **▼** buttons and press the **OK** button to confirm.  
The address entry menu appears, showing the destination address.
- ▶ **To start route calculation:** select **Start** and press the **OK** button to confirm.

### Entering another destination as an intermediate stop

- ▶ **To switch to navigation mode:** press the **NAVI** function button.
- ▶ **To show the menu:** press the **OK** button.
- ▶ Select **Destination** in the navigation menu bar using the **▼** **◀** **▶** buttons and press the **OK** button to confirm.
- ▶ Select **Stopover** and press the **OK** button to confirm.
- ▶ Select **Other**.
- ▶ Select **Address Entry**, **From Memory**, **From Last Destinations** or **From POIs**.

Selection	Step
Address Entry	▶ Enter a destination by address (> page 48).
From Memory	▶ Select a destination from the destination memory (> page 54).
From Last Destinations	▶ Select a destination from the list of last destinations (> page 55).
From POIs	▶ Enter a point of interest (> page 60).

- ▶ **To start route calculation:** once you have entered a destination, select **Start** and press the **OK** button to confirm.

### Deleting an intermediate stop

If an intermediate stop has already been entered, you can delete it.

- ▶ **To switch to navigation mode:** press the **NAVI** function button.
- ▶ **To show the menu:** press the **OK** button.
- ▶ Select **Destination** in the navigation menu bar using the **◀** **▶** **▼** buttons and press the **OK** button to confirm.
- ▶ Select **Stopover** and press the **OK** button to confirm.
- ▶ Select **Delete Stopover** and press the **OK** button to confirm.  
COMAND deletes the intermediate stop and recalculates the route to the main destination.

## Search & Send

### Notes

**i** To use Search & Send, your vehicle needs to be equipped with mbrace, a navigation system and a valid mbrace subscription.

"Search & Send" is a service assisting you in entering destinations for the navigation system. This mbrace service can send a destination address directly from the Google Maps® website to the navigation system of your vehicle.

### Selecting and sending a destination address

**i** Observe the notes on entering and sending an address provided on the respective website. Each website operates in a different way and is subject to changes and amendments.

- ▶ Access the <http://maps.google.com> website and enter the destination address in the address entry field.
- ▶ Click the corresponding button to send the destination address to the e-mail address registered with mbrace.
- ▶ Enter the e-mail address you specified when setting up your mbrace account into the corresponding field in the "Send" dialog window.
- ▶ Click "Send".

### Calling up a destination address

- ▶ Press the mbrace information button to begin downloading the destination address to your vehicle's navigation system.



**i** If you have sent more than one destination address to your vehicle's navigation system, you will need to call up the information individually for every address to be downloaded.

- ▶ Select **Yes** when the prompt for starting the navigation system is shown. The window for starting the navigation system appears (▶ page 51).

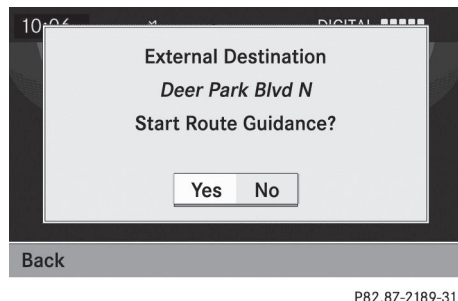

- ▶ Select **Start**.

or

- ▶ Select **No** if you want to store the downloaded destination in the **From Memory** destination list for later use.

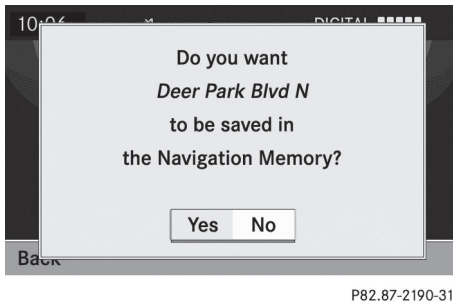

- i** The destination addresses are downloaded in the same order as they are sent. If you own several Mercedes-Benz vehicles equipped with an mbrace subscriber account, each destination address can be downloaded by each vehicle associated with the e-mail address registered for your mbrace account.

## Entering a point of interest

### Initiating point of interest entry

- ▶ **To switch on navigation mode:** press the **NAVI** function button.
- ▶ **To show the menu:** press the **OK** button.
- ▶ Select **Destination** in the navigation menu bar using the **◀ ▶ ▼** buttons and press the **OK** button to confirm.
- ▶ Select **From POIs** and press the **OK** button to confirm.

### Entering a point of interest in the vicinity of the destination

Entering a point of interest in the vicinity of the destination is only possible when route guidance is active.

- ▶ Select **Near Destination** from the menu and press the **OK** button to confirm.
- ▶ Continue with assigning the point of interest category (▷ page 61).

### Entering a point of interest in the vicinity of the current position

- ▶ Select **Current Position** and press the **OK** button to confirm.
- ▶ Continue with assigning the point of interest category (▷ page 61).

### Entering a point of interest in the vicinity of a city

#### Option 1

- ▶ Select **Other City** and press the **OK** button to confirm.
- ▶ If desired, select the state/province (▷ page 49).
- ▶ **To enter a city:** select **City** and press the **OK** button to confirm.  
Proceed as described in the "Entering a city" section (▷ page 49).
- ▶ After entering the city, assign the point of interest category (▷ page 61).

#### Option 2

- ▶ Enter an address in the address entry menu (▷ page 49).
- ▶ Select **POI** and press the **OK** button to confirm.
- ▶ Assign a point of interest category (▷ page 61).

### Entering a point of interest using name search

This function gives you access to all points of interest available in the digital map.

- ▶ Select **Search By Name** and press the **OK** button to confirm.  
You will see a list of all points of interest.

- ▶ Proceed as described in the "Point of interest list with character bar" section (> page 64).

### Entering a point of interest using the phone number search

This function gives you access to all points of interest that have a phone number.

- ▶ Select **Search By Phone Number** and press the **(OK)** button to confirm. You will see a list of phone numbers.
- ▶ Proceed as described in the "Point of interest list with character bar" section (> page 64).

### Assigning a point of interest category

#### Introduction

The categories and points of interest available depend on the distance from the vehicle position you have set for the point of interest.

- point of interest in the vicinity of the destination:
 

Alphabetically sorted categories are available, as well as points of interest in the vicinity of the destination position arranged by distance.
- point of interest in the vicinity of the current position:
 

Alphabetically sorted categories are available, as well as points of interest in the vicinity of the vehicle position arranged by distance.
- point of interest within a given city:
 

If you have only entered the state/province and the city, alphabetically sorted categories and alphabetically sorted points of interest within the city are available.

If you have entered more information than the state/province and the city, alphabetically sorted categories and points

of interest sorted by distance within the vicinity of the address entered are available.

- point of interest using name search:
 

An alphabetically sorted list of all points of interest is available.

### Selecting a category

Depending on the number of categories available, you will see the main category list either with the character bar (option 1) or as a selection list (option 2).

#### Option 1: main category list with character bar

- ▶ Select a category. Proceed as described in the "Entering characters" section (> page 22).

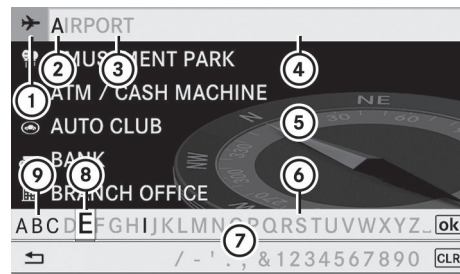

P82.87-2110-31

- ① Icon for main category
- ② Character entered by the user
- ③ Characters added by the system
- ④ List entry most closely resembling the characters entered by the user
- ⑤ Main category list
- ⑥ Characters currently not available for selection
- ⑦ Character bar
- ⑧ Selected character
- ⑨ Characters available for selection

#### Option 2: main category list as selection list

- ▶ Select a main category using the **(▲)** **(▼)** buttons.

- Irrespective of the option, press the **OK** button to confirm your selection. If the selected main category does not contain any sub-categories, the point of interest list appears.

If the selected main category contains sub-categories, you will see the list of sub-categories either with the character bar (option 1) or as a selection list (option 2). The following illustration shows the **RESTAURANT** main category with available sub-categories as an example.

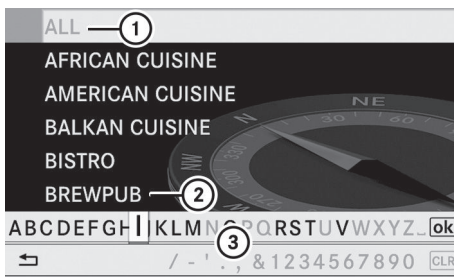

P82.87-2112-31

- ① To call up all entries in the **RESTAURANT** main category
  - ② To call up all entries in the **BREWPUB** subcategory
  - ③ Character bar
- **Option 1:** select a category. Proceed as described in the "Searching for a phone book entry" section (► page 103).
  - **Option 2:** select a category using the **▲** **▼** buttons and press the **OK** button to confirm.

The point of interest list appears. It contains the points of interest that are available in the subcategory and are within the search radius.

- ❗ **Search radius means:** COMAND searches within a radius of approximately 100 km and ceases searching when 50 points of interest have been found.

If COMAND does not find any points of interest within this radius, it extends its search range to approximately 200 km. If

COMAND finds one point of interest within this radius, it finishes the search.

- ❗ If you select the **ALL** list item, the point of interest list contains all points of interest for all subcategories in the **RESTAURANT** main category which lie within the search radius.

If you select the **OTHER RESTAURANTS** list item at the end of the list, the points of interest contains all points of interest which cannot be assigned to any subcategory of the **RESTAURANT** main category and which lie within the search radius.

## Point of interest list

### Introduction

The illustration below shows an example of the point of interest list for the **RESTAURANT** main category and **BREWPUB** subcategory in the vicinity of the current position.

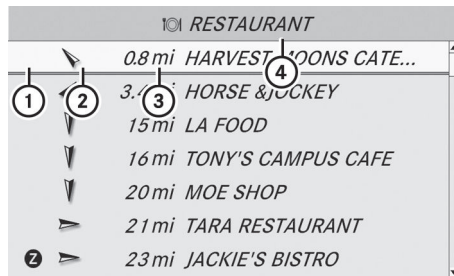

P82.87-2113-31

- ① point of interest
- ② Compass heading to the point of interest
- ③ Linear distance to the point of interest
- ④ Selected category or subcategory

- ❗ Display ③ is not visible if you have entered a point of interest within a given city and only the country and city have been entered.



Depending on the point of interest selected, COMAND uses different reference points in determining the linear distance to the destination:

- vicinity of current position: the linear distance is the distance of the point of interest from the current vehicle position.
- vicinity of destination: the linear distance is the distance of the point of interest from the destination entered.

Long names of points of interest are abbreviated. An information icon is shown after the entry.

► **To call up the complete display:** press the  button.



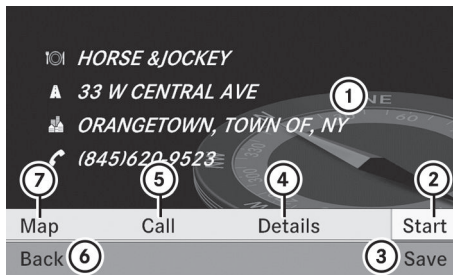

### Selecting a point of interest

- Select a point of interest using the   buttons and press the  button to confirm. The full address of the point of interest selected appears.



P82.87-2114-31

- ① Point of interest with address
- ② To start route calculation
- ③ To store an address in the destination memory
- ④ To display details
- ⑤ To make a call (when available)
- ⑥ To cancel selection
- ⑦ To show an address on the map

- **To start route calculation:** select **Start** and press the  button to confirm.
- **To store an address in the destination memory:** select **Save** and press the  button to confirm. You can now select storage options (► page 79).
- **To show the detailed view:** select **Details** and press the  button to confirm.
- **To connect a call:** select **Call** and press the  button to confirm (available if the point of interest entry contains a phone number).
- **To call up the map:** select **Map** and press the  button to confirm.
- You can scroll the map and select a destination (► page 56).

### ZAGAT® rating service

Entries featuring the Z icon contain additional ZAGAT information. ZAGAT rates restaurants, for instance, in regard to the quality of the food, furnishing, service, and provides an average pricing level as well as a general description.



P82.87-2118-31

After selecting an entry with a Z icon, you can call up the ZAGAT rating in the subsequent screen.





P82.87-2119-31

- ① ZAGAT ratings
- ② To display details

- ▶ **To display the description:** select **Details**.

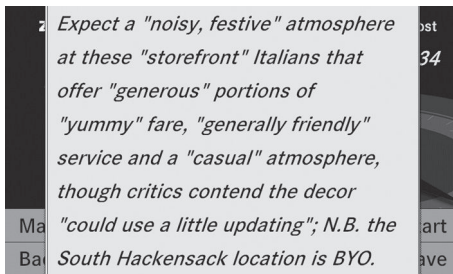

P82.87-2120-31

Example of a ZAGAT description

### Point of interest list with character bar

If you have selected "Searching for a point of interest by name" (▷ page 60) or "Searching for a point of interest by phone number", the list of all points of interest contained on the map appears.

Proceed as described in the "Searching for a phone book entry" section (▷ page 103).

- ❗ If COMAND can unambiguously assign the characters entered to one entry, the address entry appears automatically.
- ▶ **To start route calculation:** select **Start** and press the **OK** button to confirm.

### Entering a point of interest using the map

- ▶ **To switch on navigation mode:** press the **NAVI** function button.
- ▶ **To show the menu:** press the **OK** button.
- ▶ Select **Guide** in the navigation menu bar using the **▼**, **◀**, **▶** buttons and press the **OK** button to confirm.

If points of interest are available:

Depending on the map scale selected, point of interest icons appear on the map. The scale at which the icons are displayed on the map varies according to the icon. You can select the icons that COMAND will display (▷ page 83).

If there are points of interest, you will see a message to this effect.

- ❗ You also see this message if you have selected the menu item **No Symbols** under "Map display" (▷ page 83).
- ▶ Press the **OK** button and confirm the message.



P82.87-2121-31

Point of interest on the map

- ① Information about the highlighted point of interest
- ② Highlighted point of interest
- ▶ **To select a point of interest:** select **Next** or **Previous** and press the **OK** button to confirm.
- ▶ **To show details for the selection:** select **Details** and press the **OK** button to confirm.



- ▶ **To start route calculation:** select **Start** and press the **OK** button to confirm. A prompt appears asking whether the point of interest should be used as the destination.
- ▶ Select **Yes** or **No** and press the **OK** button to confirm. If you select **Yes**, route calculation begins. If you select **No**, you can select a new point of interest.

## Route guidance

### General information

#### **WARNING**

COMAND calculates the route to the destination without taking account of the following, for example:

- traffic lights
- stop and give way signs
- parking or stopping restrictions
- lane narrowing
- other road and traffic rules and regulations

COMAND may give incorrect driving recommendations if the data on the digital map does not correspond to the actual conditions, e.g. the road layout has changed.

For this reason, you must always observe the respective road and traffic rules and regulations during your journey. Road and traffic rules and regulations always have priority over system driving recommendations.

Route guidance begins once a route has been calculated (▶ page 51).

COMAND guides you to your destination by means of navigation commands in the form of audible navigation announcements and route guidance displays.

The route guidance displays can only be seen if the display is switched to navigation mode.

If you do not follow the navigation announcements or if you leave the calculated

route, COMAND automatically calculates a new route to the destination.

If the digital map contains the corresponding information, the following applies:

- when selecting a route, COMAND tries to avoid roads that only have limited access, e.g. roads closed to through traffic and non-residents.
- roads that have time restrictions (e.g. closed on Sundays and public holidays) are avoided for route guidance.

### Switching between the full-screen map and the change-of-direction display

- ▶ Press the **NAVI** button. COMAND switches to the respective display.

### Change of direction

#### Introduction

Changes of direction have three phases:

- Preparation phase
- Announcement phase
- Change-of-direction phase

#### Preparation phase

COMAND prepares you for the upcoming change of direction. Based on the example display below, the change of direction is announced with the **Prepare to turn right** message. The map can be seen in the full-screen display.

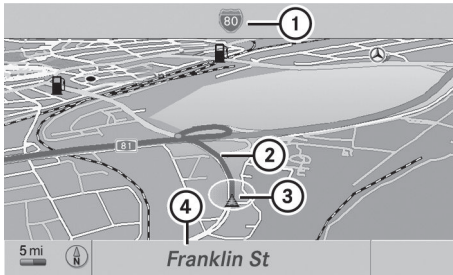

P82.87-2122-31

Example display: initiation phase

- ① Next road
- ② Point at which the change of direction takes place (light blue dot)
- ③ Current vehicle position (the tip of the triangle indicates the vehicle's direction of travel)
- ④ Current road

Display ④ depends on the setting selected for "Information in map" (▷ page 84).

### Announcement phase

COMAND announces the imminent change of direction. Based on the following example, the change of direction is announced with the **In 400 meters turn right onto the A81** message.

The display is now split into two sectors. In the left half, you see the normal map view. In the right half, there is an enlarged view of the area surrounding the intersection (intersection zoom), the change of direction also being illustrated.

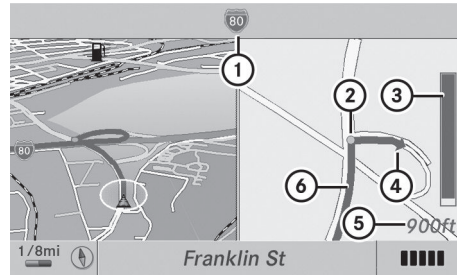

P82.87-3919-31

Example display: announcement phase

- ① Next road
- ② Point at which the change of direction takes place (light blue dot, shown in both the left and right half of the display)
- ③ Graphic representation of the distance to the next change of direction
- ④ Change of direction (turn right here)
- ⑤ Distance to the next change of direction
- ⑥ Route (blue line, shown in both the left and right half of the display)

**i** The filled-in section of visual display for distance ③ gets shorter the nearer you get to the announced change of direction.

### Change-of-direction phase

COMAND announces the imminent change of direction. Based on the example display below, the change of direction is announced 40 meters before the change of direction with the **Turn right** message. The display is split into two halves, as in the announcement phase.

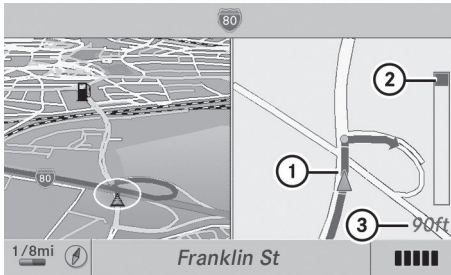

P82.87-3920-31

Example display: change-of-direction phase

- ① Current vehicle position (the tip of the triangle indicates the vehicle's direction of travel)
- ② Graphic representation of the distance to the next change of direction
- ③ Distance to the next change of direction

Once the change of direction is completed, COMAND automatically switches back to full-screen display.

### Lane recommendations

#### Overview

On multilane roads, COMAND can display lane recommendations for the next change of direction. The corresponding data must be available in the digital map.

COMAND displays lane recommendations ⑥, based on the next two changes of direction. The number of lanes reflects the situation at the point of the next change of direction. The situation beforehand may be different.

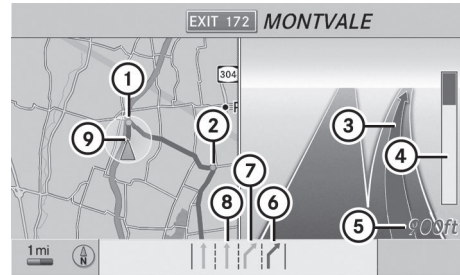

P82.87-2125-31

Example of display: day design

- ① Point of the next change of direction
- ② Point of the change of direction after next
- ③ Next change of direction (in this case, turn off to the right)
- ④ Graphic representation of the distance to the next change of direction
- ⑤ Distance to the next change of direction
- ⑥ Recommended lane (dark blue)
- ⑦ Possible lane (light blue)
- ⑧ Non-recommended lane (light gray)
- ⑨ Current vehicle position (the tip of the triangle indicates the vehicle's direction of travel)

### Display and description of lane recommendations

The colors used in the lane recommendation display vary depending on whether day or night design is switched on.

Lane	Day design	Night design
Recommended lane ⑥ In this lane, you will be able to complete the next two changes of direction without changing lanes.	Dark blue	Light blue
Possible lane ⑦ In this lane, you will only be able to complete the next change of direction without changing lanes.	Light blue	Dark blue
Lane not recommended ⑧ In this lane, you will not be able to complete the next change of direction without changing lane.	Light gray	Gray

#### Canceling or continuing route guidance

##### Canceling route guidance

- ▶ **To switch to navigation mode:** press the **NAVI** function button.
- ▶ **To show the menu:** press the **OK** button.
- ▶ Select **Destination** in the navigation menu bar using the **▼** **◀** **▶** buttons and press the **OK** button to confirm.
- ▶ Select **Cancel route guidance** and press the **OK** button to confirm.

##### Continuing route guidance

- ▶ **To switch to navigation mode:** press the **NAVI** function button.
- ▶ **To show the menu:** press the **OK** button.
- ▶ Select **Destination** in the navigation menu bar using the **▼** **◀** **▶** buttons and press the **OK** button to confirm.

- ▶ Select **Continue route guidance** and press the **OK** button to confirm. COMAND calculates the route.

#### Destination or area of destination reached

When you reach your destination, COMAND displays a checkered flag and route guidance is automatically ended.

For certain points of interest (airports or freeway intersections), you will see the **Area of destination reached** message in addition to the checkered flag.

#### Navigation announcements

##### **WARNING**

Navigation announcements are intended to direct you while driving without diverting your attention from the road and driving.







Please always use this feature instead of consulting the map display for directions. Consulting the symbols or map display for

directions may cause you to divert your attention from driving and increase your risk of an accident.







### Repeating navigation announcements

- i** Audible navigation announcements are muted during a telephone call.

If you have missed an announcement, you can call up the current announcement at any time.





- ▶ **To show the menu:** press the  function button.
- ▶ Select  in the navigation menu bar using the    buttons and press the  button to confirm.

### Switching navigation announcements on/off



- ▶ **To switch off:** press the  button during an announcement. You will briefly see the message: **The guidance instructions have been muted.**
- ▶ **To switch on:** press the  function button.
- ▶ Select  in the navigation menu bar using the    buttons and press the  button to confirm.
- i** COMAND automatically switches the navigation announcements back on when:
  - it receives RDS-TMC traffic reports during traffic-dependent route guidance and recalculates the route (▷ page 51).
  - you have a new route calculated.
  - you switch COMAND back on again or start the engine.

### Reducing volume during a navigation announcement

The volume of an active audio or video source can be automatically reduced during a navigation announcement.



- ▶ Select **Navi** in the main menu bar using the    buttons and press the  button to confirm.
- ▶ Select **Audio fadeout** and press the  button to confirm. Depending on the previous status, the function is switched on  or off .

### Setting the volume manually

- ▶ Adjust the volume using the  control knob during a navigation announcement.
- or
- ▶ Select  in the map view with the menu shown and adjust the volume using the  control knob.

### Navigation system displays in the multifunction display

#### Calling up the navigation system menu

- ▶ Press the  or  button repeatedly until **Navi** appears in the display.

The view in the multifunction display depends on whether route guidance is active or not.

**Route guidance is inactive:** the direction of travel and, if known, the name of the road you are currently traveling along are shown in the multifunction display.

**Route guidance is active:** the display in the multifunction display depends on whether a change of direction is announced or not.







When a change of direction is announced, you will see a symbol for the change of direction and a distance graphic. The distance indicator shortens towards the top of the display as you approach the point of the announced change of direction.





When route guidance is active, the following messages may be shown:

-  You have reached your destination.
- **NEW ROUTE**  
COMAND calculates a new route, e.g. because you have deviated from the calculated route or as a result of a traffic jam report. COMAND then continues route guidance.
- **CALC RTE**  
COMAND is calculating a route. COMAND then starts route guidance.
- **OFF MAP**  
The vehicle position is outside of the range of the digital map. The vehicle is in an off-map position.
- **OFF ROAD**  
The vehicle is on a road that is not on the digital map or the vehicle is no longer on a road, e.g. in a car park.
- **NO ROUTE**  
COMAND is unable to calculate a route to the selected destination.
- **Direction**  
The vehicle has entered an off-map position during route guidance.

#### Avoiding a section of the route blocked by a traffic jam







This function blocks a section of the route ahead of you. You can set the length of the blocked route section. If possible, COMAND calculates a detour around the blocked section of the route.

- ▶ **To switch to navigation mode:** press the  function button.
- ▶ **To show the menu:** press the .
- ▶ Select **Route** in the navigation menu bar using the    buttons and press the  button to confirm.

- ▶ Select **Detour** and press the  button to confirm.
- ▶ **To block a section of the route:** select **Longer** or **Shorter** repeatedly and confirm using the  button until the desired section has been selected.
- ▶ **i** The total length of the section that can be blocked is defined by the digital map. The menu items are available accordingly.
- ▶ **To start route calculation:** select **Start** and press the  button to confirm.
- ▶ **To change the blocked section:** select **Change** while the message is shown and press the  button to confirm.
- ▶ Then, block the desired section of the route.
- ▶ **To delete the blocked section:** select **Delete** while the message is shown and press the  button to confirm. COMAND calculates the route without the block.

#### Selecting an alternative route

With the "Alternative route" function, routes other than the original one can be calculated.

- ▶ **To switch to navigation mode:** press the  function button.
- ▶ **To show the menu:** press the .
- ▶ Select **Route** in the navigation menu bar using the    buttons and press the  button to confirm.
- ▶ Select **Alternative route** and press the  button to confirm. You see the selected route. The display now shows a split-screen view. On the left-hand side, one or more alternative routes are shown from start to destination. The current route is highlighted dark blue; other alternative routes appear light blue.

- ▶ **To select the next or previous alternative route:** select **Next** or **Previous** and press the **OK** button to confirm.  
Possible alternative routes are shown in the following order: **Personal route**, **Fast route**, **Economic route**, **Short route** and **Alternative route**.
- ▶ **To select the original route:** select **Back** a corresponding number of times and press the **OK** button to confirm.
- ▶ **To start route guidance using the selected alternative route:** select **Start** and press the **OK** button to confirm.

### Displaying destination information

You have entered a destination (▷ page 49) or a point of interest (▷ page 60) and possibly an intermediate stop (▷ page 57).

- ▶ **To switch to navigation mode:** press the **NAVI** function button.
- ▶ **To show the menu:** press the **OK** button.
- ▶ Select **Route** in the navigation menu bar using the **▼**, **◀**, **▶** buttons and press the **OK** button to confirm.
- ▶ Select **Destination information** and press the **OK** button to confirm.  
Destination information is displayed.

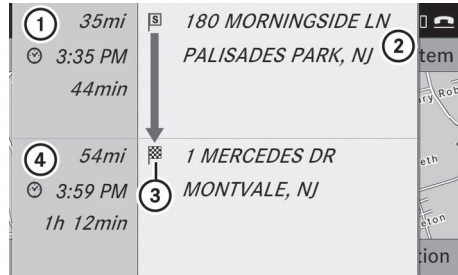

P82.87-4131-31

Example display: destination information

- ① Distance, estimated time of arrival and estimated remaining driving time to intermediate stop
- ② Intermediate stop **□**
- ③ Destination **□**
- ④ Distance to destination, estimated time of arrival and estimated remaining driving time

**i** If a phone number is available for a destination or an intermediate stop and you have connected a mobile phone, you can now call this number.

- ▶ **To dial the phone number:** select the phone using the **▲** or **▼** button and press the **OK** button to confirm.  
This initiates dialing.
- ▶ **To close the destination information display:** press the **◀**, **▶** or the **BACK** back button.

### Route browser

The route browser shows an overview of the route. You can use the route browser to move along the route section by section and view information and details about each section of the route.

You have entered a destination (▷ page 48) or a point of interest (▷ page 60) and possibly an intermediate stop (▷ page 57).

- ▶ **To switch to navigation mode:** press the **NAVI** function button.



- ▶ **To show the menu:** press the **OK** button.
- ▶ Select **Route** in the navigation menu bar using the **▼** **◀** **▶** buttons and press the **OK** button to confirm.
- ▶ Select **Route browser** and press the **OK** button to confirm.

At the top of the display, you will see information about the highlighted route section, for example the distance to be driven on the road and road designation. The highlighted route section is marked in white with a red border on the map.

- ▶ **To view the next or previous route section:** select **Next** or **Previous** and press the **OK** button to confirm.
- i** If the first or last route section is highlighted, you cannot select **Previous** or **Next**.
- ▶ **To zoom in or out of the map:** select **Q** or **Q** and press the **OK** button to confirm.
- ▶ **To close the route browser:** select **Back** and press the **OK** button to confirm.

### Off-road and off-map

#### Route guidance to an off-road destination

##### **⚠ WARNING**

The COMAND navigation system may direct you to off-road routes that your vehicle may not be capable of traversing through without damaging your tires, wheels or vehicle. It is the driver's sole responsibility to determine the suitability of the route. Off-road routes may be of varying conditions and their appropriateness for use may be affected by various factors such as time of day, time of year and immediate weather conditions that cannot be judged or taken into consideration by the COMAND system.

COMAND can guide you to destinations which are within the area covered by the digital map, but which are not themselves recorded on the map.

These destinations are known as off-road destinations, which you can enter using the map, for example. In these cases, COMAND guides you for as long as possible with navigation announcements and displays on roads known to the system.

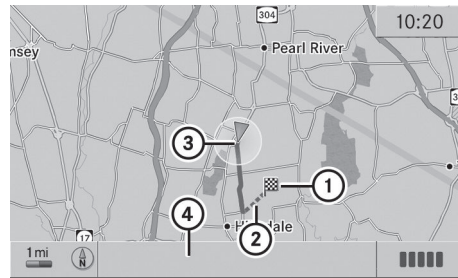

P82.87-3897-31

Example display: route guidance to an off-road destination

- ① Off-road destination
- ② Off-road section of the route
- ③ Current vehicle position: the tip of the triangle indicates the vehicle's direction of travel
- ④ Off-road, no street names available

Shortly before you reach the last known point on the map, you will see the **Area of destination reached** message and an arrow. The direction arrow shows the compass heading to the destination.

#### Route guidance from an off-road location to a destination

If the vehicle position is within the area covered by the digital map, but the map does not contain any information about that location, the vehicle is in an off-road location. COMAND is also able to guide you to a destination even from an off-road location.

At the start of the route guidance, you will see the **Off Mapped Road** message, an arrow and the distance to the destination. The arrow



shows the compass heading to the actual destination.

The route is highlighted blue, starting from the last recognized street the vehicle was on before it left the map.

As soon as the vehicle is back on a road known to the system, route guidance continues in the usual way.

### Route guidance from an off-map location to a destination

If the vehicle position is outside the area covered by the digital map, then the vehicle is in an off-map location. COMAND is also able to guide you to a destination even from an off-map location.

At the start of the route guidance, you will see the **Off Mapped Road** message, an arrow and the distance to the destination. The arrow shows the compass heading to the road left last.

The route is highlighted blue starting at the nearest road known to the system.

As soon as the vehicle is back on a road known to the system, route guidance continues in the usual way.

### Off-road during route guidance

Due to roadworks, for example, there may be differences between the data on the digital map and the actual course of the road.

In such cases, the system will temporarily be unable to locate the vehicle position on the digital map and thus considers the vehicle to be in an off-road position.

In the display, you will see the **Off Mapped Road** message, an arrow and the distance to the destination. The arrow shows the compass heading to the last road you were driving on.

As soon as the system can assign the vehicle position to the map again, route guidance continues in the usual way.

## Traffic reports



### Conditions

- ① The satellite radio reception described below requires optionally available satellite radio equipment as well as a subscription to SIRIUS XM Satellite Radio Traffic Message Service. Further details on satellite radio are available in the "Satellite radio" chapter (> page 121).

COMAND can receive traffic reports via satellite radio and incorporate them in the navigation system. Traffic reports and map icons can then be shown in the COMAND display.

### Real-time traffic reports on the map

COMAND can show certain traffic incidents on the map. The incidents are shown on the map at a scale from 1/16 mi to 20 mi.



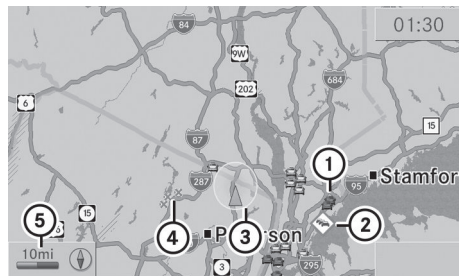

- ▶ Press  or  repeatedly until the desired map scale has been set.



P82.87-2482-31





- ① Icon display for the section of route affected
- ② Icon for incident on route
- ③ Current position and direction of travel
- ④ Icon delimiting the affected section of the route
- ⑤ Map scale

## Icon for real-time traffic reports

Icon	Description	Traffic reports in the map display	Traffic report list	Traffic report
	Warning (red)	N/A	Entry type: warning	Entry type: warning
	Caution (yellow)	N/A	Entry type: caution	Entry type: caution
	Traffic jam (speed & flow)	Appears when approaching a traffic jam (average speed between 25 and 45 mph) if route guidance is active and the route passes through the area affected by the traffic jam.  This icon may appear in conjunction with yellow vehicle icons.	Entry type: traffic jam on route (speed & flow)	Entry type: traffic jam on route (speed & flow)
	Traffic jam on the route	Appears when approaching a traffic jam (average speed between 5 and 20 mph) if route guidance is active and the route passes through the area affected by the traffic jam.  This icon may appear in conjunction with red vehicle icons.	Entry type: traffic jam on route	Entry type: traffic jam on route
	Blocked section on route	Appears at the beginning of a blocked section if route guidance is active and the route passes through the blocked area.  The XXXX icons can appear in conjunction with this icon.	Entry type: blocked route section	Entry type: blocked route section

Icon	Description	Traffic reports in the map display	Traffic report list	Traffic report
Yellow line with arrows	Incidents	Possible traffic blocks (e.g. roadworks) Appears on the side of the road affected (arrows indicate direction of traffic flow)	N/A	N/A
Green line with arrows	Unimpeded traffic flow	No traffic blocks Appears only on the side of the road with unimpeded traffic flow (arrows indicate the direction of traffic flow)	N/A	N/A

### Displaying real-time traffic reports

- ▶ If necessary, switch to navigation mode and show the menu (▷ page 47).
- ▶ Use the     buttons to select **TMC** and press the  button to confirm.

If you see a dialog window showing the **No Traffic Messages** message, this means that:

- no traffic reports have been received yet.
- no traffic reports are available.
- ▶ **To cancel the search:** select **Cancel**.
- ▶ **To close the message window:** select **OK**.



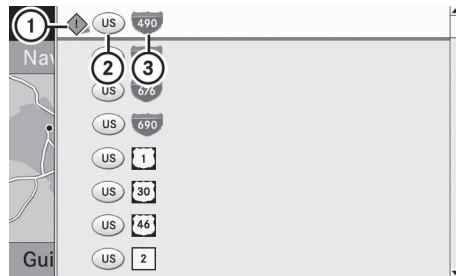

If there are any traffic reports, a list is shown. The content of the list varies depending on whether route guidance is active or not.

#### List when route guidance is not active

The list shows all the roads, areas or regions for which reports are available.



P82.87-2483-31

- ① Icon for warning message
- ② Country code
- ③ Road concerned
- ▶ **To show the list of traffic reports:** use the     buttons to select **Display All Messages** and press the  button to confirm.
- ❗ A traffic report may refer to an area or a region, e.g. if visibility is impaired due to fog.
- ▶ **To read a traffic report:** select a road, an area or a region.



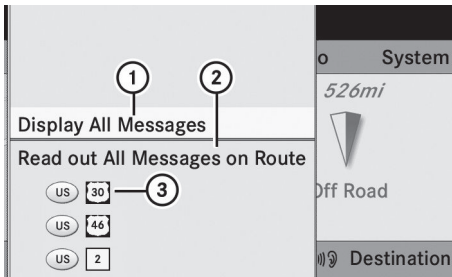

#### List when route guidance is active

The first list shows the roads, areas and regions that lie along the route and for which traffic reports are available.



P82.87-2487-31



- ① To show all traffic reports (including those not affecting the route)
- ② To have traffic reports read out, see read-aloud function (▷ page 73)
- ③ Affected roads, areas or regions (only available when there are traffic reports for the route)

► **To show all traffic reports:** use the     buttons to select **Display All Messages** and press the  button to confirm.

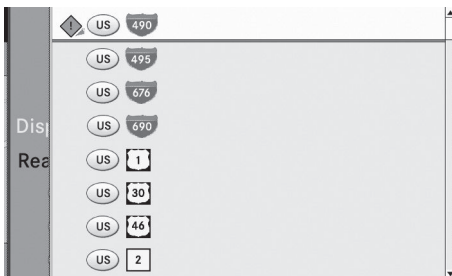
You see a list of all roads, areas and regions for which traffic reports are available, even if the reports do not affect your route.



P82.87-2488-31

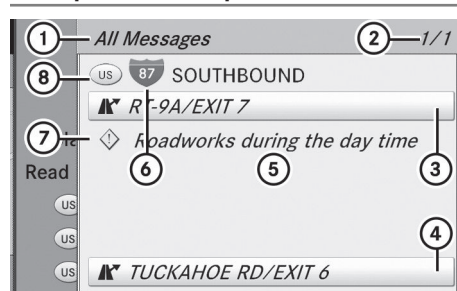

- **To display a report:** select a road, an area or a region from the list.
- **To close the list:** press the  or  button once or repeatedly.

### Example: traffic report



P82.87-3898-31

- ① Depending on your selection: **Messages On Route** or **All Messages**
- ② Report 1 of 1 for the road affected
- ③ Beginning of the affected route section
- ④ End of the affected route section
- ⑤ Text of report
- ⑥ Road, area or region affected by traffic reports
- ⑦ Icon for report type, e.g. warning message
- ⑧ Country code







► **To scroll within the message or to the next message:** press the  or  button.

► **To return to the message list:** press the  or  button.

### Read-aloud function





The read-aloud function is only available while route guidance is active. It reads out traffic reports affecting the current route. You can adjust the text reader volume (▷ page 27).

If the automatic read-aloud function for traffic reports is activated, received traffic reports are read out automatically.

- If necessary, switch on navigation mode and show the menu system (▷ page 47).
- Use the     buttons to select **TMC** and press the  button to confirm.
- Select **Read out all messages on route** and press the  button to confirm.

COMAND reads out the reports in sequence.

**i** The **Messages On Route** menu item has no function if there are no reports relating to the route.

► **To switch off the read-aloud function:** use the     buttons to select **Cancel Read-Aloud Function** and press the **OK** button to confirm.

COMAND reads the current report aloud and then exits the read-aloud function.

► **To cancel the read-aloud function for the current report:** press the  button. COMAND cancels the read-aloud function for the current report. Subsequent reports will still be read out.

## Destination memory

### Home address (My address)



#### Entering the home address via address entry

► Enter the home address as a destination, e.g. as a city, street and house number (> page 48). Then, save the home address without starting route guidance (> page 52).

#### Adopting an address book entry as a home address

► **To switch on navigation mode:** press the  function button.

► **To show the menu:** press the **OK** button.

► Select **Destination** in the navigation menu bar using the    buttons and press the **OK** button to confirm.

► Select **From Memory** and press the **OK** button to confirm.  
You will see the destination memory list either with the character bar (option 1) or as a selection list (option 2).

#### Option 1: destination memory list with character bar

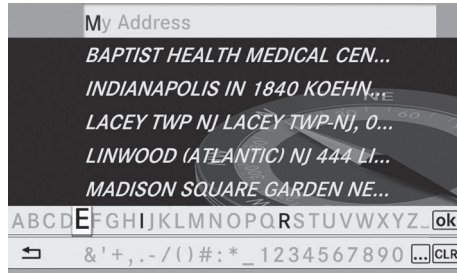

P82.87-2128-31

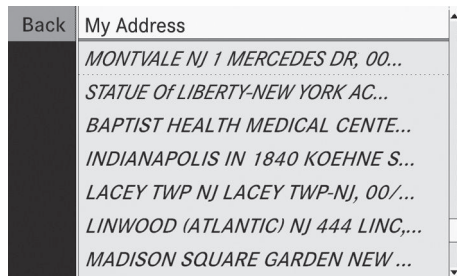

► Press and hold the **OK** button until the destination memory list appears as a selection list.

#### Option 2: destination memory list as selection list



P82.87-5409-31

The **My Address** entry is listed as the first entry in the destination memory.

► Select **My Address** using the   buttons and press the **OK** button to confirm.

**i** If you have not yet entered any characters, the **My Address** entry is automatically highlighted in the selection list.

If no home address has been stored yet, you can now assign an address book entry. If a home address already exists, it is displayed and you can alter it.

**i** If you select **New Entry**, you are also offered the option of entering the home address for the first time. You can then save the home address without having to start route guidance.

► **To enter the home address for the first time:** select **Assign to Address Book Entry** and press the **OK** button to confirm.

► Select **Home** or **Work** and press the **OK** button to confirm.

► **To change the home address:** select **Change** and press the **OK** button to confirm.

► Select **Assign to Address Book Entry** and press the **OK** button to confirm.

**i** If you select **New Entry**, you are also offered the option of changing the home address by entering an address. You can then save the home address without having to start route guidance.

► Select **Home** or **Work** and press the **OK** button to confirm.  
In both cases, you will see the address book either with the character bar or as a selection list.

► **To select an address book entry:** proceed as described in the "Searching for an address book entry" section (▷ page 109).

► **To confirm your selection:** press button **OK**.

If no home address has been stored, COMAND saves the entry. You will see a message and then the address menu with the selected address. **Start** is highlighted automatically.

If a home address has already been stored, you will see a prompt asking you whether the **My Address** entry should be overwritten.

► Select **Yes** or **No** and press the **OK** button to confirm.

If you select **Yes**, COMAND overwrites the destination. You will see a message and then the address menu with the selected address. **Start** is highlighted automatically.

If you select **No**, the list will reappear.

## Selecting the home address for route guidance

► Proceed as described in the "Entering a destination from the destination memory" section (▷ page 54).

## Saving a destination in the destination memory

### Notes

This function also stores the destination in the address book.

### After destination entry

► The destination has been entered and is shown in the address entry menu (▷ page 51).

► Select **Save** using the **▼** **◀** **▶** **▲** buttons and press the **OK** button to confirm.  
You can now select storage options (▷ page 79).

### During route guidance

► **To show the menu:** press the **OK** button.

► Select **Destination** in the navigation menu bar using the **▼** **◀** **▶** buttons and press the **OK** button to confirm.





► Select **Save Destination** and press the **OK** button to confirm.  
You can now select storage options (▷ page 79).

### From the list of previous destinations



► **To show the menu:** press the **OK** button.

► Select **Destination** in the navigation menu bar using the **▼** **◀** **▶** buttons and press the **OK** button to confirm.

► Select **From Last Destinations** and press the **OK** button to confirm.  
The list of previous destinations appears.

- ▶ Select the destination using the   buttons and press the  button to confirm.  
The destination address is shown.
- ▶ Select **Save** and press the  button to confirm.  
You can now select storage options (▷ page 79).

### Selecting storage options

- ▶ **To save the destination without a name:** select **Save Without Name** and press the  button to confirm.  
COMAND stores the destination in the destination memory and uses the address as the destination name.
- ▶ **To save the destination with a name:** select **Save With Name** and press the  button to confirm.
- ▶ Select a category, e.g. **Home**, and press the  button to confirm.  
The input menu appears with data fields and the character bar.

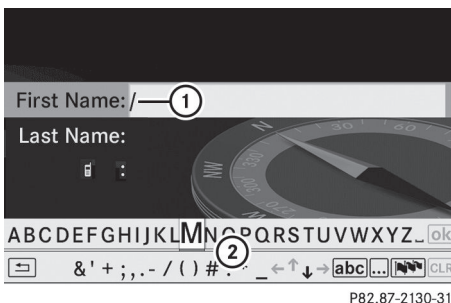



P82.87-2130-31

Example display: saving a destination with a name



- ① Selected data field with cursor
- ② Character bar
- ▶ Proceed as described under "Entering characters" in the Entering characters in

navigation mode (entering a city)" section (▷ page 23).



- ▶ Then select  and press the  button to confirm.  
COMAND stores the destination under the name entered.

### Assigning a destination to an address book entry











An address with complete address data that is suitable for navigation can be assigned to an already existing address book entry. You can then later start route guidance to this address straight from the address book (▷ page 112).

- ▶ Select **Assign to Address Book Entry** and press the  button to confirm.
- ▶ Select a category, e.g. **Home**, and press the  button to confirm.  
You will see the address book either with the character bar or as a selection list.
- ▶ **To select an address book entry:** proceed as described in the "Searching for an address book entry" section (▷ page 109).  
COMAND stores the data if the address book entry selected does not yet contain navigable address data.  
If the selected address book entry already contains navigable address data, a prompt will appear asking whether you wish to overwrite the existing data.
- ▶ Select **Yes** or **No** and press the  button to confirm.  
If you select **Yes**, COMAND stores the data.

### Deleting a destination or the home address from the destination memory

- ▶ **To switch on navigation mode:** press the  function button.
- ▶ **To show the menu:** press the  button.



- ▶ Select **Destination** in the navigation menu bar using the    buttons and press the  button to confirm.
- ▶ Select **From Memory** and press the  button to confirm.  
You will see the destination memory list either with the character bar (option 1) or as a selection list (option 2).
- ▶ **Option 1 – destination memory list with character bar:** proceed as described in the "Entering characters" section (▷ page 23).
- ▶ **Option 2 – destination memory list as a selection list:** select a destination using the   buttons and press the  button to confirm.  
The address data appears for the selected entry.
- ▶ Select **Delete** and press the  button to confirm.  
A prompt appears asking whether you wish to delete the destination.
- ▶ Select **Yes** or **No** and press the  button to confirm.  
If you select **Yes**, COMAND deletes the destination. You see a message to this effect.  
If you select **No**, the process will be canceled.

- i** If the navigable address data for the destination being deleted is also assigned to an address book entry, COMAND will also delete this data from there. If the corresponding address book entry does not contain any further data, such as telephone numbers, COMAND deletes the entire address book entry.

## Previous destinations

### Introduction







COMAND automatically stores the previous destinations for which the route calculation was started. If the memory is full, COMAND

deletes the oldest destination. You can also store one destination from the list of previous destinations in the destination memory. It will be stored there permanently.

### Storing a destination permanently in the destination memory

- ▶ Proceed as described in the "From the list of previous destinations" section (▷ page 78).







### Storing the vehicle position in the list of previous destinations

- ▶ **To switch on navigation mode:** press the  function button.
- ▶ **To show the menu:** press the  button.
- ▶ Select **Position** in the navigation menu bar using the    buttons and press the  button to confirm.
- ▶ Select **Save Vehicle Position** and press the  button to confirm.  
COMAND stores the current vehicle position as a destination in the list of previous destinations.

### Storing the crosshair position in the list of previous destinations

#### Route guidance not active

A crosshair appears on the map if you have moved the map manually. You can store the crosshair position as a destination in the list of previous destinations.

- ▶ **To show the menu:** press the  button.
- ▶ Select **Position** in the navigation menu bar using the    buttons and press the  button to confirm.
- ▶ Select **Save Crosshair Position** and press the  button to confirm.



### Route guidance is active

- ▶ **To show the menu:** press the **OK** button.
- ▶ Select **Position** in the navigation menu bar using the **▼** **◀** **▶** buttons and press the **OK** button to confirm.
- ▶ Select **Destination Position Map** and press the **OK** button to confirm.  
You will see the map with a crosshair at the destination.
- ▶ **To show the menu:** press the **OK** button.
- ▶ Select **Position** in the navigation menu bar using the **▼** **◀** **▶** buttons and press the **OK** button to confirm.
- ▶ Select **Save Crosshair Position** and press the **OK** button to confirm.  
COMAND stores the crosshair position as a destination in the list of previous destinations.

### Deleting one of the previous destinations

- ▶ **To switch on navigation mode:** press the **NAVI** function button.
- ▶ **To show the menu:** press the **OK** button.
- ▶ Select **Position** in the navigation menu bar using the **▼** **◀** **▶** buttons and press the **OK** button to confirm.
- ▶ Select **From Last Destinations** and press the **OK** button to confirm.  
The list of previous destinations appears.
- ▶ Select the desired destination and press the **OK** button to confirm.  
The destination address appears.
- ▶ Select **Delete** and press the **OK** button to confirm.  
A prompt appears, asking whether the entry should be deleted.

- ▶ Select **Yes** or **No** and press the **OK** button to confirm.  
If you select **Yes**, the entry is deleted.  
If you select **No**, the process will be canceled.

### Map operation and settings

#### Notes

Company logos displayed on the map are trademarks of the respective companies and used solely for the purpose of indicating the location of these companies. The use of such logos for the map does not indicate approval, support or advertisement of the navigation system by the respective companies.

#### Adjusting the map scale

- ▶ **To call up the scale bar:** press the **\*+** or **#** button.  
The map scale appears at the upper edge of the screen.
- ▶ **To zoom in the map:** press the **\*+** button as often as necessary.
- ▶ **To zoom out the map:** press the **#** button as often as necessary.

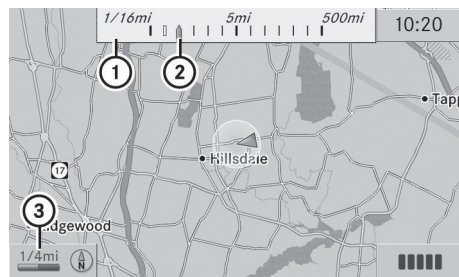

P82.87-3922-31







Map with scale

- ① Map scale
- ② Currently set map scale as indicated by the needle on the scale bar
- ③ Current map scale expressed as a number with unit

Unit of measurement ③ in the COMAND display depends on the selection made for the instrument cluster (see the vehicle Operator's Manual).

### Moving the map

#### Showing the crosshair

- ▶ **To hide the menu:** press the  button and when the **Full Screen** menu item is shown, press the  button.
- ▶ **To scroll the map:** press the     buttons.

A crosshair appears on the map. If you press one of the buttons again, the map moves under the crosshair in the corresponding direction.

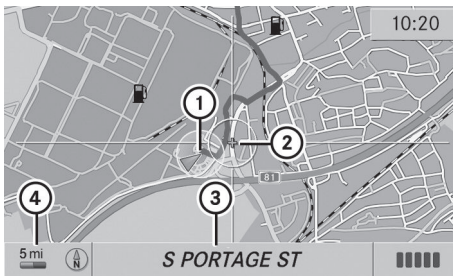

P82.B7-3892-31

- ① Current vehicle position
- ② Crosshair
- ③ Details of the crosshair position
- ④ Map scale selected







Display ③ may be the name of a street, for example, provided the digital map contains the necessary data. Or it may show the geo-coordinate position of the crosshair if the **Geo-coordinates** display is switched on (▶ page 85).

#### Hiding the crosshair and centering the map on the vehicle position or destination







- ▶ Press the  button.  
The crosshair disappears and the map is set to the vehicle position.
- or
- ▶ Set the map to the vehicle position; see the explanation below.

#### Centering the map on the vehicle or destination position

##### Centering the map on the vehicle position

- ▶ **To show the menu:** press the  button.
- ▶ Select **Position** in the navigation menu bar using the    buttons and press the  button to confirm.
- ▶ Select **Vehicle Position Map** and press the  button to confirm or, if the crosshair is shown, press the  back button.  
This hides the crosshair.

##### Centering on the destination

- ▶ **To show the menu:** press the  button.
- ▶ Select **Position** in the navigation menu bar using the    buttons and press the  button to confirm.
- ▶ Select **Destination Position Map** and press the  button to confirm.  
The crosshair is centered on the destination.

## Map display

### Setting the map orientation













P82.87-3890-31

Map orientation

- ① Currently set map orientation

The following display modes are possible:



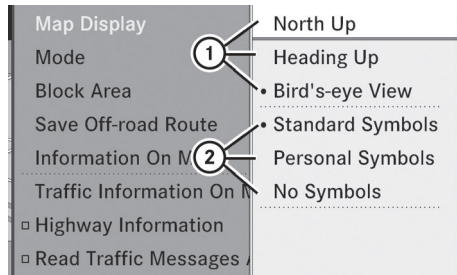

-  North orientation (the map view is displayed so that north is always up)
-  Orientation in the direction of travel (the map is displayed so that the heading is always up; the orange point of the icon points north)
-  Bird's-eye view (the map is displayed so that the heading is always up, the map projection reproduces the curvature of the earth and the orange point of the icon points north)

- ▶ **To show the menu:** press the  button.
- ▶ Select **Navi** in the main function bar using the    buttons and press the  button to confirm.
- ▶ Select **Map Display** and press the  button to confirm.  
The  icon indicates the current setting.



P82.87-3434-31







Map display menu

- ① Map orientation options
- ② To set point of interest icons
- ▶ Select **North Up**, **Heading Up** or **Bird's-eye View** using the   buttons and press the  button to confirm.
  - ▶ **To exit the menu:** press the  or  button.  
The map orientation changes accordingly.

### Point of interest icons on the map



You can set the points of interest you wish to have displayed as icons on the map. Points of interest are, for example, gas stations, hotels, cinemas and restaurants.

The following settings are possible:



- **Standard Symbols**  
Icon display determined by the factory settings
- **Personal Symbols**  
You can determine the icons yourself
- **No Symbols**
- ▶ **To show the menu:** press the  button.
- ▶ Select **Navi** in the main menu bar using the    buttons and press the  button to confirm.
- ▶ Select **Map Display** and press the  button to confirm.

- ▶ Select **Standard Symbols**, **Personal Symbols** or **No Symbols**.

If you select **Personal Symbols**, the list of points of interest appears.

- ▶ **To switch the icon display on/off:** select the point of interest using the   buttons and press the  button to confirm. Depending on the previous setting, the icons will be switched on  or off . You can switch on the icon displays for more than one point of interest.











**i** The list shows all icons that are contained on the digital map across all countries. However, not all points of interest are available in all countries. As a result, certain point of interest icons may not be displayed on the map, even if the icon display is switched on.

- ▶ **To exit the menu:** press the  or  button.

### Map information in the display

#### Displaying map information

During route guidance, you can have map information displayed at the bottom edge of the display.

- ▶ **To show the menu:** press the  button.
- ▶ Select **Navi** in the main menu bar using the    buttons and press the  button to confirm.
- ▶ Select **Information On Map** and press the  button to confirm. The  icon indicates the current setting.
- ▶ Select **Arrival Time / Distance**, **Current Street**, **Geo-coordinates** or **None** and press the  button to confirm.
- ▶ **To exit the menu:** press the  or  button.

#### Arrival time/distance to the destination

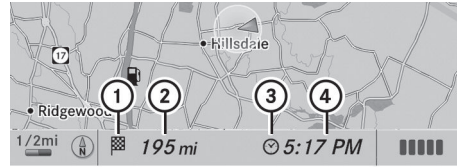

P82.87-3891-31

Arrival time/distance display switched on

- ① Icon for destination
- ② Distance to the destination
- ③ Icon for estimated time of arrival
- ④ Estimated time of arrival

You can only see this display during route guidance. When scrolling the map ( page 82), you will see data, e.g. road names, depending on the crosshair position if the digital map supports this data.

- i** During route calculation, or if the vehicle is traveling on a non-digitized road, the linear distance to the destination is shown. In this case, the display will be grayed out.

#### Road display



P82.87-3916-31

Road display active

- ① Road name or designation

## Geo-coordinate display



P82.87-3918-31

Geo-coordinate display active

- ① Current height above average sea level (rounded to the nearest 100 ft)
- ② Current vehicle position: latitude coordinates
- ③ Current vehicle position: longitude coordinates
- ④ Number of GPS satellites currently being used

There must be sufficient GPS reception for all displays to be shown. If this is not the case, the display will be grayed out. Height display ① may vary from the actual value, because the navigation system uses the GPS signal for the calculation.

## "None" menu option

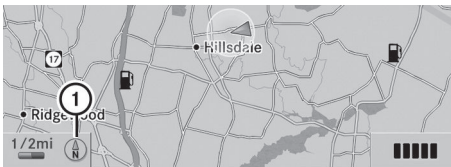

P82.87-3917-31

Display switched off

- ① Currently set map orientation
- ❗ During the "Move map" function, you can see additional data depending on the position of the crosshair, such as a road name, if the digital map supports this data.

## Additional settings

### Avoiding an area

#### General information

COMAND makes it possible to avoid areas you do not wish to drive through.

If you activate or deactivate a route block while route guidance is active, COMAND will calculate a new route. If you activate or deactivate a route block while route guidance is inactive, COMAND will use the new setting for the next route guidance.

- ❗ Freeways within blocked areas are always taken into consideration in the route calculation.

This function is not available while the vehicle is in motion.

- ▶ **To switch to navigation mode:** press the **NAVI** function button.

- ▶ **To show the menu:** press the **OK** button.

- ▶ Select **Navi** in the main function bar using the **▲**, **◀**, **▶** buttons and press the **OK** button to confirm.

- ▶ Select **Block area** and press the **OK** button to confirm.









If you have not yet set an area to be avoided, the map with the crosshair appears (option 1).

If you have already set one or more areas to be avoided, a list appears (option 2).

#### Option 1: the map appears



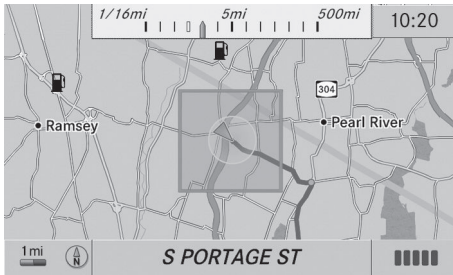

P82.87-5410-31

- ▶ **To scroll the map:** press the     buttons.
- ▶ **To set the map scale:** press the  or  button.  
The scale bar appears.
- ▶ Press the  or  button again.  
The map view is zoomed in or out.
- ▶ **To add an area to be avoided:** press the  button.  
A red square on the map delimits the area to be avoided.



P82.87-3921-31



- ▶ **To set the size of the square:** press the  or  button.  
The square is enlarged or reduced.
- ▶ **To confirm the setting:** press the  button.  
The list appears. The previously selected area to be avoided has been added and activated.
- ▶ If you want to use list functions, proceed according to the instructions described under "Option 2: the list appears".

## Option 2: the list appears

Avoid New Area		
Back	MONVALE	Display / Change
	<input type="checkbox"/> Empty	Delete
	<input type="checkbox"/> Empty	
	<input type="checkbox"/> Empty	
	<input type="checkbox"/> Empty	

P82.86-9983-31

Example display: "Avoid area" list



- ▶ Select **Avoid new area** using the   buttons and press the  button to confirm.  
The map with the crosshair appears.
- ▶ Proceed according to the instructions under "Option 1: the map appears" if you wish to set a new area to be avoided.  
The following illustration shows an example with two areas that are to be avoided.



P82.87-5420-31













- ① Area currently being avoided
- ② New area to be avoided, the size of which can still be adjusted

## Switching an avoided area on/off





- ▶ Select an entry in the list using the   buttons and press the  button to confirm.  
The avoided area is switched on  or off  depending on the previous status.



## Displaying and changing an avoided area



- ▶ Select an entry in the list using the   buttons.
- ▶ Select **Options** using the  button and press the  button to confirm.
- ▶ Select **Display / Change** and press the  button to confirm.  
The area to be avoided is indicated in the map.
- ▶ **To change the position of the area:** press the    or  button.  
The area is moved on the map.
- ▶ **To change the size of the area:** press the  or  button.  
The area is enlarged or reduced.
- ▶ **To confirm the change:** press the  button.  
The list appears and the change is entered.





## Deleting a set area

- ▶ Select an entry in the list using the   buttons.
- ▶ Select **Options** using the  button and press the  button to confirm.
- ▶ Select **Delete** and press  to confirm.  
A query appears asking whether the entry should be deleted.
- ▶ Select **Yes** or **No**.  
If you select **Yes**, the entry is deleted.  
If you select **No**, the process will be aborted.

## "Record route" function

### Switching the function on/off

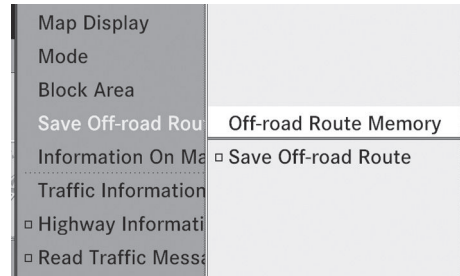

- ▶ **To switch to navigation mode:** press the  function button.
- ▶ **To show the menu:** press the  button.

- ▶ Select **Navi** in the main function bar using the    buttons and press the  button to confirm.
- ▶ Select **Save off-road route** and press the  button to confirm.











P82.87-3437-31

### Off-road route menu

- ▶ Select **Save off-road route** again and press the  button to confirm.  
Depending on the previous status, you switch the option on  or off .
- ▶ **To exit the menu:** press the  or  button.

## Displaying memory usage

When the memory is 90% full, you see a message to this effect. You will also see a message when the memory is completely full.

- ▶ **To confirm the message:** press the  button.
- ▶ **To confirm the message:** press the  button.  
In order to be able to continue using the "Record route" function, you should delete the route memory afterwards.
- ▶ **To switch to navigation mode:** press the  function button.
- ▶ **To show the menu:** press the  button.
- ▶ Select **Navi** in the main function bar using the    buttons and press the  button to confirm.
- ▶ Select **Save off-road route** and press the  button to confirm.

- ▶ Select **Off-road route memory** and press the **OK** button to confirm.

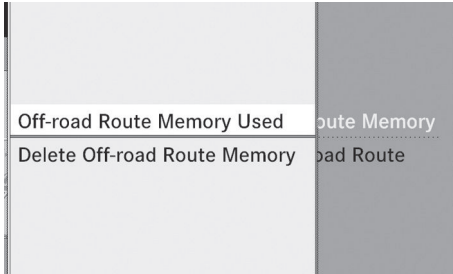

P82.87-3438-31

Off-road route memory menu

- ▶ Select **Off-road route memory used** and press the **OK** button to confirm. A bar shows the memory usage as a percentage.
- ▶ **To close the display:** press the **NAVI** function button.

**i** When the memory is completely full, you cannot select the **Off-road route memory** menu item.

### Deleting the route memory

- ▶ **To switch to navigation mode:** press the **NAVI** function button.
- ▶ **To show the menu:** press the **OK** button.
- ▶ Select **Navi** in the main function bar using the **▲** **◀** **▶** buttons and press the **OK** button to confirm.
- ▶ Select **Save off-road route** and press the **OK** button to confirm.
- ▶ Select **Off-road route memory** and press the **OK** button to confirm.
- ▶ Select **Delete off-road route memory** and press the **OK** button to confirm. A query appears asking whether the memory should be deleted.
- ▶ Select **Yes** or **No**. If you select **Yes**, the memory is deleted. If you select **No**, the process will be aborted.

### Freeway information

When driving on freeways, you can have the nearest gas stations, rest areas, etc., as well as your current distance from them, shown on the right-hand side of the display.

- ▶ **To switch to navigation mode:** press the **NAVI** function button.
- ▶ **To show the menu:** press the **OK** button.
- ▶ Select **Navi** in the main function bar using the **▲** **◀** **▶** buttons and press the **OK** button to confirm.
- ▶ Select **freeway information** and press the **OK** button to confirm. Depending on the previous status, you switch the option on  or off .

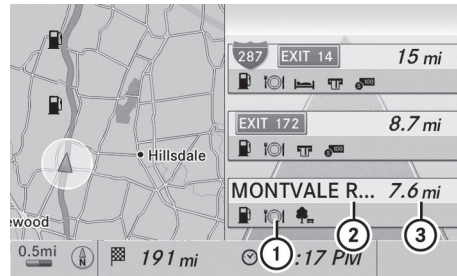

P82.86-9989-31

Example display with function active

- ① Icons for freeway service facilities
- ② Name of freeway service
- ③ Distance from current vehicle position





**i** If the digital map does not supply any data, only a stylized road without freeway information is visible on the right-hand side of the display.

### Compass function

You can see the current vehicle position and direction of travel in the compass view.

- ▶ **To switch to navigation mode:** press the **NAVI** function button.
- ▶ **To show the menu:** press the **OK** button.



- ▶ Select **Position** in the navigation menu bar using the    buttons and press the  button to confirm.
- ▶ Select **Compass** and press the  button to confirm.  
Depending on the previous status, you switch the option on  or off .

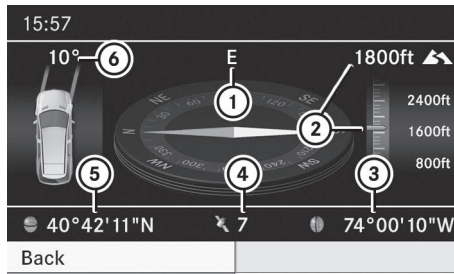

P82.87-2476-31

Example display: compass

- ① Current direction of travel
  - ② Current height above average sea level (rounded to the nearest 50m)
  - ③ Current vehicle position: longitude coordinates
  - ④ Number of GPS satellites currently being used
  - ⑤ Current vehicle position: latitude coordinates
  - ⑥ Currently set steering angle of the front wheels
- i** To display current height (②), the system must be able to receive at least four satellites. Steering angle (⑥) can be a maximum of 35° in both directions.

## Updating the digital map

### Introduction

The digital maps generated by the map software become outdated in the same way as conventional road maps. Optimal route guidance can only be provided by the navigation system in conjunction with the most up-to-date map software.

Information about new versions of the digital map can be obtained from an authorized Mercedes-Benz Center. You can have the digital map updated there with a DVD, or you can update it yourself.

- i** The update process can take a long time (over an hour), depending on the size of the map software. During this time, you will only be able to switch on radio mode and to accept incoming calls. The update will be completed more quickly if the vehicle is stationary.

If you carry out the update with the engine switched off and the starter battery has insufficient power, COMAND may automatically switch off during the process in order to protect the battery. If this occurs, restart the update with the engine running.

### WARNING

Never run the engine in an enclosed space. The exhaust fumes contain poisonous carbon monoxide. Inhaling exhaust fumes is hazardous to your health and can lead to loss of consciousness and death.

### Updating process



- ▶ Insert the DVD (▷ page 127).  
The update begins. COMAND checks whether the digital map on the DVD is compatible with the navigation system and system software.  
If this is the case and the DVD's map data has not already been installed, COMAND starts updating the digital map.  
If the map data has already been installed, the display shows version data and a message to this effect.
- ▶ **To confirm the message:** press the  button.
- ▶ Eject the DVD.

While the update is running, you will see a message to this effect and a progress bar. The

navigation system is not operational until the update is complete.

- ▶ **i** You cannot eject the DVD during the update. If you switch off COMAND during the update, the update is interrupted. It then continues from where it was interrupted when the system is restarted.

COMAND may prompt you to change the DVD during the update.

- ▶ Press the  load/eject button.
- ▶ Take the DVD out of the slot.
- ▶ Insert the requested DVD.  
Once the update has been successfully completed, you will see a message to this effect.
- ▶ **To confirm the message:** press the  button.
- ▶ Take the DVD out of the slot.  
The update is complete.  
If the update is not successfully completed, you will see a message that the map update is not possible.
- ▶ **To confirm the message:** press the  button.
- ▶ Take the DVD out of the slot.

## Problems with the navigation system

Problem	Possible causes/consequences and ► Solutions
COMAND is unable to continue route guidance after the journey has been interrupted.	<p>Route guidance is canceled if you interrupt the journey for more than two hours.</p> <p>"Interrupting the journey" refers to stopping the vehicle and switching off COMAND. "Continuing route guidance" refers to switching COMAND back on and driving on.</p> <p>► Continue route guidance (► page 68). COMAND determines the vehicle's position. Depending on the driving situation, this may take some time.</p> <p>Route guidance may be restricted during the determination of the vehicle's position.</p> <p>When positioning is complete, route guidance is resumed with navigation announcements and route guidance displays.</p>

Problem	Possible causes/consequences and ► Solutions
COMAND is unable to determine the vehicle's position.	<p>COMAND has to redetermine the position of the vehicle if the vehicle has been transported (e.g. by ferry, by motorail or after towing).</p> <p>► Start the vehicle and pull away. COMAND determines the vehicle's position. Depending on the driving situation, this may take some time.</p> <p>Route guidance may be restricted during the determination of the vehicle's position.</p> <p>When positioning is complete, route guidance is resumed with navigation announcements and route guidance displays.</p>

Problem	Possible causes/consequences and ► Solutions
The <b>Navigation unavailable</b> message appears.	<p>COMAND has an integrated hard drive on which the digital map is stored.</p> <p>To protect the hard drive from damage, COMAND switches it off at very high temperatures. The navigation system will then be temporarily unavailable.</p> <ul style="list-style-type: none"> <li>► Let the vehicle and COMAND cool down.</li> <li>► <b>To hide the message:</b> switch COMAND off and then on again.</li> </ul> <p>If an area of the hard disk has a malfunction, COMAND can no longer access the map data in this area, for example when calculating a route.</p> <ul style="list-style-type: none"> <li>► <b>To hide the message:</b> switch COMAND off and then on again. The navigation system will be operational again until it has to access the faulty area of the hard drive once more. The message will then reappear.</li> <li>► Consult an authorized Mercedes-Benz Center.</li> </ul>

Problem	Possible causes/consequences and ► Solutions
You see a message informing you that the DVD containing the digital map is incompatible with the system software.	<p>The DVD containing the digital map cannot be used for the update.</p> <ul style="list-style-type: none"> <li>► <b>To confirm the message:</b> press the <b>OK</b> button.</li> <li>► Eject the DVD.</li> <li>► Have the system software updated at an authorized Mercedes-Benz Center.</li> </ul>

Problem	Possible causes/consequences and ► Solutions
The map software update has failed.	<p>The DVD is dirty or scratched.</p> <ul style="list-style-type: none"> <li>► Clean the DVD.</li> <li>► Restart the update.</li> </ul> <p>There is overheating due to excessive temperatures in the vehicle interior.</p> <ul style="list-style-type: none"> <li>► Wait until the vehicle interior has cooled down.</li> <li>► Restart the update.</li> </ul> <p>COMAND's integral hard drive is faulty.</p> <ul style="list-style-type: none"> <li>► Consult an authorized Mercedes-Benz Center.</li> </ul>

COMAND features .....	94
General information .....	94
Telephony via the Bluetooth® inter- face .....	95
Reception and transmission volume .	99
Telephone operation .....	100
Using the phone book .....	102
Using call lists .....	106
Using the address book .....	108
Operating the telephone using the multifunction steering wheel .....	113

## COMAND features

These Operating Instructions describe all standard and optional equipment available for your COMAND system at the time of purchase. Country-specific deviations are possible. Please note that your COMAND system may not be equipped with all the features described.

## General information

### Introduction

In the telephone function, telephony via Bluetooth® interface is available if a Bluetooth®-capable mobile phone is connected.

Using the Bluetooth® interface and a suitable mobile phone, you can use COMAND's hands-free feature to download electronic business cards (vCards).

More detailed information on suitable mobile phones and on connecting Bluetooth®-capable mobile phones to COMAND can be found on the Internet at <http://www.mbusa-mobile.com>. Or call the Mercedes-Benz Customer Assistance Center under 1-800-FOR-MERCEDES(1-800-367-6372) (USA), or Customer Relations under 1-800-387-0100 (Canada).

### Important safety notes

#### WARNING

A driver's attention to the road must always be his/her primary focus when driving. For your safety and the safety of others, we recommend that you pull over to a safe location and stop before placing or taking a telephone call. If you choose to use the mobile phone while driving, please use the handsfree device and only use the mobile phone when weather, road, and traffic conditions permit.

Some jurisdictions prohibit the driver from using a cellular mobile phone while driving a vehicle.

Bear in mind that at a speed of just 30 mph (approximately 50 km/h), your vehicle is covering a distance of 44 feet (approximately 14 m) every second.

#### WARNING

You and others may damage your health due to excessive electromagnetic radiation. By using an external antenna, the possible health risks of electromagnetic fields, which are under discussion among the scientific community, should be largely prevented.







### Call disconnection while the vehicle is in motion

A call may be disconnected if:

- there is insufficient network coverage in certain areas.
- you move from one transmitter/receiver area (cell) into another and no channels are free.
- you use a SIM card which is not compatible with the network available.
- you are using a mobile phone with "Twincard" and the mobile phone with the second SIM card is already logged into the network.

### Operating options

You can operate the telephone by:

- the  and  button or the  button on COMAND
- the  or  button and the number keypad on COMAND
- pressing the  or  button on the multifunction steering wheel
- by speaking using the Voice Control System

Unless stated otherwise, the descriptions and illustrations in this section refer to COMAND.

### Function restrictions

The telephone is not ready for use in the following situations:

- if the mobile phone is not logged into a mobile phone network the telephone automatically tries to log on to a network. If no network is available, you will not be able to make a "911" emergency call. If you attempt to make an outgoing call, the **No Service** message will appear for a short while.

### 911 emergency call

#### WARNING

The 911 emergency call system is a public service. Using it without due cause is a criminal offense.

The following conditions must be fulfilled in order to make a **911** emergency call:

- the mobile phone must be switched on.
- a network must be available.
- a valid and operational SIM card must be inserted in the mobile phone.
- the mobile phone must be connected to COMAND via the Bluetooth® interface.

If you cannot make an emergency call, you must arrange rescue measures yourself.

- ▶ Enter numbers on COMAND.
- ▶ Press the  button.  
The telephone makes the connection.
- ▶ Wait until the emergency call center answers and describe the emergency situation.

## Telephony via the Bluetooth® interface

### Conditions

#### Mobile phone

For telephony via COMAND's Bluetooth® interface, a Bluetooth®-capable mobile phone is required.

- i** Not all mobile phones available on the market are equally suitable. For more information on suitable mobile phones and on connecting Bluetooth®-capable mobile phones to COMAND, visit <http://www.mbusa-mobile.com> or call the Mercedes-Benz Customer Assistance Center under 1-800-FOR-MERCEdes(1-800-367-6372) (US) or Customer Relations under 1-800-387-0100 (Canada).

The battery of the mobile phone should be kept sufficiently charged in order to prevent malfunctions.

In preparation for telephoning via the Bluetooth® interface, you should check the following items on your mobile phone (see the mobile phone operating instructions):

- ▶ Hands-Free Profile  
The mobile phone must support Hands-Free Profile 1.0 or above.
- i** Some displays (e.g. the signal strength) depend on the supported version of the Hands-Free Profile.
- ▶ Bluetooth® visibility  
On certain mobile phones, the device itself must be made "visible" for other devices, as well as activating the Bluetooth® function (see the mobile phone operating instructions).
- ▶ Bluetooth® device name  
Every Bluetooth® device has its own Bluetooth® device name. This device name is freely definable, but can be identical for all devices from the same manufacturer. It



is therefore recommended that you change this name so that you can easily recognize your mobile phone (see the mobile phone operating instructions).

- ▶ Switch on the mobile phone (see the mobile phone operating instructions).
- ▶ Activate Bluetooth® functions and, where necessary, Bluetooth® visibility on the mobile phone (see the mobile phone operating instructions).

### COMAND

- ▶ Activate the Bluetooth® function in COMAND (▷ page 40).

### Connecting a mobile phone

#### General information

Before using your mobile phone with COMAND for the first time, you will need to connect it.

When you authorize a new mobile phone, it is connected automatically.

Connecting comprises:

- searching for a Bluetooth®-capable mobile phone
- authorizing the Bluetooth®-capable mobile phone

You can connect up to ten mobile phones.

#### Searching for a mobile phone

- ▶ Press the **TEL** function button on COMAND.
- ▶ Select **Phone** in the telephone basic menu using the **▼** **◀** **▶** buttons and press the **OK** button to confirm.
- ▶ Select **Bluetooth Phones** and press the **OK** button to confirm.

- ▶ Select **Update** and press the **OK** button to confirm.

COMAND searches for Bluetooth® telephones within range and adds them to the Bluetooth® telephone list.

The duration of the search depends on the number of Bluetooth® telephones within range and their characteristics.

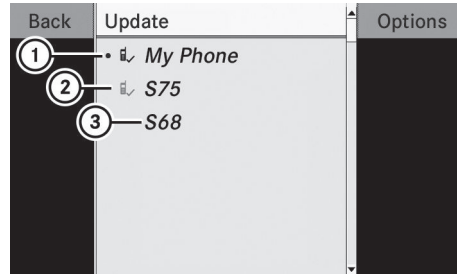

P82.86-9972-31

Example of display: Bluetooth® telephone list

- ① Currently connected • and authorized mobile phone **✓**
- ② Device not within range but previously authorized (**✓** appears in gray)
- ③ Newly detected mobile phone within range but not yet authorized (no icon yet)

The Bluetooth® telephone list shows all mobile phones within range and all previously authorized mobile phones, whether or not they are in range.

**i** If the Bluetooth® telephone list is already full, you will be requested to de-authorize a mobile phone (▷ page 98). If COMAND does not find your mobile phone, external authorization (▷ page 97) may be necessary.

**i** When called up again, the telephone list may no longer show all mobile phones because, for example, a mobile phone has been removed from the vehicle in the meantime. In this case, start a new search to update the Bluetooth® telephone list.

### Authorizing (registering) a mobile phone

- ▶ Select as yet unauthorized mobile phone ③ in the Bluetooth® telephone list using the ▲ ▼ buttons.
- ▶ Select **Options** using the ► button and press the OK button to confirm.
- ▶ Select **Authorize** and press the OK button to confirm.  
The passcode entry menu appears.

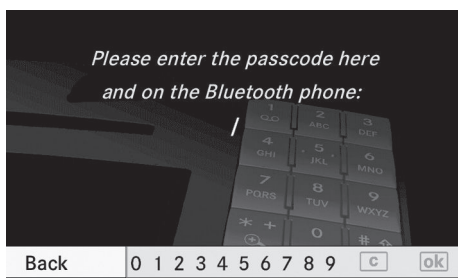

P82.B7-2463-31

The passcode is any one to sixteen-digit number combination which you can determine yourself. You must enter the same number combination in COMAND and in the Bluetooth®-capable mobile phone (see the operating instructions of the Bluetooth®-capable mobile phone).

- ❗ Some mobile phones require the input of a four-digit passcode or longer character strings.

If you want to re-authorize a mobile phone following de-authorization, you can select a different passcode.

- ▶ **To enter a passcode in COMAND:** press the number keys in turn.  
OK is highlighted after the first number has been entered.

or

- ▶ Select the digits using the ◀ ▶ buttons and press the OK button to confirm. Then, select OK .

- ▶ **To confirm an entry in COMAND:** press the OK button.
- ▶ Now enter the same passcode in the mobile phone.

**To enter in the mobile phone:** if the Bluetooth® connection is successful, you will be prompted by the mobile phone to enter the passcode (see the mobile phone operating instructions).

- ▶ Enter the same passcode in the mobile phone as already entered in COMAND.

- ❗ After entering the passcode, you may also need to enter a confirmation in your mobile phone to connect calls. Check the display of your mobile phone.

If the COMAND display shows the **Authorization Procedure Unsuccessful** message, you may have exceeded the prescribed time period. Repeat the procedure.

The mobile phone is connected to COMAND (authorized). You can now make phone calls using the COMAND hands-free system.

### External authorization

If COMAND does not detect your mobile phone, this may be due to particular security settings on your mobile phone. In this case, check whether your mobile phone can find COMAND. The Bluetooth® device name of COMAND is **MB Bluetooth**.

Observe the following: some mobile phones require that you reconnect to COMAND after you have entered the passcode (see the mobile phone operating instructions). The mobile phone can otherwise not be authorized.

- ▶ Press the TEL function button.
- ▶ Select **Phone** in the telephone basic menu using the ◀ ▶ ▲ ▼ buttons and press the OK button to confirm.

- ▶ Select **Bluetooth Phones** and press the **OK** button to confirm.
- ▶ Select **Update** and press the **OK** button to confirm.
- ▶ Select **Options** using the **▶** button and press the **OK** button to confirm.
- ▶ Select **External Authorization** and press the **OK** button to confirm.
- ▶ Start the Bluetooth® search on the mobile phone (see the mobile phone operating instructions).
- ▶ Select COMAND (**MB Bluetooth**) on the mobile phone.
- ▶ Enter the passcode on the mobile phone when requested to and then input it in COMAND.

#### Automatic reconnection

COMAND always searches for the last connected mobile phone.

If no connection can be made to the most recently connected mobile phone, the system searches for the mobile phone which was connected before that one.

#### Connecting another mobile phone

If you have authorized several mobile phones, you can switch between the individual phones.

- i** You can only switch to another authorized mobile phone if no phone call is active.
- ▶ Select the mobile phone in the Bluetooth® telephone list using the **▲** **▼** buttons and press the **OK** button to confirm.  
The selected mobile phone is searched for and connected if it is within Bluetooth® range and if Bluetooth® is activated.  
Only one mobile phone can be connected at any one time. The currently connected

mobile phone is indicated by the **•** dot in the Bluetooth® telephone list (▶ page 96).

#### To display details

- ▶ Press the **TEL** function button on COMAND.
- ▶ Select the desired mobile phone in the Bluetooth® telephone list using the **▲** **▼** buttons.
- ▶ Select **Options** using the **▶** button and press the **OK** button to confirm.
- ▶ Select **Details** and press the **OK** button to confirm.  
The following information concerning the selected mobile phone is shown:
  - Bluetooth® name
  - Bluetooth® address
  - availability
  - authorization status
- ▶ **To close the detailed display:** press the **◀** or **▶** button.

#### Deregistering (de-authorizing) a mobile phone

Mercedes-Benz recommends de-authorization in COMAND and on the mobile phone. Subsequent authorization may otherwise fail.

- ▶ Select the desired mobile phone in the Bluetooth® telephone list using the **▲** **▼** buttons.

- ▶ Select **Options** using the  button and press the **OK** button to confirm.
- ▶ Select **De-Authorize** and press the **OK** button to confirm.  
A prompt appears asking whether you really wish to revoke authorization for this mobile phone.
- ▶ Select **Yes** or **No**.  
If you select **Yes**, the mobile phone will be deleted from the Bluetooth® telephone list.  
If you select **No**, the process will be canceled.

**i** Before re-authorizing the mobile phone, you should also delete the device name **MB Bluetooth** from your mobile phone's Bluetooth® list.



#### Telephone basic menu (Bluetooth® interface)

- ▶ Press the **TEL** function button.

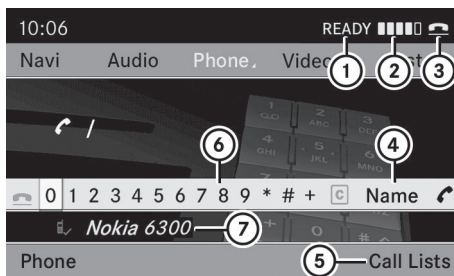
If the mobile phone is ready for use, the following display appears:





P82.87-2491-31

- ① Phone service status
- ② Network reception  (if supported by the telephone)
- ③ Receiver icon:  or 
- ④ To display the COMAND phone book
- ⑤ To display call lists
- ⑥ Character bar
- ⑦ Bluetooth® name of the currently connected mobile phone

**i** Displays ① and ② are shown depending on the mobile phone connected.

Bars ② display the current signal strength of the mobile phone network. If all the bars are filled, you have optimum reception. If all the bars are empty, there is very poor reception of none at all.





Receiver icon ③ shows whether a call is active/being connected  or not .

#### Reception and transmission volume

Once the mobile phone has been authorized, you can optimize the transmission and reception volume settings. To find out about the best possible settings for your mobile phone, contact an authorized Mercedes-Benz Center or visit <http://www.mercedes-benz.com/connect>.

These settings can also be changed while making a call.

**i** Incorrect settings may have a significant impact on the quality of calls.

- ▶ Press the **TEL** function button.
- ▶ Select **Phone** in the telephone basic menu using the , , ,  buttons and press the **OK** button to confirm.
- ▶ Select **Adjust Volume** and press the **OK** button to confirm.

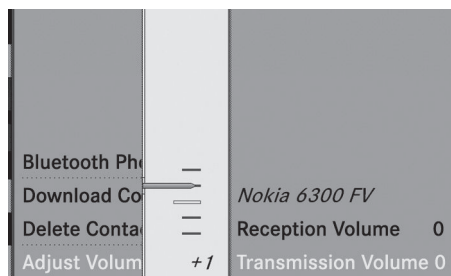

P82.87-2132-31

Scale with indicator showing current volume

- ▶ Select **Reception Volume** or **Transmission Volume** and press the **OK** button to confirm.
- ▶ Select a volume setting using the **▲** **▼** buttons.
- ▶ **To close the scale:** press the **OK** or **◀** button.

## Telephone operation

### Incoming call

#### Rejecting or accepting a call

When there is an incoming call, you see a corresponding window in the display.

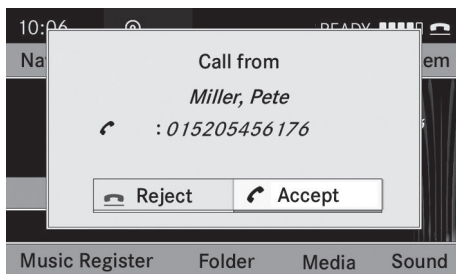

P82.87-2139-31

- ▶ **To reject:** select **Reject** using the **◀** button and press the **OK** button to confirm.
- or
- ▶ Press the **☎** button on COMAND.
- ▶ **To accept:** confirm **Accept** by pressing the **OK** button.
- or
- ▶ Press the **☎** button on COMAND.

- i** You can also accept the call by voice command using the Voice Control System (▷ page 181).

Once you have accepted the call, you can use hands-free mode. The call volume can be adjusted (▷ page 27). For more information, see the "Functions during a single call connection" section (▷ page 101).

The display shows the phone number or the name and phone number (if the entry is stored in the address book) or shows the **Call from Unknown** (phone number withheld) message.

- i** You can also accept a call using the **☎** button when COMAND is showing the display of a different main function. Once you have accepted the call, the display switches to telephone mode. After the call is finished, you see the display of the previous main application again.

### Making a call

#### Entering a telephone number using the number keypad



- ▶ Call up the telephone basic menu (▷ page 99)
- ▶ Enter the digits using the number keypad.
- ▶ **To make a call:** press the **☎** button on COMAND.

#### Entering a telephone number using the telephone basic menu



- ▶ Call up the telephone basic menu (▷ page 99).
- ▶ Enter the required digits. Proceed as described in the "Entering characters in the address and phone books" section (▷ page 23).
- ▶ **To make a call:** select **☎** in the character bar and press the **OK** button to confirm.

#### Redialing





- ▶ Call up the telephone basic menu (▷ page 99).

- ▶ Select  in the character bar and press the  button to confirm.



or

- ▶ While the  icon is highlighted, press the  button on COMAND.



In both cases, the calls dialed list appears. The most recently dialed number is at the top.



- ▶ **To select a call:** press the  or  button.
- ▶ **To make a call:** press the  or  button.

### Connecting a call to an entry in a call list or in the COMAND phone book

- ▶ Call up a call list and select an entry using the   buttons.

or

- ▶ Call up the COMAND phone book and select an entry using the   buttons.

- ▶ **To make a call:** press the  or  button.

### Functions available during a call

#### Overview



P82.87-2497-31





Telephone operation with a single call

- ① Person you are calling
- ② Icon for active telephone connection
- ③ To switch hands-free microphone on/off



- ④ To send DTMF tones (not possible with all mobile phones)
- ⑤ Device name of the mobile phone connected
- ⑥ To end a call

### Switching the hands-free microphone on/off

This function is also available during an active phone call.

- ▶ Call up the telephone basic menu (▷ page 99)
- ▶ **To switch off:** select **Mike off** and press the  button to confirm. If the microphone is switched off, the display shows the  icon and the **The microphone is off** message appears for a short period.
- ▶ **To switch on:** select **Mike on** and press the  button to confirm. The  symbol disappears. You will briefly see the **The microphone is on** message.

### Ending an active call

- ▶ Select  and press the  button to confirm.

or

- ▶ Press the  button on COMAND or on the multifunction steering wheel.

### Call waiting

- ❗ The "call waiting" function must be supported by the network provider and be enabled.

If you are busy with a single call and receive another call, the telephone number of the call waiting will be entered in the list of incoming calls. A warning tone sounds.

### Sending DTMF tones

This function is not supported by all mobile phones.

Answering machines or other devices can be controlled by DTMF tones, e.g. for remote query functions.

- ▶ If you would like to listen to the messages on your answering machine, for example, select the corresponding number.

- ▶ **To transmit individual characters:** once a connection has been established to the answer phone, select desired characters ④ and press the (OK) button to confirm.

or

- ▶ Press the corresponding key on the COMAND number keypad.

Every character selected will be transmitted immediately.

- ▶ **To send a phone book entry as a sequence of characters:** select **Name** using the (▲) (▼) (◀) (▶) buttons and press the (OK) button to confirm.

- ▶ Select the desired phone book entry and press the (OK) button to confirm. The entry is immediately sent as a character string.

- ▶ **To return to the call display:** select **Back** again and press the (OK) button to confirm.

- ① You can also send DTMF tones using the Voice Control System (▷ page 181).

## Using the phone book

### Introduction

The phone book displays the names and phone numbers of all of the address book entries saved in the COMAND address book. If an address book entry does not have a telephone number, it does not appear in the phone book.

You can import contacts or download vCards.

- ① In addition, you can also import contacts from an SD memory card if the SD memory card contains vCards.

The functions:

- importing contacts
- receiving vCards
- deleting contacts

are described in detail in the "Address book" section (▷ page 110).

- ① The stored phone book and the vCards remain in COMAND, even if you use COMAND with another mobile phone. The entries can be viewed without a mobile phone. For this reason, delete the phone book before selling or transferring ownership of your vehicle.

## Calling up the phone book

### Overview

- ▶ Select **Name** in the telephone basic menu using the (▲) (▼) (◀) (▶) buttons and press the (OK) button to confirm.

If the phone book contains entries, they will be displayed in alphabetical order. Character bar ③ is active.

The character bar serves to reduce the number of entries needed.

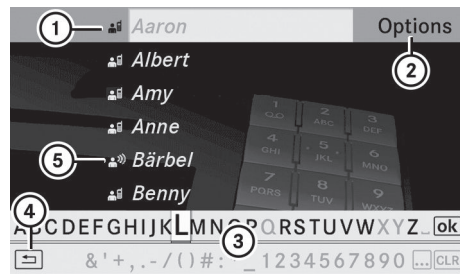





P82.87-3899-31

- ① (List icon) symbol for a phone book entry received from the mobile phone
- ② To call up options
- ③ Character bar
- ④ To close the phone book
- ⑤ (List icon) symbol for a voice tag (▷ page 191)









## Symbol overview

Icon	Explanation
	Address book entry that has been entered or changed via COMAND
	Address book entry with voice tag <b>i</b> These entries have also been assigned a voice tag. Voice tags are available in vehicles with a Voice Control System (> page 191).
	Contact imported from a mobile phone
 with a paper clip symbol	Entry which has been imported from the SD memory card
 with BT	Entry imported via the Bluetooth® interface

### Searching for a phone book entry

#### Using the character bar















You determine the first letter of the entry you are looking for with the first character you enter.

- ▶ Select a character using the     buttons and press the  button to confirm.  
The first entry in the list that starts with the letter selected is highlighted. If there are similar entries, the next different character is shown. For example, the entries **Christel** and **Christine** begin with the same character strings. In this particular case, you would be able to choose from the letters **E** and **I**.
- ▶ Select the characters of the entry you are searching for one by one and press the  button to confirm.  
When the selection is clear, COMAND switches automatically to the selection list.
- ▶ **To complete the search:** switch from the phone book with character bar to the selection list (> page 104).  
The last list entry is automatically highlighted.



### Using the number keypad

Alternatively, you can also enter digits using the number keypad (direct entry) (> page 23).

#### Deleting characters

- ▶ Select  using the     buttons and briefly press the  button.
- or
- ▶ Briefly press the  button  
Each time you enter or delete a character, the closest match will be displayed at the top of the list.
- ▶ **To delete an entry:** select  using the     buttons and press and hold the  button until the entry has been deleted.
- or
- ▶ Press and hold the  button until the entire entry is deleted.

#### Changing the language of the character bar

- ▶ Select  and press the  button.
- ▶ Select the desired language.

### Changing the character set of the character bar

- ▶ Select **[...]** and press the **[OK]** button to confirm.  
The character set changes each time you make this selection.

### Selecting an entry directly from the list

When the selection is clear, COMAND switches automatically to the list. You can switch to the list at any time during character entry.

- ▶ Press the **[▲]** button repeatedly or press and hold the **[OK]** button until the character bar disappears.

or

- ▶ Select **[ok]** and press the **[OK]** button to confirm.
- ▶ **To select an entry:** press the **[▲]** or **[▼]** repeatedly until the desired entry is highlighted and press the **[OK]** button to confirm.

**To select a phone number:** the **[▶]** icon indicates that an entry contains more than one phone number.

- ▶ Select a phone book entry with the **[▶]** icon and press the **[OK]** button to confirm. The sub-entries appear. The **[▶]** icon changes to **[▼]**.
- ▶ Select a sub-entry using the **[▼]** **[▲]** buttons and press the **[OK]** button to confirm.
- ▶ **To return to the phone book with character bar:** select **Back** in the list and press the **[OK]** button to confirm.

or

- ▶ Press the **[BACK]** back button.

### Displaying details for an entry

- ▶ Select an entry in the list using the **[▲]** **[▼]** buttons.
- ▶ Select **Options** using the **[▶]** button and press the **[OK]** button to confirm.
- ▶ Select **Details** and press **[OK]** to confirm. The detailed display appears.
- ▶ **To close the detailed view:** press the **[◀]** or **[▶]** button or the **[BACK]** back button.

### Deleting an entry from the phone book

If the entry contains only phone numbers, it is deleted from the phone book and address book.

If there is additional data included along with the phone number, e.g. a navigable destination, the entry is deleted from the phone book but retained in the address book.

- ▶ Select an entry in the list using the **[▲]** **[▼]** buttons.
- ▶ Select **Options** using the **[▶]** button and press the **[OK]** button to confirm.
- ▶ Select **Delete** and press **[OK]** to confirm. A prompt appears asking whether the entry should be deleted.
- ▶ Select **Yes** or **No**.  
If you select **Yes**, the entry is deleted in accordance with the rules described above. If you select **No**, the process will be aborted.

### Creating a new entry in the phone book

- ▶ Press the **[▲]** button in the phone book repeatedly until the selection list appears.



P82.87-5412-31

- ▶ Select **Options** in the selection list using the button and press the **OK** button to confirm.
- ▶ Select **New entry** and press **OK** to confirm.
- ▶ Select a category for the number, e.g. **Home**, and press the **OK** to confirm.
- ▶ Select a category for the phone, e.g. **Mobile**, and press the **OK** to confirm.

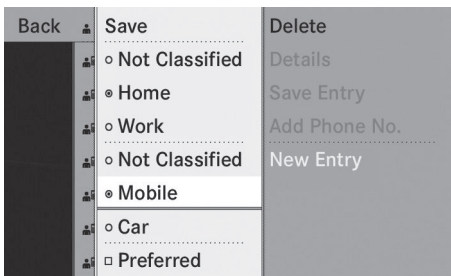

P82.87-5413-31

- ▶ Select **Save** and press **OK** to confirm. The input menu with data fields appears.

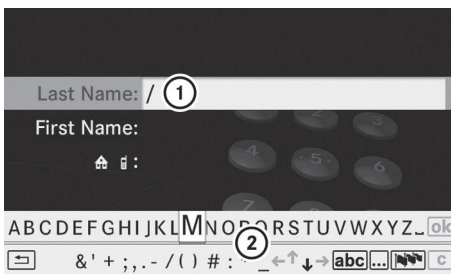

P82.87-5414-31

- ① Selected data field with cursor
- ② Character bar

- ▶ Enter characters and save the entry. Proceed as described under "Entering characters" in the "Entering characters in the address and phone books" section (> page 22).

**i** The entry is created in the phone book and in the address book.

### Adding telephone numbers to an existing phone book entry

- ▶ Select an entry in the list using the buttons.
- ▶ Select **Options** using the button and press the **OK** button to confirm.
- ▶ Select **Add Phone No.** and press **OK** to confirm.
- ▶ Select a category for the number, e.g. **Home**, and press the **OK** to confirm.
- ▶ Select a category for the phone, e.g. **Mobile**, and press the **OK** to confirm.
- ▶ Select **Save** and press **OK** to confirm. COMAND stores the data if there are fewer than five numbers assigned to the entry you are searching for in the selected number category.

If five numbers are stored for the entry in the selected number category, a prompt will appear asking whether you wish to overwrite one of the existing numbers.

- ▶ Select **Yes** or **No** and press the **OK** button to confirm. If you select **Yes**, a selection list will appear containing the five existing numbers. If you select **No**, the process will be aborted.
- ▶ Select the number to be overwritten using the buttons and press the **OK** button to confirm. An input menu appears. The data field for entering the new phone number is highlighted.

- ▶ Enter characters and save the entry. Proceed as described under "Entering characters" in the "Entering characters in the address and phone books" section (> page 22).

## Using call lists

### Introduction

#### Telephone

For telephony via the Bluetooth® interface, COMAND shows a list of calls received (including missed calls) or a list of calls dialed.

- ❗ The respective menu item can only be selected if calls have already been received or dialed on COMAND.

Displaying missed calls in the COMAND display is not supported by all mobile phones.

These lists remain in COMAND, even after another mobile phone has been connected.

### Opening the call list and selecting an entry

- ▶ Press the **TEL** function button.
- ▶ Select **Call Lists** in the telephone basic menu using the **▼** **◀** **▶** buttons and press the **OK** button to confirm. A menu appears.
- ▶ Select **Calls Received** or **Calls Dialed** using the **▲** **▼** buttons and press the **OK** button to confirm. The corresponding list appears.

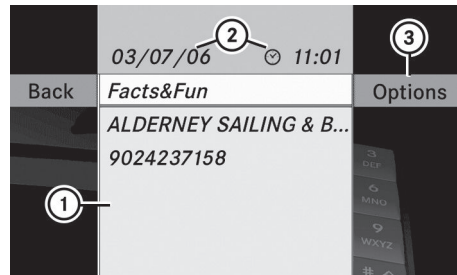

P82.87-2495-31

Example display: list of calls received

- ① List of incoming calls
  - ② Date/time and phone number of the selected entry
  - ③ To call up options
- ❗ You can also call up the list of dialed calls by pressing the **☎** button when the telephone basic menu is shown. Doing so displays only names or phone numbers without a date or time.

- ▶ Select an entry using the **▲** **▼** buttons.
- ▶ **To dial a phone number:** press the **☎** button.
- ▶ **To close the list:** press the **BACK** button.

### Displaying details about a list entry

COMAND can also show a shortened list entry in full.

- ▶ Select a list entry using the **▲** **▼** buttons.
- ▶ Select **Options** using the **▶** button and press the **OK** button to confirm.
- ▶ Select **Details** and press **OK** to confirm. The detailed display appears.
- ▶ **To return to the list:** press the **◀** or **▶** repeatedly until the list is highlighted.



## Storing a list entry which has not yet been stored



### Introduction



For incoming calls from a person who is not in the address book, COMAND displays the phone number in the call list. You can save this entry.

### Storing as a new entry in the address book

- ▶ Call up a call list and select an entry (▷ page 106).
- ▶ Select **Options** using the  button and press the **OK** button to confirm.
- ▶ Select **Save Entry** and press the **OK** button to confirm.
- ▶ **Save Entry** is shown in gray if the selected list entry has already been saved in the address book.
- ▶ Select **New Entry** and press **OK** to confirm.
- ▶ Select a category for the number, e.g. **Home**, and press the **OK** to confirm.
- ▶ Select a category for the phone, e.g. **Mobile Phone**, and press the **OK** to confirm.

Number category	Display (phone book and address book)
Not Classified	
Home	
Work	

Phone category	Display (phone book and address book)
Not Classified	
Mobile Phone	

Phone category	Display (phone book and address book)
Car	
Pager	

- ▶ Select **Save** and press **OK** to confirm. An input menu with data fields is shown. The data field for the telephone number is filled in automatically.

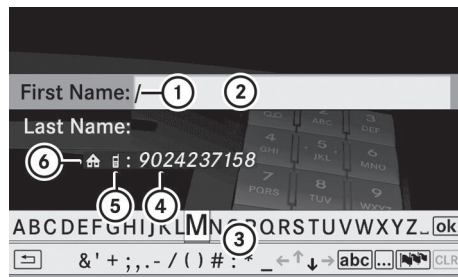

P82.87-2496-31

- ① Entry mark (cursor)
- ② Data field
- ③ Character bar
- ④ The data field for the telephone number is filled in automatically.
- ⑤ Phone category
- ⑥ Number category

- ▶ Proceed as described under "Entering characters" in the "Entering characters in the address and phone books" section (▷ page 22).

### Adding a phone number to an address book entry

- ▶ Call up a call list and select an entry (▷ page 106).
- ▶ Select **Options** using the  button and press the **OK** button to confirm.
- ▶ Select **Save entry** and press the **OK** button to confirm.

**i** **Save entry** is shown in gray if the selected list entry has already been saved.

- ▶ Select **Add** and press the **OK** button to confirm.
- ▶ Select a category for the number, e.g. **Home**, and press the **OK** to confirm.
- ▶ Select a category for the phone, e.g. **Mobile**, and press the **OK** to confirm.
- ▶ Select **Save**.  
The search menu for address book entries appears.
- ▶ Search for the desired entry (▷ page 103).
- ▶ Press the **OK** button when you have finished searching.

COMAND stores the data if there are fewer than five numbers assigned to the entry you are searching for in the selected number category.

You will see a message to this effect.

If five numbers are stored for the entry you are searching for, a prompt will appear asking whether you wish to overwrite one of the existing numbers.

- ▶ Select **Yes** or **No** and press the **OK** button to confirm.  
If you select **Yes**, a selection list with the five existing numbers is displayed.  
If you select **No**, the process will be aborted.
- ▶ Select the number to be overwritten from the list using the **▲** **▼** buttons and press the **OK** button to confirm.  
COMAND overwrites the selected number with the new data.

### Deleting call lists

**i** The stored call lists remain in COMAND, even if you use COMAND with another mobile phone. For this reason, you should delete any call lists before handing over or selling the vehicle.

- ▶ Select **Call lists** in the telephone basic menu using the **▼** **◀** **▶** buttons and press the **OK** button to confirm.
- ▶ Select **Delete call lists** and press the **OK** button to confirm.  
A prompt appears asking whether you wish to delete all call lists.
- ▶ Select **Yes** or **No** and press the **OK** button to confirm.  
If you select **Yes**, the call lists are deleted.  
If you select **No**, the process will be aborted.

## Using the address book

### Introduction

#### **⚠** WARNING

Please devote your attention first and foremost to the traffic situation you are in.

Before your journey, please familiarize yourself with the address book functions.

Only use the COMAND when road and traffic conditions permit you to do so. Otherwise you could be involved in an accident in which you or others could be injured.

The address book organizes and stores entries which are entered from different sources (mobile phone, SD memory card, COMAND telephone book, navigation system).

You can use these entries to make telephone calls and for navigation.

**i** Each address book entry consists of a surname, first name and company, and can contain up to five telephone numbers, one home address and one business address. The address book can store around 900 entries.

**i** Address book entries remain stored when the mobile phone is disconnected. Therefore, you should delete your personal data using the reset function before selling your vehicle, for example (▷ page 43).

### Calling up the address book

- ▶ Press the **TEL** function button.  
You see the telephone basic menu or the address book if it was open previously.
- ▶ If the telephone basic menu is shown, press the **▲** **◀** **▶** buttons to select **Phone** and press the **OK** button to confirm.
- ▶ Select **Address Book** from the menu and press the **OK** button to confirm.

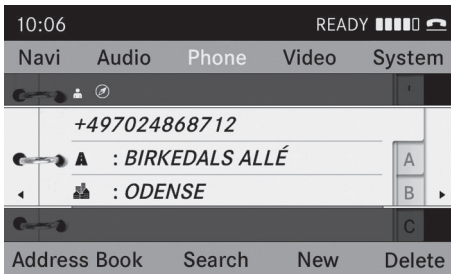

P82.87-2141-31

Address book with address book entry and navigable data

- ▶ **To browse the address book:** press the **◀** or **▶** button.
- ▶ **To close the address book:** press the **TEL** button.

### Searching for an address book entry

- ▶ Call up the address book (▷ page 109).
- ▶ Select **Search** in the address book using the **▼** **◀** **▶** buttons and press the **OK** button to confirm.

If there are more than eight entries, the search menu and the character bar appear.

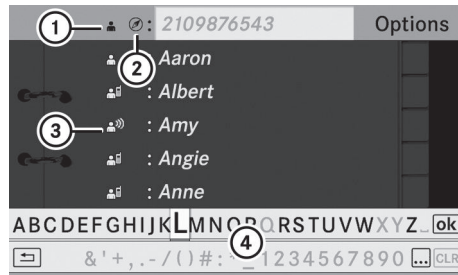

P82.87-2143-31

Search menu with character bar

- ① Symbol for address book entry
- ② Symbol for complete address data from the navigation
- ③ Symbol for voice tag
- ④ Character bar

Further symbols, such as for voice recognition, are described in the "Symbol overview" section (▷ page 103).

- ▶ Proceed as described under "Searching for a phone book entry" (▷ page 103).

### Creating a new entry in the address book

You can enter address data directly into the address book. If you store telephone numbers in the COMAND phone book, these are also saved in the address book. If you store a navigation destination, COMAND creates an address book entry which includes the complete navigable address data.

- ▶ Call up the address book (▷ page 109).
- ▶ Select **New** in the address book using the **▼** **◀** **▶** buttons and press the **OK** button to confirm.  
An input menu with data fields appears.



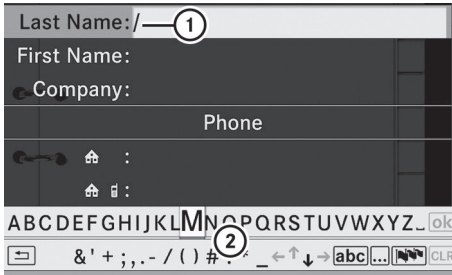

P82.87-2142-31

## Telephone

Input menu with data fields

- ① Selected data field with cursor
- ② Character bar

**i** If COMAND is not equipped with a hard disk, you can only edit data fields with telephone numbers.

- ▶ Enter characters and save the entry. Proceed as described under "Entering characters" in the "Entering characters in the address and phone books" section (▷ page 23).

### Deleting an address book entry

- ▶ **Option 1:** select **Delete** in the address book using the buttons and press the button to confirm.
  - ▶ **Option 2:** search for an address book entry (▷ page 109).
  - ▶ Select **Options** using the button and press the button to confirm.
  - ▶ Select **Delete** and press to confirm. Irrespective of the option chosen, a prompt will appear.
  - ▶ Select **Yes** or **No** and press the button to confirm. If you select **Yes**, the entry will be deleted. If you select **No**, the process will be aborted.
- i** Deleting a mobile phone book entry only deletes the entry in the address book, not on the mobile phone.

### Displaying the detailed view for an address book entry

#### Selecting an entry

- ▶ Search for an address book entry and select it in the list using the buttons (▷ page 109).
- or
- ▶ Select an address book entry by browsing (▷ page 109).
  - ▶ In both cases, press the button. The detailed display appears.



P82.87-2144-31

Detailed display for home details









- ① Returns to the previous menu
  - ② Selected data field
  - ③ icon for home details
  - ④ Calls up options
  - ⑤ Symbol for business details
- ▶ Select a data field using the buttons and press the button to confirm.
  - ▶ **To close the detailed view:** select **Back** and press the button to confirm.

### Showing the details of an address book entry





- ▶ Select **Options** using the button and press the button to confirm.
- ▶ Select **Details** and press to confirm. The display is shown in full.
- ▶ **To close the detailed view:** press the , , or button.

## Changing an address book entry

### Changing an entry

- ▶ **Option 1:** search for an address book entry and select it from the list using the   buttons (▷ page 109).
- ▶ Select **Options** using the  button and press the  button to confirm.
- ▶ Select **Change** and press the  button to confirm.
- ▶ **Option 2:** call up the detailed view for an address book entry (▷ page 110).
- ▶ Select **Options** using the  button and press the  button to confirm.
- ▶ Select **Change Entry** and press the  button to confirm.  
Irrespective of the option, the input menu containing data fields appears.
- ▶ Proceed as described under "Entering characters" in the "Entering characters in the address and phone books" section (▷ page 23).

### Changing the category of a telephone number data field

- ▶ Display the detailed view for an address book entry (▷ page 110) and highlight the telephone number data field.
- ▶ Select **Options** using the  button and press the  button to confirm.
- ▶ Select **Change Category** and press the  button to confirm.
- ▶ Select a number category, e.g. **Home**.
- ▶ Select a telephone category, e.g. **Mobile Phone**.
- ▶ Select **Preferred** if desired and press the  button to confirm.  
Depending on the previous state, switch the option on  or off . The phone number is displayed as the first number in

the phone book and can be dialed immediately.



- ▶ Select **Save** and press  to confirm.  
The new category is stored.

## Calling a number stored in an entry





### Conditions

The mobile phone must be connected via the Bluetooth® interface.



### Option 1

- ▶ Display details for an address book entry (▷ page 110).
- ▶ Select the telephone number data field using the   buttons and press the  button to confirm.  
The telephone makes the call. The display switches to telephone mode.

### Option 2





- ▶ Display details for an address book entry.
- ▶ Select the telephone number data field using the   buttons.
- ▶ Select **Options** using the  button and press the  button to confirm.
- ▶ Select **Call** and press the  button to confirm.  
The telephone makes the call.

### Option 3





- ▶ Select an address book entry in the list using the   buttons.
- ▶ Press the  button.  
The telephone makes the call.

### Starting route guidance to an entry

#### Option 1

- ▶ Search for an address book entry (▷ page 109) with the  symbol and select it from the list.
- ▶ Display details for an address book entry (▷ page 110).
- ▶ Select the address data field using the   buttons and press the  button to confirm.

#### Option 2

- ▶ Search for an address book entry (▷ page 109) with the  symbol and select it from the list.
- ▶ Select **Options** using the  button and press the  button to confirm.
- ▶ Select **Navigate** and press the  button to confirm.





If the address data is complete and it matches the digital map, route guidance starts.

Subsequent operation will depend on how complete the address data items are and whether they correspond with the data in the digital map in the navigation system. They do not correspond, for example, if they are not written in the same way as the destination entry.





### Voice tags

#### Adding or changing a voice tag





You can enter voice tags via the Voice Control System (▷ page 191). Once you have assigned a voice tag to an address book entry, you can call up this entry with a voice command and dial a phone number, for example. You can add one voice tag per address book entry.

- ▶ Search for an address book entry with or without a voice tag ( symbol) (▷ page 109).
- ▶ Select **Options** using the  button and press the  button to confirm.
- ▶ Select **Voice Name** and press the  button to confirm.
- ▶ Select **Add** or **Change** and press the  button to confirm.  
Subsequent operation is voice-controlled. The Voice Control System guides you through the dialogs.

#### Deleting a voice tag

- ▶ Search for an address book entry with a voice tag (▷ page 109).
- ▶ Select **Options** using the  button and press the  button to confirm.
- ▶ Select **Voice Name** and press the  button to confirm.
- ▶ Select **Delete** and press  to confirm.  
A deletion prompt appears.
- ▶ Select **Yes** or **No** and press the  button to confirm.  
If you select **Yes**, COMAND deletes the voice tag.  
If you select **No**, the process will be aborted.

#### Listening to a voice tag

- ▶ Search for an address book entry with a voice tag (▷ page 109).
- ▶ Select **Options** using the  button and press the  button to confirm.
- ▶ Select **Voice Name** and press the  button to confirm.
- ▶ Select **Listen** and press the  button to confirm.  
You hear the voice tag.

## Importing contacts

### Conditions

You can import contacts to the address book from an external Bluetooth® device or an SD memory card.





The Bluetooth® device needs to be inside the vehicle and has to be switched on, activated, and authorized. It must be able to transmit contacts and/or vCards via Bluetooth®.

- i** Around 900 entries can be stored in the address book. When the maximum number has been reached, you can delete existing entries (> page 110), and then import new ones.

### Importing contacts

- ▶ Start the data exchange on the external device (see the external device's operating instructions).

or

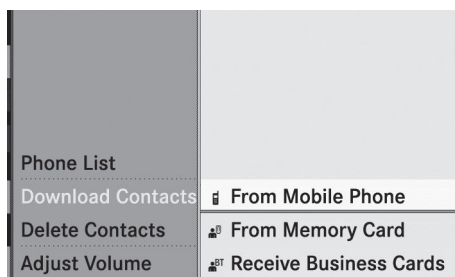

- ▶ Insert an SD memory card.
- ▶ Select **Address Book** in the address book using the    buttons and press the  button to confirm.
- ▶ Select **Download Contacts** and press the  button to confirm. A menu appears.



P82.87-2147-31

- ▶ Select **From Mobile Phone**, **From The Memory Card** or **Receive Business Card(s)** and press  to confirm. The contacts are imported.

## Deleting contacts

- ▶ With the address book shown, select **Address Book** and press the  button to confirm. A menu appears.
- ▶ Select **Delete Contacts** and press the  button to confirm.
- ▶ Select one of the following options:
  - **Internal Contacts**
  - **From Mobile Phone**
  - **From The Memory Card**
  - **Received Business Cards**
  - **Delete All**
 A prompt corresponding to your selection appears.
- ▶ Select **Yes** or **No** and press the  button to confirm. If you select **Yes**, the contacts are deleted according to your selection. If you select **No**, the process will be aborted.



## Operating the telephone using the multifunction steering wheel

### Telephone menu

#### Introduction

You can operate the telephone using the functions in the "Telephone" menu, provided you have connected it to the Mercedes-Benz hands-free system.

The display in the "Telephone" menu depends on the status of the telephone.

- ▶ Switch on the telephone and COMAND.
- ▶ Press the  or  button to select the **TEL** display.

#### Telephone is ready to receive calls

Bluetooth® interface telephony: whether the network provider's name is displayed depends on the telephone connected.

### Accepting a call

When the telephone is ready for use, you can accept a call at any time. When a call is incoming, you see the name or telephone number in the multifunction display.









- ▶ Press the  button on the multifunction steering wheel.

### Rejecting or ending a call

- ▶ Press the  button on the multifunction steering wheel.

### Calling a number from the COMAND phone book

You may select and dial a number from the COMAND phone book at any time, provided your mobile phone is ready to receive calls.

- i** If you have imported contacts (> page 113), you can select the phone book entries of the mobile phone by using the multifunction steering wheel.
- ▶ Press the  or  button to select the TEL display.
- ▶ Press the  or  button to open the phone book in the multifunction display.
- ▶ Press the  or  button repeatedly until the desired entry is highlighted. The saved names are displayed alphabetically.
- i** If you press and hold the  or  button for longer than one second, the multifunction display will skip from the fifth entry to the first entry found under the following letter. Release the button to stop.

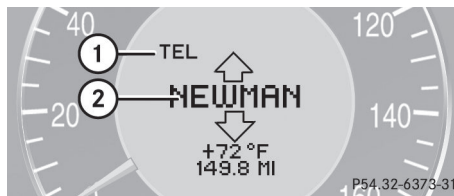

- ① Mode
- ② Caller's name







- ▶ **To make a call:** press the  button on the multifunction steering wheel.

**i** If there are several numbers for this name, you see a list of sub-entries.

- ▶ Press the  button again. The **Connecting call...** message appears in the multifunction display along with the number being dialed and the name, if it is stored in the phone book. The phone number dialed is stored in the appropriate call list.

- ▶ **To exit without connecting a call:** press the  button on the multifunction steering wheel.

### Redialing

- ▶ Press the  or  button to select the TEL display.
- ▶ Press the  button. You see the last call dialed.
- ▶ To scroll through the list of dialed calls: press the  or  button repeatedly until the desired entry is shown.
- ▶ **To make a call:** press the  button.

COMAND features .....	116
Radio mode .....	116
HD Radio .....	120
Satellite radio .....	121
Audio CD/DVD and MP3 mode .....	126
MUSIC REGISTER .....	137
Media Interface mode .....	141
Audio AUX mode .....	147

### COMAND features

These Operating Instructions describe all standard and optional equipment available for your COMAND system at the time of purchase. Country-specific deviations are possible. Please note that your COMAND system may not be equipped with all the features described.

### Radio mode

#### General information

- ❗ Portable electronic devices in the vehicle may seriously impair radio reception.

#### Switching on radio mode

##### Option 1

- ▶ Press the **RADIO** function button.  
The radio display appears.

**Radio mode:** you will hear the last station played on the last waveband.

- ❗ Repeatedly pressing the **RADIO** function button switches through the wavebands in the order FM, AM, WB (▶ page 117) and SatRadio. Pressing the button again takes you back to FM radio mode.

##### Option 2

- ▶ Select **Audio** in the main function bar using the **▲** **◀** **▶** buttons and press the **OK** button to confirm.  
If radio mode was the last mode selected, it will now be active.  
If another audio mode is switched on, you can now switch to radio mode in the audio menu.
- ▶ Select **Audio** using the **▲** button and press the **OK** button to confirm.  
The audio menu appears.

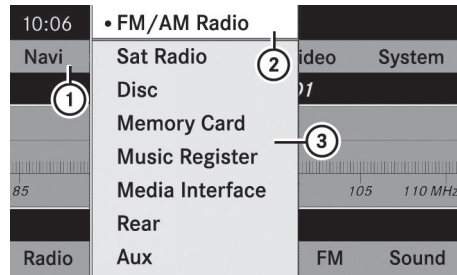

P82.87-2944-31

- ① Main function bar
  - ② Current audio operating mode
  - ③ Audio menu
- ▶ Select **Radio** (radio mode) using the **▲** **▼** buttons and press the **OK** button to confirm.

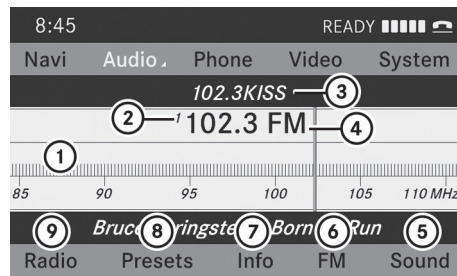

P82.87-3446-31

Radio display

- ① Display window with station selection
- ② Preset position of the selected station
- ③ Name of the selected station
- ④ Frequency of the selected station
- ⑤ Sound settings
- ⑥ Waveband submenu (FM, AM, WB)
- ⑦ To display radio text (FM and AM digital only)
- ⑧ Memory functions
- ⑨ Radio functions

## Switching wavebands

### Option 1

You can switch the radio between the FM, AM and WB waveband.

- ▶ Press the **RADIO** function button repeatedly until the desired waveband is selected.

### Option 2

- ▶ Press **▼** to highlight the submenu.
- ▶ **To select a waveband:** press the **▶** or **◀** button repeatedly until the currently selected waveband is highlighted (**FM**, **AM**, or **WB**).
- ▶ Press **OK**.  
The waveband submenu opens.

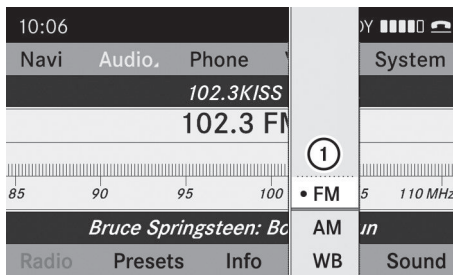

P82.87-3558-31

- ① Waveband submenu  
The **•** dot indicates the currently selected waveband.
- ▶ Select the waveband (FM, AM, or WB).

## Selecting a station

### Selecting stations using the station search function

- ▶ Press the **▶** or **◀** button when the display/selection window is active.
- or
- ▶ Press the **◀◀** or **▶▶** button on the COMAND control panel.  
Station search scans up or down and stops at the next station found.

## Selecting stations via the station presets

### Quick setting

- ▶ Press a number key, such as **2**.

### Directly in the station presets

- ▶ Select **Preset** (radio mode) using the **▼**, **◀**, **▶** buttons and press the **OK** button to confirm.

or

- ▶ Press the **OK** button when the display/selection window is active.  
The station preset menu appears. The **•** dot indicates under which preset the currently selected station is stored.

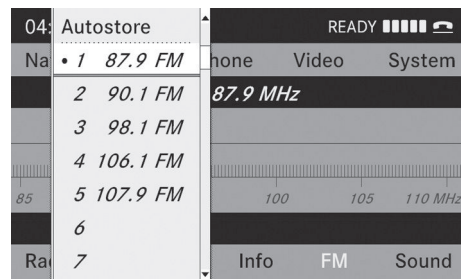

P82.87-3447-31

Station presets in radio mode

- ▶ Select a channel using the **▲**, **▼** buttons and press the **OK** button to confirm.

## Tuning in stations by entering the frequency manually

This function is available in radio mode.

### Option 1

- ▶ Press the **\*+OK** button.

### Option 2

- ▶ Select **Radio** in the radio display using the **▼**, **◀**, **▶** buttons and press the **OK** button to confirm.



- ▶ Select **Enter Frequency** and press the **OK** button to confirm. Irrespective of the option used, an input menu will appear.
- ▶ Enter a frequency using the number keys. COMAND tunes in to the frequency entered.

Waveband	Frequency
AM	530 - 1710 kHz
FM	87.8 - 107.9 MHz
WB (Weather Band)	Weather report channels

- i** You can only enter currently permitted numbers.
- i** If you enter a frequency in the FM or AM wavebands which is outside the frequency range, COMAND tunes in to the next lower frequency.

### Storing a station

#### Storing stations manually

There are ten presets available for each waveband (FM, AM, and SatRadio).

#### Quick save

- ▶ Press and hold a number key, e.g. **2**, until you hear a tone. The station is stored.

#### Directly in the station presets

- ▶ Press the **OK** button when the display/selection window is active.
- or
- ▶ Select **Presets** in the radio display using the **▼** **◀** **▶** buttons and press the **OK** button to confirm. In both cases, the station presets appear. The **•** dot indicates under which preset the currently selected station is stored.

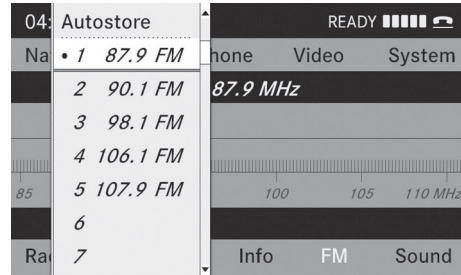

#### Station presets

- ▶ Select a preset using the **▲** **▼** buttons and press and hold the **OK** button until you hear a tone. The station is stored under the preset.

#### Storing stations automatically

This function automatically stores stations with adequate reception. The search starts at the lowest frequency. If stations are found, COMAND stores them starting at memory slot 1. Storing is complete when the highest frequency has been reached or when 10 stations have been found. Stations stored manually in the preset memory will be lost. It is possible that COMAND does not fill all memory slots when storing.

#### Option 1

- ▶ Press the **OK** button when the display/selection window is active.
- ▶ Select **Autostore** in the preset menu using the **▲** **▼** buttons and press the **OK** button to confirm.

#### Option 2

- ▶ Select **Presets** in the radio display using the **▼** **◀** **▶** buttons and press the **OK** button to confirm.
- ▶ Select **Autostore** and press the **OK** button to confirm. In both cases, COMAND searches for stations that can be received. You will see a message to this effect. The available

stations are automatically stored in the preset positions.

### Canceling storing

- ▶ Select **Cancel** and press the **OK** button to confirm.

## Weatherband

### Switching on

- ▶ Press the **RADIO** function button repeatedly until Weatherband has been selected.
- or
- ▶ Press the **▼** button to highlight the submenu.
- ▶ **To select Weatherband:** press the **▶** or **◀** button repeatedly until the currently selected waveband is highlighted (**FM** or **AM**).
- ▶ Press **OK**.  
The waveband submenu opens.
- ▶ Select **WB**.

### Searching for a channel

- ▶ Press the **▶** or **◀** button when the display/selection window is active.
- or
- ▶ Press the **◀◀** or **▶▶** button on the control panel.  
Channel search scans up or down and stops at the next channel found.

### Selecting a channel from the channel list

- ▶ Press the **▼** button to highlight the submenu.
- ▶ **To call up the channel list:** press the **▶** or **◀** button repeatedly until **Channel** is highlighted.
- ▶ Press **OK**.  
The channel list appears.

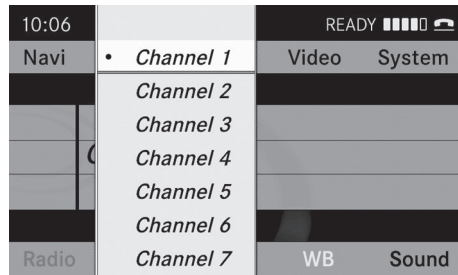

P82.87-3449-31

- ▶ **To select a channel:** press the **▲** or **▼** button.
- ▶ **To tune in the selected channel:** press the **OK** button.
- or
- ▶ Press a number key on the control panel, e.g. **4**, at any time.

## Program information

- i** This function is only available for analog FM programs and digital (HD Radio) AM/FM programs.

Information on the current program is usually displayed above the submenu bar.

- ▶ **To show the program information in the display/selection window:** select **Info** in the radio display submenu.

Information on the current program is now shown in the display/selection window. The contents and purpose of the information depend on the radio station.



P82.87-4132-31

## HD Radio

### Important notes

The "HD Radio™" chapter provides detailed information on the following:

- special functions available exclusively for HD Radio when compared with analog AM and FM radio
- selecting an HD Radio station
- displaying program information

**i** Optionally available HD Radio® equipment is required to make use of the HD Radio functions described here. Registration is not required.

**i** HD Radio functions offer:

- digital broadcasting in the same wavebands as analog AM/FM. The analog AM/FM stations remain available on the same frequencies when selecting a station.
- multiple program streams via a single AM/FM frequency (e.g. HD1, HD2 etc.)
- interference-free, clear reception
- FM: sound reproduction in CD quality; AM: sound reproduction as for analog FM stations
- numerous data services, text-based information display: artist's name, track name etc.

Further information on HD Radio can be found at <http://www.hdradio.com>.

**i** Please note that sub-programs and program information shown in the illustrations are dependent on the program broadcast by the respective radio station. The program contents may vary. The sub-programs and programs shown in the illustrations in this manual may therefore differ from the sub-programs and programs broadcast by radio stations.

## Switching on HD radio



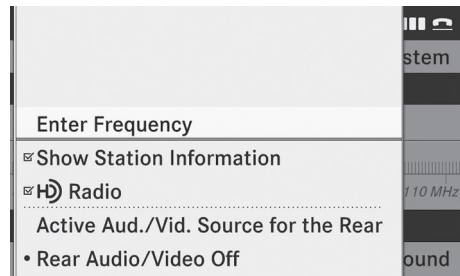

**i** As HD Radio stations are broadcast in the AM/FM wavebands, operating HD Radio is similar to operating analog AM/FM radio. This chapter describes only those functions that differ from standard FM radio functions.

Operating analog FM/AM radio is described in the "Radio" chapter (▷ page 116).

You can deactivate HD Radio for the selected frequency in the radio submenu.



P82.87-3458-31

▶ Select **Radio** in the radio display using the     buttons and press the **OK** button to confirm.

▶ Select **HD Radio** and press the **OK** button to confirm.

If check box  is empty, HD Radio is deactivated.

You will be listening to the frequency's analog program.

If you switch to another HD Radio frequency, HD Radio is automatically reactivated.

### HD Radio® display

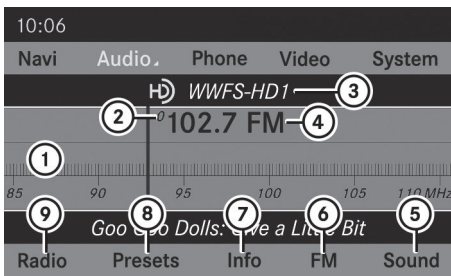

P82.87-2499-31

- ① Display/selection window with frequency display
- ② Preset number
- ③ Name of the selected station with HD icon and program number
- ④ Station frequency
- ⑤ Sound settings
- ⑥ FM, AM or WB radio
- ⑦ Program information
- ⑧ Station presets
- ⑨ Radio functions

### Switching wavebands

See "Switching wavebands" in the radio mode chapter (▷ page 117).

### Selecting a station

You can select an HD Radio station in the same way as selecting a standard FM radio station. After tuning in to an HD Radio frequency, you will briefly hear the analog station until the digital data has been decoded. You will then be listening to digital radio and be able to switch to a sub-program (-HD2).

See "Selecting stations" in the Radio mode section (▷ page 117).

### Storing stations

See "Storing stations" in the Radio mode section (▷ page 118).

### Displaying program information

- ▶ Select **Info** in the radio display using the buttons and press the button to confirm.

Information on the currently selected station is displayed. The contents and purpose of the information depend on the HD Radio station.

### Satellite radio

#### Important notes

This section provides detailed information on the following topics:

- selecting a channel and program category
- memory functions
- sound settings

**i** The SatRadio mode described below requires optionally available SatRadio equipment and registration with a SatRadio provider.

**i** Note that the categories and channels shown in the illustrations depend on the program content offered by the provider. The program contents may vary. The illustrations and descriptions in these operating instructions may therefore differ from the channels and categories offered by the provider.

SatRadio mode may be temporarily unavailable or interrupted for a variety of reasons. These reasons include environmental or topographical conditions as well as other issues beyond our control. Operation may also be impaired in certain locations (e.g. tunnels, parking garages) or in the vicinity of facilities or objects that impair satellite reception.

**i** SIRIUS XM Radio offers more than 130 digital-quality radio channels providing 100% commercial-free music, sport, news and entertainment.

SIRIUS XM Radio employs a fleet of high-performance satellites to broadcast around the clock throughout the USA and Canada.

The SatRadio program is available for a monthly fee. Details are available from the SIRIUS XM Service Center and at

<http://www.sirius.com> (USA) or







<http://www.siriuscanada.com>

(Canada).













## Registering

### Registering SatRadio

Switching to SatRadio mode:

- ▶ **From another main function:** select **Audio** using the     buttons and press the  button to confirm.
- ▶ Select **Audio** and press the  button to confirm.
- ▶ Select **SatRadio** and press the  button to confirm.

**i** If radio mode was the last active mode, you only need to select **Audio**.

- ▶ **When in audio mode:** select **Audio** using the     buttons and press the  button to confirm.
- ▶ Select **SatRadio** and press the  button to confirm.  
The satellite radio main menu appears showing the weather channel. You cannot select any other stations.
- ▶ Select **SatRadio** (in the submenu) using the     buttons and press the  button to confirm.
- ▶ Select **Service** and press the  button to confirm.  
The service information screen appears.



P82.87-3940-31

Service information screen

- ① Provider's phone number (SIRIUS XM)
- ② SIRIUS ID of your satellite receiver
- ③ SIRIUS ID of your traffic tuner

- ▶ Call the phone number of your satellite radio provider shown on the screen.

**i** You can also have the satellite service activated online. To do so, visit the SIRIUS XM Radio website at

<http://www.sirius.com> (USA) or

<http://www.siriuscanada.com>





(Canada).

Once the connection has been established:

- ▶ Follow the instructions of the service staff. The activation process may take up to ten minutes. If the activation is completed successfully, the **No Service** message appears in the display, followed by the SatRadio main menu.

**i** If registration is not included when purchasing the system, your credit card details will be required to activate your account.







## SatRadio mode

**i** You can also use the multifunction steering wheel to tune in channels or scroll through lists, e.g. by pressing the     buttons.







## Switching on

Important notes on registration, see "Registering satellite radio" (▷ page 122).

Switching on SatRadio mode:

- ▶ **From another main function:** select **Audio** using the     buttons and press the  button to confirm.
- ▶ Select **Audio** and press the  button to confirm.
- ▶ Select **SatRadio** and press the  button to confirm.

**i** If radio mode was the last active mode, you only need to select **Audio**.

- ▶ **When in audio mode:** select **Audio** using the     buttons and press the  button to confirm.
- ▶ Select **SatRadio** and press the  button to confirm.

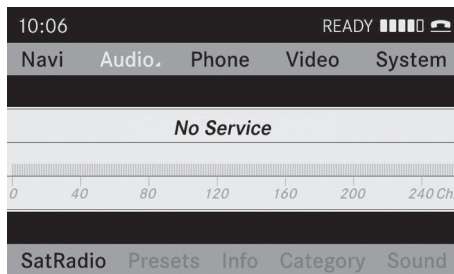

P82.87-2154-31

The **No Service** message appears when starting up or if no signal is being received. Once COMAND receives the signal, the satellite radio display appears. The station last selected is played.

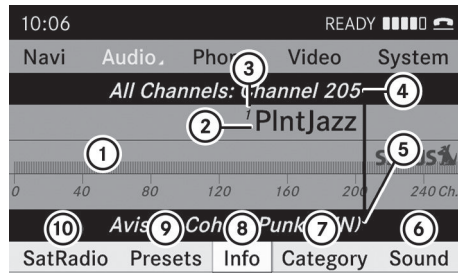

P82.87-2155-31



Satellite radio main menu



- ① Satellite radio main display
  - ② Channel name
  - ③ Preset
  - ④ Selected category/channel number
  - ⑤ Channel information (in brief)
  - ⑥ Sound settings
  - ⑦ Category list
  - ⑧ Channel information (in detail)
  - ⑨ Channel preset list
  - ⑩ SatRadio menu
- i** You can display details for the following:
- Channel information (▷ page 125)

## Changing the category

Satellite radio stations are sorted into various categories. You can choose between the different categories, such as news/talk shows, sports or country, if they are available. The category list is sorted alphabetically.

### Selecting a category

- ▶ **To call up the category list:** press the  or  button repeatedly until **Category** is highlighted in the submenu.
  - ▶ Press .
- The category list appears.

- ▶ **To select a category:** press the  or  button.
- ▶ **To tune in the selected category:** press . The category selected is shown in the display. The station last selected in this category begins playing. The **All Channels** category is at the top of the category list. This category is sorted by channel number and allows you to browse all available channels.





## Audio

### Selecting a channel



The following functions are available to you:

- channel search
- channel selection by direct entry
- channel selection by SatRadio channel list
- selection by preset menu

#### Channel search

- ▶ Press  or  when the SatRadio main display is highlighted.
- or
- ▶ Press the  or  button on the control panel. COMAND searches in both directions (ascending and descending) and stops at the next channel found in the selected category.

#### SatRadio menu

- ▶ Using the  or  button, select **SatRadio** in the submenu bar and press the  button to confirm.

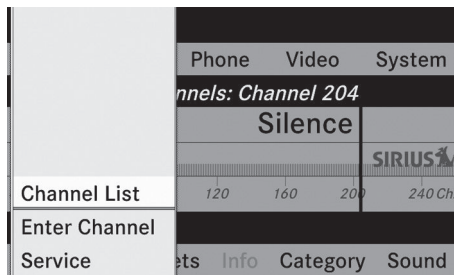

P82.87-2156-31

The SatRadio menu appears.

#### Entering channel numbers directly









- ▶ Select **SatRadio** in the SatRadio menu using the , , ,  buttons and press the  button to confirm.
- ▶ Select **Enter Channel** and press the  button to confirm. An input dialog appears.

or

- ▶ Press  on the control panel.
- ▶ **To enter a channel:** press the corresponding number key on the control panel. COMAND sets the selected channel.

 You can only select currently permitted digits.

#### Selecting a channel from the SatRadio channel list

- ▶ Select **SatRadio** in the SatRadio menu using the , , ,  buttons and press the  button to confirm.
- ▶ Select **Channel List** and press the  button to confirm. The channel list appears.
- ▶ **To select a channel:** select  or .
- ▶ **To tune in the selected channel:** press .

## Memory functions

**i** There are ten presets available.

The following functions are available to you:

- storing channels
- selecting channels from the satellite presets

## Storing channels

▶ Press **OK** when the display/selection window is active.

or

▶ Select **Presets** in the SatRadio submenu bar.

In both cases, the channel presets appear.

The • dot in front of a preset entry indicates that the currently selected station is stored under this preset.

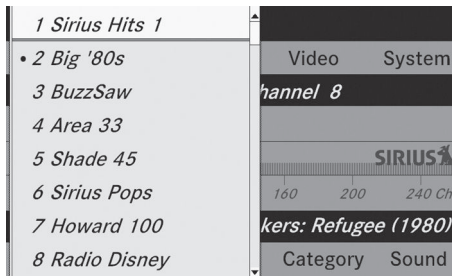

P82.87-2157-31

Channel presets

▶ **To select a preset:** press the **▲** or **▼** button.

▶ **To store a channel under a selected preset:** press and hold **OK** until a tone sounds.

or

▶ Press and hold a number key, e.g. **4**, until you hear a tone. The channel is stored.

## Selecting a channel from the preset list

▶ **To call up the channel list:** press **▶** or **◀** in the submenu repeatedly until **Presets** is highlighted.

The channel preset list appears.

▶ **To select a channel:** press the **▲** or **▼** button.

▶ **To tune in the selected channel:** press **OK**.

or

▶ Press a number key on the control panel, e.g. **4**.

## Displaying information

▶ Press **▶** or **◀** in the submenu repeatedly until **Info** is highlighted.

▶ Press **OK**.

Information on the currently received program is displayed.

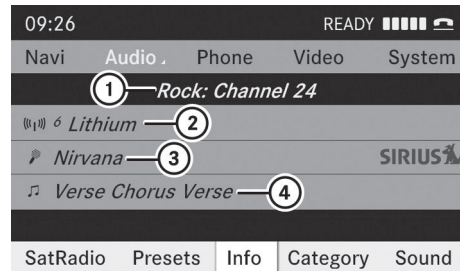

P82.87-3923-31

① Category

② Channel

③ Artist

④ Name of the song

If available, you will see:





- the full name
- additional information

▶ **To return to the SatRadio main display:** press **▶** or **◀**.



### Displaying service information

If you have any questions or require version information, you can call the provider's customer service center at any time.

- ▶ Select **SatRadio** using the     buttons and press the **OK** button to confirm.
- ▶ Select **Service** and press the **OK** button to confirm.  
The provider's details appear.



- ① Provider's phone number (SIRIUS XM)
- ② SIRIUS ID of your satellite receiver
- ③ SIRIUS ID of your traffic tuner

- ▶ **To return to the SatRadio main display:** press  or .

### Updating the channel list

When receiving a new channel list, the display shows the **Updating Channels...** message.

The station last selected is muted until the update has been completed. SatRadio mode is not available during the update process.

When the update has been completed, the SatRadio main menu appears. The station last selected is played.

### Sound settings

Information on the sound settings can be found in the "At a glance" chapter.

- Volume (▷ page 27)
- Balance and fader (▷ page 28)

- Treble and bass (▷ page 28)
- Surround sound (▷ page 28)

### Audio CD/DVD and MP3 mode

#### Safety notes

##### **WARNING**

COMAND is classified as a Class 1 laser product. You must not open the casing. If you open the casing, or if the casing is faulty or damaged, there is a risk of exposure to invisible laser radiation. This may damage your eyes, or those of others.

COMAND does not contain any parts that can be serviced by the user. For safety reasons, all maintenance work must be carried out by qualified aftersales technicians.

##### **WARNING**

Only when the vehicle is stationary should you:

- load a disc
- eject a disc

There is a risk of being distracted from the road and traffic conditions if this is done while the vehicle is in motion.

### Inserting/ejecting CDs/DVDs

#### Notes

##### **WARNING**

Only insert a CD or DVD when the vehicle is stationary. There is a risk of being distracted from the road and traffic conditions if this is done while the vehicle is in motion.

If the CD/DVD has a printed side, this must face upwards when the CD/DVD is inserted. If neither side is printed, the side to be played should face downwards. CDs/DVDs with copy protection may not be able to be played by the system.

- i** If a medium contains other files in addition to music files, the loading time before the first track starts to play may be longer.

### Inserting discs into the DVD changer



The DVD changer has a fixed magazine with six trays.

#### Inserting a single CD/DVD into a magazine tray

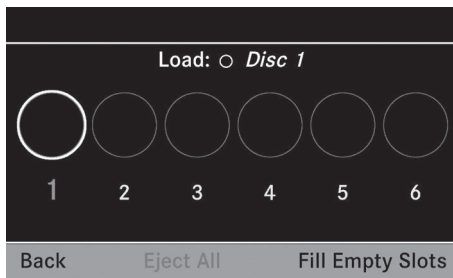
- ▶ Press the  load/eject button. A menu shows the current load status of the magazine trays. The last tray selected is identified by a red digit.



P82.87-2159-31

- ▶ Select the magazine tray using the   buttons and press the  button to confirm.

or

- ▶ Press a number key, e.g. . The DVD changer switches to the selected magazine tray. You see the **Please wait...** message.

You then see the **Please insert disc <x>** message.

- i** Never insert a data medium before COMAND prompts you to do so. Never insert more than one disc into a magazine tray at a time.

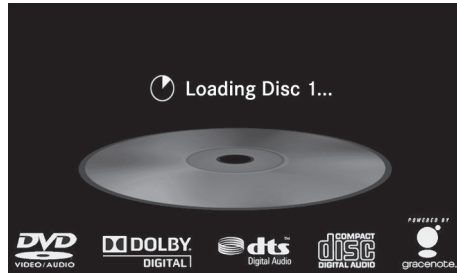

P82.87-3901-31

- ▶ Insert a disc into the disc slot with the printed side facing upwards. The DVD changer loads the disc into the selected magazine tray. You see the **Loading disc <x>...** message.

- i** It may take some time for the disc to be loaded, depending on the type of disc. If no disc is inserted for approximately 20 seconds, the display returns to the magazine menu.

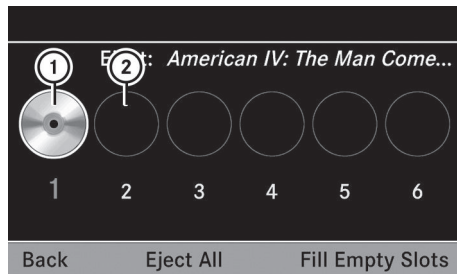

The DVD changer plays the disc if:

- it has been inserted correctly.
- it is a permissible type of disc.



P82.87-2161-31

- ① Full magazine tray (eject function is available)
- ② Empty magazine tray (disc can be inserted)

- ▶ **To exit the menu:** press the  eject/load button again or press the  button.

### Loading empty magazine trays

- ▶ Press the  load/eject button. The magazine menu appears.
- ▶ Select **Fill empty slots**. You see the **Please wait...** message. COMAND switches to the next empty magazine tray. You then see the **Please insert disc <x>** message.

**i** Never insert a data medium before COMAND prompts you to do so. Never insert more than one disc at a time into a magazine tray.

- ▶ Insert a disc into the disc slot with the printed side facing upwards. You see the **Please wait...** message. Once the disc is loaded, the DVD changer switches to the next empty tray. You see the **Please insert disc <x>** message.
- ▶ Repeat this step until all trays are loaded. The DVD changer will play the last disc loaded if it has been inserted correctly and is of a permissible type. This applies even if not all trays have been loaded with a disc.
- ▶ **To complete the insertion:** press the  eject/load button again or press the **BACK** button.

### Ejecting discs from the DVD changer

#### Notes

#### WARNING

Only eject a disc when the vehicle is stationary. Otherwise, you may be distracted from the traffic conditions and could cause an accident.

If you remove one disc while playing another disc, the DVD changer interrupts playback. Playback continues once the disc has been ejected.

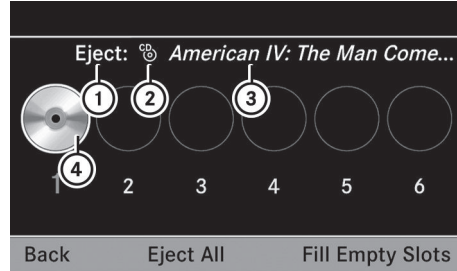

#### Ejecting a single disc

- ▶ Press the  load/eject button. The magazine menu appears. The magazine tray with the current disc is highlighted.





P82.87-2162-31

- ① Magazine tray loaded (ejection is enabled)
- ② Disc type
- ③ Disc name (only if stored on the disc)
- ④ Current disc (ejecting possible)

- ▶ Select a loaded magazine tray using the   buttons and press the  button to confirm.

or

- ▶ Press number keys  to . The **Ejecting disc <x>...** message appears. Then, you see the following message:





P82.87-2163-31

- ▶ Take the disc out of the slot. If you do not take the disc out of the slot, COMAND will draw it in again automatically after a short while and load it again.

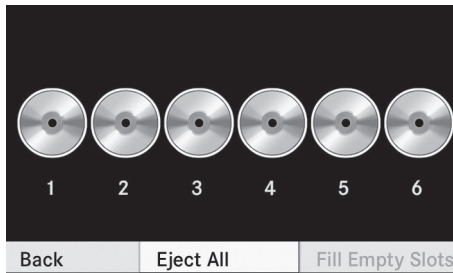
### Ejecting all CDs/DVDs



P82.87-2164-31

- ▶ Press the  load/eject button. The magazine menu appears.
- ▶ Select **Eject all**. The DVD changer ejects the last disc selected. You see the **Ejecting disc <x>...** message.
- ▶ Take the disc out of the disc slot when you see the **Please remove disc <x>** message. The DVD changer switches to the next loaded magazine tray and ejects the disc.
- ▶ Repeat the last step until the magazine is empty.
- ▶ **To cancel ejecting:** press the  eject/load button again or press the **BACK** button.

### Inserting and ejecting an SD memory card

#### General information

COMAND supports 16-bit full-size type I and II SD memory cards.

Mercedes-Benz recommends using SD memory cards with a storage capacity of up to 4 GB.

SD memory cards feature the following logo:



This logo is a registered trademark of SanDisk Corporation.

- ▶ **i** COMAND does not support the "SD-HC 2.0 Standard" SD card format. Not all SD memory cards and storage media are designed for the temperatures which may be reached in the vehicle. Due to the wide range of SD memory cards available on the market, playback cannot be guaranteed for all brands of SD memory card.

#### Inserting an SD memory card

- ▶ Insert the SD memory card into the slot. The side with the contacts must face downwards and point towards the slot. COMAND loads the memory card and shows a message to this effect. If no MP3 tracks can be found, you will see a message to this effect.

#### Ejecting an SD memory card

- ▶ Press the SD memory card. The SD memory card is ejected.
- ▶ Remove the SD memory card from the slot.

### Activating audio CD/DVD or MP3 mode

#### Option 1

- ▶ Insert a CD/DVD (▷ page 126) or an SD memory card (▷ page 129). COMAND loads the medium inserted and starts to play it.

### Option 2

▶ Press the **Disc** function button one or more times.

**i** By pressing the **Disc** function button repeatedly, you can switch modes in the following order:

- Audio CD or DVD/video DVD/MP3 discs in the DVD changer (disc)
- SD memory card mode
- MUSIC REGISTER
- Media Interface mode

▶ If desired, select an audio medium from the media list (▶ page 132).

### Option 3

▶ Select **Audio** in the main function bar using the **◀ ▶ ▲ ▼** buttons and press the **OK** button to confirm.

If disc mode was the last mode selected, it will now be active.

If another audio source is switched on, you can now switch to disc mode in the audio menu.

▶ Select **Audio** using the **▲ ▶ ▶** buttons and press the **OK** button to confirm. The audio menu appears.

▶ Select **Disc** or **Memory card** and press the **OK** button to confirm. The desired disc mode is activated.

▶ If desired, select an audio medium from the media list (▶ page 132).

### Example display: audio CD mode

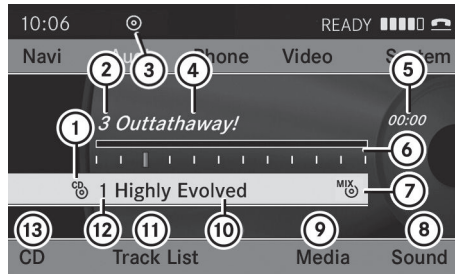

P82.87-2502-31

- ① Disc type
- ② Track number
- ③ CD or DVD inserted
- ④ Track name (only if stored on the disc as CD text or if Gracenote® data is available)
- ⑤ Track time
- ⑥ Graphic time and track display
- ⑦ Current playback settings (no symbol for "Normal track sequence")
- ⑧ Sound settings
- ⑨ Media selection
- ⑩ Disc name (only if stored on the disc as CD text or if Gracenote® data is available)
- ⑪ To call up the track list
- ⑫ Data carrier position in the media list
- ⑬ Playback options

### Example display: audio DVD mode



P82.87-2166-31

- ① Disc type
- ② Track number
- ③ CD or DVD inserted

- ④ Track name (only if stored on the disc as CD text)
- ⑤ Track time
- ⑥ Graphic time and track display
- ⑦ Current playback settings (no symbol for "Normal track sequence")
- ⑧ Sound settings
- ⑨ Media selection
- ⑩ Disc name (only if stored on the disc)
- ⑪ To call up the track list
- ⑫ Stop function
- ⑬ Pause function
- ⑭ Data carrier position in the media list
- ⑮ Playback options

### Example display: MP3 mode

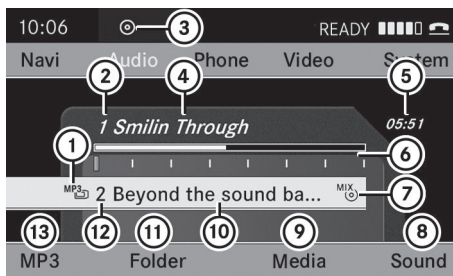

P82.87-2167-31

- ① Disc type
- ② Track number
- ③ CD or DVD inserted
- ④ Track name
- ⑤ Track time
- ⑥ Graphic time and track display
- ⑦ Current playback settings (no symbol for "Normal track sequence")
- ⑧ Sound settings
- ⑨ Media selection
- ⑩ Current folder
- ⑪ To call up the folder list
- ⑫ Data carrier position in the media list
- ⑬ Playback options

- ❗ If no Media Interface (> page 141) is connected during operation with a DVD changer, ⑧ displays **Changer** instead of **Media**.

### Pause function

#### In audio CD/DVD and MP3 mode

- ▶ **To pause playback:** briefly press the button. The symbol appears at the top left in the status bar.
- ▶ **To continue playback:** briefly press the button again. The symbol disappears.





#### In audio DVD mode only

- ▶ **To pause playback:** switch on audio DVD mode (> page 129).
- ▶ Select using the buttons and press the button to confirm. The display changes to .
- ▶ **To continue playback:** select and press the button to confirm. Playback continues from the point where it was interrupted. The display changes to .

### Stop function



This function is only available in audio DVD mode.

- ▶ Switch on audio DVD mode (> page 129).
- ▶ **To interrupt playback:** select using the buttons and press the button to confirm. The display changes to . remains highlighted.
- ▶ **To continue playback:** select and press the button to confirm. Playback continues from the point where it was interrupted.



- ▶ **To stop playback:** while playback is interrupted, select  again and press the  button to confirm.
  - ▶ is highlighted.
- ▶ **To restart playback:** select  and press the  button to confirm. Playback starts at the beginning of the DVD.

### Selecting audio CD/DVD/MP3 discs

#### Selecting via the media list

- ▶ **In audio CD/DVD and MP3 mode:** select **Media** or **Changer** using the , ,  buttons and press the  button to confirm.

or

- ▶ **In audio CD/DVD mode only:** press the  button when the display/selection window is active. The media list appears. The  dot indicates the current medium being played.



P82.87-2168-31

#### Media list

The media list shows the discs currently available. Readable discs are audio CDs, MP3 CDs or DVDs, audio DVDs and video DVDs.

- ▶ **i** If a disc is not readable, an entry appears behind the magazine tray or you receive a message at the selected memory card.

#### Positions in the media list



##### For DVD changer

Media Interface, position 0

Magazine trays, positions 1 to 6

SD memory card, position 7

MUSIC REGISTER, position 8

- ▶ Select a disc using the ,  buttons and press the  button to confirm.

- ▶ **i** If you select a video DVD, the system switches to video DVD mode (▶ page 150).

#### Selecting a track using the number keypad

- ▶ Press a number key, e.g. , when the display/selection window is active. The medium at the corresponding position in the media list is loaded and then played.

#### Selecting a track

##### Selecting by skipping to a track

- ▶ **To skip forwards or backwards to a track:** press the  or  button.

or

- ▶ Press the  or  button.

The skip forward function skips to the next track.

Skipping backwards restarts the current track (if it has been playing for more than eight seconds) or starts the previous track (if the current track has only been playing for a shorter time).

If the **Random tracks** or **Random folder** playback option has been selected, the track order is random.



### Selecting by track list

- ▶ Select **Title** or **Track list** in audio CD/DVD mode and press the **OK** button to confirm.

or

- ▶ Press the **OK** button in MP3 mode when the display/selection window is active. The track list appears. The **•** dot indicates the current track.
- ▶ Select a track using the **▲** **▼** buttons and press the **OK** button to confirm.

- i** In MP3 mode, the list shows all the tracks in alphabetical order.

### Selecting a track using the number keypad

- ▶ Press the **\*+OK** button on the number keypad. A numerical entry field appears. The number of positions offered corresponds to the number of tracks on the CD/DVD. Only numbers that correspond to a track number on the CD/DVD can be entered.
- ▶ Enter the desired track number using the number keys.
- ▶ **To complete entry:** press the **OK** button.

- i** Pressing and holding a number button for 2 seconds or more also completes entry and the corresponding track is played.

### Selecting using the multifunction steering wheel

- ▶ Switch on audio CD/DVD, MP3 or SD memory card mode on COMAND.
- ▶ Use the **DISC** or **DISC** button on the multifunction steering wheel to select the DISC display.
- ▶ Press the **▲** or **▼** button on the multifunction steering wheel. You will hear the previous or next track. The skip back function skips to the beginning of the current track if the track has been playing for more than eight seconds. If the

track has been playing for less than eight seconds, it skips to the start of the previous track.

### Fast forwarding/rewinding

#### Selecting using COMAND

- ▶ With the display/selection window active, press the **◀** or **▶** button repeatedly until you reach the desired position.

or

- ▶ Press and hold the **◀◀** or **▶▶** button until the desired position is reached.

#### Selecting using the multifunction steering wheel

- ▶ Press and hold the **▲** or **▼** button on the multifunction steering wheel until the desired position has been reached.

### Selecting a folder

This function is only available in MP3 mode.

- ▶ Switch on MP3 mode (▷ page 129).
- ▶ Select **Folder** using the **▼** **◀** **▶** buttons and press the **OK** button to confirm.

or

- ▶ Press the **OK** button when the display/selection window is selected. The folder content appears.





P82.87-2169-31

- ① Symbol for next folder up
- ② Current track
- ③ Track symbol

- ▶ To switch to the superordinate folder: select icon ① and press the **OK** button to confirm.

The display changes to the next folder up.



P82.87-2170-31

- ① Disc name (only if stored on the disc)
- ② Current folder
- ③ Folder icon

- ▶ Select a folder using the **▲** **▼** buttons and press the **OK** button to confirm. You will see the tracks in the folder.
- ▶ Select a track using the **▲** **▼** buttons and press the **OK** button to confirm. The track is played and the corresponding folder is now the active folder.

## Gracenote Media Database

### Introduction

This function is only available in audio CD mode and during operation with the installed hard disk.

There is a version of the software from Gracenote®, Emeryville, California, USA on the hard disk. You will recognize this by the logo which can be seen in the bottom right-hand corner of certain audio displays.



Many audio CDs contain CD text. COMAND uses the information contained therein to display the artist, album and track name.

If the audio CD does not contain any CD text information, COMAND can use the Gracenote Media Database to identify unknown audio tracks when running in audio CD mode. The prerequisites for this are that the relevant information be stored in the Gracenote Media Database and that the "Read CD database" function is activated.





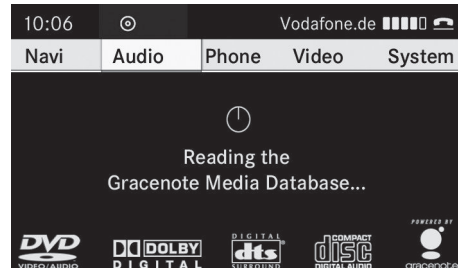



If this is the case, COMAND will display the corresponding data such as artist, album and track name in the relevant displays and lists.

If COMAND accesses the Gracenote Media Database when reading an audio CD, you will see the following message:



P82.87-2171-31

### "Read CD database" function

- ▶ Switch on audio CD mode (▷ page 129).
- ▶ Select **CD** using the     buttons and press the  button to confirm.
- ▶ Select **Read CD database** using the   buttons and press the  button to confirm.  
The function is switched on  or off , depending on the previous status.

### Updating Gracenote® music recognition technology and the Gracenote Media Database





The digital data on the Gracenote Media Database becomes obsolete due to the release of new CDs. Optimum functionality can only be attained with up-to-date Gracenote® music recognition technology. Information about new versions can be obtained from an authorized Mercedes-Benz Center.









You can have your music recognition software updated there with a DVD, or you can update it yourself.

-  The Gracenote Media Database is updated at the same time as the map software.

### Setting the audio format









You can only set the audio format in audio DVD mode. The number of audio formats available depends on the DVD. The content of an audio DVD is called an "album", and this can be divided into up to nine groups. A group can contain music in different sound qualities (stereo and multichannel formats, for example), or bonus tracks. Each group can contain up to 99 tracks. If an audio DVD only contains one audio format, the "Group" menu item(s) cannot be selected.

- ▶ Switch on audio DVD mode (▷ page 129).
- ▶ Select **DVD-A** using the    buttons and press the  button to confirm.

- ▶ Select **Group** using the   buttons and press the  button to confirm.  
The list of available audio formats appears. The  dot indicates the format currently selected.
- ▶ Select an audio format using the   buttons and press the  button to confirm.
- ▶ **To exit the menu:** press the  or  button.

### Playback options

The following options are available to you:

- **Normal track sequence**  
The tracks are played in the normal order (e.g. track 1, 2, 3, etc.).  
In MP3 mode, the track order is determined by the order in which the tracks are written to the MP3 data carrier when it is created. Alphabetical order is the most common. Once all the tracks in a folder have been played, the tracks in the next folder are played.
- **Random tracks**  
All the tracks on the medium are played in random order (e.g. track 3, 8, 5 etc.).
- **Random folder** (MP3 mode only)  
The tracks in the currently active folder are played in random order.
- ▶ **To select options:** switch on audio CD/DVD or MP3 mode (▷ page 129).
- ▶ Select **CD, DVD-A** or **MP3** using the    buttons and press the  button to confirm.  
The options list appears. The  dot indicates the option selected.
- ▶ Select an option using the  or  button and press the  button to confirm.  
The option is switched on. For all options except "Normal track sequence", you will see a corresponding display in the display/selection window. See example of display: audio CD mode (▷ page 130), item .

**i** The "Normal track sequence" option is automatically selected when you change the medium you are currently listening to or when you select a different medium. If an option is selected, it remains selected after COMAND is switched on or off.

### Notes on MP3 mode

#### Permissible discs

- CD-R and CD-RW
- DVD-R and DVD-RW
- DVD+R and DVD+RW
- SD memory card:

**i** COMAND does not support the "SD-HC 2.0 Standard" SD card format. Mercedes-Benz recommends using SD memory cards with a storage capacity of up to 4 GB.

#### Permissible file systems

- ISO 9660/Joliet standard for CDs
- UDF for audio and video DVDs
- FAT16 for SD memory cards with storage medium

#### Multisession CDs

For multisession CDs, the content of the first session determines how COMAND will process the CD. COMAND plays only one session and gives priority to the audio CD session.

If possible, use COMAND to play only CDs which have been written in one session.

#### File structure of a data carrier

When you create a disc with compressed music files, the tracks can be organized in folders. A folder may also contain subfolders. A disc can contain a maximum of 255 folders. Each folder can contain a maximum of 255 tracks and 255 subfolders. A disc can contain a maximum of 1200 tracks.

The disc may contain no more than eight directory levels. Files beyond the eighth level will not be recognized by the system.

#### Track and file names

When you create a disc with compressed music files, you can assign names to the tracks and folders.

COMAND uses these names accordingly for the display. Folders which contain data other than MP3 or WMA tracks are not displayed by COMAND.

If MP3 or WMA files are stored in the root directory itself, the root directory will also be treated as a folder. COMAND will then show the name of the root directory as the folder name.

You must observe the following when assigning track names:

- track names must have at least one character.
- track names must have the extension "mp3" or "wma".
- there must be a full stop between the track name and the extension.

Example of a correct track name:  
"Track 1.mp3".

**i** COMAND does not support ID3 tags.

#### Permissible formats

COMAND supports the following formats:

- MPEG1 Audio Layer 3 (MP3)
- Microsoft Windows Media Audio V2, V7, V8 and V9 (WMA) without copy protection

#### Permissible bit and sampling rates

##### MP3

COMAND supports MP3 files of the following types:

- constant and variable bit rates from 32 kbit/s to 320 kbit/s
- sampling rates of 8 kHz to 48 kHz

## WMA

COMAND supports WMA files of the following types:

- fixed bit rates of 8 kbit/s up to 384 kbit/s
- sampling rates of 8 kHz to 48 kHz

COMAND does not support WMA files of the following types:

- DRM (Digital Rights Management) encrypted files
- variable bit rate
- WMA Pro
- 5.1 Surround

- i** Only use tracks with a bit rate of at least 128 kbit/s and a sampling rate of at least 44.1 kHz. Lower rates can cause a noticeable deterioration in quality. This is especially the case if you have activated a surround sound function.

## Notes on copyright

MP3 or WMA tracks that you create or play back are generally subject to copyright protection in accordance with the applicable international and national regulations.

In many countries, reproductions, even for private use, are not permitted without the prior consent of the copyright holder.

Make sure that you know about the applicable copyright regulations and that you comply with these.

If you own these rights yourself, e.g. for your own compositions and recordings, or if the copyright holder has granted you permission, these restrictions do not apply.

## Notes on CDs/DVDs

Discs with copy protection are not compatible with the audio CD standard and therefore may not be able to be played by COMAND.

Playback problems may occur when playing copied discs. There is a wide range of data

carriers, disc-writing software and writers available. This variety means that there is no guarantee that the system will be able to play discs that you have copied yourself.

There may be playback problems if you play CDs that you have copied yourself with a storage capacity of more than 700 MB. CDs of this type do not conform to the currently applicable standards.

- i** On many DVD audio discs, the last track does not contain any music and COMAND then switches to the next disc. This is normal system behavior and does not mean that there is a malfunction.

- !** Do not affix stickers or labels to the discs. They could peel off and damage the drive. The drive is designed to hold discs which comply with the EN 60908 standard. Therefore, you can only use discs with a maximum thickness of 1.3 mm.

If you insert thicker discs, e.g. those that contain data on both sides (DVD on one side and audio data on the other), they cannot be ejected and can damage the drive.

Do not use discs with a diameter of 8 cm, even with an adapter. Only use round discs with a diameter of 12 cm.

- i** COMAND can play back audio CDs with the high-resolution surround format.

## MUSIC REGISTER

### General information

This function is available if COMAND features an integrated hard disk.

To protect the hard drive from damage, COMAND switches it off at very high temperatures. The MUSIC REGISTER will then be temporarily unavailable.

You can store music files in MP3 or WMA format in the MUSIC REGISTER. The memory has a capacity of 4 GB.

- ❗ Retain the original music files in a secure location. An error in COMAND might result in the loss of the music files stored in the MUSIC REGISTER. Mercedes-Benz is not liable for any loss of data.

### Switching to MUSIC REGISTER

#### Option 1

- ▶ Press the **DISC** function button repeatedly until the MUSIC REGISTER is switched on. If there are any music files, you will hear the first track in the first folder found or playback will begin at the point it was last interrupted.

If there are no music files, you will see a message to this effect.

By pressing the **DISC** function button repeatedly, you can switch modes in the following order:

- audio CD/DVD/MP3 (disc)
  - SD memory card mode
  - MUSIC REGISTER
  - Media Interface mode
- ▶ You first need to copy music files to the MUSIC REGISTER (▷ page 138).

#### Option 2

- ▶ Select **Audio** in the main function bar using the **▲** **◀** **▶** buttons and press the **OK** button to confirm.

If MUSIC REGISTER was the last mode selected, it is now switched on.

If another audio source is switched on, you can now switch on the MUSIC REGISTER in the audio menu.

- ▶ Select **Audio** using the **▲** button and press the **OK** button to confirm. The audio menu appears.
- ▶ Select **Music Register** and press the **OK** button to confirm.

#### Option 3

- ▶ Press the **8** **TUV** number button. The MUSIC REGISTER is switched on.

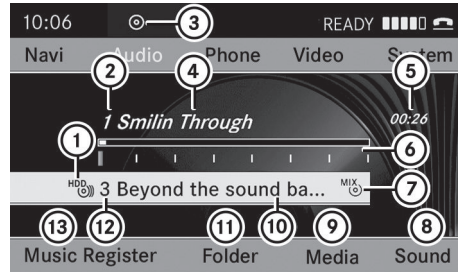

P82.87-2172-31

Example display: MUSIC REGISTER

- ① Type of data carrier: MUSIC REGISTER
- ② Track number
- ③ CD or DVD inserted
- ④ Track name
- ⑤ Track time
- ⑥ Graphic time and track display
- ⑦ Current playback settings (no symbol for "Normal track sequence")
- ⑧ Sound settings
- ⑨ Media selection
- ⑩ Current folder
- ⑪ Folder functions
- ⑫ Data carrier position in the media list
- ⑬ To call up the MUSIC REGISTER menu

### Copying music data to the MUSIC REGISTER

#### Introduction

You can copy music files from discs in the DVD changer or from the memory card, as long as they are in MP3 and/or WMA format.

- ❗ While copying, several functions will not be available. If this is the case, you will see a message to this effect.

## 1. Selecting a data medium

- ▶ Select **Music Register** using the    buttons and press the  button to confirm.
- ▶ Select **Copy music files** and press the  button to confirm.  
The media list appears. A data medium from which files can be copied is selected automatically.

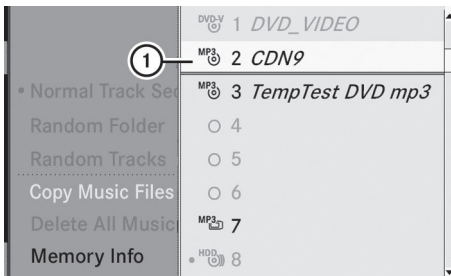

P82.87-2503-31

- ① Data medium selected

- ▶ Select a data medium using the   buttons and press the  button to confirm.  
The data medium is loaded.  
If the data medium contains music files that can be copied, you see a menu.

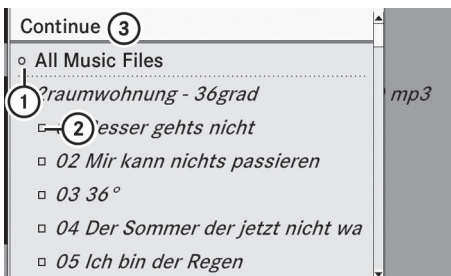

P82.87-2504-31

- ① To select an individual folder  
② To copy all music files  
③ To confirm your selection

## 2. Selecting music files

### Selecting all music files

- ▶ Select **All Music Files**.  
This function copies all music files on the selected data carrier. The icon in front of **All music files** ② is filled in and all following entries have a tick  beside them.

### Selecting folders or tracks

- ▶ Press the  or  button and confirm by pressing the  button.  
Selection ① is indicated by the  tick in front of the folder or track entry.

## 3. Confirming your selection

- ▶ Select **Continue** and press the  button to confirm.  
The copying menu appears.

## 4. Starting the copying process

- ① To copy from a memory card  
② To copy to the MUSIC REGISTER  
③ Memory requirement, see "Calling up memory space info" (▷ page 140)  
④ To determine destination folder  
⑤ Name of the data medium from which files are being copied  
⑥ To start the copying process  
⑦ Data carrier position in the media list  
⑧ To cancel copying of music files

- ▶ **To select a destination folder:** select **Destination folder** and press the  button to confirm.

- ▶ Press the  or  button and confirm by pressing the  button.
- ▶ Confirm **Start** by pressing the  button.  
Copying begins. The progress bar indicates the status of the copying procedure.

- ! When copying data from the memory card, never remove the memory card while

copying is in progress. You will otherwise create unusable data in the MUSIC REGISTER.

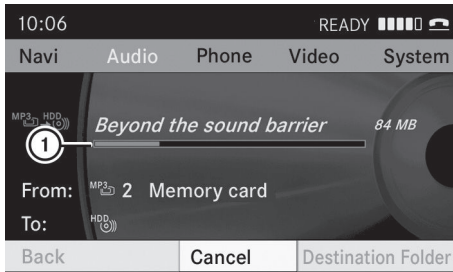

P82.87-2506-31

## Audio

① Progress bar

❗ It may take some time for the copying process to be completed, depending on the amount of data. It should take about one minute to copy 20 MB. If there is not enough memory space, you will see a message to this effect.

Once copying is complete, you hear the first track on the album copied. The MUSIC REGISTER display appears. Now you can copy more music files to the MUSIC REGISTER.

▶ **To cancel the copying process:** select **Cancel** and press the **OK** button to confirm. Music files are stored in the MUSIC REGISTER up until the point of cancellation.

### Deleting all music files

This function deletes all music files from the MUSIC REGISTER.

❗ The deletion procedure may take several minutes. In order to prevent malfunctions, do not use COMAND during this period.

- ▶ Select **Music Register** using the **▼** **◀** **▶** buttons and press the **OK** button to confirm.
- ▶ Select **Delete all music files** and press the **OK** button to confirm. A query appears. **No** is highlighted.

If you select **Yes**, all music files are deleted. You see the **Please Wait...** message. Then, you see the **Deletion Procedure Successful** message.

If you select **No**, the process will be aborted.

### Calling up memory space info

- ▶ Select **Music Register** using the **▼** **◀** **▶** buttons and press the **OK** button to confirm.
- ▶ Select **Memory info** and press the **OK** button to confirm. The following is displayed:
  - storage capacity
  - available memory
  - occupied memory
  - content (folders, tracks)

### Folder functions

#### Introduction

You can view the content of the MUSIC REGISTER, change folder or track names and delete individual folders or tracks.

❗ You cannot change folder or track names while the vehicle is in motion.

#### Calling up the MUSIC REGISTER

- ▶ Select **Folder** using the **▼** **◀** **▶** buttons and press the **OK** button to confirm.
- or
- ▶ Press the **OK** button when the display/selection window is selected. You see the content of the current folder.



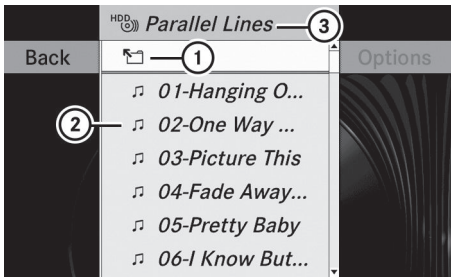

PB2.87-2176-31

- ① Folder selection symbol
- ② Icon for music file
- ③ Current folder

- ▶ To select one folder higher: select the symbol. The display changes to the next folder up.

### Changing the folder/track name

- ▶ Select **Folder** using the buttons and press the button to confirm.
- ▶ Select a folder/track using the buttons and press the button to confirm.
- ▶ Select **Options** and press the button to confirm.
- ▶ Select **Change** and press the button to confirm.
- ▶ Enter a name for the folder/track.
- ▶ **To save the changes:** select and press the button to confirm.

### Deleting folders/tracks

- ▶ Select **Folder** using the buttons and press the button to confirm.
- ▶ Select a folder/track using the buttons and press the button to confirm.
- ▶ Select **Options** and press the button to confirm.
- ▶ Select **Delete** and press to confirm. A query appears. **No** is highlighted. If you select **Yes**, the folders/tracks are deleted. You see the **Please Wait...**

message. Then, you see the **Deletion Procedure Successful** message.

If you select **No**, the process will be aborted.

### Playback options

The following options are available to you:

- **Normal Track Sequence**

The tracks are played in the normal order (e.g. track 1, 2, 3, etc.).

- **Random Tracks**

All the tracks on the medium are played in random order.

- **Random Folder** (only in MP3 mode)

The tracks in the currently active folder are played in random order.

- ▶ **To select options:** switch on the MUSIC REGISTER ([▷ page 138](#)).

- ▶ Select **Music Register**.

The options list appears. The dot indicates the option selected.

- ▶ Select an option.

The option is switched on. For all options except **Normal Track Sequence**, you will see a corresponding display in the display/selection window.

- ▶ **i** The **Normal Track Sequence** option is automatically selected when you change the disc you are currently listening to or when you select a different medium. If an option is selected, it remains selected after COMAND is switched on or off.

### Media Interface mode

#### Connection options

#### Overview

The connection jacks are located:

- in the center console stowage compartment (SL)
- in the glove box



To connect external devices to the Media Interface, you require device-specific adapter cables which are included in the Media Interface scope of delivery.

- ❗ Stow the individual parts in a secure location.

Use only genuine Mercedes-Benz connecting cables.

You can connect the following data carriers to COMAND via the Media Interface:

- iPod®
- USB devices (USB sticks, USB hard drives)

- ❗ iPod® is a registered trademark of Apple Inc., Cupertino, California, USA.

### Supported iPod® variants

The following are examples of supported iPod® variants:

- iPod® mini
- iPod® nano
- iPod® classic
- iPod® touch

### Supported USB devices

The following USB devices are supported:

- USB sticks (flash memory)
- USB hard drives requiring a startup/permanent current of max. 800 mA (it may be necessary to connect a separate power supply)
- certain MP3 players

- ❗ The Media Interface supports USB storage media of "USB Device Subclass 6". Information concerning USB Device Subclass 6 is available from the equipment manufacturer.

For further details and a list of supported devices, please contact an authorized Mercedes-Benz Center or visit <http://www.mercedes-benz.com/connect> and

proceed as described under "Media Interface".

### Connecting an external device

- ❗ Do not leave external devices in the vehicle, as at extreme temperatures (e.g. in direct sunlight or extremely low outside temperatures) they cannot be guaranteed to function correctly (see the operating instructions for the respective device). Mercedes-Benz does not take responsibility for any damage to external devices.

Never connect more than one device at a time. You will otherwise not be able to play back from the external device.

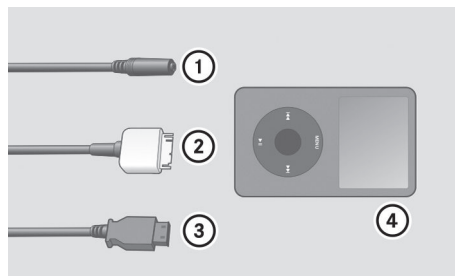

P82.60-6736-31

- ① Four-pin socket for 3.5 mm stereo jack, e.g. for MP3 players (audio and video)
- ② iPod socket, to connect an iPod®
- ③ USB socket, to connect a USB device
- ④ Example of device (iPod®)

- ▶ Connect the external device with suitable socket ①, ② or ③. COMAND activates the device.

If you remove a device, the **No Device Connected** message appears.

- ❗ A connected iPod® or MP3 player should not be simultaneously operated via the Media Interface and the remote control (e.g. Bluetooth® remote control) as this may produce unpredictable results.

- ❗ Connecting a completely discharged iPod or MP3 player can result in an extended initialization period.

Error messages appear while the device is being activated if:

- COMAND does not support the device connected (**External Device Unavailable**).
- two devices are connected simultaneously (**Please make sure that only one device is connected**).
- the connected device consumes too much power.
- the Media Interface connection is faulty.

- ❗ If necessary, consult an authorized Mercedes-Benz Center.

### Switches on Media Interface mode

#### General notes

In extreme cases, starting up individual functions can take up to several minutes – this depends on the external device and its content (e.g. video podcasts).

Only use the original software to store data on your iPods and MP3 players. Otherwise, some or all functions may not be available.

#### Options for switching on

##### Option 1

- ▶ Connect an external device (> page 142). COMAND activates the device. The basic display then appears.

##### Option 2

- ▶ Press the **[DISC]** function button one or more times.

By pressing the **[DISC]** function button repeatedly, you can change the operating mode in the following order:

- audio CD/DVD/MP3 (disc)
- SD memory card mode

- MUSIC REGISTER
- Media Interface mode

##### Option 3

- ▶ Press the **[0]** number key. This directly selects the connected external audio equipment.

##### Option 4

- ▶ Use the **[▲]** **[▼]** buttons to select the entry under position 0 in the media list (> page 132) and press the **[OK]** button to confirm.

COMAND activates the connected device. You will see a message to this effect. The basic display then appears.

If no device is connected, you will see the **Media Int.** entry instead of a device name.

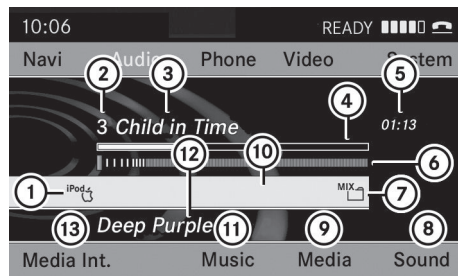

P82.87-2507-31

Example of Media Interface display (iPod® mode)

- ① Type of data medium
- ② Track number
- ③ Track name
- ④ Visual time display
- ⑤ Elapsed track time (also in format 00:00:00 for audiobooks)
- ⑥ Visual track display
- ⑦ Current playback settings (no icon for "Normal track sequence")
- ⑧ Sound settings
- ⑨ Media list
- ⑩ Album name (if supplied)
- ⑪ Categories, playlists and/or folders

- ⑫ Artist (if supplied)
- ⑬ Playback options

Type of device ① connected is indicated by the corresponding icon for iPod®, MP3 player or USB mass storage device.

- i** If the device connected does not contain any playable tracks, a message appears to this effect.



## Audio

### Selecting music files



#### Notes

COMAND displays the data stored on the iPod®, MP3 player or USB mass storage device according to the filing structure used in the respective medium.



#### Selecting by skipping to a track

- ▶ **To skip forwards or backwards to a track:** press the  or  button.

or

- ▶ Press the  or  button.  
 Skipping forward skips to the next track. Skipping backwards skips to the beginning of the current track if the track has been playing for more than eight seconds. If the track has been playing for less than eight seconds, it skips to the start of the previous track. If you have selected a playback option other than **Normal Track Sequence**, the track sequence is random.

#### Selecting using the number keypad



- ▶ **To make an entry:** press the  button.  
 An input menu appears. The number of characters available for input depends on the number of stored tracks.
- ▶ **To enter a track number:** press a number key, such as .  
 The digit is entered in the first position in the input line.

- i** COMAND will ignore and not display an invalid digit.



▶ If desired, enter further digits.

- ▶ **To confirm an entry:** press the  button or press and hold the number key corresponding to the last digit of the desired track number.  
 The selected track is played.

#### Fast forward/rewind

- ▶ With the display/selection window active, press the  or  button repeatedly until you reach the desired position.

or

- ▶ Press and hold the  or  button until the desired position has been reached.

- i** On an iPod®, the fast rewind function can only be used within the currently playing track.

### Selecting a category/playlist/folder

#### iPod® and selected MP3 players

You can select tracks for an iPod® and MP3 player according to categories and folders.

Categories can include:

- **Current Tracklist**
- **Playlists** (e.g. **All**)
- **Artists**
- **Albums**
- **Tracks**
- **Podcasts**
- **Genres**
- **Composers**
- **Audiobooks**







- i** Some playback categories contain the **All** entry. If this entry has been selected, the entire content of the category selected will be played.

## USB devices

For USB mass storage devices, you can select folders and also playlists (if available). When playing back playlists, COMAND can also display the respective album and artist name (metadata), if these have been uploaded to the system.

Playlists are indicated in the display by a special icon. When you open the playlist, the corresponding tracks are opened and playback begins. Now **Random Categories** is available as a playback option instead of **Random Folder**.





For USB mass storage devices, you can choose to display the metadata contained in the tags of the encoded music data, or to display the file and directory names when the music is playing.

- ▶ **To display the album and artist's name:** select **Media Int.** in the basic display using the    buttons and press the  button to confirm.
- ▶ Select **Display Metadata** using the   buttons and press the  button to confirm.

## Selecting a category and opening a folder

- ▶ Press the  button when the display/selection window is active.

or

- ▶ Select **Music** in the basic display using the    buttons and press the  button to confirm.

You will see the available categories or the folder content (e.g. other folders). The category selected or the folder name is in the status bar of the display.

- i** The **Music** menu item is not available until the device has been activated.

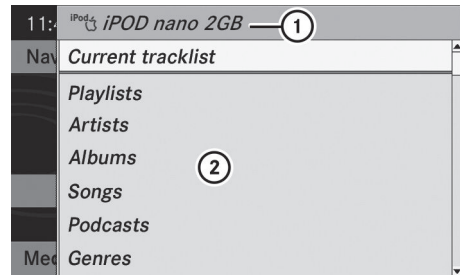



P82.87-2508-31

Example of display: category list

① Device icon and device name

② Selectable categories

- ▶ Select a category/folder using the   buttons and press the  button to confirm.

You will see the content of the selected category or selected folder.

- i** If the data needs to be read from the connected device, the **Please Wait...** message appears.
- ▶ If necessary, repeat this operating step until the tracks in the selected folder/album appear.

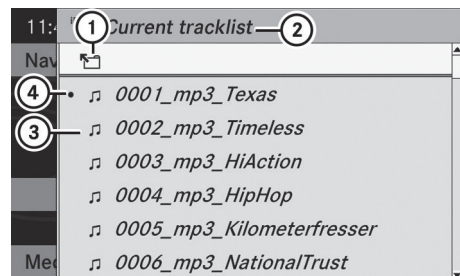

P82.87-2509-31



Example of display: current track list





① Icon for next folder up

② Current category

③ Track icon

④ Current track

- ▶ Select a track using the   buttons and press the  button to confirm. The track is played.

- ▶ **To switch to the superordinate folder:** select the  icon using the   buttons and press the  button to confirm.

**i** The  icon is always listed right at the top of the respective folder.



### Playing the content of a category or folder

- ▶ Select a category or folder.
- ▶ Press the  button for longer than two seconds.  
The content of the category or folder selected is played in accordance with the playback option (▶ page 147) selected.

### Alphabetical track selection

#### iPod® and MP3 player

This function is available for alphabetically sorted categories and folders. This function is not available for albums or playlists, for example.

- ▶ Select a category, e.g. **Artists**.  
The available artists appear.
- ▶ Press the corresponding number key once or several times to select the first letter of the artist's name (e.g. for an artist beginning with the letter "C", press number key  three times).  
You see the available letters at the bottom edge of the display.
- ▶ Press the  button.  
After a message, the first entry in the list which matches the letter entered is highlighted.
- i** If there is no entry which matches the letter which has been entered, the last entry in the list which matches a previous letter is highlighted.
- i** For iPods® and MP3 players, the quality of the search results is highly dependent on the version and language variant of the

software (e.g. iTunes® version) used to populate the device.

### USB mass storage devices

This function is available for alphabetically sorted directories. This function is not available for albums or playlists, for example.

- ▶ In a directory, press the corresponding number key once or several times to select the first letter of the artist's name (e.g. for an artist beginning with the letter "C", press number key  three times).







You see the available letters at the bottom edge of the display.

If the directory only contains folders, COMAND searches for folders. After a message, the first entry found which matches the letters entered appears first in the list.

If there is no entry beginning with the letter entered, the last entry beginning with the previous letter is shown at the top of the list.

### Selecting an active partition (for USB mass storage devices only)

You can select this function for USB mass storage devices when the storage device is partitioned. Up to four partitions (primary or logical and FAT-formatted) are supported.

- i** The Windows formatting program supports FAT partitions of up to 32 GB as standard.
- ▶ Select **Media Int.** in the basic display using the    buttons and press the  button to confirm.
- ▶ Select **Select Active Partition** using the   buttons and press the  button to confirm.

### Playback options

The following options are available to you:

- **Normal Track Sequence**

You hear the tracks in their normal order (numerical or alphabetical, for example).





- **Random Tracks**

All the tracks on the medium are played in random order.



- **Random Categories** or **Random Folder** (in the case of USB devices when **Folder** has been selected):

The tracks in the currently active category or folder, including any sub-folders, are played in random order.

- **i** For USB devices, the random playlists can contain a maximum of 300 randomly selected tracks.

- ▶ **To select a playback option:** select **Media Int.** in the basic display using the    buttons and press the  button to confirm.

The options list appears. The • dot indicates the option selected.

- ▶ Select an option using the   buttons and press the  button to confirm.

### Notes on USB devices

#### Data formats

The following data formats are supported:

- mp3: CBR, VBR (up to 320 kbit/s)
- wma: CBR, VBR (up to 320 kbit/s)

#### Notes on USB devices

- Avoid storing data other than music data on the USB device so that the start-up time is not extended unnecessarily.
- Up to eight directory levels with up to 1000 tracks are supported.

- Do not use a USB extension cable or adapter. These may impair functionality.
- A search of the USB device is performed in the background and any playlists found are provided in a separate category in addition to the folders. Initialization of larger USB mass storage devices containing a high number of files can take up to several minutes.

- **i** Files protected with DRM (Digital Rights Management) are not supported by the Media Interface.

### Audio AUX mode

#### Notes on audio AUX mode





You can connect an external audio source (AUX) to COMAND. The socket for this is located in the glove box.

If COMAND is equipped with a Media Interface, external audio sources are connected using the associated cable set. The audio cable set replaces the audio AUX socket.

- **i** You can find more information on the Internet at <http://www.mercedes-benz.com/connect> and in the "Media Interface mode" section (> page 141).



#### Switching on audio AUX mode



When you connect an external audio source, audio AUX is not selected automatically.

- ▶ Select **Audio** in the main function bar using the    buttons and press the  button to confirm.

If AUX mode was the last mode selected, it will now be active.

If another audio source is switched on, you can now switch to audio AUX mode in the audio menu.

- ▶ Select **Audio** using the  button and press the  button to confirm. The audio menu appears.

- ▶ Select **Aux** using the   buttons and press the  button to confirm. The audio AUX menu appears. You will hear the medium in the external audio source if it is connected and switched to playback.

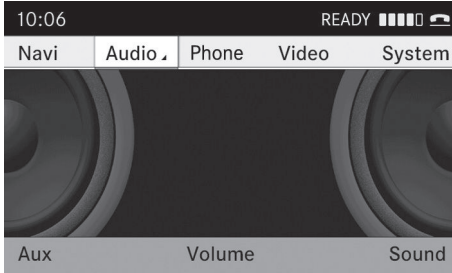

P82.87-3941-31

For operation of the external audio source, please see the corresponding operating instructions.

You will find details on volume (▷ page 27) and sound (▷ page 27) settings in the "At a glance" section.

 **WARNING**

External audio sources may have different volumes, which can mean that system messages such as traffic announcements and navigation system announcements are much louder. If necessary, please deactivate the system messages or adjust their volume manually.

COMAND features .....	150
General information .....	150
Basic settings .....	150
Video DVD mode .....	150
Video AUX mode .....	156



## COMAND features

These Operating Instructions describe all standard and optional equipment available for your COMAND system at the time of purchase. Country-specific deviations are possible. Please note that your COMAND system may not be equipped with all the features described.

## General information

### Automatic picture shutoff

The video picture is only shown when the gear lever is in position "P".

If the gear lever is shifted to a position other than "P", the **In order not to distract you from the traffic situation, the picture is faded out while the vehicle is in motion** message appears.











If you reset the gear lever to "P", the picture will be displayed again.

## Basic settings

### Picture settings









#### Adjusting the brightness, contrast or color

The following describes the video DVD and video AUX modes.

- ▶ Press the  button in video DVD mode and show the menu.
- ▶ Select **DVD-Video** or **AUX** using the    buttons and press the  button to confirm.  
A menu appears.
- ▶ Select **Brightness**, **Contrast** or **Color** using the   buttons and press the  button to confirm.
- ▶ Select a setting using the   buttons and press the  button to confirm.

## Changing the picture format

The following describes the video DVD and video AUX modes.

- ▶ Press the  button in video DVD mode and show the menu.
- ▶ Select **DVD-Video** or **AUX** using the    buttons and press the  button to confirm.  
A menu appears.
- ▶ Select **16:9 Optimized, 4:3** or **Widescreen** using the   buttons and press the  button to confirm.  
The  icon indicates the format currently selected.

## Sound settings

The sound settings can be selected to suit a variety of different video sources. You can call up the respective sound menu from the menu of the desired mode (> page 27).

## Video DVD mode

### Safety notes

#### WARNING

COMAND is classified as a Class 1 laser product. You must not open the casing. If you open the casing, or if the casing is faulty or damaged, there is a risk of exposure to invisible laser radiation. This may damage your eyes, or those of others.

COMAND does not contain any parts that can be serviced by the user. For safety reasons, all maintenance work must be carried out by qualified aftersales technicians.

#### WARNING

Only when the vehicle is stationary should you:

- load a disc
- eject a disc

There is a risk of being distracted from the road and traffic conditions if this is done while the vehicle is in motion.

### Notes about discs

Playback problems may occur when playing copied discs. There are a large variety of discs, DVD authoring software, writing software and writers available. This variety means that there is no guarantee that the system will be able to play discs that you have copied yourself.

**!** Do not affix stickers or labels to the discs, as they could peel off and damage COMAND. Stickers can cause the disc to bend, which can result in read errors and disc recognition problems.

**!** COMAND is designed to accommodate discs which comply with the EN 60908 standard. You can therefore only use discs with a maximum thickness of 1.3 mm. If you insert thicker discs, e.g. those that contain data on both sides (DVD on one side and audio data on the other), they cannot be ejected and can damage COMAND.

Use round discs with a diameter of 12 cm. Do not use discs with a diameter of 8 cm, even with an adapter.

### DVD playback conditions

There are video DVDs available on the market which do not conform to the current standards.

These DVDs can create picture, sound or other problems during playback.

COMAND can play back video DVDs produced according to the following standards:

- region code 1 or region code 0 (no region code)

**i** If you insert a video DVD with a different region code, you will see a message to this effect.

- PAL or NTSC standard

You will generally find the relevant details either on the DVD itself or on the DVD case.

**i** COMAND is set to region code 1 at the factory. This setting can be changed at an authorized Mercedes-Benz Center. This will allow you to play video DVDs with a different region code, provided that they are produced in accordance with the PAL or NTSC standard. The region code can be changed up to five times.

### Function restrictions

Depending on the DVD, it is possible that certain functions or actions will be temporarily blocked or may not function at all. As soon as you try to activate these functions or actions, you will see the  symbol in the display.

### Inserting and removing DVDs

- ▶ Proceed as described in the "Inserting and ejecting CDs and DVDs" section (> page 127).

### Switching to video DVD mode

#### Option 1

- ▶ Insert a video DVD (> page 127). COMAND loads the medium inserted and starts to play it.

#### Option 2







- ▶ Press the  function button. COMAND switches to the disc mode last set (audio CD, audio DVD, MP3 CD, video DVD) or Media Interface. COMAND accesses all discs in the DVD changer.

If you previously selected the video DVD function, it is now switched on.





If you activated a different disc function:

- ▶ Select **Media**.  
The media list appears.
- ▶ Select a video DVD (▷ page 132).

### Option 3

- ▶ Show the menu (▷ page 152).
- ▶ Select **Video** in the main function bar using the    buttons and press the  button to confirm.  
If video DVD mode was the last mode selected, it will now be active.  
If another video source is switched on, you can now switch to DVD mode in the video menu.
- ▶ Select **Video** using the  button and press the  button to confirm.  
The video menu appears.
- ▶ Select **DVD-Video** and press the  button to confirm.

### Hiding/showing the navigation menu

- ▶ **To show:** press the  or  button.
  -  This function is not available while the DVD's own menu (▷ page 154) is being displayed.
  - ▶ **To hide:** press the  or  button.
- or
- ▶ Wait for approximately eight seconds.

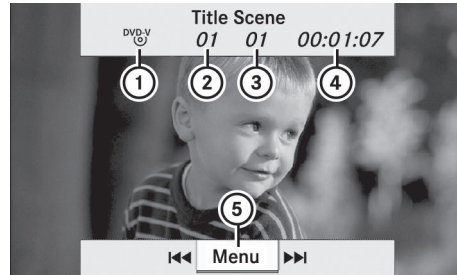





P82.87-2178-31

Navigation menu displayed

- ① Disc type
- ② Current title
- ③ Current scene
- ④ Track time
- ⑤ Shows the menu

### Showing/hiding the menu

This function is not available while the DVD's own menu (▷ page 154) is being displayed.

- ▶ **To show:** press the  button.
- or
- ▶ Select **Menu** while the control menu is shown and press the  button to confirm.
  - ▶ **To hide:** press the  button, select **Full screen** and press the  button to confirm.

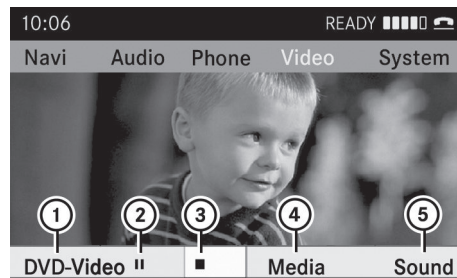

P82.87-2179-31

Menu shown

- ① Video DVD options
- ② Pause function
- ③ Stop function

- ④ Media selection
- ⑤ Sound settings

### Fast forwarding/rewinding

- ▶ Press and hold the ◀ or ▶ button until the desired position is reached.
- or
- ▶ Press and hold the ⏮ or ⏭ button until the desired position is reached. You see the navigation menu.

### Selecting a video DVD

- ▶ Show the menu (▷ page 152).
- ▶ Select **Media** and press the **OK** button to confirm. The media list appears. The ● dot indicates the current medium being played.

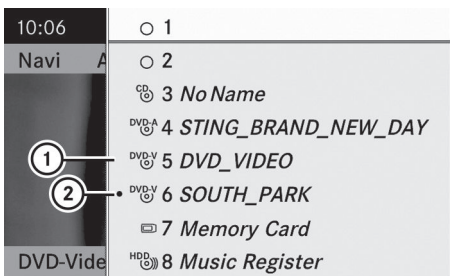

P82.87-2180-31

Media list

- ① Video DVD symbol
  - ② Video DVD currently playing
- ▶ Select a video DVD using the ▲ or ▼ button and press the **OK** button to confirm. COMAND loads the video DVD.
- i** If you select a CD, an audio DVD or an MP3 medium, you switch to the respective audio mode. You can find further information about the media list on (▷ page 129).

### Stop function

- ▶ Show the menu (▷ page 152).
- ▶ **To interrupt playback:** select ■ and press the **OK** button to confirm. The ■ display changes to ▶. The video image is hidden.
- ▶ **To continue playback:** select ▶ and press the **OK** button to confirm. Playback continues from the point where it was interrupted. The menu is hidden.
- ▶ **To stop playback:** while playback is interrupted, select ■ again and press the **OK** button to confirm. Selection is at ▶.
- ▶ **To restart playback:** select ▶ and press the **OK** button to confirm. Playback starts at the beginning of the DVD. The menu is hidden.



### Pause function

- ▶ Show the menu (▷ page 152).
- ▶ **To pause playback:** select ■ and press the **OK** button to confirm. The ■ display changes to ▶.
- ▶ **To continue playback:** select ▶ and press the **OK** button to confirm. The menu is hidden.



### Selecting a scene/chapter

If the film is divided into scenes or chapters, you can select them directly while the film is running, or skip forwards step-by-step. Some DVDs do not permit this at certain points (e.g. during the opening credits).

It may also be possible to select the scene/chapter from within the menu stored on the DVD.

- ▶ **To skip forwards or backwards:** press the  or  button.

or





- ▶ Press the  or  button on the control panel.  
The navigation menu (▷ page 152) appears for approximately eight seconds.

### Selecting a film/title

This function is only available if the DVD is divided into several films/titles.

If the DVD contains several films, these can be selected directly. A film can be selected either when the DVD is being played back or when it is stopped.

The film can also be selected from the menu on the DVD itself.



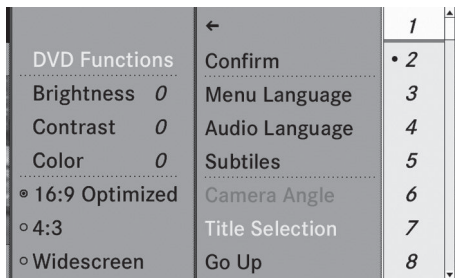

- ▶ Show the menu (▷ page 152).
- ▶ Select **DVD-Video** in the menu using the    buttons and press the  button to confirm.
- ▶ Select **DVD Functions** and press the  button to confirm.

The "DVD functions" menu appears:



P82.87-2181-31

DVD functions menu







- ▶ Select **Title selection** using the   buttons and press the  button to confirm.
- ▶ Select a film/title from the menu and press the  button to confirm.

### DVD menu





#### Calling up the DVD menu

The DVD menu is the menu stored on the DVD itself. It is structured in various ways according to the individual DVD and permits certain actions and settings.

In the case of multi-language DVDs, for example, you can change the DVD language in the DVD menu.

- ▶ Show the menu (▷ page 152).
- ▶ Select **DVD-Video** in the menu using the     buttons and press the  button to confirm.
- ▶ Select **DVD Functions** and press the  button to confirm.
- ▶ Select **Menu** and press the  button to confirm.  
The DVD menu appears.

#### Selecting menu items in the DVD menu

- ▶ Select a menu item using the     buttons and press the  button to confirm.  
The menu appears.

- ▶ **i** Menu items which cannot be selected are shown in gray.

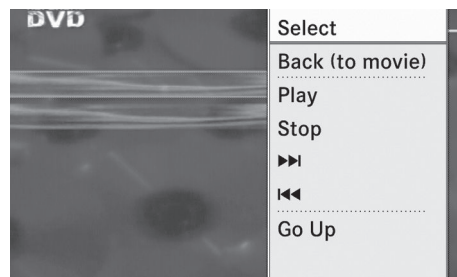











P82.87-2182-31

- ▶ **To reconfirm your selection:** select **Select** and press the  button to confirm.  
COMAND executes the function or shows a submenu.



Make a selection from the further options, if necessary.  
COMAND then switches back to the DVD menu.

- i** Depending on the DVD, the menu items: **Back (to movie)**, **Play**, **Stop**, **◀◀**, **▶▶** or **Go Up** may not function or not function at certain points in the DVD menu. To indicate this, the  symbol appears in the display.

or

- ▶ Show the control menu while in video DVD mode, if necessary.
- ▶ Select **Menu** using the     buttons and press the  button to confirm.
- ▶ Select **DVD-V** in the menu using the     buttons and press the  button to confirm.
- ▶ Select **DVD Functions** and press the  button to confirm.
- ▶ Navigate in the DVD menu using the directional arrows.

### Stopping a film or skipping to the beginning or end of a scene

- ▶ Select any menu item from the DVD menu. The menu appears.
- ▶ **To stop the film:** select the **Stop** menu item and press the  button to confirm.
- ▶ **To skip to the end of a scene:** select the **▶▶** menu item and press the  button to confirm.
- ▶ **To skip to the beginning of a scene:** select the **◀◀** menu item and press the  button to confirm.







### Moving up one level in the DVD menu

- ▶ Press the  back button.

or

- ▶ Select the corresponding menu item in the DVD menu and press the  button to confirm.

or

- ▶ Select any menu item from the DVD menu.
- ▶ Select **DVD-V** in the menu using the     buttons and press the  button to confirm.
- ▶ Select **DVD Functions** and press the  button to confirm.
- ▶ Select **Go up** and press the  button to confirm.

### Back to the film





- ▶ Press the  back button repeatedly until you see the movie.







or

- ▶ Select the corresponding menu item from the DVD menu.
- ▶ Select the **Back (to movie)** menu item in the menu and press the  button to confirm.

### Setting the language and audio format











This function is not available on all DVDs. If it is available, you can set the DVD menu language, the audio language or the audio format. The number of settings is determined by the DVD content. It is possible that the settings may also be accessed in the DVD menu (> page 154).

- ▶ Show the menu (> page 152).
- ▶ Select **DVD-Video** in the menu using the    buttons and press the  button to confirm.
- ▶ Select **DVD Functions** and press the  button to confirm.

- ▶ Select **Menu Language** or **Audio Language** and press the  button to confirm.  
In both cases, a menu appears after a few seconds. The • dot in front of an entry indicates the currently selected language.
- ▶ Select a setting using the   buttons and press the  button to confirm.
- ▶ **To exit the menu:** press the  or  button.

















### Subtitles and camera angle

These functions are not available on all DVDs. The number of subtitle languages and camera angles available depends on the content of the DVD. It is possible that the settings may also be accessed in the DVD menu (▷ page 154).

- ▶ Show the menu (▷ page 152).
- ▶ Select **DVD-Video** in the menu using the    buttons and press the  button to confirm.
- ▶ Select **DVD Functions** and press the  button to confirm.
- ▶ Select **Subtitles** or **Camera Angle** and press the  button to confirm.  
In both cases, a menu appears. The • dot in front of an entry indicates the current setting.
- ▶ Select a setting using the   buttons and press the  button to confirm.
- ▶ **To exit the menu:** press the  or  button.

### Interactive content

DVDs can contain interactive content (e.g. a video game). In a video game, for example, you may be able to influence events by selecting and triggering actions. The type and number of actions depend on the DVD.

- ▶ Select an action using the     buttons and press the  button to execute it.  
A menu appears and the first entry, **Select**, is highlighted.
  - ▶ Press the  button.
- or
- ▶ Show the control menu while in video DVD mode, if necessary.
  - ▶ Select **Menu** using the     buttons and press the  button to confirm.
  - ▶ Select **DVD-V** in the menu using the     buttons and press the  button to confirm.
  - ▶ Select **DVD Functions** and press the  button to confirm.
  - ▶ Select or execute an action using the arrow keys.

## Video AUX mode

### Connecting external video sources

If your vehicle is equipped with a Media Interface, you can connect an external video source.

You require an additional audio/video cable set to connect an external video source to Media Interface.

For details, please consult an authorized Mercedes-Benz Center or visit <http://www.mercedes-benz.com/connect>. and proceed as described under "Media Interface".

The connection jacks are located:

- in the center console stowage compartment (SL)
- in the glove box

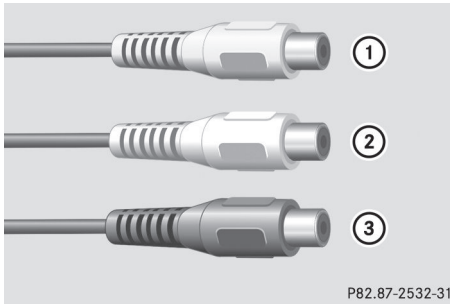

P82.87-2532-31

Audio/video socket

- ① Video port (V)
- ② Audio port (L)
- ③ Audio port (R)

**i** To facilitate correct playback, it may be necessary to set a suitable video standard in the external video source.

- ▶ Connect the external device to corresponding port ①, ② or ③. COMAND activates the device.

### Switching on video AUX mode

- ▶ Select **Video** in the main function bar using the buttons and press the button to confirm.  
If video AUX mode was the last mode selected, it will now be active.  
If another video source is switched on, you can now switch to video AUX mode in the video menu.
- ▶ Select **Video** and press the button to confirm.
- ▶ Select **Aux** and press the button to confirm.  
The video AUX menu appears. You will hear and see the content of the external video source if this is connected and switched to playback.

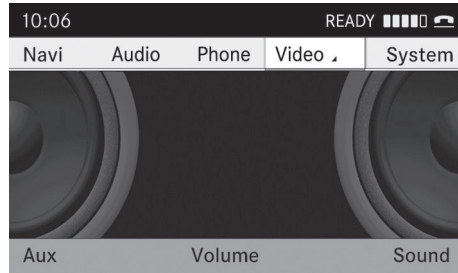

P82.87-3952-31

Video AUX mode

For details on how to operate the external video source, see the respective device's operating instructions.

External video sources may have different audio output volume. You can select two different input volume levels for the AUX connection:

- **Standard**

External sources with a medium to high audio output volume.

- **Boost**

External sources with a low audio output volume.

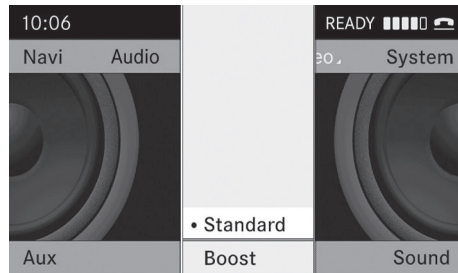

P82.87-3953-31



- ▶ **Setting the desired input volume:**

Select **Volume** using the buttons and press the button to confirm.

- ▶ Select **Standard** or **Boost** and press the button to confirm.



### Showing/hiding the menu

- ▶ **To show:** press the  button.
- ▶ **To hide:** press the  button, select **Full Screen** and press the  button to confirm.

### Volume and sound settings

You will find details on volume (▷ page 27) and sound (▷ page 27) settings in the "At a glance" section.

#### **WARNING**

External video sources may have different volumes, which can mean that system messages such as traffic announcements and navigation system announcements are much louder. If necessary, please deactivate the system messages or adjust their volume manually.

-  It may be the case that a device which is connected as an external video source seems quieter or louder in the vehicle, or that the usual maximum volume cannot be reached. The volume of some devices can be set separately. In this case, start at a medium volume and then raise it slowly. This enables you to hear if the system can play the music without distortion even at high volumes.

COMAND features .....	160
General information .....	160
Basic functions .....	161
System settings .....	163
Audio CD/DVD and MP3 mode .....	164
Video DVD mode .....	169
AUX mode .....	173

### COMAND features

These Operating Instructions describe all standard and optional equipment available for your COMAND system at the time of purchase. Country-specific deviations are possible. Please note that your COMAND system may not be equipped with all the features described.

### General information

#### Changing batteries

#### Notes

Batteries are required for the remote control and for the two sets of cordless headphones.



#### WARNING

Keep the batteries out of the reach of children. Consult a doctor immediately if a child should swallow a battery. Do not dismantle, short-circuit or burn a battery.



#### Environmental note

Dispose of discharged batteries in an environmentally responsible manner.

### On the remote control

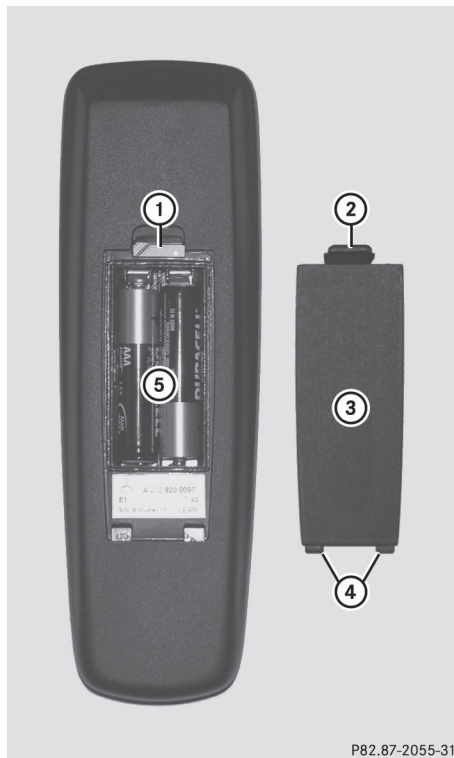

- ① Battery compartment
- ② Catch tab
- ③ Battery compartment cover
- ④ Retaining lugs
- ⑤ Batteries

The remote control contains 2 type AAA, 1.5 V batteries.

- ▶ **To open the battery compartment:** remove battery compartment cover ③ on the back of the remote control.
- ▶ To do so, press down retaining lug ② and take off battery compartment cover ③.
- ▶ Remove discharged batteries ⑤ from the tray.

- ▶ Insert the new batteries. Observe the polarity markings on the batteries and battery compartment when doing so. Left-hand battery: the positive pole (+) must face upwards.  
Right-hand battery: the positive pole (+) must face downwards.
- ▶ **To close the battery compartment:** insert battery compartment cover ③ starting with retaining lugs ④ into the battery compartment and allow catch tab ② to engage in place.

### On the cordless headphones

The battery compartment cover is located on the left headphone.



P82.87-2056-31

- ① Battery compartment cover

The cordless headphones contain 2 type AAA, 1.5 V batteries.

- ▶ **To open the battery compartment:** flip battery compartment cover ① upwards.  
As you do so, hold the left-hand side of the headphones as shown to prevent the batteries from falling out.
- ▶ Remove the discharged batteries from the tray.
- ▶ Insert the new batteries. Observe the polarity markings on the batteries and battery compartment when doing so. Left-hand battery: the positive pole (+) must face upwards.

Right-hand battery: the positive pole (+) must face downwards.

- ▶ **To close the battery compartment:** press battery compartment cover downwards until it engages into place. If the batteries have been inserted correctly, the indicator lamp will light up green when the headphones are switched on.

### Basic functions

#### Using headphones

You can use the cordless headphones supplied and/or up to two sets of corded headphones connected to the corresponding jack of the rear-compartment screens (> page 30).

Information on:

- switching the cordless headphones on/off
- adjusting the volume of the headphones
- selecting a screen for the headphones  
can be found in the Cordless headphones section (> page 32).

#### Using the main loudspeakers







You can use the vehicle loudspeakers to listen to a disc inserted in the rear-compartment drive. To do so, at least one of the rear-compartment screens must be set to disc mode.

- ▶ **To set using COMAND:** press, for example, the **RADIO** function button once or twice to switch on an audio mode.
- ▶ Select **Audio** using the **▲** button and press the **OK** button to confirm.  
The audio menu (> page 21) appears.
- ▶ Select **Rear** using the **▲** **▼** buttons and press the **OK** button to confirm.

- ❗ The headphones' volume setting does not affect the main loudspeakers.

### Adjusting the sound settings

You can select the sound settings in the audio CD/DVD/MP3, TV, video DVD and AUX modes.

- ▶ Switch on an operating mode (e.g. CD mode).
- ▶ Select **Treble** or **Bass** using the    buttons on the remote control and press the  button to confirm. An adjustment scale appears.
- ▶ Select a setting using the   buttons and press the  button to confirm.

### Multiple users

#### Simultaneous use of the rear-compartment disc drive

-  The two rear-compartment screens can be operated almost entirely independently from one another. However, there can be a conflict in some menus if the two screens are used simultaneously.

If the rear-compartment disc drive is being used for both screens simultaneously, selecting certain menus or settings on one of the screens also affects the other screen.

The following functions affect both screens:

- changing playback options
- selecting a track (from a track list or folder)
- using play, pause and stop
- fast forwarding/rewinding or scrolling
- calling up the DVD menu and navigating within it
- setting the language, subtitles and camera angle
- calling up interactive DVD content

The following functions affect only one screen:

- audio and video functions as well as picture settings
- switching between full screen and the screen showing the menu

### Switching between operating modes

When you exit an operating mode (e.g. audio CD mode), the current setting is saved. If you call up this operating mode again later, there are two possibilities:

- the operating mode has been changed on the other screen.
- the operating mode has not been changed.

In the first case, the operating mode appears as it is on the other screen.









In the second case, the setting appears on the screen as it was when you last exited the operating mode.

### Picture settings

#### Overview

You can select these settings in video DVD and AUX mode. Instructions for AUX mode ([▷ page 31](#)).

#### Adjusting the brightness, contrast and color

- ▶ Switch on video DVD mode.
  - ▶ **To show the menu:** press the  button on the remote control.
- or
- ▶ Select **Menu** while the navigation menu ([▷ page 152](#)) is shown and press the  button to confirm.
  - ▶ Select **DVD-Video** using the    buttons and press the  button to confirm.
  - ▶ Select **Brightness, Contrast** or **Color** and press the  button to confirm. An adjustment scale appears.
  - ▶ Select the setting and press the  button to confirm.

### Changing the picture format

- ▶ **To show the menu:** press the **OK** button on the remote control.
- or
- ▶ Select **Menu** while the navigation menu (> page 152) is shown and press the **OK** button to confirm.
- ▶ Select **DVD-Video** using the **▼** **◀** **▶** buttons and press the **OK** button to confirm.  
The **●** icon in front of the **16:9 Optimized, 4:3** or **Widescreen** menu item indicates the format currently set.
- ▶ Select the format and press the **OK** button to confirm.

### System settings

#### Note

You can adjust almost all system settings individually for each screen without affecting the other screen. You make these settings using the remote control (> page 30).

### Selecting the display language

- ▶ Select **System** using the **▲** **◀** **▶** buttons on the remote control and press the **OK** button to confirm.  
You see the system menu on the selected rear screen.

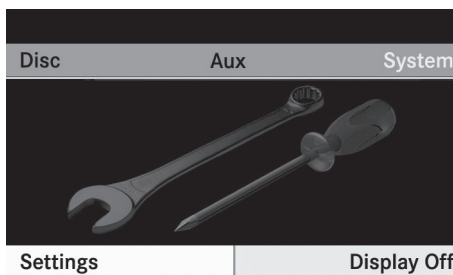

P82.B7-3450-31

System menu

- ▶ Select **Settings** using the **▼** button and press the **OK** button to confirm.
- ▶ Select **Language** using the **▲** **▼** buttons and press the **OK** button to confirm.  
The list of languages appears. The **●** dot indicates the current setting.
- ▶ Select a language using the **▲** **▼** buttons and press the **OK** button to confirm.  
The Rear Seat Entertainment System activates the selected language.



### Switching the display design

- ▶ Select **Settings** in the system menu using the **▼** button and press the **OK** button to confirm.
- ▶ Select **Day Mode, Night Mode** or **Automatic** using the **▲** **▼** buttons and press the **OK** button to confirm.  
The **●** icon indicates the current setting.





Design	Explanation
Day Mode	The display is set permanently to day design.
Night Mode	The display is set permanently to night design.
Automatic	The display design changes depending on the vehicle instrument cluster illumination.

### Setting the brightness

- ▶ Select **Settings** in the system menu using the **▼** button and press the **OK** button to confirm.
- ▶ Select **Brightness** using the **▲** **▼** buttons and press the **OK** button to confirm.  
A scale appears.

- ▶ Adjust the brightness using the   buttons and press the  button to confirm. The brightness bar moves up or down. The picture becomes lighter or darker in accordance with the scale.

#### Showing/hiding the picture

- ▶ **To hide the picture:** select **Display Off** in the system menu using the   buttons and press the  button to confirm. The picture is hidden.
- ▶ **To display the picture:** press the  button.

### Audio CD/DVD and MP3 mode

#### Important safety notes

##### **WARNING**

The CD/DVD drive is a class 1 laser product. Never open the housing. There is a risk of exposure to invisible laser radiation if the housing is opened, or if the casing is faulty or damaged.

The Rear Seat Entertainment System contains no parts which you can repair yourself. For safety reasons, all maintenance work must be carried out by qualified aftersales technicians.

##### **WARNING**

The driver should not wear a Rear Seat Entertainment headset while operating the vehicle under any circumstances. The use of a headset while driving the vehicle could drastically impair the ability to react to audible traffic conditions (e.g. emergency sirens from police/fire/ambulance, another car's horn, etc.).

##### **WARNING**

When not in use, headsets or external video sources should be stored in a safe location (e.g. one of the vehicle's storage

compartments) so that they are not loose within the passenger compartment during braking, vehicle maneuvers or a traffic accident. Objects moving within the passenger compartment could cause serious personal injury to vehicle occupants.

##### **WARNING**

Due to a potential choking hazard, wired headset usage by children should only occur with adult supervision.

#### General notes

You will find information on the following topics in the "Audio" section:

- notes on CDs/DVDs (▷ page 137)
- notes on MP3 mode (▷ page 136)
- notes on copyright (▷ page 137)

#### Inserting a CD/DVD

M-Class: the CD/DVD drive is in the center behind the front seats.

R-Class: the CD/DVD drive is in the center console.

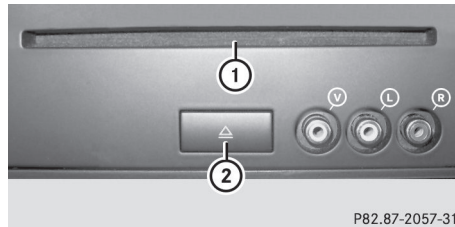

- ① Disc slot
- ② Eject button

The CD/DVD drive is a single disc drive. If there is already a disc inserted, this must be ejected before another is inserted.

- ▶ Insert a disc into the disc slot.  
The printed side of the disc must face upwards. If neither side of the disc is

P82.87-2057-31

printed, the side you wish to play must face downwards.

The CD/DVD drive draws in the disc.

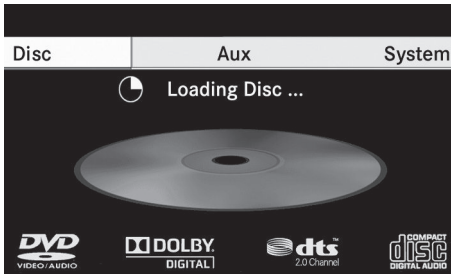

P82.87-3451-31

The CD/DVD drive plays the disc:

- if it has been inserted correctly and is a permissible disc, and
- if you have switched to disc mode (audio CD, audio DVD and MP3 mode) (▷ page 165)

Data on an MP3 CD first needs to be loaded by the drive. Loading may take some time, depending on the number of folders and tracks.

### Removing a CD/DVD

- ▶ Press the eject button. The drive ejects the disc.
- ▶ Take the disc out of the slot. If you do not take the disc out of the slot, the drive will draw it in again automatically after a short while.

### Switching to audio CD, audio DVD or MP3 mode

- ▶ Insert a CD/DVD (▷ page 164). The Rear Seat Entertainment System loads the inserted disc.
- ▶ Select **Disc** in the menu using the buttons on the remote

control and confirm by pressing the button.

The corresponding mode is switched on. The Rear Seat Entertainment System plays the disc.

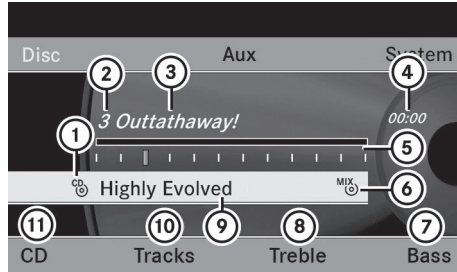

P82.87-3452-31

Example display: audio CD mode

- ① Type of data medium
- ② Track number
- ③ Track name (only if stored on the disc as CD text)
- ④ Track time
- ⑤ Graphic time and track display
- ⑥ Current playback settings (no symbol for "Normal track sequence")
- ⑦ Sets the bass
- ⑧ Sets the treble
- ⑨ Disc name (only if stored on the disc as CD text)
- ⑩ Calls up the track list
- ⑪ Playback options

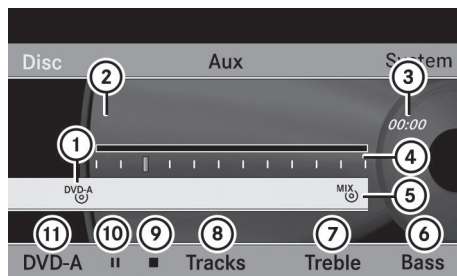

P82.87-3453-31

Example display: audio DVD mode

- ① Type of data medium
- ② Track number



- ③ Track time
- ④ Graphic time and track display
- ⑤ Current playback settings (no symbol for "Normal track sequence")
- ⑥ Sets the bass
- ⑦ Sets the treble
- ⑧ Calls up the track list
- ⑨ Stop function
- ⑩ Pause function
- ⑪ Playback options

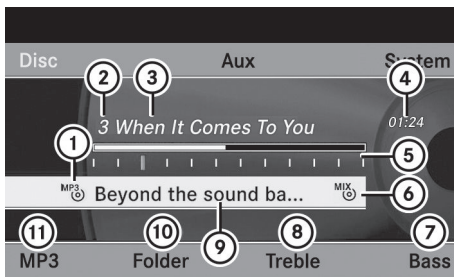

P82.87-2515-31

Example display: MP3 mode

- ① Type of data medium <sup>MP3</sup>
- ② Track number
- ③ Track name
- ④ Track time
- ⑤ Graphic time and track display
- ⑥ Current playback settings (no symbol for "Normal track sequence")
- ⑦ Sets the bass
- ⑧ Sets the treble
- ⑨ Disc name or current folder
- ⑩ Calls up the folder list
- ⑪ Playback options, to switch track information on/off

## Selecting a track

### Selecting by skipping to a track

- ▶ **To skip forwards or backwards to a track:** press the ◀ or ▶ button on the remote control.

or

- ▶ Press the ⏮ or ⏭ button.  
The skip forward function skips to the next track.

Skipping backwards restarts the current track (if it has been playing for more than eight seconds) or starts the previous track (if the current track has only been playing for a shorter time).

If you have selected the playback options [Random Tracks](#) or [Random Folder](#), the track order is random.

### Selecting by track list

In audio CD mode, the track list contains all tracks on the disc currently playing.

In audio DVD mode, the track list contains all tracks in the currently active group; see "Setting the audio format" (> page 168).

In MP3 mode, the track list shows all tracks in the currently active folder as well as the folder structure, allowing you to select any track on the MP3 CD.

- ▶ Select [Tracks](#) (audio CD/DVD mode) or [Folder](#) (MP3 mode) using the ▼ ◀ ▶ buttons on the remote control and confirm by pressing the Ⓞ button.

or

- ▶ Press the Ⓞ button when the display/selection window is selected.  
The track list appears. The • dot indicates the current track.
- ▶ Select a track using the ▲ ▼ buttons and press the Ⓞ button to confirm.

### Making a selection by entering the track number directly

- ▶ Press the button on the remote control.  
The track entry display appears.

Example: track 2

- ▶ Press the number key.

Example: track 12

- ▶ Press the corresponding number keys in rapid succession.
- i** It is not possible to enter numbers that exceed the number of tracks on the CD or in the currently active folder.
- ▶ Wait for approximately three seconds after making an entry.  
You will hear the track which has been entered. The corresponding basic menu then reappears.

### Fast forwarding/rewinding

- ▶ With the display/selection window active, press the or button on the remote control repeatedly until you reach the desired position.

or

- ▶ Press and hold the or button until the desired position is reached.

### Selecting a folder

This function is only available in MP3 mode.

- ▶ Select **Folder** using the , , buttons on the remote control and press the button to confirm.

or

- ▶ Press the button when the display/selection window is selected.  
The folder content appears.

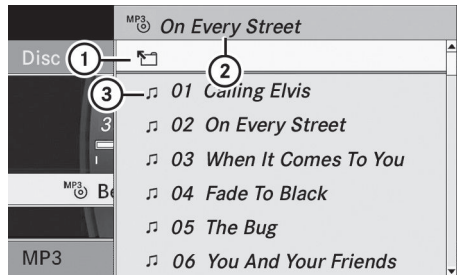

P82.87-2516-31

- ① Folder selection symbol
- ② Current folder name
- ③ Track symbol

- ▶ To switch to the next folder up: select symbol ①.  
The display shows the next folder up.

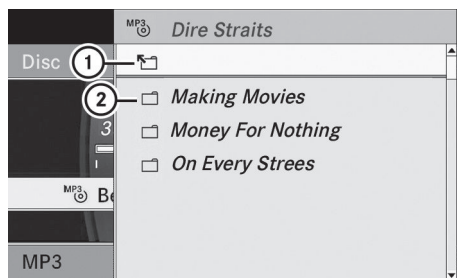











P82.87-2517-31

- ① Folder selection symbol
- ② Folder icon

- ▶ Select a folder using the , buttons and press the button to confirm.  
You will see the tracks in the folder.
- ▶ Select a track using the , buttons and press the button to confirm.  
The track is played and the corresponding folder is now the active folder.















### Pause function

This function is only available in audio DVD mode.

- ▶ **To pause playback:** select  using the    buttons on the remote control and press the  button to confirm. The  display changes to .
- ▶ **To continue playback:** select  and press the  button to confirm. The  display changes to .









### Stop function





This function is only available in audio DVD mode.

- ▶ **To interrupt playback:** select  using the    buttons on the remote control and press the  button to confirm. The  display changes to .
- ▶ **To continue playback:** select  and press the  button to confirm. Playback continues from the point where it was interrupted.
- ▶ **To stop playback:** while playback is interrupted, select  again and press the  button to confirm. Playback stops and returns to the beginning of the DVD.  is highlighted.
- ▶ **To restart playback:** select  and press the  button to confirm. Playback starts from the beginning of the DVD.

### Setting the audio format









Further information on audio formats is available in the "Audio" section (> page 135).

- ▶ Select **DVD-A** using the    buttons on the remote control and press the  button to confirm.
- ▶ Select **Group** using the   buttons and press the  button to confirm. The list of available audio formats appears. The  dot indicates the format currently selected.

- ▶ Select an audio format using the   buttons and press the  button to confirm.
- ▶ To exit the menu: press the  or  button.

### Playback options





Further information on playback options is available in the "Audio" section (> page 135).

- ▶ Select **CD, DVD-A** or **MP3** using the    buttons on the remote control and press the  button to confirm. The options list appears. The  dot indicates the option currently selected.
  - ▶ Select **Normal Track Sequence, Random Tracks** or **Random Folder** using the   buttons and press the  button to confirm. The option is switched on. For all options except **Normal Track Sequence**, you will see a corresponding display in the display/selection window.
- i** If you change the disc, the **Normal Track Sequence** option is activated automatically. If an option is selected, it remains selected after the Rear Seat Entertainment System is switched on or off.

### Switching track information on/off (MP3 mode only)

If the function is switched on, folder and track names are displayed.

If the function is switched off, disc and file names are displayed.

- ▶ Select **Display Track Information** using the   buttons on the remote control and press the  button to confirm. The function is switched on  or off , depending on the previous status.

## Video DVD mode

### General notes

Here you will find further information on the following topics:

- safety notes (▷ page 126)
- notes on CDs/DVDs (▷ page 137)

### DVD playback conditions

Playback problems may occur when playing copied discs. There is a large variety of discs, DVD authoring software, writing software and writers available. This variety means that there is no guarantee that the Rear Seat Entertainment System will be able to play video DVDs that you have copied yourself. You will find further information in the "Video" section (▷ page 151). Information regarding COMAND also applies to the Rear Seat Entertainment System.

### Function restrictions

Depending on the DVD, it is possible that certain functions or actions described in this section will be temporarily blocked or may not function at all. As soon as you try to activate these functions or actions, you will see the  symbol in the display.





### Inserting and removing a CD/DVD

- ▶ Proceed as described in the "Audio CD/ DVD and MP3 mode" section (▷ page 127).

### Switching to video DVD mode

- ▶ Insert a video DVD.  
The Rear Seat Entertainment System loads the disc.  
If disc mode was the last mode selected, it will now be active.





If it was not, switch on video DVD mode as described in the following instruction.

- ▶ Select **Disc** using the    buttons on the remote control and press the  button to confirm.

If the video DVD fulfills the playback criteria, the film either starts automatically or the menu saved on the DVD appears. If the DVD menu appears, you must start the film manually.

- ▶ Select the corresponding menu item in the DVD menu (▷ page 171).

### Hiding/showing the navigation menu

- ▶ **To show:** press the  or  button.
  - ▶ **To hide:** press the  or  button.
- or
- ▶ Wait for approximately eight seconds.



P82.87-3455-31

Navigation menu

- ① Disc type
- ② Current track
- ③ Current scene
- ④ Track time
- ⑤ Shows the menu

### Showing/hiding the menu

- ▶ **To show:** press the **OK** button on the remote control.
- or
- ▶ Select **Menu** while the navigation menu is shown and press the **OK** button to confirm.
- ▶ **To hide:** press the **▲** button, select **Full Screen** and press the **OK** button to confirm.

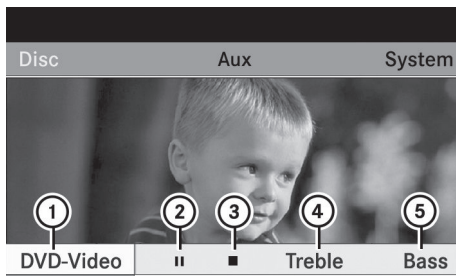

P82.87-3454-31

Menu shown

- ① Video DVD options
- ② Pause function
- ③ Stop function
- ④ To set the treble
- ⑤ To set the bass

### Fast forwarding/rewinding

- ▶ Press and hold the **⏮** or **⏭** button on the remote control until the desired position has been reached. You see the navigation menu.

### Pause function

- ▶ Show the menu (▶ page 170).
- ▶ **To pause playback:** select **II** and press the **OK** button on the remote control to confirm. The **II** display changes to **▶**.

- ▶ **To continue playback:** select **▶** and press the **OK** button to confirm. The menu is hidden.

### Stop function

- ▶ Show the menu (▶ page 170).
- ▶ **To interrupt playback:** select **■** and press the **OK** button on the remote control to confirm. The **■** display changes to **▶**. The video image is hidden.
- ▶ **To continue playback:** select **▶** and press the **OK** button to confirm. Playback continues from the point where it was interrupted. The menu is hidden.
- ▶ **To stop playback:** while playback is interrupted, select **■** again and press the **OK** button to confirm. Playback stops and returns to the beginning of the DVD. **▶** is highlighted.
- ▶ **To restart playback:** select **▶** and press the **OK** button to confirm. Playback starts from the beginning of the DVD.

### Selecting a scene/chapter

#### Note

Further information on this function is available in the "Video" section (▶ page 153).

### Skipping forwards/backwards

- ▶ Press the **◀** or **▶** button on the remote control.
- or
- ▶ Press the **⏮** or **⏭** button. The navigation menu (▶ page 169) appears for approximately eight seconds.

### Selecting a scene/chapter directly

The examples illustrate how to select scene/chapter 5.

- ▶ **Option 1:** while the film is playing, press the **[\*]** button.
  - ▶ Press the corresponding number key, such as **[5<sub>JKL</sub>]**.
  - ▶ **Option 2:** show the menu (▷ page 170).
  - ▶ Select **DVD-Video** and press the **[OK]** button to confirm.
  - ▶ Select **DVD Functions** and press the **[OK]** button to confirm.
  - ▶ Select **Scene Selection** and press the **[OK]** button to confirm.
  - ▶ Select **5** using the **[▲]** or **[▼]** button and press the **[OK]** button to confirm.
- In both cases, playback will begin from the fifth scene/chapter after a brief pause.

### Selecting a film/title

#### Note

Further information on this function is available in the "Video" section (▷ page 154).

#### Option 1

- ▶ Show the menu (▷ page 170).
- ▶ Select **DVD-Video** and press the **[OK]** button on the remote control to confirm.

DVD Functions	Aux	System
Brightness	0	
Contrast	0	
Color	0	
◉ 16:9 Optimized		
○ 4:3		
○ Wide Screen		
	Treble	Bass

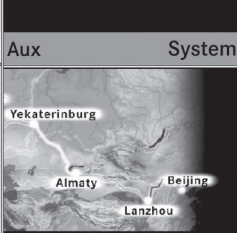

P82.B7-3456-31

- ▶ Select **DVD Functions** and press the **[OK]** button to confirm.
- ▶ Select **Title Selection** and press the **[OK]** button to confirm.
- ▶ To call up the selection list: press the **[OK]** button.
- ▶ Select a film/track.

#### Option 2:

Example: selecting film 2

- ▶ Press the **[2<sub>ABC</sub>]** button.
- After a brief pause, the second film is played.

### DVD menu

#### Note

You will find further information on the DVD menu in the "Video" section (▷ page 154).

### Calling up the DVD menu

- ▶ Show the menu (▷ page 170).
  - ▶ Select **DVD-Video** and press the **[OK]** button on the remote control to confirm.
  - ▶ Select **DVD Functions** and press the **[OK]** button to confirm.
  - ▶ Select **Menu** and press the **[OK]** button to confirm.
- The DVD menu appears.

### Selecting menu items in the DVD menu

- ▶ Select a menu item using the **[▲]**, **[▼]**, **[◀]**, **[▶]** buttons on the remote control and press the **[OK]** button to confirm.
- A menu appears.
- i** Menu items which cannot be selected are shown in gray.



P82.87-2521-31

- ▶ Confirm **Select** by pressing the **OK** button. The Rear Seat Entertainment System carries out the action or displays a submenu for the item selected in the DVD menu.
- ▶ If required, select from the further options. The Rear Seat Entertainment System then switches back to the DVD menu.
- i** Depending on the DVD, the menu items: **Back (to movie)**, **Play**, **Stop**, **⏮**, **⏭** or **Go Up** may not function or not function at certain points in the DVD menu. To indicate this, the **⊘** symbol appears in the display.

### Stopping a film or skipping to the beginning or end of a scene

- ▶ Select any menu item from the DVD menu. The menu appears.
- ▶ **To stop the film:** select the **Stop** menu item and press the **OK** button to confirm.
- ▶ **To skip to the end of a scene:** select the **⏭** menu item and press the **OK** button to confirm.
- ▶ **To skip to the beginning of a scene:** select the **⏮** menu item and press the **OK** button to confirm.

### Moving up one level in the DVD menu

- ▶ **Option 1:** press the **⏪** back button or select the corresponding menu item in the DVD menu.

- ▶ **Option 2:** select any menu item in the DVD menu.
- ▶ Select the **Go Up** menu item in the menu and press the **OK** button to confirm.

### Back to the film

- ▶ **Option 1:** press the **⏪** back button repeatedly until you see the film or select the corresponding menu item in the DVD menu.
- ▶ **Option 2:** select any menu item in the DVD menu.
- ▶ Select the **Back (to movie)** menu item in the menu and press the **OK** button to confirm.

### Setting the audio format

This function is not available on all DVDs. If it is available, you can set the audio language or the audio format. The number of settings is determined by the DVD content. It is possible that the settings may also be accessed from the DVD menu.

- ▶ Show the menu (▷ page 170).
- ▶ Select **DVD-Video** and press the **OK** button on the remote control to confirm.
- ▶ Select **DVD Functions** and press the **OK** button to confirm.
- ▶ Select **Audio Language** and press the **OK** button to confirm.
  - A menu appears after a short while. The
    - dot in front of an entry indicates the currently selected language.
- ▶ Select a language using the **▲** **▼** buttons and press the **OK** button to confirm.
- ▶ **To exit the menu:** press the **⏪** or **⏩** button.

### Subtitles and camera angle

These functions are not available on all DVDs. The number of subtitle languages and camera



angles available depends on the content of the DVD. It is possible that the settings may also be accessed from the DVD menu.

- ▶ Show the menu (▷ page 170).
- ▶ Select **DVD-Video** and press the **OK** button on the remote control to confirm.
- ▶ Select **DVD Functions** and press the **OK** button to confirm.
- ▶ Select **Subtitles** or **Camera Angle** and press the **OK** button to confirm.  
In both cases, a menu appears after a few seconds. The • dot in front of an entry indicates the current setting.
- ▶ Select a setting using the **▲** **▼** buttons and press the **OK** button to confirm.
- ▶ **To exit the menu:** press the **◀** or **▶** button.

### Interactive content

DVDs can also contain interactive content (e.g. a video game). In a video game, you may be able to influence events by selecting and triggering actions. The type and number of actions depend on the DVD.

- ▶ Select an action using the **▲** **▼** **◀** **▶** buttons and press the **OK** button to execute it.  
A menu appears and the first entry, **Select**, is highlighted.
- ▶ Press the **OK** button.

## AUX mode

### Introduction

You can connect one external video source to each of the displays of the Rear Seat Entertainment System (AUX display) and also one external video source to the rear-compartment CD/DVD drive (AUX drive) with a sound and video signal.

Please see the corresponding operating instructions for information on how to operate the external video source.

For further details about external video sources, please consult an authorized Mercedes-Benz Center.

### Connecting AUX equipment

#### AUX drive

The AUX drive jacks are located on the CD/DVD drive on the right next to the CD/DVD eject button (▷ page 31).

#### Displaying AUX

The AUX display jacks are on the side of the screen (▷ page 30).

#### Audio and video connection

- ▶ Insert the audio plugs for the left and right signals into the corresponding **L** and **R** jacks.
- ▶ Insert the video plug into the **V** jack.

### Activating AUX mode

#### AUX drive

- ▶ Select **Aux** in the menu using the **▲** **◀** **▶** buttons on the remote control and press the **OK** button to confirm. The AUX menu appears.

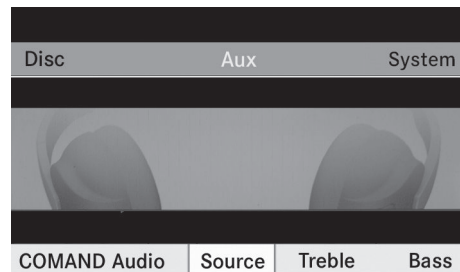

P82.87-2522-31

AUX menu



- ▶ Select **Source** from the AUX menu and press the **OK** button to confirm.
- ▶ Select **Disc Drive Aux** and press the **OK** button to confirm.  
You will hear and see the content of the external video source if it is connected to the CD/DVD drive and switched to playback. If no video image is available from the AUX source connected, you will see an audio menu.

### Displaying AUX

- ▶ Select the screen to which an external video source is connected and which you would like to operate with the remote control (▷ page 31).
- ▶ Select **Aux** in the menu using the **▲** **◀** **▶** buttons on the remote control and press the **OK** button to confirm.
- ▶ Select **Source** from the AUX menu and press the **OK** button to confirm.
- ▶ Select **Display Aux** and press the **OK** button to confirm.  
You will see and hear the content of the video source if it is switched to playback. If no video image is available from the AUX source connected, you will see an audio menu.

### Selecting the active COMAND source

- ▶ Select **Aux** in the menu using the **▲** **◀** **▶** buttons on the remote control and press the **OK** button to confirm.
- ▶ Select **COMAND** from the AUX menu and press the **OK** button to confirm.
- ▶ Select **COMAND Audio** or **COMAND Video** and press the **OK** button to confirm.  
**COMAND audio:** the audio mode selected for COMAND is also selected for the Rear Seat Entertainment System.  
**COMAND video:** COMAND transmits the video image to the Rear Seat Entertainment System.

### Operation with an active COMAND source

You can transfer an audio or video mode selected in COMAND to the Rear Seat Entertainment System.

- i** If you then switch modes in COMAND, the new source will not be transmitted to the Rear Seat Entertainment System.
- ▶ **To switch on the function in COMAND:** switch to the desired audio mode in COMAND or show the menu when in video mode.
- ▶ Select the menu item at the bottom left, e.g. **CD**, using the **▼** **◀** **▶** buttons on the remote control while CD mode is switched on.
- ▶ Select **Active Aud./Vid. Source for the Rear**.

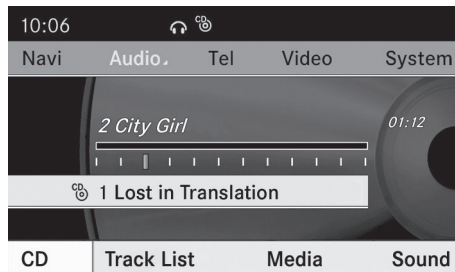

P82.87-2523-31

In the status bar at the top, you will see the headphones icon and the **COMAND** icon for the source that has been switched on.

- ▶ **To switch off the function in COMAND:** switch to the desired audio mode in COMAND or call up the menu system when in video mode.
- ▶ Select the menu item at the bottom left, e.g. **CD**, using the **▼** **◀** **▶** buttons and press the **OK** button to confirm.

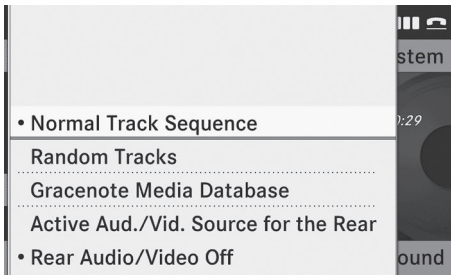

P82.B7-3457-31

- ▶ Select **Rear Audio/Video Off** and press the button to confirm.

### Adjusting the brightness, contrast or color

- ▶ Select **Source** in the AUX menu and press the button on the remote control to confirm.
- ▶ Select **Display Aux** or **Disk Drive Aux** and press the button to confirm.
- ▶ Select **Brightness**, **Contrast** or **Color** and press the button to confirm. An adjustment scale appears.
- ▶ Select a setting using the or button and press the button to confirm.

### Changing the picture format

- ▶ Select **Source** in the AUX menu and press the button on the remote control to confirm.
- ▶ Select **Display Aux** or **Disk Drive Aux** and press the button to confirm.
- ▶ Select **16:9 Optimized**, **4:3** or **Widescreen** using the buttons and press the button to confirm. The icon in front of a menu item indicates the current setting.



COMAND features .....	178
Overview .....	178
Phone .....	181
Navigation .....	183
Address Book .....	191
Radio and Satellite Radio .....	194
DVD Changer .....	198
External Equipment (Aux) .....	199
Command List .....	199
Troubleshooting .....	206

## COMAND features

- i** This manual describes all the standard and optional equipment of your vehicle which was available at the time of purchase. Country-specific differences are possible. Bear in mind that your vehicle may not feature all functions described here. This also refers to safety-related systems and functions.

## Overview

### Operating Safety

#### WARNING

Please devote your attention first and foremost to the traffic situation you are in. While the system permits hands-free phone operation, attention to traffic may be diverted not only by physical operation of a phone, but also by the distraction of a phone conversation while driving. As such, for safety reasons, we encourage the driver to stop the vehicle in a safe place before answering or placing a phone call.

For safety reasons, you should only select a destination when the vehicle is stationary.

While the navigation system provides directional assistance, the driver must remain focused on safe driving behavior, especially pay attention to traffic and street signs, and should utilize the system's audio cues while driving.

The navigation system does not supply any information on stop signs, yield signs, traffic regulations or traffic safety rules. Their observance always remains in the driver's personal responsibility. DVD maps do not cover all areas nor all routes within an area.

Traffic regulations always have priority over any route recommendations given.

Bear in mind that at a speed of just 30 mph (approximately 50 km/h), your vehicle is covering a distance of 44 feet (approximately 14 m) every second.

#### WARNING

Navigation announcements are intended to direct you while driving without diverting your attention from the road and driving.

Please always use this feature instead of consulting the map display for directions. Consulting the symbols or map display for directions may cause you to divert your attention from driving and increase your risk of an accident.

#### WARNING

Please do not use the Voice Control System in an emergency, as the tone of your voice may change in a stressful situation. This could cause a delay in completing your phone call in a timely manner. This could distract you in an emergency situation and cause you to be involved in an accident.

## Symbols Only Used in this Chapter

The following symbols indicate:



that you have to say something



that there is a voice output from the voice control



that the system shows information on the display.

## Usage

You can use the voice control system to operate the following systems depending on the equipment in your vehicle:

- Phone
- Navigation
- Address book
- Audio (radio, satellite radio, DVD changer, memory card, music register)

Say the commands without pausing between individual words. If you enter a command that does not exist or is incorrect, the voice control system asks you for a new command with "Please repeat" or "Please repeat your

entry!”. The voice control confirms important commands to you and gives you instructions in the event of incorrect entries.

### Command Types

Voice control distinguishes between the following types of command:

- **Global commands:**  
These are commands which can be called up at any time (e.g. help or phone commands).
- **Local commands:**  
These are commands which are only available for the active application (e.g. “Enter Street” during navigation).

### Active Application

The local commands refer to the application currently shown on the display and to the audio source you are currently listening to.

For example, if you are listening to the radio while the navigation application is active on the display, you can operate both applications using voice control.

To operate a different function using voice control, you must first switch to that application using the corresponding command.

## Operating Voice Control

### Vehicles with Voice Control Buttons on the Multi-Function Steering Wheel

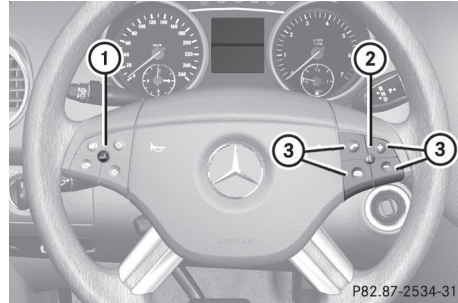

Example display: M-Class

- ① Cancels voice control
- ② Activates voice control
- ③ Decreases the volume
- Increases the volume
- Mute

- ❗ You can cancel the dialog with voice control at any time.

Voice control is operational around half a minute after COMAND is switched on.

### Vehicles with Lever for Voice Control

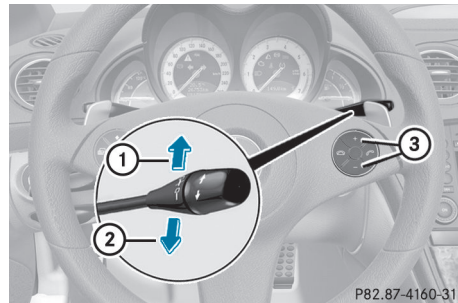

Example display: SL-Class

- ① Cancels voice control
- ② Activates voice control
- ③ Decreases the volume
- Increases the volume

### Starting the Dialog

- ▶ Switch on the ignition (see the vehicle Owner's Manual).
- ▶ **Vehicles with Voice Control buttons on the Multi-function Steering Wheel:** Press the  button.

or

- ▶ **Vehicles with Lever for Voice Control:** Pull the lever toward you  
An acoustic signal confirms that the dialog has been started.
- ▶ Give a command.

### Interrupting the Dialog

If a list appears on the display, you can use the “Pause” command to interrupt the dialog. You can then select an entry using the COMAND control panel.

To resume the dialog with voice control, press the  button on the multifunction steering wheel.

### Canceling the Dialog

- ▶ **Vehicles with Voice Control buttons on the Multi-function Steering Wheel:** Press the  button.

or

- ▶ **Vehicles with Lever for Voice Control:** Push the lever away from you.  
An acoustic signal confirms that the dialog has been canceled.

or



- ▶ Say the command “Cancel” (except when creating and storing voice tags, navigation entries or during individualization).

or

- ▶ Press any button on COMAND.

### Adjusting the Volume

- ▶ Start the dialog.
- ▶ Give a command, e.g. “Help”.

- ▶ Press the  or  button.  
The volume increases or decreases during voice output.

or

- ▶ Set the volume for the voice output on the volume control for COMAND.

### Display Messages

The audible help function can be supplemented by visual help on the display (▷ page 38). If the help function is switched on, the most important commands that are currently possible appear in the display when you start the dialog.

In the address book and navigation system, a selection list is shown in the display if voice control requires additional information from you.

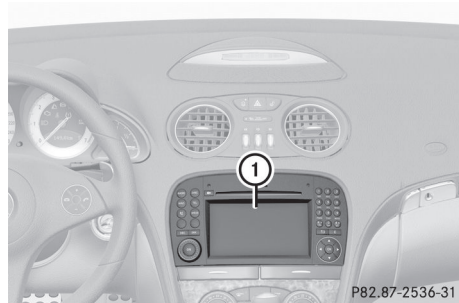

- ① Display

### Entering Numbers

- Digits from “zero” to “nine” are permitted.
- Say the phone number in groups of, e.g., three to five digits.
- Say each individual digit clearly.

### Spell

- The letters of the alphabet and the numbers 0 to 9 are permitted.
- Say the letters in groups of, e.g., five to seven letters.
- Say each individual letter clearly.

- i** Using individualization, you can fine-tune voice control to your own voice and thus improve voice recognition. The process of individualization is described in chapter “System Settings” (> page 38).
- i** If you use individualization, it may impair recognition of other users. Switch off individualization if it makes recognition of other users worse.

## Phone

### WARNING

Some jurisdictions prohibit the driver from using a cellular telephone while driving. Whether or not prohibited by law, for safety reasons, the driver should not use the cellular telephone while the vehicle is in motion. Stop the vehicle in a safe location before placing or answering a call.

If you nonetheless choose to use the mobile phone while driving, please use the handsfree feature and be sure to pay attention to the traffic situation at all times. Use the mobile phone only when road, weather and traffic conditions permit. Otherwise, you may not be able to observe traffic conditions and could endanger yourself and others.

Bear in mind that at a speed of just 30 mph (approximately 50 km/h), your vehicle is covering a distance of 44 feet (approximately 14 m) every second.

### Operation

You can use voice control to:

- place a call by using your voice to input a phone number
- store names and numbers in the address book
- dial a number from the address book
- dial a number from the call list “Latest calls”
- listen to the phone book
- retrieve and manage your voice mail and recorded announcement services
- redial

Voice control recognizes whether:

- your phone is switched on
- your phone is connected via Bluetooth®
- the car phone is registered with the relevant mobile phone network
- it is possible to dial

If it is not possible to dial, voice control issues a message to this effect.

- i** You can still operate your phone using the keypad.

### Commands

#### “Phone”

Use the “Phone” command to select the phone application. Use this command if you wish the digits entered to be shown on the display.

#### “Help Phone”

Voice control has an extensive help function. Using the “Help Phone” command, you can have all the essential commands for the phone read out.

#### “Dial number”

You can use the “Dial number” command to dial a phone number.

The digits 0 to 9 and the word “Plus” are permitted.









“Plus” replaces the international dialing code, e.g. “00”.



Say the phone number in the form of a continuous string of individual digits or as blocks of digits, e.g. three to five digits.

Voice control repeats the digits it recognizes after each block of digits (with a pause of about half a second between each block of digits) and waits for you to continue speaking.



Example of dialog:











-  Dial number
-  Please say the number
-  Zero one three zero
-  Zero one three zero
-  Five zero zero five
-  Five zero zero five
-  Okay
-  Dialing



-  You can also dial the specified number if you press the  button on the multi-function steering wheel instead of the concluding command “Okay”.

### “Confirm”

While you are entering a number, you can use the “Confirm” command to have all the spoken digits repeated by voice control. Voice control will then prompt you to continue with the entry.

Example of dialog:

-  Dial number
-  Please say the number
-  Zero one three zero
-  Zero one three zero
-  Confirm
-  Zero one three zero. Please continue.
-  Five zero zero five
-  Five zero zero five
-  Okay
-  Dialing













-  You can also dial the specified number if you press the  button on the multi-function steering wheel instead of the concluding command “Okay”.

### “Correction”

While you are entering a number, you can use the “Correction” command to correct the block of digits last spoken. When you input this command, voice control deletes the last

block of digits and repeats the digits input up to this point. Voice control will then prompt you to continue with the entry.













Example of dialog:

-  Dial number
-  Please say the number
-  Zero one three zero
-  Zero one three zero
-  Five zero zero five
-  Five zero zero five
-  Correction
-  Zero one three zero. Please continue
-  Five zero zero five
-  Five zero zero five
-  Okay
-  Dialing

### “Delete”

While you are entering a number, you can use the “Delete” command to delete all the digits which have been entered. After you have input this command, voice control prompts you to enter additional digits or commands.

Example of dialog:

-  Dial number
-  Please say the number
-  Zero one three zero
-  Zero one three zero
-  Five zero zero five
-  Five zero zero five
-  Delete
-  Number deleted, please say the number again:
-  Zero three seven three
-  Zero three seven three
-  Three nine one
-  Three nine one
-  Okay
-  Dialing

**“Save Name” (Address Book)**

“Save Name” (Address Book) functional description (> page 192)

**“Dial Name” (Address Book)**

“Dial Name” (Address Book) functional description (> page 193)

**“Delete Name” (Address Book)**

“Delete Name” (Address Book) functional description (> page 193)

**“Find Name” (Address Book)**

“Find Name” (Address Book) functional description (> page 193)

**“List Phone Book” and Dialing a Phone Number**

You can use the “List phone book” command to listen to all entries in the phone book in which a phone number is also stored and, if required, select an entry. If the list contains more than 30 entries, the system asks you to say the name from which the reading shall be started.

Example of dialog:



List phone book

The system reads out all the address book entries with phone numbers. If there is more than one phone number for an entry, voice control queries this.



Do you want to make a work call or a home call?



Home call

To cancel the dialog:

► **Vehicles with Voice Control buttons on the Multi-function Steering Wheel:** Press the button.

► **Vehicles with Lever for Voice Control:** Push the Voice Control lever away from you. You have canceled the dialog. The system confirms by responding “Cancel”.

**“Redial”**

You can use the “Redial” command to redial the number most recently called.

**Managing Announcement Services or Voice Mail**

You can also use voice control to manage your voice mail or recorded announcement services.

While a phone call is in progress:

► **Vehicles with Voice Control buttons on the Multi-function Steering Wheel:** Press the button while a phone call is in progress.

or

► **Vehicles with Lever for Voice Control:** Pull the Voice Control lever toward you. An acoustic signal confirms that the system is activated.

► Say the required digits (“zero” to “nine”).

or

► Say the required words “Star” or “Hash”.

► Say the concluding command “Okay”. The system dials the number entered.

**Navigation****⚠ WARNING**

For safety reasons, you should only select a destination when the vehicle is stationary. While the navigation system provides directional assistance, the driver must remain

focused on safe driving behavior, especially pay attention to traffic and street signs, and should utilize the system's audio cues while driving.

The navigation system does not supply any information on stop signs, yield signs, traffic regulations or traffic safety rules. Their observance always remains in the driver's personal responsibility. DVD maps do not cover all areas nor all routes within an area.

Traffic regulations always have priority over any route recommendations given. Bear in mind that at a speed of just 30 mph (approximately 50 km/h), your vehicle is covering a distance of 44 feet (approximately 14 m) every second.

During route guidance, you will not receive information on:

- traffic lights
- stop and yield signs
- parking or stopping zones
- one-way streets
- narrow bridges
- other traffic regulation data

You should therefore always strictly observe traffic regulations while driving. Drive carefully and always obey traffic laws and road signs, even if they contradict navigation system instructions.

#### WARNING

Navigation announcements are intended to direct you while driving without diverting your attention from the road and driving.

Please always use this feature instead of consulting the map display for directions. Consulting the symbols or map display for directions may cause you to divert your attention from driving and increase your risk of an accident.

#### WARNING

Please do not use the Voice Control System in an emergency, as the tone of your voice may change in a stressful situation. This could

cause a delay in completing your phone call in a timely manner. This could distract you in an emergency situation and cause you to be involved in an accident.

### Operation

You can use voice control to:

- enter a state
- enter a province
- enter a city
- enter a district (center)
- enter a street
- enter an intersection
- enter a house number
- enter an entire address
- enter a zip code
- find address
- enter a point of interest
- select one of your previous destinations
- call up route information
- store a destination
- display the map
- enlarge/reduce the size of the map
- listen to the destination memory
- start and stop route guidance
- switch the guidance instructions on and off

To select the navigation application:

- ▶ **Vehicles with Voice Control buttons on the Multi-function Steering Wheel:** Press the  button.

or

- ▶ **Vehicles with Lever for Voice Control:** Pull the Voice Control lever toward you.

- ▶ Give the “Navigation” command.
  - ▶ **Vehicles with Voice Control buttons on the Multi-function Steering Wheel:** Press the  button.
- or
- ▶ **Vehicles with Lever for Voice Control:** Pull the Voice Control lever toward you.
  - ▶ Give one of the navigation commands explained below.

### Commands

You cannot start the route guidance until all the necessary address data has been entered.

### “Help Navigation”/“Help”

Using the “Help navigation” command, you can have all the essential commands for the navigation system read out.

### Entering an Address





-  If voice control fails to recognize your entry, it is advisable to spell the name of the town and street. Spell names of towns and streets when abroad.

The system guides you completely through the dialog to route guidance. As soon as a valid address is entered (at least the town), you can use the “Start route guidance” command to start the route guidance.









### “Enter state”/“Enter province”

You can use the “Enter state”/“Enter province” command to change the state or province setting of the navigation system.

Example of dialog:

-  Enter state
-  Please say the name of the state.
-  New York
-  The system shows a numbered list of possible state names on the display. If

there is only one entry on the list, voice control asks if it is correct.















-  Please select a line number or say continue
-  Number 1
-  Number 1 accepted.
-  Do you want to enter a destination?
-  No
-  Do you want to save the state?
-  Yes
-  Saving state

### “Enter Destination”









You can use the “Enter destination” command to enter a complete address.

The system guides you through the whole dialog. As soon as a valid address is entered (at least the town), you can use the “Start route guidance” command to start the route guidance.

Example of dialog:

-  Enter destination
-  Pre-selected state is New York. Do you want to enter town first or street first?
-  Town
-  Please say the name of the town
-  Albany
-  The system shows a numbered list of possible city names on the display. If there is only one entry on the list, voice control asks if it is correct.
-  Please select a line number or say continue
-  Number 1
-  Number 1 accepted.
-  Do you want to enter a street?
-  Yes
-  Please say a New York street name
-  Park Avenue
-  The system shows a numbered list of possible street names on the display.

If there is only one entry on the list, voice control asks if it is correct.



-  Please select a line number or say continue
-  Number 1
-  Number 1 accepted.
-  Do you want to enter a house number?
-  No
-  Do you want to start route guidance?
-  Yes
-  Starting route guidance

The system starts route guidance.









If you give one of the following commands, the system guides you through the dialog to route guidance.





### “Enter Town”

You can use the “Enter town” command to enter any town in the state or province that is currently selected.

-  If the city you require does not appear in the list or the system fails to recognize the name of the town, it can be entered by using the “Spell town” command.
-  You can use the “Next page” or “Previous page” commands to scroll through the list. You can use the “Correction” command to enter the name of the town again.

Example of dialog:

-  Enter town
-  Please say the name of the town
-  Albany
-  The system shows a numbered list of possible town names on the display. If there is only one entry on the list, voice control asks if it is correct.
-  Please select a line number or say continue
-  Number 1
-  Number 1 accepted.
-  Do you want to enter a street?
-  No

-  Do you want to start route guidance?
-  No
-  Do you want to save the destination?
-  No
-  Cancel

The town is stored for route guidance.

### “Spell town”

Using the “Spell town” command, you can spell any town. This may be necessary if certain town or street names are not recognized.















Say the letters in the form of a continuous string of letters. In the case of long names, it is not always necessary to spell the whole name. Usually only the first five to seven letters are required.

A list of city names will appear in the display and you can choose the one you require.

Say each individual letter clearly.

It is not easy to avoid confusion of similar-sounding letters (e.g. D and E).

Example of dialog:

-  Spell town
-  Please spell a New York town name
-  F-R-E-N-S
-  The system shows a numbered list of city names on the display. If there is only one entry on the list, voice control asks if it is correct.
-  Please select a line number or say continue
-  Number 3
-  Number 3 accepted.
-  Do you want to enter a street?
-  No
-  Do you want to start route guidance?
-  No
-  Do you want to save the destination?
-  No
-  Cancel















The town is stored for route guidance.

- i** You can use the “Next page” or “Previous page” commands to scroll through the list. You can use the “Correction” command to spell the town again from the beginning.
- i** Note that the list in the display is sorted according to the probability of voice recognition.

### “Enter District” (Center)

You can use the “Enter district” command to enter an area in a city which you have selected previously.

Example of dialog:

-  Enter district
-  Please say the name of the district.
-  Manhattan
-  The system shows a numbered list of districts in the display if the selected city has more than one district.
-  Please select a line number or say continue
-  Number 1
-  Number 1 accepted.
-  Do you want to enter a street?
-  No
-  Do you want to start route guidance?
-  No
-  Do you want to save the destination?
-  No
-  Cancel

















The district is stored for route guidance.

### “Enter Street”

You can use the “Enter Street” command to enter the name of any street in the selected city.

- i** If only a few streets are stored for a selected town, they will be displayed for selection immediately after you give the “Enter Street” command.

Example of dialog:

-  Enter Street
-  Same town?
-  Yes
-  Please say a New York street name
-  Mabel’s Street
-  The system shows a numbered list of street names on the display. If there is only one entry on the list, voice control asks if it is correct.
-  Please select a line number or say continue
-  Number 3
-  Number 3 accepted
-  Do you want to enter a house number?
-  No
-  Do you want to start route guidance?
-  No
-  Do you want to save the destination?
-  No
-  Cancel

The street name is stored for route guidance.

### “Correction”







If you have entered or spelled a city or street, you can use the “Correction” command to enter the city or street again or spell it from the beginning.







### “Intersection”

You can use the “Intersection” command to specify an intersection of two streets.

#### No street has been entered yet

Example of dialog:









-  Intersection
-  Please say the name of the first street
-  Main street
-  Please select a line number or say continue
-  Number 1
-  Number 1 accepted

-  Please say the name of the intersecting street
-  Mable street
-  Please select a line number or say continue
-  Number 4
-  Number 4 accepted
-  Do you want to start route guidance?
-  Yes

The route guidance to the specified intersection is started.

### A street has already been entered

Example of dialog:







-  Intersection
-  Please say the name of the intersecting street
-  Mable street
-  Please select a line number or say continue
-  Number 4
-  Number 4 accepted
-  Do you want to start route guidance?
-  Yes



The route guidance to the specified intersection is started.

### In connection with the "Enter Destination" dialog

-  You can enter an intersection instead of a house number in the "Enter Destination" dialog.

Example of dialog (continues "Enter Destination" dialog):

-  Do want to enter a house number?
-  Intersection
-  Please say the name of the intersecting street
-  Mable street
-  Please select a line number or say continue
-  Number 4
-  Number 4 accepted







-  Do you want to start route guidance?
-  Yes

The route guidance to the specified intersection is started.

### "House Number"

You can use the "House number" command to specify the house number for the selected street in individual digits.

Example of dialog:

-  House number
-  Please say the house number in single digits
-  Three four
-  Three four
-  Okay
-  Do you want to start route guidance?
-  Yes









The route guidance to the specified house number is started.







-  You can use the "minus" command to express compound house numbers, e.g. 23-25.

### "Points of interest" (POI)

You can use the "Points of interest" command to select specific destinations (gas stations, airports, stations, etc.).



Example of dialog:

-  Points of interest
-  The system shows the following list in the display:
-  Please select a line number or say continue
-  Number 1
-  Number 1 accepted.
-  The system shows a numbered list of POI categories
-  Please select a line number or say the POI name
-  Number 5

-  The system shows a numbered list with destinations from the selected category
-  Please select a line number or say continue
-  Number 1
-  Number 1 accepted.
-  Do you want to start route guidance?
-  Yes

The route guidance for the selected point of interest is started.

or

-  No
-  Do you want to save the destination?
-  Yes

The dialog continues as shown in the section “Save destination”.

-  Depending on the selected area, other lists may be shown.







You can only select points of interest in the state or province the navigation system is set for.

### Selecting next point of interest

You can use the following commands to select nearby points of interest:



- “Next gas station”
- “Next car park”
- “Next Mercedes-Benz Service”
- “Next restaurant”
- “Next hospital”

Example of dialog:

-  Next gas station
-  The system shows a numbered list of gas stations on the display
-  Please select a line number or say continue
-  Number 1
-  Number 1 accepted. Do you want to start route guidance?
-  Yes

The route guidance for this point of interest is started.

or







-  No
-  Do you want to save the destination?
-  Yes

The dialog continues as shown in the section “Save destination”.

### “Last Destinations”

You can use the “Last destinations” command to reselect a destination from a list of the previously selected destinations.

Example of dialog:

-  Last destinations
-  The system shows a numbered list of the previously selected destinations. If there is only one entry on the list, voice control asks if it is correct.
-  Please select a line number or say continue
-  Number 1
-  Number 1 accepted. Do you want to start route guidance?
-  Yes





The route guidance for this destination is started.

### “Save Destination”



You can use the “Save destination” command to save the current destination in the address book by means of a voice tag.

-  If the desired voice tag already exists in the address book, the system asks if you want to add the address.

Example of dialog:

-  Save destination
-  Please say the name.
-  Smith
-  Please repeat the name.
-  Smith











-  Where do you want to save: home or work?
-  Work
-  The destination has been saved.

### “Find Address”

---

You can use the “Find address” command to select a previously saved address and start route guidance. Say the name of an address exactly as you have entered it into the address book, e.g. if you entered first name and last name, you have to say both.



Example of dialog:

-  Find address
-  Please say the name
-  Smith
-  The system shows a numbered list of saved addresses in the display. If there is only one entry on the list, voice control asks if it is correct.
-  Please select a line number or say the name
-  Number 1
-  Number 1 accepted, Smith work
-  Starting route guidance

### “Start Route Guidance”

---

When Route Guidance is inactive, you can use the “Start route guidance” command to start route guidance once a valid destination has been entered.

-  Start route guidance
-  Starting route guidance

### “Route Information”

---

You can use the “Route information” command to have the following information on your currently planned route read out:

- Distance to destination/stopover
- Expected arrival time
- Remaining driving time

### “Guidance Instructions On”

---

When you use the “Guidance instructions on” command, voice control repeats the last driving tip. If the driving tip output has been switched off up to this point, it is now switched on again.

### “Guidance Instructions Off”

---





You can use this command to switch off the route guidance voice output.

### “Cancel Route Guidance”

---



You can use this command to stop route guidance.

Example of dialog:

-  Cancel route guidance
-  Are you sure you want to cancel route guidance?
-  Yes
-  Canceling route guidance

Voice control cancels route guidance.

or

-  No
-  Continuing route guidance.

The dialog with voice control is terminated. Route guidance remains activated.

### “Zoom In”/“Zoom Out”

---

You can use these commands to zoom the map display one step in or out.

### “Zoom In Completely”/“Zoom Out Completely”

---

You can use these commands to set the map display directly to the smallest or largest scale.

### “List Destination Memory”

---

You can use the “List destination memory” command to listen to the entries from the address book’s destination memory and, if required, navigate to one of them. If the list

contains more than 30 entries, the system asks you to say the name from which the reading shall be started.

Example of dialog:



List destination memory

The system reads out all entries, from the address book destination memory.

To select an entry and set an address:

► **Vehicles with Voice Control buttons on the Multi-function Steering Wheel:**

Press the button at the selected entry.

or

► **Vehicles with Lever for Voice Control:**

Pull the Voice Control lever toward you at the selected entry.

If there is more than one address, the system asks



Do you want to navigate to Smith home or work?



Home



Smith home. Starting route guidance

The system starts route guidance.

**To cancel the dialog:**

► **Vehicles with Voice Control buttons on the Multi-function Steering Wheel:**

Press the button.

or

► **Vehicles with Lever for Voice Control:**

Push the Voice Control lever away from you.

You have canceled the dialog. The system confirms by responding “Cancel”.

## Address Book



### WARNING

Please devote your attention first and foremost to the traffic situation you are in.

Before your journey, please familiarize yourself with the address book functions.

Only use the Voice Control System when road and traffic conditions permit you to do so. Otherwise you could be involved in an accident in which you or others could be injured.

## Overview

The address book gives you the option of storing information about people in the form of entries.

Using voice control, you can dial a phone number stored in the address book or start route guidance for a stored address.

Apart from the speaker-dependent voice tags stored in the address book, voice control can recognize all the entries in the name fields of the address book. Recognition of the entries in the address book depends on the text that was entered. To make a call you must say the text of the entry.

Check the address book entries for the following:

- The name entries, e.g. last name and first name, are in the right fields.
- Do not use abbreviations or acronyms.
- Avoid unnecessary spaces in names.
- Do not use special characters.

You can improve voice recognition by saving a speaker-dependent voice tag for address book entries.

Use a speaker-dependent voice tag:

- for names which are difficult to pronounce
- to distinguish names which sound similar
- for names which are not pronounced as they are written

Voice control can store up to 50 of these address book entries by means of a speaker-dependent voice tag.

### Operation

You can use voice control at any time to:

- save a name
- select a name
- delete a name
- list the address book
- delete the address book
- open the address book
- open an entry from the address book
- list the phone book
- list the destination memory

To open the address book:

- ▶ **Vehicles with Voice Control buttons on the Multi-function Steering Wheel:** Press the  button.

or

- ▶ **Vehicles with Lever for Voice Control:** Pull the Voice Control lever toward you.
- ▶ Give the “Address book” command.
- ▶ **Vehicles with Voice Control buttons on the Multi-function Steering Wheel:** Press the  button.

or

- ▶ **Vehicles with Lever for Voice Control:** Pull the Voice Control lever toward you.
- ▶ Give one of the address book commands explained below.

### Commands

#### “Address Book”

- ▶ **To open the address book:** Say the command “Address book”.

#### “Help Address Book”

- ▶ Using the “Help address book” command, you can have all the essential commands for the address book read out.

### “Save Name”

Use the “Save name” command to save a phone number with a voice tag for a specific speaker. Use this command for a name which is complicated or which is pronounced differently as it is spelled, for example, because it is a foreign name. When you have given the command “Save Name”, voice control prompts you to enter a phone number.

**i** This function is only possible if a mobile phone is connected to COMAND.

The digits 0 to 9 and the word “Plus” are permitted.











“Plus” replaces the international dialing code, e.g. “00”.

Say the phone number in the form of a continuous string of digits or as blocks of digits, e.g. three to five digits.

Voice control repeats the digits it recognizes after each block of digits (with a pause of about half a second between each block of digits) and waits for you to continue speaking.

When you have given the command “Okay”, voice control prompts you two or three times to say the name. When repeating the name, make sure that you pronounce it in exactly the same way as you did the first time. Otherwise, the name cannot be saved and voice control aborts the saving procedure.

Example of dialog:

-  Save name
-  Please say the number
-  Zero one three zero
-  Zero one three zero
-  Five zero zero five
-  Five zero zero five
-  Okay
-  Please say the name.
-  Smith
-  Please repeat the name.
-  Smith

 Do you want to save the number in a category?

 No

 Name and number saved

### “Dial Name”

You can use the “Dial name” command to place a call by selecting a name from your address book. You can choose either a voice tag or say a name entry.

Only say the surname if only the surname is entered in the address book.

Say the surname first and then the first name if both are entered in the address book.

Example of dialog:

 Dial name

 Please say the name

 Smith

If there is more than one phone number for an entry, voice control queries this:

 Which number do you want to dial?  
Home or work, landline, mobile or car?  
or

Please select a line number

 Work

 Smith work, landline. Dialing.

### “Find Name”

Use the “Find name” command to search for a name in the address book. Voice control then asks what action you want it to perform: for example call the selected number, start route guidance to the saved address or open the entry.

### “Find Address”

(▷ page 190)

### “Delete Name”

Use the “Delete name” command to delete a voice tag from your address book.

Example of dialog:

 Delete name

 Please say the name

 Smith

 Do you want to delete Smith?

 Yes

 The entry has been deleted

### “List Address Book”

You can use the “List address book” command to listen to all names and voice tags in the address book. You can select an entry during this.

If no name is entered in the name field of the address book, the phone number or the address is read out. A name can be entered later in the name field.

Example of dialog:

 List address book

The system reads out all address book entries. If there is a large number of entries, the system asks from which entry it should start the reading.

 If you do not say a name, voice control reads out all address book entries.

**To select an address book entry:**

► **Vehicles with Voice Control buttons on the Multi-function Steering Wheel:**

Press the  button at the selected entry.

or

► **Vehicles with Lever for Voice Control:**

Pull the Voice Control lever toward you.

The entry is selected and shown on the display.

Voice control asks whether the selected entry should be called, navigated

to or opened.

► **To select an address book entry:**

Press the  button at the selected entry.

The entry is selected and shown on the display.

Voice control asks whether the

selected entry should be called, navigated to or opened.

#### To cancel the dialog:

##### ► Vehicles with Voice Control buttons on the Multi-function Steering Wheel:

Press the  button.

or

##### ► Vehicles with Lever for Voice Control:

Push the Voice Control lever away from you. You have cancelled the dialog. The system confirms by responding “Cancel”.

#### “List Phone Book” and Dialing a Phone Number

(▷ page 183)







#### “Delete Address Book”

You can use the “Delete address book” command to delete individual voice tags or all the voice tags in the address book. The address data is not deleted.

#### “Open Entry”

You can use the “Open entry” command to open any address book entry.

Example of dialog:

-  Open entry
-  Please say the name
-  Smith
-  The system shows a numbered list in the display.
-  Please select a line number or say continue.
-  Number 1 ...
-  Number 1 accepted.  
The system opens the first entry on the list.

If the selected entry contains at least one phone number or an address, voice control asks whether you want to dial the number or navigate to the stored address.







#### “Spell Entry”

You can use the “Spell entry” command to open any address book entry by spelling the name.

Say the letters in the form of a continuous string of letters (e.g. five to seven letters).

A list of possible entries will appear in the display and you can choose the one you require.

Example of dialog:

-  Spell entry
-  Please spell the name.
-  S-M-I-T-H
-  The system shows a numbered list in the display.
-  Please select a line number or say continue.
-  Number four
-  Number four accepted

The system opens the fourth entry on the list.

If the selected entry contains at least one phone number or an address, voice control asks whether you want to dial the number or navigate to the stored address.

-  You can use the “Next page” or “Previous page” commands to scroll through the list. You can use the “Correction” command to spell the name again.

#### Radio and Satellite Radio

##### WARNING

Please devote your attention first and foremost to the traffic situation you are in.

Before your journey, please familiarize yourself with the radio functions.

Only use the Voice Control System when road and traffic conditions permit you to do so. Otherwise you could be involved in an

accident in which you or others could be injured.

## Operation

You can use voice control to:

- select the waveband
- find a station
- select a frequency (FM, AM)
- select a category (Satellite radio)
- listen to the station list
- save a voice tag for a station
- delete a station list (voice tags only)
- delete a station (voice tag only)
- select a channel number (Satellite radio)

The names of all received and stored stations are available for voice recognition. To improve voice recognition, you can store a voice tag for a specific speaker.

### To select the radio or satellite radio application:

- ▶ **Vehicles with Voice Control buttons on the Multi-function Steering Wheel:** Press the  button on the multifunction steering wheel.

or

- ▶ **Vehicles with Lever for Voice Control:** Pull the Voice Control lever toward you
- ▶ Say the command “Radio” or “Satellite Radio”.
- ▶ **Vehicles with Voice Control buttons on the Multi-function Steering Wheel:** Press the  button on the multifunction steering wheel.

or

- ▶ **Vehicles with Lever for Voice Control:** Pull the Voice Control lever toward you
- ▶ Say one of the Radio or Satellite radio commands explained below.

## Commands

You can always give the commands for the radio when you are listening to the radio, even if a different application is shown on the display.

### “Help Radio”

Using the “Help Radio” command, you can have all the commands for the radio read out.

### “Help Satellite Radio”

Using the “Help Satellite Radio” command, you can have all the commands for the satellite radio read out.

### Selecting a Waveband

You can set the waveband with the following commands:

- “FM”
- “AM”

### “Next Station”/“Previous Station”

You can start manual tuning and set the next station using the following commands:

- “Next station”
- “Previous station”

### “Next Category”/“Previous Category”

You can use the following commands to change the category on satellite radio:

- “Next category”
- “Previous category”

### Selecting the Frequency (FM Range)

You can select frequencies within the FM range (87.7 to 107.9 MHz) directly. Voice control also recognizes the words “frequency”, “point” and “megahertz”.

Example of dialog:



 Eighty seven point nine megahertz

 Voice control sets the frequency.

### Selecting the Frequency (AM Range)

You can select frequencies within the AM range (530 to 1710 kHz) directly. Voice control also recognizes the words “frequency” and “kilohertz”.

Example of dialog:







-  Five hundred and thirty kilohertz
-  Voice control sets the frequency.

### “Save Station”

Using the “Save station” command you can give a voice tag to the station currently selected. You can also use this command to improve voice recognition for difficult names or if you want to use a name of your own. You could, for example, save a station with the name 'Favorite station'.

When you have given the command, voice control prompts up to three times to say the station name. When repeating the station name, make sure that you pronounce it in exactly the same way as you did the first time. Otherwise, the name cannot be saved and voice control aborts the saving procedure.





Example of dialog:

-  Save station
-  Please say the station name
-  Favorite station
-  Please repeat the station name.
-  Favorite station
-  The station 'Favorite station' has been saved.

### “Select Station”

Using the “Select station” command, you can select a station.



Example of dialog:

-  Select station
-  Please say the station name
-  Favorite station
-  Voice control sets the station

### “Station 'Favorite Station”

Using this command, you can select a saved station.





Example of dialog:

-  Favorite station
-  Voice control sets the station 'Favorite station'

### “Select Category” (Satellite radio)

Using the “Select category” command, you can select an available category.



Example of dialog:

-  Select category
-  Please say the category name
-  News
-  Voice control sets the category

### “Category News” (Satellite Radio)

Use this command to select a satellite radio category.

Example of dialog:

-  Category news
-  Voice control sets the category

### “Enter Channel Number” (Satellite Radio)

Use the command “Enter channel number” to select a satellite radio category.

### “List Station List” and “Selecting a Station”

Using the “List station list” command, you can hear a list of all receivable stations and choose one from your station list.

-  If voice control does not recognize the station name, have the list of stations read out. This allows you to check whether you have saved the station you require in the station list.

Example of dialog:

 List station list

The system reads out the station list.

If the station you require is read out:

▶ **Vehicles with Voice Control buttons on the Multi-function Steering Wheel:** Press the  button.

or

▶ **Vehicles with Lever for Voice Control:**  
Pull the Voice Control lever toward you.  
The system sets the corresponding frequency.

**To cancel the dialog:**

▶ **Vehicles with Voice Control buttons on the Multi-function Steering Wheel:** Press the  button.

or

▶ **Vehicles with Lever for Voice Control:**  
Push the Voice Control lever away from you.  
You have canceled the dialog. The system confirms by responding “Cancel”.

### “Delete Station”

You can use the “Delete station” command to delete a voice tag for a station from your station list.

Example of dialog:

 Delete station

 Which station do you want to delete?

 Favorite station

 Do you want to delete 'Favorite station'?

 Yes

 Station deleted.

### “Delete Station List”

You can use the “Delete station list” command to delete all voice tags or individual ones from your station list.

Example of dialog:

 Delete station list

 Do you want to delete all voice names from the station list?

 Yes

 Do you really want to delete the whole list?

 Yes

 All voice names have been deleted from the station list

The system permanently deletes all voice names in the station list.

or

 No

The system reads out the list of stations.

When the system reads out the stations to be deleted:

▶ **Vehicles with Voice Control buttons on the Multi-function Steering Wheel:** Press the  button.

or

▶ **Vehicles with Lever for Voice Control:**  
Pull the Voice Control lever toward you.  
The station to be deleted is selected. The system reads out the selected station again.

 Do you want to delete 'Favorite station'?

 Yes

 Station deleted

 The system deletes the station and reads out the remaining entries in the station list.

or

 No

The system continues to read out the list of stations.



## DVD Changer

### WARNING

Please devote your attention first and foremost to the traffic situation you are in.

Before your journey, please familiarize yourself with the disc functions.

Only use the Voice Control System when road and traffic conditions permit you to do so. Otherwise you could be involved in an accident in which you or others could be injured.

### Operation

You can use voice control to:

- select a CD/DVD
- select a track
- select a directory in MP3 operation
- select a group in Audio DVD operation

**i** On the command “Next/previous CD/DVD”, the DVD changer changes from one CD/ DVD to the next, skipping any empty compartments. If you select an empty compartment with the “CD/DVD 1 to CD/DVD 6” command, the current compartment remains selected and the system responds with “No audio CD”.

#### To select the CD application:

▶ **Vehicles with Voice Control buttons on the Multi-function Steering Wheel:** Press the  button.

or

▶ **Vehicles with Lever for Voice Control:** Pull the Voice Control lever toward you.

▶ Say one of the following commands:

- “CD player/CD changer”
- “DVD audio”

- “DVD video”
- “MP3”

▶ **Vehicles with Voice Control buttons on the Multi-function Steering Wheel:** Press the  button.

or

▶ **Vehicles with Lever for Voice Control:** Pull the Voice Control lever toward you.

▶ Give one of the CD or DVD commands explained below.

### Commands

#### “Help CD”/“Help DVD”/“Help MP3”

With the commands:

- “Help CD”
- “Help DVD audio”
- “Help DVD video”
- “Help MP3”

you can have all the commands for the CD, DVD or MP3 read out.

#### “Next CD/DVD”

With the “Next CD”/“Next DVD” commands, you can select the next audio CD/ DVD from your DVD changer.

#### “Track 1” to “Track 99”

With the “Track 1” to “Track 99” commands, you can select a track number from the inserted CD/DVD.

#### “Next Track”

You can use the “Next track” command to select the next track.

#### “Previous Track”

With the “Previous track” or “Repeat track” commands, you can have the track just played repeated. If the command is spoken as the first few seconds of the track are played, the previous track is selected.

**“Group 1” to “Group 9”**

With the “Group 1” to “Group 9” commands, you can select a group on an inserted audio DVD.

**“Next Group”/“Previous Group”**

With the “Next group”/“Previous group” commands, you can select the next or previous group on the inserted audio DVD.

**“Next Folder”/“Previous Folder”**

With the “Next folder”/“Previous folder” commands, you can select a folder on the inserted CD/DVD in MP3 mode.

**“Memory Card”**

With the “Memory card” command, you can switch to the SD card on the COMAND system.

**“DVD Video”**

With the “DVD video” command, you can start a video DVD on the COMAND system.

**“Hard Disk”**

With the “Hard disk” command, you can change to the internal hard disk (Music Register) of COMAND.

**External Equipment (Aux)**

**"Audio Aux"**

You can use the "Audio Aux" command to activate the Aux input.

**Command List**

In the Command list section, you will find all the main commands for operating voice control. The commands available to you depend on the vehicle’s equipment.

**i** Some functions have several voice commands to facilitate operation. These are grouped together between the separator lines in the list and can be used interchangeably.

Some commands are enclosed in angular brackets <>. This signifies that the enclosed command is a voice name, which you can determine yourself and attach to address book entries, radio stations, program categories etc.

**General Commands**

- Yes
- Correct
- Okay
- Cancel
- No
- Pause
- Address book
- MP3
- CD changer
- CD
- Navigation
- Route guidance
- Nav
- DVD video
- DVD audio
- Radio
- Satellite radio / Sirius
- Phone
- Messages
- Video

## Voice Control

- Correction
- Wrong
- Incorrect

- Help

- Help functions
- Help devices

- Help voice control [system]
- Help voice control/voice control help
- General help

- 0 – 9 (Numbers)

- a – z (Letters of the alphabet)

- Continue
- Go forward
- Next page

- Previous page
- Go back
- Back

- Help radio

- Help phone/help telephone

- Help address book

- Help CD changer

- Help DVD
- Help DVD changer

- Help DVD audio
- Help DVD audio changer

- Help MP3
- Help MP3 changer

- Help navigation
- Help route guidance
- Help nav

## Phone Commands

- Phone
- Telephone on/phone on

- Save
- Save name
- Save number
- Save phone number

- Dial number
- Dial phone number

- Confirm
- Confirm number
- Confirm phone number

- List phone book
- Read out phone book

- Redial
- Redial last number
- Redial last phone number

- Correction
- Incorrect
- Wrong number
- Wrong phone number

- Delete
- Delete name
- Delete phone number

## Navigation Commands

- Navigation
- Route guidance
- Nav

- Guidance/ route guidance instructions on
- Switch guidance/ route guidance instructions on
- Listen to guidance/ route guidance instructions

- Guidance/ route guidance instructions off
- Switch off guidance/ route guidance instructions
- Mute guidance/ route guidance instructions

- House number
- Enter house number

- Map
- Show map
- Map on/switch on map

- Zoom in
- Zoom in on map

- Zoom out
- Zoom out of map

- Zoom out completely

- Zoom in completely

- Enter state
- Change state
- Enter province
- Change province
- Enter destination area
- Another state

- Last destinations

- Enter town
- Enter name of town

- Spell town
- Spell name of town

- District
- Enter district
- Center
- Enter center

- Spell district
- Spell center

- Point(s) of interest/POI(s)
- Enter point(s) of interest/POI(s)

- Street
- Enter street
- Name of street
- Enter name of street

- Intersection
- Enter intersection

- Spell street
- Spell name of street

- Enter destination

- Save destination
- Save address

- Start route guidance/routing/ destination guidance
- Begin route guidance
- Begin destination guidance
- Continue route guidance/destination guidance

- Cancel route guidance/navigation/ nav/destination guidance
- Exit route guidance/navigation/ nav/ destination guidance
- Stop route guidance/navigation/ nav/ destination guidance
- Terminate route guidance/navigation/ nav/destination guidance

- Next gas station

- Next Mercedes-Benz Service
- Next workshop
- Next MB service

- Next hospital

- Next car park

- Next restaurant

**Address Book Commands**

- Address book
- List address book
- Read out/play address book
- Delete address book
- Spell entry
- Spell name
- Find entry
- Delete name
- List destination memory
- Read out/play destination memory
- **i** Commands enclosed in angular brackets <> are voice names, which you can determine yourself and attach to address book entries.
- <voice name>
- <voice name> car
- <voice name> car phone
- <voice name> landline
- <voice name> landline phone
- <voice name> mobile
- <voice name> mobile phone
- <voice name> phone
- <voice name> work
- <voice name> home
- Work
- Office
- Company/business
- Car
- Car phone
- Landline
- Landline phone
- Mobile
- Mobile phone

- Work car
- Work car phone
- Car phone work/office/business/company
- Work/office/business/company/landline
- Work/office/business/company/landline telephone/phone
- Landline telephone/phone work/office/business/company
- Work/office/business/company/mobile
- Work/office/business/company/phone
- Mobile phone work/office/business/company
- Home
- Home car
- Home car phone
- Car phone home
- Home landline
- Home landline telephone/phone
- Landline telephone/phone home
- Home mobile
- Home mobile phone
- Mobile phone home
- Dial name
- Save name
- Save number
- Save telephone/phone number
- Accept
- Accept name
- Accept phone number
- Okay
- Finished
- <1> - <6>
- Select 1 - select 6
- Number 1 - number 6

**Audio and Video Commands**

- Audio

**Radio**

- Radio on
- 87.7 megahertz - 107.9 megahertz
- 87 point 7 to 107 point 9
- 87 point 7 megahertz to 107 point 9 megahertz
- Frequency 87.7 to frequency 107.9
- Frequency 87 point 7 to frequency 107 point 9
- Frequency 87 point 7 megahertz to frequency 107 point 9 megahertz
- FM
- AM
- Weatherband
- Next station
- Other station
- Station search
- Station <station name>
- Delete station
- Save station
- Select station
- List station list
- Read out station list
- Delete station list
- Previous station
- Last station

**Satellite Radio (SIRIUS XM)**

- Satellite Radio on/SIRIUS on
- Next station
- Other channel
- Channel <channel name>
- Delete channel
- Save channel
- Select channel
- List channel list
- Read out channel list
- Delete channel list
- Last channel
- Previous station
- Next category
- Previous category
- Category <category name>
- Select category
- List category list
- Read out category list
- Previous category
- Last category

**CD Changer**

- CD changer
- Next CD
- Other CD
- Previous CD
- Last CD
- Next track
- Other track

- Previous track
- Last track
- Repeat/replay track
- CD 1 to CD 6
- CD number 1 to CD number 6
- Track 1 to Track 99
- Track number 1 to Track number 99

**MP3**

- MP3
- MP3 changer (on)
- Next MP3
- Other MP3
- Previous MP3
- Last MP3
- Repeat/replay MP3
- Next directory
- Other directory
- Previous directory
- Last directory
- Next track
- Other track
- Previous track
- Last track
- Repeat/replay track
- Track 1 to Track 99
- Track number 1 to Track number 99
- MP3 1 to MP3 6
- MP3 number 1 to MP3 number 99

**Hard Disk**

- Hard disk
- Music register

**Memory Card**

- Memory card

**DVD Audio**

- DVD audio
- DVD audio changer on
- Next DVD audio
- Other DVD audio
- Previous DVD audio
- Last DVD audio
- Next directory
- Other directory
- Previous directory
- Last directory
- Next group
- Other group
- Previous group
- Last group
- Group 1 to 9
- Group number 1 to 9
- Next track
- Other track
- Previous track
- Last track
- Repeat/replay track
- Track 1 to Track 99
- Track number 1 to Track number 99
- DVD audio 1 to DVD audio 6
- DVD audio number 1 to DVD audio number 6

**Aux**

Audio Aux

**Video**



- Video
- DVD video



## Troubleshooting

### Troubleshooting Table

Problem	Possible Cause/ Consequence	Suggested Solutions
Voice control does not understand you.	You have not operated the system from the driver's seat.	▶ Only operate the system from the driver's seat.
	You have spoken too exaggeratedly, too loudly or too quietly.	▶ State the commands coherently and clearly without exaggerating.
	A blower is set to its highest setting or there is wind noise through an open window.	▶ Prevent loud noises from interfering.
An address book entry without a speaker-dependent voice tag is not recognized.	The fields in the address book entry for the last name and first name are both filled in, but you only said the first name or the last name.	▶ Say the last name and then the first name of the address book entry in full.
	The names entered in the address book do not sound sufficiently different, or are not pronounced as they are written.	▶ Make sure the address book entries are plausible. Check the address book entries for the following: <ul style="list-style-type: none"> <li>• The name entries, e.g. last name and first name, are in the right fields.</li> <li>• Do not use abbreviations or acronyms.</li> <li>• Avoid unnecessary spaces in names.</li> <li>• Do not use special characters.</li> </ul>

Problem	Possible Cause/Consequence	Suggested Solutions
<p>An address book entry without a speaker-dependent voice tag is not recognized.</p>	<p>The names entered in the address book do not sound sufficiently different, or are not pronounced as they are written.</p>	<ul style="list-style-type: none"> <li>▶ Create a speaker-dependent voice tag.</li> <li>or</li> <li>▶ Give the “List address book” command. The system reads out the address book.</li> <li>▶ <b>Vehicles with Voice Control buttons on the Multi-function Steering Wheel:</b> Press the  button when the name you want is read out.</li> <li>or</li> <li>▶ <b>Vehicles with Lever for Voice Control:</b> Pull the Voice Control lever toward you</li> </ul>
	<p>The sound of the voice tags in the address book is not sufficiently different.</p>	<ul style="list-style-type: none"> <li>▶ The voice tags entered in the address book must sound as different as possible, e.g. store the names White and Wright as “Mr White office” and “Mr Wright John”.</li> <li>or</li> <li>▶ Give the “List address book” command. The system reads out the address book.</li> <li>▶ <b>Vehicles with Voice Control buttons on the Multi-function Steering Wheel:</b> Press the  button when the name you want is read out.</li> <li>or</li> <li>▶ <b>Vehicles with Lever for Voice Control:</b> Pull the Voice Control lever toward you</li> </ul>



Problem	Possible Cause/ Consequence	Suggested Solutions
A station list entry is not recognized.	The voice tags for the stations in the address book do not sound sufficiently different.	<ul style="list-style-type: none"> <li>▶ Save a speaker-dependent voice tag for the station (▷ page 192).</li> <li>or</li> <li>▶ Give the “List station list” command. The system reads out the station list.</li> <li>▶ <b>Vehicles with Voice Control buttons on the Multi-function Steering Wheel:</b> Press the  button when the station you want is read out.</li> <li>or</li> <li>▶ <b>Vehicles with Lever for Voice Control:</b> Pull the Voice Control lever toward you. The station is selected (▷ page 196).</li> </ul>
If you are making speaker-dependent voice tags, the system prompts you to enter them several times.	The two voice tags differ from each other.	<ul style="list-style-type: none"> <li>▶ Say the voice tag with the same intonation both times.</li> </ul>

### Help Function

Voice control has a comprehensive help function to assist the user.

The voice control help function provides:

- general information about how best to operate voice control
- a list of the possible commands

#### “Help Voice Control”

You can use the “Help Voice Control” command to obtain information about how best to operate voice control.

#### “Help”







If you press the  button and say the command “Help”, you will receive help for the application currently selected.

If you select the “Help” command during a voice dialog, for example after the “Dial number” command, you will receive help explaining how the dialog continues.

You can also request the help function for a specific system, for example with the “Help phone” command.

If you have activated the help window, you will see a selection of the possible commands on the display (▷ page 38).

## Symbols

-  Warning
-  Environmental note
-  Possible damage to the vehicle
-  Tip
-  Instruction
-  Continuation symbol
-  Page reference
- Display** Displays in the multifunction display/COMAND

## Publication details

### Internet

Further information on Mercedes-Benz vehicles and Daimler AG can be found on the Internet at the following websites:

<http://www.mercedes-benz.com>

<http://www.daimler.com>

### Editorial office

You are welcome to forward any queries or suggestions you may have about the Operator's Manual to the technical documentation team at the following address:

Daimler AG, HPC: R822, D-70546 Stuttgart, Germany

Not to be reprinted, translated or otherwise reproduced, in whole or in part, without written permission from Daimler AG.



# COMAND

## Operating Instructions

COMAND Operating Instructions



2515845682

Order no. 6515 6927 13 Part no. 251 584 56 82 Edition Edition A 2012



Mercedes-Benz