



M-Class

Operator's Manual



Mercedes-Benz

Symbols

Registered trademarks:

- Bluetooth® is a registered trademark of Bluetooth SIG Inc.
- DTS is a registered trademark of DTS, Inc.
- Dolby and MLP are registered trademarks of DOLBY Laboratories.
- BabySmart™, ESP® and PRE-SAFE® are registered trademarks of Daimler AG.
- HomeLink® is a registered trademark of Prince.
- iPod® and iTunes® are registered trademarks of Apple Inc.
- Logic7® is a registered trademark of Harman International Industries.
- Microsoft® and Windows media® are registered trademarks of Microsoft Corporation.
- SIRIUS is a registered trademark of Sirius XM radio Inc.
- HD Radio is a registered trademark of iBiquity Digital Corporation.
- Gracenote® is a registered trademark of Gracenote, Inc.
- ZAGATSurvey® and related brands are registered trademarks of ZagatSurvey, LLC.

In this Operator's Manual, you will find the following symbols:

WARNING

Warning notes draw your attention to hazards that endanger your health or life, or the health or life of others.

Environmental note

Environmental notes provide you with information on environmentally aware actions or disposal.

 Notes on material damage alert you to dangers that could lead to damage to your vehicle.

 Practical tips or further information that could be helpful to you.

▶ This symbol indicates an instruction that must be followed.

▶ Several of these symbols in succession indicate an instruction with several steps.

(▷ page) This symbol tells you where you can find more information about a topic.

▷▷ This symbol indicates a warning or an instruction that is continued on the next page.

Display This font indicates a display in the multifunction display/COMAND display.

Parts of the software in the vehicle are protected by copyright © 2005 The FreeType Project <http://www.freetype.org>. All rights reserved.

Publication details

Internet

Further information about Mercedes-Benz vehicles and about Daimler AG can be found on the following websites

<http://www.mbusa.com> (USA only)

<http://www.mercedes-benz.ca> (Canada only)

Editorial office

You are welcome to forward any queries or suggestions you may have regarding this Operator's Manual to the technical documentation team at the following address:

Daimler AG, HPC: CAC, Customer Service,
70546 Stuttgart, Germany

©Daimler AG: Not to be reprinted, translated or otherwise reproduced, in whole or in part, without written permission of Daimler AG.

Welcome to the world of Mercedes-Benz

Before you first drive off, read this Operator's Manual carefully and familiarize yourself with your vehicle. For your own safety and a longer vehicle life, follow the instructions and warning notices in this manual. Disregarding them may lead to damage to the vehicle or personal injury.

Vehicle damage resulting from the disregard of the instructions is not covered by the Mercedes-Benz Limited Warranty.

The equipment or model designation of your vehicle may differ according to:

- model
- order
- country variant
- availability

Mercedes-Benz therefore reserves the right to introduce changes in the following areas:

- design
- equipment
- technical features

Therefore, descriptions may vary from those of your own vehicle.

The following are integral components of the vehicle:

- Operator's Manual
- Maintenance Booklet
- Equipment-dependent supplements

Keep printed copies of the documents in the vehicle at all times. If you sell the vehicle, always pass the documents on to the new owner.

The technical documentation team at Daimler AG wishes you safe and pleasant motoring.

Mercedes-Benz USA, LLC

Mercedes-Benz Canada, Inc.

A Daimler Company

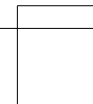
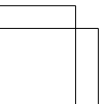
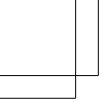

Index 4

Introduction 23

At a glance 31

Safety 41

Opening and closing 77

Seats, steering wheel and mirrors .. 101

Lights and windshield wipers 119

Climate control 137

Driving and parking 155

On-board computer and displays 261

Stowage and features 331

Maintenance and care 363

Breakdown assistance 379

Wheels and tires 397

Technical data 441

1, 2, 3 ...

| | |
|--|-----|
| 115 V socket | 348 |
| 12 V socket | |
| see Sockets | |
| 360° camera | |
| Function/notes | 225 |
| 4ETS | |
| see ETS/4ETS (Electronic Traction System) | |
| 4MATIC (permanent four-wheel drive) | 246 |

A

| | |
|--|-----|
| ABS (Anti-lock Braking System) | |
| Display message | 283 |
| Function/notes | 66 |
| Important safety notes | 66 |
| Warning lamp | 319 |
| Activating/deactivating cooling with air dehumidification | 145 |
| Active Blind Spot Assist | |
| Activating/deactivating (on- board computer) | 273 |
| Display message | 306 |
| Function/information | 237 |
| Trailer towing | 240 |
| Active Curve System | |
| Display message | 303 |
| Function/notes | 209 |
| Active Driving Assistance package . | 237 |
| Active Lane Keeping Assist | |
| Activating/deactivating (on- board computer) | 273 |
| Display message | 306 |
| Function/information | 241 |
| Trailer towing | 243 |
| Active light function | 125 |
| Active Parking Assist | |
| Display message | 307 |
| Function/notes | 218 |
| Important safety notes | 217 |
| Towing a trailer | 221 |
| ADAPTIVE BRAKE | 73 |
| Adaptive Brake Assist | |
| Display message | 290 |
| Function/notes | 69 |

Adaptive Damping System

 see ADS (Adaptive Damping System)

Adaptive Highbeam Assist

| | |
|---|-----|
| Display message | 298 |
| Function/notes | 125 |
| Switching on/off (on-board computer) | 275 |

Additives (engine oil)**ADS (Adaptive Damping System)**

| | |
|----------------------|-----|
| Function/notes | 209 |
|----------------------|-----|

Air bags

| | |
|--|-----|
| Display message | 294 |
| Front air bag (driver, front passenger) | 46 |
| Important safety notes | 44 |
| Knee bag | 47 |
| PASSENGER AIR BAG OFF indicator lamp | 48 |
| Safety guidelines | 43 |
| Side impact air bag | 47 |
| Window curtain air bag | 48 |

Air-conditioning system

 see Climate control

Air filter (display message)**AIR FLOW****AIRMATIC package**

| | |
|-----------------------------------|-----|
| ADS (Adaptive Damping System) ... | 209 |
| Function/notes | 209 |
| Level control | 210 |

Air vents

| | |
|------------------------------------|-----|
| Glove box | 152 |
| Important safety notes | 151 |
| Rear | 152 |
| Setting | 151 |
| Setting the center air vents | 151 |
| Setting the side air vents | 152 |
| see Climate control | |

Alarm system

 see ATA (Anti-Theft Alarm system)

Ambient lighting

| | |
|---|-----|
| Setting the brightness (on-board computer) | 275 |
| Setting the color (on-board computer) | 275 |

AMG adaptive sport suspension**system****AMG menu (on-board computer)**

- Anti-lock braking system**
 - see ABS (Anti-lock Braking System)
- Anti-theft alarm system**
 - see ATA (Anti-Theft Alarm system)
- Approach/departure angle** 190
- Ashtray** 346
- Assistance menu (on-board computer)** 272
- ASSYST PLUS**
 - Displaying a service message 369
 - Hiding a service message 369
 - Notes 368
 - Resetting the service interval display 369
 - Service message 368
 - Special service requirements 369
- ATA (Anti-Theft Alarm system)**
 - Activating/deactivating 75
 - Function 75
 - Switching off the alarm 75
- ATTENTION ASSIST**
 - Activating/deactivating 273
 - Display message 302
 - Function/notes 230
- Audio menu (on-board computer)** 269
- Audio system**
 - see separate operating instructions
- Authorized Centers**
 - see Qualified specialist workshop
- Authorized Mercedes-Benz Center**
 - see Qualified specialist workshop
- Authorized workshops**
 - see Qualified specialist workshop
- AUTO lights**
 - Display message 298
 - see Lights
- Automatic engine start (ECO start/stop function)** 162
- Automatic engine switch-off (ECO start/stop function)** 162
- Automatic headlamp mode** 120
- Automatic transmission**
 - Automatic drive program 169
 - Changing gear 168
 - DIRECT SELECT lever 165
 - Display message 312
 - Drive program display 165
 - Driving tips 168
 - Emergency running mode 173
 - Engaging drive position 167
 - Engaging neutral 166
 - Engaging park position automatically 166
 - Engaging reverse gear 166
 - Engaging the park position 165
 - Kickdown 168
 - Manual drive program 171
 - Overview 165
 - Problem (malfunction) 173
 - Program selector button 169
 - Pulling away 160
 - Shift ranges 170
 - Starting the engine 159
 - Steering wheel paddle shifters 169
 - Trailer towing 168
 - Transmission position display 165
 - Transmission positions 167
- Automatic transmission emergency mode** 173
- Axle load, permissible (trailer towing)** 455

B

- Bag hook** 337
- Ball coupling**
 - Installing 255
 - Removing 259
 - Storing 260
- BAS (Brake Assist System)** 67
- BAS PLUS (Brake Assist System PLUS)** 67
- Battery (SmartKey)**
 - Checking 81
 - Important safety notes 81
 - Replacing 81
- Battery (vehicle)**
 - Charging 387
 - Display message 300
 - Important safety notes 385
 - Jump starting 389
 - Overview 385
- Blind Spot Assist**
 - Activating/deactivating 273
 - Display message 306

- Notes/function 233
 - Trailer towing 235
 - see Active Blind Spot Assist
 - BlueTEC**
 - Adding DEF 177
 - BlueTEC (DEF)** 448
 - Brake Assist**
 - see BAS (Brake Assist System)
 - Brake fluid**
 - Display message 289
 - Notes 450
 - Brake lamps**
 - Changing bulbs 132
 - Display message 296
 - Brakes**
 - ABS 66
 - Adaptive Brake Assist 69
 - BAS 67
 - BAS PLUS 67
 - Brake fluid (notes) 450
 - Display message 283
 - Driving tips 183
 - High-performance brake system 184
 - Important safety notes 183
 - Maintenance 184
 - Parking brake 180
 - Warning lamp 318
 - Breakdown**
 - see Flat tire
 - see Towing away
 - Bulbs**
 - see Changing bulbs
- C**
- California**
 - Important notice for retail customers and lessees 24
 - Calling up a malfunction**
 - see Display messages
 - Car**
 - see Vehicle
 - Care**
 - Carpets 377
 - Car wash 370
 - Display 374
 - Exhaust pipe 374
 - Exterior lights 373
 - Gear or selector lever 376
 - Interior 374
 - Matte finish 372
 - Night View Assist Plus 375
 - Notes 369
 - Paint 371
 - Plastic trim 375
 - Power washer 371
 - Rear view camera 373
 - Roof lining 377
 - Seat belt 377
 - Seat cover 376
 - Sensors 373
 - Steering wheel 376
 - Trim pieces 376
 - Washing by hand 371
 - Wheels 372
 - Windows 372
 - Wiper blades 373
 - Wooden trim 376
 - Cargo compartment cover**
 - Notes/how to use 338
 - Cargo compartment enlargement**
 - Important safety notes 335
 - Cargo compartment floor**
 - Opening/closing 342
 - Stowage well (under) 342
 - Cargo net**
 - Attaching 340
 - Important safety information 340
 - Cargo tie down rings** 337
 - Car keys**
 - see SmartKey
 - Car wash (care)** 370
 - CD player/CD changer (on-board computer)** 270
 - Center console**
 - Lower section 37
 - Upper section 36
 - Central locking**
 - Automatic locking (on-board computer) 276
 - Locking/unlocking (SmartKey) 79
 - Changing bulbs**
 - Brake lamps 132
 - High-beam headlamps 130
 - Important safety notes 128
 - Low-beam headlamps 130

- Overview of bulb types 129
- Parking lamps 131
- Removing/replacing the cover (front wheel arch) 129
- Side marker lamps 131
- Standing lamps (front) 131
- Child-proof locks**
- Important safety notes 64
- Rear doors 65
- Children**
- In the vehicle 60
- Restraint systems 60
- Special seat belt retractor 62
- Child seat**
- LATCH-type (ISOFIX) child seat anchors 63
- Top Tether 63
- Cigarette lighter** 346
- Cleaning**
- Mirror turn signal 373
- Trailer tow hitch 374
- Climate control**
- Automatic climate control (3-zone) 142
- Controlling automatically 145
- Cooling with air dehumidification . . 145
- Defrosting the windows 149
- Defrosting the windshield 148
- Dual-zone automatic climate control 139
- Important safety notes 138
- Indicator lamp 145
- Information on using 3-zone automatic climate control 144
- Maximum cooling 148
- Notes on using automatic climate control 141
- Overview of systems 138
- Problems with cooling with air dehumidification 145
- Problem with the rear window defroster 150
- Rear control panel 142
- Setting the air distribution 147
- Setting the airflow 147
- Setting the air vents 151
- Setting the climate mode (AIR FLOW) 146
- Setting the temperature 146
- Switching air-recirculation mode on/off 150
- Switching on/off 144
- Switching residual heat on/off 150
- Switching the rear window defroster on/off 149
- Switching the ZONE function on/off 148
- Coat hooks** 340
- Cockpit**
- Overview 32
- see Instrument cluster
- COLLISION PREVENTION ASSIST** 68
- COMAND**
- ON&OFFROAD menu 252
- see separate operating instructions
- COMAND display**
- Cleaning 374
- Combination switch** 123
- Combined cargo cover and net** 339
- Compass**
- Calling up 362
- Consumption statistics (on-board computer)** 267
- Convenience closing feature** 93
- Convenience opening feature** 93
- Coolant (engine)**
- Checking the level 367
- Display message 299
- Filling capacity 451
- Important safety notes 451
- Temperature (on-board computer) . 278
- Temperature gauge 263
- Warning lamp 326
- Cooling**
- see Climate control
- Cornering light function**
- Display message 295
- Function/notes 125
- Crash-responsive emergency lighting** 128
- Cruise control**
- Activating 193
- Activation conditions 192
- Cruise control lever 192
- Deactivating 194

- Display message 309
 - Driving system 192
 - Function/notes 192
 - Important safety notes 192
 - Storing and maintaining current speed 193
 - Cup holder**
 - Center console 344
 - Important safety notes 343
 - Rear compartment 344
 - Temperature controlled 344
 - Customer Assistance Center (CAC) ...** 28
 - Customer Relations Department** 28
- D**
- Dashboard**
 - see Instrument cluster
 - Dashboard lighting**
 - see Instrument cluster lighting
 - Data**
 - see Technical data
 - Daytime running lamps**
 - Display message 297
 - Function/notes 120
 - Switching on/off (on-board computer) 274
 - Dealerships**
 - see Qualified specialist workshop
 - Declarations of conformity** 27
 - DEF**
 - Adding 177
 - Display message 302
 - Filling capacity 449
 - Important safety notes 448
 - Delayed switch-off**
 - Exterior lighting (on-board computer) 275
 - Interior lighting 276
 - Diagnostics connection** 27
 - Diesel** 447
 - Differential locks (display message)** 304
 - Digital speedometer** 267
 - DIRECT SELECT lever**
 - see Automatic transmission
 - Display messages**
 - ASSYST PLUS 368
 - Calling up (on-board computer) 282
 - Driving systems 302
 - Engine 299
 - General notes 282
 - Hiding (on-board computer) 282
 - KEYLESS-GO 315
 - Lights 295
 - Safety systems 283
 - SmartKey 314
 - Tires 310
 - Vehicle 312
 - Distance display (on-board computer)** 272
 - Distance recorder**
 - see Trip odometer
 - Distance warning (warning lamp) ...** 328
 - Distance warning function**
 - Activating/deactivating 272
 - Function/notes 68
 - Warning lamp 328
 - DISTRONIC PLUS**
 - Activating 196
 - Activation conditions 196
 - Cruise control lever 196
 - Deactivating 201
 - Display message 308
 - Displays in the multifunction display 202
 - Driving tips 202
 - Function/notes 194
 - Important safety notes 194
 - Setting the specified minimum distance 200
 - Warning lamp 328
 - Doors**
 - Automatic locking (on-board computer) 276
 - Automatic locking (switch) 86
 - Central locking/unlocking (SmartKey) 79
 - Control panel 40
 - Display message 313
 - Emergency locking 87
 - Emergency unlocking 86
 - Important safety notes 84
 - Opening (from inside) 85

- Overview 84
- Power closing feature 86
- Downhill Speed Regulation**
- see DSR (Downhill Speed Regulation)
- Drinking and driving** 182
- Drinks holder**
- see Cup holder
- Drive program**
- Automatic 169
- Display (DIRECT SELECT lever) 165
- Manual 171
- Off-road program (vehicles without the ON&OFFROAD package) 248
- Off-road program (vehicles with the ON&OFFROAD package) 248
- SETUP (on-board computer) 279
- see On-road programs
- Driver's door**
- see Doors
- Driving abroad**
- Mercedes-Benz Service 369
- Symmetrical low beam 120
- Driving in mountainous terrain**
- Approach/departure angle 190
- Driving lamps**
- see Daytime running lamps
- Driving off-road**
- see Off-road driving
- Driving safety systems**
- ABS (Anti-lock Braking System) 66
- ADAPTIVE BRAKE 73
- Adaptive Brake Assist 69
- BAS (Brake Assist System) 67
- BAS PLUS (Brake Assist System PLUS) 67
- COLLISION PREVENTION ASSIST 68
- Distance warning function 68
- Electronic brake force distribution ... 73
- ESP® (Electronic Stability Program) 70
- ETS/4ETS (Electronic Traction System) 70
- Important safety information 66
- Overview 65
- PRE-SAFE® Brake 73
- STEER CONTROL 75
- Driving systems**
- 360° camera 225
- Active Blind Spot Assist 237
- Active Curve System 209
- Active Driving Assistance package 237
- Active Lane Keeping Assist 241
- Active Parking Assist 217
- ADS 209
- AIRMATIC package 209
- AMG adaptive sport suspension system 212
- ATTENTION ASSIST 230
- Blind Spot Assist 233
- Cruise control 192
- Display message 302
- DISTRONIC PLUS 194
- HOLD function 207
- Lane Keeping Assist 235
- Level control (vehicles with AIRMATIC package) 210
- Level control (vehicles with the ON&OFFROAD package) 204
- On-road programs 243
- PARKTRONIC 213
- Rear view camera 221
- Driving tips**
- Automatic transmission 168
- Brakes 183
- Break-in period 156
- DISTRONIC PLUS 202
- Downhill gradient 183
- Drinking and driving 182
- Driving abroad 120
- Driving in winter 186
- Driving on flooded roads 185
- Driving on sand 189
- Driving on wet roads 185
- Driving over obstacles 189
- Exhaust check 182
- Fuel 182
- General 182
- Hydroplaning 185
- Icy road surfaces 186
- Limited braking efficiency on salted roads 184
- Off-road driving 187
- Off-road fording 185

- Snow chains 401
 - Symmetrical low beam 120
 - Tire ruts 189
 - Towing a trailer 253
 - Traveling uphill 190
 - Wet road surface 183
 - DSR (Downhill Speed Regulation)**
 - Display message 305
 - Function/notes 246
 - DVD audio**
 - Operating (on-board computer) 270
 - DVD video**
 - Operating (on-board computer) 270
- E**
- EASY-ENTRY feature**
 - Activating/deactivating 277
 - Function/notes 112
 - EASY-EXIT feature**
 - Crash-responsive 113
 - Function/notes 112
 - Switching on/off 277
 - EASY-PACK load-securing kit** 340
 - EBD (electronic brake force distribution)**
 - Display message 285
 - Function/notes 73
 - ECO start/stop function**
 - Automatic engine start 162
 - Automatic engine switch-off 162
 - Deactivating/activating 163
 - General information 161
 - Important safety notes 161
 - Electronic Stability Program**
 - see ESP® (Electronic Stability Program)
 - Emergency release**
 - Driver's door 86
 - Vehicle 86
 - Emergency spare wheel**
 - Important safety notes 436
 - Points to remember 437
 - Removing 437
 - Storage location 437
 - Technical data 439
 - Emergency Tensioning Devices**
 - Function 59
 - Safety guidelines 43
 - Emergency unlocking**
 - Tailgate 91
 - Emissions control**
 - Service and warranty information 24
 - Engine**
 - Check Engine warning lamp 325
 - Display message 299
 - ECO start/stop function 161
 - Engine number 444
 - Irregular running 164
 - Jump-starting 389
 - Starting problems 164
 - Starting the engine with the
 - SmartKey 159
 - Starting with KEYLESS-GO 160
 - Switching off 180
 - Tow-starting (vehicle) 394
 - Engine electronics**
 - Problem (malfunction) 164
 - Engine oil**
 - Adding 366
 - Additives 450
 - Checking the oil level 365
 - Checking the oil level using the
 - dipstick 366
 - Display message 300
 - Filling capacity 450
 - Notes about oil grades 449
 - Notes on oil level/consumption 365
 - Temperature (on-board computer) . 278
 - Viscosity 450
 - ESP® (Electronic Stability Program)**
 - AMG menu (on-board computer) ... 279
 - Deactivating/activating 71
 - Display message 283
 - ETS/4ETS 70
 - Function/notes 70
 - Important safety information 71
 - Trailer stabilization 72
 - Warning lamp 321
 - ETS/4ETS (Electronic Traction System)** 70
 - Exhaust check** 182
 - Exhaust pipe (cleaning instructions)** 374

- Exterior lighting**
see Lights
- Exterior mirrors**
Adjusting 113
Dipping (automatic) 114
Folding in/out (automatically) 114
Folding in/out (electrically) 114
Folding in when locking (on-board computer) 277
Out of position (troubleshooting) ... 114
Setting 114
Storing settings (memory function) 116
Storing the parking position 115
- Eyeglasses compartment** 334
- F**
- Filler cap**
see Fuel filler flap
- First-aid kit** 380
- Flat tire**
MOExtended tires 382
Preparing the vehicle 381
TIREFIT kit 383
- Floor mat** 362
- Folding the rear bench seat forwards/back** 335
- Fording**
Off-road 185
On flooded roads 185
- Fuel**
Additives 446
Consumption statistics 267
Displaying the current consumption 267
Displaying the range 267
Driving tips 182
Flexible fuel vehicles 448
Fuel gauge 33, 263
Grade (gasoline) 445
Important safety notes 445
Premium-grade unleaded gasoline . 445
Problem (malfunction) 176
Quality (diesel) 447
Refueling 173
Tank content/reserve fuel 445
- Fuel filler flap**
Opening/closing 174
- Fuel filter (display message)** 301
- Fuel level**
Calling up the range (on-board computer) 267
- Fuel tank**
Capacity 445
Problem (malfunction) 176
see Fuel tank
- Fuses**
Allocation chart 395
Before changing 395
Dashboard fuse box 395
Fuse box in the engine compartment 395
Fuse box under rear bench seat 395
Important safety notes 394
see Fuses
- G**
- Garage door opener**
Clearing the memory 361
Important safety notes 359
Opening/closing the garage door .. 361
Programming (button in the rear-view mirror) 359
- Gear indicator (on-board computer)** 278
- Genuine Mercedes-Benz parts** 442
- Glove box** 333
- GTW (Gross Trailer Weight) (definition)** 419
- H**
- Handbrake**
see Parking brake
- Hazard warning lamps** 124
- Headlamps**
Adding fluid to cleaning system 368
Cleaning system (capacity) 452
Cleaning system (function) 125
Cleaning system (notes) 452
Fogging up 127
see Automatic headlamp mode

- Head restraints**
- Adjusting 104
 - Adjusting (electrically) 105
 - Adjusting (manually) 105
 - Adjusting (rear) 106
 - Installing/removing (rear) 106
 - Luxury 105
- Heating**
- see Climate control
- High-beam headlamps**
- Changing bulbs 130
 - Display message 296
 - Switching Adaptive Highbeam
 - Assist on/off 126
 - Switching on/off 124
- Hill start assist** 161
- HOLD function**
- Deactivating 208
 - Display message 305
 - Function/notes 207
- Hood**
- Closing 365
 - Display message 313
 - Important safety notes 364
 - Opening 364
- Hydroplaning** 185
- I**
- Ignition lock**
- see Key positions
- Immobilizer** 75
- Indicator lamps**
- see Warning and indicator lamps
- Insect protection on the radiator** 365
- Instrument cluster**
- Overview 33, 263
 - Warning and indicator lamps 34, 316
- Instrument cluster lighting** 263
- Interior lighting** 127
- Automatic control 127
 - Delayed switch-off (on-board computer) 276
 - Emergency lighting 128
 - Manual control 128
 - Overview 127
 - Reading lamp 127
 - Setting the brightness of the ambient lighting (on-board computer) 275
 - Setting the color of the ambient lighting (on-board computer) 275
- J**
- Jack**
- Storage location 380
 - Using 423
- Jump-start (engine)**
- see Jump starting (engine)
- Jump starting (engine)** 389
- K**
- KEYLESS-GO**
- Convenience closing feature 94
 - Display message 315
 - Locking 79
 - Start/Stop button 158
 - Starting the engine 160
 - Unlocking 79
- Key positions**
- KEYLESS-GO 158
 - SmartKey 157
- Kickdown**
- Driving tips 168
 - Manual drive program 172
- Knee bag** 47
- L**
- Lamps**
- see Warning and indicator lamps
- Lane detection (automatic)**
- see Lane Keeping Assist
- Lane Keeping Assist**
- Activating/deactivating 273
 - Display message 306
 - Function/information 235
 - see Active Lane Keeping Assist
- Lap time (RACETIMER)** 279
- LATCH-type (ISOFIX) child seat anchors** 63
- Level control (display message)** 303

- Level control (vehicles with AIRMATIC package)**
 - Basic settings 211
 - Function/notes 210
 - Important safety notes 210
 - Level control (vehicles with the ON&OFFROAD package)**
 - Basic settings 205
 - Function/notes 204
 - Important safety notes 204
 - License plate lamp (display message)** 297
 - Light function, active**
 - Display message 298
 - Lights**
 - Activating/deactivating the interior lighting delayed switch-off . 276
 - Active light function 125
 - Automatic headlamp mode 120
 - Cornering light function 125
 - Driving abroad 120
 - Hazard warning lamps 124
 - High beam flasher 124
 - High-beam headlamps 124
 - Light switch 120
 - Low-beam headlamps 121
 - Parking lamps 122
 - Rear fog lamp 122
 - Setting the brightness of the ambient lighting (on-board computer) 275
 - Setting the color of the ambient lighting (on-board computer) 275
 - Standing lamps 123
 - Switching Adaptive Highbeam Assist on/off 275
 - Switching the daytime running lamps on/off (on-board computer) 274
 - Switching the exterior lighting delayed switch-off on/off (on-board computer) 275
 - Switching the surround lighting on/off (on-board computer) 275
 - Turn signals 123
 - see Changing bulbs
 - see Interior lighting
 - see Lights
 - Light sensor (display message)** 298
 - Loading guidelines** 332
 - Locking**
 - see Central locking
 - Locking (doors)**
 - Automatic 86
 - Emergency locking 87
 - From inside (central locking button) 85
 - Locking centrally**
 - see Central locking
 - Locking verification signal (on-board computer)** 276
 - Low-beam headlamps**
 - Changing bulbs 130
 - Display message 295
 - Setting for driving abroad (symmetrical) 120
 - Switching on/off 121
 - LOW RANGE**
 - Display message 304
 - Off-road gear 250
 - LOW RANGE off-road gear** 250
 - Luggage holder (EASY-PACK load-securing kit)** 341
 - Lumbar support**
 - Adjusting (on the seat) 107
 - Luxury head restraints** 105
- M**
- M+S tires** 400
 - Maintenance**
 - see ASSYST PLUS
 - Malfunction message**
 - see Display messages
 - Matte finish (cleaning instructions)** 372
 - mbrace**
 - Call priority 354
 - Display message 289
 - Downloading destinations (COMAND) 354
 - Downloading routes 358
 - Emergency call 351
 - Geo fencing 358
 - Important safety notes 350
 - Locating a stolen vehicle 357

- MB info call button 353
 - Remote vehicle locking 356
 - Roadside Assistance button 353
 - Search & Send 355
 - Self-test 351
 - Speed alert 358
 - System 351
 - Triggering the vehicle alarm 359
 - Vehicle remote malfunction diagnosis 357
 - Vehicle remote unlocking 356
 - Mechanical key**
 - Function/notes 80
 - Locking vehicle 87
 - Unlocking the driver's door 86
 - Memory card (audio)** 270
 - Memory function** 116
 - Message memory (on-board computer)** 282
 - Messages**
 - see Display messages
 - Mirrors**
 - see Exterior mirrors
 - see Rear-view mirror
 - see Vanity mirror (in the sun visor)
 - Mobile phone**
 - Menu (on-board computer) 270
 - Modifying the programming (SmartKey)** 80
 - MOExtended tires** 382
 - Mounting wheels**
 - Lowering the vehicle 426
 - Mounting a new wheel 425
 - Raising the vehicle 423
 - Removing a wheel 425
 - Securing the vehicle against rolling away 422
 - MP3**
 - Operation 270
 - see separate operating instructions
 - Multifunction display**
 - Function/notes 265
 - Permanent display 274
 - Multifunction steering wheel**
 - Operating the on-board computer . 264
 - Overview 35
- N**
- Navigation**
 - Menu (on-board computer) 268
 - see separate operating instructions
 - Night View Assist Plus**
 - Activating/deactivating 231
 - Cleaning 375
 - Problem (malfunction) 233
 - Notes on breaking-in a new vehicle** 156
- O**
- Occupant Classification System (OCS)**
 - Faults 53
 - Operation 48
 - System self-test 51
 - Occupant safety**
 - Children in the vehicle 60
 - Important safety notes 42
 - OCS**
 - Faults 53
 - Operation 48
 - System self-test 51
 - Odometer**
 - see Trip odometer
 - Off-road driving**
 - Checklist after driving off-road 188
 - Checklist before driving off-road 188
 - General information 187
 - Important safety notes 187
 - Traveling uphill 190
 - Off-road program (vehicles without the ON&OFFROAD package)**
 - Function/notes 248
 - Off-road programs (vehicles with the ON&OFFROAD package)**
 - Displays in the COMAND display ... 252
 - Function/notes 248
 - Off-road program 1 249
 - Off-road program 2 249
 - Off-road system**
 - 4MATIC 246
 - DSR 246
 - LOW RANGE off-road gear 250

- Off-road 4ETS 71
 - Off-road ABS 66
 - Off-road ESP® 72
 - Off-road program (vehicles without the ON&OFFROAD package) 248
 - Off-road programs (vehicles with the ON&OFFROAD package) 248
 - Oil**
 - see Engine oil
 - On and Offroad menu (on-board computer)** 278
 - On-board computer**
 - AMG menu 278
 - Assistance menu 272
 - Audio menu 269
 - Convenience submenu 277
 - Displaying a service message 369
 - Display messages 282
 - DISTRONIC PLUS 202
 - Factory settings submenu 278
 - Important safety notes 262
 - Instrument cluster submenu 274
 - Lighting submenu 274
 - Menu overview 266
 - Message memory 282
 - Navigation menu 268
 - On and Offroad menu 278
 - Operation 264
 - RACETIMER 279
 - Service menu 273
 - Settings menu 274
 - Standard display 266
 - Telephone menu 270
 - Trip menu 266
 - Vehicle submenu 276
 - Video DVD operation 270
 - On-road programs**
 - AUTO program 244
 - Function/notes 243
 - Snow program 245
 - SPORT program 244
 - Trailer program 245
 - Opening and closing the side trim panels** 132
 - Operating system**
 - see On-board computer
 - Outside temperature display** 264
 - Overhead control panel** 39
 - Override feature**
 - Rear side windows 65
- P**
- Paint code number** 443
 - Paintwork (cleaning instructions)** ... 371
 - Panic alarm** 42
 - Panorama roof with power tilt/sliding panel**
 - Opening/closing 98
 - Opening/closing the roller sunblind 99
 - Problem (malfunction) 100
 - Resetting 99
 - Panorama sliding sunroof**
 - Important safety notes 96
 - Parking** 179
 - Important safety notes 179
 - Parking brake 180
 - Position of exterior mirror, front-passenger side 115
 - Rear view camera 221
 - see PARKTRONIC
 - Parking aid**
 - Active Parking Assist 217
 - see Exterior mirrors
 - see PARKTRONIC
 - Parking brake**
 - Display message 286
 - Electric parking brake 180
 - Warning lamp 324
 - see Parking brake
 - Parking lamps**
 - Switching on/off 122
 - Parking lamps (changing bulbs)** 131
 - PARKTRONIC**
 - Deactivating/activating 215
 - Driving system 213
 - Function/notes 213
 - Important safety notes 213
 - Problem (malfunction) 217
 - Range of the sensors 214
 - Trailer towing 216
 - Warning display 215
 - PASSENGER AIR BAG OFF indicator lamp** 48

- Plastic trim (cleaning instructions)** . 375
 - Power closing feature** 86
 - Power washers** 371
 - Power windows**
 - see Side windows
 - PRE-SAFE® (anticipatory occupant protection)**
 - Display message 289
 - Operation 54
 - PRE-SAFE® Brake**
 - Activating/deactivating 272
 - Display message 291
 - Function/notes 73
 - Warning lamp 328
 - Product information** 23
 - Program selector button** 169
 - Protection of the environment**
 - General notes 23
 - Pulling away**
 - Trailer 160
 - Pulling away (automatic transmission)** 160
- Q**
- Qualified specialist workshop** 27
- R**
- RACETIMER (on-board computer)** 279
 - Radar sensor system**
 - Activating/deactivating 277
 - Display message 305
 - Radiator cover** 365
 - Radio**
 - Selecting a station 269
 - see separate operating instructions
 - Radio-controlled devices (installing)** 362
 - Reading lamp** 127
 - Rear axle level control (AMG adaptive sport suspension system)** 212
 - Rear compartment**
 - Setting the air vents 152
 - Rear fog lamp**
 - Switching on/off 122
 - Rear seats**
 - Adjusting 106
 - Rear view camera**
 - Cleaning instructions 373
 - Function/notes 221
 - Switching on/off 222
 - Rear-view mirror**
 - Anti-glare (manual) 113
 - Dipping (automatic) 114
 - Rear window defroster**
 - Problem (malfunction) 150
 - Switching on/off 149
 - Rear window wiper**
 - Replacing the wiper blade 134
 - Switching on/off 133
 - Refueling**
 - Fuel gauge 33, 263
 - Important safety notes 173
 - Refueling process 174
 - see Fuel
 - Remote control**
 - Programming (garage door opener) 359
 - Reporting safety defects** 28
 - Reserve (fuel tank)**
 - see Fuel
 - Reserve fuel**
 - Display message 301
 - Warning lamp 325
 - see Fuel
 - Residual heat (climate control)** 150
 - Restraint system**
 - see SRS (Supplemental Restraint System)
 - Reversing lamps (display message)** 297
 - Roadside Assistance (breakdown)** 25
 - Roller sunblind**
 - Panorama roof with power tilt/sliding panel 98
 - Rear side windows 345
 - Roof carrier** 343
 - Roof lining and carpets (cleaning guidelines)** 377
 - Roof load (maximum)** 452
 - Route (navigation)**
 - see Route guidance (navigation)

- Route guidance (navigation)** 268
- S**
- Safety**
- Children in the vehicle 60
 - Child restraint systems 60
 - Occupant Classification System (OCS) 48
- Safety system**
- see Driving safety systems
- Seat belts**
- Adjusting the driver's and front-passenger seat belt 57
 - Adjusting the height 57
 - Belt force limiters 59
 - Cleaning 377
 - Correct usage 55
 - Emergency Tensioning Devices 59
 - Fastening 56
 - Important safety guidelines 54
 - Releasing 58
 - Safety guidelines 43
 - Switching belt adjustment on/off (on-board computer) 277
 - Warning lamp 317
 - Warning lamp (function) 58
 - see Seat belts
- Seats**
- Adjusting (electrically) 104
 - Adjusting the head restraint 104
 - Cleaning the cover 376
 - Correct driver's seat position 102
 - Folding the rear bench seat forwards/back 335
 - Important safety notes 103
 - Overview 103
 - Seat heating problem 109
 - Seat ventilation problem 110
 - Storing settings (memory function) 116
 - Switching seat heating on/off 107
 - Switching seat ventilation on/off . . 109
- Securing hooks** 338
- Selector lever**
- Cleaning 376
- Sensors (cleaning instructions)** 373
- Service menu (on-board computer)** . 273
- Service products**
- Brake fluid 450
 - Coolant (engine) 451
 - DEF special additives 448
 - Engine oil 449
 - Fuel 445
 - Important safety notes 444
 - Washer fluid 452
- Settings**
- Factory (on-board computer) 278
 - On-board computer 274
- Setting the air distribution** 147
- Setting the airflow** 147
- SETUP (on-board computer)** 279
- Side impact air bag** 47
- Side marker lamp (display message)** 297
- Side marker lamps (changing bulbs)** 131
- Side windows**
- Cleaning 372
 - Convenience closing feature 93
 - Convenience opening feature 93
 - Important safety information 92
 - Opening/closing 92
 - Overview 92
 - Problem (malfunction) 96
 - Resetting 94
- Sliding sunroof**
- Important safety notes 96
 - Opening/closing 97
 - Problem (malfunction) 100
 - Resetting 98
 - see Panorama roof with power tilt/sliding panel
- SmartKey**
- Changing the battery 81
 - Changing the programming 80
 - Checking the battery 81
 - Convenience closing feature 94
 - Convenience opening feature 93
 - Display message 314
 - Door central locking/unlocking 79
 - Important safety notes 78
 - Loss 83
 - Mechanical key 80
 - Overview 78
 - Positions (ignition lock) 157

- Problem (malfunction) 83
 - Starting the engine 159
 - Snow chains**
 - Information 401
 - Snow drive program 245
 - Sockets**
 - Center console 347
 - General notes 347
 - Luggage compartment 348
 - Rear compartment 348
 - Spare wheel**
 - see Emergency spare wheel
 - Specialist workshop** 27
 - Special seat belt retractor** 62
 - Speed, controlling**
 - see Cruise control
 - Speedometer**
 - Digital 267
 - In the Instrument cluster 33, 263
 - Segments 264
 - Selecting the unit of measurement 274
 - see Instrument cluster
 - SRS**
 - see SRS (Supplemental Restraint System)
 - SRS (Supplemental Restraint System)**
 - Display message 291
 - Introduction 43
 - Warning lamp 324
 - Warning lamp (function) 43
 - Standing lamps**
 - Changing bulbs 131
 - Display message 297
 - Switching on/off 123
 - Start/stop function**
 - see ECO start/stop function
 - Starting (engine)** 159
 - STEER CONTROL** 75
 - Steering (display message)** 314
 - Steering wheel**
 - Adjusting (electrically) 111
 - Adjusting (manually) 110
 - Button overview 35
 - Buttons (on-board computer) 264
 - Cleaning 376
 - Important safety notes 110
 - Paddle shifters 169
 - Steering wheel heating 111
 - Storing settings (memory function) 116
 - Steering wheel heating**
 - Problem (malfunction) 112
 - Switching on/off 111
 - Steering wheel paddle shifters** 169
 - Stopwatch (RACETIMER)** 279
 - Stowage areas** 332
 - Stowage compartments**
 - Armrest (under) 334
 - Center console 334
 - Cup holders 343
 - Eyeglasses compartment 334
 - Glove box 333
 - Important safety information 333
 - Stowage net 335
 - Stowage net** 335
 - Stowage space**
 - Center console (rear) 334
 - Summer tires** 400
 - Sun visor** 345
 - Surround lighting (on-board computer)** 275
 - Suspension tuning**
 - AMG adaptive sport suspension system 212
 - SETUP (on-board computer) 279
 - SUV**
 - (Sport Utility Vehicle) 26
 - Switching air-recirculation mode on/off** 150
 - Switching off the alarm (ATA)** 75
- T**
- Tachometer** 264
 - Tailgate**
 - Display message 313
 - Emergency unlocking 91
 - Important safety notes 87
 - Limiting the opening angle 91
 - Opening/closing (automatically from inside) 90
 - Opening/closing (automatically from outside) 89

- Opening/closing (from outside) 88
- Opening dimensions 452
- Power closing 86
- Tail lamps**
 - Display message 296
- Tank content**
 - Fuel gauge 33, 263
- Technical data**
 - Capacities 444
 - Emergency spare wheel 439
 - Information 442
 - Tires/wheels 426
 - Trailer loads 455
 - Vehicle data 452
- TELEAID**
 - Call priority 354
 - Downloading destinations (COMAND) 354
 - Downloading routes 358
 - Emergency call 351
 - Geo fencing 358
 - Important safety notes 350
 - Locating a stolen vehicle 357
 - MB info call button 353
 - Remote vehicle locking 356
 - Roadside Assistance button 353
 - Search & Send 355
 - Self-test 351
 - Speed alert 358
 - System 351
 - Triggering the vehicle alarm 359
 - Vehicle remote malfunction diagnosis 357
 - Vehicle remote unlocking 356
- Telephone**
 - Accepting a call 271
 - Display message 314
 - Menu (on-board computer) 270
 - Number from the phone book 271
 - Redialing 271
 - Rejecting/ending a call 271
- Telescopic rod (EASY-PACK load-securing kit) 341**
- Temperature**
 - Coolant 263
 - Coolant (on-board computer) 278
 - Engine oil (on-board computer) 278
 - Outside temperature 264
 - Setting (climate control) 146
- Theft deterrent systems**
 - ATA (Anti-Theft Alarm system) 75
 - Immobilizer 75
- Through-loading 335**
- Time**
 - see Separate Operator's Manual
- Timing (RACETIMER) 279**
- TIREFIT kit 383**
- Tire pressure**
 - Calling up (on-board computer) 406
 - Checking manually 405
 - Display message 310
 - Maximum 404
 - Notes 403
 - Not reached (TIREFIT) 384
 - Reached (TIREFIT) 384
 - Recommended 402
 - see Tire pressure
- Tire pressure loss warning system**
 - Important safety notes 405
 - Restarting 406
- Tire pressure monitoring system**
 - Checking the tire pressure electronically 408
 - Function/notes 406
 - Restarting 409
 - Warning lamp 329
 - Warning message 409
- Tires**
 - Aspect ratio (definition) 420
 - Average weight of the vehicle occupants (definition) 419
 - Bar (definition) 418
 - Changing a wheel 421
 - Characteristics 418
 - Checking 399
 - Definition of terms 418
 - Direction of rotation 422
 - Display message 310
 - Distribution of the vehicle occupants (definition) 421
 - DOT, Tire Identification Number (TIN) 418
 - DOT (Department of Transportation) (definition) 419

- GAWR (Gross Axle Weight Rating)
 - (definition) 419
- GTW (Gross Trailer Weight)
 - (definition) 419
- GVW (Gross Vehicle Weight)
 - (definition) 419
- GVWR (Gross Vehicle Weight Rating) (definition) 419
- Important safety notes 398
- Increased vehicle weight due to optional equipment (definition) 419
- Kilopascal (kPa) (definition) 419
- Labeling (overview) 415
- Load bearing index (definition) 420
- Load index 417
- Load index (definition) 420
- M+S tires 400
- Maximum loaded vehicle weight (definition) 419
- Maximum load on a tire (definition) 420
- Maximum permissible tire pressure (definition) 420
- Maximum tire load 417
- Maximum tire load (definition) 420
- MOExtended tires 400
- Optional equipment weight (definition) 420
- PSI (pounds per square inch) (definition) 420
- Replacing 421
- Service life 400
- Sidewall (definition) 420
- Speed rating (definition) 419
- Storing 422
- Structure and characteristics (definition) 418
- Temperature 414
- TIN (Tire Identification Number) (definition) 420
- Tire bead (definition) 420
- Tire pressure (definition) 420
- Tire pressures (recommended) 419
- Tire size (data) 426
- Tire size designation, load-bearing capacity, speed rating 415
- Tire tread 399
- Tire tread (definition) 420
- Total load limit (definition) 421
- Traction 414
- Traction (definition) 421
- Tread wear 414
- TWR (permissible trailer drawbar noseweight) (definition) 421
- Uniform Tire Quality Grading Standards 413
- Uniform Tire Quality Grading Standards (definition) 419
- Unladen weight (definition) 420
- Wear indicator (definition) 421
- Wheel rim (definition) 419
 - see Flat tire
- Top Tether** 63
- Towing**
 - Important safety guidelines 391
 - Installing the towing eye 392
 - Removing the towing eye 393
 - With the rear axle raised 393
- Towing a trailer**
 - Active Parking Assist 221
 - Axle load, permissible 455
 - Cleaning the trailer tow hitch 374
 - Coupling up a trailer 257
 - Decoupling a trailer 258
 - Driving tips 253
 - ESP® (Electronic Stability Program) 72
 - Important safety notes 253
 - Installing the ball coupling 255
 - Mounting dimensions 454
 - Power supply 260
 - Pulling away with a trailer 160
 - Removing the ball coupling 259
 - Shift range 168
 - Storing the ball coupling 260
 - Trailer drive program 245
 - Trailer loads 455
- Towing away**
 - With both axles on the ground 393
- Tow-starting**
 - Emergency engine starting 394
 - Important safety notes 391
- Trailer coupling**
 - see Towing a trailer
- Trailer loads and drawbar noseweights** 259

| | |
|--|-----|
| Trailer towing | |
| Active Blind Spot Assist | 240 |
| Active Lane Keeping Assist | 243 |
| Blind Spot Assist | 235 |
| PARKTRONIC | 216 |
| Permissible trailer loads and drawbar noseweights | 259 |
| Transfer case | 173 |
| Transmission | |
| see Automatic transmission | |
| Transmission position display | 165 |
| Transmission position display (DIRECT SELECT lever) | 165 |
| Transporting the vehicle | 393 |
| Traveling uphill | |
| Brow of hill | 191 |
| Driving downhill | 191 |
| Maximum gradient-climbing capability | 191 |
| Trim pieces (cleaning instructions) . | 376 |
| Trip computer (on-board computer) | 267 |
| Trip odometer | |
| Calling up | 266 |
| Resetting (on-board computer) | 268 |
| see Trip odometer | |
| Trunk | |
| see Tailgate | |
| Turn signals | |
| Display message | 295 |
| Switching on/off | 123 |
| see Turn signals | |
| TWR (Tongue Weight Rating) (definition) | 421 |
| Type identification plate | |
| see Vehicle identification plate | |

U

| | |
|---|----|
| Unlocking | |
| Emergency unlocking | 86 |
| From inside the vehicle (central unlocking button) | 85 |

V

| | |
|---|-----|
| Vanity mirror (in the sun visor) | 345 |
| Vehicle | |
| Correct use | 27 |
| Data acquisition | 28 |
| Display message | 312 |
| Equipment | 24 |
| Individual settings | 274 |
| Limited Warranty | 28 |
| Loading | 410 |
| Locking (in an emergency) | 87 |
| Locking (SmartKey) | 79 |
| Lowering | 426 |
| Maintenance | 25 |
| Parking for a long period | 182 |
| Pulling away | 160 |
| Raising | 423 |
| Reporting problems | 28 |
| Securing from rolling away | 422 |
| Towing away | 391 |
| Transporting | 393 |
| Unlocking (in an emergency) | 86 |
| Unlocking (SmartKey) | 79 |
| Vehicle data | 452 |
| Vehicle battery | |
| see Battery (vehicle) | |
| Vehicle data | 452 |
| Vehicle dimensions | 452 |
| Vehicle emergency locking | 87 |
| Vehicle identification number | |
| see VIN | |
| Vehicle identification plate | 443 |
| Vehicle level (display message) | 302 |
| Vehicle tool kit | 380 |
| Video | |
| Operating the DVD | 270 |
| VIN | 443 |

W

| | |
|------------------------------------|-----|
| Warning and indicator lamps | |
| ABS | 319 |
| Brakes | 318 |
| Check Engine | 325 |
| Coolant | 326 |
| Distance warning | 328 |
| DISTRONIC PLUS | 328 |

- ESP® 321
- ESP® OFF 322
- Fuel tank 325
- Overview 34, 316
- PASSENGER AIR BAG OFF
 - indicator lamp 48
 - Reserve fuel 325
 - Seat belt 317
 - SRS 324
 - Tire pressure monitor 329
- Warranty** 442
- Washer fluid**
 - Display message 314
- Wheel bolt tightening torque** 426
- Wheel chock** 422
- Wheels**
 - Changing a wheel 421
 - Checking 399
 - Cleaning 372
 - Cleaning (warning) 422
 - Emergency spare wheel 436
 - Important safety notes 398
 - Interchanging/changing 421
 - Mounting a new wheel 425
 - Mounting a wheel 422
 - Overview 398
 - Removing a wheel 425
 - Storing 422
 - Tightening torque 426
 - Wheel size/tire size 426
- Window curtain air bag**
 - Display message 292
 - Operation 48
- Windows**
 - see Side windows
- Windshield**
 - Defrosting 148
 - Infrared reflective 362
 - see Windshield
- Windshield washer fluid**
 - see Windshield washer system
- Windshield washer system**
 - Adding washer fluid 368
 - Filling capacity 452
 - Notes 452
- Windshield wipers**
 - Problem (malfunction) 136
 - Rear window wiper 133
 - Replacing the wiper blades 133
 - Switching on/off 132
- Winter driving**
 - Slippery road surfaces 186
 - Snow chains 401
- Winter operation**
 - General notes 400
 - Overview 400
 - Radiator cover 365
 - Snow drive program 245
- Winter tires**
 - M+S tires 400
- Wiper blades**
 - Cleaning 373
 - Important safety notes 133
 - Replacing 133
 - Replacing (rear window) 134
 - Replacing (windshield) 134
- Wooden trim (cleaning instructions)** 376
- Workshops**
 - see Qualified specialist workshop

Protection of the environment

General notes

Environmental note

Daimler's declared policy is one of integrated environmental protection.

The objectives are for the natural resources that form the basis of our existence on this planet to be used sparingly and in a manner that takes the requirements of both nature and humanity into account.

You too can help to protect the environment by operating your vehicle in an environmentally responsible manner.

Fuel consumption and the rate of engine, transmission, brake and tire wear depend on the following factors:

- operating conditions of your vehicle
- your personal driving style

You can influence both factors. You should bear the following in mind:

Operating conditions:

- avoid short trips as these increase fuel consumption.
- always make sure that the tire pressures are correct.
- do not carry any unnecessary weight.
- keep an eye on the vehicle's fuel consumption.
- remove roof racks once you no longer need them.
- a regularly serviced vehicle will contribute to environmental protection. You should therefore adhere to the service intervals.
- always have service work carried out at a qualified specialist workshop.

Personal driving style:

- do not depress the accelerator pedal when starting the engine.
- do not warm up the engine when the vehicle is stationary.
- drive carefully and maintain a safe distance from the vehicle in front.

- avoid frequent, sudden acceleration.
- change gear in good time and use each gear only up to $\frac{2}{3}$ of its maximum engine speed.
- switch off the engine in stationary traffic.

Environmental concerns and recommendations

Wherever the operating instructions require you to dispose of materials, first try to regenerate or re-use them. Observe the relevant environmental rules and regulations when disposing of materials. In this way you will help to protect the environment.

Product information

Mercedes-Benz recommends that you use genuine Mercedes-Benz parts, conversion parts and accessories that have been approved for your vehicle.

Mercedes-Benz tests genuine parts as well as conversion parts and accessories that have been specifically approved for your vehicle for their reliability, safety and suitability. Despite ongoing market research, Mercedes-Benz is unable to assess other parts. Therefore, Mercedes-Benz accepts no responsibility for the use of such parts in Mercedes-Benz vehicles. This is also the case, even if they have been independently or officially approved. The use of non-approved parts could affect your vehicle's operating safety. Genuine Mercedes-Benz parts, approved conversion parts and accessories are available from any authorized Mercedes-Benz Center. Here, you will receive advice about permissible technical modifications, and the parts will be professionally installed.

Operator's Manual

General notes

Before you first drive off, read this Operator's Manual carefully and familiarize yourself with your vehicle.

For your own safety and a longer vehicle life, follow the instructions and warning notices in this manual. Disregarding them may lead to damage to the vehicle or personal injury.

Vehicle damage resulting from the disregard of the instructions is not covered by the Mercedes-Benz Limited Warranty.

Vehicle equipment

This Operator's Manual describes all models and all standard and optional equipment of your vehicle available at the time of going to print. Country-specific differences are possible. Please note that your vehicle may not be equipped with all features described. This also applies to safety-related systems and functions. The equipment in your vehicle may therefore differ from some of the descriptions or illustrations.

The original purchase agreement lists all systems installed in your vehicle.

Contact an authorized Mercedes-Benz Center if you have any questions about equipment or operation.

The Operator's Manual and Maintenance Booklet are important documents and should be kept in the vehicle.

Service and vehicle operation

Service and literature

Your vehicle is covered under the terms of the warranties printed in the Service and Warranty Information booklet. Your authorized Mercedes-Benz Center will exchange or repair any defective parts originally installed in the vehicle in accordance with the terms of the following warranties:

- New Vehicle Limited Warranty
- Emission Systems Warranty
- Emission Performance Warranty
- California, Connecticut, Maine, Massachusetts, New York, Pennsylvania, Rhode Island and Vermont Emission Control Systems Warranty
- State warranty enforcement laws (lemon laws)

Information for customers in California

Under California law you may be entitled to a replacement of your vehicle or a refund of the purchase price or lease price, if after a reasonable number of repair attempts Mercedes-Benz USA, LLC and/or its authorized repair or service facilities fail to fix one or more substantial defects or malfunctions in the vehicle that are covered by its express warranty. During the period of 18 months from original delivery of the vehicle or the accumulation of 18,000 miles (approximately 29,000 km) on the odometer of the vehicle, whichever occurs first, a reasonable number of repair attempts is presumed for a retail buyer or lessee if one or more of the following occurs:

- (1) the same substantial defect or malfunction results in a condition that is likely to cause death or serious bodily injury if the vehicle is driven, that defect or malfunction has been subject to repair two or more times, and you have directly

notified Mercedes-Benz USA, LLC in writing of the need for its repair,

- (2) the same substantial defect or malfunction of a less serious nature than category (1) has been subject to repair four or more times and you have directly notified us in writing of the need for its repair, or
- (3) the vehicle is out of service by reason of repair of the same or different substantial defects or malfunctions for a cumulative total of more than 30 calendar days.

Please send your written notice to:

Mercedes-Benz USA, LLC
Customer Assistance Center
One Mercedes Drive
Montvale, NJ 07645-0350

Maintenance

The Service and Warranty Booklet describes all the necessary maintenance work which should be done at regular intervals.

Always have the Service and Warranty Booklet with you when you bring the vehicle to an authorized Mercedes-Benz Center. The service advisor will record every service for you in the Service and Warranty Booklet.

Roadside Assistance

The Mercedes-Benz Roadside Assistance Program offers technical help in the event of a breakdown. Calls to the toll-free Roadside Assistance Hotline are answered by our agents 24 hours a day, 365 days a year.

1-800-FOR-MERCEdes(1-800-367-6372)
(USA)

1-800-387-0100 (Canada)

For additional information, refer to the Mercedes-Benz Roadside Assistance Program brochure (USA) or the "Roadside Assistance" section in the Service and Warranty booklet (Canada). You will find both in your vehicle literature portfolio.

Change of address or change of ownership

In the event of a change of address, please send us the "Notification of Address Change" in the Service and Guarantee booklet or simply call the Mercedes-Benz Customer Assistance Center (USA) at the hotline number

1-800-FOR-MERCEdes(1-800-367-6372) or Customer Service Center (Canada) at 1-800-387-0100. This will assist us in contacting you in a timely manner should the need arise.

If you sell your Mercedes, please leave the entire literature in the vehicle so that it is available to the next owner.

If you have purchased a used car, please send us the "Notification of Used Car Purchase" in the Service and Guarantee booklet or simply call the Mercedes-Benz Customer Assistance Center (USA) at the hotline number 1-800-FOR-MERCEdes(1-800-367-6372) or Customer Service (Canada) at 1-800-387-0100.

Vehicle operation outside the USA and Canada

If you plan to operate your vehicle in foreign countries, please be aware that:

- service facilities or replacement parts may not be readily available.
- unleaded fuel for vehicles with a catalytic converter may not be available. Leaded fuel may cause damage to the catalytic converter.
- the fuel may have a considerably lower octane rating. Unsuitable fuel can cause engine damage.

Some Mercedes-Benz models are available for delivery in Europe through our European Delivery Program. For details, consult an authorized Mercedes-Benz Center or write to one of the following addresses.

In the USA

Mercedes-Benz USA, LLC
 European Delivery Department
 One Mercedes Drive
 Montvale, NJ 07645-0350

In Canada

Mercedes-Benz Canada, Inc.
 European Delivery Department
 98 Vanderhoof Avenue
 Toronto, Ontario M4G 4C9

Sports Utility Vehicle

WARNING

This Sport Utility Vehicle is designed for both on-road and off-road use. It can go places and perform tasks for which conventional 2-wheel drive passenger cars are not intended. This vehicle will handle and maneuver differently from conventional passenger cars in driving conditions which may occur on streets, highways and off-road use.

This vehicle has a higher ground clearance and a higher center of gravity than many passenger cars. As with other vehicles of this type, if you make sharp turns at excessive speeds or abrupt maneuvers, the vehicle may roll over or may go out of control and crash. Utility vehicles have a significantly higher rollover rate than other types of vehicles. Failure to operate this vehicle safely may result in an accident, rollover of the vehicle, and severe or fatal injury.

Before you start to drive this vehicle, read the Operator's Manual. Take time to become familiar with the driving characteristics of this vehicle. Be sure you are familiar with all vehicle controls. Learn how your vehicle handles on different road surfaces. Do not attempt sharp turns at excessive speeds or abrupt maneuvers or other unsafe driving actions that can cause loss of vehicle control. When driving off-road or working the vehicle hard, do not overload it. And, always wear your seat belts at all times. In a rollover crash,

an unbelted person is significantly more likely to die than a person wearing a seat belt.

Operating safety

Important safety notes

WARNING

Work improperly carried out on electronic components and associated software could cause them to cease functioning. Because the vehicle's electronic components are interconnected, any modifications made may produce an undesired effect on other systems. Electronic malfunctions could seriously impair the operating safety of your vehicle.

Contact an authorized Mercedes-Benz Center for repairs or modifications to electronic components.

Other improper work or modifications on the vehicle could also have a negative impact on the operating safety of the vehicle.

Some safety systems only function when the engine is running. You should therefore never turn off the engine while driving.

WARNING

Heavy blows against the vehicle underbody or tires/wheels may cause serious damage and impair the operating safety of your vehicle. Such blows can be caused, for example, by running over an obstacle, road debris or a pothole.

If you feel a sudden significant vibration or ride disturbance, or you suspect that damage to your vehicle has occurred:

- turn on your hazard warning flashers.
- slow down carefully.
- drive with caution to an area which is a safe distance from the road.

Inspect the vehicle underbody and tires/wheels for possible damage. If the vehicle appears unsafe, have it towed to the nearest authorized Mercedes-Benz Center or other

qualified maintenance or repair facility for further inspection or repairs.

Declarations of conformity

Vehicle components which receive and/or transmit radio waves

USA: "The wireless devices of this vehicle comply with Part 15 of the FCC Rules. Operation is subject to the following two conditions: 1) These devices may not cause harmful interference, and 2) These devices must accept any interference received, including interference that may cause undesired operation. Changes or modifications not expressly approved by the party responsible for compliance could void the user's authority to operate the equipment."

Canada: "The wireless devices of this vehicle comply with Industry Canada license-exempt RSS standard(s). Operation is subject to the following two conditions: (1) These devices may not cause interference, and (2) These devices must accept any interference, including interference that may cause undesired operation of the device."

Diagnostics connection

WARNING

If you connect equipment to the on-board diagnostics connection, it can affect the operation of the vehicle systems. This can impair the operating safety of your vehicle while driving. There is a risk of an accident.

Do not connect any equipment to the on-board diagnostics connection.

WARNING

Loose equipment or equipment cables which are connected to the on-board diagnostics connection can obstruct the area around the pedals. The equipment or the cables could come between the pedals in the event of

sudden braking or acceleration. This may affect the function of the pedals. There is a risk of an accident.

Do not attach any equipment or cables in the driver's footwell.

-  If the engine is switched off and equipment on the diagnostics connection is used, the starter battery may discharge.

The diagnostics connection is only intended for the connection of diagnostic equipment at a qualified specialist workshop.

Connecting equipment to the diagnostics connection can, for example, lead to emissions monitoring information being reset. This may lead to the vehicle failing to meet the requirements of the next emissions test during the main inspection.

Qualified specialist workshop

An authorized Mercedes-Benz Center is a qualified specialist workshop. It has the necessary specialist knowledge, tools and qualifications to correctly carry out the work required on your vehicle. This is especially the case for work relevant to safety.

Observe the notes in the Maintenance Booklet.

Always have the following work carried out at an authorized Mercedes-Benz Center:

- work relevant to safety
- service and maintenance work
- repair work
- alterations, installation work and modifications
- work on electronic components

Correct use

WARNING

There are various warning stickers affixed to your vehicle. Their purpose is to alert you and others to various dangers. Therefore, do not

remove any warning stickers unless the sticker clearly states that you may do so.

If you remove any warning stickers, you or others could fail to recognize certain dangers and be injured.

When driving your vehicle observe the following information:

- the safety notes in this manual
- the Technical Data section in this manual
- traffic rules and regulations
- laws and safety standards pertaining to motor vehicles

Problems with your vehicle

If you should experience a problem with your vehicle, particularly one that you believe may affect its safe operation, we urge you to contact an authorized Mercedes-Benz Center immediately to have the problem diagnosed and rectified. If the problem is not resolved to your satisfaction, please discuss the problem again with a Mercedes-Benz Center or contact us at one of the following addresses.

In the USA

Customer Assistance Center
Mercedes-Benz USA, LLC
One Mercedes Drive
Montvale, NJ 07645-0350

In Canada

Customer Relations Department
Mercedes-Benz Canada, Inc.
98 Vanderhoof Avenue
Toronto, Ontario M4G 4C9

Reporting safety defects

USA only:

The following text is published as required of manufacturers under Title 49, Code of U.S. Federal Regulations, Part 575 pursuant to the "National Traffic and Motor Vehicle Safety Act of 1966".

If you believe that your vehicle has a defect which could cause a crash or could cause injury or death, you should immediately inform the National Highway Traffic Safety Administration (NHTSA) in addition to notifying Mercedes-Benz USA, LLC.

If NHTSA receives similar complaints, it may open an investigation, and if it finds that a safety defect exists in a group of vehicles, it may order a recall and remedy campaign. However, NHTSA cannot become involved in individual problems between you, your dealer, or Mercedes-Benz USA, LLC.

To contact NHTSA, you may call the Vehicle Safety Hotline toll-free at 1-888-327-4236 (TTY: 1-800-424-9153); go to <http://www.safercar.gov>; or write to: Administrator, NHTSA, 400 Seventh Street, SW., Washington, DC 20590.

You can also obtain other information about motor vehicle safety from

<http://www.safercar.gov>

Limited Warranty

- ❗ Follow the instructions in this manual about the proper operation of your vehicle as well as about possible vehicle damage. Damage to your vehicle that arises from culpable contraventions against these instructions is not covered either by the Mercedes-Benz Limited Warranty or by the New or Used-Vehicle Warranty.

Data stored in the vehicle

Information about electronic data acquisition in the vehicle

(Including notice pursuant to California Code § 9951)

Your vehicle records electronic data. If your vehicle is equipped with mbrace (Canada: TELE AID), data is transmitted in the event of an accident.

This information helps, for example, to test vehicle systems after an accident and to continually improve vehicle safety.

Daimler AG can access this data and submit it:

- for safety research or vehicle diagnosis purposes
- with the consent of the vehicle owner
- on the instruction of prosecuting authorities
- for use in arbitration of disputes that involve Daimler AG, its affiliates or its sales and service organizations
- as otherwise required or permitted by law.

Please check your mbrace (Canada: TELE AID) purchase agreement to find out more about data that can be recorded and transmitted by this system.

Information on copyright

General information

You can find information on licenses for free and open-source software used in your vehicle and its electronic components on the following website:

<http://www.mercedes-benz.com/opensource>

Dashboard 32
Instrument cluster 33
Multifunction steering wheel 35
Center console 36
Overhead control panel 39
Door control panel 40



Dashboard

At a glance

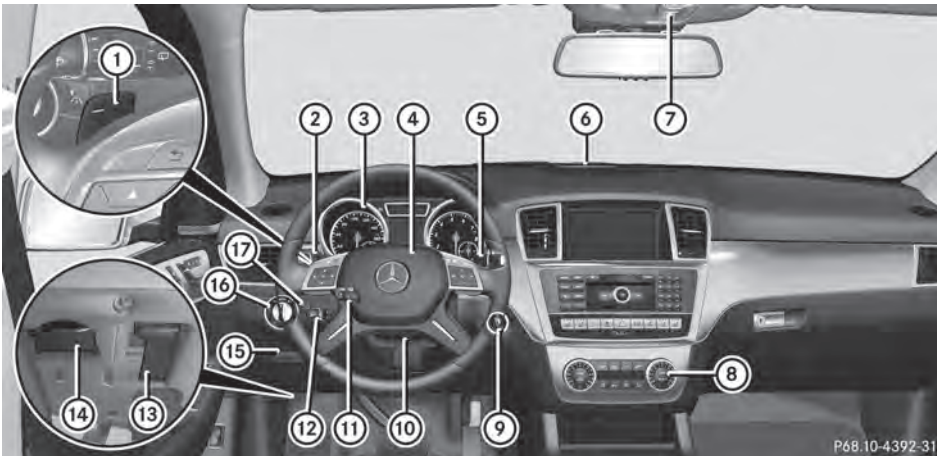

P68.10-4392-31

| | Function | Page |
|---|--------------------------------|------|
| ① | Steering wheel paddle shifters | 169 |
| ② | Combination switch | 123 |
| ③ | Instrument cluster | 33 |
| ④ | Horn | |
| ⑤ | DIRECT SELECT lever | 165 |
| ⑥ | PARKTRONIC warning display | 213 |
| ⑦ | Overhead control panel | 39 |
| ⑧ | Climate control systems | 138 |
| ⑨ | Ignition lock | 157 |
| | Start/Stop button | 158 |

| | Function | Page |
|---|---|------|
| ⑩ | Adjusting the steering wheel manually | 110 |
| ⑪ | Adjusting the steering wheel electrically | 110 |
| | Steering wheel heating | 111 |
| ⑫ | Cruise control lever | 192 |
| ⑬ | Opening the hood | 364 |
| ⑭ | Diagnostics connection | 27 |
| ⑮ | Electric parking brake | 180 |
| ⑯ | Light switch | 120 |
| ⑰ | Night View Assist Plus | 231 |

Instrument cluster

Displays and controls

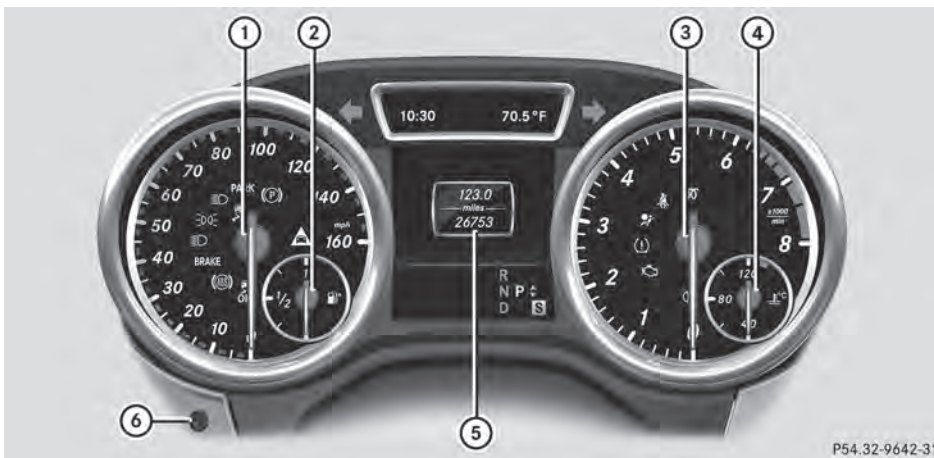

P54.32-9642-31

| | Function | Page | | Function | Page |
|---|---------------------------|------|---|-----------------------|------|
| ① | Speedometer with segments | 264 | ④ | Coolant temperature | 263 |
| ② | Fuel gauge | | ⑤ | Multifunction display | 265 |
| ③ | Tachometer | 264 | ⑥ | Instrument lighting | 263 |

Warning and indicator lamps



P54.32-9646-31







| | Function | Page |
|---|---|------|
| ① | Low-beam headlamps | 121 |
| ② | Parking lamps | 122 |
| ③ | ESP® | 321 |
| ④ | High-beam headlamps | 124 |
| ⑤ | Electric parking brake (red) (USA only) (Canada only) | 324 |
| ⑥ | Electric parking brake (yellow) | 324 |
| ⑦ | Distance warning | 328 |
| ⑧ | Turn signals | 123 |
| ⑨ | Tire pressure monitor | 329 |







| | Function | Page |
|---|--|------|
| ⑩ | SRS | 324 |
| ⑪ | Seat belt | 317 |
| ⑫ | Diesel engine: preglow | 159 |
| ⑬ | Coolant | 326 |
| ⑭ | Rear fog lamp | 122 |
| ⑮ | Check Engine | 325 |
| ⑯ | Reserve fuel | 325 |
| ⑰ | ESP® OFF | 321 |
| ⑱ | ABS | 319 |
| ⑲ | Braking (USA only) (Canada only) | 318 |

Multifunction steering wheel



At a glance

| | Function | Page |
|---|--|------|
| ① | Multifunction display | 265 |
| ② | COMAND display; see the separate Operating Instructions | |
| ③ |  Switches on the Voice Control System; see the separate operating instructions | |
| ④ |  Rejects or ends a call Exits phone book/redial memory  Makes or accepts a call Switches to the redial memory   Adjusts the volume  Mute | 270 |

| | Function | Page |
|---|--|------|
| ⑤ |   Selects a menu   Selects a submenu or scrolls through lists  Confirms your selection Hides display messages | 264 |
| ⑥ |  Back Switches off the Voice Control System; see the separate operating instructions | 264 |





Center console

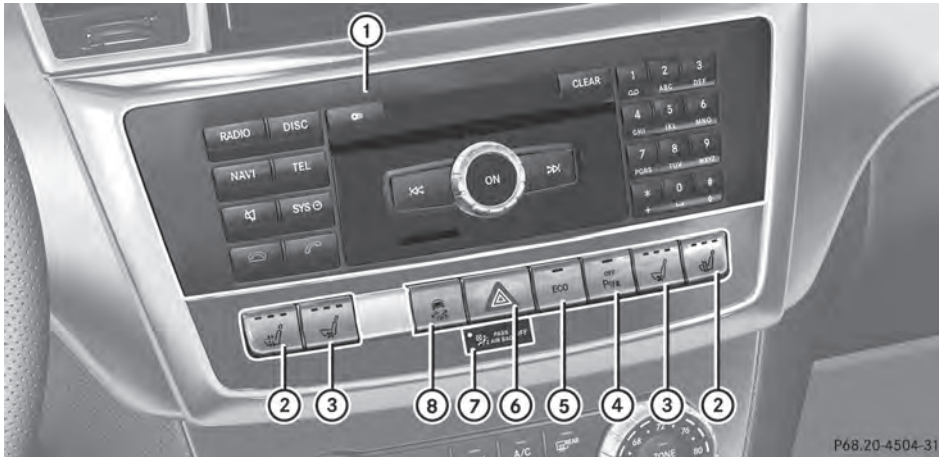

Center console, upper section

At a glance



P68.20-4504-31

| | Function | Page |
|---|---|------|
| ① | COMAND; see the separate operating instructions | |
| ② |  Seat heating | 107 |
| ③ |  Seat ventilation | 109 |
| ④ |  PARKTRONIC | 213 |
| ⑤ |  ECO start/stop function | 161 |

| | Function | Page |
|---|--|------|
| ⑥ |  Hazard warning lamps | 124 |
| ⑦ |  Indicator lamp | 48 |
| ⑧ |  ESP® | 71 |

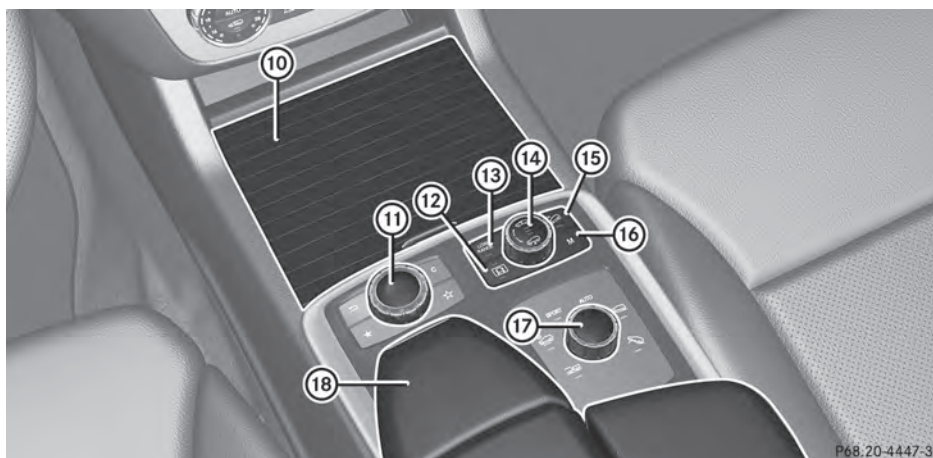

Center console, lower section





P68.20-4447-31

At a glance

i Vehicles with ON&OFFROAD menu



| | Function | Page |
|---|---|------|
| ⑩ | Cup holders | 343 |
| | Ashtray | 346 |
| | Cigarette lighter | 346 |
| | Power socket | 347 |
| ⑪ | COMAND controller; see the separate operating instructions | |
| ⑫ |  ON&OFFROAD menu button | 252 |
| ⑬ |  LOW RANGE off-road gear | 250 |

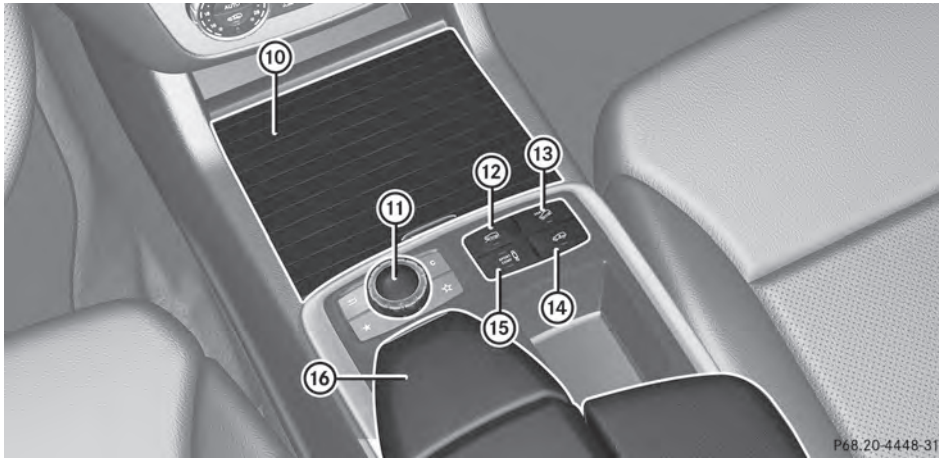



| | Function | Page |
|---|---|------|
| ⑭ |  Level control | 204 |
| ⑮ |  DSR (Downhill Speed Regulation) | 246 |
| ⑯ |  Manual drive program | 171 |
| ⑰ | Selector wheel for on-road programs | 243 |
| | Selector wheel for off-road programs | 248 |
| ⑱ | Stowage compartment | 334 |



P68.20-4448-31

i Vehicles without ON&OFFROAD menu and AMG vehicles

| | Function | Page |
|---|---|------|
| ⑩ | Cup holders | 343 |
| | Ashtray | 346 |
| | Cigarette lighter | 346 |
| | Power socket | 347 |
| ⑪ | COMAND controller; see the separate operating instructions | |
| ⑫ |  Selects off-road program (vehicles with AIRMATIC package) | 248 |
| |  Selects the drive program | 169 |
| | Selects the drive program (AMG vehicles) | 169 |

| | Function | Page |
|---|--|------|
| ⑬ |  DSR (Downhill Speed Regulation) | 246 |
| ⑭ |  Level control (vehicles with AIRMATIC package) | 210 |
| ⑮ |  Adaptive Damping System (vehicles with AIRMATIC package) | 209 |
| |  Adjusts AMG adaptive damping system (AMG vehicles) | 212 |
| ⑯ | Stowage compartment | 334 |

Overhead control panel

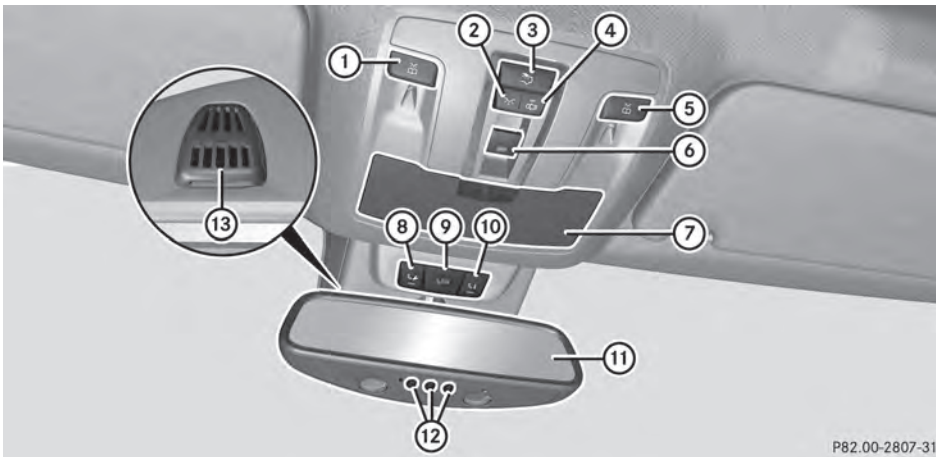

P82.00-2807-31

At a glance











| | Function | Page | | Function | Page |
|---|--|----------|---|---|------|
| ① | Switches the left-hand reading lamp on/off | 127 | ⑦ | Eyeglasses compartment | 334 |
| ② | Switches the front interior lighting on | 128 | ⑧ | Roadside Assistance call button (mbrace system) | 353 |
| ③ | Switches the rear interior lighting on/off | 128 | ⑨ | SOS button (mbrace system) | 351 |
| ④ | Switches the front interior lighting/automatic interior lighting control off | 127 | ⑩ | MB Info call button (mbrace system) | 353 |
| ⑤ | Switches the right-hand reading lamp on/off | 127 | ⑪ | Rear-view mirror | 113 |
| ⑥ | Opens/closes the sliding sunroof Opens/closes the panorama roof with power tilt/sliding panel with roller sunblinds | 97 98 | ⑫ | Buttons for the garage door opener | 361 |
| | | | ⑬ | Microphone for mbrace (emergency call system) telephone and the Voice Control System ¹ | |



¹ Voice Control System only available together with COMAND. Observe the additional operating instructions.

Door control panel



P72.10-3859-31

| | Function | Page |
|---|--|------|
| ① | Opens the door | 85 |
| ② |   Unlocks/locks the vehicle | 85 |
| ③ |     Stores settings for the seat, exterior mirrors and steering wheel (memory function) | 116 |
| ④ | Adjusts the seats | 103 |
| ⑤ |     Adjusts and folds the exterior mirrors in/out electrically | 113 |

| | Function | Page |
|---|---|------|
| ⑥ |  Opens/closes the side windows | 92 |
| ⑦ |  Opens/closes the tailgate | 90 |
| ⑧ |  Activates/deactivates the override feature for the side windows in the rear compartment | 65 |

| | |
|--------------------------------------|----|
| Useful information | 42 |
| Panic alarm | 42 |
| Occupant safety | 42 |
| Children in the vehicle | 60 |
| Driving safety systems | 65 |
| Theft deterrent locking system | 75 |

Useful information

- i** This Operator's Manual describes all models and all standard and optional equipment of your vehicle available at the time of publication of the Operator's Manual. Country-specific differences are possible. Please note that your vehicle may not be equipped with all features described. This also applies to safety-related systems and functions.
- i** Read the information on qualified specialist workshops: (▷ page 27).

Panic alarm



- ▶ **To activate:** press **PANIC** button ① for at least one second.
An alarm sounds and the exterior lighting flashes.
 - ▶ **To deactivate:** press **PANIC** button ① again.
- or
- ▶ Insert the SmartKey into the ignition lock.
- or
- ▶ Press the KEYLESS-GO Start/Stop button.
The KEYLESS-GO key must be in the vehicle.

Occupant safety

Important safety notes

⚠ WARNING

Modifications to or work improperly conducted on restraint system components or their wiring, as well as tampering with interconnected electronic systems, can lead to the restraint systems no longer functioning as intended.

Air bags or Emergency Tensioning Devices (ETDs), for example, could deploy inadvertently or fail to deploy in accidents although the deceleration threshold for air bag deployment is exceeded. Therefore, never modify the restraint systems. Do not tamper with electronic components or their software.

In this section, you will learn the most important facts about the restraint system components of the vehicle.

The restraint system consists of:

- seat belts
- child restraint systems
- LATCH-type (ISOFIX) child seat anchors

Additional protection is provided by:

- SRS (Supplemental Restraint System)
- PRE-SAFE®
- air bag system components with:
 - PASSENGER AIR BAG OFF indicator lamp
 - front-passenger seat with Occupant Classification System (OCS)

The different air bag systems work independently of each other. The protective functions of the system work in conjunction with each other. Not all air bags are always deployed in an accident.

- i** See "Children in the vehicle" for information on infants and children traveling with you in the vehicle restraint systems for infants and children (▷ page 60).

SRS (Supplemental Restraint System)

Introduction

SRS consists of:

-  SRS warning lamp
- Air bags
- The air bag control unit with crash sensors
- Emergency Tensioning Devices for the front seat belts and the outer seat belts in the rear
- Belt force limiters

SRS reduces the risk of occupants coming into contact with the vehicle's interior in the event of an accident. It can also reduce the effect of the forces to which occupants are subjected during an accident.

SRS warning lamp

WARNING

The SRS self-check has detected a malfunction if the  SRS indicator lamp:

- does not light up at all
- does not go out after approximately four seconds after the engine is started
- lights up after the engine is started or while the vehicle is in motion

For your safety, Mercedes-Benz strongly recommends that you have the system checked as soon as possible at a qualified specialist workshop. SRS may otherwise fail to activate when it is needed in the event of an accident, which could lead to serious or fatal injuries. SRS might also be activated unexpectedly and unnecessarily, which could also result in injury.

In addition, work carried out improperly on SRS may render SRS inoperative or cause unintended air bag deployment. Work on the SRS system should only be carried out by qualified specialist personnel. Consult a qualified specialist workshop.

If it is necessary to modify an air bag system to accommodate a person with disabilities, contact an authorized Mercedes-Benz Center

for details. USA only: for further information, contact our Customer Assistance Center at 1-800-FOR-MERcedes (1-800-367-6372).

SRS functions are checked regularly when you switch on the ignition and when the engine is running. Therefore, malfunctions can be detected in good time.

The  SRS warning lamp in the instrument cluster lights up when the ignition is switched on. It goes out no later than a few seconds after the engine is started.

The SRS components are in operational readiness when the  SRS warning lamp goes out while the engine is running.

Safety guidelines for seat belts, Emergency Tensioning Devices (ETDs) and air bags

WARNING

- Damaged seat belts or seat belts that have been subjected to stress in an accident must be replaced. Their anchoring points must also be checked. Only use seat belts installed or supplied by an authorized Mercedes-Benz Center.
- Air bags and pyrotechnic Emergency Tensioning Devices (ETDs) contain perchlorate material, which may require special handling and regard for the environment. Check your national disposal guidelines. California residents, see www.dtsc.ca.gov/HazardousWaste/Perchlorate/index.cfm.
- Air bags and ETDs are designed to function on a one-time-only basis. An air bag or ETD that has deployed must be replaced. PRE-SAFE® has electrically operated reversible belt tensioners in addition to the pyrotechnic ETDs.
- Do not pass seat belts over sharp edges. They could tear.
- Do not make any modification that could change the effectiveness of the seat belts.

- Do not bleach or dye seat belts as this may severely weaken them. In a crash they may not be able to provide adequate protection.
- No modifications of any kind may be made to any components or wiring of the SRS.
- Do not change or remove any component or part of the SRS.
- Do not install additional trim material, seat covers, badges, etc. to the:
 - padded steering wheel boss
 - knee bag covers
 - front-passenger air bag cover
 - outer side of front seat bolsters
 - outer side of rear bench seat backrest seat bolsters
 - roof lining trim
- Do not install additional electrical/ electronic equipment on or near SRS components and wiring.
- Keep area between air bags and occupants free of objects (e.g. packages, purses, umbrellas, etc.).
- Do not hang items such as coat hangers from the coat hooks or handles over the door. These items may be thrown around in the vehicle and cause head and other injuries when the window curtain air bag is deployed.
- Air bag system components will be hot after an air bag has inflated. Do not touch them.
- Never place your feet on the instrument panel, dashboard, or on the seat. Always keep both feet on the floor in front of the seat.
- Improper repair work on the SRS creates a risk of rendering the SRS inoperative or causing unintended air bag deployment. Work on the SRS must therefore only be performed by qualified technicians. Contact an authorized Mercedes-Benz Center.
- For your protection and the protection of others, when scrapping the air bag unit or ETD, our safety instructions must be

followed. These instructions are available from any authorized Mercedes-Benz Center.

- Given the considerable deployment speed, required inflation volume, and the material of the air bags, there is the possibility of abrasions or other, potentially more serious injuries resulting from air bag deployment.

If you sell your vehicle, Mercedes-Benz strongly recommends that you inform the subsequent owner that the vehicle is equipped with SRS. Also, refer them to the applicable section in the Operator's Manual.

Air bags

Important safety notes

WARNING

Air bags are designed to reduce the incidence of injuries and fatalities in certain situations:

- frontal impacts (driver's and front-passenger front air bags and driver's knee bag)
- side impacts (side impact air bags and window curtain air bags)
- rollover (window curtain air bags)

However, no system available today can completely eliminate injuries and fatalities. When the air bags are deployed, a small amount of powder is released. The powder generally does not constitute a health hazard and does not indicate that there is a fire in the vehicle. In order to prevent potential breathing difficulties, you should leave the vehicle as soon as it is safe to do so. If you have any breathing difficulty but cannot get out of the vehicle after the air bag inflates, then get fresh air by opening a window or door.

WARNING

In order to reduce the potential danger of injuries caused during the deployment of the front air bags, the driver and front passenger

must always be correctly seated and wear their seat belts.

For maximum protection in the event of a collision, you must always be in the normal seat position with your back against the backrest. Fasten your seat belt and make sure that it is correctly positioned on your body.

As the air bag inflates with considerable speed and force, a proper seating position and correct positioning of the hands on the steering wheel will help to keep you at a safe distance from the air bag. Occupants who are not wearing their seat belt, are not seated properly or are too close to the air bag can be seriously injured or killed by an air bag, as it inflates with great force instantaneously:

- sit with the seat belt fastened correctly and in a position that is as upright as possible with your back against the backrest.
- move the driver's seat as far back as possible, still permitting proper operation of vehicle controls. The distance from the center of the driver's chest to the center of the air bag cover on the steering wheel must be at least 10 inches (25 cm). You should be able to accomplish this by adjusting the seat and steering wheel. If you have any difficulties, please contact an authorized Mercedes-Benz Center.
- do not lean your head or chest close to the steering wheel or dashboard.
- only hold the steering wheel on the outside. Placing hands and arms inside the rim can increase the risk and potential severity of hand/arm injury if the driver front air bag inflates.
- adjust the front-passenger seat as far back as possible from the dashboard when the seat is occupied.
- occupants, especially children, should never place their bodies or lean their heads in the area of the door where the side impact air bag inflates. This could result in serious or fatal injuries should the side impact air bag be deployed. Always sit as upright as possible, wear the seat belt

properly and use an appropriately sized infant restraint, toddler restraint or booster seat recommended for the size and weight of the child.

Failure to follow these instructions can result in severe injuries to you or other occupants.

If you sell your vehicle, it is important that you make the buyer aware of this safety information. Be sure to give the buyer this Operator's Manual.

WARNING

Accident research shows that the safest place for children in an automobile is in a rear seat.

A side impact air bag related injury may occur if occupants, especially children, are not properly seated or restrained when next to a side impact air bag which needs to deploy rapidly in a side impact in order to do its job.

To help avoid the possibility of injury, please follow these guidelines:

- (1) Always sit as upright as possible and use the seat belts properly. Make sure that children 12 years old and under use an appropriately sized child restraint, infant restraint, or booster seat recommended for the size and weight of the child.
- (2) Always wear seat belts properly.

If the air bags are deployed, you will hear a bang, and a small amount of powder may also be released. Only in rare cases will the bang affect your hearing. The powder that is released generally does not constitute a health hazard. The  SRS warning lamp lights up.

The air bags are deployed if the air bag control unit detects the need for deployment. Only in the event of such a situation will the air bags provide their supplemental protection.

If the driver and front passenger do not wear their seat belts, it is not possible for the air bags to provide their supplemental protection.

In the event of other types of impacts and impacts below air bag deployment thresholds, the air bags will not deploy. The driver and passengers will then be protected to the extent possible by a properly fastened seat belt. A properly fastened seat belt is also needed to provide the best possible protection in a rollover.

Air bags provide additional protection; they are not, however, a substitute for seat belts. All vehicle occupants must fasten their seat belts regardless of whether your vehicle is equipped with air bags or not.

It is important for your safety and that of your passengers to have deployed air bags replaced and to have any malfunctioning air bags repaired. This will help to make sure the air bags continue to perform their protective function for the vehicle occupants in the event of a crash.

Front air bags



Driver's air bag ① deploys in front of the steering wheel; front-passenger front air bag ② deploys in front of and above the glove box.

The front air bags increase protection for the driver's and front-passenger's head and chest.

They are deployed:

- in the event of certain frontal impacts
- if the system determines that air bag deployment can offer additional protection to that provided by the seat belt

- depending on whether the seat belt is being used
- independently of other air bags in the vehicle

If the vehicle overturns, the front air bags are generally not deployed. If the system detects high vehicle deceleration in a longitudinal direction, the front air bags are deployed.

When a child restraint system is installed on the front-passenger seat and the  PASSENGER AIRBAG OFF indicator lamp in the center console does not light up:

- a child restraint system without a transponder for the air bag deactivation system is installed or
- a child restraint system with a transponder has not been installed properly.

Your vehicle has adaptive, two-stage front air bags. In the event of a collision, the air bag control unit evaluates the vehicle deceleration. In the first deployment stage, the front air bag is filled with enough propellant gas to reduce the risk of injuries. The front air bag is fully deployed if a second deployment threshold is exceeded within a few milliseconds.

The deployment of front-passenger front air bag ② is also influenced by the weight category of the front passenger, which is determined by the Occupant Classification System (OCS) (> page 48).

The lighter the passenger side occupant, the higher the vehicle deceleration rate required (predicted at the start of the impact) for second-stage inflation of the front-passenger front air bag. In the second stage, the front air bags are inflated with the maximum amount of propellant gas available.

The front air bags are not deployed in situations where a low impact severity is predicted. You will then be protected by the fastened seat belt.

Front-passenger front air bag ② will only deploy if:

- the system, based on the OCS weight sensor readings, has detected that the front-passenger seat is occupied.
- the  indicator lamp on the center console is not lit (> page 48).
- the air bag control unit predicts a high impact severity.

Driver's knee bag



Driver's knee bag ① deploys under the steering column. The driver's knee bag is always deployed along with the driver's front air bag. The driver's knee bag is designed to operate together with the front air bags in frontal impacts if certain thresholds are exceeded. The driver's knee bag operates best in conjunction with correctly positioned and fastened seat belts.

The driver's knee bag increases protection of the driver against:

- knee injuries
- thigh injuries
- lower leg injuries

Side impact air bags

WARNING

Only use seat covers which have been tested and approved by Mercedes-Benz for your vehicle model. Using other seat covers may interfere with or prevent the deployment of the side impact air bags. Contact an

authorized Mercedes-Benz Center for availability.

WARNING

The pressure sensors for side impact air bag control are located in the doors. Do not modify any components of the doors or door trim panels including, for example, the addition of door speakers.

Improper repair work on the doors or the modification or addition of components to the doors create a risk of rendering the side impact air bags inoperative or causing unintended air bag deployment. Work on the doors must therefore only be performed by qualified technicians. Contact an authorized Mercedes-Benz Center.



Front side impact air bags ① and side impact air bags in the 2nd row of seats ② inflate next to the outer seat cushion.

When deployed, the side impact air bags offer additional protection for the thorax and, on the front seats, the pelvis of the vehicle occupants on the side of the vehicle on which the impact occurs. However, they do not protect the:

- head
- neck
- arms

The side impact air bags are deployed:

- on the side on which an impact occurs
- at the start of an accident with a high rate of lateral vehicle deceleration or acceleration, e.g. in a side impact

- regardless of whether the seat belt on the driver's seat and the outer seats of the 2nd row of seats is used
- independently of the front air bags
- independently of the ETDs

If the vehicle rolls over, the side impact air bags are generally not deployed. side impact air bags are deployed if the system detects high vehicle deceleration or acceleration in a lateral direction, or also if the vehicle rolls over, and the system determines that side impact air bag deployment can offer additional protection to that provided by the seat belt.

Side impact air bags will not deploy in side impacts which do not exceed the system's preset deployment thresholds for lateral acceleration/deceleration. You will then be protected by the fastened seat belt.

The side impact air bag on the front-passenger side is not deployed in the following situations:

- the OCS system detects that the front-passenger seat is not occupied, and
- the front-passenger seat belt is not fastened.

The side impact air bag on the front-passenger side will deploy if the front-passenger seat belt is fastened, regardless of whether the front-passenger seat is occupied or not.

Window curtain air bags

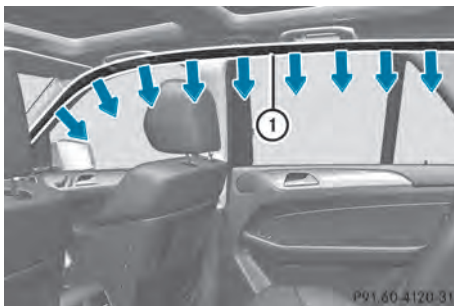

Window curtain air bags (1) enhance the level of protection for the head, but not chest or arms, of the vehicle occupants on the side of the vehicle on which the impact occurs.

The window curtain air bags are integrated into the side of the roof frame and deploy in the area from the A-pillar to the C-pillar.

Window curtain air bags are deployed:



- at the start of an accident with a high rate of lateral vehicle deceleration or acceleration, e.g. in a side impact
- on the side on which an impact occurs
- on the driver's side and passenger side, in the event of a vehicle rollover and if the system determines that air bag deployment can offer the vehicle occupants additional protection to that provided by the seat belt
- independently of the use of the seat belt
- regardless of whether the front-passenger seat is occupied
- independently of the front air bags

Window curtain air bags will not deploy in impacts which do not exceed the system's preset deployment thresholds for lateral acceleration/deceleration. You will then be protected by the fastened seat belt.

Occupant Classification System (OCS)

Method of operation

WARNING

If the  indicator lamp illuminates when an adult or someone larger than a small individual is in the front passenger seat, have the front passenger reposition himself or herself in the seat until the  indicator lamp goes out.

In the event of a collision, the air bag control unit will not allow front passenger front air bag deployment when the OCS has classified the front passenger seat occupant as weighing as much as or less than a typical 12-month-old



child in a standard child restraint or if the front passenger seat is classified as being empty.

When the OCS senses that the front passenger seat occupant is classified as being up to or less than the weight of a typical 12-month-old child in a standard child restraint, the  indicator lamp will illuminate when the engine is started and remain illuminated. This indicates that the front passenger front air bag is deactivated.

When the OCS senses that the front passenger seat is classified as being empty, the  indicator lamp will illuminate when the engine is started and remain illuminated. This indicates that the front passenger front air bag is deactivated.

When the OCS senses that the front passenger seat occupant is classified as being heavier than the weight of a typical 12-month-old child seated in a standard child restraint or as being a small individual (such as a young teenager or a small adult), the

 indicator lamp will illuminate for approximately 6 seconds when the engine is started. Depending on occupant weight sensor readings from the seat, it will then remain illuminated or go out. With the

 indicator lamp illuminated, the front passenger front air bag is deactivated. With the  indicator lamp out, the front passenger front air bag is activated.

When the OCS senses that the front passenger seat occupant is classified as an adult or someone larger than a small individual, the  indicator lamp will illuminate for approximately six seconds when the engine is started and then go out. This indicates that the front passenger front air bag is activated.

If the  indicator lamp is illuminated, the front passenger front air bag is deactivated and will not be deployed.

If the  indicator lamp is not illuminated, the front passenger front air bag is activated and will be deployed

- in the event of certain frontal impacts
- if the impact exceeds a predetermined triggering threshold
- independent of the side impact air bag or pelvis air bag

If the front passenger front air bag is deployed, the rate of inflation will be influenced by

- the rate of vehicle deceleration as assessed by the air bag control unit
- the front passenger's weight category as identified by the OCS





WARNING

According to accident statistics, children are safer when properly restrained on the rear seats than on the front-passenger seat. Thus, we strongly recommend that children be placed in the rear seats whenever possible. Regardless of seating position, children 12 years old and under must be seated and properly secured in an appropriate infant restraint, toddler restraint, or booster seat recommended for the size and weight of the child.

The infant or child restraint must be properly secured with the vehicle's seat belt, the seat belt and Top Tether strap, or lower anchors and Top Tether strap, fully in accordance with the child seat manufacturer's instructions.

Occupants, especially children, should always sit as upright as possible, wear the seat belt properly and use an appropriately sized infant restraint, toddler restraint, or booster seat recommended for the size and weight of the child.



Children can be killed or seriously injured by an inflating air bag. Note the following important information when circumstances require you to place a child in the front-passenger seat:

- Your vehicle is equipped with air bag technology designed to deactivate the front-passenger front air bag in your vehicle when the system senses the weight of a typical 12-month-old child or less along with the weight of a standard appropriate child restraint on the front-passenger seat.
- A child in a rear-facing child restraint on the front-passenger seat will be seriously injured or even killed if the front-passenger front air bag inflates in a collision which could occur under some circumstances, even with the air bag technology installed in your vehicle. The only means to eliminate this risk completely is never to place a child in a rear-facing child restraint in the front-passenger seat. We therefore strongly recommend that you always place a child in a rear-facing child restraint on the rear seat.
- If you install a rear-facing child restraint on the front-passenger seat, make sure the  indicator lamp is illuminated, indicating that the front-passenger front air bag is deactivated. Should the  indicator lamp not illuminate or go out while the restraint is installed, please check installation. Periodically check the  indicator lamp while driving to make sure that the  indicator lamp is illuminated. If the  indicator lamp goes out or remains out, do not transport a child on the front-passenger seat until the system has been repaired.

A child in a rear-facing child restraint on the front-passenger seat will be seriously injured or even killed if the front-passenger front air bag inflates.

- If you place a child in a forward-facing child restraint on the front-passenger seat:
 - move the seat as far back as possible
 - use the proper child restraint recommended for the age, size and weight of the child
 - secure child restraint with the vehicle's seat belt according to the child seat manufacturer's instructions
- For children larger than the typical 12-month-old child, the front-passenger front air bag may or may not be activated.

WARNING

If the red  SRS warning lamp in the instrument cluster and the  indicator lamp light up simultaneously, the OCS is malfunctioning. The front passenger front air bag will be deactivated in this case. Have the system checked by qualified technicians as soon as possible. Contact an authorized Mercedes-Benz Center.

Only have the seat repaired or replaced at an authorized Mercedes-Benz Center.

In order to ensure proper operation of the air bag system and OCS:

- Sit with the seat belt properly fastened in a position that is as upright as possible with your back against the seat backrest.
- When seated, a passenger should not position him/herself in such a way as to cause the passenger's weight to be lifted from the seat cushion as this may result in the OCS being unable to correctly approximate the passenger's weight category.
- Read and observe all warnings in this chapter.



If the SmartKey has been removed from the ignition lock or is in position **0**,

 indicator lamp **1** does not light up.

The Occupant Classification System (OCS) categorizes the occupant on the front-passenger seat using a weight sensor. The front-passenger front air bag is deactivated automatically for certain weight categories.

 indicator lamp **1** shows you the current status. If

 indicator lamp **1** lights up, the front-passenger air bag is disabled.

The system does not deactivate:

- the side impact air bag
- the window curtain air bag
- the Emergency Tensioning Devices

To be classified correctly, the front passenger must sit:

- with the seat belt fastened correctly
- in a position that is as upright as possible with their back against the seat backrest
- with their feet on the floor

The OCS weight sensor reading is affected if the occupant's weight is transferred, e.g. by leaning on the armrest.

If the front-passenger seat, the seat cover or the seat cushion are damaged, have the necessary repair work carried out at a qualified specialist workshop.

For safety reasons, Mercedes-Benz recommends that you only use seat accessories that have been approved by Mercedes-Benz.

Both the driver and the front passenger should always observe the  indicator lamp to determine whether or not the front passenger is positioned correctly. Also observe the air bag display messages, which appear in the instrument cluster (> page 294).

If the driver's air bag deploys, this does not mean that the front-passenger front air bag will also deploy.

The OCS may have detected that the seat:

- is empty or occupied by the weight of a typical child up to twelve months old, seated in a child restraint system
- is occupied by a small individual, such as a young teenager or a small adult
- is occupied by a child in a child restraint system whose weight is greater than that of a typical twelve month old child.

These are examples of when the OCS deactivates the front-passenger front air bag. Deactivation takes place although the collision fulfills the criteria for deploying the driver's air bag.

System self-test

WARNING

If the  indicator lamp does not illuminate, the system is not functioning. You must contact an authorized Mercedes-Benz Center before seating any child on the front passenger seat.

WARNING

Never place anything between seat cushion and child seat (e.g. a pillow), since it reduces the effectiveness of the OCS. The underside and rear side child restraint system must be placed entirely on the seat cushion and the backrest of the front-passenger seat backrest.

If necessary, adjust the tilt of the passenger seat backrest.



An incorrectly mounted child seat could cause injuries to the child in case of an accident, instead of increasing protection for the child.

Follow the manufacturer's instructions for installation of child restraint systems.

The  indicator lamp lights up:

- if you turn the SmartKey in the ignition lock to position **1** or **2**
- if you press the KEYLESS-GO Start/Stop button once or twice on vehicles with KEYLESS-GO
- if an adult is seated properly on the front-passenger seat and the OCS classifies the occupant as an adult



The  indicator lamp goes out after approximately six seconds.

If the seat is not occupied and the OCS detects that the front-passenger seat is empty, the  indicator lamp will continue to light up. The  indicator lamp will not go out.



For more information about the OCS, see "Problems with the Occupant Classification System" (▷ page 53).







Problems with the occupant classification system

WARNING

If the   indicator lamp illuminates and remains illuminated when the weight of a typical adult or someone larger than a small individual has been detected on the passenger seat, do not allow any occupant to use the passenger seat until the system has been repaired.

WARNING

If the   indicator lamp does not illuminate or remains out with the weight of a typical 12-month-old child in a standard child restraint or less, or is unoccupied, on the front-passenger seat, do not transport a child on the front-passenger seat until the system has been repaired.

| Problem | Possible causes/consequences and ► Solutions |
|---|--|
| <p>The   indicator lamp lights up and stays on.</p> <p>The person on the front-passenger seat:</p> <ul style="list-style-type: none"> • has the weight of a typical adult • has been determined by the system not to be a child | <p>The OCS is malfunctioning.</p> <ul style="list-style-type: none"> ► Have the OCS checked as soon as possible at a qualified specialist workshop. ► Observe the additional messages in the multifunction display (► page 294). |
| <p>The   indicator lamp does not light up and/or does not stay on.</p> <p>The front-passenger seat is:</p> <ul style="list-style-type: none"> • unoccupied • occupied with a weight up to that of a typical twelve-month-old child in a standard child restraint system | <p>The OCS is malfunctioning.</p> <ul style="list-style-type: none"> ► Make sure there is nothing between the seat cushion and the child seat. ► Check the installation of the child restraint system. ► Make sure that no objects are applying additional weight onto the seat. ► If the   indicator lamp remains off, have the OCS checked as soon as possible at a qualified specialist workshop. Do not transport a child on the front-passenger seat as long as the OCS is not functioning. ► Observe the additional messages in the multifunction display (► page 294). |

PRE-SAFE® (anticipatory occupant protection system) **WARNING**

The PRE-SAFE® system reduces the impact of an accident on vehicle occupants, as long as their seat belts have been fastened correctly. Although your vehicle is equipped with a PRE-SAFE® system, the possibility of injury in the event of an accident cannot be ruled out. You should therefore always drive carefully and adapt your driving style to the prevailing road, weather and traffic conditions.

 **WARNING**

Make sure that nobody can become trapped as you adjust the seat.

-  Make sure that there are no objects in the footwell or behind the seats when resetting the seats. There is a risk that the seats and/or the objects could be damaged.

PRE-SAFE® takes preemptive measures to protect occupants in certain hazardous situations.

PRE-SAFE® intervenes:

- if BAS intervenes, e.g. in emergency braking situations
- if BAS PLUS intervenes powerfully – on vehicles with DISTRONIC PLUS
- if, on vehicles with DISTRONIC PLUS, the radar sensor system detects an imminent danger of collision in certain situations
- in critical driving situations, e.g. when physical limits are exceeded and the vehicle understeers or oversteers severely

PRE-SAFE® takes the following measures depending on the hazardous situation detected:

- the front seat belts are pre-tensioned.
- vehicles with the memory function: the front-passenger seat is adjusted if it is in an unfavorable position.

- vehicles with a multicontour seat: the air pressure in the side bolsters of the seat backrest is increased.
- if the vehicle skids, the sliding sunroof/panorama roof with power tilt/sliding panel and the side windows are closed so that only a small gap remains.

If the hazardous situation passes without resulting in an accident, PRE-SAFE® slackens the belt pretensioning. In vehicles with multicontour seats, the air pressure in the side bolsters is reduced again. All settings made by PRE-SAFE® can then be reversed.

If the seat belts are not released:

- ▶ Move the backrest or seat back slightly, but only when the vehicle is stationary. The belt pretensioning is reduced and the locking mechanism is released.

More information about seat belt adjustment, a convenience function integrated into PRE-SAFE®, can be found in the "Seat belt adjustment" section (▷ page 57).

Seat belts**Important safety notes** **WARNING**

Always fasten your seat belt before driving off. Always make sure all of your passengers are properly restrained. You and your passengers should always wear seat belts.

Failure to wear and properly fasten and position your seat belt greatly increases your risk of injuries and their likely severity in an accident.

If you are ever in an accident, your injuries can be considerably more severe without your seat belt properly buckled. Without your seat belt buckled, you are much more likely to hit the interior of the vehicle or be ejected from it. You can be seriously injured or killed.

In the same crash, the possibility of injury or death is lessened if you are properly wearing your seat belt. The air bags can only protect

as intended if the occupants are properly wearing their seat belts.

WARNING

Never ride in a moving vehicle with the seat backrest in an excessively reclined position as this can be dangerous. You could slide under the seat belt in a collision. If you slide under it, the seat belt would apply force at the abdomen or neck. That could cause serious or even fatal injuries. The seat backrest and seat belt provide the best restraint when the wearer is in a position that is as upright as possible and the seat belt is properly positioned on the body.

WARNING

Never let more people ride in the vehicle than there are seat belts available. Make sure everyone riding in the vehicle is correctly restrained with a separate seat belt. Never use a seat belt for more than one person at a time.

WARNING

Always have damaged seat belts or seat belts that have been subjected to a load in an accident replaced and the anchorages checked.

Only use seat belts that have been approved by Mercedes-Benz.

Never tamper with seat belts. This can result in the unintended deployment of the Emergency Tensioning Devices or the failure to deploy when necessary.

Do not bleach or dye seat belts, as this may severely weaken them. In the event of a collision, they may be unable to provide adequate protection.

Have all work carried out only by qualified technicians. Consult a qualified specialist workshop.

The use of seat belts and infant and child restraint systems is required by law in:

- all 50 states
- U.S. territories
- the District of Columbia
- all Canadian provinces

Even where this is not required by law, all vehicle occupants should correctly fasten their seat belts before starting the journey.

-  See "Children in the vehicle" (> page 60) for further information on infants and children traveling in the vehicle as well as on child restraint systems.

Correct use of the seat belts

WARNING

USE SEAT BELTS PROPERLY

- Seat belts can only work when used properly. Never wear seat belts in any other way than as described in this section, as that could result in serious injuries in the event of an accident.
- Each occupant should wear their seat belt at all times, because seat belts help reduce the likelihood of and potential severity of injuries in accidents, including rollovers. The integrated restraint system includes SRS (driver front air bag, driver's side knee bag, front-passenger front air bag, side impact air bags, window curtain air bags for the side windows), Emergency Tensioning Devices, seat belt force limiters, and front seat knee bolsters.

The system is designed to enhance the protection offered to properly belted occupants in certain frontal (front air bags, driver's side knee bag and ETDs) and side (side impact air bags, window curtain air bags, and ETDs) impacts which exceed preset deployment thresholds and in certain rollovers (window curtain air bags and ETDs).

- Never wear the shoulder belt under your arm, across your neck or off your shoulder.

In a frontal crash, your body would move too far forward. That would increase the chance of head and neck injuries. The seat belt would also apply too much force to the ribs or abdomen, which could severely injure internal organs such as your liver or spleen.

Adjust the seat belt so that the shoulder section is located as close as possible to the middle of the shoulder. It should not touch the neck. Never pass the shoulder portion of the seat belt under your arm. For this purpose, you can adjust the height of the seat belt outlet.

- Position the lap belt as low as possible on your hips and not across the abdomen. If the lap belt is positioned across your abdomen, it could cause serious injuries in a crash.
- Never wear seat belts over rigid or breakable objects in or on your clothing, such as eyeglasses, pens, keys etc., as these might cause injuries.
- Make sure the seat belt is always fitted snugly. Take special care of this when wearing loose clothing.
- Never use a seat belt for more than one person at a time. Do not fasten a seat belt around a person and another person or other objects at the same time.
- Seat belts should not be worn twisted. In a crash, you would not have the full width of the seat belt to distribute impact forces. The twisted seat belt against your body could cause injuries.
- Pregnant women should also always use a lap-shoulder belt. The lap belt portion should be positioned as low as possible on the hips to avoid any possible pressure on the abdomen.
- Place the seat backrest in a position that is as upright as possible.
- Check your seat belt during travel to make sure it is properly positioned.

- Never place your feet on the instrument panel, dashboard, or on the seat. Always keep both feet on the floor in front of the seat.
- When using a seat belt to secure infant restraints, toddler restraints, or children in booster seats, always follow the child seat manufacturer's instructions.

WARNING

Do not pass seat belts over sharp edges. They could tear.

Do not allow the seat belt to get caught in the door or in the seat adjustment mechanism. This could damage the seat belt.

Never attempt to make modifications to seat belts. This could impair the effectiveness of the seat belts.

Fastening seat belts

WARNING

According to accident statistics, children are safer when properly restrained on the rear seats than on the front-passenger seat. Thus, we strongly recommend that children be placed in the rear seat whenever possible. Regardless of seating position, children 12 years old and under must be seated and properly secured in an appropriately sized child restraint system or booster seat recommended for the size and weight of the child. For additional information, see the "Children in the vehicle" section.

A child's risk of serious or fatal injuries is significantly increased if the child restraints are not properly secured in the vehicle and/or the child is not properly secured in the child restraint.

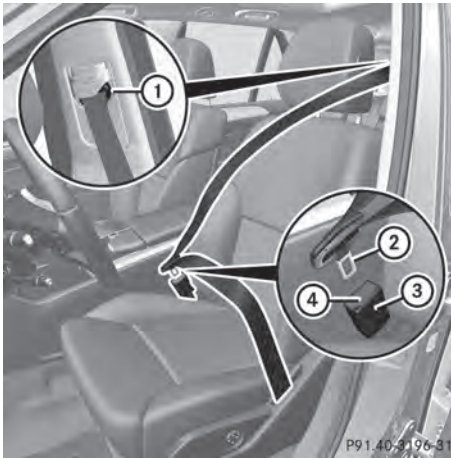

- ▶ Adjust the seat and move the backrest to an almost vertical position (▷ page 102).
- ▶ Pull the seat belt smoothly through belt sash guide ①.
- ▶ Without twisting it, guide the shoulder section of the seat belt across the middle of your shoulder and the lap section across your pelvis.
- ▶ Engage belt tongue ② in buckle ③.
Seat-belt adjustment: if necessary, the driver's and front-passenger seat belts automatically adjust to the upper body (▷ page 57).
- ▶ If necessary, adjust the seat belt to the appropriate height (▷ page 57).
- ▶ If necessary, pull upwards on the shoulder section of the seat belt to tighten the belt across your body.

All seat belts except the driver's seat belt are equipped with a special seat belt retractor to securely fasten child restraint systems in the vehicle. Further information can be found under "Special seat belt retractor" (▷ page 62).

For more information about releasing the seat belt with release button ④, see "Releasing seat belts" (▷ page 58).

Seat belt adjustment

The seat-belt adjustment function adjusts the driver's and front-passenger seat belt to the upper body of the occupants.

The belt strap is tightened slightly when:

- you engage the belt tongue in the belt buckle and you then turn the SmartKey to position **2** in the ignition lock.
- the SmartKey is in position **2** in the ignition lock and you then engage the belt tongue in the buckle.

The seat-belt adjustment will apply a retraction force if any slack is detected between the occupant and the seat belt. Do not hold on to the seat belt tightly while it is adjusting. You can switch the seat-belt adjustment on and off in the on-board computer (▷ page 277).

The seat-belt adjustment is an integral part of the PRE-SAFE® convenience function. More information about PRE-SAFE® can be found under "PRE-SAFE® (preventative occupant protection)" (▷ page 54).

Belt height adjustment

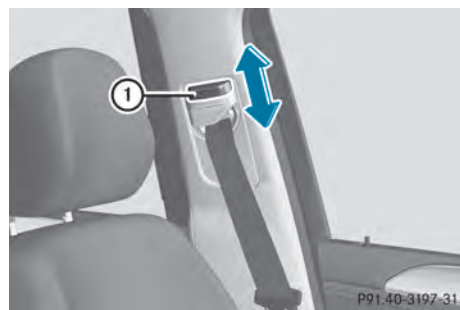

You can adjust the seat belt height on the front seats. Adjust the belt to a height that allows the upper part of the seat belt to be routed across the center of your shoulder.

- ▶ **To raise:** slide the belt sash guide upwards. The belt sash guide engages in various positions.
- ▶ **To lower:** press and hold belt sash guide release ①.

- ▶ Slide the belt sash guide downwards.
- ▶ Release belt sash guide release ① and make sure that the belt sash guide has engaged.

Releasing seat belts

! Make sure that the seat belt is fully rolled up. Otherwise, the seat belt or belt tongue will be trapped in the door or in the seat mechanism. This could damage the door, the door trim panel and the seat belt. Damaged seat belts can no longer fulfill their protective function and must be replaced. Visit a qualified specialist workshop.

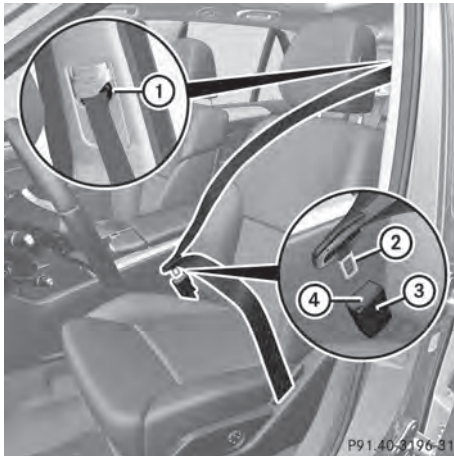

- ① Belt sash guide
- ② Seat belt tongue
- ③ Buckle
- ④ Release button

- ▶ Press release button ④ and guide belt tongue ② back towards belt sash guide ①.

Belt warning for the driver and front passenger

Regardless of whether the driver's and front-passenger seat belts have already been fastened, the  seat belt warning lamp

lights up for six seconds each time the engine is started. It then goes out if the driver and the front passenger have fastened their seat belts.

If the driver's seat belt is not fastened when the engine is started, an additional warning tone will sound. The warning tone goes out after approximately six seconds or once the driver's seat belt is fastened.

If after six seconds the driver or front passenger have not fastened their seat belts and the doors are closed, the  seat belt warning lamp lights up:

- until the driver's or front passenger's seat belt is fastened
- if a vehicle speed of 15 mph (25 km/h) is exceeded, a warning tone also sounds with increasing intensity for a maximum of 60 seconds or until the driver or front passenger have fastened their seat belts.

If the driver/front passenger unfasten their seat belt while the vehicle is in motion, the  seat belt warning lamp lights up and a warning tone sounds again.

The warning tone ceases even if the driver or front passenger have still not fastened their seat belt after 60 seconds. The  seat belt warning lamp stops flashing but remains illuminated.

After the vehicle comes to a standstill, the warning tone is reactivated and the  seat belt warning lamp flashes again if the vehicle speed again exceeds 15 mph (25 km/h).

The  seat belt warning lamp only goes out if:

- both the driver and the front passenger have fastened their seat belts.
- or
- the vehicle is stationary and a door is open.

i For more information on the  seat belt warning lamp, see "Warning and indicator lamps in the instrument cluster, seat belts" (▷ page 317).

Emergency Tensioning Devices, seat belt force limiter

WARNING

Pyrotechnic Emergency Tensioning Devices that have been deployed must be renewed.

For your safety, when disposing of Emergency Tensioning Devices, always observe the safety instructions. These are available from any authorized Mercedes-Benz Center.

The PRE-SAFE® system has electrically operated reversible pre-tensioners that do not require replacement after activation.

! If the front-passenger seat is not occupied, do not engage the seat belt tongue in the buckle on the front-passenger seat. Otherwise, the Emergency Tensioning Device could be triggered in the event of an accident.

- ▶ In order to ensure that the pyrotechnic Emergency Tensioning Devices have not been triggered, always have the seat belts checked after an accident.
If the Emergency Tensioning Devices have been triggered, they must be replaced.

The front seat belts and the outer seat belts in the rear are equipped with Emergency Tensioning Devices and belt force limiters.

The ETDs on the driver's and front-passenger seat consist of pyrotechnic belt buckle tensioners and belt anchor tensioners that are triggered together. The belt buckle tensioner is mounted on the B-pillar and the belt anchor installing is mounted on the side of the seat. After deploying, both tensioners must always be replaced.

The ETDs tighten the seat belts in an accident, pulling them close against the body.

The ETDs do not correct incorrect seat positions or incorrectly fastened seat belts.

The ETDs do not pull vehicle occupants back towards the backrest.

When triggered, seat belt force limiters help to reduce the peak force exerted by the seat belt on the vehicle occupant.

The belt force limiters for the front seats are synchronized with the front air bags, which take on a part of the deceleration force. This results in the force exerted on the occupant being distributed over a greater area.

The ETDs can only be activated when:

- the ignition is switched on.
- the restraint systems are operational; see "SRS warning lamp" (▷ page 43).
- the belt tongue is engaged in the buckle on each of the lap-shoulder belts in the front.
- the front-passenger seat is occupied and the belt tongue is engaged in the buckle on the front-passenger side

The ETDs on the outside seats in the rear compartment are triggered independently of the lock status of the seat belts.

The ETDs are triggered depending on the type and severity of an accident:

- if, in the event of a head-on or rear-end collision, the vehicle decelerates or accelerates rapidly in a longitudinal direction during the initial stages of the impact
- if, in the event of a side impact, on the side opposite the impact the vehicle decelerates or accelerates rapidly in a lateral direction
- if, in certain situations where the vehicle overturns, the system determines that it can provide additional protection

If the ETDs are deployed, you will hear a bang, and a small amount of powder may also be released. Only in rare cases will the bang affect your hearing. The powder that is released generally does not constitute a health hazard. The  SRS warning lamp lights up.

Children in the vehicle

Child restraint systems

Important safety notes

Safety

WARNING

According to accident statistics, children are safer when properly restrained in the rear seating positions than in the front seating position. Thus, we strongly recommend that children be placed in the rear seats whenever possible. Regardless of seating position, children 12 years old and under must be seated and properly secured in an appropriate infant restraint, toddler restraint, or booster seat recommended for the size and weight of the child.





The infant or child restraint must be properly secured with the vehicle's seat belt, the seat belt and top tether strap, or lower anchors and top tether strap, fully in accordance with the child seat manufacturer's instructions.

Occupants, especially children, should always sit as upright as possible, wear the seat belt properly and use an appropriately sized infant restraint, toddler restraint, or booster seat recommended for the size and weight of the child.

Children can be killed or seriously injured by an inflating air bag. Note the following important information when circumstances require you to place a child in the front passenger seat:

- Your vehicle is equipped with air bag technology designed to deactivate the front passenger front air bag in your vehicle when the system senses the weight of a typical 12-month-old child or less along with the weight of a standard appropriate child restraint on the front passenger seat.
- For children larger than the typical 12-month-old child, the front passenger front air bag may or may not be activated. Always make sure the  PASS. AIR BAG OFF indicator lamp is illuminated, indicating that the front passenger front air bag is deactivated.

- A child in a rear-facing child restraint on the front passenger seat will be seriously injured or even killed if the front passenger front air bag inflates in a collision which could occur under some circumstances, even with the air bag technology installed in your vehicle. The only means to completely eliminate this risk is to never place a child in a rear-facing child restraint in the front seat. We therefore strongly recommend that you always place a child in a rear-facing child restraint in a backseat.

- If you must install a rear-facing child restraint on the front passenger seat because circumstances require you to do so, make sure the  PASS. AIR BAG OFF indicator lamp is illuminated, indicating that the front passenger front air bag is deactivated. Should the  PASS. AIR BAG OFF indicator lamp not illuminate or go out while the restraint is installed, please check installation. Periodically check the  PASS. AIR BAG OFF indicator lamp while driving to make sure the  PASS. AIR BAG OFF indicator lamp is illuminated. If the  PASS. AIR BAG OFF indicator lamp goes out or remains out, do not transport a child on the front passenger seat until the system has been repaired.

A child in a rear-facing child restraint on the front passenger seat will be seriously injured or even killed if the front passenger front air bag inflates.

- If you have to place a child in a forward-facing child restraint on the front passenger seat, move the seat as far back as possible, use the proper child restraint recommended for the age, size and weight of the child, and secure child restraint with the vehicle's seat belt according to the child seat manufacturer's instructions.

WARNING

If the child restraint system is not fitted correctly on a suitable seat, it may not fulfil its protective function. In the event of an accident, sharp braking or a sudden change

in direction, the child may not be held securely. The child could thus be seriously or even fatally injured. For this reason, when fitting a child restraint system, observe the manufacturer's installation instructions and the correct use of the child restraint system. Child restraint systems should preferably be fitted on the rear seats. The child is generally better protected there.

The entire base of the child restraint system must always rest on the seat cushion. Therefore, never place objects, e.g. a cushion, under the child restraint system.

Only use child restraint systems with the original cover designed for them. Only replace damaged covers with genuine covers.

We recommend that you use the child restraint systems which have been recommended for Mercedes-Benz.

WARNING

Infants and small children should never share a seat belt with another occupant. In the event of an accident, they could be crushed between the occupant and seat belt.

A child's risk of serious or fatal injuries is significantly increased if the child restraints are not properly secured in the vehicle and/or the child is not properly secured in the child restraint.

Children that are too large for a child restraint must travel in seats using normal seat belts. Position the shoulder belt across the chest and shoulder, not face or neck. A booster seat may be necessary to achieve proper seat belt positioning for children over 41 lb (18 kg) until they reach a height where a lap-shoulder belt fits properly without a booster.

When the child restraint is not in use, remove it from the vehicle or secure it with the seat belt to prevent the child restraint from becoming a projectile in the event of an accident.

WARNING

When leaving the vehicle, always remove the SmartKey from the ignition lock. Always take the SmartKey with you and lock the vehicle. Do not leave children unattended in the vehicle, even if they are secured in a child restraint system, or with access to an unlocked vehicle. A child's unsupervised access to a vehicle could result in an accident and/or serious personal injury. The children could:

- injure themselves on parts of the vehicle
- be seriously or fatally injured through excessive exposure to extreme heat or cold
- injure themselves or cause an accident with vehicle equipment that can be operated even if the SmartKey is removed from the ignition lock or removed from the vehicle, such as seat adjustment, steering wheel adjustment, or the memory function

If children open a door, they could injure other persons or get out of the vehicle and injure themselves or be injured by following traffic.

Do not expose the child restraint system to direct sunlight. The child restraint system's metal parts, for example, could become very hot, and the child could be burned on these parts.

WARNING

Do not carry heavy or hard objects in the passenger compartment or cargo compartment unless they are firmly secured in place.

Unsecured or improperly positioned cargo increases a child's risk of injury in the event of

- strong braking maneuvers
- sudden changes of direction
- an accident

Further information on secure stowage of loads can be found under "Loading guidelines".

If an infant or child is traveling in the vehicle:

- Secure the child with a child or infant seat restraint system appropriate to the age and weight of the child.
- Make sure that the infant or child is properly secured at all times while the vehicle is in motion.

Mercedes-Benz recommends that you always properly secure all infants and children with a child or infant seat restraint system for the trip.

The use of seat belts and infant and child restraint systems is required by law in:

- all 50 states
- U.S. territories
- the District of Columbia
- all Canadian provinces

Infants and children must always be seated in an appropriate infant or child restraint system recommended for the size and weight of the child. The infant or child restraint system must be properly secured in accordance with the manufacturer's instructions.

All infant or child restraint systems must meet the following standards:

- U.S. Federal Motor Vehicle Safety Standards 213 and 225
- Canadian Motor Vehicle Safety Standards 213 and 210.2

An information label on the child restraint system indicates whether it meets these standards. This information is also provided in the installation instructions supplied with the child restraint system.

Always read and follow the manufacturer's instructions when using an infant or child restraint system or booster seat.

Observe the warning labels in the vehicle interior or on the infant or child restraint.

Special seat belt retractor

WARNING

If you release the seat belt when driving, the special seat belt retractor is deactivated.

The released seat belt cannot be engaged again while driving, because the inertia reel pulls in the seat belt a small distance. The child restraint system is no longer properly secured. There is an increased risk of serious injury or even fatal injury.

Always keep the seat belt of the activated special seat belt retractor engaged when driving.

All seat belts except the driver's seat belt are equipped with a special seat belt retractor. When activated, the special seat belt retractor ensures that the seat belt will not slacken once the child restraint system has been secured.

Installing a child restraint system:

- ▶ Always comply with the manufacturer's installation instructions.
- ▶ Pull the seat belt smoothly from the seat belt retractor.
- ▶ Engage the seat belt tongue in the belt buckle.

Activating the special seat belt retractor:

- ▶ Pull the seat belt out fully and let the seat belt retractor retract it again. While the seat belt is retracting, you should hear a ratcheting sound. The special seat belt retractor is activated.
- ▶ Push down on the child restraint system to take up any slack.

Removing a child restraint system/
deactivating the special seat belt retractor:

- ▶ Always comply with the manufacturer's installation instructions.
- ▶ Press the seat belt release button and guide the belt tongue to the belt outlet. The special seat belt retractor is deactivated.

LATCH-type (ISOFIX) child seat anchors in the rear

WARNING

Children that are too large for a child restraint must travel in seats using normal seat belts. Position shoulder belt across the chest and shoulder, not face or neck.

A booster seat may be necessary to achieve proper seat belt positioning for children over 41 lb (18 kg) until they reach a height where a lap/shoulder belt fits properly without a booster.

Install the child restraint system in accordance with the manufacturer's instructions.

Attach the child restraint system to both securing rings.

An incorrectly installed child restraint system could come loose during an accident and seriously or even fatally injure the child.

Child restraint systems or child seat securing rings that are malfunctioning or damaged as the result of a collision must be replaced.

-  When installing the child restraint system, make sure that the seat belt for the middle seat does not get trapped. The seat belt could otherwise be damaged.

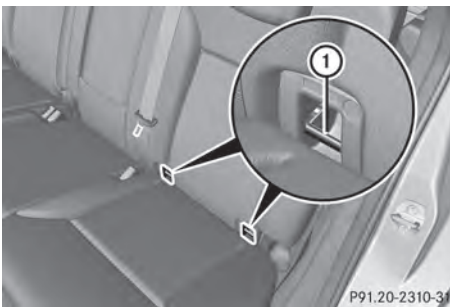

- Install the LATCH-type (ISOFIX) child seat securing system. Comply with the manufacturer's instructions when installing.

ISOFIX is a standardized securing system for specially designed child restraint systems on

the rear seats. Securing rings ① for two LATCH-type (ISOFIX) child restraint systems are installed on the left and right of the rear seats.

Secure child restraint systems without a LATCH-type (ISOFIX) child seat securing system using the seat belts in the vehicle. When installing child restraint systems, you must observe the manufacturer's installation instructions.

Top Tether

Top Tether anchorages

WARNING

Always lock the rear seat backrests in their upright position when the rear seats are occupied by passengers. Lock the rear seat backrests in their upright position before installing the Top Tether straps or when the cargo compartment is not in use. Make sure that rear seat backrests are secured properly by pushing and pulling on the seat backrests. If the seat backrest is not locked properly, the seat backrest could fold forward. The child restraint system is no longer supported properly or held in position and can no longer fulfill its function. This could cause serious or even fatal injuries.

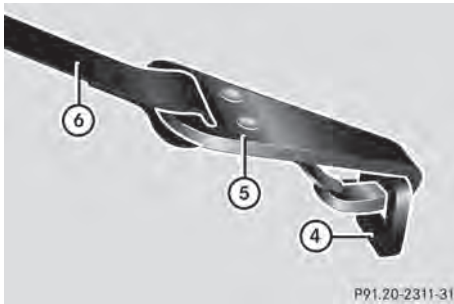
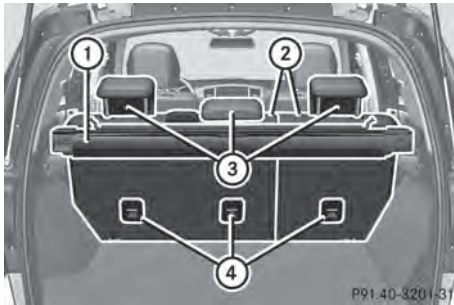

Top Tether provides an additional connection between a child restraint system, secured with a LATCH-type (ISOFIX) child seat mount, and the rear seat. This helps reduce the risk of injury even further.

The Top Tether anchorages are located on the rear side of the rear seat backrests.

- ▶ Move head restraint ③ upwards.
- ▶ Install the LATCH-type (ISOFIX) child restraint system with Top Tether. Comply with the manufacturer's installation instructions when doing so.
- ▶ Route Top Tether belt ⑥ under head restraint ③ between the two head restraint bars.
- ▶ Guide Top Tether belt ⑥ downwards between cargo compartment cover ① and rear seat backrest ②.
- ▶ Hook Top Tether hook ⑤ of Top Tether belt ⑥ into Top Tether anchorage ④.

Ensure that:

- Top Tether hook ⑤ is hooked into Top Tether anchorage ④ as shown.
 - Top Tether belt ⑥ is not twisted.
 - Top Tether belt ⑥ is routed between rear seat backrest ② and cargo compartment cover ① if cargo compartment cover ① is installed.
 - Top Tether belt ⑥ is routed between the rear seat backrest ② and the cargo net if the cargo net is installed.
- ▶ Tension Top Tether belt ⑥. Comply with the manufacturer's installation instructions when doing so.
- ▶ Move head restraint ③ back down again slightly if necessary (▶ page 106). Make sure that you do not interfere with the correct routing of Top Tether belt ⑥.

Child-proof locks

Important safety notes

⚠ WARNING

When leaving the vehicle, always remove the SmartKey from the ignition lock. Always take the SmartKey with you and lock the vehicle. Do not leave children unattended in the vehicle, even if they are secured in a child restraint system, or with access to an unlocked vehicle. A child's unsupervised access to a vehicle could result in an accident and/or serious personal injury. The children could:

- injure themselves on parts of the vehicle
- be seriously or fatally injured through excessive exposure to extreme heat or cold
- injure themselves or cause an accident with vehicle equipment that can be operated even if the SmartKey is removed from the ignition lock or removed from the vehicle, such as seat adjustment, steering wheel adjustment, or the memory function

If children open a door, they could injure other persons or get out of the vehicle and injure themselves or be injured by following traffic.

Do not expose the child restraint system to direct sunlight. The child restraint system's metal parts, for example, could become very hot, and the child could be burned on these parts.

Child-proof locks for the rear doors

WARNING

Children could open a rear door from inside the vehicle. This could result in serious injuries or an accident. Therefore, when children ride in the rear always secure the rear doors with the child-proof locks.

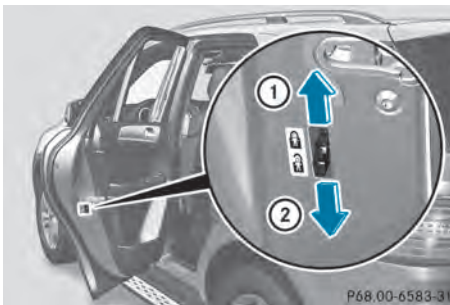

You secure each door individually with the child-proof locks on the rear doors. A door secured with a child-proof lock cannot be opened from inside the vehicle. When the vehicle is unlocked, the door can be opened from the outside.

- ▶ **To activate:** press the child-proof lock lever up in the direction of arrow ①.
- ▶ Make sure that the child-proof locks are working properly.
- ▶ **To deactivate:** press the child-proof lock lever down in the direction of arrow ②.

Override feature for the rear side windows

WARNING

When children ride on the vehicle's rear seats, activate the override switch. Otherwise, the children could be injured, e.g. by trapping themselves in the rear side window.

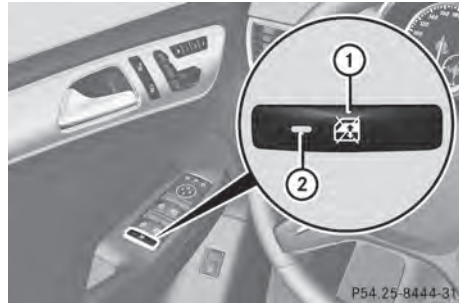

- ▶ **To activate/deactivate:** press button ①. If indicator lamp ② is lit, operation of the rear side windows is disabled. Operation is only possible using the switches in the driver's door. If indicator lamp ② is off, operation is possible using the switches in the rear compartment.

Driving safety systems

Overview of driving safety systems

In this section, you will find information about the following driving safety systems:

- ABS (**A**nti-**l**ock **B**raking **S**ystem) (▷ page 66)
- BAS (**B**rake **A**ssist **S**ystem) (▷ page 67)
- BAS PLUS (**B**rake **A**ssist **S**ystem **P**LUS) (▷ page 67)
- COLLISION PREVENTION ASSIST (▷ page 68)
- ESP® (**E**lectronic **S**tability **P**rogram) (▷ page 71)
- EBD (**e**lectronic **b**rake **f**orce **d**istribution) (▷ page 73)
- ADAPTIVE BRAKE (▷ page 73)

- PRE-SAFE® Brake (▷ page 73)
- STEER CONTROL (▷ page 75)

Important safety notes

If you fail to adapt your driving style or become distracted, the driving safety systems can neither reduce the risk of accident nor override the laws of physics. Driving safety systems are merely aids designed to assist driving. You are responsible for the distance to the vehicle in front, for vehicle speed and for braking in good time. Always adapt your driving style to suit the prevailing road and weather conditions and maintain a safe distance from the vehicle in front. Drive carefully.

- i** The driving safety systems described only work as effectively as possible when there is adequate contact between the tires and the road surface. Please pay special attention to the notes on tires, recommended minimum tire tread depths, etc. (▷ page 398).

In wintry driving conditions, always use winter tires (M+S tires) and if necessary, snow chains. Only in this way will the driving safety systems described in this section work as effectively as possible.

ABS (Anti-lock Braking System)

Important safety notes

- i** Observe the "Important safety notes" section (▷ page 66).

WARNING

If ABS is faulty, the wheels could lock when braking. The steerability and braking characteristics may be severely impaired. Additionally, further driving safety systems are deactivated. There is an increased danger of skidding and accidents.

Drive on carefully. Have ABS checked immediately at a qualified specialist workshop.

When ABS is malfunctioning, other systems, including driving safety systems, will also become inoperative. Observe the information on the ABS warning lamp (▷ page 318) and display messages which may be shown in the instrument cluster (▷ page 283).

ABS regulates brake pressure in such a way that the wheels do not lock when you brake. This allows you to continue steering the vehicle when braking.

ABS works from a speed of about 5 mph (8 km/h) upwards, regardless of road-surface conditions. ABS works on slippery surfaces, even if you only brake gently.

The yellow  ABS warning lamp in the instrument cluster lights up when the ignition is switched on. It goes out when the engine is running.

Braking

- ▶ **If ABS intervenes:** continue to depress the brake pedal vigorously until the braking situation is over.
- ▶ **To make a full brake application:** depress the brake pedal with full force.

If ABS intervenes when braking, you will feel a pulsing in the brake pedal.

The pulsating brake pedal can be an indication of hazardous road conditions, and functions as a reminder to take extra care while driving.

Off-road ABS

An ABS system specifically suited to off-road terrain is activated automatically once the off-road program is activated on:

- vehicles without the ON&OFFROAD package (▷ page 248)
- vehicles with the ON&OFFROAD package (▷ page 248)

At speeds below 20 mph (30 km/h), the front wheels lock cyclically during braking. The digging-in effect achieved in the process reduces the stopping distance on off-road terrain. This limits steering capability.

BAS (Brake Assist System)

- Observe the "Important safety notes" section (▷ page 66).

WARNING

If BAS is malfunctioning, the braking distance in an emergency braking situation is increased. There is a risk of an accident.

In an emergency braking situation, depress the brake pedal with full force. ABS prevents the wheels from locking.

BAS operates in emergency braking situations. If you depress the brake pedal quickly, BAS automatically boosts the braking force, thus shortening the stopping distance. The brakes will function as usual once you release the brake pedal. BAS is deactivated.

BAS PLUS (Brake Assist System PLUS)

- Observe the "Important safety notes" section (▷ page 66).

BAS PLUS is only available in vehicles equipped with DISTRONIC PLUS.

For BAS PLUS to assist you when driving, the radar sensor system must be:

- activated (▷ page 277)
- operational

With the help of the radar sensor system, BAS PLUS can detect obstacles that are in the path of your vehicle for an extended period of time.

If the radar sensor system is malfunctioning, BAS PLUS will not be available. The brake system is still available with complete brake boosting effect and BAS.

BAS PLUS provides braking assistance in hazardous situations at speeds greater than 4 mph (7 km/h).

At speeds of up to approximately 40 mph (70 km/h), BAS PLUS can also detect stationary objects. Examples of stationary objects are stopped or parked vehicles.

To prevent a front-end collision, BAS PLUS calculates the brake force necessary if:

- you approach an obstacle, and
- BAS PLUS has detected a risk of collision

At a speed less than 20 mph (30 km/h): if you depress the brake pedal, BAS PLUS is activated. The increase in brake pressure will be carried out at the last possible moment.

At a speed greater than 20 mph (30 km/h): if you depress the brake pedal sharply, BAS PLUS automatically raises the brake pressure to a value adapted to the traffic situation.

If BAS PLUS demands particularly high braking force, preventative passenger protection measures (PRE-SAFE®) are activated simultaneously.

- ▶ Keep the brake pedal depressed until the emergency braking situation is over. ABS prevents the wheels from locking.

BAS PLUS is deactivated and the brakes function as usual, if:

- you release the brake pedal.
- there is no longer any danger of a rear-end collision.
- no obstacle is detected in front of your vehicle.

If you have activated DSR (▷ page 246), BAS PLUS is likewise deactivated.

WARNING

BAS PLUS cannot always clearly identify objects and complex traffic situations. BAS PLUS cannot intervene in these cases. There is a risk of an accident.

Always pay careful attention to the traffic situation and be ready to brake.

In particular, the detection of obstacles can be impaired if:

- there is dirt on the sensors or anything else covering the sensors.
- snow or heavy rain
- interference by other radar sources
- there are strong radar reflections, for example in parking garages
- a narrow vehicle traveling in front, e.g. a motorbike
- a vehicle traveling in front on a different line relative to the center of your vehicle

WARNING

BAS PLUS does not react:

- to people or animals
- to oncoming vehicles
- to crossing traffic
- when cornering

As a result, BAS PLUS may not intervene in all critical situations. There is a risk of an accident.

Always pay careful attention to the traffic situation and be ready to brake.

Following damage to the front end of the vehicle, have the configuration and operation of the radar sensors checked at a qualified specialist workshop. This also applies to collisions at low speeds where there is no visible damage to the front of the vehicle.

COLLISION PREVENTION ASSIST

General notes

COLLISION PREVENTION ASSIST consists of Adaptive Brake Assist and the distance warning function, which are described in the following.

Distance warning function

Important safety notes

-  Observe the "Important safety notes" section (▷ page 66).

WARNING

The distance warning function does not react:

- to people or animals
- to oncoming vehicles
- to crossing traffic
- when cornering

Thus, the distance warning function cannot provide a warning in all critical situations. There is a risk of an accident.

Always pay careful attention to the traffic situation and be ready to brake.

The distance warning function cannot always clearly identify objects and complex traffic situations.



In such cases, the distance warning function may:

- give an unnecessary warning
- not give a warning

Always pay careful attention to the traffic situation and do not rely solely on the distance warning function.

Function

- ▶ **To activate/deactivate:** activate or deactivate the distance warning function in the on-board computer (▷ page 272).

When the distance warning function is activated, the multifunction display shows the  symbol, as long as the HOLD function is not switched on (▷ page 207). On vehicles with Active Parking Assist, the  symbol is displayed when **P** is engaged or you are driving faster than 22 mph (35 km/h).

The distance warning function can help you to minimize the risk of a front-end collision with a vehicle ahead or reduce the effects of such a collision. If the distance warning

function detects that there is a risk of a collision, you will be warned visually and acoustically. The distance warning function cannot prevent a collision without your intervention.

Starting at a speed of around 20 mph (30 km/h), this function warns you if you rapidly approach a vehicle in front. An intermittent warning tone will then sound and the  distance warning lamp will light up in the instrument cluster.

▶ Brake immediately in order to increase the distance from the vehicle in front.

or

▶ Take evasive action, provided it is safe to do so.

For the distance warning function to assist you when driving, the function must be activated in the on-board computer and be operational (▷ page 272).

Due to the nature of the system, particularly complicated driving conditions may cause the system to display unnecessary warnings.

With the help of the radar sensor system, the distance warning function can detect obstacles that are in the path of your vehicle for an extended period of time.

At speeds up to 40 mph (70 km/h), the distance warning function may also detect stationary obstacles, for example stopped or parked vehicles.

If you approach an obstacle and the distance warning function detects a risk of a collision, the system will initially alert you both visually and acoustically.

In particular, the detection of obstacles can be impaired if:

- there is dirt on the sensors or anything else covering the sensors
- snow or heavy rain
- interference by other radar sources
- there are strong radar reflections, for example in parking garages

- a narrow vehicle traveling in front, e.g. a motorbike
- a vehicle traveling in front on a different line relative to the center of your vehicle

Following damage to the front end of the vehicle, have the configuration and operation of the radar sensor checked at a qualified specialist workshop. This also applies to collisions at low speeds where there is no visible damage to the front of the vehicle.

Adaptive Brake Assist

-  Observe the "Important safety notes" section (▷ page 66).

WARNING

Adaptive Brake Assist cannot always clearly identify objects and complex traffic situations. In these cases, Adaptive Brake Assist may not intervene. There is a risk of an accident.

Always pay careful attention to the traffic situation and be ready to brake.

WARNING

Adaptive Brake Assist does not react:

- to people or animals
- to oncoming vehicles
- to crossing traffic
- to stationary obstacles
- when cornering

As a result, Adaptive Brake Assist may not intervene in all critical conditions. There is a risk of an accident.

Always pay careful attention to the traffic situation and be ready to brake.

Adaptive Brake Assist provides braking assistance in hazardous situations at speeds greater than 20 mph (30 km/h) and uses radar sensor technology to assess the traffic situation.

With the help of Adaptive Brake Assist, the distance warning signal can detect obstacles

that are in the path of your vehicle for an extended period of time.

Should you approach an obstacle and Adaptive Brake Assist has detected a risk of collision, Adaptive Brake Assist calculates the braking force necessary to avoid a rear-end collision. Should you apply the brakes vigorously, Adaptive Brake Assist will automatically increase the braking force to a level suitable for the traffic conditions.

- ▶ Keep the brake pedal depressed until the emergency braking situation is over. ABS prevents the wheels from locking.

The brakes will work normally again if:

- you release the brake pedal.
- there is no longer any danger of a rear-end collision.
- no obstacle is detected in front of your vehicle.

Adaptive Brake Assist is then deactivated.

If Adaptive Brake Assist requires particularly high brake pressure, preventive passenger protection measures (PRE-SAFE®) are deployed simultaneously.

Up to vehicle speeds of around 155 mph (250 km/h), adaptive Brake Assist is capable of reacting to moving objects that have already been recognized as such at least once over the period of observation. Adaptive Brake Assist does not react to stationary obstacles.

If Adaptive Brake Assist is not available due to a malfunction in the radar sensor system, the brake system remains available with full brake boosting effect and BAS.

In particular, the detection of obstacles can be impaired if there is:

- dirt on the sensors or anything else covering the sensors
- snow or heavy rain
- interference by other radar sources
- there are strong radar reflections, for example in parking garages

- a narrow vehicle traveling in front, e.g. a motorbike
- a vehicle traveling in front on a different line relative to the center of your vehicle

Following damage to the front end of the vehicle, have the configuration and operation of the radar sensor checked at a qualified specialist workshop. This also applies to collisions at low speeds where there is no visible damage to the front of the vehicle.

ESP® (Electronic Stability Program)

General notes

- ❗ Observe the "Important safety notes" section (▷ page 66).

ESP® monitors driving stability and traction, i.e. power transmission between the tires and the road surface.

If ESP® detects that the vehicle is deviating from the direction desired by the driver, one or more wheels are braked to stabilize the vehicle. The engine output is also modified to keep the vehicle on the desired course within physical limits. ESP® assists the driver when pulling away on wet or slippery roads. ESP® can also stabilize the vehicle during braking.

ETS/4ETS (Electronic Traction System)

ETS/4ETS traction control is part of ESP®.

Traction control brakes the drive wheels individually if they spin. This enables you to pull away and accelerate on slippery surfaces, for example if the road surface is slippery on one side. In addition, more drive torque is transferred to the wheel or wheels with traction.

Traction control remains active, even if you deactivate ESP®.

In appropriate driving situations, activate the off-road program:

- ▶ Vehicles without the ON&OFFROAD package (> page 248)
- ▶ Vehicles with the ON&OFFROAD package (> page 248)

Off-road 4ETS (Electronic Traction System)

A 4ETS system specifically suited to off-road terrain is activated automatically once the off-road program is activated on:

- vehicles without the ON&OFFROAD package (> page 248)
- vehicles with the ON&OFFROAD package (> page 248)

Important safety notes

WARNING

If ESP® is malfunctioning, ESP® is unable to stabilize the vehicle. Additionally, further driving safety systems are deactivated. This increases the risk of skidding and an accident.



Drive on carefully. Have ESP® checked at a qualified specialist workshop.

- !** Vehicles with 4MATIC: only operate the vehicle for a maximum of ten seconds on a brake test dynamometer. Switch off the ignition.

Application of the brakes by ESP® may otherwise destroy the brake system.

- !** Vehicles with 4MATIC: function or performance tests may only be carried out on a 2-axle dynamometer. Before you operate the vehicle on such a dynamometer, please consult a qualified workshop. You could otherwise damage the drive train or the brake system.

ESP® is deactivated if the  warning lamp in the instrument cluster lights up continuously when the engine is running.

If the  warning lamp and the  warning lamp are lit continuously, ESP® is not available due to a malfunction.

Observe the information on warning lamps (> page 321) and display messages which may be shown in the instrument cluster (> page 283).

- i** Only use wheels with the recommended tire sizes. Only then will ESP® function properly.

Characteristics of ESP®

General information

ESP® is activated automatically when the engine is started.

If ESP® intervenes, the  ESP® warning lamp flashes in the instrument cluster.

If ESP® intervenes:

- ▶ Do not deactivate ESP® under any circumstances.
- ▶ Only depress the accelerator pedal as far as necessary when pulling away.
- ▶ Adapt your driving style to suit the prevailing road and weather conditions.

ECO start/stop function

The ECO start/stop function switches the engine off automatically when the vehicle stops moving. The engine starts automatically when the driver wants to pull away again. ESP® remains in its previously selected status. **Example:** if ESP® was deactivated before the engine was switched off, ESP® remains deactivated when the engine is switched on again.

Deactivating/activating ESP®

Important safety notes

You can select between the following states of ESP®:

- ESP® is activated.
- ESP® is deactivated.

⚠ WARNING

If you deactivate ESP®, ESP® no longer stabilizes the vehicle. There is an increased risk of skidding and an accident.

Only deactivate ESP® in the situations described in the following.

It may be best to deactivate ESP® in the following situations:

- when using snow chains
- in deep snow
- on sand or gravel

i Activate ESP® as soon as the situations described above no longer apply. ESP® will otherwise not be able to stabilize the vehicle if the vehicle starts to skid or a wheel starts to spin.

! Avoid spinning the driven wheels for an extended period with ESP® deactivated. You could otherwise damage the drivetrain.

Deactivating/activating ESP®

► **To switch off:** press button ①.

The  ESP® OFF warning lamp in the instrument cluster lights up.

► **To switch on:** press button ①.

The  ESP® OFF warning lamp in the instrument cluster goes out.

Characteristics when ESP® is deactivated

If ESP® is deactivated and one or more wheels start to spin, the  ESP® warning lamp in

the instrument cluster flashes. In such situations, ESP® will not stabilize the vehicle.

If you deactivate ESP®:

- ESP® no longer improves driving stability.
- the engine's torque is no longer limited and the drive wheels can spin. The spinning of the wheels results in a cutting action, which provides better grip.
- ETS/4ETS is still active.
- ESP® still provides support when you brake.

Off-road ESP®

An ESP® system specifically suited to off-road terrain is activated automatically once the off-road program is activated on:

- vehicles without the ON&OFFROAD package (▷ page 248)
- vehicles with the ON&OFFROAD package (▷ page 248)

Off-road ESP® intervenes with a delay if there is oversteering or understeering, thus improving traction.

ESP® trailer stabilization**⚠ WARNING**

If road and weather conditions are poor, trailer stabilization will not be able to prevent the vehicle/trailer combination from swerving. Trailers with a high center of gravity can tip over before ESP® can detect this. There is a risk of an accident.

Always adapt your driving style to the prevailing road and weather conditions.

If your vehicle with trailer (vehicle/trailer combination) begins to lurch, you can only stabilize the vehicle/trailer combination by depressing the brake firmly.

In this situation, ESP® assists you and can detect if the vehicle/trailer combination begins to lurch. ESP® slows the vehicle down by braking and limiting the engine output until

the vehicle/trailer combination has stabilized.

Trailer stabilization is active above speeds of about 37 mph (60 km/h).

Trailer stabilization does not work if ESP® is deactivated because of a malfunction.

EBD (electronic brake force distribution)

i Observe the "Important safety notes" section (▷ page 66).

WARNING

If EBD has malfunctioned, the rear wheels can still lock, e.g. under full braking. This increases the risk of skidding and an accident.

You should therefore adapt your driving style to the different handling characteristics. Have the brake system checked at a qualified specialist workshop.

Observe information regarding indicator and warning lamps (▷ page 319) as well as display messages (▷ page 285).

EBD monitors and controls the brake pressure on the rear wheels to improve driving stability while braking.

ADAPTIVE BRAKE

ADAPTIVE BRAKE enhances braking safety and offers increased braking comfort. In addition to the braking function, ADAPTIVE BRAKE also has the HOLD function (▷ page 207) and hill start assist (▷ page 161).

PRE-SAFE® Brake

i Observe the "Important safety notes" section (▷ page 66).

PRE-SAFE® Brake is only available in vehicles with DISTRONIC PLUS.

If PRE-SAFE® Brake is to aid you, the radar sensor system must be:

- activated (▷ page 277)
- operational

With the help of the radar sensor system, PRE-SAFE® Brake can detect obstacles that are in front of your vehicle for an extended period of time.

PRE-SAFE® Brake can help you to minimize the risk of a collision with a vehicle ahead or reduce the effects of such a collision. If PRE-SAFE® Brake has detected a risk of collision, you will be warned visually and acoustically as well as by automatic braking. PRE-SAFE® Brake cannot prevent a collision without your intervention.

Starting at a speed of around 4 mph (7 km/h), this function warns you if you very quickly approach a vehicle in front. An intermittent warning tone will then sound and the  distance warning lamp will light up in the instrument cluster.

► Brake immediately in order to increase the distance from the vehicle in front.

or

► Take evasive action provided it is safe to do so.

From a speed of approximately 4 mph (7 km/h), if the driver and front passenger have fastened their seat belts, PRE-SAFE® Brake can brake the vehicle automatically at speeds up to approximately 124 mph (200 km/h).

Due to the nature of the system, particularly complicated driving conditions may cause unnecessary warnings or the unnecessary intervention of PRE-SAFE® Brake.

You can prevent the intervention of the PRE-SAFE® Brake at any time by:

- depressing the accelerator pedal further
- activating kickdown
- releasing the brake pedal

The braking action of PRE-SAFE® Brake is ended automatically if:

- you maneuver to avoid the obstacle.
- there is no longer any danger of a rear-end collision.
- there is no longer an obstacle detected in front of your vehicle.

If you have activated DSR (▷ page 246), PRE-SAFE® Brake is deactivated.

At speeds of up to approximately 40 mph (70 km/h), PRE-SAFE® Brake can also detect stationary objects. Examples of stationary objects are stopped or parked vehicles.

If you approach an obstacle and PRE-SAFE® Brake detects a risk of a collision, the system will alert you both visually and acoustically. If you do not brake or take evasive action, the system will warn you by automatically braking the vehicle gently. If there is an increased risk of collision, preventative passenger protection measures (PRE-SAFE®) are activated (▷ page 54). If, at speeds over 20 mph (30 km/h), a risk of collision remains and you do not brake, take evasive action or significantly accelerate, automatic braking may be performed up to a level of automatic emergency braking. Automatic emergency braking is not performed until immediately prior to an accident that can no longer be avoided.

WARNING

PRE-SAFE® Brake will initially brake your vehicle by a partial application of the brakes if a danger of collision is detected. There may be a collision unless you also brake. Automatic emergency braking cannot prevent a collision. There is a risk of an accident. Always apply the brakes yourself and try to take evasive action.

WARNING

PRE-SAFE® Brake cannot always clearly identify objects and complex traffic conditions.

In these cases, PRE-SAFE® Brake may:

- give an unnecessary warning and then brake the vehicle
- not give a warning or intervene

There is a risk of an accident.

Always pay particular attention to the traffic situation and be ready to brake, especially if PRE-SAFE® Brake warns you. Terminate the intervention in a non-critical driving situation.

In particular, the detection of obstacles can be impaired if:

- there is dirt on the sensors or anything else covering the sensors
- snow or heavy rain
- interference by other radar sources
- there are strong radar reflections, for example in parking garages
- a narrow vehicle traveling in front, e.g. a motorbike
- a vehicle traveling in front on a different line relative to the center of your vehicle

WARNING

PRE-SAFE® Brake does not react:

- to people or animals
- to oncoming vehicles
- to crossing traffic
- when cornering

As a result, PRE-SAFE® Brake may neither give warnings nor intervene in all critical situations. There is a risk of an accident.

Always pay careful attention to the traffic situation and be ready to brake.

In order to maintain an appropriate distance from the vehicle in front and thus prevent a collision, you must apply the brakes yourself.

► **To activate/deactivate:** activate or deactivate PRE-SAFE® Brake in the on-board computer (▷ page 272). When PRE-SAFE® Brake is activated, the  symbol appears in the multifunction display as long as the HOLD function is

deactivated (▷ page 207). On vehicles with Active Parking Assist, the  symbol is displayed when **P** is engaged or you are driving faster than 22 mph (35 km/h).

Following damage to the front end of the vehicle, have the configuration and operation of the radar sensors checked at a qualified specialist workshop. This also applies to collisions at low speeds where there is no visible damage to the front of the vehicle.

STEER CONTROL

- i** Observe the "Important safety notes" section (▷ page 66).

STEER CONTROL helps you by transmitting a noticeable steering force to the steering wheel in the direction required for vehicle stabilization.

This steering assistance is provided in particular if:

- both right wheels or both left wheels are on a wet or slippery road surface when you brake
- the vehicle starts to skid

If ESP® is malfunctioning, you will not receive steering support from STEER CONTROL. Power steering will, however, continue to function.

Theft deterrent locking system

Immobilizer

- ▶ **To activate with the SmartKey:** remove the SmartKey from the ignition lock.
- ▶ **To activate with KEYLESS-GO:** switch the ignition off and open the driver's door.
- ▶ **To deactivate:** switch on the ignition.

The immobilizer prevents your vehicle from being started without the correct SmartKey. When leaving the vehicle, always take the SmartKey with you and lock the vehicle.

Anyone can start the engine if a valid SmartKey has been left inside the vehicle.

- i** The immobilizer is always deactivated when you start the engine.

In the event that the engine cannot be started when the starter battery is fully charged, the immobilizer may be faulty. Contact an authorized Mercedes-Benz Center or call 1-800-FOR-MERCEDES (in the USA) or 1-800-387-0100 (in Canada).

ATA (anti-theft alarm system)



- ▶ **To arm:** lock the vehicle with the SmartKey or KEYLESS-GO.

Indicator lamp ① flashes. The alarm system is armed after approximately 15 seconds.

- ▶ **To switch off using the SmartKey:** unlock the vehicle with the SmartKey.

or

- ▶ Insert the SmartKey into the ignition lock.

- ▶ **To switch off using KEYLESS-GO:** unlock the vehicle with KEYLESS-GO.

or

- ▶ Press the Start/Stop button on the dashboard. The SmartKey must be inside the vehicle.

A visual and audible alarm is triggered if the alarm system is armed and you open:

- a door
- the vehicle with the mechanical key

- the tailgate
- the hood

► **To turn the alarm off with the**

SmartKey: press the  or  button on the SmartKey.

The alarm is switched off.

or

- Insert the SmartKey into the ignition lock.
The alarm is switched off.

► **To stop the alarm using KEYLESS-GO:**

grasp the outside door handle. The SmartKey must be outside the vehicle.

The alarm is switched off.

or

- Press the Start/Stop button on the dashboard. The SmartKey must be inside the vehicle.

The alarm is switched off.

The alarm is not switched off, even if you close the open door that has triggered it, for example.

i If the alarm stays on for more than 30 seconds, the mbrace (USA only) or TELEAID (Canada only) emergency call system initiates a call to the Customer Assistance Center automatically. The emergency call system initiates the call provided that:

- you have subscribed to the mbrace/TELEAID Service.
- the mbrace/TELEAID Service has been activated properly.
- the required mobile phone, power supply and GPS are available.

| | |
|--------------------------|----|
| Useful information | 78 |
| SmartKey | 78 |
| Doors | 84 |
| Cargo compartment | 87 |
| Side windows | 92 |
| Sliding sunroof | 96 |

Useful information

- i** This Operator's Manual describes all models and all standard and optional equipment of your vehicle available at the time of publication of the Operator's Manual. Country-specific differences are possible. Please note that your vehicle may not be equipped with all features described. This also applies to safety-related systems and functions.
- i** Read the information on qualified specialist workshops: (▷ page 27).

SmartKey

Important safety notes

WARNING

If children are left unsupervised in the vehicle, they could:

- open the doors, thus endangering other people or road users.
- get out and disrupt traffic.
- operate the vehicle's equipment.

Additionally, children could set the vehicle in motion if, for example, they:

- release the parking brake.
- shift the automatic transmission out of parking position P.
- starting the engine.

There is a risk of an accident and injury.

When leaving the vehicle, always take the SmartKey with you and lock the vehicle. Never leave children or animals unattended in the vehicle. Always keep the SmartKey out of reach of children.

WARNING

When leaving the vehicle, always remove the SmartKey from the ignition lock. Always take the SmartKey with you and lock the vehicle. Do not leave children unsupervised in the vehicle, even if they are secured in a child restraint system, and do not give them access to an unlocked vehicle. A child's unsupervised access to a vehicle could result in an accident and/or serious personal injury. They could:

- injure themselves on vehicle parts
- be seriously or fatally injured by extreme heat or cold
- injure themselves or have an accident with vehicle equipment that may still be in operation even after the SmartKey has been removed from the ignition, such as the seat adjustment, steering wheel adjustment or memory function.

If children open a door, they could cause severe or even fatal injury to other persons; if they get out of the vehicle, they could injure themselves when doing so or be seriously or even fatally injured by any passing traffic.

Do not expose the child restraint system to direct sunlight. The child restraint system's metal parts, for example, could become very hot, and a child could be burned on these parts.

WARNING

If you attach heavy or large objects to the SmartKey, the SmartKey could be unintentionally turned in the ignition lock. This could cause the engine to be switched off. There is a risk of an accident.

Do not attach any heavy or large objects to the SmartKey. Remove any bulky keyrings before inserting the SmartKey into the ignition lock.

- !** Keep the SmartKey away from strong magnetic fields. Otherwise, the remote control function could be affected.

Strong magnetic fields can occur in the vicinity of powerful electrical installations.

- Do not keep the SmartKey:
 - with electronic devices, e.g. a mobile phone or another SmartKey
 - with metallic objects, e.g. coins or metal foil
 - inside metallic objects, e.g. a metal case



This can affect the functionality of the SmartKey.

Do not keep the KEYLESS-GO key in the temperature-controlled cup holder.

Otherwise, the KEYLESS-GO key will not be recognized.

SmartKey functions



- ①  To lock the vehicle
- ②  To open/close the tailgate
- ③  To unlock the vehicle

- ▶ **To unlock centrally:** press the  button.

If you do not open the vehicle within approximately 40 seconds of unlocking:

- the vehicle is locked again.
- the theft deterrent locking system is armed again.

- ▶ **To lock centrally:** press the  button.

The SmartKey centrally locks/unlocks:

- the doors
- the tailgate
- the fuel filler flap

When unlocking, the turn signals flash once. When locking, they flash three times.

You can also set an audible signal to confirm that the vehicle has been locked. The audible signal can be activated and deactivated using the on-board computer (▷ page 276).

When it is dark, the surround lighting also comes on if it is activated in the on-board computer (▷ page 275).

KEYLESS-GO

General notes

Bear in mind that the engine can be started by any of the vehicle occupants if there is a KEYLESS-GO key in the vehicle.

Locking/unlocking centrally

You can start, lock or unlock the vehicle using KEYLESS-GO. To do this, you only need carry the SmartKey with you. You can combine the functions of KEYLESS-GO with those of a conventional SmartKey. Unlock the vehicle by using KEYLESS-GO, for instance, and lock it using the  button on the SmartKey.

When locking or unlocking with KEYLESS-GO, the distance between the SmartKey and the corresponding door handle must not be greater than 3 ft (1 m).

KEYLESS-GO checks whether a valid SmartKey is in the vehicle by periodically establishing a radio connection between the vehicle and the SmartKey. This happens:

- when the external door handles are touched
- when starting the engine
- while the vehicle is in motion

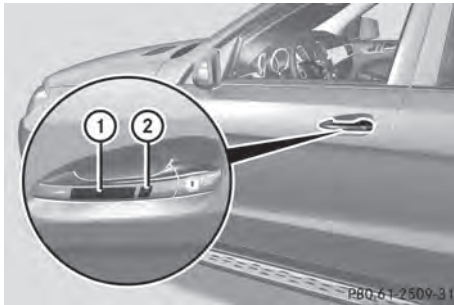





- ▶ **To unlock the vehicle:** touch the inner surface of the door handle.
- ▶ **To lock the vehicle:** touch sensor surface ①.
- ▶ **Convenience closing feature:** touch recessed sensor surface ② for an extended period.

Further information on the convenience closing feature (▷ page 93).



If you pull on the handle of the tailgate, only the cargo compartment of the vehicle is unlocked.

Changing the settings of the locking system



You can change the settings of the locking system. This means that only the driver's door and the fuel filler flap are unlocked when the vehicle is unlocked. This is useful if you frequently travel on your own.

- ▶ **To change the setting:** press and hold down the  and  buttons simultaneously for approximately six seconds until the battery check lamp flashes twice (▷ page 81).
- ▶ **i** If the setting of the locking system is changed within the signal range of the vehicle, pressing the  or  button:
 - locks or
 - unlocks the vehicle

The SmartKey now functions as follows:

- ▶ **To unlock the driver's door:** press the  button once.
- ▶ **To unlock centrally:** press the  button twice.
- ▶ **To lock centrally:** press the  button.

The KEYLESS-GO function is changed as follows:

- ▶ **To unlock the driver's door:** touch the inner surface of the door handle on the driver's door.
- ▶ **To unlock centrally:** touch the inner surface of the door handle on the front-passenger door or the rear door.
- ▶ **To lock centrally:** touch the outer sensor surface on one of the door handles (▷ page 79).
- ▶ **To restore the factory settings:** press and hold down the  and  buttons simultaneously for approximately six seconds until the battery check lamp flashes twice (▷ page 81).



Mechanical key

General notes

If the vehicle can no longer be locked or unlocked with the SmartKey, use the mechanical key.

If you use the mechanical key to unlock and open the driver's door, the anti-theft alarm system will be triggered (▷ page 75).

There are several ways to turn off the alarm:

- ▶ **To turn the alarm off with the SmartKey:** press the  or  button on the SmartKey.
- or
- ▶ Insert the SmartKey into the ignition lock.
- or
- ▶ **To deactivate the alarm with KEYLESS-GO:** press the Start/Stop button in the

ignition lock. The SmartKey must be in the vehicle.

or

- ▶ Lock or unlock the vehicle using KEYLESS-GO. The SmartKey must be outside the vehicle.

If you unlock the vehicle using the mechanical key, the fuel filler flap will not be unlocked automatically.

- ▶ **To unlock the fuel filler flap:** insert the SmartKey into the ignition lock.

Removing the mechanical key



- ① Release catch
- ② Mechanical key

- ▶ Push release catch ① in the direction of the arrow and at the same time remove mechanical key ② from the SmartKey.

SmartKey battery

Important safety notes

WARNING





Batteries contain toxic and corrosive substances. If batteries are swallowed, it can result in severe health problems. There is a risk of fatal injury.

Keep batteries out of the reach of children. If a battery is swallowed, seek medical attention immediately.

Mercedes-Benz recommends that you have the batteries replaced at a qualified specialist workshop.

Checking the battery



- ▶ Press the  or  button. The battery is working properly if battery check lamp ① lights up briefly. The battery is discharged if battery check lamp ① does not light up briefly.
- ▶ Change the battery (▶ page 81).
- i** If the SmartKey battery is checked within the signal reception range of the vehicle, pressing the  or  button:
 - locks or
 - unlocks the vehicle
- i** You can get a battery at any qualified specialist workshop.

Replacing the battery

You require a CR 2025 3 V cell battery.

- ▶ Take the mechanical key out of the SmartKey (▶ page 80).



① Battery compartment cover

② Mechanical key

- ▶ Press mechanical key ② into the opening in the SmartKey in the direction of the arrow until battery compartment cover ① opens. Do not hold battery compartment cover ① closed while doing so.
- ▶ Remove battery compartment cover ①.









③ Battery

- ▶ Repeatedly tap the SmartKey against your palm until battery ③ falls out.
- ▶ Insert the new battery with the positive terminal facing upwards. Use a lint-free cloth to do so.
- ▶ Make sure that the surface of the battery is free from lint, grease and all other forms of contamination.

- ▶ Insert the front tabs of battery compartment cover ① into the housing first and then press to close it.
- ▶ Insert mechanical key ② into the SmartKey.
- ▶ Check the function of all SmartKey buttons on the vehicle.

Problems with the SmartKey

| Problem | Possible causes/consequences and ► Solutions |
|--|---|
| You cannot lock or unlock the vehicle using the SmartKey. | <p>The SmartKey battery is discharged or nearly discharged.</p> <ul style="list-style-type: none"> ► Try again to lock/unlock the vehicle using the remote control function of the SmartKey. Point the tip of the SmartKey at the driver's door handle from close range and press the  or  button. <p>If this does not work:</p> <ul style="list-style-type: none"> ► Check the SmartKey battery (▷ page 81) and replace it if necessary (▷ page 81). ► Lock (▷ page 86) or unlock (▷ page 87) the vehicle using the mechanical key. <p>The SmartKey is faulty.</p> <ul style="list-style-type: none"> ► Lock (▷ page 86) or unlock (▷ page 87) the vehicle using the mechanical key. ► Have the SmartKey checked at a qualified specialist workshop. |
| You can no longer lock or unlock the vehicle using KEYLESS-GO. | <p>There is interference from a powerful source of radio waves.</p> <ul style="list-style-type: none"> ► Lock/unlock the vehicle using the remote control function of the SmartKey. Point the tip of the SmartKey at the driver's door handle from close range and press the  or  button. <p>There is a malfunction with KEYLESS-GO.</p> <ul style="list-style-type: none"> ► Lock/unlock the vehicle using the remote control function of the SmartKey. Point the tip of the SmartKey at the driver's door handle from close range and press the  or  button. ► Have KEYLESS-GO checked at a qualified specialist workshop. <p>If this does not work:</p> <ul style="list-style-type: none"> ► Check the SmartKey battery (▷ page 81) and replace it if necessary (▷ page 81). ► Lock (▷ page 86) or unlock (▷ page 87) the vehicle using the mechanical key. |
| You have lost a SmartKey. | <ul style="list-style-type: none"> ► Have the SmartKey deactivated at a qualified specialist workshop. ► Report the loss immediately to the vehicle insurers. ► If necessary, have the locks changed as well. |
| You have lost the mechanical key. | <ul style="list-style-type: none"> ► Report the loss immediately to the vehicle insurers. ► If necessary, have the locks changed as well. |

| Problem | Possible causes/consequences and ► Solutions |
|--|---|
| The engine cannot be started using the SmartKey. | <p>The on-board voltage is too low.</p> <ul style="list-style-type: none"> ► Switch off non-essential consumers, e.g. seat heating or interior lighting, and try to start the engine again. <p>If this does not work:</p> <ul style="list-style-type: none"> ► Check the starter battery and charge it if necessary (▷ page 387). <p>or</p> <ul style="list-style-type: none"> ► Jump-start the vehicle (▷ page 389). <p>or</p> <ul style="list-style-type: none"> ► Consult a qualified specialist workshop. |
| The engine cannot be started using KEYLESS-GO. The SmartKey is in the vehicle. | <p>A door is open. Therefore, the SmartKey cannot be detected as easily.</p> <ul style="list-style-type: none"> ► Close the door and try to start the vehicle again. |
| | <p>There is interference from a powerful source of radio waves.</p> <ul style="list-style-type: none"> ► Start your vehicle with the SmartKey in the ignition lock. |

Doors

Important safety notes

WARNING

If children are left unsupervised in the vehicle, they could:

- open the doors, thus endangering other people or road users.
- get out and disrupt traffic.
- operate the vehicle's equipment.

Additionally, children could set the vehicle in motion if, for example, they:

- release the parking brake.
- shift the automatic transmission out of parking position P.
- starting the engine.

There is a risk of an accident and injury.

When leaving the vehicle, always take the SmartKey with you and lock the vehicle. Never leave children or animals unattended in the vehicle. Always keep the SmartKey out of reach of children.

WARNING

When leaving the vehicle, always remove the SmartKey from the ignition lock. Always take the SmartKey with you and lock the vehicle. Do not leave children unsupervised in the vehicle, even if they are secured in a child restraint system, and do not give them access to an unlocked vehicle. A child's unsupervised access to a vehicle could result in an accident and/or serious personal injury. They could:

- injure themselves on vehicle parts
- be seriously or fatally injured by extreme heat or cold
- injure themselves or have an accident with vehicle equipment that may still be in operation even after the SmartKey has been removed from the ignition, such as the seat adjustment, steering wheel adjustment or memory function.

If children open a door, they could cause severe or even fatal injury to other persons; if they get out of the vehicle, they could injure

themselves when doing so or be seriously or even fatally injured by any passing traffic.

Do not expose the child restraint system to direct sunlight. The child restraint system's metal parts, for example, could become very hot, and a child could be burned on these parts.

WARNING

Do not carry heavy or hard objects in the passenger compartment or cargo compartment unless they are firmly secured in place.

Unsecured or improperly positioned cargo increases a child's risk of injury in the event of

- strong braking maneuvers
- sudden changes of direction
- an accident

Unlocking and opening doors from the inside

You can open a door from inside the vehicle even if it has been locked. You can only open the rear doors from inside the vehicle if they are not secured by the child-proof locks (▷ page 65).

If the vehicle has been locked with the SmartKey or with KEYLESS-GO, opening a door from the inside will trigger the anti-theft alarm system. Switch off the alarm (▷ page 75).

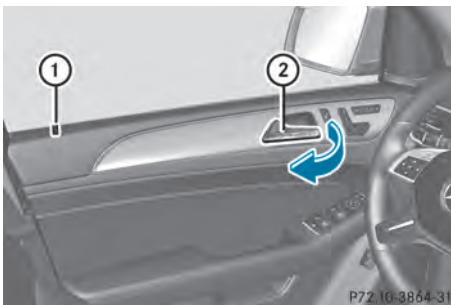

► **Front door:** pull door handle ②.

If the door is locked, locking knob ① pops up. The door is unlocked and can be opened.

► **Rear door:** pull up locking knob ① on the relevant rear door.

The rear door is unlocked and can be opened.

Centrally locking and unlocking the vehicle from the inside

You can centrally lock or unlock the vehicle from the inside. The buttons are located on both front doors.

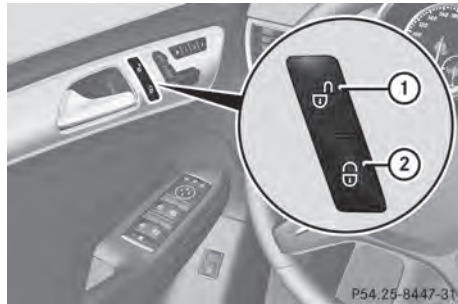

① To unlock

② To lock

► **To unlock:** press button ①.

► **To lock:** press button ②.

If the front-passenger door is closed, the vehicle locks.

Meanwhile, the fuel filler flap will not be locked or unlocked.

You cannot unlock the vehicle centrally from the inside if the vehicle has been locked with the SmartKey or KEYLESS-GO.

You can open a front door from inside the vehicle even if it has been locked.

If the vehicle has been locked using the locking button for the central locking, or has been locked automatically, and a door is opened from the inside:

- the vehicle will be fully unlocked if it had previously been fully unlocked
- only the door which has been opened from the inside is unlocked if only the driver's door had been previously unlocked

Automatic locking feature



- ① To deactivate
② To activate

- ▶ **To deactivate:** press and hold button ① for about five seconds until a tone sounds.
- ▶ **To activate:** press and hold button ② for about five seconds until a tone sounds.

i If you press one of the two buttons and do not hear a tone, the relevant setting has already been selected.

The vehicle is locked automatically when the ignition is switched on and the wheels are turning.

You could therefore be locked out if:

- the vehicle is being pushed.
- the vehicle is being towed.
- the vehicle is on a roller dynamometer.

You can also switch the automatic locking function on and off using the on-board computer (▷ page 276).

Power closing feature

Power closing pulls the doors and trunk lid into their locks automatically even if they are only partly closed.

- ▶ **To power-close a door:** push the door into the lock up to the first detent position. Power closing will pull the door fully closed.
- ▶ **To power-close the tailgate:** lightly press the tailgate downwards. Power closing will pull the tailgate fully closed.

Unlocking the driver's door (mechanical key)

If the vehicle can no longer be unlocked with the SmartKey, use the mechanical key.

If you use the mechanical key to unlock and open the driver's door, the anti-theft alarm system will be triggered (▷ page 75).

- ▶ Take the mechanical key out of the SmartKey (▷ page 80).
- ▶ Insert the mechanical key into the lock of the driver's door as far as it will go.

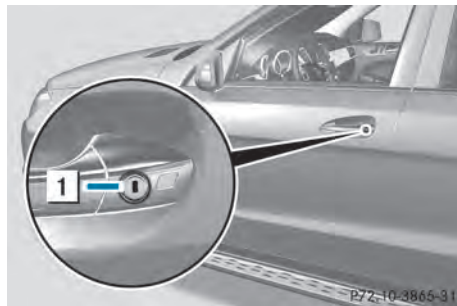

- 1 To unlock
- ▶ Turn the mechanical key counter-clockwise to position 1. The door is unlocked.
 - ▶ Turn the mechanical key back and remove it.
 - ▶ Insert the mechanical key into the SmartKey.

Locking the vehicle (mechanical key)

If the vehicle can no longer be locked with the SmartKey, use the mechanical key.

- ▶ Open the driver's door.
- ▶ Close the front-passenger door, the rear doors and the tailgate.
- ▶ Press the locking button (▷ page 85).
- ▶ Check whether the locking knobs on the front-passenger door and the rear doors are still visible. Press down the locking knobs manually, if necessary (▷ page 85).
- ▶ Close the driver's door.
- ▶ Take the mechanical key out of the SmartKey (▷ page 80).
- ▶ Insert the mechanical key into the lock of the driver's door as far as it will go.

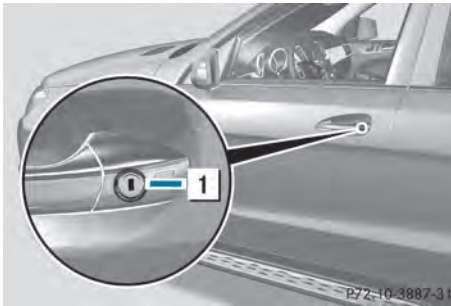

1 To lock

- ▶ Turn the mechanical key clockwise as far as it will go to position **1**.
 - ▶ Turn the mechanical key back and remove it.
 - ▶ Make sure that the doors and the tailgate are locked.
 - ▶ Insert the mechanical key into the SmartKey.
- i** If you lock the vehicle as described above, the fuel filler flap is not locked. The anti-theft alarm system is not armed.

Cargo compartment

Important safety notes

WARNING

Combustion engines emit poisonous exhaust gases such as carbon monoxide. If the tailgate is open when the engine is running, particularly if the vehicle is moving, exhaust fumes could enter the passenger compartment. There is a risk of poisoning. Turn off the engine before opening the tailgate. Never drive with the tailgate open.

WARNING

When leaving the vehicle, always remove the SmartKey from the ignition lock. Always take the SmartKey with you and lock the vehicle. Do not leave children unsupervised in the vehicle, even if they are secured in a child restraint system, and do not give them access to an unlocked vehicle. A child's unsupervised access to a vehicle could result in an accident and/or serious personal injury. They could:

- injure themselves on vehicle parts
- be seriously or fatally injured by extreme heat or cold
- injure themselves or have an accident with vehicle equipment that may still be in operation even after the SmartKey has been removed from the ignition, such as the seat adjustment, steering wheel adjustment or memory function.

If children open a door, they could cause severe or even fatal injury to other persons; if they get out of the vehicle, they could injure themselves when doing so or be seriously or even fatally injured by any passing traffic.

Do not expose the child restraint system to direct sunlight. The child restraint system's metal parts, for example, could become very hot, and a child could be burned on these parts.

⚠ WARNING

Do not carry heavy or hard objects in the passenger compartment or cargo compartment unless they are firmly secured in place.

Unsecured or improperly positioned cargo increases a child's risk of injury in the event of

- strong braking maneuvers
- sudden changes of direction
- an accident

! The tailgate swings upwards and to the rear when opened. Therefore, make sure that there is sufficient clearance above and behind the tailgate.

i Tailgate opening dimensions (> page 452).

Do not leave the SmartKey in the cargo compartment. You could otherwise lock yourself out.

Vehicles without the EASY-PACK

tailgate: the tailgate can be:

- opened and closed manually from outside
- unlocked from inside with the emergency release

For vehicles with the EASY-PACK tailgate you can:

- close the tailgate manually from outside
- open and close the tailgate automatically from outside
- open and close the tailgate automatically from inside
- unlock the tailgate from inside with the emergency release
- limit the opening angle of the tailgate

Opening/closing from outside**Opening**

P72.20-3051-31

- ▶ Press the button on the SmartKey.
- ▶ Pull handle ①.
- ▶ Raise the tailgate.

Vehicles with the EASY-PACK tailgate: if you pull handle ① and then release it, the tailgate opens automatically.

Closing**⚠ WARNING**

To prevent possible personal injury, always keep hands and fingers away from the cargo compartment opening when closing the tailgate. Be especially careful when small children are around.

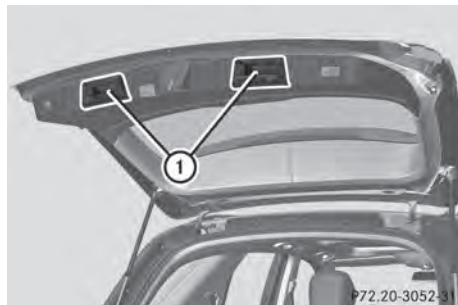

P72.20-3052-31

- ▶ Pull the tailgate down using recess ①.
- ▶ Allow the tailgate to drop into the lock.
- ▶ Lock the vehicle if necessary with the button on the SmartKey or with KEYLESS-GO.

- i** If a KEYLESS-GO key is detected in the cargo compartment, the tailgate will not lock.

Opening/closing automatically from outside

Important safety notes

WARNING

Parts of the body could become trapped during automatic closing of the tailgate. Moreover, people, e.g. children, may be standing in the closing area or may enter the closing area during the closing process. There is a risk of injury.

Make sure that nobody is in the vicinity of the closing area during the closing process.

Use one of the following options to stop the closing process:

- press the  button on the SmartKey.
- press the remote operating switch on the driver's door.
- press the closing or locking button on the tailgate.
- pull the handle on the tailgate.

WARNING

Combustion engines emit poisonous exhaust gases such as carbon monoxide. If the tailgate is open when the engine is running, particularly if the vehicle is moving, exhaust fumes could enter the passenger compartment. There is a risk of poisoning.

Turn off the engine before opening the tailgate. Never drive with the tailgate open.

- !** The tailgate swings upwards and to the rear when opened. Therefore, make sure that there is sufficient clearance above and behind the tailgate.

- i** Tailgate opening dimensions (> page 452).
- i** The tailgate is equipped with an automatic reversing feature. If an object

blocks or restricts the tailgate during the closing process, the tailgate opens again automatically.

Opening the tailgate automatically

You can open the tailgate automatically with the SmartKey or the handle in the tailgate.

- ▶ Press and hold the  button on the SmartKey until the tailgate opens.

or

- ▶ If the tailgate is unlocked, pull the handle and let it go again immediately.

Closing the tailgate automatically

WARNING

Parts of the body could become trapped during automatic closing of the tailgate. Moreover, people, e.g. children, may be standing in the closing area or may enter the closing area during the closing process. There is a risk of injury.

Make sure that nobody is in the vicinity of the closing area during the closing process.

Use one of the following options to stop the closing process:

- press the  button on the SmartKey.
- press the remote operating switch on the driver's door.
- press the closing or locking button on the tailgate.
- pull the handle on the tailgate.

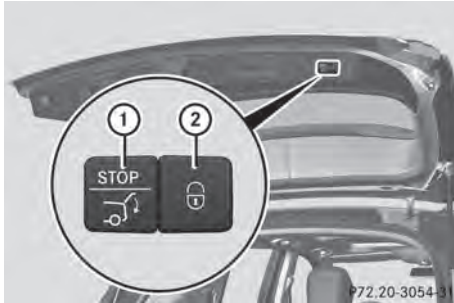

Closing and locking button (example: vehicle with EASY-PACK tailgate and KEYLESS-GO)

- ① Closing button
- ② Locking button

► **To close:** press closing button ① on the tailgate.

or

► Press and hold the  button on the SmartKey until the tailgate closes.

Vehicles with the EASY-PACK tailgate and KEYLESS-GO: you can simultaneously close and lock the tailgate.

► Press locking button ② on the tailgate.
If a KEYLESS-GO key is detected outside the vehicle, the tailgate closes and locks. All the doors must be shut and the SmartKey located in the vicinity of the tailgate.

i The tailgate cannot be opened and closed with the SmartKey if there is a SmartKey in the ignition.

If the tailgate touches an object while closing, the closing procedure is interrupted and the tailgate reopens.

i If a KEYLESS-GO key is detected in the cargo compartment, the tailgate will not lock.

Opening/closing automatically from inside

Important safety notes

WARNING

Parts of the body could become trapped during automatic closing of the tailgate. Moreover, people, e.g. children, may be standing in the closing area or may enter the closing area during the closing process. There is a risk of injury.

Make sure that nobody is in the vicinity of the closing area during the closing process.

Use one of the following options to stop the closing process:

- press the  button on the SmartKey.
- press the remote operating switch on the driver's door.
- press the closing or locking button on the tailgate.
- pull the handle on the tailgate.

WARNING

Combustion engines emit poisonous exhaust gases such as carbon monoxide. If the tailgate is open when the engine is running, particularly if the vehicle is moving, exhaust fumes could enter the passenger compartment. There is a risk of poisoning.

Turn off the engine before opening the tailgate. Never drive with the tailgate open.

! The tailgate swings upwards and to the rear when opened. Therefore, make sure that there is sufficient clearance above and behind the tailgate.

i Tailgate opening dimensions (► page 452).

i The tailgate is equipped with an automatic reversing feature. If an object blocks or restricts the tailgate during the closing process, the tailgate opens again automatically.

Opening and closing



You can open and close the tailgate from the driver's seat when the vehicle is stationary and unlocked.

- ▶ **To open:** pull remote operating switch ① for the tailgate until the tailgate opens.
- ▶ **To close:** turn the SmartKey to position 1 or 2 in the ignition lock.
- ▶ Press remote operating switch for tailgate ① until the tailgate is closed.

Limiting the opening angle of the tailgate

Important safety notes

- ❗ Make sure there is sufficient clearance to open the tailgate fully when setting the opening angle. The tailgate could otherwise be damaged. Ideally, set the opening angle outside.

Activating

You can limit the opening angle of the tailgate. This is possible in the top half of its opening range, up to approximately 4 in (10 cm) before the stop.

This could be useful, for example, if there is insufficient space above the tailgate.

- ▶ **To open the tailgate:** pull the handle on the tailgate.
- ▶ **To stop the opening procedure at the desired position:** press the closing button

(▷ page 89) in the tailgate or pull the handle on the outside of the tailgate again.

- ▶ **To store the position:** press and hold the closing button in the tailgate until you hear a short tone. The opening angle limiter is activated. The tailgate will now stop in the stored position when opening.

Deactivating

- ▶ Press and hold the closing button (▷ page 89) in the tailgate until you hear two short tones.

Tailgate emergency release

Important safety notes

- ❗ The tailgate swings upwards and to the rear when opened. Therefore, make sure that there is sufficient clearance above and behind the tailgate.

- i Tailgate opening dimensions (▷ page 452).

If the tailgate can no longer be opened from outside the vehicle, use the emergency release on the inside of the tailgate.

Opening

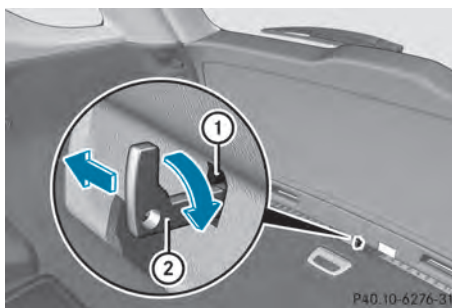

- ▶ Take the mechanical key out of the SmartKey (▷ page 80).
- ▶ Insert mechanical key ② into the opening in paneling ①.

- ▶ Turn mechanical key ② 90° clockwise.
- ▶ Push mechanical key ② in the direction of the arrow and open the tailgate.

Side windows

Important safety notes

WARNING

While opening the side windows, body parts could become trapped between the side window and the door frame as the side window moves. There is a risk of injury.

Make sure that nobody touches the side window during the opening procedure. If somebody becomes trapped, release the switch or pull the switch to close the side window again.

WARNING

While opening the side windows, body parts in the closing area could become trapped. There is a risk of injury.

Make sure that no body parts are in close proximity during the closing procedure. If somebody becomes trapped, release the switch or press the switch to open the side window again.

WARNING

If children operate the side windows they could become trapped, particularly if they are left unsupervised. There is a risk of injury.

Activate the override feature for the rear side windows. When leaving the vehicle, always take the SmartKey with you and lock the vehicle. Never leave children unsupervised in the vehicle.

The side windows are equipped with an automatic reversing feature. If an object blocks or restricts a side window during the closing process, the side window opens again automatically.

WARNING

The reversing feature does not react:

- to soft, light and thin objects, e.g. small fingers
- over the last 4 mm of the closing movement
- during resetting
- when closing the side window again manually immediately after automatic reversing

This means that the reversing feature cannot prevent someone being trapped in these situations. There is a risk of injury.

Make sure that no body parts are in close proximity during the closing procedure. If someone becomes trapped, press the switch to open the side window again.

Opening and closing the side windows

The switches for all side windows are located on the driver's door. There is also a switch on each door for the corresponding side window. The switches on the driver's door take precedence.

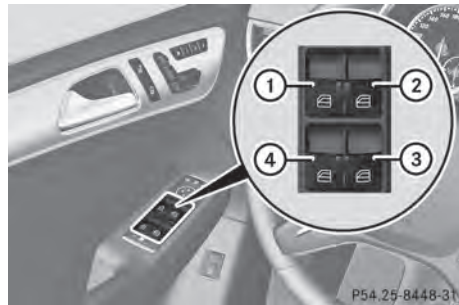

- ① Front left
- ② Front right
- ③ Rear right
- ④ Rear left

- ▶ Turn the SmartKey to position **1** or **2** in the ignition lock.
- ▶ **To open:** press the corresponding switch.
- ▶ **To close:** pull the corresponding switch.
- i** If you press the switch beyond the point of resistance, an automatic opening/closing process is started in the corresponding direction. You can stop automatic operation by operating the switch again.
- i** You can continue to operate the side windows after you switch off the engine or remove the SmartKey. This function is available for up to five minutes or until the driver's or front-passenger door is opened.
- i** The side windows cannot be operated from the rear when the override feature for the side windows is activated (> page 65).

Convenience opening

General notes

You can ventilate the vehicle before you start driving. To do this, the SmartKey is used to carry out the following functions simultaneously:

- unlock the vehicle
- open the side windows
- open the sliding sunroof or the panorama roof with power tilt/sliding panel and the roller sunblinds
- switch on the seat ventilation for the driver's seat



- i** The convenience opening feature can only be operated using the SmartKey. The SmartKey must be close to the driver's door handle.

Convenience opening

- ▶ Point the tip of the SmartKey at the driver's door handle.
- ▶ Press and hold the  button until the side windows and the sliding sunroof or the

panorama roof with power tilt/sliding panel are in the desired position.

If the roller sunblinds of the panorama roof with power tilt/sliding panel are closed, the roller sunblinds are opened first.

- ▶ Press and hold the  button again until the panorama roof with power tilt/sliding panel is in the desired position.
- ▶ **To interrupt convenience opening:** release the  button.

Convenience closing feature

Important safety notes

WARNING

When the convenience closing feature is operating, parts of the body could become trapped in the closing area of the side window and the sliding sunroof. There is a risk of injury.



Observe the complete closing procedure when the convenience closing feature is operating. Make sure that no body parts are in close proximity during the closing procedure.

When you lock the vehicle, you can simultaneously:

- close the side windows
- close the sliding sunroof or the panorama roof with power tilt/sliding panel

On vehicles with a panorama roof with power tilt/sliding panel, you can then close the roller sunblinds.

Proceed as follows if someone is trapped:

- Release the  button to interrupt the closing procedure.
- Press and hold the  button to open.

Vehicles with KEYLESS-GO:

- Release the sensor surfaces on the exterior door handle to interrupt the closing procedure.
- To open, pull the same door handle immediately and hold it firmly. The door windows and the sliding sunroof will open for as long as the door handle is held but the door is not opened.

i Notes on the automatic reversing feature for:



- the side window (▷ page 92)
- the sliding sunroof (▷ page 96)

Using the SmartKey

The SmartKey must be close to the driver's door handle.

- ▶ Point the tip of the SmartKey at the driver's door handle.
- ▶ Press and hold the  button until the side windows and the sliding sunroof or the panorama roof with power tilt/sliding panel are fully closed.
- ▶ Make sure that all the side windows and the sliding sunroof or panorama roof with power tilt/sliding panel are closed.

On vehicles with a panorama roof with power tilt/sliding panel:

- ▶ Press and hold the  button again until the roller sunblinds of the panorama roof with power tilt/sliding panel close.
- ▶ **To interrupt convenience closing:** release the  button.

Using KEYLESS-GO

The KEYLESS-GO key must be outside the vehicle. All the doors must be closed.

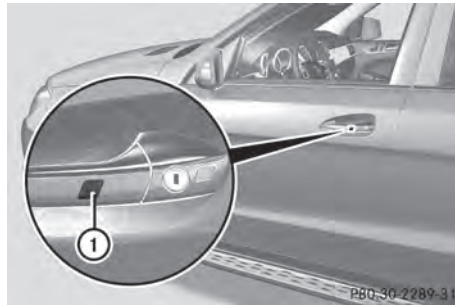

- ▶ Touch recessed sensor surface **1** on the door handle until the side windows and the sliding sunroof or the panorama roof with power tilt/sliding panel are fully closed.

i Make sure you only touch recessed sensor surface **1**.

- ▶ Make sure that all the side windows and the sliding sunroof or panorama roof with power tilt/sliding panel are closed.

On vehicles with a panorama roof with power tilt/sliding panel:

- ▶ Touch recessed sensor surface **1** on the door handle again until the roller sunblinds of the panorama roof with power tilt/sliding panel close.

- ▶ **To interrupt convenience closing:** release recessed sensor surface **1** on the door handle.

Resetting the side windows

If a side window can no longer be closed fully, you must reset it.

- ▶ Close all the doors.
- ▶ Turn the SmartKey to position **1** or **2** in the ignition lock.
- ▶ Pull the corresponding switch on the door control panel until the side window is completely closed. (▷ page 92)
- ▶ Hold the switch for an additional second.

If the side window opens again slightly:

- ▶ Immediately pull the corresponding switch on the door control panel until the side window is completely closed (▷ page 92).
- ▶ Hold the switch for an additional second.
- ▶ If the corresponding side window remains closed after the button has been released, the side window has been reset correctly. If this is not the case, repeat the steps above again.

Problems with the side windows

WARNING

Closing the side windows with increased force or without the anti-entrapment feature could lead to serious or even fatal injury. Make sure that nobody can become trapped when closing the side windows.

| Problem | Possible causes/consequences and ► Solutions |
|---|--|
| A side window cannot be closed because it is blocked by objects, e.g. leaves in the window guide. | <ul style="list-style-type: none"> ► Remove the objects. ► Close the side window. |
| A side window cannot be closed and you cannot see the cause. | <p>If a side window is obstructed during closing and reopens again slightly:</p> <ul style="list-style-type: none"> ► Immediately after the window blocks, pull the corresponding switch again until the side window has closed. The side window is closed with increased force. <p>If a side window is obstructed again during closing and reopens again slightly:</p> <ul style="list-style-type: none"> ► Immediately after the window blocks, pull the corresponding switch again until the side window has closed. The side window is closed without the anti-entrapment feature. |

Sliding sunroof

Important safety notes

Your vehicle may be equipped with a sliding sunroof or a panorama roof with power tilt/sliding panel. In this section, the term "sliding sunroof" refers to both types of sliding sunroof.

WARNING

While opening and closing the sliding sunroof, body parts in close proximity could become trapped. There is a risk of injury.

Make sure that no body parts are in close proximity during the opening and closing procedures.

If somebody becomes trapped:

- release the switch immediately, or
- during automatic operation, push the switch briefly in any direction

The opening or closing procedure will be stopped.

WARNING

If children operate the sliding sunroof they could become trapped, particularly if they are left unsupervised. There is a risk of injury.

When leaving the vehicle, always take the SmartKey with you and lock the vehicle. Never leave children unsupervised in the vehicle.

The sliding sunroof is equipped with an automatic reversing feature. If an object blocks or restricts the sliding sunroof during

the closing process, the sliding sunroof opens again automatically.

WARNING

The reversing feature does not react:

- to soft, light and thin objects, e.g. small fingers
- over the last 4 mm of the closing movement
- during resetting
- when closing the sliding sunroof again manually immediately after automatic reversing

This means that the reversing feature cannot prevent someone being trapped in these situations. There is a risk of injury.

Make sure that no body parts are in close proximity during the closing procedure.

If somebody becomes trapped:

- release the switch immediately, or
- during automatic operation, push the switch briefly in any direction

The closing process is stopped.

! Only open the sliding sunroof if it is free of snow and ice. Otherwise, malfunctions may occur.

Do not allow anything to protrude from the sliding sunroof. Otherwise, the seals could be damaged.

i Resonance noises can occur in addition to the usual airflow noises when the sliding sunroof is open. They are caused by minor pressure fluctuations in the vehicle interior. Change the position of the sliding sunroof or open a side window. The noise will be reduced or eliminated.

Operating the sliding sunroof

Opening and closing



Overhead control panel

- ① To raise
- ② To open
- ③ To close/lower

► Turn the SmartKey to position **1** or **2** in the ignition lock.

► Press or pull the  switch in the corresponding direction.

i If you press the  switch beyond the point of resistance, an automatic opening/closing process is started in the corresponding direction. You can stop automatic operation by operating the switch again.

When opening and raising the roof, automatic operation is only available if the sliding sunroof is in the closed position.

The sun protection cover automatically opens along with the sliding sunroof. You can open or close the sun protection cover manually when the sliding sunroof is raised or closed.

i You can continue to operate the sliding sunroof after switching off the engine or removing the SmartKey from the ignition lock. This function is available for up to five minutes or until the driver's or front-passenger door is opened.

Resetting

❗ If the sliding sunroof still cannot be opened or closed fully after resetting, contact a qualified specialist workshop.

Reset the sliding sunroof if it does not move smoothly.

- ▶ Turn the SmartKey to position **1** or **2** in the ignition lock.
- ▶ Raise the sliding sunroof fully at the rear (▷ page 97).
- ▶ Keep the  switch pressed for another second.
- ▶ Make sure that the sliding sunroof can be fully opened and closed again (▷ page 97).
- ▶ If this is not the case, repeat the steps above again.

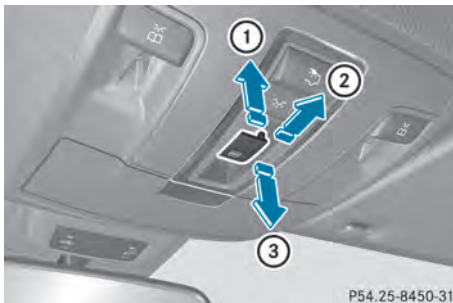

Operating the panorama roof with power tilt/sliding panel



Overhead control panel

- ① To raise
- ② To open
- ③ To close/lower

The panorama roof with power tilt/sliding panel can only be operated when the roller sunblind is open (▷ page 99).

- ▶ **To open and close:** turn the SmartKey to position **1** or **2** in the ignition lock.
- ▶ Press or pull the  switch in the corresponding direction.
- ❗ If you press the  switch beyond the point of resistance, an automatic opening/

closing process is started in the corresponding direction. You can stop automatic operation by operating the switch again.

The automatic raising feature is available only when the sliding sunroof is closed.

Operating the roller sunblinds for the panorama roof with power tilt/sliding panel

Important safety notes

WARNING

When opening or closing the roller sunblind, parts of the body could be trapped between the roller sunblind and the frame or sliding sunroof. There is a risk of injury.

When opening or closing make sure that no parts of the body are in the sweep of the roller sunblind.

If somebody becomes trapped:

- release the switch immediately, or
- during automatic operation, push the switch briefly in any direction

The opening or closing procedure will be stopped.



The roller sunblinds shield the vehicle interior from sunlight. The two roller sunblinds can only be opened and closed together when the panorama roof with power tilt/sliding panel is closed.

Opening and closing the roller sunblinds



Overhead control panel

- ① To open
- ② To open
- ③ To close

- ▶ Turn the SmartKey to position **1** or **2** in the ignition lock.
- ▶ Press or pull the  switch in the corresponding direction.
- ❗ If you press the  switch beyond the point of resistance, an automatic opening/closing process is started in the corresponding direction. You can stop automatic operation by operating the switch again.

Resetting the panorama roof with power tilt/sliding panel and the roller sunblinds





- ❗ If the panorama roof with power tilt/sliding panel and the roller sunblind cannot be fully opened or closed after resetting, contact a qualified specialist workshop.



Overhead control panel

- ① To open
- ② To open
- ③ To close

Reset the panorama roof with power tilt/sliding panel and the roller sunblinds if the panorama roof with power tilt/sliding panel or the roller sunblinds do not move smoothly.

- ▶ Turn the SmartKey to position **1** or **2** in the ignition lock.
- ▶ Pull the  switch repeatedly to the point of resistance in the direction of arrow ③ until the panorama roof with power tilt/sliding panel is fully closed.
- ▶ Keep the  switch pulled for an additional second.
- ▶ Pull the  switch repeatedly to the point of resistance in the direction of arrow ③ until the roller sunblinds are fully closed.
- ▶ Keep the  switch pulled for an additional second.
- ▶ Make sure that the panorama roof with power tilt/sliding panel (▷ page 98) and the roller sunblinds (▷ page 99) can be fully opened again.
- ▶ If this is not the case, repeat the steps above again.

Problems with the sliding sunroof**⚠ WARNING**

If you close the sliding sunroof again immediately after it has been blocked or reset, the sliding sunroof closes with increased or maximum force. The reversing feature is then not active. Parts of the body could be trapped in the closing area in the process. This poses an increased risk of injury or even fatal injury.

Make sure that no parts of the body are in the closing area.



If somebody becomes trapped:

- release the switch immediately, or
- during automatic operation, push the switch briefly in any direction

The closing process is stopped.

! If the sliding sunroof still cannot be opened or closed as a result of a malfunction, contact a qualified specialist workshop.

Your vehicle may be equipped with a sliding sunroof or a panorama roof with power tilt/sliding panel. In this section, the term "sliding sunroof" refers to both types of sliding sunroof.

| Problem | Possible causes/consequences and ► Solutions |
|--|---|
| The sliding sunroof cannot be closed and you cannot see the cause. | <p>If the sliding sunroof is obstructed during closing and reopens again slightly:</p> <p>► Immediately after the sliding sunroof blocks, pull the  switch in the overhead control panel down to the point of resistance and hold it until the sliding sunroof is closed. The sliding sunroof is closed with increased force.</p> <p>If the sliding sunroof is obstructed again during closing and then reopens slightly:</p> <p>► Immediately after the sliding sunroof blocks, pull the  switch in the overhead control panel down to the point of resistance and hold it until the sliding sunroof is closed. The sliding sunroof is closed without the anti-entrapment feature.</p> |

| | |
|--------------------------------------|-----|
| Useful information | 102 |
| Correct driver's seat position | 102 |
| Seats | 103 |
| Steering wheel | 110 |
| Mirrors | 113 |
| Memory function | 116 |

Useful information

- i** This Operator's Manual describes all models and all standard and optional equipment of your vehicle available at the time of publication of the Operator's Manual. Country-specific differences are possible. Please note that your vehicle may not be equipped with all features described. This also applies to safety-related systems and functions.
- i** Read the information on qualified specialist workshops: (▷ page 27).

Correct driver's seat position

⚠ WARNING

You could lose control of your vehicle if you do the following while driving:

- adjust the driver's seat, head restraint, steering wheel or mirrors
- fasten the seat belt

There is a risk of an accident.

Adjust the driver's seat, head restraint, steering wheel and mirror and fasten your seat belt before starting the engine.



- ▶ Observe the safety guidelines on seat adjustment (▷ page 103).
- ▶ Make sure that seat ③ is adjusted properly.
Electrical seat adjustment (▷ page 104)

When adjusting the seat, make sure that:

- you are as far away from the driver's air bag as possible.
 - you are sitting in a normal upright position.
 - you can fasten the seat belt properly.
 - you have moved the backrest to an almost vertical position.
 - you have set the seat cushion angle so that your thighs are gently supported.
 - you can depress the pedals properly.
- ▶ Check whether the head restraint is adjusted properly.

When doing so, make sure that you have adjusted the head restraint so that the back of your head is supported at eye level by the center of the head restraint. Also make sure that you have adjusted the head restraint so that the back of your head is as close to the head restraint as possible. This will be the case if the head restraint is adjusted correctly (▷ page 105).

- ▶ Observe the safety guidelines on steering wheel adjustment (▷ page 110).
- ▶ Make sure that steering wheel ① is adjusted properly.
Adjusting the steering wheel manually (▷ page 110)
Adjusting the steering wheel electrically (▷ page 111)

When adjusting the steering wheel, make sure that:

- you can hold the steering wheel with your arms slightly bent.
 - you can move your legs freely.
 - you can see all the displays in the instrument cluster clearly.
- ▶ Observe the safety guidelines for seat belts (▷ page 54).

- ▶ Check whether you have fastened seat belt ② properly (▷ page 56).

The seat belt should:

- fit snugly across your body
 - be routed across the middle of your shoulder
 - be routed in your pelvic area across the hip joints
- ▶ Before starting off, adjust the rear-view mirror and the exterior mirrors in such a way that you have a good view of road and traffic conditions (▷ page 113).
- ▶ **Vehicles with a memory function:** save the seat, steering wheel and exterior mirror settings with the memory function (▷ page 116).

Seats

Important safety notes

WARNING

Children could become trapped if they adjust the seats, particularly when unattended. There is a risk of injury.

When leaving the vehicle, always take the SmartKey with you and lock the vehicle. Never leave children unsupervised in the vehicle.

WARNING

You could lose control of your vehicle if you do the following while driving:

- adjust the driver's seat, head restraint, steering wheel or mirrors
- fasten the seat belt

There is a risk of an accident.

Adjust the driver's seat, head restraint, steering wheel and mirror and fasten your seat belt before starting the engine.

WARNING

If you adjust the seat height carelessly, you or other vehicle occupants could be trapped and thereby injured. Children in particular could

accidentally press the electrical seat adjustment buttons and become trapped. There is a risk of injury.

While moving the seats, make sure that your hands or other body parts do not get under the lever assembly of the seat adjustment system.

WARNING

When you adjust a seat, you or other vehicle occupants could become trapped, e.g. on the seat guide rail. There is a risk of injury.

Make sure when adjusting a seat that no one has any body parts in the sweep of the seat.

WARNING

If head restraints are not installed and adjusted correctly, they cannot provide protection as intended. There is an increased risk of injury in the head and neck area, e.g. in the event of an accident or when braking. Always drive with the head restraints installed. Before driving off, make sure for every vehicle occupant that the center of the head restraint supports the back of the head at about eye level.

WARNING

The seat belt does not offer the intended level of protection if the backrest is not in the upright position. When braking or in the event of an accident, you could slide underneath the seat belt and sustain abdomen or neck injuries, for example. This poses an increased risk of injury or even fatal injury.

Adjust the seat properly before beginning your journey. Always make sure that the seat is in the upright position.

WARNING

According to accident statistics, children are safer when properly restrained on the rear seats than on the front-passenger seat. Thus, we strongly recommend that children be placed in the rear seat whenever possible. Regardless of seating position, children 12

years old and under must be seated and properly secured in an appropriately sized child restraint system or booster seat recommended for the size and weight of the child. For additional information, see the "Children in the vehicle" section.

A child's risk of serious or fatal injuries is significantly increased if the child restraints are not properly secured in the vehicle and/or the child is not properly secured in the child restraint.

! To avoid damage to the seats and the seat heating, observe the following information:

- keep liquids from spilling on the seats. If liquid is spilled on the seats, dry them as soon as possible.
- if the seat covers are damp or wet, do not switch on the seat heating. The seat heating should also not be used to dry the seats.
- clean the seat covers as recommended; see "Interior care".
- do not transport heavy loads on the seats. Do not place sharp objects on the seat cushions, e.g. knives, nails or tools. The seats should only be occupied by passengers, if possible.
- when the seat heating is in operation, do not cover the seats with insulating materials, e.g. blankets, coats, bags, seat covers, child seats or booster seats.

! Make sure that there are no objects in the footwell or behind the seats when resetting the seats. There is a risk that the seats and/or the objects could be damaged.

i It is not possible to remove the head restraints from the front seats. The rear-compartment head restraints, however, can be removed (> page 106).

For more information, contact a qualified specialist workshop.

i Further related subjects:

- Important safety notes on air bags (> page 44)
- Cargo compartment enlargement (folding down the rear bench seat) (> page 335)
- Securing children in the vehicle (> page 60)

Adjusting the seats electrically

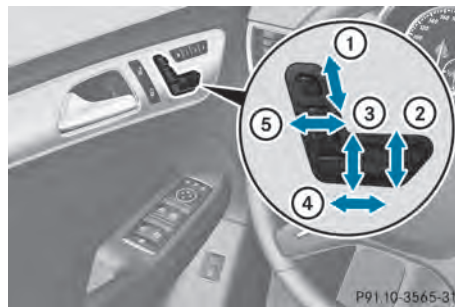

- ① Head restraint height
- ② Seat cushion angle
- ③ Seat height
- ④ Seat fore-and-aft adjustment
- ⑤ Backrest angle

i Vehicles with memory function: if PRE-SAFE® has been triggered, the front-passenger seat will be moved to a better position if it was previously in an unfavorable position.

i You can store the seat settings using the memory function (> page 116).

Adjusting the head restraints

General notes

Pay attention to the important safety notes (> page 103).

Do not rotate the head restraints of the front and rear seats. Otherwise, you cannot adjust

the height and angle of the head restraints to the correct position.

Adjusting the head restraints manually

Adjusting the head restraint height

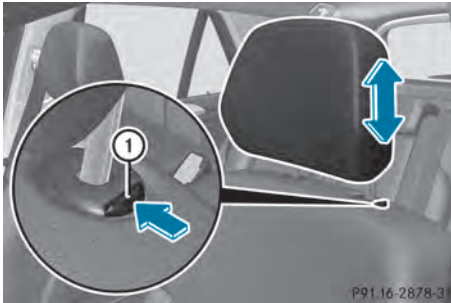

- ▶ **To raise:** pull the head restraint up to the desired position.
- ▶ **To lower:** press release catch (1) in the direction of the arrow and push the head restraint down to the desired position.

Adjusting the fore/aft position of the head restraint

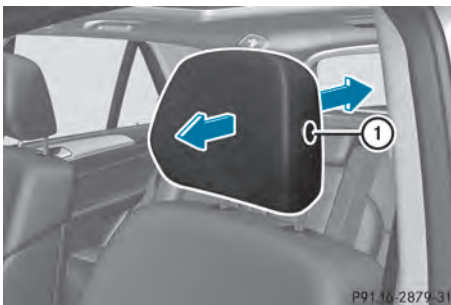

With this function you can adjust the distance between the head restraint and the back of the seat occupant's head.

- ▶ **To adjust forwards:** pull the head restraint forwards in the direction of the arrow until it engages.

There are several notches.

- ▶ **To move backwards:** press and hold release button (1) and push the head restraint backwards.
- ▶ When the head restraint is in the desired position, release the button and make sure that the head restraint is engaged in position.
- ❗ Adjust the head restraint so that the back of your head is as close to the head restraint as possible.

Adjusting the head restraints electrically

- ▶ **To adjust the head restraint height:** slide the switch for head restraint adjustment (▷ page 104) up or down in the direction of the arrow.

Adjusting the luxury head restraints

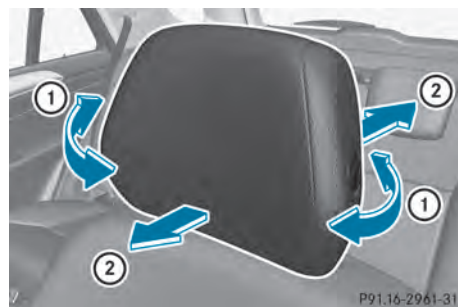

- ▶ **To adjust the side bolsters of the head restraint:** push or pull right and/or left-hand side bolster (1) into the desired position.
- ▶ **To adjust the fore/aft position of the head restraint:** push or pull the head restraint in the direction of arrow (2).

- ❗ Adjust the head restraint so that the back of your head is as close to the head restraint as possible.

Rear seat head restraints

Adjusting the rear seat head restraint height

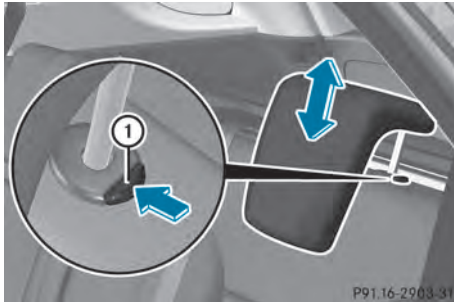

- ▶ Once the head restraint is fully lowered, press release catch ①.
- ▶ **To raise:** pull the head restraint up to the desired position.
- ▶ **To lower:** press release catch ① and push the head restraint down until it is in the desired position.

Removing and installing the rear seat head restraints

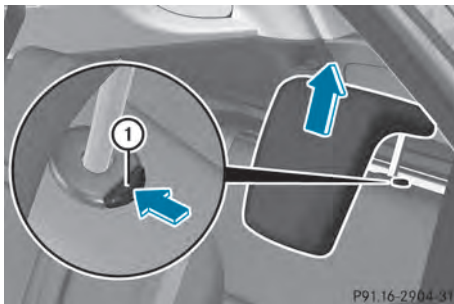

- ▶ **To remove:** pull the head restraint up to the stop.
- ▶ Press release catch ① and pull the head restraint out of the guides.
- ▶ **To re-install:** insert the head restraint so that the notches on the bar are on the left when viewed in the direction of travel.
- ▶ Push the head restraint down until you hear it engage in position.

Adjusting the angle of the rear seat backrests

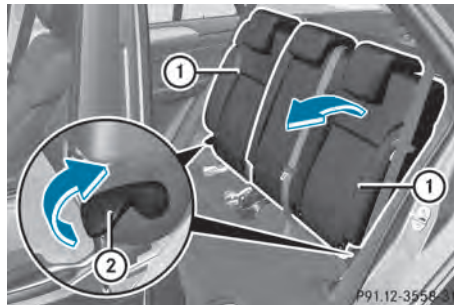

You can adjust the angle of the backrests in the second row of seats. There are ten detent positions to choose from.

- ▶ Pull the left or right release lever ② upwards in the direction of the arrow until the relevant backrest ① is fully released.
- ▶ Pull the backrest ① forwards in the direction of the arrow and allow it to engage.
- ▶ To ensure that the backrest has engaged, lean firmly against backrest ①.

Adjusting the multicontour seat

You can set the multicontour seat using COMAND. See the separate COMAND Operating Instructions.

Adjusting the 4-way lumbar support

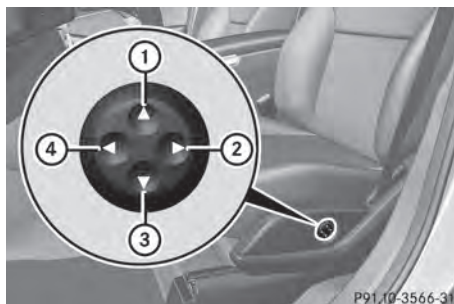

- ① To raise the backrest contour
- ② To soften the backrest contour
- ③ To lower the backrest contour
- ④ To harden the backrest contour

You can adjust the contour of the front seat backrests individually to provide optimum support for your back.

Switching the seat heating on/off

Activating/deactivating

WARNING

Repeatedly switching on the seat heating can cause the seat cushion and backrest pads to become very hot. The health of persons with limited temperature sensitivity or a limited ability to react to excessively high temperatures may be affected or they may even suffer burn-like injuries. There is a risk of injury.

Therefore, do not switch the seat heating on repeatedly.



Driver's and front-passenger seat

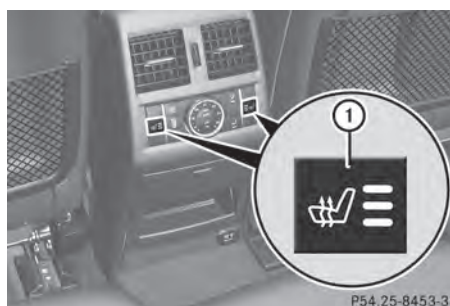

Rear seats

The three red indicator lamps in the button indicate the heating level you have selected.

The system automatically switches down from level **3** to level **2** after approximately eight minutes.

The system automatically switches down from level **2** to level **1** after approximately ten minutes.

The system automatically switches off approximately 35 minutes after it is set to level **1**.

You can set the distribution of the heated sections of the seat cushion and backrest. You can find information about this in the separate operating instructions.

- ▶ Make sure that the SmartKey is in position **1** or **2** in the ignition lock.
- ▶ **To switch on:** press button ① repeatedly until the desired heating level is set.
- ▶ **To switch off:** press button ① repeatedly until all the indicator lamps go out.

- i** If the battery voltage is too low, the seat heating may switch off.

Problems with the seat heating

| Problem | Possible causes/consequences and ► Solutions |
|---|---|
| The seat heating has switched off prematurely or cannot be switched on. | <p>The on-board voltage is too low because too many electrical consumers are switched on.</p> <p>► Switch off electrical consumers that you do not need, such as the rear window defroster or interior lighting.</p> <p>Once the battery is sufficiently charged, the seat heating will switch back on automatically.</p> |

Switching the seat ventilation on/off

Activating/deactivating



The three blue indicator lamps in the buttons indicate the ventilation level you have selected.

- Make sure that the SmartKey is in position **2** in the ignition lock.
- **To switch on:** press button ① repeatedly until the desired ventilation level is set.
- **To switch off:** press button ① repeatedly until all the indicator lamps go out.

- i** If the battery voltage is too low, the seat ventilation may switch off.
- i** You can open the side windows and the sliding sunroof using the "Convenience opening" feature (▷ page 93). The seat ventilation of the driver's seat automatically switches to the highest level.

Problems with the seat ventilation

| Problem | Possible causes/consequences and ► Solutions |
|---|--|
| The seat ventilation has switched off prematurely or cannot be switched on. | The on-board voltage is too low because too many electrical consumers are switched on. ► Switch off electrical consumers that you do not need, such as the rear window defroster or interior lighting. Once the battery is sufficiently charged, the seat ventilation will switch back on automatically. |

Steering wheel

Important safety notes

WARNING

You could lose control of your vehicle if you do the following while driving:

- adjust the driver's seat, head restraint, steering wheel or mirrors
- fasten the seat belt

There is a risk of an accident.

Adjust the driver's seat, head restraint, steering wheel and mirror and fasten your seat belt before starting the engine.

WARNING

Children could injure themselves if they adjust the steering wheel. There is a risk of injury.

When leaving the vehicle, always take the SmartKey with you and lock the vehicle. Never leave children unsupervised in the vehicle.

Adjusting the steering wheel manually

WARNING

If the steering wheel is unlocked while the vehicle is in motion, it could change position unexpectedly. This could cause you to lose control of the vehicle. There is a risk of an accident.

Before starting off, make sure the steering wheel is locked. Never unlock the steering wheel while the vehicle is in motion.

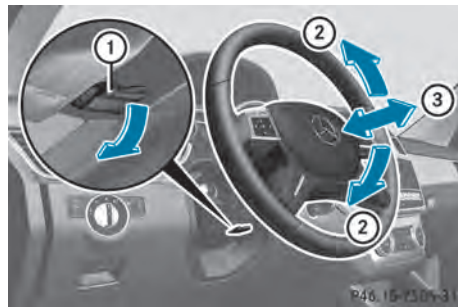

- ① Release lever
 - ② To adjust the steering wheel height
 - ③ To adjust the steering wheel position (fore-and-aft adjustment)
- Push release lever ① down completely. The steering column is unlocked.
 - Adjust the steering wheel to the desired position.
 - Push release lever ① up completely. The steering column is locked.
 - Check if the steering column is locked. When doing so, try to push the steering wheel up or down or try to move it in the fore-and-aft direction.

Adjusting the steering wheel electrically

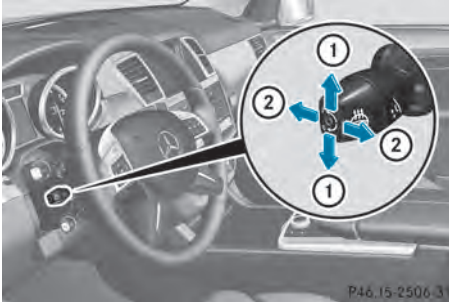

- ① To adjust the steering wheel height
- ② To adjust the steering wheel position (fore-and-aft adjustment)

The steering wheel can also be adjusted when the SmartKey is removed from the ignition lock.

- i Further related subjects:
 - EASY-ENTRY/EXIT feature (▷ page 112)
 - Storing settings (▷ page 116)

Steering wheel heating

Activating/deactivating

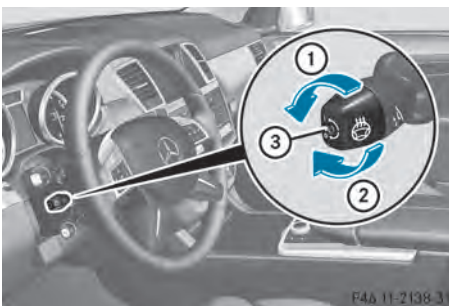

- ▶ Make sure that the SmartKey is in position **2** in the ignition lock.
- ▶ **To switch on/off:** turn the lever in the direction of arrow **①** or **②**. Indicator lamp **③** lights up or goes out.

Vehicles without KEYLESS-GO: when you remove the SmartKey from the ignition lock, the steering wheel heating is deactivated.

Vehicles with KEYLESS-GO: when you switch off the ignition and open the driver's door, the steering wheel heating is deactivated.

Problems with the steering wheel heating

| Problem | Possible causes/consequences and ► Solutions |
|---|---|
| The steering wheel heating has switched off prematurely or cannot be switched on. | The on-board voltage is too low because too many electrical consumers are switched on. ► Switch off electrical consumers that you do not need, such as the rear window defroster or interior lighting. |

EASY-ENTRY/EXIT feature

Important safety notes

WARNING

When the EASY-ENTRY/EXIT feature adjusts the steering wheel, you and other vehicle occupants – particularly children – could become trapped. There is a risk of injury.

While the EASY-ENTRY/EXIT feature is making adjustments, make sure that no one has any body parts in the sweep of the steering wheel.

If somebody becomes trapped:

- press one of the memory function position buttons, or
- move the switch for steering wheel adjustment in the opposite direction to that in which the steering wheel is moving.

The adjustment process is stopped.

WARNING

If children activate the EASY-ENTRY/EXIT feature, they can become trapped, particularly when unattended. There is a risk of injury.

When leaving the vehicle, always take the SmartKey with you and lock the vehicle. Never leave children unsupervised in the vehicle.

WARNING

If you drive off while the EASY-ENTRY/EXIT feature is making adjustments, you could lose control of the vehicle. There is a risk of an accident.

Always wait until the adjustment process is complete before driving off.

The EASY-ENTRY/EXIT feature makes getting in and out of your vehicle easier.

You can activate and deactivate the EASY-ENTRY/EXIT feature in the on-board computer (► page 277).

Position of the steering wheel when the EASY-ENTRY/EXIT feature is active

The steering wheel swings upwards when you:

- remove the SmartKey from the ignition lock
- open the driver's door with KEYLESS-GO in position **1**
- open the driver's door and the SmartKey is in position **0** or **1** in the ignition lock

 The steering wheel only moves upwards if it has not already reached the upper end stop.

Position of the steering wheel for driving

The steering wheel is moved to the last selected position when:

- the driver's door is closed
- you insert the SmartKey into the ignition lock
or
- you press the Start/Stop button once on vehicles with KEYLESS-GO

When you close the driver's door with the ignition switched on, the steering wheel is

also automatically moved to the previously set position.

The last position of the steering wheel is stored when you switch off the ignition or when you store the setting with the memory function (▷ page 116).

Crash-responsive EASY-EXIT feature

If the crash-responsive EASY-EXIT feature is triggered in an accident, the steering column will move upwards when the driver's door is opened. This occurs irrespective of the position of the SmartKey in the ignition lock. This makes it easier to exit the vehicle and rescue the occupants.

The crash-responsive EASY-EXIT feature is only operational if the EASY-EXIT/ENTRY feature is activated in the on-board computer (▷ page 277).

Mirrors

Rear-view mirror



- ▶ **Anti-glare mode:** flick anti-glare lever ① forwards or back.

Exterior mirrors

Adjusting the exterior mirrors

WARNING

The exterior mirror on the front-passenger side reduces the size of the image. Visible objects are actually closer than they appear.

This means that you could misjudge the distance from road users traveling behind, e.g. when changing lane. There is a risk of an accident.

For this reason, always make sure of the actual distance from the road users traveling behind by glancing over your shoulder.

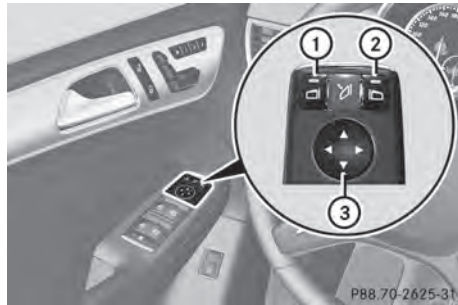

- ▶ Make sure that the SmartKey is in position 1 or 2 in the ignition lock.
- ▶ Press button ① for the left-hand exterior mirror or button ② for the right-hand exterior mirror. The indicator lamp in the corresponding button lights up in red. The indicator lamp goes out again after some time. You can adjust the selected mirror using adjustment button ③ as long as the indicator lamp is lit.
- ▶ Press adjustment button ③ up, down, or to the left or right until you have adjusted the exterior mirror to the correct position. You should have a good overview of traffic conditions.

The convex exterior mirrors provide a larger field of vision.

The exterior mirrors are heated automatically if the rear window defroster is switched on and the outside temperature is low.

Folding the exterior mirrors in or out electrically



- ▶ Make sure that the SmartKey is in position **1** or **2** in the ignition lock.
- ▶ Briefly press button **①**.
Both exterior mirrors fold in or out.
- i** Make sure that the exterior mirrors are always folded out fully while driving. They could otherwise vibrate.
- i** If you are driving faster than 30 mph (47 km/h), you can no longer fold in the exterior mirrors.

Setting the exterior mirrors

If the battery has been disconnected or completely discharged, the exterior mirrors must be reset. The exterior mirrors will otherwise not fold in when you select the "Fold in mirrors when locking" function in the on-board computer (▷ page 277).

- ▶ Make sure that the SmartKey is in position **1** in the ignition lock.
- ▶ Briefly press button **①**.

Folding the exterior mirrors in or out automatically

If the "Fold in mirrors when locking" function is activated in the on-board computer: (▷ page 277)

- the exterior mirrors fold in automatically as soon as you lock the vehicle from the outside.
- the exterior mirrors fold out again automatically as soon as you unlock the vehicle and then open the driver's or front-passenger door.

Exterior mirror pushed out of position

If an exterior mirror has been pushed out of position, proceed as follows:

- ▶ **Vehicles without electrically folding exterior mirrors:** move the exterior mirror into the correct position manually.
- ▶ **Vehicles with electrically folding exterior mirrors:** press and hold button for folding the mirrors **①** (▷ page 114) until you hear a click and then the mirror engage in position.
The mirror housing is engaged again and you can adjust the exterior mirrors as usual (▷ page 113).

Automatic anti-glare mirrors

The rear-view mirror and the exterior mirror on the driver's side automatically go into anti-glare mode if the following conditions are met simultaneously:

- the ignition is switched on and
 - incident light from headlamps strikes the sensor in the rear-view mirror.
- i** The mirrors do not go into anti-glare mode if reverse gear is engaged or if the interior lighting is switched on.

Parking position for the exterior mirror on the front-passenger side

Setting and storing the parking position

Using reverse gear

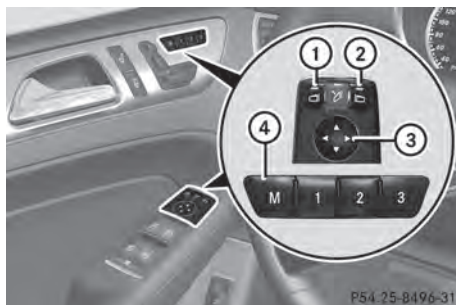

- ① Button for the driver's side exterior mirror
- ② Button for the front-passenger side exterior mirror
- ③ Adjustment button
- ④ Memory button **M**

You can position the front-passenger side exterior mirror in such a way that you can see the rear wheel on that side as soon as you engage reverse gear. You can store this position.

- ▶ Make sure that the vehicle is stationary and that the SmartKey is in position **2** in the ignition lock.
 - ▶ Press button ② for the exterior mirror on the front-passenger side.
 - ▶ Engage reverse gear. The exterior mirror on the front-passenger side moves to the preset parking position.
 - ▶ Use adjustment button ③ to adjust the exterior mirror to a position that allows you to see the rear wheel and the curb. The parking position is stored.
- i** If you shift the transmission to another position, the exterior mirror on the front-passenger side returns to the driving position.

Using the memory button

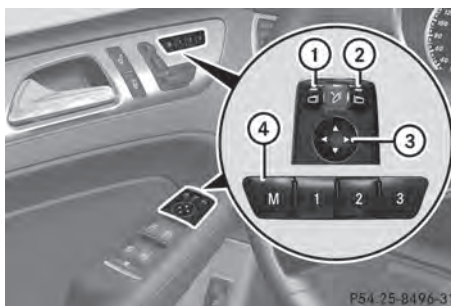

- ① Button for the driver's side exterior mirror
- ② Button for the front-passenger side exterior mirror
- ③ Adjustment button
- ④ Memory button **M**

You can position the front-passenger side exterior mirror in such a way that you can see the rear wheel on that side as soon as you engage reverse gear. This setting can be stored using memory button **M** ④.

- ▶ Make sure that the SmartKey is in position **2** in the ignition lock.
- ▶ With the exterior mirror on the front-passenger side activated, use adjustment button ③ to adjust the exterior mirror. In the exterior mirror, the rear wheel and the curb should be visible.
- ▶ Press memory button **M** ④ and one of the arrows on adjustment button ③ within three seconds. The parking position is stored if the exterior mirror does not move.
- ▶ If the mirror moves out of position, repeat the steps.

Calling up a stored parking position setting

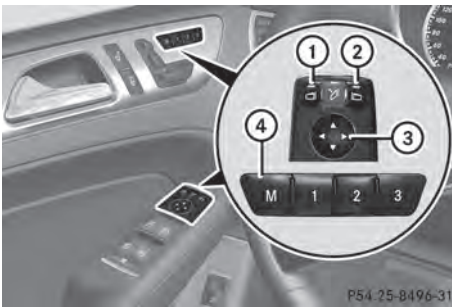

- ① Button for the driver's side exterior mirror
- ② Button for the front-passenger side exterior mirror
- ③ Adjustment button
- ④ Memory button **M**

- ▶ Turn the SmartKey to position **2** in the ignition lock.
- ▶ Adjust the exterior mirror on the front-passenger side using button ②.
- ▶ Engage reverse gear.
The exterior mirror on the front-passenger side moves to the stored parking position.

The exterior mirror on the front-passenger side moves back to its original position:

- as soon as you exceed a speed of 9 mph (15 km/h)
- if you press button ① for the exterior mirror on the driver's side

Memory function

Storing settings

WARNING

If you use the memory function on the driver's side while driving, you could lose control of the vehicle as a result of the adjustments being made. There is a risk of an accident.

Only use the memory function on the driver's side when the vehicle is stationary.

WARNING

When the memory function adjusts the seat or steering wheel, you and other vehicle occupants – particularly children – could become trapped. There is a risk of injury.

While the memory function is making adjustments, make sure that no one has any body parts in the sweep of the seat or steering wheel. If somebody becomes trapped, immediately release the memory function position button. The adjustment process is stopped.

WARNING

Children could become trapped if they activate the memory function, particularly when unattended. There is a risk of injury.

When leaving the vehicle, always take the SmartKey with you and lock the vehicle. Never leave children unsupervised in the vehicle.

With the memory function, you can store up to three different settings, e.g. for three different people.

The following settings are stored as a single memory preset:

- position of the seat, backrest and head restraint
- driver's side: steering wheel position
- driver's side: position of the exterior mirrors on the driver's and front-passenger sides



- ▶ Adjust the seat (▷ page 104).
- ▶ On the driver's side, adjust the steering wheel (▷ page 111) and the exterior mirrors (▷ page 113).
- ▶ Press the **M** memory button and then press one of the storage position buttons **1**, **2** or **3** within three seconds.
The settings are stored in the selected preset position. A tone sounds when the settings have been completed.

The memory function can still be used if the SmartKey has been removed.

Calling up a stored setting

- ▶ Press the button for storage position **1**, **2** or **3**. Keep pressing until the seat, steering wheel and exterior mirrors are in the stored position.
- ❗ The setting procedure is interrupted as soon as you release the storage position buttons.

| | |
|--------------------------|-----|
| Useful information | 120 |
| Exterior lighting | 120 |
| Interior lighting | 127 |
| Replacing bulbs | 128 |
| Windshield wipers | 132 |

Useful information

- i** This Operator's Manual describes all models and all standard and optional equipment of your vehicle available at the time of publication of the Operator's Manual. Country-specific differences are possible. Please note that your vehicle may not be equipped with all features described. This also applies to safety-related systems and functions.
- i** Read the information on qualified specialist workshops: (▷ page 27).

Exterior lighting

General notes

For reasons of safety, Mercedes-Benz recommends that you drive with the lights switched on even during the daytime. In some countries, operation of the headlamps varies due to legal requirements and self-imposed obligations.

Driving abroad

Conversion to symmetrical low beam

Switch the headlamps to symmetrical low beam in countries in which traffic drives on the opposite side of the road from the country where the vehicle is registered. This prevents glare to oncoming traffic. When using symmetrical lights, the edge of the road is not lit as widely and as far ahead as normal.

Have the headlamps converted at a qualified specialist workshop as close to the border as possible before driving in these countries.

Conversion to asymmetrical low beam after returning

Have the headlamps converted back to asymmetrical low-beam headlamps at a qualified specialist workshop as soon as possible after crossing the border again.

Setting the exterior lighting

Setting options

Exterior lighting can be set using:

- the light switch
- the combination switch (▷ page 123)
- the on-board computer (▷ page 274)

Light switch

Operation

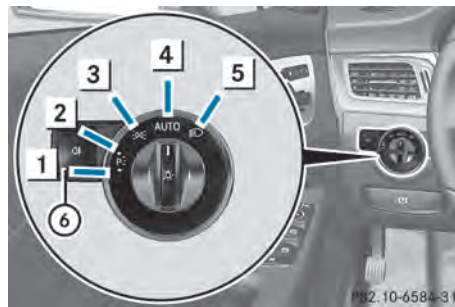

- 1** Left-hand standing lamps
- 2** Right-hand standing lamps
- 3** Parking lamps, license plate and instrument cluster lighting
- 4** **AUTO** Automatic headlamp mode, controlled by the light sensor
- 5** Low-beam/high-beam headlamps
- 6** Rear fog lamp

If you hear a warning tone when you leave the vehicle, the lights may still be switched on.

- ▶ Turn the light switch to **AUTO**.

The exterior lighting (except the parking/standing lamps) switches off automatically if you:

- remove the SmartKey from the ignition lock
- open the driver's door with the SmartKey in position **0**.

Automatic headlamp mode

WARNING





When the light switch is set to **AUTO**, the low-beam headlamps may not be switched on

automatically if there is fog, snow or other causes of poor visibility due to the weather conditions such as spray. There is a risk of an accident.

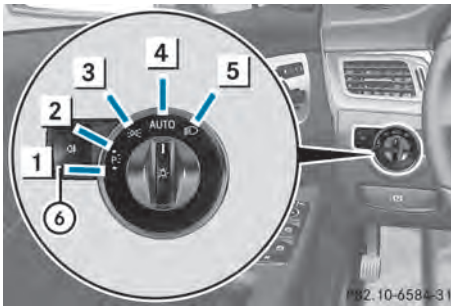
In such situations, turn the light switch to .

The automatic headlamp feature is only an aid. The driver is responsible for the vehicle's lighting at all times.



- 1  Left-hand standing lamps
- 2  Right-hand standing lamps
- 3  Parking lamps, license plate and instrument cluster lighting
- 4 **AUTO** Automatic headlamp mode, controlled by the light sensor
- 5  Low-beam/high-beam headlamps
- 6  Rear fog lamp

AUTO is the favored light switch setting. The light setting is automatically selected according to the brightness of the ambient light (exception: poor visibility due to weather conditions such as fog, snow or spray):



- SmartKey in position 1 in the ignition lock: the parking lamps are switched on or off automatically depending on the brightness of the ambient light.
- With the engine running: if you have activated the daytime running lamps function via the on-board computer, the daytime running lamps or the low-beam headlamps and parking lamps are switched on or off automatically depending on the brightness of the ambient light.

► **To switch on automatic headlamp mode:** turn the light switch to **AUTO**.

Only for Canada:



The daytime running lamps improve the visibility of your vehicle during the day. The daytime running lamps function is required by law in Canada. It cannot therefore be deactivated.

When the engine is running and the vehicle is stationary: if you move the selector lever from a drive position to **P**, the daytime running lamps/low-beam headlamps go out after three minutes.

When the engine is running, the vehicle is stationary and in high ambient light: if you turn the light switch to , you turn on the daytime running lamps and parking lamps. If the engine is running and you turn the light switch to , the manual settings take precedence over the daytime running lamps.

USA only:

The daytime running lamps improve the visibility of your vehicle during the day. To do this, the daytime running lamps function must be switched on using the on-board computer (> page 274).

If the engine is running and you turn the light switch to  or , the manual settings take precedence over the daytime running lamps.

i In the USA, the daytime running lamps are deactivated upon delivery from the factory.

Low-beam headlamps

WARNING

When the light switch is set to **AUTO**, the low-beam headlamps may not be switched on automatically if there is fog, snow or other causes of poor visibility due to the weather conditions such as spray. There is a risk of an accident.

In such situations, turn the light switch to .

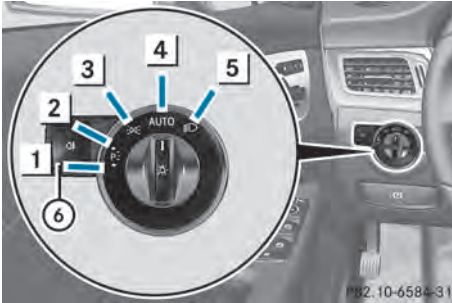

- 1 Left-hand standing lamps
- 2 Right-hand standing lamps
- 3 Parking lamps, license plate and instrument cluster lighting
- 4 **AUTO** Automatic headlamp mode, controlled by the light sensor
- 5 Low-beam/high-beam headlamps
- 6 Rear fog lamp

Even if the light sensor does not detect that it is dark, the parking lamps and low-beam headlamps switch on when the ignition is switched on and the light switch is set to the position. This is a particularly useful function in the event of rain and fog.

- ▶ **To switch on the low-beam headlamps:** turn the SmartKey in the ignition lock to position **2** or start the engine.
- ▶ Turn the light switch to . The green indicator lamp in the instrument cluster lights up.

Rear fog lamp

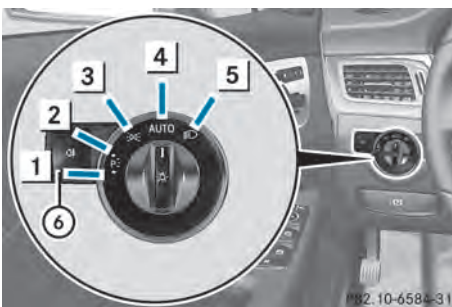

- 1 Left-hand standing lamps
- 2 Right-hand standing lamps

- 3 Parking lamps, license plate and instrument cluster lighting
- 4 **AUTO** Automatic headlamp mode, controlled by the light sensor
- 5 Low-beam/high-beam headlamps
- 6 Rear fog lamp

The rear fog lamp improves visibility of your vehicle for the traffic behind in the event of thick fog. Please take note of the country-specific regulations for the use of rear fog lamps.

- ▶ **To switch on the rear fog lamps:** turn the SmartKey in the ignition lock to position **2** or start the engine.
- ▶ Turn the light switch to or **AUTO**.
- ▶ Press the button. The yellow indicator lamp in the instrument cluster lights up.
- ▶ **To switch off the rear fog lamp:** press the button. The yellow indicator lamp in the instrument cluster goes out.

Parking lamps

- ! If the battery has been excessively discharged, the parking lamps or standing lamps are automatically switched off to enable the next engine start. Always park your vehicle safely and sufficiently lit according to legal standards. Avoid the continuous use of the parking lamps for several hours. If possible, switch on the right or the left standing lamp.

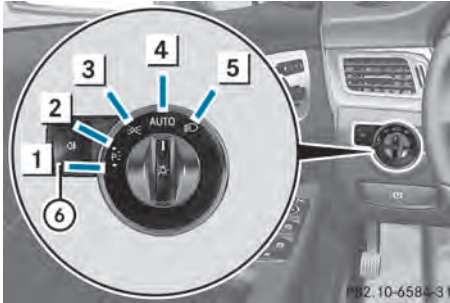

- 1 Left-hand standing lamps
- 2 Right-hand standing lamps
- 3 Parking lamps, license plate and instrument cluster lighting
- 4 **AUTO** Automatic headlamp mode, controlled by the light sensor
- 5 Low-beam/high-beam headlamps
- 6 Rear fog lamp

► **To switch on:** turn light switch to . The green indicator lamp in the instrument cluster lights up.

Standing lamps

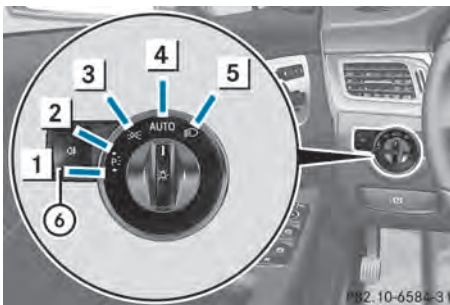

- 1 Left-hand standing lamps
- 2 Right-hand standing lamps
- 3 Parking lamps, license plate and instrument cluster lighting
- 4 **AUTO** Automatic headlamp mode, controlled by the light sensor
- 5 Low-beam/high-beam headlamps
- 6 Rear fog lamp

Switching on the standing lamps ensures the corresponding side of the vehicle is illuminated.

- **To switch on the standing lamps:** the SmartKey is not in the ignition lock or it is in position 0.
- Turn the light switch to (left-hand side of the vehicle) or (right-hand side of the vehicle).

Combination switch

Turn signal

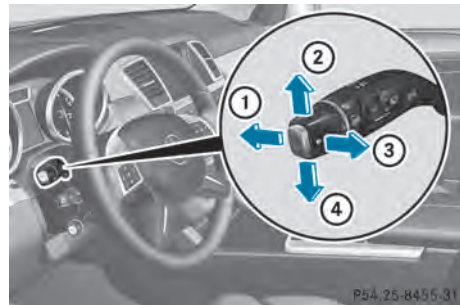

- 1 High-beam headlamps
- 2 Turn signal, right
- 3 High-beam flasher
- 4 Turn signal, left

► **To indicate briefly:** press the combination switch briefly to the pressure point in the direction of arrow ② or ④. The corresponding turn signal flashes three times.

► **To indicate:** press the combination switch beyond the pressure point in the direction of arrow ② or ④.

High-beam headlamps

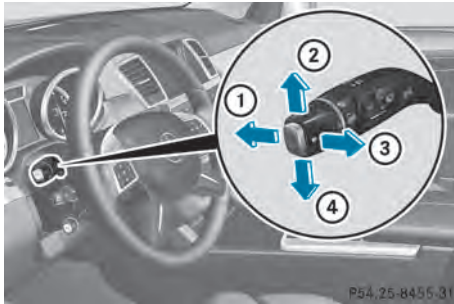

- ① High-beam headlamps
- ② Turn signal, right
- ③ High-beam flasher
- ④ Turn signal, left

► **To switch on the high-beam headlamps:** turn the SmartKey in the ignition lock to position **2** or start the engine.

► Turn the light switch to  or **AUTO**.

► Press the combination switch beyond the pressure point in the direction of arrow ①.

In the **AUTO** position, the high-beam headlamps are only switched on when it is dark and the engine is running.

The blue  indicator lamp in the instrument cluster lights up when the high-beam headlamps are switched on.

► **To switch off the high-beam headlamps:** move the combination switch back to its normal position.

The blue  indicator lamp in the instrument cluster goes out.

i Vehicles with Adaptive Highbeam Assist: when Adaptive Highbeam Assist is active, it controls activation of the high-beam headlamps (► page 125).

High-beam flasher

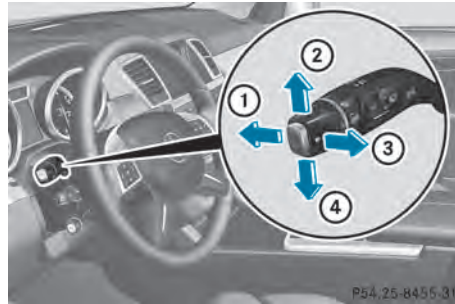

- ① High-beam headlamps
- ② Turn signal, right
- ③ High-beam flasher
- ④ Turn signal, left

► **To switch on:** turn the SmartKey in the ignition lock to position **1** or **2** or start the engine.

► Pull the combination switch in the direction of arrow ③.

Hazard warning lamps



► **To switch on the hazard warning lamps:** press button ①.

All turn signals flash. If you now switch on a turn signal using the combination switch, only the turn signal lamp on the corresponding side of the vehicle will flash.

► **To switch off the hazard warning lamps:** press button ①.

The hazard warning lamps automatically switch on if:

- an air bag is deployed.
- the vehicle decelerates rapidly from a speed of more than 45mph (70 km/h) and comes to a standstill.

The hazard warning lamps switch off automatically if the vehicle reaches a speed of over 6mph (10km/h) again after a full brake application.

- ❗ The hazard warning lamps still operate if the ignition is switched off.

Headlamp cleaning system

The headlamps are cleaned automatically if the "Wipe with washer fluid" function is operated five times (▷ page 132) while the lights are on and the engine is running. When you switch off the ignition, the automatic headlamp cleaning system is reset and counting is resumed from 0.

Active light function



The active light function is a system that moves the headlamps according to the steering movements of the front wheels. In this way, relevant areas remain illuminated while driving. This allows you to recognize pedestrians, cyclists and animals.

Active: when the lights are switched on.

Cornering light function



The cornering light function improves the illumination of the road over a wide angle in the direction you are turning, enabling better visibility in tight bends, for example. It can only be activated when the low-beam headlamps are switched on.

Active:

- if you are driving at speeds below 25mph (40 km/h) and switch on the turn signal or turn the steering wheel
- if you are driving at speeds between 25mph (40 km/h) and 45mph (70 km/h) and turn the steering wheel

Not active: if your speed exceeds 25mph (40 km/h) or if you switch off the turn signal or turn the steering wheel to the straight-ahead position.

The cornering light function may remain lit for a short time, but is automatically switched off after no more than three minutes.

Adaptive Highbeam Assist

Important safety notes

⚠ WARNING

Adaptive Highbeam Assist does not recognize road users:

- who have no lights, e.g. pedestrians
- who have poor lighting, e.g. cyclists
- whose lighting is blocked, e.g. by a barrier

In very rare cases, Adaptive Highbeam Assist may fail to recognize other road users that have lights, or may recognize them too late. In this or similar situations, the automatic high-beam headlamps will not be deactivated or activated regardless. There is a risk of an accident.

Always carefully observe the traffic conditions and switch off the high-beam headlamps in good time.



You can use this function to set the headlamps to change between low beam and high beam automatically. The system recognizes vehicles with their lights on, either approaching from the opposite direction or traveling in front of your vehicle, and consequently switches the headlamps from high beam to low beam.

The system automatically adapts the low-beam headlamp range depending on the distance to the other vehicle. Once the system no longer detects any other vehicles, it reactivates the high-beam headlamps.

The system's optical sensor is located behind the windshield near the overhead control panel.

Switching Adaptive Highbeam Assist on/off

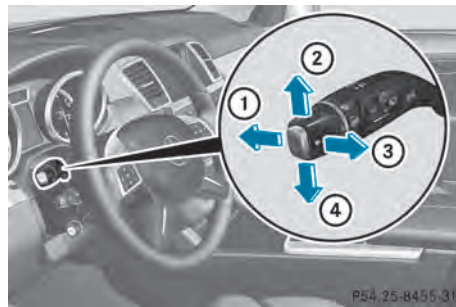

- ① High-beam headlamps
- ② Turn signal, right
- ③ High-beam flasher
- ④ Turn signal, left



- ▶ **To activate:** activate the Adaptive Highbeam Assist function using the on-board computer (▷ page 275).
- ▶ Turn the light switch to **AUTO**.
- ▶ Press the combination switch beyond the pressure point in the direction of arrow ① (▷ page 123).

The  indicator lamp in the multifunction display lights up if it is dark and the light sensor activates the low-beam headlamps.

If you are driving at speeds above approximately 28 mph (45 km/h): the headlamp range is set automatically depending on the distance between the vehicle and other road users.

If you are driving at speeds above approximately 35 mph (55 km/h) and no other road users have been detected: the high-beam headlamps are switched on automatically. The  indicator lamp in the instrument cluster also lights up.

If you are driving at speeds below approximately 30 mph (45 km/h) or other road users have been detected or the roads are adequately lit:

The high-beam headlamps are switched off automatically. The  indicator lamp in the instrument cluster goes out. The  indicator lamp in the multifunction display remains lit.

- ▶ **To deactivate:** move the combination switch back to its normal position. The  indicator lamp in the instrument cluster goes out.

Headlamps fogged up on the inside

The headlamps may fog up on the inside if there is high atmospheric humidity.

- ▶ Switch on the lights and drive off. The level of moisture diminishes, depending on the length of the journey and the weather conditions (humidity and temperature).

If the level of moisture does not diminish:



- ▶ Have the headlamps checked at a qualified specialist workshop.

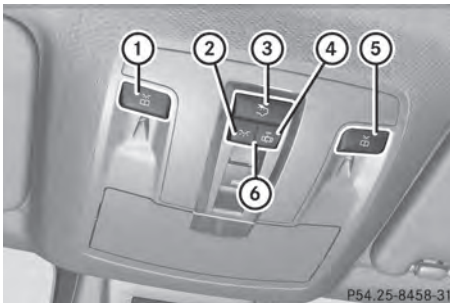

Interior lighting

Overview of interior lighting



Overhead control panel

- ①  To switch the left-hand front reading lamp on/off
- ②  To switch the front interior lighting on
- ③  To switch the rear interior lighting on/off

- ④  To switch the front interior lighting/automatic interior lighting control off
- ⑤  To switch the right-hand front reading lamp on/off
- ⑥ To switch the automatic interior lighting control on

Interior lighting control

General notes



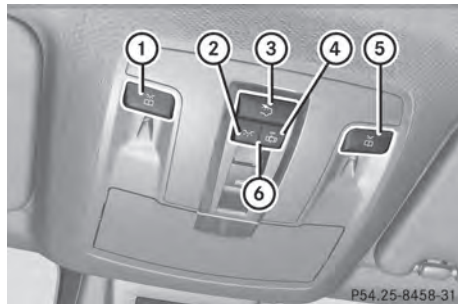

In order to prevent the vehicle's battery from discharging, the interior lighting functions are automatically deactivated after some time except for when the SmartKey is in position **2** in the ignition lock.

The color and brightness of the ambient lighting can be adjusted using the on-board computer (▷ page 275).

Automatic interior lighting control



Overhead control panel

- ①  To switch the left-hand front reading lamp on/off
- ②  To switch the front interior lighting on
- ③  To switch the rear interior lighting on/off
- ④  To switch the front interior lighting/automatic interior lighting control off
- ⑤  To switch the right-hand front reading lamp on/off
- ⑥ To switch the automatic interior lighting control on

- ▶ **To switch on:** set the switch to center position ⑥.
- ▶ **To switch off:** set the switch to the  position.

The interior lighting automatically switches on if you:





- unlock the vehicle
- open a door
- remove the SmartKey from the ignition lock.

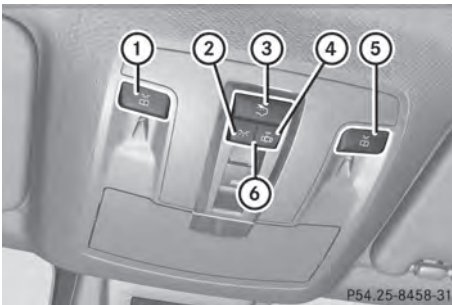



The interior light is activated for a short while when the SmartKey is removed from the ignition lock. You can activate this delayed switch-off using the on-board computer (▷ page 276).

Manual interior lighting control



Overhead control panel

- ①  To switch the left-hand front reading lamp on/off
- ②  To switch the front interior lighting on
- ③  To switch the rear interior lighting on/off
- ④  To switch the front interior lighting/automatic interior lighting control off
- ⑤  To switch the right-hand front reading lamp on/off
- ⑥ To switch the automatic interior lighting control on

- ▶ **To switch the front interior lighting on:** set the switch to the  position.
- ▶ **To switch the interior lighting off:** set the switch to the  position or (if the door is closed) to the center position.
- ▶ **To switch the rear interior lighting on/off:** press the  button.
- ▶ **To switch the reading lamps on/off:** press the  button.

Crash-responsive emergency lighting

The interior lighting is activated automatically if the vehicle is involved in an accident.

- ▶ **To switch off the crash-responsive emergency lighting:** press the hazard warning lamp button.
- or
- ▶ Lock and then unlock the vehicle using the SmartKey.

Replacing bulbs

Important safety notes

Xenon bulbs

DANGER

Xenon bulbs carry a high voltage. You can get an electric shock if you remove the cover of the Xenon bulb and touch the electrical contacts. There is a risk of fatal injury.

Never touch the parts or the electrical contacts of the Xenon bulb. Always have work on the Xenon bulbs carried out at a qualified specialist workshop.

If your vehicle is equipped with Xenon bulbs, you can recognize this by the following: the cone of light from the Xenon bulbs moves from the top to the bottom and back again when you start the engine. For this to be observed, the lights must be switched on before starting the engine.

Bulbs and lamps are an important aspect of vehicle safety. You must therefore make sure that these function correctly at all times. Have the headlamp setting checked regularly.

Other bulbs

WARNING

Bulbs, lamps and connectors can get very hot when operating. If you change a bulb, you could burn yourself on these components. There is a risk of injury.

Allow these components to cool down before changing a bulb.

There are bulbs other than the Xenon bulbs that you cannot replace. Replace only the bulbs listed (> page 129). Have the bulbs that you cannot replace yourself changed at a qualified specialist workshop.

If you require assistance changing bulbs, consult a qualified specialist workshop.

Do not touch the glass tube of new bulbs with your bare hands. Even minor contamination can burn into the glass surface and reduce the service life of the bulbs. Always use a lint-free cloth or only touch the base of the bulb when installing.

Only use bulbs of the correct type.

If the new bulb still does not light up, consult a qualified specialist workshop.

Bulbs and lamps are an important aspect of vehicle safety. You must therefore make sure that these function correctly at all times. Have the headlamp setting checked regularly.

Overview: changing bulbs/bulb types

You can change the following bulbs. The bulb type can be found in the legend.

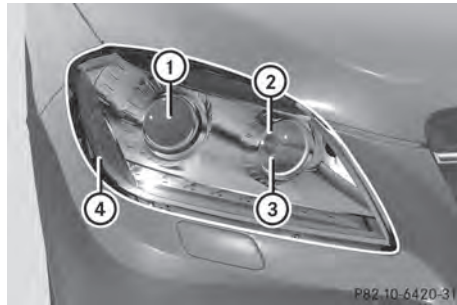

Halogen headlamps

- ① Low-beam headlamp: H7 55 W
- ② High-beam headlamp: H7 55 W
- ③ Parking lamp/standing lamp: W 5 W BV
- ④ Side marker lamp: WY 5 W



Tail lamp

- ① Brake lamp: P 21 W-L

Changing the front bulbs

Removing and installing the cover in the front wheel housing

You must remove the cover from the front wheel housing before you can change the front bulbs.



- ▶ **To remove:** switch off the lights.
- ▶ Turn the front wheels inwards.
- ▶ Remove securing pin ② using a suitable tool.
- ▶ Slide cover ① up and remove it.
- ▶ **To install:** insert cover ① again and slide it down until it engages.
- ▶ Insert securing pin ②.

Low-beam headlamps (halogen headlamps)

⚠ WARNING

These bulbs are pressurized.

They can explode when being changed if:

- they are still hot
- they hit an object when being removed
- they are dropped

There is a risk of injury.

You should wear eye protection and clean gloves when you are changing a bulb. If necessary, have bulbs changed at a qualified specialist workshop.

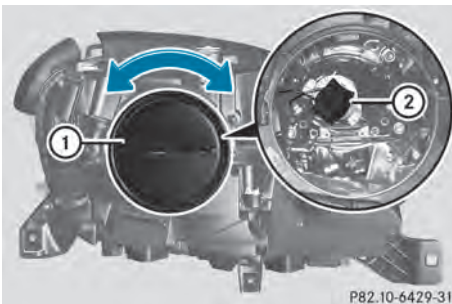

- ▶ Remove the cover in the front wheel housing (▷ page 129).
- ▶ Turn housing cover ① counter-clockwise and pull it out.
- ▶ Turn bulb holder ② counter-clockwise and pull it out.
- ▶ Take the bulb out of bulb holder ②.
- ▶ Insert the new bulb into bulb holder ②.
- ▶ Insert bulb holder ② into the lamp and turn it clockwise.
- ▶ Align housing cover ① and turn it clockwise until it engages.
- ▶ Replace the cover in the front wheel housing (▷ page 129).

High-beam headlamps (halogen headlamps)

⚠ WARNING

These bulbs are pressurized.

They can explode when being changed if:

- they are still hot
- they hit an object when being removed
- they are dropped

There is a risk of injury.

You should wear eye protection and clean gloves when you are changing a bulb. If necessary, have bulbs changed at a qualified specialist workshop.

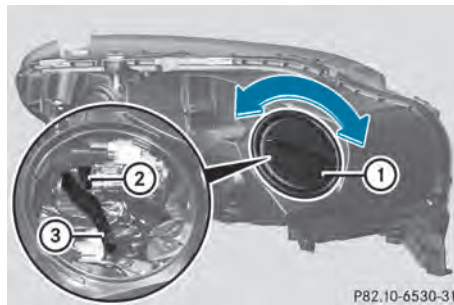

- ▶ Switch off the lights.
- ▶ Open the hood.

- ▶ Turn housing cover ① counter-clockwise and pull it out.
- ▶ Pull lever ③ upwards and remove bulb holder ②.
- ▶ Take the bulb out of bulb holder ②.
- ▶ Insert the new bulb into bulb holder ②.
- ▶ Simultaneously press bulb holder ② and pull lever ③ downwards.
- ▶ Align housing cover ① and turn it clockwise until it engages.

Parking lamps/standing lamps (halogen headlamps)

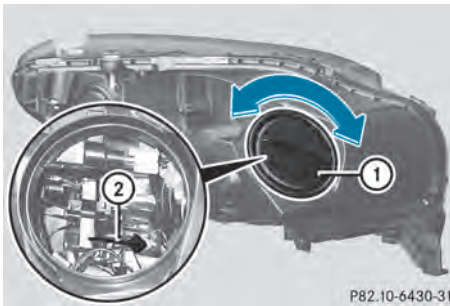

- ▶ Switch off the lights.
- ▶ Open the hood.
- ▶ Turn housing cover ① counter-clockwise and pull it out.
- ▶ Pull out bulb holder ②.
- ▶ Take the bulb out of bulb holder ②.
- ▶ Insert the new bulb into bulb holder ②.
- ▶ Insert bulb holder ②.
- ▶ Align housing cover ① and turn it clockwise until it engages.

Side marker lamps

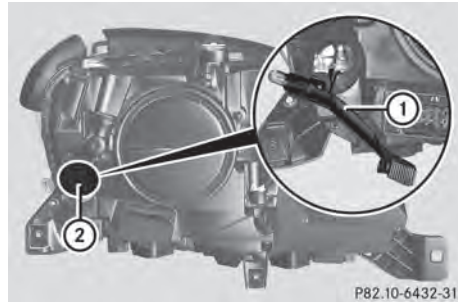

- ▶ Remove the cover in the front wheel housing (▷ page 129).
- ▶ Turn cap ② counter-clockwise and remove it.
- ▶ Pull out bulb holder ①.
- ▶ Take the bulb out of bulb holder ①.
- ▶ Insert the new bulb into bulb holder ①.
- ▶ Insert bulb holder ①.
- ▶ Align cap ② and turn it clockwise until it engages.
- ▶ Replace the cover in the front wheel housing (▷ page 129).

Changing the rear bulbs

Opening and closing the service flap

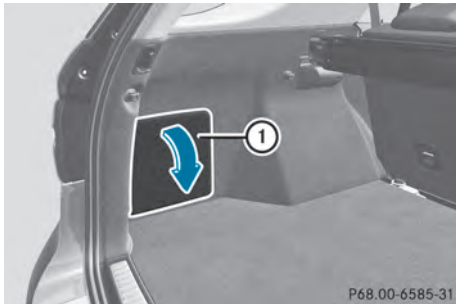

Left-hand service flap

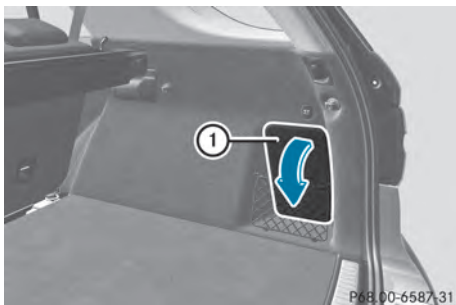

Right-hand service flap

You must open the service flap in the cargo compartment before you can change the bulbs in the brake lamp.

- ▶ **To open:** release service flap ① at the top, e.g. with a screwdriver, and swing it downward in the direction of the arrow.
- ▶ Right side: remove the first-aid kit beforehand and pull the parcel net down.
- ▶ **To close:** reinsert service flap ①.

Brake lamp



- ▶ Switch off the lights.
- ▶ Open the cargo compartment.
- ▶ Open the service flap (> page 132).
- ▶ Turn bulb holder ① counter-clockwise and remove it.
- ▶ Take bulb out of bulb holder ①.
- ▶ Insert the new bulb into bulb holder ①.
- ▶ Insert bulb holder ① into the lamp and turn it clockwise.
- ▶ Close the service flap (> page 132).

Windshield wipers

Switching the windshield wipers on/off

- ⚠ Do not operate the windshield wipers when the windshield is dry, as this could damage the wiper blades. Moreover, dust that has collected on the windshield can scratch the glass if wiping takes place when the windshield is dry.

If it is necessary to switch on the windshield wipers in dry weather conditions, always use washer fluid when operating the windshield wipers.

- ⚠ If the windshield wipers leave smears on the windshield after the vehicle has been washed in an automatic car wash, wax or other residues may be the reason for this. Clean the windshield using washer fluid after washing the vehicle in an automatic car wash.

! Intermittent wiping with rain sensor: due to optical influences and the windshield becoming dirty in dry weather conditions, the windshield wipers may be activated inadvertently. This could then damage the windshield wiper blades or scratch the windshield.

For this reason, you should always switch off the windshield wipers in dry weather.

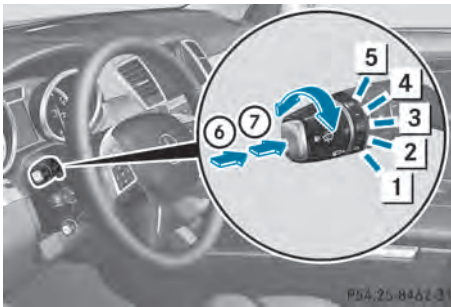

Combination switch

- 1 Windshield wiper off
- 2 Intermittent wipe, low (rain sensor set to low sensitivity)
- 3 Intermittent wipe, high (rain sensor set to high sensitivity)
- 4 Continuous wipe, slow
- 5 Continuous wipe, fast
- 6 Single wipe
- 7 To wipe with washer fluid

- ▶ Switch on the ignition.
- ▶ Turn the combination switch to the corresponding position.

In the or position, the appropriate wiping frequency is set automatically according to the intensity of the rain. In the position, the rain sensor is more sensitive than in the position, causing the windshield wipers to wipe more frequently.

If the wiper blades are worn, the windshield will no longer be wiped properly. This could prevent you from observing the traffic conditions, thereby causing an accident.

Replace the wiper blades twice a year, ideally in spring and fall.

Switching the rear window wiper on/off

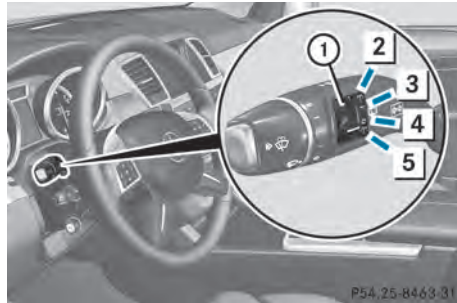

Combination switch

- 1 Rear window wiper switch
- 2 To wipe with washer fluid
- 3 To switch on intermittent wiping
- 4 To switch off intermittent wiping
- 5 To wipe with washer fluid

- ▶ Turn the SmartKey to position 1 or 2 in the ignition lock (▷ page 157).
- ▶ Turn switch ① on the combination switch to the corresponding position. When the rear window wiper is switched on, the icon appears in the instrument cluster.

Replacing the wiper blades

Important safety notes

WARNING

If the windshield wipers begin to move while you are changing the wiper blades, you could be trapped by the wiper arm. There is a risk of injury.

Always switch off the windshield wipers and ignition before changing the wiper blades.

- !** Never open the hood/tailgate if a wiper arm has been folded away from the windshield/rear window.

Never fold a windshield wiper arm without a wiper blade back onto the windshield/rear window.

Hold the windshield wiper arm firmly when you change the wiper blade. If you release the wiper arm without a wiper blade and it falls onto the windshield/rear window, the windshield/rear window may be damaged by the force of the impact.

Mercedes-Benz recommends that you have the wiper blades changed at a qualified specialist workshop.

- ! To avoid damaging the wiper blades, make sure that you touch only the wiper arm of the wiper.

Changing the windshield wiper blades

Removing the wiper blades

- ▶ Remove the SmartKey from the ignition lock.
- ▶ Fold the wiper arm away from the windshield.

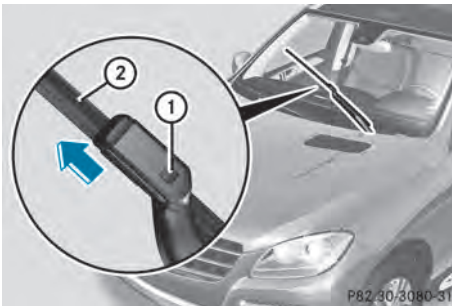

- ▶ Firmly press release knob ① and pull wiper blade ② upwards from the wiper arm in the direction of the arrow.

Installing the wiper blades

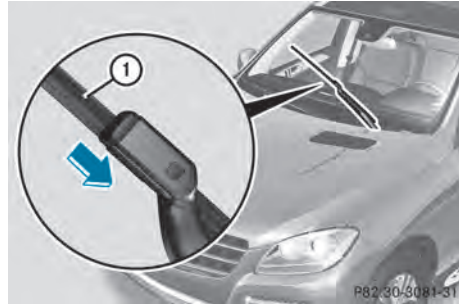

- ▶ Position new wiper blade ① in the retainer on the wiper arm and slide it into place in the direction of the arrow. The wiper blade audibly engages.
- ▶ Make sure that wiper blade is seated correctly.
- ▶ Fold the wiper arm back onto the windshield.

Replacing the rear window wiper blade

Removing the wiper blades

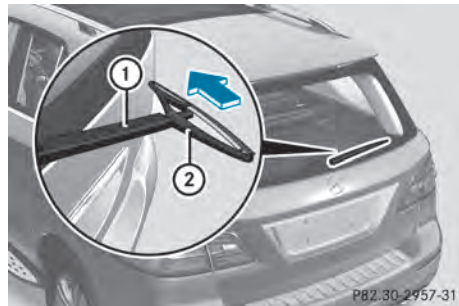

- ▶ Remove the SmartKey from the ignition lock.
- ▶ Fold wiper arm ① away from the rear window until it engages.
- ▶ Position wiper blade ② at a right angle to wiper arm ①.
- ▶ Hold wiper arm ① and press wiper blade ② in the direction of the arrow until it releases.
- ▶ Remove wiper blade ②.

Installing the wiper blade

- ▶ Place new wiper blade ② onto wiper arm ①.
- ▶ Hold wiper arm ① and press wiper blade ② in the opposite direction to the arrow until it engages.
- ▶ Make sure that wiper blade ② is seated correctly.
- ▶ Position wiper blade ② parallel to wiper arm ①.
- ▶ Fold wiper arm ① back onto the rear window.

Problems with the windshield wipers

| Problem | Possible causes/consequences and ► Solutions |
|--|---|
| The windshield wipers are jammed. | <p>Leaves or snow, for example, may be obstructing the windshield wiper movement. The wiper motor has been deactivated.</p> <ul style="list-style-type: none"> ► For safety reasons, you should remove the SmartKey from the ignition lock. <p>or</p> <ul style="list-style-type: none"> ► Switch off the engine using the Start/Stop button and open the driver's door. ► Remove the cause of the obstruction. ► Switch the windshield wipers back on. |
| The windshield wipers fail completely. | <p>The windshield wiper drive is malfunctioning.</p> <ul style="list-style-type: none"> ► Select another wiper speed on the combination switch. ► Have the windshield wipers checked at a qualified specialist workshop. |

| | |
|---|-----|
| Useful information | 138 |
| Overview of climate control systems | 138 |
| Operating the climate control systems | 144 |
| Setting the air vents | 151 |

Useful information

- i** This Operator's Manual describes all models and all standard and optional equipment of your vehicle available at the time of publication of the Operator's Manual. Country-specific differences are possible. Please note that your vehicle may not be equipped with all features described. This also applies to safety-related systems and functions.
- i** Read the information on qualified specialist workshops: (> page 27).

- i** The integrated filter can filter out most particles of dust, and completely filters out pollen. A clogged filter reduces the amount of air supplied to the vehicle interior. For this reason, you should always observe the interval for replacing the filter, which is specified in the Maintenance Booklet. As it depends on environmental conditions, e.g. heavy air pollution, the interval may be shorter than stated in the Maintenance Booklet.
- i** It is possible that the dehumidification function of the climate control system may be activated automatically an hour after the SmartKey has been removed. The vehicle is ventilated for 30 minutes.

Overview of climate control systems

Important safety notes

Observe the settings recommended on the following pages. The windows could otherwise fog up.

To prevent the windows from fogging up:

- switch off climate control only briefly
- switch on air-recirculation mode only briefly
- switch on the cooling with air dehumidification function
- switch on the defrost windshield function briefly, if required

Climate control regulates the temperature and the humidity in the vehicle interior and filters undesirable substances out of the air.

Climate control is only operational when the engine is running. The system only works optimally when the side windows and the roof are closed.

The residual heat function can only be activated or deactivated with the ignition switched off (> page 150).

- i** Ventilate the vehicle for a brief period during warm weather, e.g. using the convenience opening feature (> page 93). This will speed up the cooling process and the desired vehicle interior temperature will be reached more quickly.

Control panel for dual-zone automatic climate control

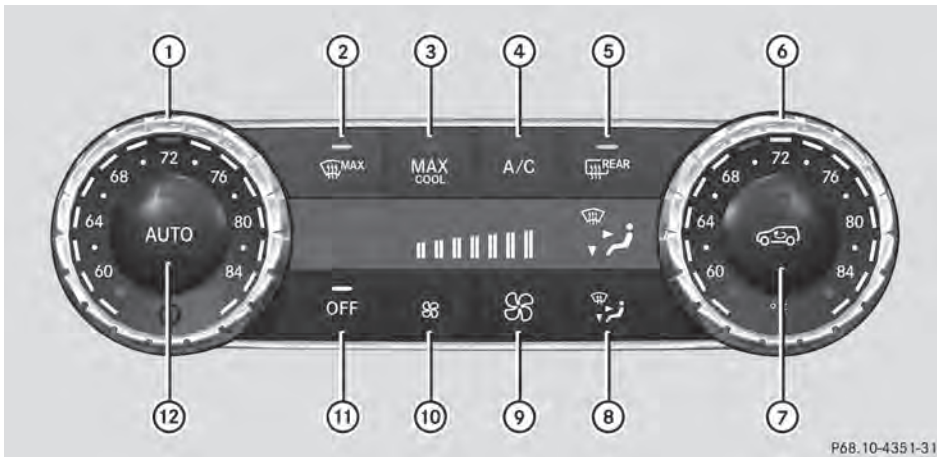

USA only

Front control panel

- ① To set the temperature, left (▷ page 146)
- ② To defrost the windshield (▷ page 148)
- ③ To switch maximum cooling on/off (▷ page 148)
- ④ To switch cooling with air dehumidification on/off (▷ page 145)
- ⑤ To switch the rear window defroster on/off (▷ page 149)
- ⑥ To set the temperature, right (▷ page 146)
- ⑦ To activate/deactivate air-recirculation mode (▷ page 150)
- ⑧ To set the air distribution (▷ page 147)
- ⑨ To increase the airflow (▷ page 147)
- ⑩ To reduce the airflow (▷ page 147)
- ⑪ To switch climate control on/off (▷ page 144)
- ⑫ To set climate control to automatic (▷ page 145)

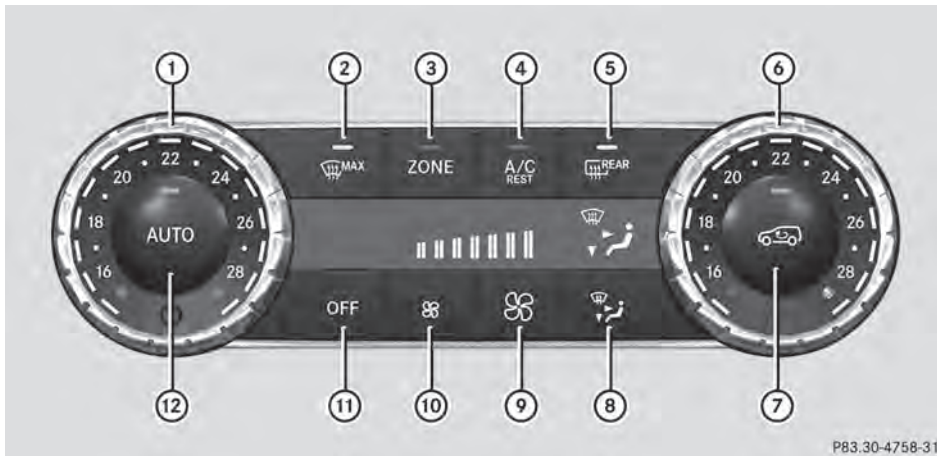

P83.30-4758-31

Climate control

Canada only

Front control panel

- ① To set the temperature, left (▷ page 146)
- ② To defrost the windshield (▷ page 148)
- ③ To switch the ZONE function on/off (▷ page 148)
- ④ To activate/deactivate cooling with air dehumidification (▷ page 145) or activates/deactivates the residual heating function (▷ page 150)
- ⑤ To switch the rear window defroster on/off (▷ page 149)
- ⑥ To set the temperature, right (▷ page 146)
- ⑦ To activate/deactivate air-recirculation mode (▷ page 150)
- ⑧ To set the air distribution (▷ page 147)
- ⑨ To increase the airflow (▷ page 147)
- ⑩ To reduce the airflow (▷ page 147)
- ⑪ To switch climate control on/off (▷ page 144)
- ⑫ To set climate control to automatic (▷ page 145)



P83.50-2187-31

Rear control panel

- ① To set rear-compartment climate control to automatic
- ② To switch rear-compartment climate control on/off

- ③ To direct the airflow through the rear air vents
- ④ To direct the airflow through the footwell vents

Information about using dual-zone automatic climate control

The following contains notes and recommendations on optimum use of dual-zone automatic climate control.

- Activate climate control using the **AUTO** and **A/C**/**A/C REST** buttons. The indicator lamps in the **AUTO** and **A/C**/**A/C REST** buttons light up.
 - Set the temperature to 72 °F (22 °C).
 - Only use the defrosting function briefly until the windshield is clear again.
 - Only use air-recirculation mode briefly, e.g. if there are unpleasant outside odors or when in a tunnel. The windows could otherwise fog up, since no fresh air is drawn into the vehicle in air-recirculation mode.
 - Use the ZONE function to adopt the temperature settings on the driver's side for the front-passenger side as well. The indicator lamp above the **ZONE** button goes out.
- i** During automatic engine switch-off, the ECO start/stop function only operates at a reduced capacity. If you require the full climate control output, you can switch off the ECO start/stop function by pressing the ECO button (▷ page 163).

Control panel for 3-zone automatic climate control

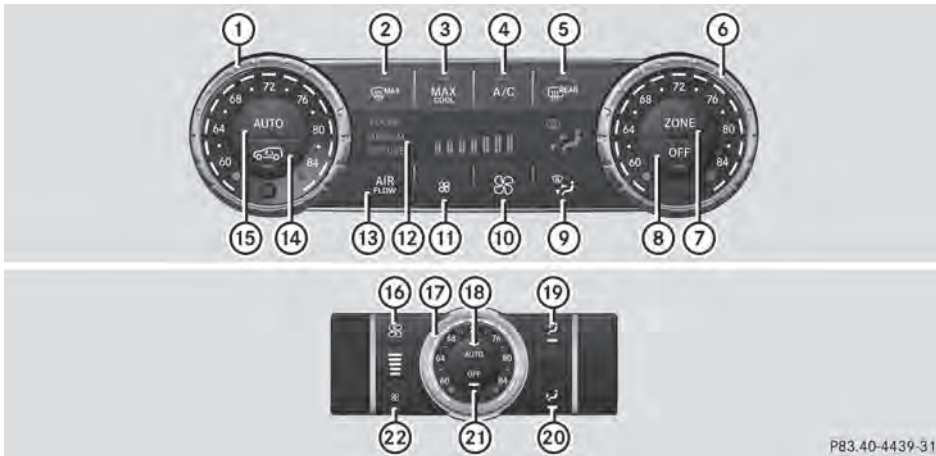

PB3.40-4439-31

USA only

Front control panel

- ① To set the temperature, left (▷ page 146)
- ② To defrost the windshield (▷ page 148)
- ③ To switch maximum cooling on/off (▷ page 148)
- ④ To switch cooling with air dehumidification on/off (▷ page 145)
- ⑤ To switch the rear window defroster on/off (▷ page 149)
- ⑥ To set the temperature, right (▷ page 146)
- ⑦ To switch the ZONE function on/off (▷ page 148)
- ⑧ To switch climate control on/off (▷ page 144)
- ⑨ To set the air distribution (▷ page 147)
- ⑩ To increase the airflow (▷ page 147)
- ⑪ To reduce the airflow (▷ page 147)
- ⑫ Display
- ⑬ To adjust the climate mode settings (▷ page 146)
- ⑭ To activate/deactivate air-recirculation mode (▷ page 150)
- ⑮ To set climate control to automatic (▷ page 145)

Rear control panel

- ⑯ To increase the airflow (▷ page 147)
- ⑰ To set the temperature (▷ page 146)
- ⑱ To set rear-compartment climate control to automatic (▷ page 145)
- ⑲ To direct the airflow through the rear air vents (▷ page 147)
- ⑳ To direct the airflow through the footwell vents (▷ page 147)

- ⑰ To switch rear-compartment climate control on/off (▷ page 144)
- ⑱ To reduce the airflow (▷ page 147)

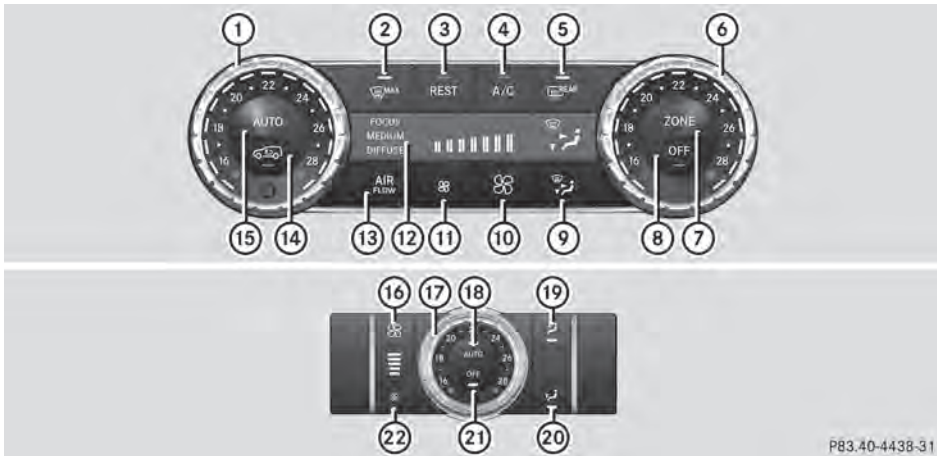

Canada only

Front control panel

- ① To set the temperature, left (▷ page 146)
- ② To defrost the windshield (▷ page 148)
- ③ To switch the ZONE function on/off (▷ page 148)
- ④ To activate/deactivate cooling with air dehumidification (▷ page 145) or activate/deactivate the residual heating function (▷ page 150)
- ⑤ To switch the rear window defroster on/off (▷ page 149)
- ⑥ To set the temperature, right (▷ page 146)
- ⑦ To switch rear-compartment climate control on/off
- ⑧ To switch climate control on/off (▷ page 144)
- ⑨ To set the air distribution (▷ page 147)
- ⑩ To increase the airflow (▷ page 147)
- ⑪ To reduce the airflow (▷ page 147)
- ⑫ Display
- ⑬ To adjust the climate mode settings (▷ page 146)
- ⑭ To activate/deactivate air-recirculation mode (▷ page 150)
- ⑮ To set climate control to automatic (▷ page 145)

Rear control panel

- ⑯ To increase the airflow (▷ page 147)
- ⑰ To set the temperature (▷ page 146)
- ⑱ To set rear-compartment climate control to automatic (▷ page 145)
- ⑲ To direct the airflow through the rear air vents (▷ page 147)

- ⑳ To direct the airflow through the footwell vents (▷ page 147)
- ㉑ To switch rear-compartment climate control on/off (▷ page 144)
- ㉒ To reduce the airflow (▷ page 147)

Information about using 3-zone automatic climate control

The following contains instructions and recommendations to enable you to get the most out of your automatic climate control.

- Activate climate control using the **AUTO** and **A/C** buttons. The indicator lamps above the **AUTO** and **A/C** buttons light up.
 - In automatic mode, you can also use the **AIR FLOW** button to set a climate mode (FOCUS/MEDIUM/DIFFUSE). The MEDIUM level is recommended.
 - Set the temperature to 72 °F (22 °C).
 - Only use the defrosting function briefly until the windshield is clear again.
 - Only use air-recirculation mode briefly, e.g. if there are unpleasant outside odors or when in a tunnel. The windows could otherwise fog up, since no fresh air is drawn into the vehicle in air-recirculation mode.
 - Use the ZONE function to adopt the temperature settings on the driver's side for the front-passenger side and the rear compartment as well. The indicator lamp above the **ZONE** button goes out.
 - Use the residual heat function if you want to heat or ventilate the vehicle interior when the ignition is switched off. The residual heat function can only be activated or deactivated with the ignition switched off.
- i** During automatic engine switch-off, the ECO start/stop function only operates at a reduced capacity. If you require the full climate control output, you can switch off the ECO start/stop function by pressing the ECO button (▷ page 163).

Operating the climate control systems

Switching climate control on/off

Points to observe before use

When the climate control is switched off, the air supply and air circulation are also switched off. Only use this setting for a brief period. The windows could otherwise fog up. Only switch off climate control briefly to prevent the windows from fogging up.

- i** Switch on climate control primarily using the **AUTO** button (▷ page 145).

In the rear compartment, you can also switch climate control on and off using the **AUTO** and **OFF** buttons.

Activating/deactivating

- ▶ Turn the SmartKey to position **2** in the ignition lock (▷ page 157).
 - ▶ **To activate:** press the **AUTO** button. The indicator lamp in the **AUTO** button lights up. Airflow and air distribution are set to automatic mode.
- or
- ▶ Press the **OFF** button. The indicator lamp in the **OFF** button goes out. The previously selected settings are restored.
 - ▶ **To deactivate:** press the **OFF** button. The indicator lamp in the **OFF** button lights up.

Activating/deactivating cooling with air dehumidification

Points to observe before use

If you switch off the cooling function, the vehicle will not be cooled when weather conditions are warm. The windows can fog up more quickly. Only deactivate the cooling with air dehumidification function for a short time to prevent the windows from fogging up.

The cooling with air dehumidification function is only available when the engine is running. The air inside the vehicle is cooled and dehumidified according to the temperature selected.

Condensation may drip from the underside of the vehicle when it is in cooling mode. This is normal and not a sign that there is a malfunction.

Activating/deactivating



Example: A/C button

▶ **To activate:** press the A/C / A/C REST button. The indicator lamp in the A/C / A/C REST button lights up.

▶ **To deactivate:** press the A/C / A/C REST button. The indicator lamp in the A/C / A/C REST button goes out. The cooling with air dehumidification function has a delayed switch-off feature.

Problems with the "cooling with air dehumidification" function

When you press the A/C button, the indicator lamp in the button flashes three times or remains off. You can no longer switch on the cooling with air dehumidification function.

▶ Visit a qualified specialist workshop.

Setting climate control to automatic

Points to observe before use

If you switch off the cooling function, the vehicle will not be cooled when weather conditions are warm. The windows can fog up more quickly. Only deactivate the cooling with air dehumidification function for a short time to prevent the windows from fogging up.



In automatic mode, the set temperature is maintained automatically at a constant level. The system automatically regulates the temperature of the dispensed air, the airflow and the air distribution.

Automatic mode will achieve optimal operation if cooling with air dehumidification is also activated. If necessary, cooling with air dehumidification can be deactivated.

In the rear compartment, you can also switch climate control for the rear seats to automatic mode using the AUTO button.

Activating/deactivating



- ▶ Turn the SmartKey to position **2** in the ignition lock (▷ page 157).
 - ▶ Set the desired temperature.
 - ▶ **To activate:** press the **AUTO** button. The indicator lamp in the **AUTO** button lights up. Automatic air distribution and airflow are activated.
 - ▶ **To select manually:** press the  button.
- or
- ▶ Press the  or  button. The indicator lamp in the **AUTO** button goes out.

3-zone automatic climate control: when automatic mode is activated, you can select a climate mode (▷ page 146).

Adjusting the climate mode settings

You can select the following climate mode settings in automatic mode:

FOCUS high airflow that is set slightly cooler

MEDIUM medium airflow, standard setting

DIFFUSE low airflow that is set slightly warmer and with less draft



- ▶ Turn the SmartKey to position **2** in the ignition lock (▷ page 157).
- ▶ Press the **AUTO** button.
- ▶ Press the **AIR FLOW** button repeatedly until the desired climate mode appears in the display.

Setting the temperature

Dual-zone automatic climate control

Different temperatures can be set for the driver's and front-passenger sides.

- ▶ Turn the SmartKey to position **2** in the ignition lock (▷ page 157).
- ▶ **To increase/reduce:** turn control ① or ⑥ clockwise or counter-clockwise (▷ page 139).

Only change the temperature setting in small increments. Start at 72 °F (22 °C).

3-zone automatic climate control

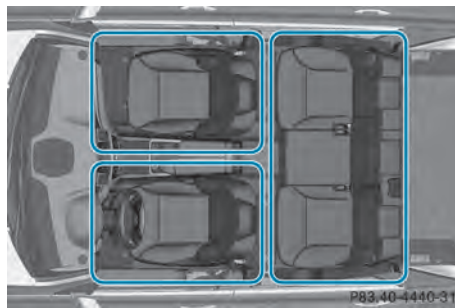

Automatic climate control zones

You can select different temperature settings for the driver's and front-passenger sides as well as for the rear compartment.

- ▶ Turn the SmartKey to position **2** in the ignition lock (▷ page 157).
- ▶ **To increase/reduce the temperature in the front:** turn control ① or ⑥ clockwise or counter-clockwise (▷ page 142). Only change the temperature setting in small increments. Start at 72 °F (22 °C).
- ▶ **To increase/reduce the temperature in the rear compartment using the front control panel:** press the **ZONE** button. The indicator lamp in the **ZONE** button goes out.
- ▶ Turn control ① clockwise or counter-clockwise (▷ page 142).

Only change the temperature setting in small increments. Start at 72 °F (22 °C). The temperature setting for the driver's side is adopted for the rear compartment and the front-passenger side.







- ▶ **To increase/decrease the rear compartment temperature using the rear control panel:** turn control ⑰ clockwise or counter-clockwise on the rear control panel (▶ page 142).

Only change the temperature setting in small increments. Start at 72 °F (22 °C).



Setting the air distribution

Air distribution settings

Front control panel

-  Directs the airflow through the center vents
-  Directs air through the footwell air vents
-  Directs the airflow through the center and footwell vents
-  Directs air through the defroster vents
-  Directs the airflow through the defroster and center vents (Canada only)
-  Directs air through the defroster and footwell vents
-  Directs the airflow through the defroster, center and footwell air vents (Canada only)

Rear control panel

-  Directs the airflow through the rear center and rear side air vents
-  Directs air through the footwell air vents

i Using the rear control panel, you can also activate both air distribution positions simultaneously. In order to do this, press both air distribution buttons. The air is then routed through all rear air vents.

i Regardless of the air distribution setting, airflow is always directed through the side air vents. The side air vents can only be closed when the controls on the side air vents are turned downwards.



Adjusting



- ▶ Turn the SmartKey to position 2 in the ignition lock (▶ page 157).
- ▶ Press the  button repeatedly until the desired symbol appears in the display.

Setting the airflow





- ▶ Turn the SmartKey to position 2 in the ignition lock (▶ page 157).
- ▶ **To increase:** press the  button.
- ▶ **To reduce:** press the  button.

i You can use 3-zone automatic climate control to set the airflow in the rear compartment separately.



Switching the ZONE function on/off



- **To activate:** press the  button. The indicator lamp above the  button lights up.

Dual-zone automatic climate control: the temperature setting for the driver's side is not adopted for the front-passenger side.

3-zone automatic climate control: the temperature setting for the driver's side is not adopted for the front-passenger side and the rear compartment.

- **To deactivate:** press the  button. The indicator lamp above the  button goes out.



Dual-zone automatic climate control: the temperature setting for the driver's side is adopted for the front-passenger side.

3-zone automatic climate control: the temperature setting for the driver's side is adopted for the front-passenger side and the rear compartment.

Defrosting the windshield



You can use this function to defrost the windshield or to defrost the inside of the windshield and the side windows.

Switch off the "defrosting" function as soon as the windshield is clear again.



- Turn the SmartKey to position **2** in the ignition lock (▷ page 157).
- **To activate:** press the  button. The indicator lamp in the  button lights up.

The climate control system switches to the following functions:

- high airflow
- high temperature
- air distribution to the windshield and front side windows
- air-recirculation mode off

- **To deactivate:** press the  button. The indicator lamp in the  button goes out. The previously selected settings are restored. Air-recirculation mode remains deactivated.

or

- Press the  button. The indicator lamp in the  button goes out. Airflow and air distribution are set to automatic mode.

or

- Turn controls ① or ⑥ clockwise or counter-clockwise:

Dual-zone automatic climate control (▷ page 139)

3-zone automatic climate control (▷ page 142)

or



- Press the  or  button.

MAX COOL maximum cooling

The MAX COOL function is only available in vehicles for the USA.



MAX COOL is only operational when the engine is running.



- ▶ **To activate:** press the  button.
The indicator lamp in the button lights up.
- ▶ **To activate:** press off-road button  again.
The indicator lamp goes out. The previously selected settings are restored.

When you activate MAX COOL, climate control switches to the following functions:



- maximum cooling
- maximum airflow
- air-recirculation mode on

Defrosting the windows

Windows fogged up on the inside

- ▶ Activate the  /  cooling with air dehumidification function.
- ▶ Activate automatic mode .
- ▶ If the windows continue to fog up, activate the defrosting function (▷ page 148).
- i** You should only select this setting until the windshield is clear again.

Windows fogged up on the outside

- ▶ Press the  button repeatedly until the  or  symbol appears in the display.
- i** You should only select this setting until the windshield is clear again.



Rear window defroster

Activating/deactivating



The rear window defroster has a high current draw. You should therefore switch it off as soon as the rear window is clear. Otherwise, the rear window defroster switches off automatically after several minutes.

If the battery voltage is too low, the rear window defroster may switch off.

- ▶ Turn the SmartKey to position **2** in the ignition lock (▷ page 157).
- ▶ Press the  button.
The indicator lamp in the  button lights up or goes out.

Problems with the rear window defroster

| Problem | Possible causes/consequences and ► Solutions |
|---|---|
| The rear window defroster has deactivated prematurely or cannot be activated. | The battery has not been sufficiently charged. ► Switch off any consumers that are not required, e.g. reading lamps or interior lighting. When the battery is sufficiently charged, the rear window defroster is activated again automatically. |



Activating/deactivating air-recirculation mode

If you switch on air-recirculation mode, the windows can fog up more quickly, in particular at low temperatures. Only use air-recirculation mode briefly to prevent the windows from fogging up.





You can deactivate the flow of fresh air if unpleasant odors are entering the vehicle from outside. The air already inside the vehicle will then be recirculated.

The operation of air-recirculation mode is the same for all control panels.

- Turn the SmartKey to position **2** in the ignition lock (► page 157).
- **To activate:** press the  button. The indicator lamp in the  button lights up.
- i** In the event of high pollution levels (3-zone automatic climate control only) or at high outside temperatures, air-recirculation mode is automatically activated. When air-recirculation mode is

activated automatically, the indicator lamp in the  button is not lit.

Outside air is added after about 30 minutes.

- **To deactivate:** press the  button. The indicator lamp in the  button goes out.

i Air-recirculation mode deactivates automatically:

- after approximately five minutes at outside temperatures below approximately 41 °F (5 °C)
- after approximately five minutes if cooling with air dehumidification is deactivated
- after approximately 30 minutes at outside temperatures above approximately 41 °F (5 °C) if the "Cooling with air dehumidification" function is activated

Activating/deactivating the residual heat function

The "residual heat" function is only available in Canada.



It is possible to make use of the residual heat of the engine to continue heating the stationary vehicle for up to 30 minutes after the engine has been switched off. The heating time depends on the temperature that has been set.

► **To activate:** press the **REST** / **A/C REST** button. The indicator lamp in the **REST** / **A/C REST** button lights up.

i The blower will run at a low speed regardless of the airflow setting.

i If you activate the residual heat function at high temperatures, only the ventilation will be activated. The blower runs at medium speed.

► **To deactivate:** press the **REST** / **A/C REST** button. The indicator lamp in the **REST** / **A/C REST** button goes out.

Residual heat is deactivated automatically:

- after approximately 30 minutes
- when the ignition is switched on
- if the battery voltage drops
- when the auxiliary heating is activated

Setting the air vents

Important safety notes

⚠ WARNING

Very hot or very cold air can flow from the air vents. This could result in burns or frostbite in

the immediate vicinity of the air vents. There is a risk of injury.

Make sure that all vehicle occupants always maintain a sufficient distance to the air outlets. If necessary, redirect the airflow to another area of the vehicle interior.

In order to ensure the direct flow of fresh air through the air vents into the vehicle interior, please observe the following notes:

- keep the air inlet grille on the hood and in the engine compartment on the front-passenger side free of blockages, such as ice, snow or leaves.
 - never cover the air vents or air intake grilles in the vehicle interior.
- i** For virtually draft-free ventilation, adjust the sliders of the air vents to the center position.

Setting the center air vents

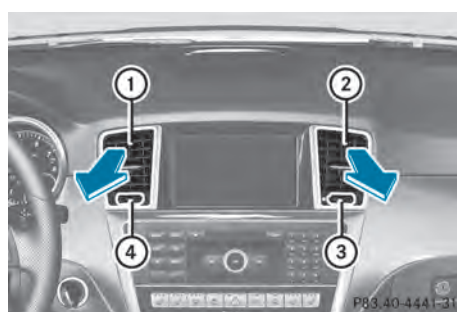

- ① Center air vent, left
- ② Center air vent, right
- ③ Center vent thumbwheel, right
- ④ Center vent thumbwheel, left

► **To open/close:** turn thumbwheels ③ and ④ to the right or left.

Setting the side air vents

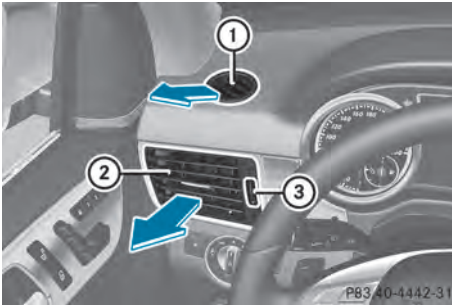

- ① Side window defroster vent
- ② Side air vent
- ③ Control for side air vent

► **To open/close:** turn thumbwheel ③ up or down.

Setting the glove box air vent

❗ Close the air vent when heating the vehicle.

At high outside temperatures, open the air vent and activate the "cooling with air dehumidification" function. Otherwise, temperature-sensitive items stored in the glove box could be damaged.

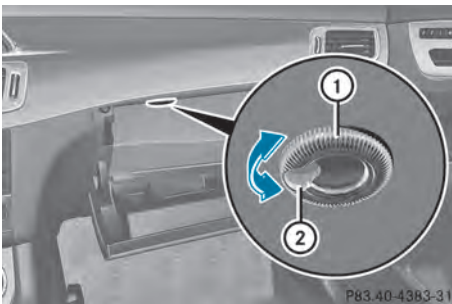

- ① Air vent thumbwheel
- ② Air vent

When automatic climate control is activated, the glove box can be ventilated, for instance to cool its contents. The level of airflow depends on the airflow and air distribution settings.

► **To open/close:** turn thumbwheel ① clockwise or counter-clockwise.

Setting the rear-compartment air vents

Setting the center vents in the rear compartment

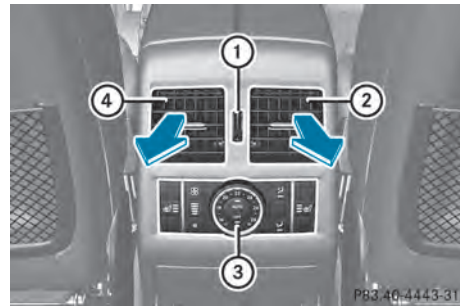

Example: center vents with rear control panel

- ① Rear-compartment air vent thumbwheel
- ② Rear-compartment air vent, right
- ③ Rear control panel
- ④ Rear-compartment air vent, left

► **To open/close:** turn thumbwheel ① up or down.

Setting the rear-compartment side air vents

2nd row of seats

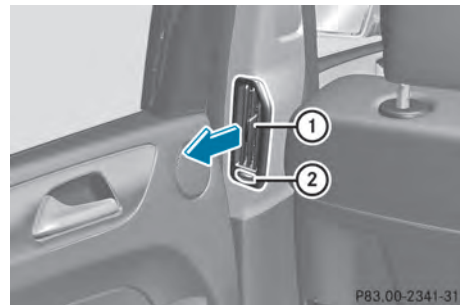

- ① B-pillar air vent
- ② Thumbwheel for B-pillar air vent

- ▶ **To open/close:** turn thumbwheel ② to the left or right.

| | |
|------------------------------------|-----|
| Useful information | 156 |
| Notes on breaking-in a new vehicle | 156 |
| Driving | 156 |
| Automatic transmission | 165 |
| Refueling | 173 |
| Parking | 179 |
| Driving tips | 182 |
| Driving systems | 192 |
| Towing a trailer | 253 |

Useful information

- i** This Operator's Manual describes all models and all standard and optional equipment of your vehicle available at the time of publication of the Operator's Manual. Country-specific differences are possible. Please note that your vehicle may not be equipped with all features described. This also applies to safety-related systems and functions.
- i** Read the information on qualified specialist workshops: (▷ page 27).

Notes on breaking-in a new vehicle

Important safety notes

New and replaced brake pads and discs only reach their optimum braking effect after several hundred kilometers of driving. Compensate for this by applying greater force to the brake pedal.

The first 1,000 miles (1,500 km)

The more you look after the engine when it is new, the more satisfied you will be with its performance in the future.

- You should therefore drive at varying vehicle and engine speeds for the first 1,000 miles (1,500 km).
- Avoid heavy loads, e.g. driving at full throttle, during this period.
- Change gear in good time, before the tachometer needle is $\frac{2}{3}$ of the way to the red area of the tachometer.
- Do not manually shift to a lower gear to brake the vehicle.
- If possible, do not depress the accelerator pedal past the point of resistance (kickdown).
- Only select shift ranges **3**, **2** or **1** when driving slowly, e.g. in mountainous terrain.

After 1,000 miles (1,500 km), you can increase the engine speed gradually and accelerate the vehicle to full speed.

Additional breaking-in notes for AMG vehicles:

- do not drive faster than 85 mph (140 km/h) for the first 1,000 miles (1,500 km).
- only allow the engine to reach a maximum engine speed of 4,500 rpm briefly.
- change gear in good time.
- ideally, drive for the first 1,000 miles (1,500km) in drive program **C**.

i You should also observe these notes on running in if the engine or parts of the drive train on your vehicle have been replaced.

i Always observe the respective speed limits.

Driving

Important safety notes

WARNING

Objects in the driver's footwell can restrict the pedal travel or obstruct a depressed pedal. The operating and road safety of the vehicle is jeopardized. There is a risk of an accident.

Make sure that all objects in the vehicle are stowed correctly, and that they cannot enter the driver's footwell. Install the floor mats securely and as specified in order to ensure sufficient clearance for the pedals. Do not use loose floor mats.

WARNING

Unsuitable footwear can hinder correct usage of the pedals, e.g.:

- shoes with thick soles
- shoes with high heels
- slippers

There is a risk of an accident.

Wear suitable footwear to ensure correct usage of the pedals.

WARNING

If you switch off the ignition while driving, safety-relevant functions are only available with limitations, or not at all. This could affect, for example, the power steering and the brake boosting effect. You will require considerably more effort to steer and brake. There is a risk of an accident.

Do not switch off the ignition while driving.

WARNING

If the parking brake has not been fully released when driving, the parking brake can:

- overheat and cause a fire
- lose its hold function.

There is a risk of fire and an accident. Release the parking brake fully before driving off.

! Warm up the engine quickly. Do not use the engine's full performance until it has reached operating temperature.

Only shift the automatic transmission to the desired drive position when the vehicle is stationary.

Where possible, avoid spinning the drive wheels when pulling away on slippery roads. You could otherwise damage the drive train.

! **AMG vehicles:** at low engine oil temperatures below 68 °F (+20 °C), the maximum engine speed is restricted in order to protect the engine. To protect the engine and maintain smooth engine operation, avoid driving at full throttle when the engine is cold.

Key positions

SmartKey

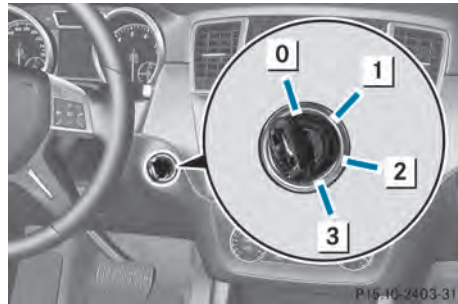

- 0** To remove the SmartKey
- 1** Power supply for some consumers, such as the windshield wipers
- 2** Ignition (power supply for all consumers) and drive position
- 3** To start the engine

As soon as the ignition is switched on, all the indicator lamps in the instrument cluster light up. If an indicator lamp does not go out after starting the engine or lights up while driving, see (▷ page 318).

If the SmartKey is in position **0** in the ignition lock for an extended period of time, it can no longer be turned in the ignition lock. The steering is then locked. To unlock, remove the SmartKey and reinsert it into the ignition lock. The steering is locked when you remove the SmartKey from the ignition lock.

- ▶ Remove the SmartKey when the engine is switched off.
The starter battery could otherwise be discharged.

If you cannot turn the SmartKey in the ignition lock, the starter battery may not be charged sufficiently.

- ▶ Check the starter battery and recharge if necessary (▷ page 387).

or

- ▶ Jump-start the vehicle (▷ page 389).

- The SmartKey can be turned in the ignition lock even if it is not the correct SmartKey for the vehicle. The ignition is not switched on. The engine cannot be started.

KEYLESS-GO

General notes

- Do not keep the KEYLESS-GO key:
 - with electronic devices, e.g. a mobile phone or another SmartKey
 - with metallic objects, e.g. coins or metal foil
 - inside metallic objects, e.g. a metal case

This can impair the functionality of the KEYLESS-GO key.

Do not keep the KEYLESS-GO key in the temperature-controlled cup holder (▷ page 344). Otherwise, the KEYLESS-GO key will not be recognized.

Vehicles with KEYLESS-GO are equipped with a SmartKey featuring an integrated KEYLESS-GO function and a detachable Start/Stop button.

The Start/Stop button must be inserted in the ignition lock and the SmartKey with the integrated KEYLESS-GO function must be in the vehicle.

Pressing the Start/Stop button several times in succession corresponds to the different key positions in the ignition lock. This is only the case if you are not depressing the brake pedal.

If you depress the brake pedal and press the Start/Stop button, the engine starts immediately.

The Start/Stop button can be removed from the ignition lock. Then, you can insert the SmartKey into the ignition lock.

- You do not have to remove the Start/Stop button from the ignition lock when you leave the vehicle. You should, however, always take the SmartKey with you when leaving the vehicle. As long as the SmartKey is in the vehicle:

- the vehicle can be started using the Start/Stop button and
- electrically powered equipment can be operated.

- The engine can be turned off while the vehicle is in motion by pressing and holding the Start/Stop button for approximately three seconds. This function operates independently of the ECO start/stop automatic engine switch-off function.

Key positions with KEYLESS-GO

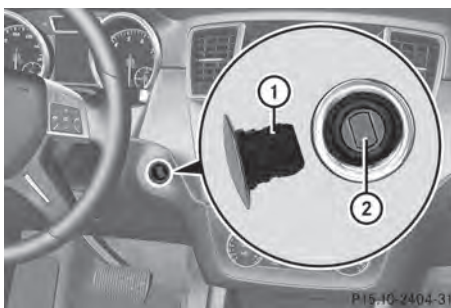

As soon as the ignition is switched on, all the indicator lamps in the instrument cluster light up. If an indicator lamp does not go out after starting the engine or lights up while driving, see (▷ page 318).

- ▶ Insert Start/Stop button ① into ignition lock ②.

- When you insert Start/Stop button ① into ignition lock ②, the system needs approximately two seconds recognition time. You can then use Start/Stop button ①.

Activating power supply

- ▶ If Start/Stop button ① has not yet been pressed, this corresponds to the SmartKey being removed from the ignition.
- ▶ Press Start/Stop button ① once. The power supply is switched on. You can now activate the windshield wipers, for example.

- i** The power supply is switched off again if:
- the driver's door is opened and
 - you press Start/Stop button ① twice when in this position.

Switching on the ignition

- ▶ Press Start/Stop button ① twice. The ignition is switched on.
- i** The power supply is switched off again if:
- the driver's door is opened and
 - you press Start/Stop button ① once when in this position.

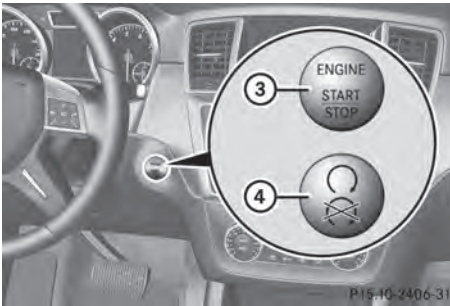

Start/Stop button

- ③ USA only
- ④ Canada only

Starting the engine

Important safety notes

⚠ WARNING

If children are left unsupervised in the vehicle, they could:

- open the doors, thus endangering other people or road users.
- get out and disrupt traffic.
- operate the vehicle's equipment.

Additionally, children could set the vehicle in motion if, for example, they:

- release the parking brake.
- shift the automatic transmission out of parking position P.
- starting the engine.

There is a risk of an accident and injury.

When leaving the vehicle, always take the SmartKey with you and lock the vehicle. Never leave children or animals unattended in the vehicle. Always keep the SmartKey out of reach of children.

⚠ WARNING

Combustion engines emit poisonous exhaust gases such as carbon monoxide. Inhaling these exhaust gases leads to poisoning. There is a risk of fatal injury. Therefore never leave the engine running in enclosed spaces without sufficient ventilation.

- i** **Vehicles with a gasoline engine:** the catalytic converter is preheated for up to 30 seconds after a cold start. The sound of the engine may change during this time.

Automatic transmission



- ▶ Shift the transmission to position **P** (> page 165). The transmission position display in the multifunction display shows **P** (> page 165).

- i** You can also start the engine when the transmission is in position **N**.

Starting procedure with the SmartKey

- ▶ **To start a gasoline engine:** turn the SmartKey to position **3** in the ignition lock

(▷ page 157) and release it as soon as the engine is running.

- ▶ **To start a diesel engine:** turn the SmartKey to position **2** in the ignition lock (▷ page 157). The  preglow indicator lamp in the instrument cluster lights up.
- ▶ When the  preglow indicator lamp goes out, turn the SmartKey to position **3** (▷ page 157) and release it as soon as the engine is running.

i You can start the engine without preglow if the engine is warm.

Using KEYLESS-GO to start the engine

- ▶ Depress the brake pedal and keep it depressed.
 - ▶ **To start a gasoline engine:** press the Start/Stop button (▷ page 158) once. The engine starts.
 - ▶ **To start a diesel engine:** press the Start/Stop button (▷ page 158) once. Preglow is activated and the engine starts.
- i** The Start/Stop button can be used to start the vehicle without inserting the SmartKey into the ignition lock. The Start/Stop button must be inserted in the ignition lock and the SmartKey must be in the vehicle. This mode for starting the engine operates independently of the ECO start/stop automatic engine start function.



Pulling away

Automatic transmission

WARNING

If the engine speed is above the idling speed and you engage transmission position **D** or **R**, the vehicle could pull away suddenly. There is a risk of an accident.

When engaging transmission position **D** or **R**, always firmly depress the brake pedal and do not simultaneously accelerate.

- ▶ Depress the brake pedal and keep it depressed.
- ▶ Shift the transmission to position **D** or **R** (▷ page 165).
- ▶ Release the brake pedal.
- ▶ Carefully depress the accelerator pedal. The electric parking brake (▷ page 180) is automatically released. The red  (USA only) or  (Canada only) indicator lamp in the instrument cluster goes out.

i It is only possible to shift the transmission from position **P** to the desired position if you depress the brake pedal. Only then is the parking lock released. If you do not depress the brake pedal, you can move the DIRECT SELECT lever but the parking lock remains engaged.

i The vehicle locks centrally once you have pulled away. The locking knobs in the doors drop down. You can open the doors from the inside at any time.

You can also deactivate the automatic locking feature (▷ page 276).

i Upshifts take place at higher engine speeds after a cold start. This helps the catalytic converter to reach its operating temperature more quickly.

Pulling away with a trailer



P42.20-2568-31

To ensure that you do not roll backwards when pulling away on an uphill slope, engage the electric parking brake.

- ▶ Press and hold handle ①.

The electric parking brake continues to brake and prevent the vehicle from rolling backwards.

The red **PARK** (USA only) or **(P)** (Canada only) indicator lamp in the instrument cluster remains on.

- ▶ Depress the accelerator pedal.
- ▶ As soon as the vehicle/trailer combination is held by the driving force of the engine, release lever ①.

The electric parking brake is released.

The red **PARK** (USA only) or **(P)** (Canada only) indicator lamp in the instrument cluster goes out.

Hill start assist

WARNING

After a short time, hill start assist will no longer brake your vehicle and it could roll away. There is a risk of an accident and injury.

Therefore, quickly move your foot from the brake pedal to the accelerator pedal. Never leave the vehicle when it is held by hill start assist.

- ▶ Remove your foot from the brake pedal. The vehicle is then held for about a second.
- ▶ Pull away.

Hill start assist helps you when pulling away forwards or in reverse on an uphill gradient. It holds the vehicle for a short time after you have removed your foot from the brake pedal. This gives you enough time to move your foot from the brake pedal to the accelerator pedal and to depress it before the vehicle begins to roll.

Hill start assist will not function if:

- you are pulling away on a level road or on a downhill gradient.
- the transmission is in position **N**.

- the electric parking brake is applied.
- ESP® is malfunctioning.

ECO start/stop function

Important safety notes

WARNING

If the engine is switched off automatically and you exit the vehicle, the engine is restarted automatically. The vehicle may begin moving. There is a risk of accident and injury.

If you wish to exit the vehicle, always turn off the ignition and secure the vehicle against rolling away.

General notes



① ECO start/stop display

If the **ECO** symbol is shown in green in the multifunction display, the ECO start/stop function switches the engine off automatically if the vehicle stops moving.

The engine starts automatically when the driver wants to pull away again. The ECO start/stop function thereby helps you to reduce the fuel consumption and emissions of your vehicle.

Every time you switch on the engine using the SmartKey or the Start/Stop button, the ECO start/stop function is activated.

If the ECO start/stop function has been manually deactivated (▶ page 163) or a malfunction has caused the system to be deactivated, the **ECO** symbol is not displayed.

AMG vehicles: the **Stop/Start active** or **Stop/Start inactive** message in the AMG menu in the multifunction display goes out.

AMG vehicles: the ECO start/stop function is only available in drive program **C**.

For further information on automatic engine switch-off (▷ page 162) and automatic engine start (▷ page 162).

Automatic engine switch-off

If the vehicle is braked to a standstill in **D** or **N**, the ECO start/stop function switches off the engine automatically.

The ECO start/stop function is operational and the **ECO** symbol is displayed in green in the multifunction display, if:

- the indicator lamp in the ECO button is lit green.
- no off-road program has been selected.
- the outside temperature is within the comfort range.
- the engine is at normal operating temperature.
- the set temperature for the vehicle interior has been reached.
- the battery is sufficiently charged.
- the system detects that the windshield is not fogged up when the air-conditioning system is switched on.
- the hood is closed.
- the driver's door is closed and the driver's seat belt is fastened.

If conditions for automatic engine switch-off have not been fulfilled, the **ECO** symbol will be shown in yellow.

AMG vehicles: the AMG menu in the multifunction display additionally shows the **Stop/Start inactive** message.

- ❗ All of the vehicle's systems remain active when the engine has been stopped automatically.
- ❗ The HOLD function can be activated if the engine has been switched off automatically. It is then not necessary to continue applying the brakes during the automatic stop phase. When you depress

the accelerator pedal, the engine starts automatically and the braking effect of the HOLD function is deactivated.

- ❗ **All vehicles (apart from AMG vehicles):** automatic engine switch-off can take place a maximum of four times consecutively (initial stop then repeated three times). The **ECO** symbol is shown in yellow in the multifunction display after the engine has been started automatically for the fourth time. When the **ECO** symbol is shown in green in the multifunction display, automatic engine switch-off is again possible.

- ❗ **AMG vehicles:** times which the engine can be automatically switched off.

Automatic engine start

The engine starts automatically if:

- you switch off the ECO start/stop function by pressing the ECO button.
- in transmission position **D** or **N** the brake pedal is released and the HOLD function is not active.
- you depress the accelerator pedal.
- you engage reverse gear **R**.
- you move the transmission out of position **P**.
- you switch to drive program **S** or **M** (AMG vehicles).
- you switch to an off-road program (except for AMG vehicles).
- you unfasten your seat belt or open the driver's door.
- the vehicle starts to roll.
- the brake system requires this.
- the temperature in the vehicle interior deviates from the set range.
- the system detects moisture on the windshield when the air-conditioning system is switched on.
- the charge level of the battery is too low.

- i** Shifting the transmission to position **P** does not start the engine.
- i** If you shift the transmission from **R** to **D**, the ECO start/stop function is available again once the **ECO** symbol reappears in green in the multifunction display.

Deactivating/activating the ECO start/stop function



ECO button

Deactivating (except for AMG vehicles)

- ▶ Press button ①.
Indicator lamp ② on button ① and the **ECO** symbol in the multifunction display go out.

Activating (except for AMG vehicles)

- ▶ Press button ①.
Indicator lamp ② on button ① lights up. If all conditions for automatic engine switch-off (> page 162) are fulfilled, the **ECO** symbol is shown in green in the multifunction display.
If not all conditions for automatic engine switch-off are fulfilled, the (> page 162) **ECO** symbol is shown in yellow in the multifunction display. If this is the case, the ECO start/stop function is not available.

Deactivating (AMG vehicles)

- ▶ Press button ① in drive program **C**.
or
- ▶ Switch to drive program **S** or **M** (> page 169).
Indicator lamp ② on button ① and the **ECO** symbol in the multifunction display go out.
The **Stop/Start active** or **Stop/Start inactive** message in the AMG menu in the multifunction display goes out.

Activating (AMG vehicles)

- ▶ Press button ①.
Indicator lamp ② on button ① lights up.
If drive program **S** or **M** is active, the automatic transmission switches to drive program **C**.
If all conditions for automatic engine switch-off (> page 162) are fulfilled, the **ECO** symbol is shown in green in the multifunction display. In addition, the **Stop/Start active** message is shown in the AMG menu in the multifunction display.
If conditions for automatic engine switch-off (> page 162) have not been fulfilled, the **ECO** symbol will be shown in yellow. If this is the case, the ECO start/stop function is not available. In addition, the **Stop/Start inactive** message is shown in the AMG menu in the multifunction display.

- i** If indicator lamp ② on button ① is off, the ECO start/stop function has been deactivated manually or as the result of a malfunction. The engine will then not be switched off automatically when the vehicle stops.

Problems with the engine

| Problem | Possible causes/consequences and ► Solutions |
|--|---|
| The engine does not start. The starter motor can be heard. | <ul style="list-style-type: none"> • There is a malfunction in the engine electronics. • There is a malfunction in the fuel supply. <p>► Try to start the engine again (> page 159). Avoid excessively long and frequent attempts to start the engine as these will drain the battery.</p> <p>If the engine does not start after several attempts:</p> <p>► Consult a qualified specialist workshop.</p> |
| The engine does not start. You cannot hear the starter motor. | <p>The on-board voltage is too low because the battery is too weak or discharged.</p> <p>► Jump-start the vehicle (> page 389).</p> <p>If the engine does not start despite attempts to jump-start it:</p> <p>► Consult a qualified specialist workshop.</p> <p>The starter motor was exposed to a thermal load that was too high.</p> <p>► Allow the starter motor to cool down for approximately two minutes.</p> <p>► Try to start the engine again.</p> <p>If the engine still does not start:</p> <p>► Consult a qualified specialist workshop.</p> |
| The engine is not running smoothly and is misfiring. | <p>There is a malfunction in the engine electronics or in a mechanical component of the engine management system.</p> <p>► Only depress the accelerator pedal slightly.</p> <p>► Have the cause rectified immediately at a qualified specialist workshop.</p> <p>Otherwise, non-combusted fuel may get into the catalytic converter and damage it.</p> |
| The coolant temperature gauge shows a value above 248 °F (120 °C). | <p>The coolant level is too low. The coolant is too hot and the engine is no longer being cooled sufficiently.</p> <p>► Stop as soon as possible and allow the engine and the coolant to cool down.</p> <p>► Check the coolant level (> page 367). Observe the warning notes as you do so and add coolant if necessary.</p> |

Automatic transmission

Important safety notes

WARNING

If the engine speed is above the idling speed and you engage transmission position **D** or **R**, the vehicle could pull away suddenly. There is a risk of an accident.

When engaging transmission position **D** or **R**, always firmly depress the brake pedal and do not simultaneously accelerate.

WARNING

The automatic transmission switches to neutral position **N** when you switch off the engine. The vehicle may roll away. There is a risk of an accident.

After switching off the engine, always switch to parking position **P**. Prevent the parked vehicle from rolling away by applying the parking brake.

DIRECT SELECT lever

Overview of transmission positions



P Park position with parking lock

R Reverse gear

N Neutral

D Drive

The DIRECT SELECT lever is on the right of the steering column.

-  The DIRECT SELECT lever always returns to its original position. The current

transmission position **P**, **R**, **N** or **D** appears in the transmission position display (▷ page 165) in the multifunction display.

Transmission position and drive program display

-  If the transmission position display in the multifunction display is not working, you should pull away carefully to check whether the desired transmission position is engaged. Ideally, you should select transmission position **D** and drive program **C** or **S**. Do not restrict the shift range.



Transmission position and drive program display

- ① Transmission position display
- ② Drive program display

The current transmission position and drive program appear in the multifunction display.

-  The arrows in the transmission position display show how and into which transmission positions you can change using the DIRECT SELECT lever.

Engaging park position P

-  If the engine speed is too high or the vehicle is moving, do not shift the automatic transmission directly from **D** to **R**, from **R** to **D** or directly to **P**. The automatic transmission could otherwise be damaged.



- P Park position with parking lock
- R Reverse gear
- N Neutral
- D Drive

- ▶ Push the DIRECT SELECT lever in the direction of arrow **P**.

- i** The automatic transmission shifts into park position **P** automatically:
 - if you open the driver's door while the vehicle is stationary in transmission position **D** or **R**
 - if you open the door while traveling at very low speeds in transmission position **D** or **R**

Engaging park position **P** automatically

Park position **P** is automatically engaged if:

- you switch off the engine using the SmartKey and remove the SmartKey
- you switch off the engine using the Start/Stop button and open one of the front doors
- the HOLD (▷ page 207) or DISTRONIC PLUS (▷ page 194) function brake your vehicle until it is stationary and at least one of the following conditions is fulfilled:
 - there is a system malfunction.
 - the vehicle is on a steep uphill or downhill gradient. The electric parking brake is then also applied.

Engaging reverse gear **R**

- !** Only shift the automatic transmission to **R** when the vehicle is stationary.
- ▶ When the vehicle is stationary, depress the brake pedal.
- ▶ Push the DIRECT SELECT lever up past the first point of resistance.

Shifting to neutral **N**

⚠ WARNING

If children are left unsupervised in the vehicle, they could:

- open the doors, thus endangering other people or road users.
- get out and disrupt traffic.
- operate the vehicle's equipment.

Additionally, children could set the vehicle in motion if, for example, they:

- release the parking brake.
- shift the automatic transmission out of parking position **P**.
- starting the engine.

There is a risk of an accident and injury.

When leaving the vehicle, always take the SmartKey with you and lock the vehicle. Never leave children or animals unattended in the vehicle. Always keep the SmartKey out of reach of children.

- ▶ When the vehicle is stationary, depress the brake pedal.
- ▶ Push the DIRECT SELECT lever up or down to the first point of resistance.

If the engine has been switched off, the automatic transmission automatically shifts to **N**.

If you want the automatic transmission to remain in neutral **N**, e.g. when having the vehicle cleaned in an automatic car wash with a towing system, observe the following notes:

Using the SmartKey:

- Make sure that the ignition is switched on.
- When the vehicle is stationary, depress the brake pedal and keep it depressed.
- Shift to neutral **N**.
- Release the brake pedal.
- If the electric parking brake is engaged, release it.
- Switch off the ignition and leave the SmartKey in the ignition lock.

Using KEYLESS-GO:

- Make sure that the ignition is switched on.
- When the vehicle is stationary, depress the brake pedal and keep it depressed.
- Engage park position **P**.
- Release the brake pedal.
- Remove the Start/Stop button from the ignition lock.
- Insert the SmartKey into the ignition lock.
- Switch on the ignition.
- Depress the brake pedal and keep it depressed.
- Shift to neutral **N**.
- Release the brake pedal.
- If the electric parking brake is engaged, release it.
- Switch off the ignition and leave the SmartKey in the ignition lock.

Engaging drive position D

- ▶ When the vehicle is stationary, depress the brake pedal.
- ▶ Push the DIRECT SELECT lever down past the first point of resistance.

Transmission positions**P****Park position**

Do not shift the transmission into position **P** (▷ page 179) unless the vehicle is stationary. The parking lock should not be used as a brake when parking. Always apply the electronic parking brake in addition to the parking lock in order to secure the vehicle.

If the vehicle electronics are malfunctioning, the transmission may be locked in position **P**. Have the vehicle electronics checked immediately at a qualified specialist workshop.

The automatic transmission shifts to **P** automatically if you:

- remove the SmartKey
- switch off the engine when in **R** or **D** and open one of the front doors

R**Reverse gear**

Only shift the transmission to **R** when the vehicle is stationary.

N**Neutral**

Do not shift the transmission to **N** while driving. Otherwise, the automatic transmission could be damaged.

No power is transmitted from the engine to the drive wheels.

Releasing the brakes will allow you to move the vehicle freely, e.g. to push it or tow it.

If ESP® is deactivated or faulty: only shift the transmission to position **N** if the vehicle is in danger of skidding, e.g. on icy roads.

If you switch off the engine using the SmartKey or the Start/Stop button, the automatic transmission shifts to neutral **N** automatically.

! Rolling in neutral **N** can damage the drive train.

D**Drive**

The automatic transmission changes gear automatically. All forward gears are available.

Changing gear

The automatic transmission shifts to the individual gears automatically when it is in transmission position **D**. This automatic gearshifting behavior is determined by:

- a possible limitation of the shift range
- the position of the accelerator pedal
- the road speed

Driving tips**Kickdown**

Use kickdown for maximum acceleration:

- ▶ Depress the accelerator pedal beyond the pressure point.
The transmission shifts to a lower gear depending on the engine speed.
- ▶ Ease off the accelerator pedal once the desired speed is reached.
The automatic transmission shifts back up.

Rocking the vehicle free

Shifting the transmission repeatedly between gears **D** and **R** may help to free the vehicle if it has become stuck in slush or snow. The vehicle's engine management restricts repeated shifting between gears up to a maximum speed of 5 mph (9 km/h). To shift back and forth between transmission positions **D** and **R**, move the selector lever up and down beyond the pressure point.

Towing a trailer

- ▶ Drive in the middle of the engine speed range on uphill gradients.
- ▶ Shift down to shift range **3** or **2** (> page 170) depending on the uphill or downhill gradient, even if cruise control or DISTRONIC PLUS is activated.

Program selector button

General notes



P54.25-8595-31

Program selector button on vehicles with the ON&OFFROAD package

- ▶ Press program selector button ①. The letter **M** appears in the multifunction display. The manual drive program **M** is activated.

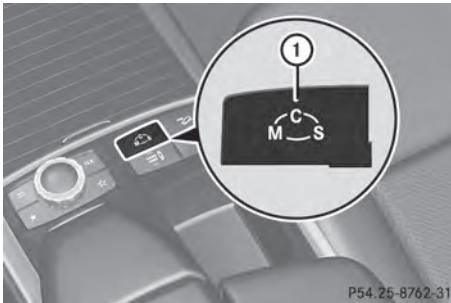

P54.25-8762-31

Program selector button on AMG vehicles

- ▶ Press program selector button ① repeatedly until the letter for the desired gearshift program appears in the multifunction display.

The program selector button allows you to choose between different driving characteristics.

- i** **AMG vehicles:** the automatic transmission switches to automatic drive program **C** each time the engine is started.

Drive programs on AMG vehicles

| | |
|--------------------------------|---------------------------------|
| C Controlled Efficiency | Comfortable, economical driving |
| S Sport | Sporty driving style |
| M Manual | Manual gear shifting |

- i** For further information on the automatic drive program, see (▷ page 169).

Steering wheel paddle shifters



P27.60-3466-31

In the manual drive program you can change gears manually using steering wheel paddle shifters ① and ② (▷ page 171).

In the automatic drive program, you can restrict or derestrict the shift range by using steering wheel paddle shifters ① and ② (▷ page 170).

- i** You can only change gear with the steering wheel paddle shifters when the transmission is in position **D**.

Automatic drive program

Drive program **E** (drive program **C** on AMG vehicles) is characterized by the following:

- comfort-oriented engine and automatic transmission settings
- optimal fuel consumption resulting from the automatic transmission shifting up sooner

- the vehicle pulling away more gently in forward and reverse gears, unless the accelerator pedal is depressed fully
- increased sensitivity. This improves driving stability on slippery road surfaces, for example
- the automatic transmission shifting up sooner. This results in the vehicle being driven at lower engine speeds and the wheels being less likely to spin

Drive program **S** is characterized by the following:

- sporty engine and transmission settings
- the automatic transmission shifting up later
- the fuel consumption possibly being higher as a result of the later automatic transmission shift points

Shift ranges

Introduction

In transmission position **D**, you can use the steering wheel paddle shifters to restrict or derestrict the shift range for the automatic transmission (▷ page 169).

The shift range selected is shown in the multifunction display. The automatic transmission shifts only as far as the selected gear.

Driving situations

- | | |
|----------|--|
| 3 | You can use the engine's braking effect. |
| 2 | The braking effect of the engine can be utilized on downhill gradients or when driving: <ul style="list-style-type: none"> • on steep mountain roads • in mountainous terrain • in arduous conditions |
| 1 | The braking effect of the engine can be utilized on extremely steep downhill gradients and long downhill stretches. |

Restricting the shift range

- ▶ Pull the left-hand steering wheel paddle shifter.
The automatic transmission shifts down one gear and restricts the shift range to the relevant gear.

- i** If the engine exceeds the maximum engine speed when shifting down, the automatic transmission protects against engine damage by not shifting down.
- i** If the maximum engine speed for the shift range is reached and you continue to accelerate, the automatic transmission shifts up, even if the shift range is restricted. This prevents the engine from overrevving.

Derestricting the shift range

- ▶ Pull the right-hand steering wheel paddle shifter.
The shift range is derestricted.

Clearing the shift range restriction

- ▶ Pull and hold the right-hand steering wheel paddle shifter until **D** is shown again in the multifunction display.

The automatic transmission shifts from the current shift range directly to **D**.

or

- ▶ Use the DIRECT SELECT lever to shift the transmission to position **D**.

The automatic transmission shifts from the current shift range directly to **D**.

Selecting the ideal shift range

- ▶ Pull the left-hand steering wheel paddle shifter and hold it in position.

The automatic transmission shifts to the gear which allows optimum acceleration and deceleration. To do this, the automatic transmission shifts down one or more gears.

Manual drive program

Switching on the manual drive program

In manual drive program **M**, you can change gear using the steering wheel paddle shifters if the transmission is in position **D**. You can see the currently selected drive program and which gear is engaged in the multifunction display.

- ▶ **AMG vehicles:** press the program selector button (▷ page 169) until **M** appears in the multifunction display.

Shifting up (all vehicles except AMG vehicles)

- ▶ Pull the right-hand steering wheel paddle shifter (▷ page 169).
The automatic transmission shifts up to the next gear.

Shifting up (AMG vehicles)

- ❗ In manual drive program **M**, the automatic transmission does not shift up automatically even when the engine limiting speed for the current gear is reached. When the engine limiting speed is reached, the fuel supply is cut to prevent the engine from overrevving. Always make sure that the engine speed does not reach the red area of the tachometer. There is otherwise a risk of engine damage.



- ① Gear indicator
- ② Upshift indicator

Before the engine speed reaches the red area, an upshift indicator will be shown in the multifunction display.

- ▶ If the color in the speedometer multifunction display changes to red and the **UP** display message is shown, shift up a gear.

Downshifting

- ▶ Pull the left-hand steering wheel paddle shifter (▷ page 169).
The automatic transmission shifts down to the next gear.

Maximum acceleration

- ▶ Pull the left-hand steering wheel paddle shifter until the transmission selects the optimum gear according to the speed.
- i If you slow down or stop without shifting down, the automatic transmission automatically shifts down.

Kickdown

You can also use kickdown for maximum acceleration in manual drive program **M**.

- ▶ Depress the accelerator pedal beyond the pressure point.
The automatic transmission shifts to a lower gear depending on the engine speed.
- ▶ Shift back up once the desired speed is reached.

i All vehicles (except AMG vehicles): if you apply full throttle, the automatic transmission shifts up to the next gear when the maximum engine speed is reached. This prevents the engine from overrevving.

i AMG vehicles: it is not possible to use kickdown in manual drive program **M**.

Switching off the manual drive program

- ▶ Press the program selector button (> page 169) repeatedly until **C** or **S** appears in the multifunction display.

Problems with the transmission

| Problem | Possible causes/consequences and ► Solutions |
|--|--|
| The transmission has problems shifting gear. | The transmission is losing oil. ► Have the transmission checked at a qualified specialist workshop immediately. |
| The acceleration ability is deteriorating. The transmission no longer changes gear. | The transmission is in emergency mode. It is only possible to shift into second gear and reverse gear. ► Stop the vehicle. ► Shift the transmission to position P . ► Switch off the engine. ► Wait at least ten seconds before restarting the engine. ► Shift the transmission to position D or R . If D is selected, the transmission shifts into second gear; if R is selected, the transmission shifts into reverse gear. ► Have the transmission checked at a qualified specialist workshop immediately. |

Transfer case

❗ Performance tests may only be carried out on a 2-axle dynamometer. The brake system or transfer case could otherwise be damaged. Contact a qualified specialist workshop for a performance test.

❗ Because ESP® is an automatic system, the engine and ignition must be switched off (SmartKey in position **0** or **1** or Start/Stop button in position **0** or **1**) when the electric parking brake is being tested on a brake dynamometer (maximum 10 seconds).

Braking triggered automatically by ESP® may seriously damage the brake system.

❗ Vehicles with 4MATIC must not be towed with either the front or the rear axle raised, as doing so will damage the transmission.

This section is only valid for vehicles with 4-wheel drive (4MATIC). Power is always transmitted to both axles.

Refueling

Important safety notes

WARNING

Fuel is highly flammable. If you handle fuel incorrectly, there is a risk of fire and explosion.

You must avoid fire, open flames, creating sparks and smoking. Switch off the engine and, if applicable, the auxiliary heating before refueling.

WARNING

Fuel is poisonous and hazardous to health. There is a risk of injury.

You must make sure that fuel does not come into contact with your skin, eyes or clothing and that it is not swallowed. Do not inhale fuel vapors. Keep fuel away from children.

If you or others come into contact with fuel, observe the following:

- Wash away fuel from skin immediately using soap and water.
- If fuel comes into contact with your eyes, immediately rinse them thoroughly with clean water. Seek medical assistance without delay.
- If fuel is swallowed, seek medical assistance without delay. Do not induce vomiting.
- Immediately change out of clothing which has come into contact with fuel.

WARNING

Electrostatic buildup can create sparks and ignite fuel vapors. There is a risk of fire and explosion.

Always touch the vehicle body before opening the fuel filler flap or touching the fuel pump nozzle. Any existing electrostatic buildup is thereby discharged.

WARNING

Vehicles with a diesel engine:

If you mix diesel fuel with gasoline, the flash point is lower than that of pure diesel fuel. When the engine is running, exhaust system components could overheat without being noticed. There is a risk of fire.

Never refuel with gasoline. Never mix gasoline with diesel fuel.

- ❗ Do not use gasoline to refuel vehicles with a diesel engine. Do not use diesel to refuel vehicles with a gasoline engine. Do not switch on the ignition if you accidentally refuel with the wrong fuel. Otherwise, the fuel will enter the fuel system. Even small amounts of the wrong fuel could result in damage to the fuel system and the engine. The repair costs are high. Notify a qualified specialist workshop and have the fuel tank and fuel lines drained completely.

- ❗ Overfilling the fuel tank could damage the fuel system.

- ❗ Take care not to spill any fuel on painted surfaces. You could otherwise damage the paintwork.

- ❗ Use a filter when refueling from a fuel can. Otherwise, the fuel lines and/or injection system could be blocked by particles from the fuel can.

Do not get into the vehicle again during the refueling process. Otherwise, electrostatic charge could build up again.

If you overfill the fuel tank, fuel could spray out when the fuel pump nozzle is removed.

- ℹ Flexible Fuel vehicles can be recognized by the **Ethanol up to E85** sticker on the inside of the fuel filler flap.

For further information on fuel and fuel quality (▷ page 445).

Refueling

Opening/closing the fuel filler flap

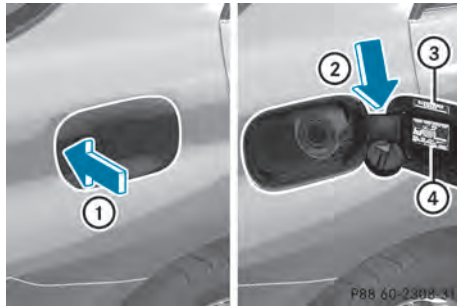

- ① To open the fuel filler flap
- ② To insert the fuel filler cap
- ③ Fuel type to be used
- ④ Tire pressure table

The fuel filler flap is unlocked or locked automatically when you open or close the vehicle with the SmartKey or with KEYLESS-GO.



The position of the fuel filler cap is displayed  in the instrument cluster. The arrow next to the filling pump indicates the side of the vehicle.

For further information on warning and indicator lamps in the instrument cluster, see (▷ page 325).

Opening

- ▶ Switch the engine off.
 - ▶ Remove the SmartKey from the ignition lock.
 - ▶ KEYLESS-GO: open the driver's door. This corresponds to key position **0**: "key removed". The driver's door can be closed again.
 - ▶ Press the fuel filler flap in the direction of arrow ①. The fuel filler flap swings up.
 - ▶ Turn the fuel filler flap counter-clockwise and remove it.
 - ▶ Insert the fuel filler cap into the holder bracket on the inside of filler flap ②.
 - ▶ Completely insert the filler neck of the fuel pump nozzle into the tank, attach and refuel.
 - ▶ Only fill the tank until the pump nozzle switches off.
- i** Do not add any more fuel after the pump stops filling for the first time. Otherwise, fuel may leak out.

Closing

- ▶ Replace the cap on the filler neck and turn clockwise until it engages audibly.
 - ▶ Close the fuel filler flap.
- i** Close the fuel filler flap before locking the vehicle.
- i** If you are driving with the fuel filler cap open, the  reserve fuel warning lamp flashes. In addition, the  Check Engine warning lamp may light up (▷ page 325). A message appears in the multifunction display (▷ page 301).

| Problems with fuel and the fuel tank | |
|--|---|
| Problem | Possible causes/consequences and ► Solutions |
| Fuel is leaking from the vehicle. | <p>The fuel line or the fuel tank is faulty.</p> <p> WARNING</p> <p>Risk of explosion or fire.</p> <ul style="list-style-type: none"> ► Turn the SmartKey to position 0 in the ignition lock and remove it immediately (▷ page 157). ► Do not restart the engine under any circumstances. ► Consult a qualified specialist workshop. |
| The engine does not start. | <p>The fuel tank of a vehicle with a diesel engine has been run completely dry.</p> <ul style="list-style-type: none"> ► Refuel the vehicle with at least 5.3 US qt (5 liters) of diesel. ► Turn the ignition on for approximately ten seconds (▷ page 157). ► Start the engine continuously for up to ten seconds until it runs smoothly. <p>If the engine does not start:</p> <ul style="list-style-type: none"> ► Turn the ignition on again for approximately ten seconds (▷ page 157). ► Start the engine again continuously for up to ten seconds until it runs smoothly. <p>If the engine does not start after three attempts:</p> <ul style="list-style-type: none"> ► Consult a qualified specialist workshop. |
| The fuel filler flap cannot be opened. | <p>The fuel filler flap is not unlocked.</p> <p>or</p> <p>The SmartKey battery is discharged.</p> <ul style="list-style-type: none"> ► Unlock the vehicle (▷ page 79). <p>or</p> <ul style="list-style-type: none"> ► Unlock the vehicle using the mechanical key (▷ page 80). |
| | <p>The fuel filler flap is unlocked, but the opening mechanism is jammed.</p> <ul style="list-style-type: none"> ► Consult a qualified specialist workshop. |

DEF (BlueTEC vehicles only)

Important notes on use

To function properly, BlueTEC exhaust gas aftertreatment must be operated with the reducing agent DEF.

When the supply of DEF is almost used up, the **Check Additive See Operator's Manual** message is shown in the multifunction display.

When the DEF supply drops to a minimum, the **Remaining Starts: 16** message is shown in the multifunction display.

If the **Remaining Starts: 16** message appears in the multifunction display, you can start the engine another 16 times. If DEF is not refilled, you will subsequently be **unable to start the engine**. Add DEF tank with approximately 1 gal (3.8 l) DEF. Have the DEF tank refilled at a qualified specialist workshop.

i If you drive the vehicle faster than 10 mph (16 km/h), the **Check Additive See Operator's Manual** message goes out after approximately one minute.

If the outside temperature is lower than 12 °F (-11) °C, damage may occur when adding DEF. If DEF is frozen and there is an active warning indicator, it may not be possible to add DEF. Park the vehicle in a warmer place, e.g. in a garage, until DEF has become fluid again. It will then be possible to add DEF again. Alternatively, have the DEF tank refilled at a qualified specialist workshop.

Further information about BlueTEC exhaust gas aftertreatment and DEF is available at any authorized Mercedes-Benz Center.

Important safety notes on the refilling procedure

DEF is a water-soluble fluid for the exhaust gas aftertreatment of diesel engines. It is:

- not poisonous
- colorless and odorless
- not flammable

When you open the DEF container, small amounts of ammonia vapor may be released.

Ammonia vapors have a pungent odor and are particularly irritating to the skin, to mucous membranes and to the eyes. You may experience a burning sensation in your eyes, nose and throat. Coughing and watering of the eyes are possible.

Do not inhale ammonia vapors. Fill the DEF tank only in well-ventilated areas.

DEF must not come into contact with your skin, eyes or clothing and must not be swallowed. Keep DEF away from children.

If you or other persons come into contact with DEF, observe the following:

- Rinse DEF from your skin immediately with soap and water.
- If DEF comes into contact with your eyes, immediately rinse them thoroughly with clean water. Seek medical assistance without delay.
- If DEF has been swallowed, rinse your mouth out immediately. Drink plenty of water. Seek medical assistance without delay.
- Change out of clothing contaminated with DEF immediately.

! Only use DEF in accordance with ISO 22241. Do not mix any additives with DEF, and do not dilute DEF with water. This may destroy the BlueTEC exhaust gas aftertreatment system.

! The vehicle must be parked on level ground to fill the DEF tank. The DEF tank can only be filled as intended with the vehicle parked on a level surface. This avoids false level readings. Filling the tank

is not permitted if the vehicle is not parked on a level surface. There is a danger of overfilling, which could result in damage to components of the BlueTEC exhaust gas aftertreatment.

❗ Rinse surfaces that have come into contact with DEF immediately with water or remove DEF using a damp cloth and cold water. If the DEF has already crystallized, use a sponge and cold water to clean it. DEF residues crystallize after time and contaminate the affected surfaces.

❗ DEF is not a fuel additive and must not be added to the fuel tank. If DEF is added to the fuel tank, this can lead to engine damage.

For further information on DEF, see (▷ page 448).

Opening the DEF filler cap

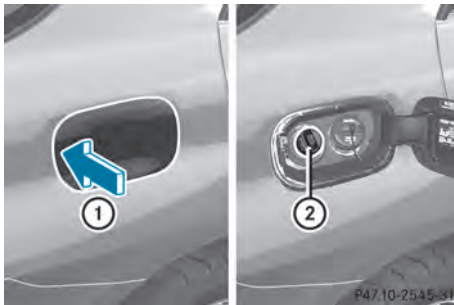

The fuel filler flap is unlocked or locked automatically when you open or close the vehicle with the SmartKey or with KEYLESS-GO.

- ▶ Switch the ignition off.
- ▶ Press the fuel filler flap in the direction of arrow ①.
The fuel filler flap swings up.
- ▶ Turn blue DEF filler cap ② counter-clockwise and remove it.
DEF filler cap ② is secured with a plastic strip.

DEF refill bottle

❗ Only screw on the DEF refill bottle hand-tight. It could otherwise be damaged.

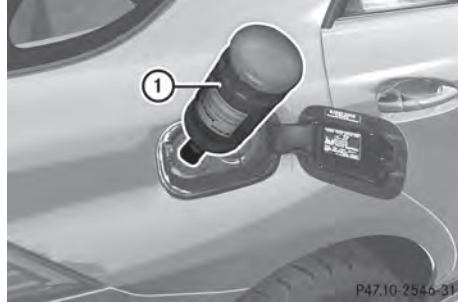

- ▶ Unscrew the protective cap from DEF refill bottle ①.
- ▶ Place DEF refill bottle ① on the filler neck as shown and screw it on clockwise until hand-tight.
- ▶ Press DEF refill bottle ① towards the filler neck.
The DEF tank is filled. This may take up to one minute.
- ❗ When DEF refill bottle ① is no longer pressed, filling stops and the bottle may be taken off again after being only partially emptied.
- ▶ Release DEF refill bottle ①.
- ▶ Turn DEF refill bottle ① counter-clockwise and remove it.
- ▶ Screw the protective cap onto DEF refill bottle ① again.

DEF refill bottles can be obtained at many gas stations or at an authorized Mercedes-Benz Center. Refill bottles without a threaded cap do not provide overfill protection. DEF may leak if overfilled. Mercedes Benz offers special refill bottles with a threaded seal. These are available at any authorized Mercedes-Benz Center.

Closing the DEF filler cap

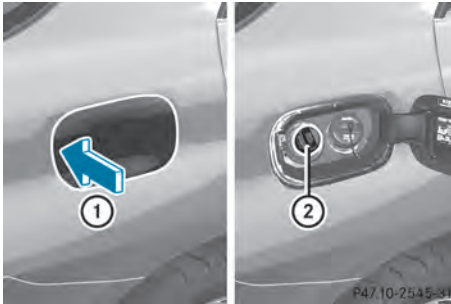

- ▶ Install DEF filler cap ② on the filler neck and turn it clockwise.
- ▶ To close the fuel filler flap, press it in the direction of arrow ①.
- ▶ Drive faster than 10 mph (16 km/h). The **Check Additive See Operator's Manual** message goes out after approximately one minute.

i If the **Check Additive See Operator's Manual** message continues to be shown in the multifunction display, you must add more DEF.

Parking

Important safety notes

⚠ WARNING

If flammable materials such as leaves, grass or twigs are exposed to prolonged contact to parts of the exhaust system that heat up, they could ignite. There is a risk of fire.

Park the vehicle so that no flammable materials come into contact with parts of the vehicle which are hot. Take particular care not to park on dry grassland or harvested grain fields.

⚠ WARNING

If you switch off the ignition while driving, safety-relevant functions are only available with limitations, or not at all. This could affect, for example, the power steering and the brake boosting effect. You will require considerably

more effort to steer and brake. There is a risk of an accident.

Do not switch off the ignition while driving.

⚠ WARNING

If you leave children unsupervised in the vehicle, they could set it in motion by, for example:

- releasing the parking brake
- shifting the automatic transmission out of the parking position **P**
- starting the engine.

They could also operate the vehicle's equipment. There is a risk of an accident and injury.

When leaving the vehicle, always take the SmartKey with you and lock the vehicle. Never leave children unsupervised in the vehicle.

! Always secure the vehicle correctly against rolling away. Otherwise, the vehicle or its drivetrain could be damaged.

To ensure that the vehicle is secured against rolling away unintentionally:

- the electric parking brake must be applied.
- the transmission must be in position **P** and the SmartKey must be removed from the ignition lock.
- on steep uphill or downhill gradients, turn the front wheels towards the curb.
- on steep uphill or downhill gradients, the front axle of an empty vehicle must be secured, for example with a wheel chock.
- on steep uphill or downhill gradients, the rear axle of a laden vehicle must be additionally secured, for example with a wheel chock.

Switching off the engine

Important safety notes

WARNING

The automatic transmission switches to neutral position **N** when you switch off the engine. The vehicle may roll away. There is a risk of an accident.

After switching off the engine, always switch to parking position **P**. Prevent the parked vehicle from rolling away by applying the parking brake.

Using the SmartKey

- ▶ Apply the electric parking brake.
- ▶ Shift the transmission to position **P**.
- ▶ Turn the SmartKey to position **0** in the ignition lock and remove it. The immobilizer is activated.

i If you turn off the engine with the SmartKey and then remove it from the ignition lock or open a front door, the automatic transmission shifts to **P** automatically.

Using KEYLESS-GO

- ▶ Apply the electric parking brake.
 - ▶ Shift the transmission to position **P**.
 - ▶ Press the Start/Stop button (▷ page 158). The engine stops and all the indicator lamps in the instrument cluster go out.
- i** If you use the Start/Stop button to switch off the engine, the automatic transmission shifts to **N** automatically. If you then open one of the front doors, the automatic transmission shifts to **P**.
- i** In the event of an emergency, the engine can be turned off while the vehicle is in motion by pressing and holding the Start/Stop button for three seconds.

Electric parking brake

General notes

WARNING

If you leave children unsupervised in the vehicle, they could set it in motion by, for example:

- releasing the parking brake
- shifting the automatic transmission out of the parking position **P**
- starting the engine.

They could also operate the vehicle's equipment. There is a risk of an accident and injury.

When leaving the vehicle, always take the SmartKey with you and lock the vehicle. Never leave children unsupervised in the vehicle.

- i** The electric parking brake performs a function test at regular intervals while the engine is switched off. The sounds that can be heard while this is occurring are normal.

Applying/releasing manually



- ▶ **To engage:** push handle ①. When the electric parking brake is engaged, the **PARK** (USA only) or **(P)** (Canada only) red indicator lamp lights up in the instrument cluster.
- i** The electric parking brake can also be applied when the SmartKey is removed.

► **To release:** pull handle ①.

The red **PARK** (USA only) or **(P)** (Canada only) indicator lamp in the instrument cluster goes out.

- ❗ The electric parking brake can only be released:
 - if the SmartKey is in position **1** in the ignition lock or
 - if the ignition was switched on using the Start/Stop button.

To ensure that you do not roll backwards when pulling away on an uphill slope, engage the electric parking brake (► page 160).

Applying automatically

The electric parking brake is applied automatically:

- if DISTRONIC PLUS brings the vehicle to a standstill or
- if the HOLD function is keeping the vehicle stationary

In addition, at least one of the following conditions must be fulfilled:

- the engine is switched off.
- the driver's door is open and the seat belt is not fastened.
- the vehicle is stationary for a lengthy period.

The red **PARK** (USA only) or **(P)** (Canada only) indicator lamp in the instrument cluster lights up.

Releasing automatically

The electric parking brake is released automatically when all of the following conditions are fulfilled:

- the engine is running.
- the transmission is in position **D** or **R**.
- the seat belt has been fastened.
- you depress the accelerator pedal.

If the transmission is in position **R**, the trunk lid must be closed.

If your seat belt is not fastened, the following conditions must be fulfilled to automatically release the electric parking brake:

- the driver's door is closed.
- you have shifted out of transmission position **P** or you have previously driven faster than 2 mph (3 km/h)

Emergency braking



► While driving, push handle ① of the electric parking brake.

The vehicle can also be braked during an emergency by using the electric parking brake.

- ❗ The vehicle is braked for as long as the handle of the electric parking brake is pressed. The longer the electric parking brake handle is depressed, the greater the braking force.

During braking:

- a warning tone sounds.
- the **Release Park. Brake** message appears
- the red **PARK** (USA only) or **(P)** (Canada only) indicator lamp in the instrument cluster flashes.

When the vehicle has been braked to a standstill, the electric parking brake is engaged.

Parking the vehicle for a long period

If you leave the vehicle parked for longer than four weeks, the battery may be damaged by exhaustive discharging.

- ▶ Connecting a trickle charger.
- ❗ You can obtain information about trickle chargers from a qualified specialist workshop.

If you leave the vehicle parked for longer than six weeks, the vehicle may suffer damage as a result of lack of use.

- ▶ Visit a qualified specialist workshop and seek advice.

Driving tips**General notes****Important safety notes****⚠ WARNING**

If you switch off the ignition while driving, safety-relevant functions are only available with limitations, or not at all. This could affect, for example, the power steering and the brake boosting effect. You will require considerably more effort to steer and brake. There is a risk of an accident.

Do not switch off the ignition while driving.

⚠ WARNING

If you operate mobile communication equipment while driving, you will be distracted from traffic conditions. You could also lose control of the vehicle. There is a risk of an accident.

Only operate this equipment when the vehicle is stationary.

Observe the legal requirements for the country in which you are driving. Some jurisdictions prohibit the driver from using a mobile phone while driving a vehicle.

If you make a call while driving, always use hands-free mode. Only operate the telephone

when the traffic situation permits. If you are unsure, pull over to a safe location and stop before operating the telephone.

Bear in mind that at a speed of only 30 mph (approximately 50 km/h), the vehicle covers a distance of 44 feet (approximately 14 m) per second.

Drive sensibly – save fuel

Observe the following tips to save fuel:

- ▶ The tires should always be inflated to the recommended tire pressure.
- ▶ Remove unnecessary loads.
- ▶ Remove roof carriers when they are not needed.
- ▶ Warm up the engine at low engine speeds.
- ▶ Avoid frequent acceleration or braking.
- ▶ Have all maintenance work carried out as indicated by the service intervals in the Maintenance Booklet or by the service interval display.

Fuel consumption also increases when driving in cold weather, in stop-start traffic and in hilly terrain.

Drinking and driving**⚠ WARNING**

Drinking and driving and/or taking drugs and driving are very dangerous combinations. Even a small amount of alcohol or drugs can affect your reflexes, perceptions and judgment.

The possibility of a serious or even fatal accident are greatly increased when you drink or take drugs and drive.

Do not drink or take drugs and drive or allow anyone to drive who has been drinking or taking drugs.

Emission control**⚠ WARNING**

Combustion engines emit poisonous exhaust gases such as carbon monoxide. Inhaling

these exhaust gases leads to poisoning. There is a risk of fatal injury. Therefore never leave the engine running in enclosed spaces without sufficient ventilation.

Certain engine systems are designed to keep the level of poisonous components in exhaust fumes within legal limits.

These systems only work at peak efficiency if they are serviced exactly in accordance with the manufacturer's specifications. For this reason, all work on the engine must be carried out by qualified and authorized Mercedes-Benz technicians.

The engine settings must not be changed under any circumstances. Furthermore, all specific service work must be carried out at regular intervals and in accordance with the Mercedes-Benz service requirements. Details can be found in the Maintenance Booklet.

Braking

Important safety notes

WARNING

If you shift down on a slippery road surface in an attempt to increase the engine's braking effect, the drive wheels could lose their grip. There is an increased danger of skidding and accidents.

Do not shift down for additional engine braking on a slippery road surface.

Downhill gradients

! On long and steep gradients, you must reduce the load on the brakes by shifting early to a lower gear. This allows you to take advantage of the engine braking effect and helps avoid overheating and excessive wear of the brakes.

When you take advantage of the engine braking effect, a drive wheel may not turn for some time, e.g. on a slippery road surface. This could cause damage to the

drive train. This type of damage is not covered by the Mercedes-Benz warranty.

Do not depress the brake pedal continuously while the vehicle is in motion, e.g. causing the brakes to rub by constantly applying light pressure to the pedal. This results in excessive and premature wear to the brake pads.

Heavy and light loads

WARNING

If you rest your foot on the brake pedal while driving, the braking system can overheat. This increases the stopping distance and can even cause the braking system to fail. There is a risk of an accident.

Never use the brake pedal as a footrest. Never depress the brake pedal and the accelerator pedal at the same time.

! Depressing the brake pedal constantly results in excessive and premature wear to the brake pads.

If the brakes have been subjected to a heavy load, do not stop the vehicle immediately. Drive on for a short while. This allows the airflow to cool the brakes more quickly.

Wet roads

If you have driven for a long time in heavy rain without braking, there may be a delayed reaction from the brakes when braking for the first time. This may also occur after the vehicle has been washed or driven through deep water.

You then have to depress the brake pedal more firmly. Maintain a greater distance from the vehicle in front.

After driving on a wet road or having the vehicle washed, brake firmly while paying attention to the traffic conditions. This will warm up the brake discs, thereby drying them more quickly and protecting them against corrosion.

Limited braking performance on salt-treated roads

If you drive on salted roads, a layer of salt residue may form on the brake discs and brake pads. This can result in a significantly longer braking distance.

- Brake occasionally to remove any possible salt residue. Make sure that you do not endanger other road users when doing so.
- Carefully depress the brake pedal at the beginning and end of a journey.
- Maintain a greater distance to the vehicle ahead.

Servicing the brakes

! If the red brake warning lamp lights up in the instrument cluster and you hear a warning tone while the engine is running, the brake fluid level may be too low. Observe additional warning messages in the multifunction display.

The brake fluid level may be too low due to brake pad wear or leaking brake lines.

Have the brake system checked immediately. This work should be carried out at a qualified specialist workshop.

! A function or performance test should only be carried out on a 2-axle dynamometer. If you are planning to have the vehicle tested on such a dynamometer, contact an authorized Mercedes-Benz Center to obtain further information first. Otherwise, you could damage the drive train or the brake system.

! Because ESP® is an automatic system, the engine and ignition must be switched off (SmartKey in position **0** or **1** or Start/Stop button in position **0** or **1**) when the electric parking brake is being tested on a brake dynamometer (maximum 10 seconds).

Braking triggered automatically by ESP® may seriously damage the brake system.

All checks and maintenance work on the brake system must be carried out at a qualified specialist workshop. Consult a qualified specialist workshop to arrange this. Have brake pads installed and brake fluid replaced at a qualified specialist workshop. If the brake system has only been subject to moderate loads, you should test the functionality of your brakes at regular intervals. To do so, press firmly on the brake pedal when driving at a high speed. This improves the grip of the brake pads.

You can find a description of Brake Assist (BAS) on (> page 67) or of BAS PLUS on (> page 67).

Mercedes-Benz recommends that you only have brake pads/linings installed on your vehicle which have been approved for Mercedes-Benz vehicles or which correspond to an equivalent quality standard. Brake pads/linings which have not been approved for Mercedes-Benz vehicles or which are not of an equivalent quality could affect your vehicle's operating safety.

Mercedes-Benz recommends that you only use brake fluid that has been specially approved for your vehicle by Mercedes-Benz, or which corresponds to an equivalent quality standard. Brake fluid which has not been approved for Mercedes-Benz vehicles or which is not of an equivalent quality could affect your vehicle's operating safety.

High-performance brake system for AMG vehicles

The high-performance brake system is installed only on the ML 63 AMG.

The high-performance brake system is designed for heavy loads. This may lead to noise when braking. This will depend on:

- Speed
- Braking force
- Environmental conditions, such as temperature and humidity

The wear of individual components of the brake system, such as the brake pads/linings or brake discs, depends on the individual driving style and operating conditions.

For this reason, it is impossible to state a mileage that will be valid under all circumstances. An aggressive driving style will lead to high wear. You can obtain further information about this from your authorized Mercedes-Benz Center.

New and replaced brake pads and discs only reach their optimum braking effect after several hundred kilometers of driving. Compensate for this by applying greater force to the brake pedal. Keep this in mind, and adapt your driving and braking accordingly during this break-in period.

Excessive heavy braking results in correspondingly high brake wear. Observe the  brake wear warning lamp in the instrument cluster and note any brake status messages in the multifunction display. Especially for high performance driving, it is important to maintain and have the brake system checked regularly.

Driving on wet roads

Hydroplaning

If water has accumulated to a certain depth on the road surface, there is a danger of hydroplaning occurring, even if:

- you drive at low speeds.
- the tires have adequate tread depth.

For this reason, in the event of heavy rain or in conditions in which hydroplaning may occur, you must drive in the following manner:

- lower your speed.
- avoid ruts.
- brake carefully.

Driving on flooded roads

! Do not drive through flooded areas. Check the depth of any water before driving through it. Drive slowly through standing water. Otherwise, water may enter the vehicle interior or the engine compartment. This can damage the electronic components in the engine or the automatic transmission. Water can also be drawn in by the engine's air suction nozzles and this can cause engine damage.

i **Vehicles with the AIRMATIC package:** set the raised level before driving through standing water.

Off-road fording

! Under no circumstances should you accelerate before entering the water. The bow wave could cause water to enter and damage the engine and other assemblies.

! Do not open any of the vehicle's doors while fording. Otherwise, water could get into the vehicle interior and damage the vehicle's electronics and interior equipment.

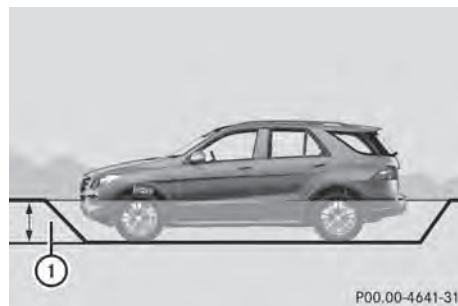

① Fording depth

| | Fording depth |
|--|------------------|
| Steel-sprung vehicles | 20 in (50 cm) |
| Vehicles with the AIRMATIC package and AMG vehicles | |
| Raised level | 20 in (50 cm) |

- Establish how deep the water is and the characteristics of the body of water before fording.
- **Vehicles with the AIRMATIC package:** select the highest possible vehicle level.
- Restrict the shift range to **1** or **2**.
- Avoid high engine speeds.
- Enter and exit the water at a flat place and at a steady walking pace.
- Drive slowly and at an even speed through the water.
- Do not stop.
- Water offers a high degree of resistance, and the ground is slippery and in some cases unstable. Therefore, it is difficult and dangerous to pull away in the water.
- Ensure that a bow wave does not form as you drive.
- Clean any mud from the tire tread after fording.
- Apply the brakes to dry them after fording.

Winter driving

General notes

WARNING

If you shift down on a slippery road surface in an attempt to increase the engine's braking effect, the drive wheels could lose their grip. There is an increased danger of skidding and accidents.

Do not shift down for additional engine braking on a slippery road surface.

DANGER

If the exhaust pipe is blocked or adequate ventilation is not possible, poisonous gases such as carbon monoxide (CO) may enter the vehicle. This is the case, e.g. if the vehicle becomes trapped in snow. There is a risk of fatal injury.

If you leave the engine or the auxiliary heating running, make sure the exhaust pipe and area around the vehicle are clear of snow. To ensure an adequate supply of fresh air, open a window on the side of the vehicle that is not facing into the wind.

Have your vehicle winterproofed at a qualified specialist workshop at the onset of winter.

i Vehicles with a diesel engine: do not cover the radiator, e.g. with a protective cover. The measuring function of the onboard diagnosis system may otherwise provide inaccurate values. Some of these values are required by law and must therefore always be accurate.

Observe the notes in the "Winter operation" section (> page 400).

Driving with summer tires

Observe the notes in the "Winter operation" section (> page 400).

Slippery road surfaces

WARNING

If you shift down on a slippery road surface in an attempt to increase the engine's braking effect, the drive wheels could lose their grip. There is an increased danger of skidding and accidents.

Do not shift down for additional engine braking on a slippery road surface.

If the vehicle threatens to skid or cannot be stopped when moving at low speed:

▶ Shift the transmission to position **N**.

i For more information on driving with snow chains, see (▷ page 401).

Drive particularly carefully on slippery road surfaces. Avoid sudden acceleration, steering and braking maneuvers. Do not use the cruise control or DISTRONIC PLUS.

The outside temperature indicator is not designed to serve as an ice-warning device and is therefore unsuitable for that purpose. Changes in the outside temperature are displayed after a short delay.

Indicated temperatures just above the freezing point do not guarantee that the road surface is free of ice. The road may still be icy, especially in wooded areas or on bridges. You should pay special attention to road conditions when temperatures are around freezing point.

Off-road driving

Important safety notes

WARNING

If you drive on a steep incline at an angle or turn when driving on an incline, the vehicle could slip sideways, tip and rollover. There is a risk of an accident.

Always drive on a steep incline in the line of fall (straight up or down) and do not turn the vehicle.

WARNING

If the vehicle level is high, the vehicle center of gravity is raised. This could cause the vehicle to tip over more easily on uphill or downhill gradients. There is a risk of an accident.

Select the lowest possible vehicle level.

When driving off-road, sand, mud and water, possibly mixed with oil, for example, could get

into the brakes. This could result in a reduced braking effect or in total brake failure and also in increased wear and tear. The braking characteristics change depending on the material ingressing the brakes. Clean the brakes after driving off-road. If you detect a reduced braking effect or grinding noises, have the brake system checked in a qualified specialist workshop as soon as possible. Adapt your driving style to the different braking characteristics.

Driving off-road increases the likelihood of damage to the vehicle, which, in turn, can lead to failure of the mechanical assembly or systems. Adapt your driving style to suit the terrain conditions. Drive carefully. Have damage to the vehicle rectified immediately at a qualified specialist workshop.

Do not switch to transmission position **N** when driving off-road. You could lose control of the vehicle if you attempt to brake using the service brake. If the gradient is too steep, drive backwards in reverse gear.

General notes

Read this section carefully before driving your vehicle off-road. Practice by driving over more gentle off-road terrain first.

Familiarize yourself with the characteristics of your vehicle and the gear shift operation before driving through difficult terrain.

The following driving systems are specially adapted to off-road driving:

- Off-road ABS (▷ page 66)
- AIRMATIC package (vehicle level) (▷ page 209)
- DSR (Downhill Speed Regulation) (▷ page 246)

Observe the following notes:

- Stop the vehicle before starting to drive along an off-road route.
- **For vehicles with the AIRMATIC package:** select a vehicle level that is suitable for the off-road terrain. To avoid

damaging the vehicle, make sure there is always sufficient ground clearance.

- Check that items of luggage and loads are stowed safely and are well secured (▷ page 337).
 - Always keep the engine running and in gear when driving on a downhill gradient. Activate DSR (▷ page 246).
 - Always keep the doors, tailgate, windows and sliding sunroof closed while driving.
 - Adapt your speed to the terrain. The rougher, steeper or more ruts on the terrain, the slower your speed should be.
 - Drive slowly and at an even speed through the water. Ensure that a bow wave does not form as you drive.
 - Drive with extreme care on unfamiliar off-road routes where visibility is poor. For safety reasons, get out of the vehicle first and survey the off-road route.
 - Look out for obstacles, such as rocks, holes, tree stumps and furrows.
 - Check the depth of water before fording rivers and streams.
 - When fording, do not stop and do not switch off the engine.
 - On sand, drive quickly to overcome the rolling resistance. Otherwise the vehicle's wheels could become stuck in loose ground.
 - Do not jump with the vehicle as this will interrupt the vehicle's propulsion.
 - Always keep the engine running and in gear when driving on a slope.
 - Do not shift the automatic transmission to transmission position **N**.
- i** Do not use the HOLD function when driving off-road, on steep uphill or downhill gradients or on slippery or loose surfaces. The HOLD function cannot hold the vehicle on such surfaces.

Checklist before driving off-road

- !** If the engine oil warning lamp lights up while the vehicle is in motion, stop the vehicle in a safe place as soon as possible. Check the engine oil level. The engine oil warning lamp warning must not be ignored. Continuing the journey while the symbol is displayed could lead to engine damage.
- ▶ **Engine oil level:** check the engine oil level and add oil if necessary.
When driving on steep gradients, the engine oil level must be sufficiently high to ensure a correct oil supply in the vehicle.
 - ▶ **DEF tank (BlueTEC vehicles):** check the fluid level and, if necessary, refill to the maximum (13 l) (▷ page 177).
 - ▶ **Wheel-changing tool kit:** check that the jack is working and make sure you have the lug wrench, a robust tow cable and a folding spade in the vehicle.
 - ▶ **Wheels and tires:** check the tire tread depth and tire pressure.
 - ▶ Check for damage and remove any foreign objects, e.g. small stones, from the wheels/tires.
 - ▶ Replace any missing valve caps.
 - ▶ Replace dented or damaged wheels.
 - ▶ **Rims:** dented or bent rims can result in a loss of tire pressure and damage the tire bead. Therefore, check your rims before driving off-road and replace them as required.

Checklist after driving off-road

- !** If you detect damage to the vehicle after driving off-road, have the vehicle checked immediately at a qualified specialist workshop.
- ▶ Deactivate DSR (▷ page 246).
 - ▶ **Vehicles with the AIRMATIC package:** lower the vehicle to a ride height suitable for the road conditions, e.g. to the highway/high-speed level.

- ▶ Clean the headlamps and rear lights and check for damage.
 - ▶ Clean the front and rear license plates.
 - ▶ Clean the wheels/tires with a water jet and remove any foreign objects.
 - ▶ Clean the wheels, wheel housings and the vehicle underside with a water jet; check for any foreign objects and damage.
 - ▶ Check whether twigs or other parts of plants have become trapped. These increase the risk of fire and can damage fuel pipes, brake hoses or the rubber bellows of the axle joints and propeller shafts.
 - ▶ After the trip, examine without fail the entire undercarriage, wheels, tires, brakes, bodywork structure, steering, chassis and exhaust system for damage.
 - ▶ After driving for extended periods across sand, mud, gravel, water or in similarly dirty conditions, have the brake discs, wheels, brake pads/linings and axle joints checked and cleaned.
 - ▶ If you detect strong vibrations after off-road travel, check for foreign objects in the wheels and drive train and remove them if necessary. Foreign objects can disturb the balance and cause vibrations.
- drive quickly to overcome the rolling resistance. Otherwise the vehicle's wheels could become stuck in loose ground.
 - drive in the tracks of other vehicles if possible. Make sure that:
 - the tire ruts are not too deep.
 - the sand is sufficiently firm.
 - the ground clearance of the vehicle is sufficient.

Tire ruts and gravel roads

- ❗ Check that the ruts are not too deep and that your vehicle has sufficient clearance. Otherwise, your vehicle could be damaged or bottom out and get stuck.

Observe the following rules when driving along ruts in off-road terrain or on roads with loose gravel:

- **vehicles with the AIRMATIC package:** select a raised vehicle level.
- avoid high engine speeds.
- select shift range **1**.
- drive slowly.
- where ruts are too deep, drive with the wheels of one side on the center grassy area, if possible.

Crossing obstacles

- ❗ Obstacles could damage the floor of the vehicle or components of the chassis. Ask passengers for guidance when driving over large obstacles. The passenger should always keep a safe distance from the vehicle when doing so in order to avoid injury as a result of unexpected vehicle movements. After driving off-road or over obstacles, check the vehicle for possible damage, especially to the underbody and the components of the chassis.

Driving over rough terrain places greater demands on your vehicle than driving on normal roads. After driving off-road, check the vehicle. This allows you to detect damage promptly and reduce the risk of an accident to yourself and other road users.

Driving on sand

Observe the following rules when driving on sand:

- **vehicles with the AIRMATIC package:** select a raised vehicle level.
- avoid high engine speeds.
- select a shift range appropriate to the terrain.



Observe the following rules when driving over tree stumps, large stones and other obstacles:

- Raise the vehicle level.
- Avoid high engine speeds.
- Select shift range 1.
- Drive very slowly.
- Drive straight over the center of obstacles.

Traveling uphill

Approach/departure angle

WARNING

If you drive on a steep incline at an angle or turn when driving on an incline, the vehicle could slip sideways, tip and rollover. There is a risk of an accident.

Always drive on a steep incline in the line of fall (straight up or down) and do not turn the vehicle.



All vehicles (except vehicles with AMG bodystyling)

| | ① | ② |
|--|-----|-----|
| Steel-sprung vehicles | 26° | 25° |
| Vehicles with the AIRMATIC package | | |
| Highway level | 23° | 23° |
| Raised level | 30° | 28° |
| Vehicles with the ON&OFFROAD package | | |
| Highway level | 23° | 23° |
| Off-road level 1 | 26° | 25° |
| Off-road level 2 | 30° | 28° |
| Off-road level 3 | 31° | 29° |
| AMG vehicles | | |
| Highway level (in sports mode with the AMG adaptive suspension system activated) | 19° | 21° |
| Raised level | 23° | 24° |

Vehicles with AMG bodystyling

| | ① | ② |
|---|-----|-----|
| Steel-sprung vehicles | 25° | 25° |
| Vehicles with the AIRMATIC package | | |
| Highway level | 22° | 22° |
| Raised level | 28° | 27° |

| | ① | ② |
|---|-----|-----|
| Vehicles with the ON&OFFROAD package | | |
| Highway level | 22° | 22° |
| Off-road level 1 | 25° | 24° |
| Off-road level 2 | 28° | 27° |
| Off-road level 3 | 29° | 29° |

- Observe the rules on off-road driving.
- Do not drive at an angle on slopes, inclines or gradients, but instead follow the direct line of fall. The maximum gradient-climbing capability of your vehicle is 100%, which corresponds to an approach/departure angle of 45°. Note that the climbing ability of your vehicle depends on the terrain conditions.
- Before tackling steep downhill gradients, select shift range 1.
- Drive slowly.
- Avoid high engine speeds – drive at an appropriate engine speed (maximum 3,000 rpm).
- When driving down an incline, make use of the engine's braking effect. Observe the engine speed; do not overrev the engine.
- Check the brakes after prolonged off-road driving.

- **i** Hill start assist will aid you when pulling away on a hill.
For more information, see "Hill start assist" (> page 161).

Do not switch to transmission position **N** when driving off-road. If you try to brake the vehicle using the service brake, you could lose control of the vehicle. If the gradient is too steep for your vehicle, drive back down in reverse gear.

Maximum gradient-climbing capability

On good road surfaces the maximum gradient-climbing capability of your vehicle is 100%, which corresponds to an approach/departure angle of 45°. Note that the vehicle's gradient-climbing capability depends on the off-road conditions.

Accelerate carefully and make sure that the wheels do not spin when driving on steep terrain.

- **i** If the load on the front axle is reduced when pulling away on a steep uphill slope, the front wheels have a tendency to spin. 4ETS recognizes this and brakes the wheels accordingly. The rear wheel torque is increased, making it easier to drive off.

Hilltops

When driving up an uphill gradient, slightly reduce pressure on the accelerator immediately before reaching the brow of the hill. Use the vehicle's own impetus to drive over the top of the hill.

This style of driving prevents:

- the vehicle from lifting off the ground on the brow of a hill
- the vehicle from traveling too quickly down the other side

Driving downhill

- Drive slowly.
- Do not drive at an angle down steep inclines. Steer into the line of fall and drive with the front wheels aligned straight. Otherwise, the vehicle could slip sideways, tip and rollover.
- Before tackling steep downhill gradients, select shift range 1.
- Activate DSR. If this is not sufficient, brake gently. When doing so, make sure that the vehicle is facing in the direction of the line of fall.
- Check that the brakes are working normally after a long downhill stretch.

i The special off-road ABS setting enables a precise, brief and repeated locking of the front wheels. This causes them to dig into loose earth. Be aware that the front wheels easily skid across the ground surface if completely braked and therefore lose their ability to steer.

Driving systems

Cruise control

Important safety notes

If you fail to adapt your driving style, cruise control can neither reduce the risk of an accident nor override the laws of physics. Cruise control cannot take into account the road, traffic and weather conditions. Cruise control is only an aid. You are responsible for the distance to the vehicle in front, for vehicle speed, for braking in good time and for staying in your lane.

Do not use cruise control:

- in road and traffic conditions which do not allow you to maintain a constant speed e.g. in heavy traffic or on winding roads
- on slippery road surfaces. Braking or accelerating could cause the drive wheels to lose traction and the vehicle could then skid
- when there is poor visibility, e.g. due to fog, heavy rain or snow

If there is a change of drivers, advise the new driver of the speed stored.

General notes

Cruise control maintains a constant road speed for you. It brakes automatically in order to avoid exceeding the set speed. On long and steep downhill gradients, especially if the vehicle is laden or towing a trailer, you must select shift range **1**, **2** or **3** in good time. By doing so, you will make use of the braking effect of the engine, which relieves the load

on the brake system and prevents the brakes from overheating and wearing too quickly.

Use cruise control only if road and traffic conditions make it appropriate to maintain a steady speed for a prolonged period. You can store any road speed above 20 mph (30 km/h).

i Cruise control should not be activated during off-road driving.

Cruise control lever

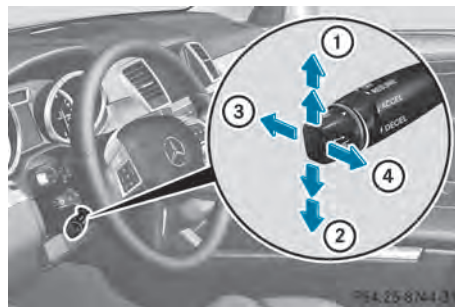

- ① To activate or increase speed
- ② To activate or reduce speed
- ③ To deactivate cruise control
- ④ To activate at the current speed/last stored speed

When you activate cruise control, the stored speed is shown in the multifunction display for five seconds. In the multifunction display, the segments between the stored speed and the maximum speed light up.

Activation conditions

To activate cruise control, all of the following activation conditions must be fulfilled:

- the electric parking brake must be released.
- you are driving faster than 20mph (30 km/h).
- ESP® must be active, but not intervening.
- the transmission must be in position **D**.

- DSR must be deactivated.
- off-road program 2 must be deactivated (vehicles with the ON&OFFROAD package).

Storing, maintaining and calling up a speed

Storing and maintaining a speed

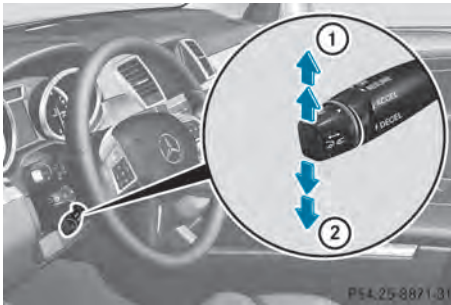

- ▶ Accelerate the vehicle to the desired speed.
- ▶ Briefly press the cruise control lever up ① or down ②.
- ▶ Remove your foot from the accelerator pedal.
Cruise control is activated. The vehicle automatically maintains the stored speed.

You can accept the current speed if you are driving faster than 20 mph (30 km/h).

- ❗ Cruise control may be unable to maintain the stored speed on uphill gradients. The stored speed is resumed when the gradient evens out. Cruise control maintains the stored speed on downhill gradients by automatically applying the brakes.

Storing or calling up a speed

⚠ WARNING

If you call up the stored speed and it differs from the current speed, the vehicle accelerates or decelerates. If you do not know the stored speed, the vehicle could accelerate or brake unexpectedly. There is a risk of an accident.

Pay attention to the road and traffic conditions before calling up the stored speed. If you do not know the stored speed, store the desired speed again.

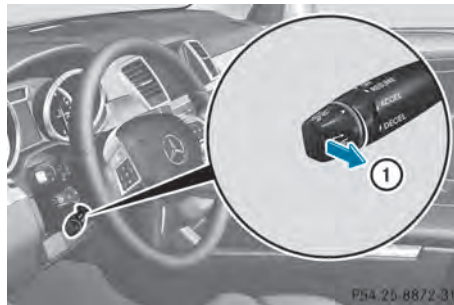

- ▶ Briefly pull the cruise control lever towards you ①.
- ▶ Remove your foot from the accelerator pedal.
The first time cruise control is activated, it stores the current speed or regulates the speed of the vehicle to the previously stored speed.

Setting a speed

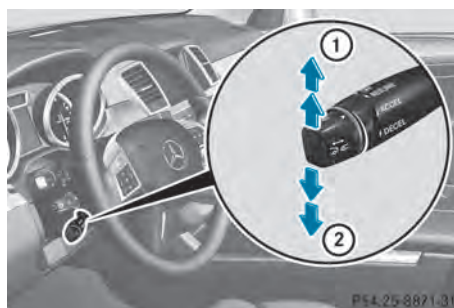

Keep in mind that it may take a brief moment until the vehicle has accelerated or braked to the speed set.

- ▶ Press the cruise control lever up ① for a higher speed or down ② for a lower speed.
- ▶ **To adjust the set speed in 1 mph increments (1 km/h increments):** briefly

press the cruise control lever up ① or down ② to the pressure point. Every time the cruise control lever is pressed up ① or down ② the last speed stored is increased or reduced.

- ▶ **To adjust the set speed in 5 mph increments (10 km/h increments):** briefly press the cruise control lever up ① or down ② to the pressure point. Every time the cruise control lever is pressed up ① or down ② the last speed stored is increased or reduced.

- ❗ Cruise control is not deactivated if you depress the accelerator pedal. For example, if you accelerate briefly to overtake, cruise control adjusts the vehicle's speed to the last speed stored after you have finished overtaking.

Deactivating cruise control

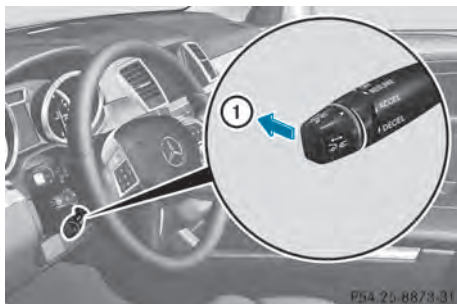

There are several ways to deactivate cruise control:

- ▶ Briefly press the cruise control lever forwards ①.

or

- ▶ Brake.

Cruise control is automatically deactivated if:

- you engage the electric parking brake.
- you are driving at less than 20 mph (30 km/h).
- ESP® intervenes or you deactivate ESP®.

- you activate DSR.
- you shift the transmission to position **N** while driving.

If cruise control is deactivated, you will hear a warning tone. You will see the **Cruise Control Off** message in the multifunction display for approximately five seconds.

- ❗ When you switch off the engine, the last speed stored is cleared.

DISTRONIC PLUS

Important safety notes

⚠ WARNING

DISTRONIC PLUS does not react to:

- people or animals
- stationary obstacles on the road, e.g. stopped or parked vehicles
- oncoming and crossing traffic

As a result, DISTRONIC PLUS may neither give warnings nor intervene in such situations. There is a risk of an accident.

Always pay careful attention to the traffic situation and be ready to brake.

⚠ WARNING

DISTRONIC PLUS cannot always clearly identify other road users and complex traffic situations.

In such cases, DISTRONIC PLUS may:

- give an unnecessary warning and then brake the vehicle
- neither give a warning nor intervene
- accelerate unexpectedly

There is a risk of an accident.

Continue to drive carefully and be ready to brake, in particular when warned to do so by DISTRONIC PLUS.

⚠ WARNING

DISTRONIC PLUS brakes your vehicle with up to 40% of the maximum braking force. If this

braking force is insufficient, DISTRONIC PLUS warns you visually and audibly. There is a risk of an accident.

In such cases, apply the brakes yourself and try to take evasive action.

! If DISTRONIC PLUS or the HOLD function is activated, the vehicle brakes automatically in certain situations. To prevent damage to the vehicle, deactivate DISTRONIC PLUS and the HOLD function in the following or other similar situations:

- when towing the vehicle
- in the car wash

If you fail to adapt your driving style, DISTRONIC PLUS can neither reduce the risk of accident nor override the laws of physics. DISTRONIC PLUS cannot take into account the road, traffic and weather conditions. DISTRONIC PLUS is only an aid. You are responsible for the distance to the vehicle in front, for vehicle speed, for braking in good time and for staying in your lane.

Do not use DISTRONIC PLUS:

- in road and traffic conditions which do not allow you to maintain a constant speed e.g. in heavy traffic or on winding roads
- on slippery road surfaces. Braking or accelerating could cause the drive wheels to lose traction and the vehicle could then skid
- when there is poor visibility, e.g. due to fog, heavy rain or snow

DISTRONIC PLUS may not detect narrow vehicles driving in front, e.g. motorcycles, or vehicles driving on a different line.

In particular, the detection of obstacles can be impaired if:

- dirt on the sensors or anything else covering the sensors
- snow or heavy rain
- interference by other radar sources
- strong radar reflections, for example, in parking garages

If DISTRONIC PLUS no longer detects a vehicle in front, DISTRONIC PLUS may unexpectedly accelerate the vehicle to the stored speed.

This speed may:

- be too high if you are driving in a filter lane or an exit lane
- be so high when driving in the right-hand lane that you overtake vehicles in the left-hand lane
- be so high when driving in the left-hand lane that you overtake vehicles in the right-hand lane

If there is a change of drivers, advise the new driver of the speed stored.

General notes

DISTRONIC PLUS regulates the speed and automatically helps you maintain the distance to the vehicle detected in front. DISTRONIC PLUS brakes automatically so that the set speed is not exceeded.

On long and steep downhill gradients, especially if the vehicle is laden or towing a trailer, you must select shift range **1**, **2** or **3** in good time. By doing so, you will make use of the braking effect of the engine. This relieves the load on the brake system and prevents the brakes from overheating and wearing too quickly.

If DISTRONIC PLUS detects a slower-moving vehicle in front, your vehicle is braked in order to maintain the preset distance to the vehicle in front.

If DISTRONIC PLUS detects that there is a risk of a collision, you will be warned visually and acoustically. DISTRONIC PLUS cannot prevent a collision without your intervention. An intermittent warning tone will then sound and the distance warning lamp will light up in the instrument cluster. Brake immediately in order to increase the distance to the vehicle in front or take evasive action provided it is safe to do so.

For DISTRONIC PLUS to assist you when driving, the radar sensor system must be:

- activated (▷ page 277)
- operational

If there is no vehicle in front, DISTRONIC PLUS operates in the same way as cruise control in the speed range between 20 mph (Canada: 30 km/h) and 120 mph (Canada: 200 km/h). If a vehicle is driving in front of you, it operates in the speed range between 0 mph (0 km/h) and 120 mph (Canada: 200 km/h).

Do not use DISTRONIC PLUS while driving on roads with steep gradients.

As DISTRONIC PLUS transmits radar waves, it can resemble the radar detectors of the responsible authorities. You can refer to the relevant chapter in the Operator's Manual if questions are asked about this.

i USA only:

This device has been approved by the FCC as a "Vehicular Radar System". The radar sensor is intended for use in an automotive radar system only. Removing, tampering with, or altering the device will void any warranties, and is not permitted by the FCC. Do not tamper with, alter, or use in any non-approved way.

Any unauthorized modification to this device could void the user's authority to operate the equipment.

i Canada only: This device complies with RSS-210 of Industry Canada. Operation is subject to the following two conditions:

1. This device may not cause harmful interference, and
2. this device must accept any interference received, including interference that may cause undesired operation of the device.

Removal, tampering, or altering of the device will void any warranties, and is not permitted. Do not tamper with, alter, or use in any non-approved way.

Any unauthorized modification to this device could void the user's authority to operate the equipment.

Cruise control lever

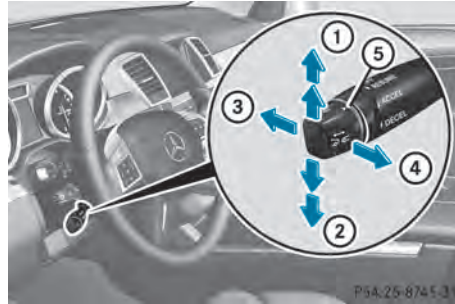

- ① To activate or increase speed
- ② To activate or reduce speed
- ③ To deactivate DISTRONIC PLUS
- ④ To activate at the current speed/last stored speed
- ⑤ To set the specified minimum distance

Activating DISTRONIC PLUS

Activation conditions

In order to activate DISTRONIC PLUS, the following conditions must be fulfilled:

- the engine must be started. It may take up to two minutes after pulling away before DISTRONIC PLUS is operational.
- the electric parking brake must be released.
- ESP® must be active, but not intervening.
- the transmission must be in position **D**.
- the driver's door must be closed when you shift from **P** to **D** or your seat belt must be fastened.
- the front-passenger door and rear doors must be closed.
- off-road program 2 must be deactivated (vehicles with the ON&OFFROAD package).
- DSR must be deactivated.
- the vehicle must not skid.

Activating while driving

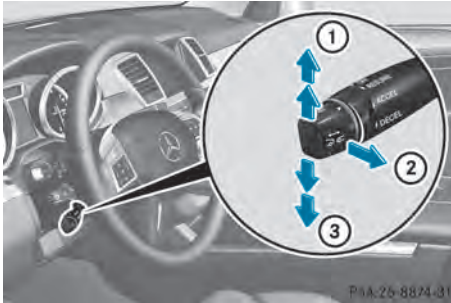

- ▶ Briefly pull the cruise control lever towards you ② or press it up ① or down ③. DISTRONIC PLUS is selected.
- ▶ **To adjust the set speed in 1 mph increments (1 km/h increments):** briefly press the cruise control lever up ① to the pressure point for a higher speed or down ③ for a lower speed.
Every time the cruise control lever is pressed up or down, the last speed stored is increased or reduced.

or

- ▶ **To adjust the set speed in 5 mph increments (10 km/h increments):** briefly press the cruise control lever up ① past the pressure point for a higher speed or down ③ for a lower speed.
Every time the cruise control lever is pressed up or down, the last speed stored is increased or reduced.
- ▶ Remove your foot from the accelerator pedal.
Your vehicle adapts its speed to that of the vehicle in front, but only up to the desired stored speed.

If the vehicle in front has been detected and is shown in the multifunction display, you can also activate DISTRONIC PLUS when driving at speeds below 20 mph (30km/h). If the vehicle in front is no longer detected and displayed, for example because it has changed lanes, DISTRONIC PLUS is deactivated. You will hear a warning tone if this is the case.

- ❗ If you do not fully release the accelerator pedal, the **DISTRONIC PLUS Passive** message appears in the multifunction display. The set distance to a slower-moving vehicle in front will then not be maintained. You will be driving at the speed you determine by the position of the accelerator pedal.

Activating when driving towards a stationary vehicle

- ▶ Briefly pull the cruise control lever towards you ② or press it up ① or down ③. DISTRONIC PLUS is selected.
- ▶ **To adjust the set speed in 1 mph increments (1 km/h increments):** briefly press the cruise control lever up ① to the pressure point for a higher speed or down ③ for a lower speed.
Every time the cruise control lever is pressed up or down, the last speed stored is increased or reduced.

or

- ▶ **To adjust the set speed in 5 mph increments (10 km/h increments):** briefly press the cruise control lever up ① past the pressure point for a higher speed or down ③ for a lower speed.
Every time the cruise control lever is pressed up or down, the last speed stored is increased or reduced.

If the vehicle in front of you is stationary, you can only activate DISTRONIC PLUS once your vehicle is stationary as well.

- ❗ DISTRONIC PLUS can only be activated at under 20 mph (30km/h) if a vehicle in front has been detected. Therefore, the DISTRONIC PLUS distance display in the instrument cluster should be activated (▷ page 272).

- ❗ You can use the cruise control lever to set the stored speed and the control on the cruise control lever to set the specified minimum distance (▷ page 200).

Activating at the current speed/last stored speed

WARNING

If you call up the stored speed and it differs from the current speed, the vehicle accelerates or decelerates. If you do not know the stored speed, the vehicle could accelerate or brake unexpectedly. There is a risk of an accident.

Pay attention to the road and traffic conditions before calling up the stored speed. If you do not know the stored speed, store the desired speed again.

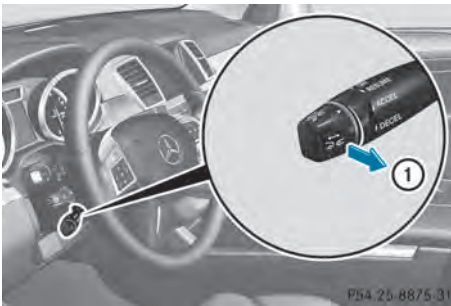

- ▶ Briefly pull the cruise control lever towards you ①.
- ▶ Remove your foot from the accelerator pedal.
DISTRONIC PLUS is activated. The first time it is activated, the current speed is stored. Otherwise, it sets the vehicle cruise speed to the previously stored value.

Driving with DISTRONIC PLUS

Pulling away and driving

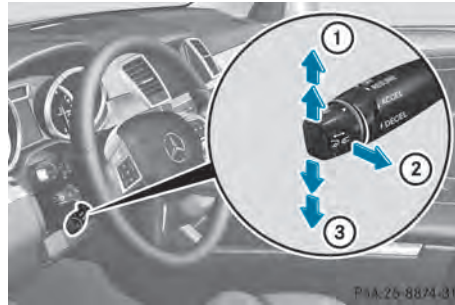

- ▶ **If the vehicle in front pulls away:** remove your foot from the brake pedal.
 - ▶ Briefly pull the cruise control lever towards you ② or press it up ① or down ③.
- or
- ▶ Accelerate briefly.
Your vehicle pulls away and adapts its speed to that of the vehicle in front.

If there is no vehicle in front, DISTRONIC PLUS operates in the same way as cruise control.

If DISTRONIC PLUS detects that the vehicle in front has slowed down, it brakes your vehicle. In this way, the distance you have selected is maintained.

If DISTRONIC PLUS detects a faster-moving vehicle in front, it increases the driving speed. However, the vehicle is only accelerated up to the speed you have stored.

If you depress the brake, DISTRONIC PLUS is deactivated unless your vehicle is stationary.

Changing lanes

If you change to the passing lane, DISTRONIC PLUS supports you when:

- you are driving faster than 40mph (60 km/h)
- DISTRONIC PLUS is maintaining the distance to a vehicle in front

- you switch on the appropriate turn signal
- DISTRONIC PLUS does not detect a danger of collision

If these conditions are fulfilled, your vehicle is accelerated. Acceleration will be interrupted if changing lanes takes too long or if the distance between your vehicle and the vehicle in front becomes too small.

- i** When changing lanes, DISTRONIC PLUS monitors the left lane on left-hand drive vehicles and the right lane on right-hand drive vehicles.

Vehicles with COMAND

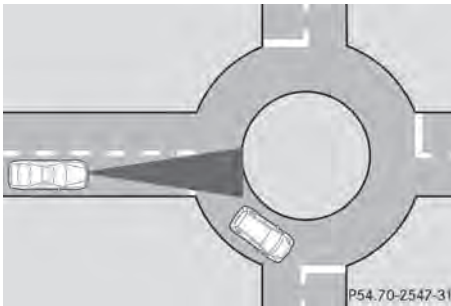

Example: traffic circle

- i** The following function is not operational in all countries.

DISTRONIC PLUS uses additional information from your navigation system so that it can react appropriately to certain traffic situations. This is the case if, while following a vehicle, DISTRONIC PLUS is active and you:

- approach or drive through a traffic circle
- approach a T-intersection
- turn off at a highway exit

Even if the vehicle in front leaves the detection range, DISTRONIC PLUS temporarily maintains the current driving speed and does not accelerate. This is based on the current map data in the navigation system.

The current speed is maintained:

- approximately 10 seconds before the traffic circle/T intersection and

approximately 1.5 seconds when driving on a traffic circle.

- approximately 12 seconds before reaching a highway exit and approximately 4 seconds after the highway exit.

Afterwards, the vehicle accelerates back to the set speed you specified.

Stopping

⚠ WARNING

When leaving the vehicle, even if it is braked only by DISTRONIC PLUS, it could roll away if:

- there is a malfunction in the system or in the voltage supply.
- DISTRONIC PLUS has been deactivated with the cruise control lever, e.g. by a vehicle occupant or from outside the vehicle.
- the electrical system in the engine compartment, the battery or the fuses have been tampered with.
- the battery is disconnected.
- the accelerator pedal has been depressed, e.g. by a vehicle occupant.

There is a risk of an accident.

If you wish to exit the vehicle, always turn off DISTRONIC PLUS and secure the vehicle against rolling away.

If DISTRONIC PLUS detects that the vehicle in front is stopping, it brakes your vehicle until it is stationary.

Once your vehicle is stationary, it remains stationary and you do not need to depress the brake.

After a time, the electric parking brake secures the vehicle and relieves the service brake.

Depending on the specified minimum distance, your vehicle will come to a standstill at a sufficient distance behind the vehicle in front. The specified minimum distance is set using the control on the cruise control lever.

The electric parking brake automatically secures the vehicle if DISTRONIC PLUS is activated and:

- the driver's door is open and the driver's seat belt is unfastened.
- the engine is switched off, unless it is automatically switched off by the ECO start/stop function.
- a system malfunction occurs.
- the power supply is not sufficient.

On steep uphill or downhill inclines or if there is a malfunction, the transmission may also automatically be shifted into position **P**.

Setting a speed

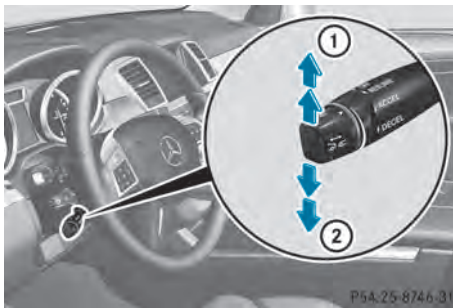

Keep in mind that it may take a brief moment until the vehicle has accelerated or braked to the speed set.

- ▶ Press the cruise control lever up ① for a higher speed or down ② for a lower speed.
- ▶ **To adjust the set speed in 1 mph increments (1 km/h increments):** briefly press the cruise control lever up ① or down ② to the pressure point. Every time the cruise control lever is pressed up ① or down ② the last speed stored is increased or reduced.
- ▶ **To adjust the set speed in 5 mph increments (10 km/h increments):** briefly press the cruise control lever up ① or down ② to the pressure point. Every time the cruise control lever is pressed up ① or down ②, the last speed stored is increased or reduced.

- ① DISTRONIC PLUS is not deactivated if you depress the accelerator pedal. If you accelerate to overtake, DISTRONIC PLUS adjusts the vehicle's speed to the last speed stored after you have finished overtaking.

Setting the specified minimum distance

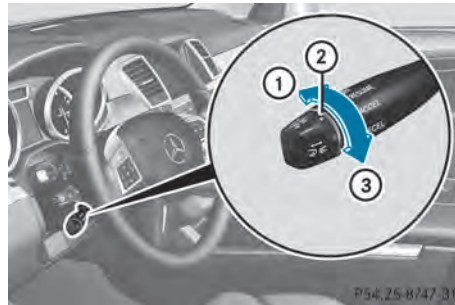

You can set the specified minimum distance for DISTRONIC PLUS by varying the time span between one and two seconds. With this function, you can set the minimum distance that DISTRONIC PLUS keeps to the vehicle in front, dependent on vehicle speed. You can see this distance in the multifunction display (> page 202).

- ▶ **To increase:** turn control ② in direction ③. DISTRONIC PLUS then maintains a greater distance between your vehicle and the vehicle in front.
- ▶ **To decrease:** turn control ② in direction ①. DISTRONIC PLUS then maintains a shorter distance between your vehicle and the vehicle in front.
- ① Make sure that you maintain a sufficiently safe distance from the vehicle in front. Adjust the distance to the vehicle in front if necessary.

Deactivating DISTRONIC PLUS

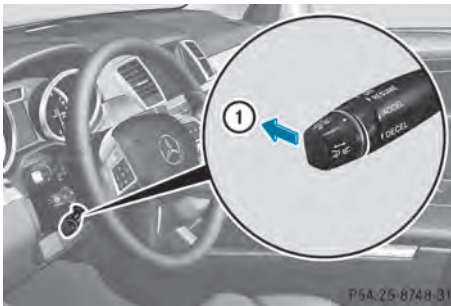

There are several ways to deactivate DISTRONIC PLUS:

- ▶ Briefly press the cruise control lever forwards ①.

or

- ▶ Brake, unless the vehicle is stationary.

When you deactivate DISTRONIC PLUS, you will see the **DISTRONIC PLUS Off** message in the multifunction display for approximately five seconds.

- i** The last speed stored remains stored until you switch off the engine.
- i** DISTRONIC PLUS is not deactivated if you depress the accelerator pedal. If you accelerate to overtake, DISTRONIC PLUS adjusts the vehicle's speed to the last speed stored after you have finished overtaking.

DISTRONIC PLUS is automatically deactivated if:

- you engage the electric parking brake or if the vehicle is automatically secured with the electric parking brake
- you are driving slower than 15 mph (25 km/h) and there is no vehicle in front, or if the vehicle in front is no longer detected
- ESP® intervenes or you deactivate ESP®
- the transmission is in the **P**, **R** or **N** position
- you switch off the radar sensor system (> page 277)

- you pull the cruise control lever towards you in order to pull away and the front-passenger door or one of the rear doors is open
- you activate DSR
- you activate off-road program 2 on vehicles with the ON&OFFROAD package
- the vehicle has skidded

If DISTRONIC PLUS is deactivated, you will hear a warning tone. You will see the **DISTRONIC PLUS Off** message in the multifunction display for approximately five seconds.

Displays in the instrument cluster

Displays in the speedometer



Example: DISTRONIC PLUS displays in the speedometer

When DISTRONIC PLUS is activated, one or two segments ② in the set speed range light up.

If DISTRONIC PLUS detects a vehicle in front, segments ② between speed of the vehicle in front ① and stored speed ③ light up.

- i** For design reasons, the speed displayed in the speedometer may differ slightly from the speed set for DISTRONIC PLUS.

Display when DISTRONIC PLUS is deactivated

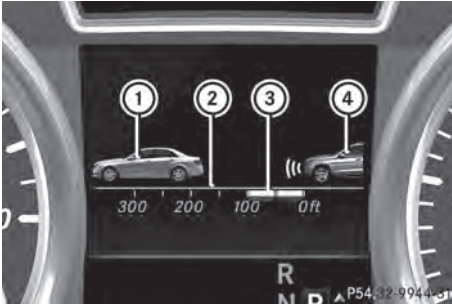

Distance display when DISTRONIC PLUS is deactivated

- ① Vehicle in front, if detected
- ② Distance indicator, current distance to the vehicle in front
- ③ Specified minimum distance to the vehicle in front; adjustable
- ④ Own vehicle

In the Assistance menu (▷ page 272) of the on-board computer, you can select the distance display.

- ▶ Select the **Distance display** function using the on-board computer (▷ page 272).

In the Assistance menu of the on-board computer, you can also activate or deactivate PRE-SAFE® Brake (▷ page 272).

Display when DISTRONIC PLUS is activated



Distance display with DISTRONIC PLUS activated in the multifunction display

- ① DISTRONIC PLUS activated
- ② Own vehicle
- ③ Specified minimum distance to the vehicle in front; adjustable
- ④ Vehicle in front, if detected

In the Assistance menu (▷ page 272) of the on-board computer, you can select the distance display.

- ▶ Select the **Distance display** function using the on-board computer (▷ page 272).

You will see the stored speed for about five seconds when you activate DISTRONIC PLUS.

Tips for driving with DISTRONIC PLUS

General notes

Pay particular attention in the following traffic situations:

- cornering, going into and coming out of a bend
- vehicles traveling on a different line
- other vehicles changing lanes
- narrow vehicles
- obstructions and stationary vehicles
- crossing vehicles

In such situations, brake if necessary. DISTRONIC PLUS is then deactivated.

Cornering, going into and coming out of a bend

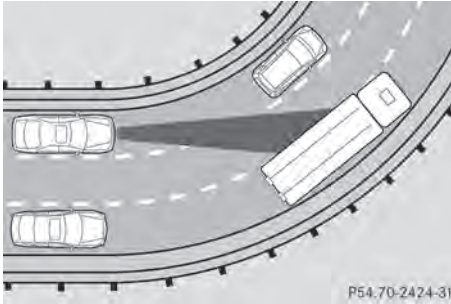

The ability of DISTRONIC PLUS to detect vehicles when cornering is limited. Your vehicle may brake unexpectedly or late.

Vehicles traveling on a different line

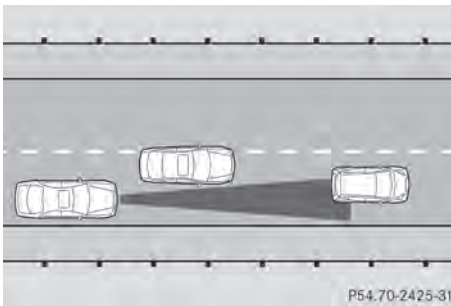

DISTRONIC PLUS may not detect vehicles traveling on a different line. The distance to the vehicle in front will be too short.

Other vehicles changing lanes

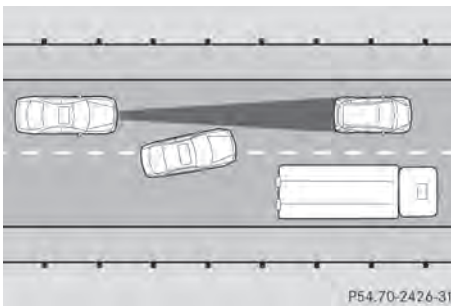

DISTRONIC PLUS has not detected the vehicle cutting in yet. The distance to this vehicle will be too short.

Narrow vehicles

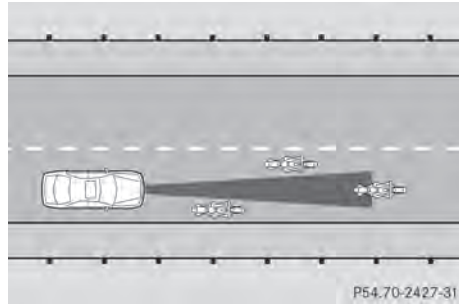

DISTRONIC PLUS has not yet detected the vehicle in front on the edge of the road, because of its narrow width. The distance to the vehicle in front will be too short.

Obstructions and stationary vehicles

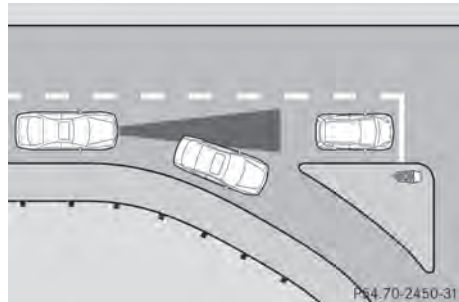

DISTRONIC PLUS does not brake for obstacles or stationary vehicles. If, for example, the detected vehicle turns a corner and reveals an obstacle or stationary vehicle, DISTRONIC PLUS will not brake for these.

Crossing vehicles

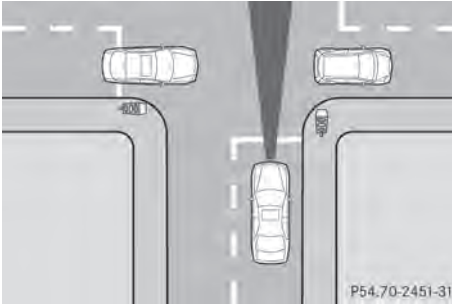

DISTRONIC PLUS may mistakenly detect vehicles that are crossing your lane. Activating DISTRONIC PLUS at traffic lights with crossing traffic, for example, could cause your vehicle to pull away unintentionally.

Level control (vehicles with the ON&OFFROAD package)

Important safety notes

WARNING

When the vehicle is being lowered, people could become trapped if their limbs are between the vehicle body and the wheels or underneath the vehicle. There is a risk of injury.

Make sure no one is underneath the vehicle or in the immediate vicinity of the wheel arches when the vehicle is being lowered.

WARNING

When you drive with the vehicle raised, the driving characteristics could be impaired by the vehicle's raised center of gravity. The vehicle could rollover more easily, for example on a bend. There is a risk of an accident.

Always select as low a vehicle level as possible and adjust your driving style.

WARNING

When you drive with the chassis lowered or raised, the vehicle's braking and driving

characteristics can be significantly impaired. You could also exceed the permissible vehicle height if the chassis is raised. There is a risk of an accident.

Adjust the vehicle level before pulling away.

WARNING

Due to the high center of gravity, the vehicle may start to skid and roll over in the event of an abrupt steering maneuver and/or when the vehicle's speed is not adapted to the road conditions. There is a risk of an accident.

Always adapt your speed and driving style to the vehicle's driving characteristics and to the prevailing road and weather conditions.

-  When driving on extremely rough terrain, select a high vehicle level in good time. Make sure there is always sufficient ground clearance. You will otherwise damage the vehicle.

- Utility vehicles have a significantly higher rollover rate than other types of vehicles. Failure to operate this vehicle safely may result in an accident, rollover of the vehicle, and severe or fatal injury.
- In a rollover crash, an unbelted person is significantly more likely to die than a person wearing a seat belt. You and all vehicle occupants should always wear your seat belts.

Level control adapts the vehicle level automatically to the current operating and driving situation. This results in reduced fuel consumption and improved handling.

Make changes to the vehicle level while the vehicle is in motion. This enables the vehicle to adjust to the new level as quickly as possible.

The vehicle level may change visibly if you park the vehicle and the outside temperature changes. If the temperature drops, the vehicle level is lower; with an increase in temperature, the vehicle level rises.

If you unlock the vehicle or open a door, the vehicle begins to compensate for load discrepancies while still parked. However, for significant level changes, such as after the vehicle has been stationary for a long period, the engine must be on. For safety reasons, the vehicle is only lowered when the doors are closed. Lowering is interrupted if a door is opened, and it continues once the door has been closed.

For information about driving off-road, see (▷ page 187).

Basic settings

The extent to which the vehicle is raised or lowered depends on the basic setting selected.

Select:

- highway/high-speed level for driving on normal roads
- off-road level 1 for driving on easily negotiable off-road terrain
- off-road level 2 for driving on normal off-road terrain
- off-road level 3 for freeing the vehicle in particularly rough terrain at low speeds only

The individual vehicle levels differ from highway level as follows:

- highway level: +/-0 in (+/-0 mm)
- high-speed level: -0.6 in (-15 mm)
- off-road level 1: + 1.2 in (+30 mm)
- off-road level 2: + 2.3 in (+60 mm)
- off-road level 3: + 3.6 in (+ 90 mm)

Highway/high-speed level

! Make sure that there is enough ground clearance when the vehicle is being lowered. It could otherwise hit the ground, damaging the underbody.

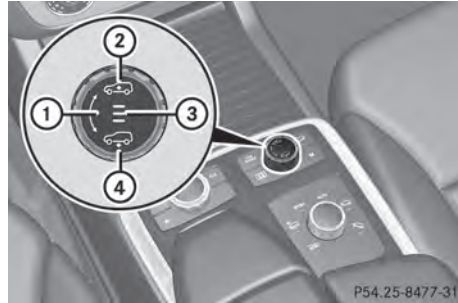

- ① Selector wheel
- ② To raise the level
- ③ Indicator lamps
- ④ To lower the level

▶ Start the engine.

▶ **Selector wheel ① engaged:** briefly press selector wheel ①. Selector wheel ① extends.

If one or more indicator lamps ③ are on:

▶ Turn selector wheel ① counter-clockwise ④ until all indicator lamps ③ that are lit start to flash.

The vehicle is lowered to highway level. As soon as the next lowest level is reached, the indicator lamp stops flashing and goes out.



During the adjustment, the **Lowering** message, for example, appears in the multifunction display.

If you press the  or **OK** button on the multifunction steering wheel, the message

will disappear. Once highway level has been reached, all indicator lamps ③ go out.

The vehicle automatically selects highway level if you are driving at a speed above 70 mph (115 km/h) or if you drive at a speed between 62 mph (100 km/h) and 70 mph (115 km/h) for approximately 20 seconds. The vehicle is lowered to high-speed level if you are traveling at higher speeds.

Off-road levels

General notes

- Only select off-road level 3 for driving off-road in particularly rough terrain.
- Adjust your driving style to the altered handling characteristics.
- Do not drive faster than 12 mph (20 km/h).

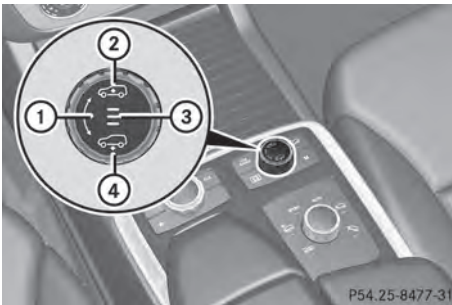

Only select an off-road level when this is appropriate for road conditions. Otherwise, fuel consumption increases and handling may be affected.

- ▶ Start the engine.
 - ▶ **Selector wheel ① engaged:** briefly press selector wheel ①. Selector wheel ① extends.
 - ▶ **To raise:** turn selector wheel ① clockwise ②. The vehicle is raised.
- or
- ▶ **To lower:** turn selector wheel ① counter-clockwise ④. The vehicle is lowered.

Indicator lamps ③ for the desired off-road level flash:



- Off-road level 1: the lower indicator lamp flashes
- Off-road level 2: the lower and center indicator lamps flash
- Off-road level 3: all three indicator lamps flash



The vehicle adjusts to the off-road level selected. As soon as an off-road level is reached, the corresponding indicator lamp stops flashing and lights up constantly.

Raising the vehicle

During the adjustment, the **Vehicle rising** message, for example, appears in the multifunction display.

The vehicle rises from highway level to off-road level 1.

If you press the  or  button on the multifunction steering wheel, the message will disappear.

- ▶ Up to off-road level 2, you can hide the messages using the  or  button on the multifunction steering wheel.

Once off-road level 2 has been reached, the lower and center indicator lamps of the selector wheel are on.



While the adjustment from off-road level 2 to off-road level 3 is taking place, you will see a message such as the following in the multifunction display: **Vehicle rising Max. speed 12 mph (20 km/h).**

The **Max. Speed 12 mph (20 km/h)** message draws your attention to the maximum speed permitted for off-road level 3.

Once off-road level 3 has been reached, you will see a message shown in white in the multifunction display, for example: **Max. Speed 12 mph (20 km/h)**.

If you drive above 20 km/h at off-road level 3, you will see the following message in red in the multifunction display: **Vehicle Lowering Max. Speed 12 mph (20 km/h)**.

i You cannot clear these messages.

You also hear a warning. The vehicle is lowered and off-road level 3 is canceled.

If you continue to increase your speed, the red message continues to be shown in the multifunction display. The newly set level is not displayed until the vehicle has been set to a level suitable for the current speed.

Lowering the vehicle



If you maintain or reduce your speed, you will see a message in white in the display while the vehicle is being lowered, such as the following: **Vehicle Lowering Max. Speed 12 mph (20 km/h)**.

The vehicle is lowered to off-road level 2.

If you select an off-road level when driving at too high a speed, the **Please reduce speed** message appears in the multifunction display.

You can select from the following:

- Off-road level 1 at speeds up to 60 mph (100 km/h)
- Off-road level 2 at speeds up to 40 mph (65 km/h)
- Off-road level 3 at speeds up to 12 mph (20 km/h)

If you are driving above 50 mph (80 km/h) or drive between 40 mph (65 km/h) and 50 mph (80 km/h) for longer than 20 seconds, off-road level 2 will be canceled. The vehicle is lowered to off-road level 1.

You will see a message in the multifunction display, for example: **Lowering**.

If you are driving above 70 mph (115 km/h) or drive between 62 mph (100 km/h) and 70 mph (115 km/h) for longer than 20 seconds, off-road level 1 will be canceled. Depending on the vehicle's speed and the ADS mode selected (> page 209), the vehicle is automatically lowered to highway or high-speed level.

You will see a message in the multifunction display, for example: **Lowering**.

HOLD function

Important safety notes

⚠ WARNING

When leaving the vehicle, it can still roll away despite being braked by the HOLD function if:

- there is a malfunction in the system or in the voltage supply.
- the HOLD function has been deactivated by pressing the accelerator pedal or the brake pedal, e.g. by a vehicle occupant.
- the electrical system in the engine compartment, the battery or the fuses have been tampered with.
- the battery is disconnected

There is a risk of an accident.

If you wish to exit the vehicle, always turn off the HOLD function and secure the vehicle against rolling away.

! If DISTRONIC PLUS or the HOLD function is activated, the vehicle brakes automatically in certain situations. To prevent damage to the vehicle, deactivate DISTRONIC PLUS and the HOLD function in the following or other similar situations:

- when towing the vehicle
- in the car wash

Deactivate the HOLD function (▷ page 208).

General notes

The HOLD function can assist the driver in the following situations:

- when pulling away, especially on steep slopes
- when maneuvering on steep slopes
- when waiting in traffic

The vehicle is kept stationary without the driver having to depress the brake pedal.

The braking effect is canceled and the HOLD function deactivated when you depress the accelerator pedal to pull away.

i Do not use the HOLD function when driving off-road, on steep uphill or downhill gradients or on slippery or loose surfaces. The HOLD function cannot hold the vehicle on such surfaces.

Activation conditions

You can activate the HOLD function if:

- the vehicle is stationary
- the engine is running
- the driver's door is closed or your seat belt is fastened
- the electric parking brake is released
- the transmission is in position **D**, **R** or **N**
- DISTRONIC PLUS is deactivated

Activating the HOLD function

- ▶ Make sure that the activation conditions are met.
- ▶ Depress the brake pedal.
- ▶ Quickly depress the brake pedal further until **HOLD** appears in the multifunction display. The HOLD function is activated. You can release the brake pedal.

i If depressing the brake pedal the first time does not activate the HOLD function, wait briefly and then try again.

Deactivating the HOLD function

The HOLD function is deactivated automatically if:

- you accelerate and the transmission is in position **D** or **R**
- you shift the transmission to position **P**
- you depress the brake pedal again with a certain amount of pressure until **HOLD** disappears from the multifunction display
- you secure the vehicle using the electric parking brake
- you activate DISTRONIC PLUS

i After a time, the electric parking brake secures the vehicle and relieves the service brake.

The electric parking brake automatically secures the vehicle if the HOLD function is activated and:

- the driver's door is open and the driver's seat belt is unfastened.
- the engine is switched off.
- a system malfunction occurs.
- the power supply is not sufficient.

On steep uphill or downhill inclines or if there is a malfunction, the transmission may also be automatically shifted into position **P**.

AIRMATIC package

General notes

AIRMATIC regulates the level of your vehicle. As well as level control (▷ page 210), your vehicle can be equipped with ADS (Adaptive Damping System) (▷ page 209) and ACTIVE CURVE SYSTEM (▷ page 209).

Observe the notes on driving with a trailer (▷ page 253).

ADS (Adaptive Damping System)

General notes

ADS adapts the damping characteristics to the current operating and driving situation. This depends on:

- your driving style
- the road surface conditions
- the ADS setting
- the vehicle level setting

Your selection remains stored even if you remove the SmartKey from the ignition lock.

Sports tuning

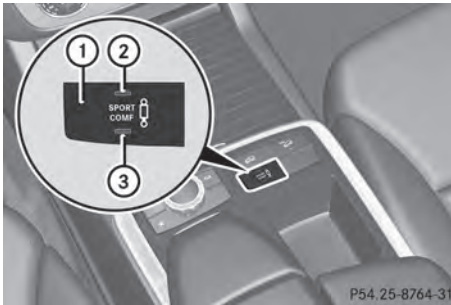

Example: vehicles without the ON&OFFROAD package

- ① Suspension tuning button
- ② Indicator lamp for sports tuning
- ③ Indicator lamp for comfort tuning

▶ Start the engine.

▶ Press button ①.

Indicator lamp ② lights up. Sports suspension tuning is selected. The vehicle is lowered by 0.6 in (15 mm).

The firmer suspension tuning in Sport mode ensures even better contact with the road. Select this mode when employing a sporty driving style, e.g. on winding country roads.

Comfort tuning

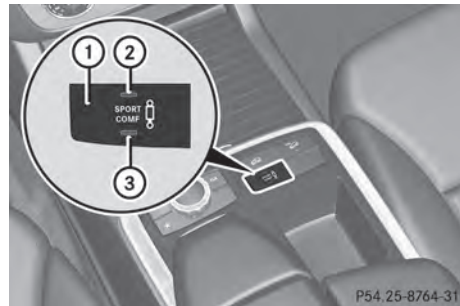

Example: vehicles without the ON&OFFROAD package

- ① Suspension tuning button
- ② Indicator lamp for sports tuning
- ③ Indicator lamp for comfort tuning

▶ Press button ①.

Indicator lamp ③ lights up. Comfort tuning is selected. The vehicle is raised by 0.6 in (15 mm).

In comfort mode, the driving characteristics of your vehicle are more comfortable. Therefore, select this mode if you favor a more comfortable driving style. Select comfort mode also when driving fast on straight roads, e.g. on straight stretches of freeway.

Active Curve System

The Active Curve System uses active stabilizers to optimize both driving comfort and vehicle agility. Depending on the ADS mode selected (▷ page 209), the Active Curve System also changes the setting.

If you select ADS comfort mode:

- rolling movement is reduced in the event of changing surface undulations
- the roll angle when cornering is reduced
- the driving style is agile

If you select ADS sport mode:

- the roll angle is reduced significantly
- the driving style is even more agile

Level control

Important safety notes

WARNING

When the vehicle is being lowered, people could become trapped if their limbs are between the vehicle body and the wheels or underneath the vehicle. There is a risk of injury.

Make sure no one is underneath the vehicle or in the immediate vicinity of the wheel arches when the vehicle is being lowered.

WARNING

When you drive with the vehicle raised, the driving characteristics could be impaired by the vehicle's raised center of gravity. The vehicle could rollover more easily, for example on a bend. There is a risk of an accident.

Always select as low a vehicle level as possible and adjust your driving style.

WARNING

When you drive with the chassis lowered or raised, the vehicle's braking and driving characteristics can be significantly impaired. You could also exceed the permissible vehicle height if the chassis is raised. There is a risk of an accident.

Adjust the vehicle level before pulling away.

WARNING

Due to the high center of gravity, the vehicle may start to skid and roll over in the event of an abrupt steering maneuver and/or when

the vehicle's speed is not adapted to the road conditions. There is a risk of an accident.

Always adapt your speed and driving style to the vehicle's driving characteristics and to the prevailing road and weather conditions.

 When driving on extremely rough terrain, select a high vehicle level in good time. Make sure there is always sufficient ground clearance. You will otherwise damage the vehicle.

 When you raise the vehicle in such a way that not all wheels have contact with the ground, remove the SmartKey from the ignition lock.

- Utility vehicles have a significantly higher rollover rate than other types of vehicles. Failure to operate this vehicle safely may result in an accident, rollover of the vehicle, and severe or fatal injury.
- In a rollover crash, an unbelted person is significantly more likely to die than a person wearing a seat belt. You and all vehicle occupants should always wear your seat belts.

General notes

Further information about "Driving off-road" ([▷ page 187](#)).

Level control adapts the vehicle level automatically to the current operating and driving situation. This results in reduced fuel consumption and improved handling.

If you select ADS comfort mode ([▷ page 209](#)), the vehicle is lowered to high-speed level as the speed increases. As the vehicle speed decreases, the vehicle is raised back up to highway level.

If you select ADS sport mode ([▷ page 209](#)), the vehicle skips highway level and lowers directly to high-speed level depending on the basic setting ([▷ page 211](#)).

Make changes to the vehicle level while the vehicle is in motion. This enables the vehicle to adjust to the new level as quickly as possible.

The vehicle level may change visibly if you park the vehicle and the outside temperature changes. If the temperature drops, the vehicle level is lower; with an increase in temperature, the vehicle level rises.

If you unlock the vehicle or open a door, the vehicle begins to compensate for load discrepancies while still parked. However, for significant level changes, such as after the vehicle has been stationary for a long period, the engine must be on. For safety reasons, the vehicle is only lowered when the doors are closed. Lowering is interrupted if a door is opened, and it continues once the door has been closed.

Basic settings

The extent to which the vehicle is raised or lowered depends on the basic setting selected. Select raised level for off-road driving or highway/high-speed level for normal roads.

The individual vehicle levels differ from highway level as follows:

- highway level: +/-0 in (+/-0 mm)
- high-speed level: -0.6 in (-15 mm)
- raised level: +2.3 in (+60 mm)

Raised level

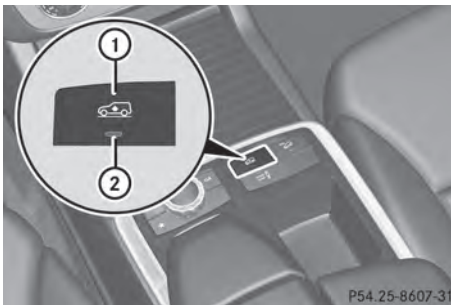

Only select raised level if this is appropriate for the road conditions. Otherwise, fuel consumption may increase and handling may be affected.

- ▶ Start the engine.

If indicator lamp ② is not lit:

- ▶ Press button ①.
Indicator lamp ② flashes. The vehicle rises to raised level.



During the adjustment, the **Vehicle rising** message, for example, appears in the multifunction display.

If you press the or button on the multifunction steering wheel, the message will disappear.

Once the vehicle has reached raised level, indicator lamp ② remains lit. The **Vehicle rising** message disappears from the multifunction display.

If you try to select raised level at a speed above 40 mph (64 km/h), the **Drive More Slowly** message appears in the multifunction display.

Highway/high-speed level

- ❗ Make sure that there is enough ground clearance when the vehicle is being lowered. It could otherwise hit the ground, damaging the underbody.

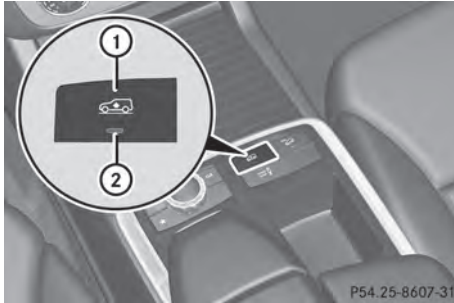

- ① Level control button
- ② Level control indicator lamp



► Start the engine.

If indicator lamp ② is lit:

- Press button ①.
Indicator lamp ② flashes. The vehicle is adjusting to highway/high-speed level.



During the adjustment, the **Lowering** message, for example, appears in the multifunction display.

If you press the  or  button on the multifunction steering wheel, the message will disappear.

Once highway level has been reached, indicator lamp ② goes out. The **Lowering** message disappears from the multifunction display.

The vehicle automatically adjusts to highway level when you:

- drive faster than 50 mph (80 km/h) or
- drive between 40 mph (64 km/h) and 50 mph (80 km/h) for approximately 20 seconds

Depending on the ADS mode selected (> page 209), the vehicle is lowered to high-speed level at high speeds.

AMG adaptive sport suspension system

Rear axle level control

The vehicle automatically sets the vehicle level at the rear axle. Rear axle level control ensures the best possible suspension and that the ground clearance remains constant even when the vehicle is loaded. This improves driving safety and fuel consumption.

Suspension tuning

General notes

The electronically controlled damping system works continuously. This improves driving safety and ride comfort.

The damping is tuned individually to each wheel and depends on:

- your driving style, e.g. sporty
- the road surface condition, e.g. bumps
- your individual selection of Sport, Sport + or Comfort

If you select Sport or Sport + mode and restart the engine, the suspension setting reverts to Comfort mode.

Sport mode

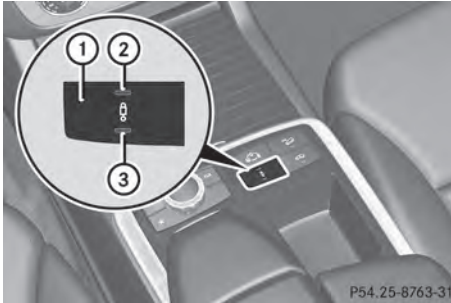

The firmer suspension tuning in Sport mode ensures even better contact with the road. Select this mode when employing a sporty driving style, e.g. on winding country roads.

- ▶ Press the ① button once.
Indicator lamp ② lights up. You have selected Sport mode.
The **AMG Suspension System SPORT** message appears in the multifunction display.

Sport + mode

The very firm setting of the suspension tuning in Sport + mode ensures the best possible contact with the road. Select this mode only when driving on race circuits.

If indicator lamps ③ and ② are off:

- ▶ Press button ① twice.
Indicator lamps ③ and ② light up. You have selected Sport + mode.
The **AMG Suspension System SPORT +** message appears in the multifunction display.

If indicator lamp ② lights up:

- ▶ Press the ① button once.
Second indicator lamp ③ lights up. You have selected Sport + mode.
The **AMG Suspension System SPORT +** message appears in the multifunction display.

Comfort mode

In Comfort mode, the driving characteristics of your vehicle are more comfortable. Therefore, select this mode if you favor a more comfortable driving style. Select comfort mode also when driving fast on straight roads, e.g. on straight stretches of freeway.

- ▶ Press button ① repeatedly until indicator lamps ③ and ② go out.
You have selected Comfort mode.
The **AMG Suspension System COMFORT** message appears in the multifunction display.

PARKTRONIC

Important safety notes

PARKTRONIC is an electronic parking aid with ultrasonic sensors. It indicates visually and audibly the distance between your vehicle and an object.

PARKTRONIC is only an aid. It is not a replacement for your attention to your immediate surroundings. You are always responsible for safe maneuvering, parking and exiting a parking space. When maneuvering, parking or pulling out of a parking space, make sure that there are no persons, animals or objects in the area in which you are maneuvering.

- ❗ When parking, pay particular attention to objects above or below the sensors, such as flower pots or trailer drawbars. PARKTRONIC does not detect such objects when they are in the immediate vicinity of the vehicle. You could damage the vehicle or the objects.

The sensors may not detect snow and other objects that absorb ultrasonic waves. Ultrasonic sources such as an automatic car wash, the compressed-air brakes on a truck or a pneumatic drill could cause PARKTRONIC to malfunction.

PARKTRONIC may not function correctly on uneven terrain.

PARKTRONIC is activated automatically when you:

- switch on the ignition
- shift the transmission to position **D**, **R** or **N**
- release the electric parking brake

PARKTRONIC is deactivated at speeds above 11 mph (18km/h). It is reactivated at lower speeds.

PARKTRONIC monitors the area around your vehicle using six sensors in the front bumper and four sensors in the rear bumper.

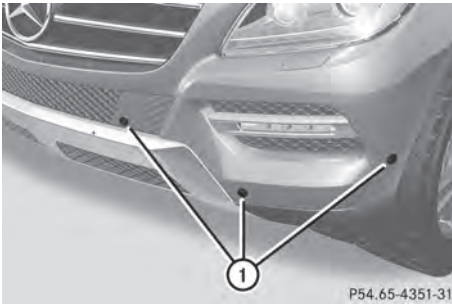

- ① Sensors in the front bumper, left-hand side (example)

Range of the sensors

General notes

PARKTRONIC does not take objects into consideration that are:

- below the detection range, e.g. people, animals or objects
- above the detection range, e.g. overhanging loads, truck overhangs or loading ramps.



Side view

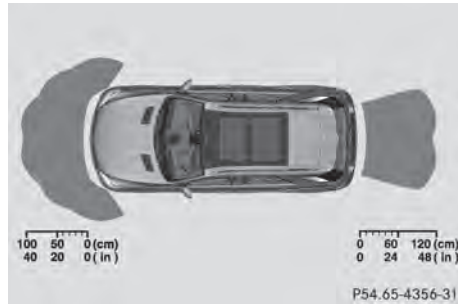

Top view

The sensors must be free from dirt, ice or slush. They can otherwise not function correctly. Clean the sensors regularly, taking care not to scratch or damage them (▷ page 373).

Front sensors

| | |
|---------|------------------------------|
| Center | Approx. 40in (approx. 100cm) |
| Corners | Approx. 24in (approx. 60cm) |

Rear sensors

| | |
|---------|------------------------------|
| Center | Approx. 48in (approx. 120cm) |
| Corners | Approx. 32in (approx. 80cm) |

Minimum distance

| | |
|---------|----------------------------|
| Center | Approx. 8in (approx. 20cm) |
| Corners | Approx. 6in (approx. 15cm) |

If there is an obstacle within this range, the relevant warning displays light up and a warning tone sounds. If the distance falls below the minimum, the distance may no longer be shown.

Warning displays

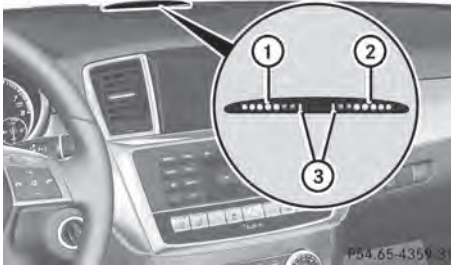

Warning display for the front area

- ① Segments on the left-hand side of the vehicle
- ② Segments on the right-hand side of the vehicle
- ③ Segments showing operational readiness

The warning displays show the distance between the sensors and the obstacle. The warning display for the front area is located on the dashboard above the center air vents. The warning display for the rear area is in the roof lamp in the rear compartment.

The warning display for each side of the vehicle is divided into five yellow and two red segments. PARKTRONIC is operational if yellow segments showing operational readiness ③ light up.

The selected transmission position and the direction in which the vehicle is rolling determine which warning display is active when the engine is running.

| Transmission position | Warning display |
|--|--------------------------------|
| D | Front area activated |
| R, N or the vehicle is rolling backwards | Rear and front areas activated |
| P | No areas activated |

One or more segments light up as the vehicle approaches an obstacle, depending on the vehicle's distance from the obstacle.

From the:

- sixth segment onwards, you will hear an intermittent warning tone for approximately two seconds.
- seventh segment onwards, you will hear a warning tone for approximately two seconds. This indicates that you have now reached the minimum distance.

Deactivating/activating PARKTRONIC



- ① Indicator lamp
- ② Deactivating/activating PARKTRONIC

If indicator lamp ① lights up, PARKTRONIC is deactivated. Active Park Assist is then also deactivated.

- i PARKTRONIC is automatically activated when you turn the SmartKey to position 2 in the ignition lock.

Towing a trailer

! Fold in the ball coupling if the trailer tow hitch is not required. PARKTRONIC measures the minimum detection range to an obstacle from the bumper, not the ball coupling.

PARKTRONIC is deactivated for the rear area when you establish an electrical connection between your vehicle and a trailer.

Problems with PARKTRONIC

| Problem | Possible causes/consequences and ► Solutions |
|--|--|
| Only the red segments in the PARKTRONIC warning displays are lit. You also hear a warning tone for approximately two seconds. PARKTRONIC is deactivated after approximately five seconds, and the indicator lamp in the PARKTRONIC button lights up. | <p>PARKTRONIC has malfunctioned and has switched off.</p> <p>► If problems persist, have PARKTRONIC checked at a qualified specialist workshop.</p> |
| Only the red segments in the PARKTRONIC warning displays are lit. PARKTRONIC is deactivated after approximately five seconds. | <p>The PARKTRONIC sensors are dirty or there is interference.</p> <p>► Clean the PARKTRONIC sensors (▷ page 373).</p> <p>► Switch the ignition back on.</p> <p>The problem may be caused by an external source of radio or ultrasound waves.</p> <p>► See if PARKTRONIC functions in a different location.</p> |

Active Parking Assist

Important safety notes

Active Parking Assist is merely an aid. It is not a replacement for your attention to your immediate surroundings. You are always responsible for safe maneuvering, parking and exiting a parking space. When maneuvering, parking or pulling out of a parking space, make sure that there are no persons, animals or objects in the area in which you are maneuvering.

WARNING

The vehicle swings out when parking and in doing so could cross into the opposite lane. This could result in a collision with another road user. There is a risk of an accident. Pay attention to other road users when parking. Stop the vehicle if necessary or

cancel the Active Parking Assist parking procedure.

! If unavoidable, you should drive over obstacles such as curbs slowly and not at a sharp angle. Otherwise, you may damage the wheels or tires.

Active Parking Assist may possibly indicate parking spaces which are not suitable for parking, for example:

- where parking or stopping is prohibited
- in front of driveways or entrances and exits
- on unsuitable surfaces

Parking tips:

- On narrow roads, drive as close to the parking space as possible.
- Parking spaces that are littered, overgrown or partially occupied by trailer drawbars might be identified incorrectly or not at all.
- Snowfall or heavy rain may lead to a parking space being measured inaccurately.
- Pay attention to the PARKTRONIC (> page 215) warning messages during the parking procedure.
- When transporting a load which protrudes from your vehicle, you should not use Active Parking Assist.
- Never use Active Parking Assist when snow chains are installed.
- Make sure that the tire pressures are always correct. This has a direct influence on the parking characteristics of the vehicle.

General notes

Active Parking Assist is an electronic parking aid with ultrasound. Ultrasound is used to measure the road on both sides of the vehicle. A suitable parking space is indicated by the parking symbol. Active steering intervention can assist you during parking.

You may also use PARKTRONIC (> page 213). When PARKTRONIC is switched off, Active Parking Assist is also unavailable. Use Active Parking Assist for parking spaces:

- that are parallel to the direction of travel
- that are on straight roads, not bends
- that are on the same level as the road, e.g. not on the pavement

Detecting parking spaces

WARNING

If there are objects above the detection range, Active Parking Assist may turn prematurely. You may cause a collision as a result. There is a risk of an accident.

If there are objects above the detection range, stop and deactivate Active Parking Assist.

Objects located above the height range of Active Parking Assist will not be detected when the parking space is measured. These are not taken into account when the parking procedure is calculated, e.g. overhanging loads, tail sections or loading ramps of goods vehicles. In some circumstances, Active Parking Assist may therefore guide you into the parking space too early.

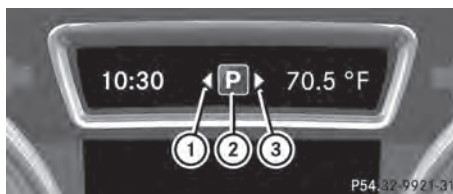

- ① Detected parking space on the left
- ② Parking symbol
- ③ Detected parking space on the right

Active Parking Assist is switched on automatically when driving forwards. The system is operational at speeds of up to approximately 22 mph (35 km/h). While in operation, the system independently locates and measures parking spaces on both sides of the vehicle. When driving at speeds below 19 mph (30 km/h), you will see the parking symbol as a status indicator in the instrument cluster. By default, Active Parking Assist only displays parking spaces on the front-passenger side. Parking spaces on the driver's side are displayed as soon as the turn signal on the driver's side is activated. To park on the driver's side, you must leave the driver's side turn signal switched on. This must remain switched on until you acknowledge the use of Active Parking Assist by pressing the **OK** button on the multifunction steering wheel.

When a parking space has been detected, an arrow towards the right or the left also appears.

Active Parking Assist will only detect parking spaces:

- that are parallel to the direction of travel
- that are at least 59 in (1.5 m) wide
- that are at least 51 in (1.3 m) longer than your vehicle





A parking space is displayed while you are driving past it, and until you are approximately 50 ft (15 m) away from it.

Parking

WARNING

Active Parking Assist merely aids you by intervening actively in the steering. If you do not brake there is a risk of an accident.

Always apply the brakes yourself when maneuvering and parking.

- ▶ Stop the vehicle when the parking space symbol shows the desired parking space in the instrument cluster.
 - ▶ Shift the transmission to position **R**. The **Start Park Assist? Yes: OK No: ** message appears in the multifunction display.
 - ▶ **To cancel the procedure:** press the  button on the multifunction steering wheel or pull away.
- or
- ▶ **To park using Active Parking Assist:** press the  button on the multifunction steering wheel. The **Park Assist active Accelerate and brake Observe surroundings** message appears in the multifunction display.
 - ▶ Let go of the multifunction steering wheel.
 - ▶ Back up the vehicle, being ready to brake at all times. When backing up, drive at a speed below approximately 6 mph (10 km/h). Otherwise Active Parking Assist will be canceled.
-  In tight parking spaces, you will achieve the best parking results by backing up as

far as possible. When doing so, also observe the PARKTRONIC messages.

- ▶ Stop as soon as PARKTRONIC sounds the continuous warning tone, if not before. Maneuvering may be required in tight parking spaces.

The **Park Assist active Select D Observe surroundings** message appears in the multifunction display.

- ▶ Shift the transmission to position **D** while the vehicle is stationary. Active Parking Assist immediately steers in the other direction.

The **Park Assist active Accelerate and brake Observe surroundings** message appears in the multifunction display.

-  You will achieve the best results by waiting for the steering procedure to complete before pulling away.
- ▶ Drive forwards and be ready to brake at all times.
- ▶ Stop as soon as PARKTRONIC sounds the continuous warning tone, if not before.

The **Park Assist active Select R Observe surroundings** message appears in the multifunction display.

Further transmission shifts may be necessary.

As soon as the parking procedure is complete, the **Park Assist switched off** message appears in the multifunction display. PARKTRONIC is still available.

- ▶ Maneuver if necessary.
- ▶ Always observe the warning messages displayed by PARKTRONIC (▷ page 215).

Parking tips:

- The way your vehicle is positioned in the parking space after parking is dependent on various factors. These include the position and shape of the vehicles parked in front and behind it and the conditions of the location. It may be the case that Active Parking Assist guides you too far into a

parking space, or not far enough into it. In some cases, it may also lead you across or onto the curb. If necessary, you should cancel the parking procedure with Active Parking Assist.

- You can also engage forward gear prematurely. The vehicle redirects and does not drive as far into the parking space. Should the gear change occur too soon to achieve a sensible parking position, the parking procedure will be aborted.
- You can intervene in the steering procedure to correct it at any time. Active Parking Assist will then be canceled.

Exiting a parking space

WARNING

Active Parking Assist does not monitor street traffic. In some cases, the vehicle will also take you onto sections of the oncoming lane when exiting a parking space.

You are responsible for safety at all times and must pay attention to any road users approaching or passing. Stop the vehicle if necessary or cancel Active Parking Assist.

Active Parking Assist can only assist you with exiting a parking space if you have parked the vehicle using Active Parking Assist.

- ▶ Start the engine.
- ▶ Switch on the turn signal on the side facing the street.
- ▶ Shift the transmission to position **D** or **R**. The **Start Park Assist? Yes: OK No: ** message appears in the multifunction display.

- ▶ **To cancel the procedure:** press the  button on the multifunction steering wheel or pull away.

or

- ▶ **To exit a parking space using Active Parking Assist:** press the  button on the multifunction steering wheel. The **Park Assist Active Accelerate and Brake Observe Surroundings**

message appears in the multifunction display.

- ▶ Let go of the multifunction steering wheel.
- ▶ Reverse the vehicle or drive forwards, being ready to brake at all times. Do not exceed a maximum speed of approximately 6 mph (10 km/h) when exiting a parking space. Otherwise, Active Parking Assist will be deactivated.
- ▶ Stop as soon as PARKTRONIC sounds the continuous warning tone, if not before.
- ▶ Shift the transmission to position **D** or **R** as required while the vehicle is stationary. Active Parking Assist immediately steers in the other direction.

- i** You will achieve the best results by waiting for the steering procedure to complete before pulling away.

If you back up after activation, the steering wheel is moved to the straight-ahead position.

- ▶ Drive forwards or back up the vehicle, being ready to brake at all times.
- ▶ Stop as soon as PARKTRONIC sounds the continuous warning tone, if not before.
- ▶ Drive forwards and back up as instructed by the PARKTRONIC warning displays.

Once you have exited the parking space completely, the steering wheel is moved to the straight-ahead position. You hear a tone and the message **Park Assist Finished** appears in the multifunction display. You will then have to steer and merge into traffic on your own. PARKTRONIC is still available.

Canceling Active Parking Assist

- ▶ Stop the movement of the multifunction steering wheel or steer yourself. Active Parking Assist will be canceled at once. The **Park Assist Canceled**

message appears in the multifunction display.

or

- ▶ Press the PARKTRONIC button on the center console (▶ page 215). PARKTRONIC is switched off and Active Parking Assist is immediately canceled. The **Park Assist Canceled** message appears in the multifunction display.

Active Parking Assist is canceled automatically if:

- parking using Active Parking Assist is no longer possible.
- you are driving faster than 6mph (10 km/h).
- a wheel spins, ESP® intervenes or fails. The  warning lamp lights up in the instrument cluster.

A warning tone sounds. The parking symbol disappears and the multifunction display shows the **Park Assist Canceled** message.

When Active Parking Assist is canceled, you must steer again yourself.

Towing a trailer

For vehicles with a trailer tow hitch, the minimum length for parking spaces is slightly increased.

If you have attached a trailer to your vehicle, you should not use Active Parking Assist. Once the electrical connection is established between your vehicle and the trailer, Active Parking Assist is no longer available. PARKTRONIC is deactivated for the rear area.

Rear view camera

Important safety notes

The rear view camera is only an aid. It is not a replacement for your attention to your immediate surroundings. You are always responsible for safe maneuvering and parking. When maneuvering or parking, make

sure that there are no persons, animals or objects in the area in which you are maneuvering.

Under the following circumstances, the rear view camera will not function, or will function in a limited manner:

- the tailgate is open
- in heavy rain, snow or fog
- at night or in very dark places
- if the camera is exposed to very bright light
- if the area is lit by fluorescent light or LED lighting (the display may flicker)
- if there is a sudden change in temperature, e.g. when driving into a heated garage in winter
- if the camera lens is dirty or obstructed
- if the rear of your vehicle is damaged. In this event, have the camera position and setting checked at a qualified specialist workshop.

General notes



Rear view camera ① is in the handle on the tailgate.

Rear view camera ① is an optical parking and maneuvering aid. It shows the area behind your vehicle with guide lines in the COMAND display.

The area behind the vehicle is displayed as a mirror image, as in the rear view mirror.

- ❗ The text of messages shown in the COMAND display depends on the language setting. The following are examples of rear

view camera messages in the COMAND display.

Activating/deactivating the rear view camera

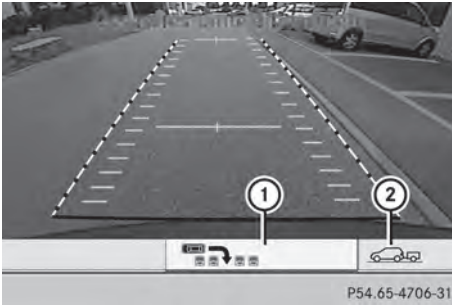

- ▶ **To activate:** make sure that the SmartKey is in position **2** in the ignition lock.
- ▶ Make sure that the function "show rear view camera display" is selected in COMAND.
- ▶ Engage reverse gear. The area behind the vehicle is shown in the COMAND display with guide lines.
- ▶ **To change the function mode for vehicles with trailer tow hitch:** using the COMAND controller, select symbol ① for the "Reverse parking" function or symbol ② for "Coupling up a trailer" (see the separate COMAND operating instructions). The symbol of the selected function is highlighted.

To deactivate: the rear view camera is deactivated if you:

- shift the transmission to position **P**
- drive forwards 33 ft (10 m)
- shift the transmission from **R** to another position (after 15 seconds)
- drive forwards at a speed of over 5 mph (10km/h)

Displays in the COMAND display

The rear view camera may show a distorted view of obstacles, show them incorrectly or not at all. The rear view camera does not show objects in the following positions:

- very close to the rear bumper
- under the rear bumper
- in the area immediately above the tailgate handle

❗ Objects not at ground level may appear to be further away than they actually are, e.g.:

- the bumper of a parked vehicle
- the drawbar of a trailer
- the ball coupling of a trailer tow hitch
- the rear section of an HGV
- a slanted post

Use the guidelines only for orientation. Approach objects no further than the bottom-most guideline.

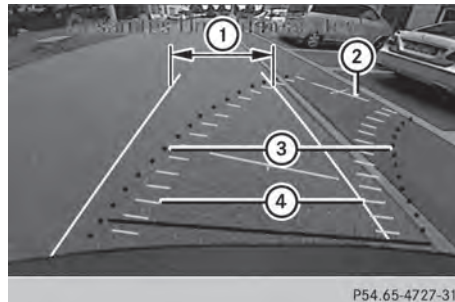

- ① White guide line without turning the steering wheel, vehicle width including the exterior mirrors (static)
- ② Yellow guide line at a distance of approximately 13 ft (4.0m) from the rear of the vehicle
- ③ Red guide line for the vehicle width including the exterior mirrors, for current steering wheel angle (dynamic)
- ④ Yellow lane marking tires at current steering wheel angle (dynamic)

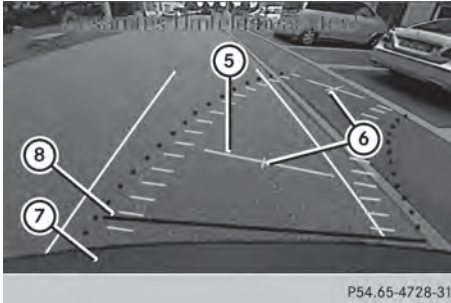

- ⑤ Yellow guide line at a distance of approximately 3 ft (1.0 m) from the rear of the vehicle
- ⑥ Vehicle center axle (marker assistance)
- ⑦ Bumper
- ⑧ Red guide line at a distance of approximately 10 in (0.25 m) from the rear of the vehicle

The guide lines are shown when the transmission is in position **R**.

The distance specifications only apply to objects that are at ground level.



Additional messages for vehicles with PARKTRONIC

- ① Front warning display
- ② Additional PARKTRONIC measurement operational readiness indicator
- ③ Rear warning display

Vehicles with PARKTRONIC: if PARKTRONIC is operational (▷ page 215), an additional operational readiness indicator will appear in COMAND display ②. If the PARKTRONIC warning displays are active or light up, warning displays ① and ③ are also

active or light up correspondingly in the COMAND display.

Reverse parking function

Backing up straight into a parking space without turning the steering wheel

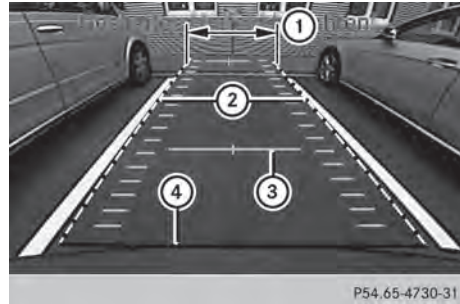

- ① White guide line without turning the steering wheel, vehicle width including the exterior mirrors (static)
- ② Red guide line for the vehicle width including the exterior mirrors, for current steering wheel angle (dynamic)
- ③ Yellow guide line at a distance of approximately 3 ft (1.0 m) from the rear of the vehicle
- ④ Red guide line at a distance of approximately 10 in (0.25 m) from the rear of the vehicle

- ▶ Make sure that the rear view camera is switched on (▷ page 222). The lane and the guide lines are shown.
- ▶ With the help of white guide line ①, check whether the vehicle will fit into the parking space.
- ▶ Using white guide line ① as a guide, carefully back up until you reach the end position. Red guide line ④ is then at the end of the parking space. The vehicle is almost parallel in the parking space.

Reverse perpendicular parking with the steering wheel at an angle



Turning the steering wheel

- ① Red guide line for the vehicle width including the exterior mirrors, for current steering wheel angle (dynamic)

- ② Parking space marking

- ▶ Make sure that the rear view camera is switched on (> page 222). The lane and the guide lines are shown.
- ▶ Drive past the parking space and bring the vehicle to a standstill.
- ▶ While the vehicle is at a standstill, turn the steering wheel in the direction of the parking space until red guide line ① reaches parking space marking ②.
- ▶ Keep the steering wheel in that position and back up carefully.



Backing up with the steering wheel turned

- ① Red guide line for the vehicle width including the exterior mirrors, for current steering wheel angle (dynamic)

- ▶ Stop the vehicle when it is almost exactly in front of the parking space. The white lane should be as close to parallel with the parking space marking as possible.



Driving to the final position

- ① White guide line at current steering wheel angle

- ② Parking space marking

- ▶ Turn the steering wheel to the center position while the vehicle is stationary.

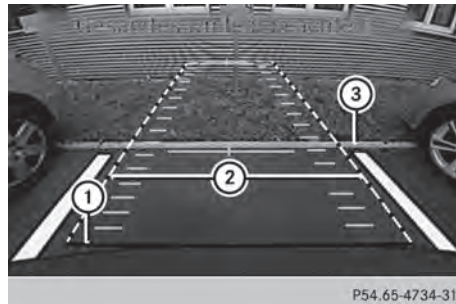

- ① Red guide line at a distance of approximately 10 in (0.25 m) from the rear of the vehicle

- ② White guide line without turning the steering wheel

- ③ End of parking space

- ▶ Back up carefully until you have reached the final position.

Red guide line ① is then at end of parking space ③. The vehicle is almost parallel in the parking space.

"Coupling up a trailer" function

! The following distance specifications refer to trailer tow hitches with ball coupling that have been approved for this vehicle by Mercedes-Benz. Distances may differ if you use other ball couplings. In this case, take into account that actual distances will not match the following distance specifications. Otherwise you could damage the trailer and vehicle.

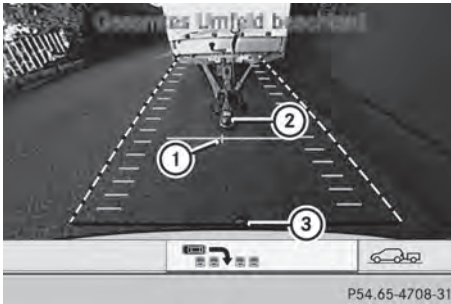

- ① Vehicle center point on the yellow guide line at a distance of approximately 3 ft (1 m) from the rear of the vehicle
- ② Trailer drawbar
- ③ Ball coupling

This function is only available on vehicles with a trailer tow hitch.

- ▶ Set the height of trailer drawbar ② so that it is slightly higher than ball coupling ③.
- ▶ Position the vehicle centrally in front of trailer drawbar ②.

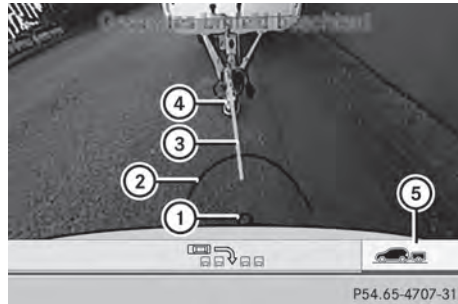

- ① Ball coupling
- ② Red guide line at a distance of approximately 10 in (0.25 m) from the ball coupling
- ③ Trailer drawbar marker assistant
- ④ Trailer drawbar
- ⑤ Symbol for the "Coupling up a trailer" function

- ▶ Use the COMAND controller to select symbol ⑤, see the separate operating instructions for COMAND. The "Coupling up a trailer" function is selected. The distance specifications now only apply to objects that are at the same level as the ball coupling.
- ▶ Reverse carefully, making sure that trailer drawbar marker assistant ③ points approximately in the direction of trailer drawbar ④.
- ▶ Reverse carefully until trailer drawbar ④ reaches red guide line ②.
- ▶ Couple up the trailer (▷ page 253).

360° camera (surround view)

Important safety notes

The 360° camera is only an aid. It is not a replacement for your attention to your immediate surroundings. You are always responsible for safe maneuvering and parking. When maneuvering or parking, make sure that there are no persons, animals or

objects in the area in which you are maneuvering.

The 360° camera may show a distorted view of obstacles, show them incorrectly or not at all. It cannot show objects in the following areas:

- under the front bumper
- very close to the front bumper
- very close to the rear bumper
- under the rear bumper
- in close range above the handle on the trunk lid
- very close to the exterior mirrors

You are always responsible for safety, and must always pay attention to your surroundings when parking and maneuvering. This applies to the areas behind, in front of and beside the vehicle. You could otherwise endanger yourself and others.

The rear view camera will not function or will function in a limited manner:

- if the doors are open
- if the exterior mirrors are folded in
- if the trunk lid is open
- in heavy rain, snow or fog
- at night or in very dark places
- if the cameras are exposed to very bright light
- if the area is lit by fluorescent light or LED lighting (the display may flicker)
- if you exit a heated garage in winter, resulting in a rapid change in temperature
- if the camera lenses are dirty or covered
- if the vehicle components in which the cameras are installed are damaged. In this event, have the camera position and setting checked at a qualified specialist workshop.

Do not use the 360° camera in this case. You can otherwise injure others or cause damage to objects or the vehicle.

General notes

The 360° camera is a system consisting of four cameras.

The system analyzes images from the following cameras:

- Rear view camera
- Front camera
- Two cameras in the exterior rear view mirrors

The cameras capture the immediate surroundings of the vehicle. The system supports you, e.g. when parking or if vision is restricted at an exit.

The 360° camera images can be shown in full screen mode or in seven different split-screen views on the COMAND display. A split-screen view also includes a top view of the vehicle. This view is calculated from the data supplied by the installed cameras (virtual camera).

The seven split-screen views are:

- top view and picture from the rear view camera (130° viewing angle)
- top view and picture from the front camera (without displaying the maximum steering wheel angle)
- top view and enlarged rear view
- top view and enlarged front view
- top view and trailer view (vehicles with trailer tow hitch)
- top view and pictures from the rearward facing mirror cameras (rear wheel view)
- top view and pictures from the forward facing mirror cameras (front wheel view)

i The top view and trailer view are available for vehicles equipped with a trailer tow hitch.

When the function is active and you shift the transmission from position **D** or **R** to **N**, you see the previous view in the COMAND display. The dynamic guidelines are hidden.

When you change between transmission positions **D** and **R**, you see the previously selected front or rear view.

Activation conditions

The 360° camera image can be displayed if:

- your vehicle is equipped with a 360° camera
- COMAND is switched on, see the separate COMAND operating instructions
- the **360° camera** function is activated

Activating the 360° camera using the SYS button

- ▶ Press and hold the **[sys]** button for longer than 2 seconds, see the separate COMAND operating instructions. Depending on whether position **D** or **R** is engaged, the following is shown:
 - full screen display with the image from the front camera
 - full screen display with the image from the rear camera

Activating the 360° camera with COMAND

- ▶ Press the **[sys]** button, see the separate COMAND operating instructions.
- ▶ Select **System** by turning **[⊙]** the COMAND controller and press **[↵]** to confirm.
- ▶ Select **360° camera** and press **[↵]** to confirm. Depending on whether position **D** or **R** is engaged, the following is shown:
 - a split screen with top view and the image from the front camera or
 - a split screen with top view and the image from the rear view camera

For further information about the COMAND Controller, see the separate COMAND operating instructions.

Activating the 360° camera using reverse gear

The 360° camera images can be automatically displayed by engaging reverse gear.

- ▶ Make sure that the SmartKey is in position **2** in the ignition lock.
- ▶ Make sure that the **Activation by R gear** setting is active in COMAND, see the separate COMAND operating instructions.
- ▶ **To show the 360° camera image:** engage reverse gear. The COMAND display shows the area behind the vehicle in split screen:
 - vehicle with guide lines
 - top view of the vehicle

Selecting the split-screen and full screen displays

- ▶ **To switch between split screen views:** switch to the line with the vehicle icons by sliding **[⊙]** the COMAND controller.
- ▶ Turn **[⊙]** the COMAND controller and select one of the vehicle symbols.
- ▶ **To switch to full screen mode:** select **Full screen** by turning **[⊙]** the COMAND controller and press **[↵]** to confirm.

Displays in the COMAND display

Important safety notes

! Objects not at ground level may appear to be further away than they actually are, e.g.:

- the bumper of a parked vehicle
- the drawbar of a trailer
- the ball coupling of a trailer tow hitch
- the rear section of an HGV
- a slanted post

Use the guidelines only for orientation. Approach objects no further than the bottom-most guideline.

Top view with picture from the rear view camera

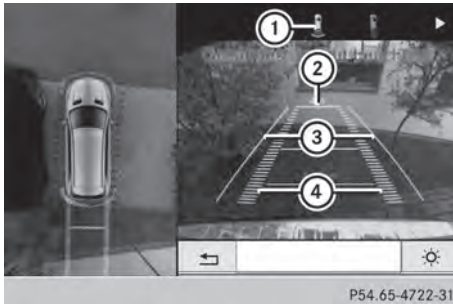

- ① Symbol for the split screen setting with top view and rear view camera image
- ② Yellow guide line at a distance of approximately 13 ft (4.0 m) from the rear of the vehicle
- ③ Yellow guide line for the vehicle width including the exterior mirrors, for current steering wheel angle (dynamic)
- ④ Yellow lane marking tires at current steering wheel angle (dynamic)

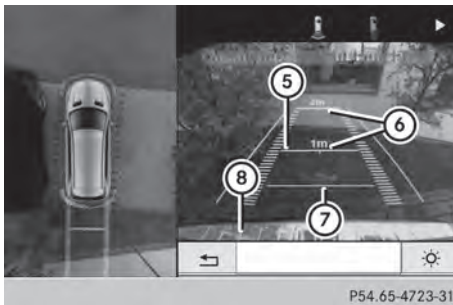

- ⑤ Yellow guide line at a distance of approximately 3 ft (1.0 m) from the rear of the vehicle
- ⑥ Vehicle center axle (marker assistance)
- ⑦ Red guide line at a distance of approximately 12 in (0.30 m) from the rear of the vehicle
- ⑧ Bumper

The guide lines are shown when the transmission is in position **R**.

The distance specifications only apply to objects that are at ground level.

Top view with picture from the front camera

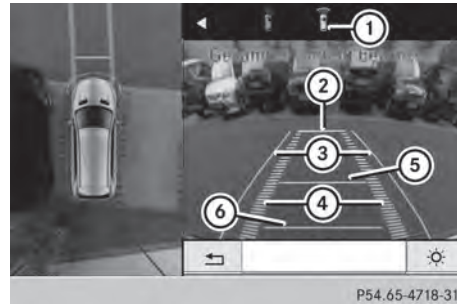

- ① Symbol for the split screen setting with top view and front camera image
- ② Yellow guide line at a distance of approximately 13 ft (4.0m) from the front of the vehicle
- ③ Yellow guide line for the vehicle width including the exterior mirrors, for current steering wheel angle (dynamic)
- ④ Yellow lane marking tires at current steering wheel angle (dynamic)
- ⑤ Yellow guide line at a distance of approximately 3 ft (1.0m) from the front of the vehicle
- ⑥ Red guide line at a distance of approximately 12 in (0.30 m) from the front of the vehicle

Top view and enlarged rear view

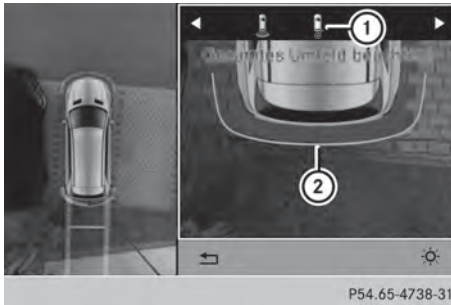

- ① Symbol for the split screen setting with top view and rear view camera image enlarged
- ② Red guide line at a distance of approximately 12 in (0.30 m) from the rear of the vehicle

This view assists you in estimating the distance to the vehicle behind you.

- i** This setting can also be selected as an enlarged front view.

Top view with picture from the mirror camera

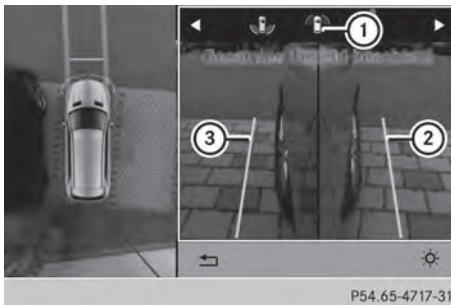

- ① Symbol for the top view and forward-facing mirror camera setting
- ② Yellow guide line for the vehicle width including the exterior mirrors (right side of vehicle)
- ③ Yellow guide line for the vehicle width including the exterior mirrors (left side of vehicle)

Top view with trailer view

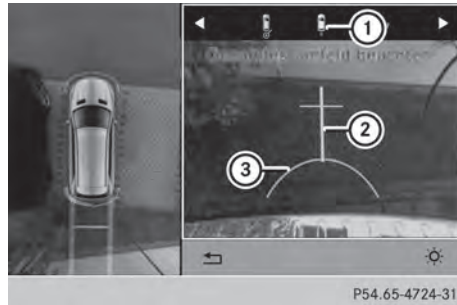

- ① Symbol for the trailer view setting
- ② Trailer drawbar marker assistant
- ③ Red guide line at a distance of approximately 12 in (0.30 m) from the ball coupling

Display with the PARKTRONIC display



Example: full screen mode with PARKTRONIC display

- ① Symbol for the full screen setting with rear view camera image



If the vehicle is equipped with PARKTRONIC and the function is active (▷ page 215), warning displays ② in the COMAND display are also active or light up accordingly.

PARKTRONIC appears:

- in split screen view as red or yellow brackets around the vehicle icon in the top view, or
- in the full screen view, on the right-hand side at the bottom as red or yellow brackets around the vehicle icon

- The full screen display can also be selected as front view.

Exiting 360° camera display mode

As soon as your vehicle exceeds a speed of 19 mph (30 km/h) with the function activated, the function switches off. The COMAND display switches back to the previously selected view. You can also switch the display by selecting the  symbol in the display and pressing  the COMAND controller.

ATTENTION ASSIST

Important safety notes

ATTENTION ASSIST is only an aid to the driver. It might not always recognize fatigue or increasing inattentiveness in time or fail to recognize them at all. The system is not a substitute for a well-rested and attentive driver.

ATTENTION ASSIST helps you during long, monotonous journeys, such as on highways. It is active in the range between 50 mph (80 km/h) and 112 mph (180 km/h).

If ATTENTION ASSIST detects typical indicators of fatigue or increasing lapses in concentration on the part of the driver, it suggests you take a break.

ATTENTION ASSIST assesses your level of fatigue or lapses in concentration by taking the following criteria into account:

- your personal driving style, e.g. steering characteristics
- journey details, e.g. time of day and length of journey



The functionality of ATTENTION ASSIST is restricted and warnings may be delayed or not occur at all:

- if the road condition is poor, e.g. if the surface is uneven or if there are potholes
- if there is a strong side wind

- if you have adopted a sporty driving style with high cornering speeds or high rates of acceleration
- if you are predominantly driving slower than 50 mph (80 km/h) or faster than 112 mph (180 km/h)
- if you are currently using COMAND or making a telephone call with it
- if the time has been set incorrectly
- in active driving situations, such as when you change lanes or change your speed

Warning and display messages in the multifunction display



- ▶ Activate ATTENTION ASSIST using the on-board computer (> page 273). Symbol  appears in the multifunction display.
- ▶ **The Attention Assist: Take a Break! message appears in the multifunction display.** If necessary, take a break.
- ▶ Press the  or  button to confirm the message.

If ATTENTION ASSIST is active, you will be warned no sooner than 20 minutes after your journey has begun. In addition to the message shown in the multifunction display, you will then hear an intermittent warning tone twice. On long journeys, take regular breaks in good time to allow yourself to rest properly. If you do not take a break and ATTENTION ASSIST still detects increasing lapses in concentration, you will be warned again after 15 minutes at the earliest.

ATTENTION ASSIST is reset when you continue your journey and starts assessing your tiredness again if:

- you switch off the engine.
- you take off your seat belt and open the driver's door, e.g. for a change of drivers or to take a break.

Night View Assist Plus

Important safety notes

Night View Assist Plus is only an aid and is not a substitute for attentive driving. Do not rely on the Night View Assist Plus display. You are responsible for the distance to the vehicle in front, for vehicle speed and for braking in good time. Drive carefully and always adapt your driving style to suit the prevailing road and traffic conditions.

The system may be impaired or may not function if:

- there is poor visibility, e.g. due to snow, rain, fog or spray
- the windshield is dirty, fogged up or covered, for instance by a sticker, in the vicinity of the camera
- on bends, on uphill gradients or downhill gradients

Pedestrian recognition may be impaired or inoperative if:

- pedestrians are partially or entirely obscured by objects, e.g. parked vehicles
- the silhouette of the pedestrian in the Night View Assist Plus display is incomplete or interrupted, e.g. by powerful light reflections
- pedestrians do not contrast adequately from the background
- pedestrians are not in an upright position, e.g. sitting, squatting or lying

General notes

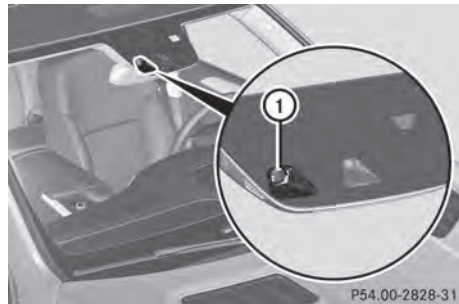

In addition to the illumination provided by the normal headlamps, Night View Assist Plus uses infrared light to illuminate the road. Night View Assist Plus camera ① picks up the infrared light and displays a monochrome image in COMAND. The image displayed in COMAND corresponds to a road lit up by high-beam headlamps. This enables you to see the road's course and any obstacles in good time. If pedestrian recognition is activated, pedestrians recognized by the system are highlighted in the Night View Assist Plus display.

Light from the headlamps of oncoming vehicles does not affect the Night View Assist Plus display in the multifunction display. This is also the case if you can't switch on the high-beam headlamps due to oncoming traffic.

- ① Infrared light is not visible to the human eye and therefore does not glare. Night View Assist Plus can therefore remain switched on even if there is oncoming traffic.

Activating Night View Assist Plus

Activation conditions

You can only activate Night View Assist Plus if:

- the SmartKey is in position **2** in the ignition lock.
- it is dark.

- the light switch is in the **AUTO** or  position.
- reverse gear has not been engaged.

Switching on Night View Assist Plus

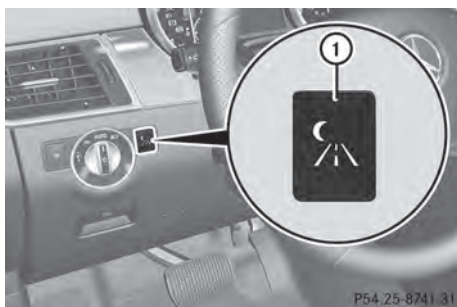

- ▶ Make sure that COMAND is switched on.
 - ▶ Press button ①.
- The Night View Assist Plus display appears in the COMAND display.

You can read about how to adjust the brightness of the COMAND display in the COMAND operating instructions.

- ❗ The infrared headlamps only switch on when the vehicle is being driven at speeds of approximately 6 mph (10 km/h). This means that you do not have the full visual range while the vehicle is stationary and cannot check whether Night View Assist Plus is working.

Pedestrian recognition

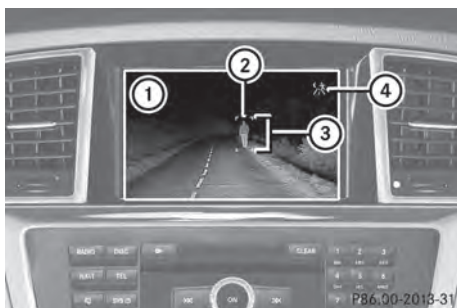

- ① Night View Assist Plus display
- ② Pedestrian recognized

- ③ Framing
- ④ Symbol for active pedestrian recognition

- ❗ Animals are not recognized by pedestrian recognition.

Night View Assist Plus is able to recognize pedestrians by typical characteristics, e.g. a silhouette in the shape of a person.

Pedestrian recognition is then switched on automatically if:

- Night View Assist Plus is activated
- you exceed a speed of approximately 6 mph (10 km/h)
- the surroundings are dark, e.g. when driving outside built-up areas without street lighting

If pedestrian recognition is active, symbol ④ appears. If pedestrians are detected, they are highlighted with framing ③. If the pedestrian recognition system has brought a pedestrian to your attention, look through the windshield to evaluate the situation. The actual distance to objects and pedestrians cannot be gaged accurately by looking at a screen.

It may be the case that objects are highlighted as well as pedestrians.

Fogged up or dirty windshield

If the windshield in front of the camera is fogged up or dirty on the inside or outside, the Night View Assist Plus display is affected.

- ▶ **To defrost:** check the automatic air conditioning settings (▷ page 149) and fold down the camera cover (▷ page 375).
- ▶ **To defrost the inside of the windshield:** fold down the camera cover (▷ page 375) and clean the windshield (▷ page 372).

Problems with Night View Assist Plus

| Problem | Possible causes/consequences and ► Solutions |
|---|---|
| The picture quality of Night View Assist Plus has deteriorated. | The windshield wipers are smearing the windshield. ► Replace the wiper blades (▷ page 133). |
| | The windshield is smeared after the vehicle has been cleaned in a car wash. ► Clean the windshield (▷ page 372). |
| | There is windshield chip damage in the camera's field of vision. ► Replace the windshield. |
| | The windshield is fogged up on the inside. ► Defrost the windshield (▷ page 149). |
| | The windshield is iced up. ► De-ice the windshield (▷ page 148). |
| | There is dirt on the inside of the windshield. ► Clean the inside of the windshield (▷ page 372). |

Lane Tracking package

General notes

The Lane Tracking package consists of Blind Spot Assist (▷ page 233) and Lane Keeping Assist (▷ page 235).

Blind Spot Assist

Important safety notes

WARNING

Blind Spot Assist does not react to:

- vehicles overtaken too closely on the side, placing them in the blind spot area
- vehicles approaching and driving by with a speed difference of more than approximately 6.8 mph (11 km/h)

As a result, Blind Spot Assist may not give warnings in such situations. There is a risk of an accident.

Always observe the traffic conditions carefully, and maintain a safe lateral distance.

Blind Spot Assist is only an aid. It may fail to detect some vehicles and is no substitute for attentive driving.

USA only:

This device has been approved by the FCC as a "Vehicular Radar System". The radar sensor is intended for use in an automotive radar system only. Removing, tampering with, or altering the device will void any warranties, and is not permitted by the FCC. Do not tamper with, alter, or use in any non-approved way.

Any unauthorized modification to this device could void the user's authority to operate the equipment.

General notes

Blind Spot Assist uses a radar sensor system to monitor the areas on both sides of your vehicle. It supports you from a speed of approximately 20 mph (30 km/h). A warning display in the exterior mirrors draws your attention to vehicles detected in the

monitored area. If you then switch on the corresponding turn signal to change lanes, you will also receive a visual and audible collision warning. Blind Spot Assist uses sensors in the rear bumper for monitoring purposes.

For Blind Spot Assist to assist you when driving, the radar sensor system must be:

- activated (▷ page 277)
- operational

Monitoring range of the sensors

In particular, the detection of obstacles can be impaired if:

- dirt on the sensors or anything else covering the sensors
- poor visibility, e.g. due to fog, heavy rain, snow or spray
- narrow vehicles, e.g. motorcycles or bicycles
- the road has very wide lanes
- the road has narrow lanes
- you are not driving in the middle of the lane
- there are barriers or similar lane borders

Vehicles in the monitoring range are then not indicated.

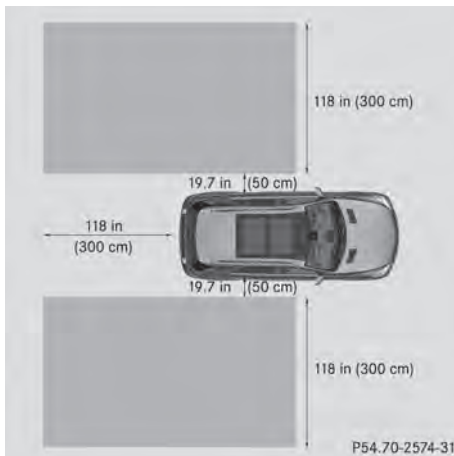

Blind Spot Assist monitors the area up to 10 ft (3m) behind your vehicle and directly next to your vehicle, as shown in the diagram.

If the lanes are narrow, vehicles driving in the lane beyond the lane next to your vehicle may be indicated, especially if the vehicles are not driving in the middle of their lane. This may be the case if there are vehicles driving at the inner edge of their lanes.

Due to the nature of the system:

- warnings may be issued in error when driving close to crash barriers or similar solid lane borders.
- the warning is canceled when driving for an extended period next to long vehicles, such as trucks.

The two radar sensors for Blind Spot Assist are integrated into the sides of the rear bumper. Make sure that the bumper is free of dirt, ice or slush in the vicinity of the sensors. The sensors must not be covered, for example by cycle racks or overhanging loads. Following a severe impact or in the event of damage to the bumpers, have the condition of the radar sensors checked at a qualified specialist workshop. Blind Spot Assist may otherwise not work properly.

Indicator and warning display

Blind Spot Assist is not active at speeds below approximately 20 mph (30 km/h). Vehicles in the monitoring range are then not indicated.

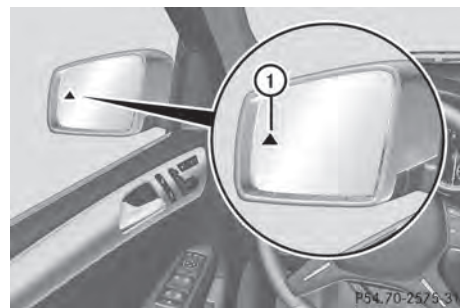

① Yellow indicator lamp/red warning lamp

When Blind Spot Assist is activated, indicator lamp ① in the exterior mirrors lights up yellow at speeds of up to 20 mph (30 km/h). At speeds above 20 mph (30 km/h) the

indicator lamp goes out and Blind Spot Assist is operational.

If a vehicle is detected within the monitoring range of Blind Spot Assist at speeds above 20 mph (30km/h), warning lamp ① on the corresponding side lights up red. This warning is always emitted when a vehicle enters the blind spot monitoring range from behind or from the side. When you overtake a vehicle, the warning only occurs if the difference in speed is less than 7 mph (12km/h).

The yellow indicator lamp goes out if reverse gear is engaged. In this event, Blind Spot Assist is no longer active.

The brightness of the indicator/warning lamps is adjusted automatically according to the ambient light.

Collision warning

If a vehicle is detected in the monitoring range of Blind Spot Assist and you switch on the corresponding turn signal, a double warning tone sounds. Red warning lamp ① flashes. If the turn signal remains on, vehicles detected are indicated by the flashing of red warning lamp ①. There are no further warning tones.

Switching on Blind Spot Assist

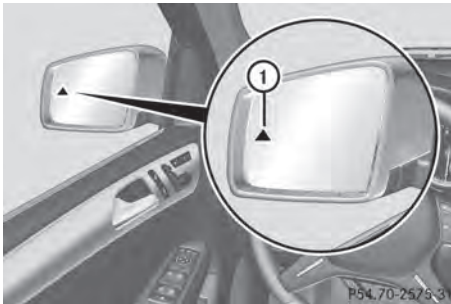

- ▶ Make sure that the radar sensor system (▷ page 277) and Blind Spot Assist

(▷ page 273) are activated in the on-board computer.

- ▶ Turn the SmartKey to position **2** in the ignition lock.
Warning lamps ① in the exterior mirrors light up red for approximately 1.5 seconds and then turn yellow.

Towing a trailer

When you attach a trailer, make sure you have correctly established the electrical connection. This can be accomplished by checking the trailer lighting. In this event, Blind Spot Assist is deactivated. The indicator lamp in the exterior mirrors lights up yellow, and the **Blind Spot Assist Currently Unavailable See Operator's Manual** message appears in the multifunction display.

- i** You can deactivate the indicator lamps in the exterior mirrors.

To do so, switch off Blind Spot Assist when:

- the SmartKey is in position **2** in the ignition lock
- the engine is not running
- the electrical connection to the trailer has been established

Lane Keeping Assist

Important safety notes

WARNING

Lane Keeping Assist may not always clearly recognize lane markings.

In this case, Lane Keeping Assist may:

- give an unnecessary warning
- not give a warning

There is a risk of an accident.

Always pay particular attention to the traffic situation and stay in lane, in particular if warned by Lane Keeping Assist.

⚠ WARNING

The Lane Keeping Assist warning does not return the vehicle to the original lane. There is a risk of an accident.

You should always steer, brake or accelerate yourself, in particular if warned by Lane Keeping Assist.

If you fail to adapt your driving style, Lane Keeping Assist can neither reduce the risk of an accident nor override the laws of physics. Lane Keeping Assist cannot take into account the road, traffic and weather conditions. Lane Keeping Assist is merely an aid. You are responsible for the distance to the vehicle in front, for vehicle speed, for braking in good time and for staying in your lane.

The Lane Keeping Assist does not keep the vehicle in the lane.

The system may be impaired or may not function if:

- there is poor visibility, e.g. due to insufficient illumination of the road, or due to snow, rain, fog or spray
- there is glare, e.g. from oncoming traffic, the sun or reflections (e.g. when the road surface is wet)
- the windshield is dirty, fogged up, damaged or covered, for instance by a sticker, in the vicinity of the camera
- there are no, several or unclear lane markings for a lane, e.g. in areas with road construction work
- the lane markings are worn away, dark or covered up, e.g. by dirt or snow
- the distance to the vehicle in front is too small and the lane markings thus cannot be detected
- the lane markings change quickly, e.g. lanes branch off, cross one another or merge
- the road is narrow and winding
- there are strong shadows cast on the lane

General notes

Lane Keeping Assist monitors the area in front of your vehicle by means of a camera at the top of the windshield. Lane Keeping Assist detects lane markings on the road and warns you before you leave your lane unintentionally.

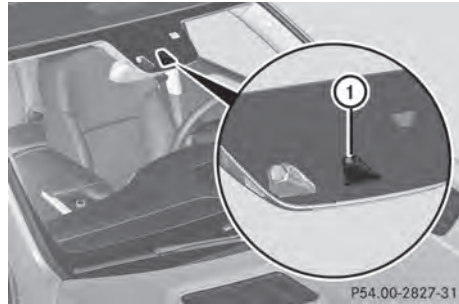

① Lane Keeping Assist camera

If you select **km** on the on-board computer in the **Display Unit Speed-/Odometer** function (▷ page 274), Lane Keeping Assist is active starting at a speed of 60 km/h. If the **miles** display unit is selected, the assistance range begins at 40 mph.

A warning may be given if a front wheel passes over a lane marking. It will warn you by means of intermittent vibration in the steering wheel for up to 1.5 seconds.

Switching on Lane Keeping Assist

- ▶ Switch on Active Lane Keeping Assist using the on-board computer; to do so, select **Standard** or **Adaptive** (▷ page 273). Symbol ① appears in the multifunction display.

If you drive at speeds above 40 mph (60 km/h) and lane markings are detected,

symbol ① is shown in green. Lane Keeping Assist is ready for use.

Standard

If **Standard** is selected, no warning vibration occurs if:

- you switch on the turn signals. In this event, the warnings are suppressed for a certain period of time.
- a driving safety system intervenes, such as ABS, BAS or ESP®.

Adaptive

If **Adaptive** is selected, no warning vibration occurs if:

- you switch on the turn signals. In this event, the warnings are suppressed for a certain period of time.
- a driving safety system intervenes, e.g. ABS, BAS or ESP®.
- you accelerate hard, e.g. kickdown.
- you brake hard.
- you steer actively, e.g. swerve to avoid an obstacle or change lanes quickly.
- you cut the corner on a sharp bend.

In order that you are warned only when necessary and in good time if you cross the lane marking, the system recognizes certain conditions and warns you accordingly.

The warning vibration occurs earlier if:

- you approach the outer lane marking on a bend.
- the road has very wide lanes, e.g. a highway.
- the system recognizes solid lane markings.

The warning vibration occurs later if:

- the road has narrow lanes.
- you cut the corner on a bend.

Active Driving Assistance package

General notes

The Active Driving Assistance package consists of DISTRONIC PLUS (▷ page 194), Active Blind Spot Assist (▷ page 237) and Active Lane Keeping Assist (▷ page 241).

Active Blind Spot Assist

General notes

Active Blind Spot Assist uses a radar sensor system to monitor the side areas of your vehicle which are behind the driver. A warning display in the exterior mirrors draws your attention to vehicles detected in the monitored area. If you then switch on the corresponding turn signal to change lane, you will also receive an optical and audible warning. If a risk of lateral collision is detected, corrective braking may help you avoid a collision. To support the course-correcting brake application, Active Blind Spot Assist uses the forward-facing radar sensor system. The free space in the direction of travel is then evaluated.

Active Blind Spot Assist supports you from a speed of approximately 20 mph (30 km/h).

For Active Blind Spot Assist to assist you when driving, the radar sensor system must be:

- activated (▷ page 277)
- operational

Important safety notes

Active Blind Spot Assist is only an aid. It may fail to detect some vehicles and is no substitute for attentive driving.

WARNING

Active Blind Spot Assist does not react to:

- vehicles overtaken too closely on the side, placing them in the blind spot area
- vehicles approaching and driving by with a speed difference of more than approximately 6.8 mph (11 km/h)

As a result, Active Blind Spot Assist may neither give warnings nor intervene in such situations. There is a risk of an accident. Always observe the traffic conditions carefully, and maintain a safe lateral distance.

i USA only: This device has been approved by the FCC as a "Vehicular Radar System". The radar sensor is intended for use in an automotive radar system only. Removal, tampering, or altering of the device will void any warranties, and is not permitted by the FCC. Do not tamper with, alter, or use in any non-approved way.

Any unauthorized modification to this device could void the user's authority to operate the equipment.

i Canada only: This device complies with RSS-210 of Industry Canada. Operation is subject to the following two conditions:

1. This device may not cause harmful interference, and
2. this device must accept any interference received, including interference that may cause undesired operation of the device.

Removal, tampering, or altering of the device will void any warranties, and is not permitted. Do not tamper with, alter, or use in any non-approved way.

Any unauthorized modification to this device could void the user's authority to operate the equipment.

Monitoring area

In particular, the detection of obstacles can be impaired if:

- dirt on the sensors or anything else covering the sensors
- poor visibility, e.g. due to fog, heavy rain, snow or spray
- narrow vehicles, e.g. motorcycles or bicycles
- the road has very wide lanes
- the road has narrow lanes

- you are not driving in the middle of the lane
 - there are barriers or similar lane borders
- Vehicles in the monitoring range are then not indicated.

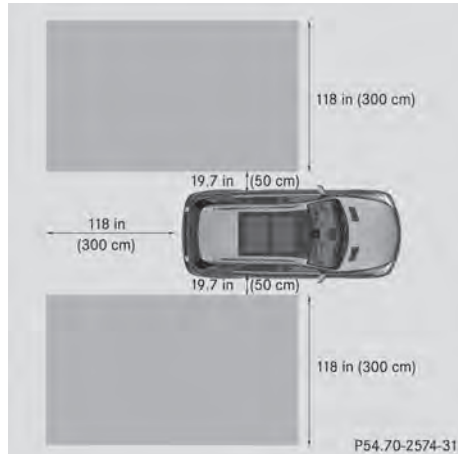

Active Blind Spot Assist monitors the area up to 10 ft (3.0 m) behind your vehicle and directly next to your vehicle, as shown in the diagram. For this purpose, Active Blind Spot Assist uses radar sensors in the rear bumper. If the lanes are narrow, vehicles driving in the lane beyond the lane next to your vehicle may be indicated, especially if the vehicles are not driving in the middle of their lane. This may be the case if there are vehicles at the inner edge of your lane.

Due to the nature of the system:

- warnings may be issued in error when driving close to crash barriers or similar solid lane borders.
- warnings may be interrupted when driving alongside particularly long vehicles, e.g. trucks, for a prolonged time.

The Active Blind Spot Assist radar sensors are integrated into the front and rear bumpers and behind a cover in the radiator grill. Make sure that the bumpers and the cover in the radiator grill are free of dirt, ice or slush. The rear sensors must not be covered, for example by cycle racks or overhanging cargo. Following a severe impact or in the event of

damage to the bumpers, have the function of the radar sensors checked at a qualified specialist workshop. Active Blind Spot Assist may otherwise no longer work properly.

Indicator and warning display

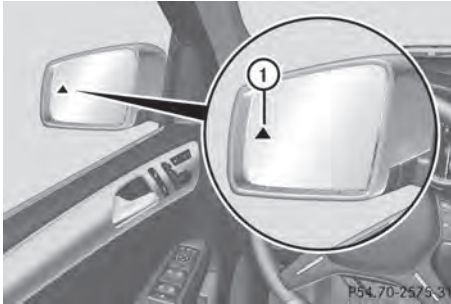

① Yellow indicator lamp/red warning lamp

Active Blind Spot Assist is not active at speeds below approximately 20 mph (30 km/h). Vehicles in the monitoring range are then not indicated.

When Active Blind Spot Assist is activated, indicator lamp ① in the exterior mirrors lights up yellow at speeds of up to 20 mph (30 km/h). At speeds above 20 mph (30 km/h), the indicator lamp goes out and Active Blind Spot Assist is operational.

If a vehicle is detected within the monitoring range of Blind Spot Assist at speeds above 20 mph (30 km/h), warning lamp ① on the corresponding side lights up red. This warning is always emitted when a vehicle enters the blind spot monitoring range from behind or from the side. When you overtake a vehicle, the warning only occurs if the difference in speed is less than 7 mph (12 km/h).

The yellow indicator lamp goes out if reverse gear is engaged. In this event, Active Blind Spot Assist is no longer active.

The brightness of the indicator/warning lamps is adjusted automatically according to the ambient light.

Visual and acoustic collision warning

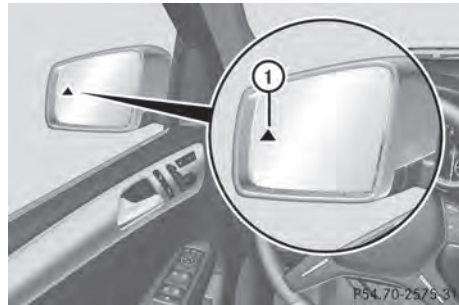

If you switch on the turn signals to change lanes and a vehicle is detected in the side monitoring range, you receive a visual and acoustic collision warning. You then hear a double warning tone and red warning lamp ① flashes. If the turn signal remains on, detected vehicles are indicated by the flashing of red warning lamp ①. There are no further warning tones.

Course-correcting brake application

WARNING

A course-correcting brake application cannot always prevent a collision. There is a risk of an accident.

Always steer, brake or accelerate yourself, especially if Active Blind Spot Assist warns you or makes a course-correcting brake application. Always maintain a safe distance at the sides.

WARNING

Active Blind Spot Assist does not detect all traffic situations and road users. In very rare cases, the system may make an inappropriate brake application. There is a risk of an accident.

An inappropriate brake application may be interrupted at any time if you steer slightly in the opposite direction or accelerate. Always make sure that there is sufficient distance on the side for other traffic or obstacles.

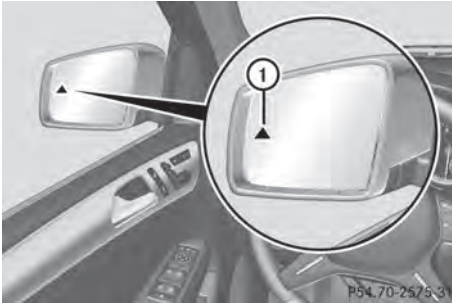

If Active Blind Spot Assist detects a risk of a lateral collision in the monitoring range, a course-correcting brake application is carried out. This is meant to assist you in avoiding a collision.

If a course-correcting brake application occurs, red warning lamp ① flashes in the exterior mirror and a dual warning tone sounds. In addition, display ② appears in the multifunction display.

The course-correcting brake application is available in the speed range between 20 mph (30 km/h) and 120 mph (200km/h).

Either no braking application, or a course-correcting brake application adapted to the driving situation occurs if:

- there are vehicles or obstacles, e.g. crash barriers, located on both sides of your vehicle.
- a vehicle approaches you too closely at the side.
- you have adopted a sporty driving style with high cornering speeds.
- you clearly brake or accelerate.

- a driving safety system intervenes, e.g. ESP® or PRE-SAFE® Brake.
- ESP® is switched off.
- the off-road program is activated (vehicles without the ON&OFFROAD package).
- off-road program 1 or 2 is activated (vehicles with the ON&OFFROAD package).
- the LOW RANGE off-road gear is activated (vehicles with the ON&OFFROAD package).
- a loss of tire pressure or a defective tire is detected.

Switching on Active Blind Spot Assist

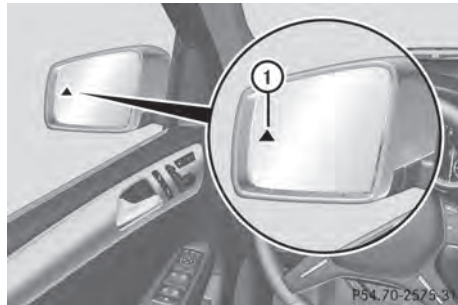

- ▶ Make sure that the radar sensor system (▷ page 277) and Active Blind Spot Assist (▷ page 273) are activated in the on-board computer.
- ▶ Turn the SmartKey to position 2 in the ignition lock.
Warning lamps ① in the exterior mirrors light up red for approximately 1.5 seconds and then turn yellow.

Towing a trailer

When you attach a trailer, make sure you have correctly established the electrical connection. This can be accomplished by checking the trailer lighting. Active Blind Spot Assist is then deactivated. The indicator lamp lights up yellow in the exterior mirrors and the **Active Blind Spot Assist Currently Unavailable See Operator's Manual** message appears in the multifunction display.

Active Lane Keeping Assist

General notes

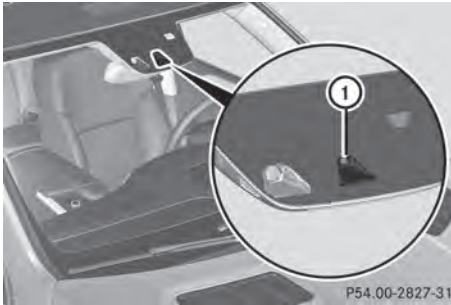

Active Lane Keeping Assist monitors the area in front of your vehicle by means of camera ① at the top of the windshield. Active Lane Keeping Assist detects lane markings on the road and warns you before you leave your lane unintentionally. If you do not react to the warning, a lane-correcting application of the brakes can bring the vehicle back into the original lane.

If you select **km** on the on-board computer in the **Display Unit Speed-/Odometer** function (▷ page 274), Active Lane Keeping Assist is activated starting at a speed of 60 km/h. If the **miles** display unit is selected, the assistance range begins at 40 mph.

Important safety notes

If you fail to adapt your driving style, Active Lane Keeping Assist can neither reduce the risk of accident nor override the laws of physics. Lane Keeping Assist cannot take into account the road, traffic and weather conditions. Lane Keeping Assist is merely an aid. You are responsible for the distance to the vehicle in front, for vehicle speed, for braking in good time and for staying in your lane.

Active Lane Keeping Assist cannot continuously keep your vehicle in its lane.

WARNING

Active Lane Keeping Assist cannot always clearly detect lane markings.

In such cases, Active Lane Keeping Assist can:

- give an unnecessary warning and then make a course-correcting brake application to the vehicle
- not give a warning or intervene

There is a risk of an accident.

Always pay particular attention to the traffic situation and keep within the lane, especially if Active Lane Keeping Assist alerts you.

Terminate the intervention in a non-critical driving situation.

The system may be impaired or may not function if:

- there is poor visibility, e.g. due to insufficient illumination of the road, or due to snow, rain, fog or spray
- there is glare, e.g. from oncoming traffic, the sun or reflections (e.g. when the road surface is wet)
- the windshield is dirty, fogged up, damaged or covered, for instance by a sticker, in the vicinity of the camera
- there are no, several or unclear lane markings for a lane, e.g. in areas with road construction work
- the lane markings are worn away, dark or covered up, e.g. by dirt or snow
- the distance to the vehicle in front is too small and the lane markings thus cannot be detected
- the lane markings change quickly, e.g. lanes branch off, cross one another or merge
- the road is narrow and winding
- there are highly variable shade conditions on the roadway
- no vehicle is detected in the adjacent lane and there are broken lane markings

Warning vibration in the steering wheel

A warning may be given if a front wheel passes over a lane marking. It will warn you

by means of intermittent vibration in the steering wheel for up to 1.5 seconds.

In order that you are warned only when necessary and in good time if you cross the lane marking, the system recognizes certain conditions and warns you accordingly.

The warning vibration occurs earlier if:

- you approach the outer lane marking on a bend.
- the road has very wide lanes, e.g. a freeway.
- the system recognizes solid lane markings.

The warning vibration occurs later if:

- the road has narrow lanes.
- you cut the corner on a bend.

Lane-correcting brake application

WARNING

A lane-correcting brake application cannot always bring the vehicle back into the original lane. There is a risk of an accident.

Always steer, brake or accelerate yourself, especially if Active Lane Keeping Assist warns you or makes a lane-correcting brake application.

WARNING

Active Lane Keeping Assist does not detect traffic conditions or road users. In very rare cases, the system may make an inappropriate brake application, e.g. after intentionally driving over a solid lane marking. There is a risk of an accident.

An inappropriate brake application may be interrupted at any time if you steer slightly in the opposite direction. Always make sure that there is sufficient distance on the side for other traffic or obstacles.



If a lane-correcting brake application occurs, display ① appears in the multifunction display.

If you leave your lane, under certain circumstances the vehicle will brake briefly on one side. This is meant to assist you in bringing the vehicle back to the original lane. This function is available in the range between 40 mph and 120 mph (60 km/h and 200 km/h).

A lane-correcting brake application can only be made after driving over a solid, recognizable lane marking. Before this, a warning must be given by means of intermittent vibration in the steering wheel. In addition, a lane with lane markings on both sides must be recognized. The brake application also slightly reduces vehicle speed.

i A further lane-correcting brake application can only occur after your vehicle has returned to the original lane.

No lane-correcting brake application occurs if:

- you clearly and actively steer, brake or accelerate.
- you cut the corner on a sharp bend.
- you have switched on the turn signal.
- a driving safety system intervenes, e.g. ESP®, PRE-SAFE® Brake or Active Blind Spot Assist.
- you have adopted a sporty driving style with high cornering speeds or high rates of acceleration.

- ESP® is switched off.
- the transmission is not in position **D**.
- on vehicles with a trailer tow hitch, the electrical connection to the trailer has been correctly established.
- the off-road program is activated (vehicles without the ON&OFFROAD package).
- off-road program 1 or 2 is activated (vehicles with the ON&OFFROAD package).
- the LOW RANGE off-road gear is activated (vehicles with the ON&OFFROAD package).
- a loss of tire pressure or a defective tire has been detected and displayed.

Active Lane Keeping Assist does not detect traffic situations or road users. An inappropriate brake application may be interrupted at any time if you:

- steer slightly in the opposite direction
- switch on the turn signal
- clearly brake or accelerate

A lane-correcting brake application is interrupted automatically if:

- a driving safety system intervenes, e.g. ESP®, PRE-SAFE® Brake or Active Blind Spot Assist.
- lane markings can no longer be recognized.

Switching on Active Lane Keeping Assist



- ▶ Switch on Active Lane Keeping Assist using the on-board computer; to do so, select **Standard** or **Adaptive** (▷ page 273). Symbol ① appears in the multifunction display.

If **Standard** is selected, no warning vibration occurs if:

- you switch on the turn signals. In this event, the warnings are suppressed for a certain period of time.
- a driving safety system intervenes, such as ABS, BAS or ESP®.

If **Adaptive** is selected, no warning vibration occurs if:

- you switch on the turn signals. In this event, the warnings are suppressed for a certain period of time.
- a driving safety system intervenes, e.g. ABS, BAS or ESP®.
- you accelerate hard, e.g. kickdown.
- you brake hard.
- you steer actively, e.g. swerve to avoid an obstacle or change lanes quickly.
- you cut the corner on a sharp bend.

Towing a trailer

When you attach a trailer, make sure you have correctly established the electrical connection. This can be accomplished by checking the trailer lighting.

On-road programs (vehicles with the ON&OFFROAD package)

General notes

The on-road programs assist you during on-road driving and the off-road programs when driving off-road (▷ page 248).

The following program messages remain in the multifunction display until the corresponding vehicle level has been set. Up to off-road level 2, you can hide the program messages using the  or **OK** button on the multifunction steering wheel.

AUTO program

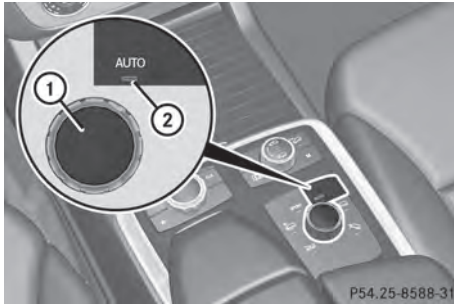

Select the AUTO program for a more comfortable ride under all normal driving conditions.

Your selection remains stored even if you remove the SmartKey from the ignition lock.

- ▶ **Selector wheel ① engaged:** briefly press selector wheel ①.
Selector wheel ① extends.
- ▶ **To select:** turn selector wheel ① until indicator lamp ② comes on.
AUTO indicator ③ appears in the multifunction display.
 - Highway level is set.
 - ADS (Adaptive Damping System) adapts comfortable damping characteristics to the current operating and driving conditions.
 - The automatic transmission selects the automatic drive program for a comfortable driving style that provides for optimum fuel consumption.

SPORT program

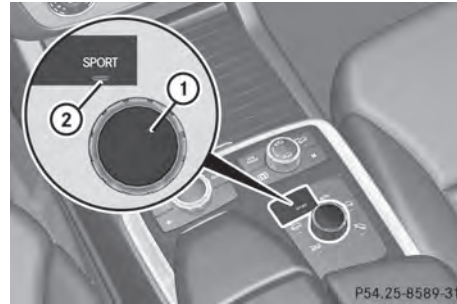

Select the SPORT program for sporty, dynamic handling.

Your selection remains stored even if you remove the SmartKey from the ignition lock.

- ▶ **Selector wheel ① engaged:** briefly press selector wheel ①.
Selector wheel ① extends.
- ▶ **To select:** turn selector wheel ① until indicator lamp ② comes on.
SPORT indicator ③ appears in the multifunction display.
 - The high-speed level of -15 mm when compared with highway level is set.
 - ADS (Adaptive Damping System) adapts sporty damping characteristics to the current operating and driving conditions.
 - The automatic transmission selects the automatic drive program for a sporty driving style.
 - The sporty accelerator pedal curve is selected, e.g. the accelerator pedal no

longer has to be pressed as far to accelerate.

- The sporty steering curve is selected, e.g. greater force is required when steering.

i You cannot select the SPORT program if LOW RANGE has been selected. The **Drive Program SPORT Not in LOW RANGE** message then appears in the multifunction display.

Snow program

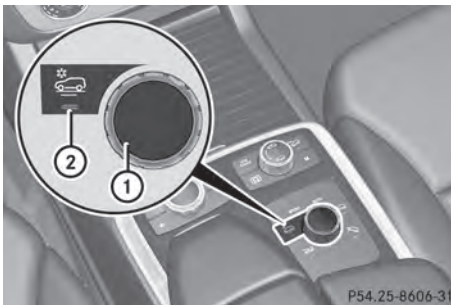

P54.25-8606-31



P54.32-9815-31

Select the snow program for driving in snow with or without snow chains.

- ▶ **Selector wheel ① engaged:** briefly press selector wheel ①.
Selector wheel ① extends.
- ▶ **To select:** turn selector wheel ① until indicator lamp ② comes on.
Snow indicator ③ appears in the multifunction display.

- Highway level is set.
- ADS (Adaptive Damping System) adapts comfortable damping characteristics to the current operating and driving conditions.
- 4ETS and the differential lock are adapted for driving on snow-covered roads.
- The automatic transmission selects the automatic drive program for a comfortable driving style that provides for optimum fuel consumption.
- The soft accelerator pedal curve is selected, e.g. the accelerator pedal must be pressed significantly further to accelerate.
- The optimum gear for pulling away is engaged.

Trailer program

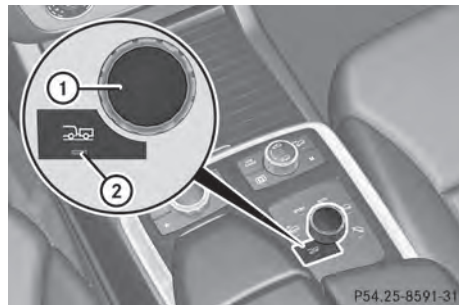

P54.25-8591-31



P54.32-9816-31

Select the trailer program when towing a trailer.

- ▶ **Selector wheel ① engaged:** briefly press selector wheel ①.
Selector wheel ① extends.
- ▶ **To select:** turn selector wheel ① until indicator lamp ② comes on.
Trailer indicator ③ appears in the multifunction display.
 - Highway level is set.
 - ADS (Adaptive Damping System) adapts comfortable damping characteristics to the current operating and driving conditions.
 - The automatic transmission selects the automatic drive program for a comfortable driving style that provides for optimum fuel consumption, changing gear at optimum points.
 - While pulling away, the differential locks are engaged.

Off-road driving systems

4MATIC (permanent four-wheel drive)

If you fail to adapt your driving style, 4MATIC can neither reduce the risk of accident nor override the laws of physics. 4MATIC cannot take account of road, weather and traffic conditions. 4MATIC is only an aid. You are responsible for the distance to the vehicle in front, for vehicle speed, for braking in good time and for staying in your lane.

! Never tow the vehicle with one axle raised. This may damage the transfer case. Damage of this sort is not covered by the Mercedes-Benz Limited Warranty. All wheels must remain either on the ground or be fully raised. Observe the instructions for towing the vehicle with all wheels in full contact with the ground.

! A function or performance test should only be carried out on a two-axle dynamometer. Before you operate the vehicle on such a dynamometer, please consult a qualified workshop. You could

otherwise damage the drive train or the brake system.

4MATIC ensures that all four wheels are permanently driven. Together with ESP® and 4ETS, it improves the traction of your vehicle whenever a drive wheel spins due to insufficient grip.

i In wintry driving conditions, the maximum effect of 4MATIC can only be achieved if you use winter tires (M+S tires), with snow chains if necessary.

Further information about "Driving off-road" (> page 187).

DSR (Downhill Speed Regulation)

Important safety notes

DSR assists you when driving downhill. It keeps the speed of travel at the speed set on the on-board computer. The steeper the downhill gradient, the greater the DSR braking effect on the vehicle. When driving on flat stretches of road or on an uphill gradient, the DSR braking effect is minimal or nonexistent.

DSR controls the set speed when it is active and the automatic transmission is in the **D**, **R** or **N** position. By accelerating or braking, you can always drive at a higher or a lower speed than that set on the on-board computer.

Further information about "Driving off-road" (> page 187).

If you fail to adapt your driving style, DSR can neither reduce the risk of accident nor override the laws of physics. DSR cannot take account of road, weather and traffic conditions. DSR is only an aid. You are responsible for the distance to the vehicle in front, for vehicle speed, for braking in good time and for staying in your lane.

You are always responsible for keeping control of the vehicle and for assessing whether the downhill gradient can be managed. DSR may not always be able to keep to the set speed, depending on road

surface and tire conditions. Select a set speed suitable for the prevailing conditions and when necessary, apply the brakes manually.

⚠ WARNING

If the speed driven and the set speed deviate and you activate DSR on a slippery road surface, the wheels may lose traction. If the wheels lose traction, the vehicle can no longer be steered. There is an increased danger of skidding and accidents.

Never activate DSR on slippery road surfaces.

Activating DSR

⚠ WARNING

If you drive faster than the set speed and activate DSR, the vehicle will decelerate on downhill gradients. If you do not know the set speed, the vehicle could decelerate unexpectedly. There is a risk of an accident.

Decelerate the vehicle to the set speed before activating DSR. If you do not know what the stored set speed is, store the desired set speed again.

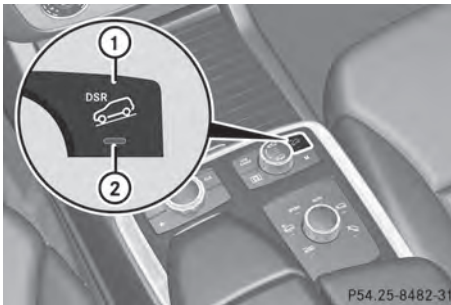

P5A.25-8482-31

Example: vehicles with the ON&OFFROAD package

- ① DSR button
- ② DSR indicator lamp

▶ Press button ①.
Indicator lamp ② lights up.

The  DSR symbol appears in the multifunction display.

You can only activate DSR when driving at speeds below 25 mph (40 km/h).

If the current vehicle speed is too high, the  DSR symbol appears in the multifunction display with the **Max. Speed 25 mph** message (Canada: **40 km/h**).

❗ You cannot activate DSR if the SPORT on-road program is activated. The  DSR symbol and the **Not in Drive Program SPORT** message then appear in the multifunction display.

Deactivating DSR

- ▶ Press button ①.
Indicator lamp ② goes out.

The  DSR symbol appears in the multifunction display with the **Off** message.

DSR switches off automatically if you drive faster than 28 mph (Canada: 45 km/h). The  DSR symbol appears in the multifunction display with the **Off** message. The status indicator in the multifunction display goes out. You also hear a warning. On vehicles with the ON&OFFROAD package, if you select a different on-road/off-road program, DSR is also deactivated.

Changing the set speed

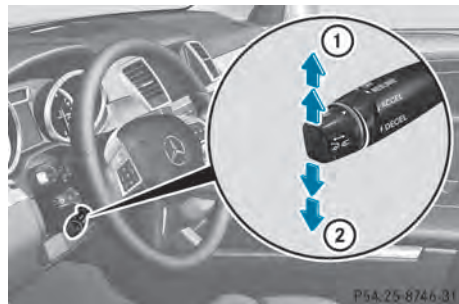

P5A.25-8746-31



P5A.32-9R21-31

- **To increase or decrease in 1 mph increments (Canada: 1 km/h increments):** briefly press the cruise control lever up ① for a higher set speed or down ② for a lower set speed.

The set speed appears in the multifunction display with the  DSR symbol. It is also displayed in status indicator ③.



When DSR is activated, you can change the set speed to a value between 1 mph and 11 mph (Canada: between 2 km/h and 18 km/h).

- ❗ The DSR set speed is always changed in 1 mph increments (Canada: 1 km/h increments). This is regardless of whether you press the cruise control lever to or beyond the pressure point.

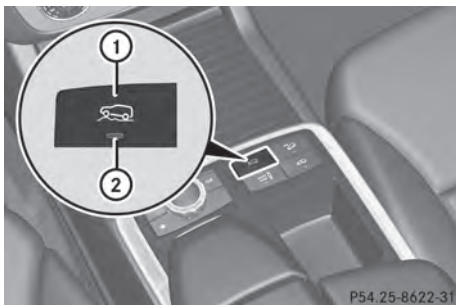
Off-road program (vehicles without the ON&OFFROAD package)



- ① Off-road program button
- ② Off-road program indicator lamp

- **To switch on:** press button ①. Indicator lamp ② lights up. The  off-road indicator appears in the multifunction display.
- **To switch off:** press button ①. Indicator lamp ② and the  off-road indicator go out in the multifunction display.

The off-road program assists you in driving off-road. The engine's performance characteristics and the gearshifting

characteristics of the automatic transmission are adapted for this purpose. ABS, ESP® and 4ETS programs especially adapted to off-road driving are activated. A gentle accelerator pedal curve is also selected, i.e. the accelerator pedal must be depressed much further in order to accelerate.

Do not use the off-road program on roads that are snow-covered or icy or if you have mounted snow chains on your vehicle.

For information about driving off-road, see (> page 187).



Off-road programs (vehicles with the ON&OFFROAD package)

General notes

The off-road programs assist you in driving off-road. The engine's performance characteristics and the gearshifting characteristics of the automatic transmission are adapted for this purpose. ABS, ESP® and 4ETS programs especially adapted to off-road driving are activated. An accelerator pedal curve suitable for the terrain is selected, i.e. the accelerator pedal must be depressed further to accelerate.

Do not use the off-road programs on roads that are snow-covered or icy or if you have mounted snow chains on your vehicle.

For information on driving off-road, see (> page 187).

The following program messages are shown in the multifunction display until the applicable vehicle level is set. Up to off-road level 2, you can hide the program messages using the  or the  button on the multifunction steering wheel.

Off-road program 1

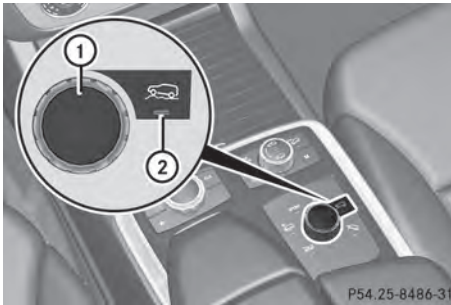

- ▶ **Selector wheel ① engaged:** briefly press selector wheel ①.
Selector wheel ① extends.
- ▶ **To select:** turn selector wheel ① until indicator lamp ② comes on.
Off-road indicator ③ appears in the multifunction display.
Off-road level 1 is set to +1.2 in (+ 30 mm) above the highway level.

If you drive at a speed above 70 mph (110 km/h), off-road program 1 switches to AUTO program.

Select off-road program 1 for gentle off-road terrain, e.g. for gravel or sand surfaces or tracks. The engine's torque is restricted to a limited degree and the drive wheels can spin. The spinning wheels produce a cutting effect for better traction.

You can only activate off-road program 1 when driving at speeds below 60 mph (100 km/h). The **Drive Program OFFROAD 1 Max Speed 60 mph (100 km/h)** message appears in the multifunction display.

Off-road program 2

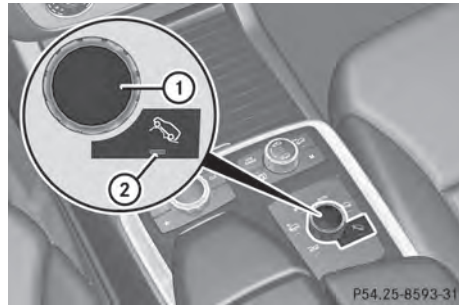

- ▶ **Selector wheel ① engaged:** briefly press selector wheel ①.
Selector wheel ① extends.
- ▶ **To select:** turn selector wheel ① until indicator lamp ② comes on.
Off-road indicator ③ appears in the multifunction display.
 - Off-road level 1 is set to +2.4 in (+60 mm) above the highway level.
 - DSR is switched on.
 - The differential lock is closed.

Off-road program 2 automatically switches to off-road program 1 if you drive faster than 30 mph (45 km/h).

Select off-road program 2 for rough terrain, e.g. for steep and/or rough terrain or driving on rocky terrain.

- ▶ **i** Your vehicle has an automatically activated differential lock for the transfer case. It controls the balance between the front and rear axles.

The differential lock improves the vehicle's traction. 4ETS (▷ page 70) controls the balance between both wheels on an axle.

You can only activate off-road program 2 when driving at speeds below 25 mph (40 km/h).

LOW RANGE off-road gear (vehicles with the ON&OFFROAD package)

Important safety notes

WARNING

If you select the LOW RANGE off-road gear on a slippery road surface, the wheels could lose traction:

- if you remove your foot from the accelerator pedal when driving
- if off road ABS intervenes when braking

If the wheels lose traction, the vehicle can no longer be steered. There is an increased danger of skidding and accidents.

Never select the LOW RANGE off-road gear when driving on slippery road surfaces.

WARNING

If you do not wait for the transfer case gear change process to complete, the transfer case could remain in the neutral position. The power transmission to the driven wheels is then interrupted. There is a danger of the vehicle rolling away unintentionally. There is a risk of an accident.

Wait until the transfer case shift process is completed.

Do not turn off the engine while changing gear and do not shift the automatic transmission to another position.

General notes

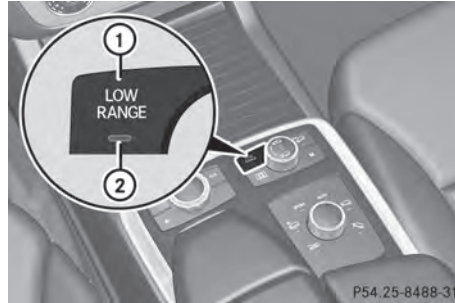

- ① LOW RANGE off-road gear button
- ② LOW RANGE off-road gear indicator lamp

| | |
|-------------------|--|
| HIGH RANGE | Position for all normal on-road driving conditions |
| LOW RANGE | <p>Off-road position for driving off-road and fording</p> <p>The transmission ratio between the engine and wheels is only approximately one third of that in the HIGH RANGE road position. Drive torque is thus proportionately higher.</p> <p>Do not use LOW RANGE:</p> <ul style="list-style-type: none"> • on slippery road surfaces, e.g. in the case of slush • on snow or ice-covered roads • if you have mounted snow chains to your vehicle |

The LOW RANGE off-road gear assists you in driving off-road and when fording. When LOW RANGE is engaged, the engine's performance characteristics and the gearshifting characteristics of the automatic transmission are adapted for this purpose.

Further information about "Driving off-road" (▷ page 187). You will find information about driving safety systems in conjunction with LOW RANGE in the "Safety" section (▷ page 65).

From HIGH RANGE to LOW RANGE

! Only change from LOW RANGE to HIGH RANGE if:

- the engine is running.
- the transmission is in position **N**
- you are driving at a speed below 40 km/h

▶ Press LOW RANGE button ①.

Indicator lamp ② flashes.

When the gear change is complete, indicator lamp ② lights up. LOW RANGE indicator appears in the multifunction display and in the status indicator.

While indicator lamp ② is flashing, you can cancel the gear change by pressing LOW RANGE button ① again.

i You cannot activate LOW RANGE if the SPORT on-road program is activated. The **LOW RANGE Not in Drive Program SPORT** message then appears in the multifunction display.

From LOW RANGE to HIGH RANGE

! Only change from LOW RANGE to HIGH RANGE if:

- the engine is running.
- the transmission is in position **N**
- you are driving at a speed below 70 km/h

▶ Press LOW RANGE button ①.

Indicator lamp ② flashes.

When the gear change is complete, indicator lamp ② goes out. In the multifunction display, the **LOW RANGE Off** message appears and status indicator ③ goes out.

While indicator lamp ② is flashing, you can cancel the gear change by pressing LOW RANGE button ① again.

Messages in the multifunction display

If a gear change process has not been successful, the following messages may be displayed in the multifunction display:

| Display messages | Possible causes/consequences and ► Solutions |
|---|---|
| LOW RANGE Max. Speed 40 km/h | You have been driving faster than 40 km/h. Additionally, the indicator lamp on the button in the center console blinks. ► Drive more slowly to carry out the gear change process. |
| LOW RANGE Shift to Position N Briefly | The transmission is in position D and you are driving at below 40 km/h. ► Shift the transmission to N to complete the gear change process. |
| LOW RANGE Shifting Canceled Please Reactivate | The gear change process was not carried out. ► Ensure that all gear change conditions are fulfilled and carry out the gear change process again. |
| LOW RANGE Stop Apply Parking Brake | A warning tone also sounds. The gear change process has not been completed. LOW RANGE is in the neutral position. There is no connection between the engine and the drive wheels. ! Do not drive any further. You could otherwise damage the vehicle's drive train. ► Stop the vehicle. Take into account the road and traffic conditions when doing this. ► Depress the electric parking brake (▷ page 180). ► Carry out the gear change process again. If the gear change process has been carried out, the LOW RANGE Stop Apply Parking Brake message disappears. |

ON&OFFROAD menu in the COMAND display (vehicles with the ON&OFFROAD package)



P54.25-8627-31

You can display some driving systems, driving programs and additional information in the COMAND display.

- Make sure that the SmartKey is in position **2** in the ignition lock.
- Make sure that COMAND is activated, see the separate COMAND operating instructions.
- Press function button **1**.
The corresponding displays appear in the COMAND display:
 - level control
 - steering angle
 - vehicle's angle of inclination

- uphill or downhill gradient in percentage
- on-road/off-road program selected
- condition of the differential lock for the transfer case
- the LOW RANGE off-road gear is selected
- condition of the LOW RANGE off-road gear
- the on-road trailer program is selected

Towing a trailer

Notes on towing a trailer

Important safety notes

WARNING

If you install a ball coupling other than the one delivered with the vehicle, the trailer tow hitch and the rear axle may be overloaded. This applies especially if the ball coupling in question is longer or angled differently. This could seriously impair the driving characteristics and the trailer can come loose. There is a risk of an accident.

Only install the ball coupling delivered with the vehicle or a ball coupling that is designed to meet your trailer towing requirements. Do not modify the ball coupling or the trailer tow hitch.

WARNING

If the ball coupling is not installed correctly or not secured with the bolt provided and the corresponding spring cotter, the trailer may come loose. There is a risk of an accident.

Always install and secure the ball coupling as described. Before every journey, ensure that the ball coupling is secured with the bolt and the corresponding spring cotter.

WARNING

If you rest your foot on the brake pedal while driving, the braking system can overheat. This increases the stopping distance and can even

cause the braking system to fail. There is a risk of an accident.

Never use the brake pedal as a footrest. Never depress the brake pedal and the accelerator pedal at the same time.

WARNING

When the vehicle/trailer combination begins to lurch, you could lose control of it. The vehicle/trailer combination could even rollover. There is a risk of an accident.

On no account should you attempt to straighten up the vehicle/trailer combination by increasing the speed. Reduce vehicle speed and do not countersteer. Apply the brake as necessary.

- ❗ Depressing the brake pedal constantly results in excessive and premature wear to the brake pads.

Please observe the manufacturer's operating instructions for the trailer coupling if a detachable trailer coupling is used.

Couple and uncouple the trailer carefully. If you do not couple the trailer to the towing vehicle correctly, the trailer could become detached.

Make sure that the following values are not exceeded:

- the permissible trailer drawbar noseweight
- the permissible trailer load
- the permissible rear axle load of the towing vehicle
- the maximum permissible gross vehicle weight of both the towing vehicle and the trailer

The applicable permissible values, which must not be exceeded, can be found:

- in the vehicle documents
- on the identification plates of the trailer tow hitch, the trailer and the vehicle

If the values differ, the lowest value applies.

You will find the values approved by the manufacturer on the vehicle identification

plates and those for the towing vehicle under "Technical data" (▷ page 455).

When towing a trailer, your vehicle's handling characteristics will be different in comparison with when driving without a trailer.

The vehicle/trailer combination:

- is heavier
- is restricted in its acceleration and gradient-climbing capability
- has an increased braking distance
- is affected more by strong crosswinds
- demands more sensitive steering
- has a larger turning radius

This could impair the handling characteristics.

When towing a trailer, always adjust your speed to the current road and weather conditions. Do not exceed the maximum permissible speed for your vehicle/trailer combination.

General notes

- Do not exceed the legally prescribed maximum speed for vehicle/trailer combinations in the relevant country. This lowers the risk of an accident.
 - Only install an approved trailer coupling on your vehicle.
Further information on availability and on installation is available from any authorized Mercedes-Benz Center.
 - The bumpers of your vehicle are not suitable for installing detachable trailer couplings.
 - Do not install hired trailer couplings or other detachable trailer couplings on the bumpers of your vehicle.
 - If you no longer need the ball coupling, remove it from the ball coupling recess. This will reduce the risk of damage to the ball coupling.
- i** When towing a trailer, set the tire pressure on the rear axle of the towing

vehicle for a maximum load; see the tire pressure table in the fuel filler flap (▷ page 419).

You will find installation dimensions and loads in the "Technical data" section (▷ page 454).

The maximum noseweight of the trailer drawbar on the ball coupling is 575 lbs(261 kg) for all models (except the model ML 350 BlueEFFICIENCY).

The maximum noseweight of the trailer drawbar on the ball coupling is 529 lbs (240 kg) for the model ML 350 BlueEFFICIENCY.

The actual noseweight may not be higher than the value which is given. The value can be found on the trailer tow hitch or trailer identification plates. The lowest weight applies.

Please note that when towing a trailer, PARKTRONIC (▷ page 213) and Blind Spot Assist (▷ page 233) are only available with limitations, or not at all.

- i** On vehicles without level control, the height of the ball coupling will alter according to the load placed on the vehicle. If necessary, use a trailer with a height-adjustable drawbar.

Driving tips

- i** Observe the information on ESP® trailer stabilization (▷ page 72) and on pulling away with a trailer (▷ page 160).

The maximum permissible speed for vehicle/trailer combinations depends on the type of trailer. Before beginning the journey, check the trailer's documents to see what the maximum permissible speed is. Observe the legally prescribed maximum speed in the relevant country.

For certain Mercedes-Benz vehicles, the maximum permissible rear axle load is increased when towing a trailer. See "Technical data" to find out whether this applies to your vehicle (▷ page 455). If you

utilize any of the added maximum rear axle load when towing a trailer, the vehicle/trailer combination may not exceed a maximum speed of 60 mph (100 km/h) for reasons concerning the operating permit. This also applies in countries in which the permissible maximum speed for vehicle/trailer combinations is above 60 mph (100 km/h). When towing a trailer, your vehicle's handling characteristics will be different in comparison with when driving without a trailer.

On long and steep downhill gradients, you must select shift range **1**, **2** or **3** in good time.

- i** This also applies if you have activated cruise control or DISTRONIC PLUS.

This will use the braking effect of the engine, so that less braking will be required to maintain the speed, This relieves the load on the brake system and prevents the brakes from overheating and wearing too quickly. If you need additional braking, depress the brake pedal repeatedly rather than continuously.

Driving tips

If the trailer swings from side to side:

- ▶ Do not accelerate.
- ▶ Do not counter-steer.
- ▶ Brake if necessary.
- Maintain a greater distance from the vehicle in front than when driving without a trailer.
- Avoid braking abruptly. If possible, brake gently at first to allow the trailer to run on. Then, increase the braking force rapidly.
- The values given for gradient-climbing capabilities from a standstill refer to sea level. When driving in mountainous areas, note that the power output of the engine and, consequently, the vehicle's gradient-climbing capability, decreases with increasing altitude.

Installing the ball coupling

WARNING

If the ball coupling is not installed and secured correctly it can become detached while the vehicle is in motion and fall onto the road. There is a risk of accident and injury.

Always install and secure the ball coupling as described. Before every journey, ensure that the ball coupling is secured with the bolt and the corresponding spring cotter.

WARNING

If the ball coupling is not installed correctly or not secured with the bolt provided and the corresponding spring cotter, the trailer may come loose. There is a risk of an accident.

Always install and secure the ball coupling as described. Before every journey, ensure that the ball coupling is secured with the bolt and the corresponding spring cotter.

WARNING

If the ball coupling is not installed and secured correctly the trailer may come loose. There is a risk of an accident.

Install and secure the ball coupling as described in the ball coupling installation instructions. Make sure that the ball coupling is installed and secured correctly before every journey.

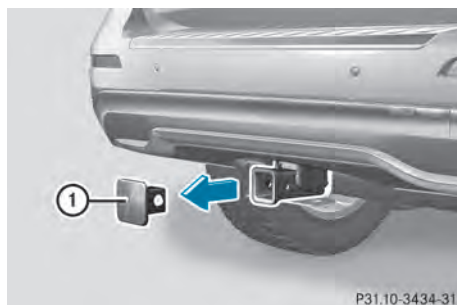

Cover cap

P31.10-3434-31

- ▶ Pull protective cap ① in the direction of the arrow, out of the ball coupling recess.
- ▶ Place protective cap ① in the ball coupling recess.

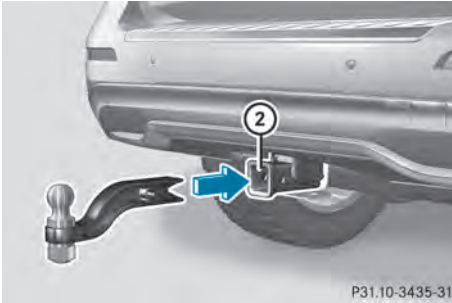

Ball coupling recess

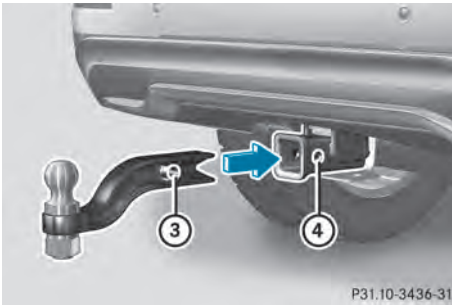

Holes in the ball coupling and ball coupling recess

- ▶ Insert the ball coupling horizontally into ball coupling recess ② in the direction of the arrow until the holes in ball coupling ③ are in line with the holes in ball coupling recess ④.

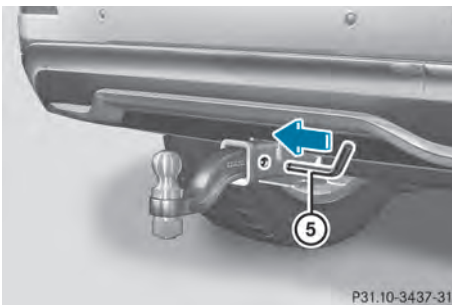

Bolt

- ▶ Slide bolt ⑤ into the hole in the ball coupling recess and the ball coupling to the stop.

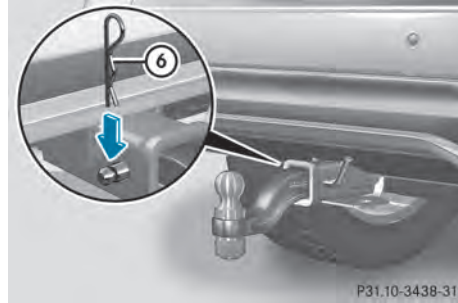

Bolt and spring cotter

- ▶ Secure the bolt using spring cotter ⑥.

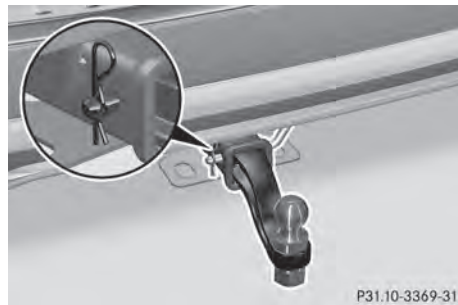

Correctly installed and secured ball coupling

- ▶ Check the ball coupling, bolt and spring cotter for correct installation.

If the ball coupling cannot be correctly mounted, remove the ball coupling. Under these circumstances, the ball coupling must not be used for trailer towing.

If the ball coupling cannot be locked and the key cannot be removed, remove the ball coupling and clean it. If the ball coupling can still not be installed (locked) after it has been cleaned, remove the ball coupling. The trailer tow hitch must then not be used to tow a trailer, as safe operation cannot be guaranteed.

Have the entire trailer tow hitch checked at a qualified specialist workshop.

Coupling up a trailer

! Do not connect the trailer's brake system (if featured) to the hydraulic brake system of the towing vehicle, as the latter is equipped with an anti-lock brake system. Doing so will result in a loss of function of the brake systems of both the vehicle and the trailer.

- ▶ Make sure that the automatic transmission is set to position **P**.
- ▶ Apply the vehicle's electric parking brake.
- ▶ Start the engine.
- ▶ **Vehicles with the AIRMATIC package:** select highway level.
- ▶ **Vehicles with ADS:** set ADS to **AUTO** or **COMF**.
- ▶ Switch off the engine.
- ▶ Close all doors and the tailgate.
- ▶ Couple up the trailer.
- ▶ Establish all electrical connections.
- ▶ Check that the trailer lighting system is working.

i Vehicles with the AIRMATIC package: with a trailer attached, the vehicle will always remain at highway level. When coupling up a trailer, please observe the following:

- Unless highway level has been set manually, the vehicle is automatically lowered to highway level. This is the case if a speed of 5 mph (8 km/h) is reached.
- High-speed level is not available.

These restrictions apply to all accessories powered through a connection to the trailer power socket of your vehicle, e.g. a bicycle carrier.

Observe the maximum permissible trailer dimensions (width and length).

Most U.S. states and all Canadian provinces require by law:

- Safety chains between the towing vehicle and the trailer. The chains should be cross-wound under the trailer drawbar. They must

be fastened to the vehicle's trailer coupling, not to the bumper or the axle.

Leave enough play in the chains to make tight cornering possible.

- A separate brake system for certain types of trailer.
- A safety switch for braked trailers. Check the specific legal requirements applicable to your state.

If the trailer detaches from the towing vehicle, the safety switch applies the trailer's brakes.

Towing a trailer

There are numerous legal requirements concerning the towing of a trailer, e.g. speed restrictions. Make sure that your vehicle/trailer combination complies with the local requirements not only in your area of residence but also at any location to which you are traveling. The police and local authorities can provide reliable information. Please observe the following when towing a trailer:

- To acquaint yourself with driving with a trailer and with the resulting changes to handling, you should practice cornering, stopping and backing up in a traffic-free location.
- Before driving, check:
 - Trailer tow hitch
 - Safety switch for braked trailers
 - Safety chains
 - Electrical connections
 - Lights
 - the wheels
- Adjust the exterior mirrors to provide an unobstructed view of the rear section of the trailer.
- If the trailer features electronically controlled brakes, pull away the vehicle/trailer combination carefully, manually

brake using the brake controller, and check the brakes for correct function.

- Secure any objects on the trailer to prevent the cargo from slipping when the vehicle is in motion.
- If you couple up a trailer, regularly check the cargo for secure fastening and make sure that the trailer lamps and (if applicable) the trailer brakes are functioning correctly.
- Bear in mind that the handling will be less stable when towing a trailer than when driving without one. Avoid sudden steering movements.
- The vehicle/trailer combination is heavier, accelerates more slowly, has a decreased gradient climbing capability and a longer braking distance.

It is more susceptible to side winds and requires more careful steering.

- If possible, avoid abrupt braking. Depress the brake pedal moderately at first, so that the trailer can activate its own brakes. Then increase the pressure on the brake pedal.
- If the automatic transmission continues to shift back and forth between two gears when driving up or downhill, restrict the shift range. Select shift range **4, 3, 2**, or **1**. A lower gear and lower speed reduce the risk of engine failure.

- When driving downhill, shift to a lower gear to utilize the engine's braking effect.

Avoid continuous brake application as this may overheat the vehicle brakes and, if installed, the trailer brakes.

- If the coolant temperature increases dramatically while the air-conditioning system is switched on, switch off the air-conditioning system.

Coolant heat can additionally be dissipated by opening the windows and by setting the

blower fan and the interior temperature to maximum.

- When overtaking, pay particular attention to the extended length of your vehicle/trailer combination.

Due to the length of your vehicle/trailer combination, you will have to travel an additional distance beyond the vehicle you are overtaking before returning to the previous lane.

Decoupling a trailer

WARNING

If you uncouple a trailer with the overrun brake engaged, you could trap your hand between the vehicle and the trailer drawbar. There is a risk of injury.

Do not uncouple a trailer if the overrun brake is engaged.

WARNING

Vehicles with level control:

The vehicle is lowered as soon as you disconnect the trailer cable. This could result in your limbs or those of other people that are between the vehicle body and tires or underneath the vehicle being trapped. There is a risk of injury.

Make sure that nobody is in the immediate vicinity of the wheel housings or under the vehicle when you disconnect the trailer cable.

- ❗ Do not disconnect a trailer with an engaged overrun brake. Otherwise, your vehicle could be damaged by the rebounding of the overrun brake.
- ▶ Make sure that the automatic transmission is set to position **P**.
- ▶ Apply the vehicle's electric parking brake.
- ▶ Start the engine.
- ▶ Close all doors and the tailgate.
- ▶ Apply the trailer's parking brake.

- ▶ Detach the trailer cable and decouple the trailer.
- ▶ Switch off the engine.

Permissible trailer loads and drawbar loads

Weight specifications

Maximum permissible gross vehicle weight rating

The gross trailer weight is calculated by adding the weight of the trailer to the weight of the load and equipment on the trailer.

Permissible gross weight (all models except the ML 350 BlueEFFICIENCY): 7,198 lbs (3,265 kg).

Permissible gross weight (ML 350 BlueEFFICIENCY): 6,613 lbs (3,000 kg).

Permissible noseweight

The maximum permissible trailer drawbar noseweight is the maximum weight with which the trailer drawbar can be loaded.

All models (except the ML 350 BlueEFFICIENCY: 575 lbs (261 kg).
ML 350 BlueEFFICIENCY: 529 lbs (240 kg).

Limit for Mercedes-Benz-approved trailer couplings.

Loading a trailer

- When loading the trailer, make sure that neither the permissible gross weight of the trailer nor the gross vehicle weight is exceeded. The permissible gross vehicle weight is indicated on the identification plate on the B-pillar on the driver's side of the vehicle.

You can find the maximum permissible values on the type plates of your vehicle and the trailer. When calculating how much weight the vehicle and trailer may carry,

pay attention to the respective lowest values.

- The trailer drawbar load on the ball coupling must be added to the rear axle load to avoid exceeding the permissible gross axle weight. The permissible gross vehicle weight is indicated on the identification plate on the B-pillar on the driver's side of the vehicle.

i Mercedes-Benz recommends a trailer load where the trailer drawbar noseweight accounts for 8% to 15% of the trailer's permissible gross weight.

i The weight of additional accessories, passengers, and cargo reduces the permissible trailer load and drawbar load for your vehicle.

Checking the vehicle and trailer weight

- To check that the weights of the towing vehicle and the trailer comply with the maximum permissible values, have the vehicle/trailer combination (including the driver, passengers, and cargo with a fully laden trailer) weighed on a calibrated weighbridge.
- Check the gross axle weight rating of the front and rear axles, the gross weight of the trailer and trailer drawbar load.

Removing the ball coupling

- ▶ Remove the spring cotter.
- ▶ Remove the bolt from the ball coupling recess.
- ▶ Remove the ball coupling from the ball coupling recess.
- ▶ Clean the ball coupling if it is dirty.

Information on cleaning and care of the trailer tow hitch can be found at (▶ page 374).

Storing the ball coupling

WARNING

Do not carry the ball coupling in the vehicle interior if it is not secured.

Otherwise, you and others could be injured by the ball coupling being thrown around if you:

- brake sharply
- change direction suddenly
- are involved in an accident

Trailer power supply

! You can connect accessories with a maximum power consumption of 240 W to the permanent power supply.

You must not charge a trailer battery using the power supply.

The trailer socket of your vehicle is equipped at the factory with a permanent power supply.

The permanent power supply is supplied via trailer socket pin 4.

The trailer's permanent power supply is switched off in the event of low vehicle supply voltage and after six hours at the latest.

A qualified specialist workshop can provide more information about installing the trailer electrics.

| | |
|--|-----|
| Useful information | 262 |
| Important safety notes | 262 |
| Displays and operation | 263 |
| Menus and submenus | 266 |
| Display messages | 282 |
| Warning and indicator lamps in the instrument cluster | 316 |

Useful information

- i** This Operator's Manual describes all models and all standard and optional equipment of your vehicle available at the time of publication of the Operator's Manual. Country-specific differences are possible. Please note that your vehicle may not be equipped with all features described. This also applies to safety-related systems and functions.
- i** Read the information on qualified specialist workshops: (> page 27).

Important safety notes **WARNING**

If you operate information systems and communication equipment integrated in the vehicle while driving, you will be distracted from traffic conditions. You could also lose control of the vehicle. There is a risk of an accident.

Only operate the equipment when the traffic situation permits. If you are not sure that this is possible, park the vehicle paying attention to traffic conditions and operate the equipment when the vehicle is stationary.

 **WARNING**

If the instrument cluster has failed or malfunctioned, you may not recognize function restrictions in systems relevant to safety. The operating safety of your vehicle may be impaired. There is a risk of an accident.

Drive on carefully. Have the vehicle checked at a qualified specialist workshop immediately.

You must observe the legal requirements for the country in which you are currently driving when operating the on-board computer.

The on-board computer only shows messages or warnings from certain systems in the

multifunction display. You should therefore make sure your vehicle is operating safely at all times. Otherwise, a vehicle that is not operating safely may cause an accident. For an overview, see the instrument panel illustration (> page 33).

Displays and operation

Instrument cluster

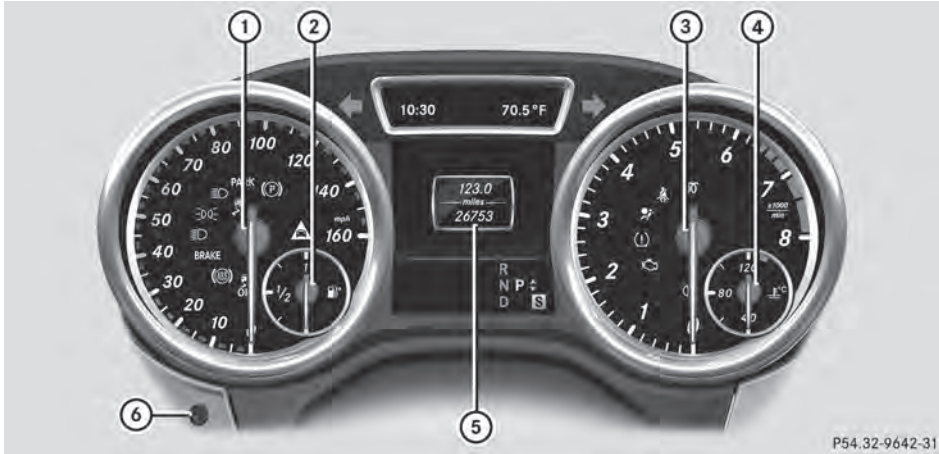

Instrument cluster: miles



- ① Speedometer with segments (▷ page 264)
- ② Fuel gauge
- ③ Tachometer (▷ page 264)
- ④ Coolant temperature (▷ page 263)
- ⑤ Multifunction display (▷ page 265)
- ⑥ Instrument cluster lighting (▷ page 263)

Instrument cluster lighting

The lighting in the instrument cluster, in the displays and the controls in the vehicle interior can be adjusted using the brightness control knob.

The brightness control knob is located on the bottom left of the instrument cluster (▷ page 33).

- ▶ Turn the brightness control knob clockwise or counter-clockwise.

If the light switch is set to **AUTO**,  or , the brightness is dependent upon the brightness of the ambient light.

- ❗ The light sensor in the instrument cluster automatically controls the brightness of the multifunction display.

In daylight, the displays in the instrument cluster are not illuminated.

Coolant temperature display

 **WARNING**

Driving when your engine is overheated can cause some fluids which may have leaked into the engine compartment to catch fire. You could be seriously burned.

Steam from an overheated engine can cause serious burns which can occur just by opening the engine hood. Stay away from the engine if you see or hear steam coming from it.

Stop the vehicle in a safe location away from other traffic. Turn off the engine, get out of the

vehicle and do not stand near the vehicle until the engine has cooled down.

! A display message is shown if the coolant temperature is too high.

If the coolant temperature is over 248 °F (120 °C), do not continue driving. The engine will otherwise be damaged.

The coolant temperature gauge is in the instrument cluster on the right-hand side (▷ page 33).

Under normal operating conditions and with the specified coolant level, the coolant temperature may rise to 248 °F (120 °C).

Tachometer

! Do not drive in the overrevving range, as this could damage the engine.

The red band in the tachometer indicates the engine's overrevving range.

The fuel supply is interrupted to protect the engine when the red band is reached.

Outside temperature display

You should pay special attention to road conditions when temperatures are around freezing point.

The outside temperature display is in the multifunction display (▷ page 265).

Changes in the outside temperature are displayed after a short delay.

Speedometer with segments

The segments in the speedometer indicate which speed range is available.

- Cruise control activated (▷ page 192):
The segments light up from the stored speed to the maximum speed.
- DISTRONIC PLUS activated (▷ page 194):

One or two segments in the set speed range light up.

- DISTRONIC PLUS detects a vehicle in front:
The segments between the speed of the vehicle in front and the stored speed light up.

Operating the on-board computer

Overview









- ① Multifunction display
- ② Switches on the Voice Control System; see the separate operating instructions
- ③ Right control panel
- ④ Left control panel
- ⑤ Back button



► **To activate the on-board computer:** turn the SmartKey to position 1 in the ignition lock.



You can control the multifunction display and the settings in the on-board computer using the buttons on the multifunction steering wheel.

Left control panel



| | |
|---|---|
|  | • Calls up the menu and menu bar |
|  | |
|  | Press briefly: |
|  | <ul style="list-style-type: none"> • Scrolls in lists • Selects a submenu or function • In the Audio menu: selects a stored station, an audio track or a video scene • In the Tel (telephone) menu: switches to the phone book and selects a name or telephone number |
|  | Press and hold: |
|  | <ul style="list-style-type: none"> • In the Audio menu: selects the previous/next station or selects an audio track or a video scene using rapid scrolling • In the Tel (Telephone) menu: starts rapid scrolling if the phone book is open |
|  | <ul style="list-style-type: none"> • Confirms a selection/display message • In the Tel (telephone) menu: switches to the telephone book and starts dialing the selected number • In the Audio menu: stops the station search function at the desired station |

Right control panel

| | |
|---|--|
|  | <ul style="list-style-type: none"> • Rejects or ends a call • Exits phone book/redial memory |
|  | <ul style="list-style-type: none"> • Makes or accepts a call • Switches to the redial memory |

| | |
|---|----------------------|
|  | • Adjusts the volume |
|  | |
|  | • Mute |

Back button

| | |
|---|---|
|  | Press briefly: |
| | <ul style="list-style-type: none"> • Back • Switches off the Voice Control System; see the separate operating instructions • Hides display messages/calls up the last Trip menu function used • Exits the telephone book/redial memory |
|  | Press and hold: |
| | <ul style="list-style-type: none"> • Calls up the standard display in the Trip menu |

Multifunction display

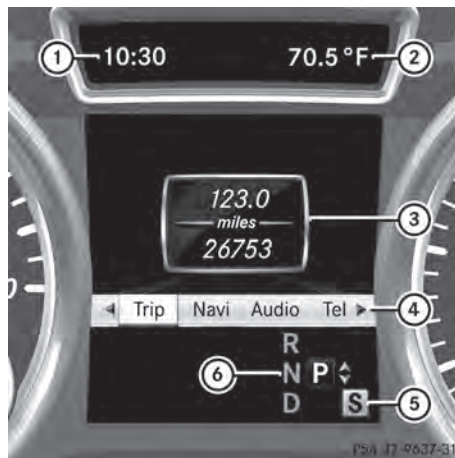

- ① Time
- ② Permanent display: outside temperature or speed (▷ page 274)
- ③ Description field
- ④ Menu bar

- ⑤ Drive program (▷ page 165)
- ⑥ Transmission position (▷ page 165)









► **To show menu bar** ④: press the ◀ or ▶ button on the steering wheel.

Menu bar ④ disappears after a few seconds.

Text field ③ shows the selected menu or submenu as well as display messages.

- ❗ You can set the time using the audio system or COMAND; see the separate operating instructions.

The following messages may appear in the multifunction display:

- ◀ P ▶ Active Parking Assist (▷ page 217)
- CRUISE** Cruise control (▷ page 192)
-  DSR (▷ page 246)
-  Off-road program (vehicles without the ON&OFFROAD package) (▷ page 248)
-  Off-road program (vehicles with the ON&OFFROAD package) (▷ page 248)
- LOW RANGE** LOW RANGE off-road gear (▷ page 250)
-  Adaptive high-beam Assist (▷ page 126)
-  ATTENTION ASSIST (▷ page 230)
- ECO** ECO start/stop function (▷ page 161)
-  Lane Keeping Assist (▷ page 235)
-  Active Lane Keeping Assist (▷ page 241)
- HOLD** HOLD function (▷ page 207)
-  Distance warning function (▷ page 68)
-  PRE-SAFE® Brake (▷ page 73)

Menus and submenus

Menu overview

Press the ◀ or ▶ button on the steering wheel to call up the menu bar and select a menu.

Operating the on-board computer (▷ page 264).

Depending on the equipment installed in the vehicle, you can call up the following menus:

- **Trip** menu (▷ page 266)
- **Navi** menu (navigation instructions) (▷ page 268)
- **Audio** menu (▷ page 269)
- **Tel** menu (telephone) (▷ page 270)
- **DriveAssist** menu (assistance) (▷ page 272)
- **Serv.** menu (▷ page 273)
- **Sett.** menu (▷ page 274)
- **ON&OFFROAD** menu (▷ page 278)
- **AMG** menu in AMG vehicles (▷ page 278)

Trip menu

Standard display



- Press and hold the  button on the steering wheel until the **Trip** menu with trip odometer ① and odometer ② is shown.

Trip computer "From Start" or "From Reset"

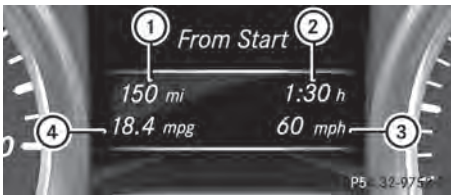

Example: trip computer "From Start"

- ① Distance
 - ② Time
 - ③ Average speed
 - ④ Average fuel consumption
- ▶ Press the or button on the steering wheel to select the **Trip** menu.
 - ▶ Press or to select **From Start** or **From Reset**.

The values in the **From Start** submenu are calculated from the start of a journey, while the values in the **From Reset** submenu are calculated from the last time the submenu was reset (▷ page 268).

The **From Start** trip computer is automatically reset when:

- The ignition has been switched off for more than four hours.
- 999 hours have been exceeded.
- 9,999 miles have been exceeded.

The **From Reset** trip computer is automatically reset if the value exceeds 9,999 hours or 99,999 miles.

Displaying the range and current fuel consumption

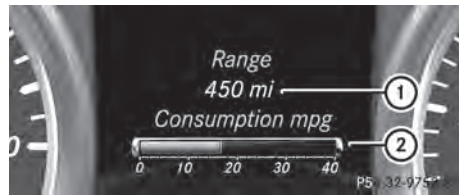

- ① Approximate range
 - ② Current fuel consumption (not for AMG vehicles)
- ▶ Press the or button on the steering wheel to select the **Trip** menu.
 - ▶ Press the or button to select the current fuel consumption (not for AMG vehicles) and the approximate range.

The approximate range that can be covered depends on the fuel level and your current driving style. If there is only a small amount of fuel left in the fuel tank, the display shows a vehicle being refueled instead of the range.

Digital speedometer



- ① Digital speedometer
- ▶ Press the or button on the steering wheel to select the **Trip** menu.
 - ▶ Press the or button to select the digital speedometer.

Resetting values



Example: resetting the trip computer "From Start"

- ▶ Press the ◀ or ▶ button on the steering wheel to select the **Trip** menu.
- ▶ Press the ▲ or ▼ button to select the function that you wish to reset.
- ▶ Press the **OK** button.
- ▶ Press the ▼ button to select **Yes** and press the **OK** button to confirm.

You can reset the values of the following functions:

- trip odometer
- "From Start" trip computer
- "From Reset" trip computer

Navigation system menu

Displaying navigation instructions

In the **Navi** menu, the multifunction display shows navigation instructions.

For more information, see the separate operating instructions.

- ▶ Switch on the audio system with Becker® MAP PILOT or COMAND; see the separate operating instructions.
- ▶ Press the ◀ or ▶ button on the steering wheel to select the **Navi** menu.

Route guidance not active

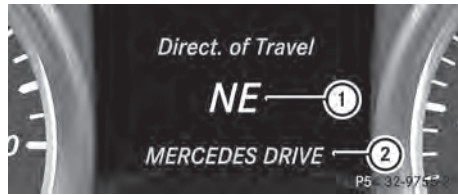

- ① Direction of travel
- ② Current street

Route guidance active

No change of direction announced



- ① Distance to the destination
- ② Distance to the next change of direction
- ③ Current street
- ④ Symbol "follow the road's course"

Change of direction announced without a lane recommendation



- ① Road into which the change of direction leads
- ② Distance to change of direction and visual distance display
- ③ Change-of-direction icon

When a change of direction has been announced, you will see visual distance display ② next to the symbol for change of direction ③. This shortens from the bottom

to the top of the display as you approach the point of the announced change of direction.

Change of direction announced with a lane recommendation

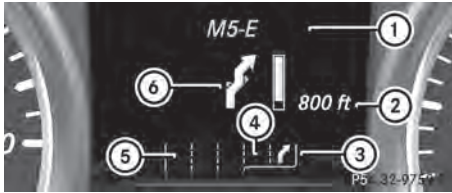

- ① Road into which the change of direction leads
- ② Distance to change of direction and visual distance display
- ③ Lane recommendation
- ④ New lane during a change of direction
- ⑤ Uninterrupted lane
- ⑥ Change-of-direction icon

On multilane roads, the system can display lane recommendation ③ for the next change of direction. During the change of direction, additional lanes may be displayed.

Lane recommendations are only displayed if the relevant data is available on the digital map.

Other status indicators of the navigation system







- : you have reached the destination or an intermediate destination.
- **New Route...** or **Calculating Route:** calculating a new route
- **Off Map** or **Off Mapped Road:** the vehicle position is outside the area of the digital map (off-map position).
- **No Route:** no route could be calculated to the selected destination.

Audio menu



Selecting a radio station



- ① Waveband
 - ② Station frequency with memory position
- i** Station ② is displayed with the station frequency or station name. The memory position is only displayed along with station ② if this has been stored.

- ▶ Switch on COMAND and select Radio; see the separate operating instructions.
- ▶ Press the  or  button on the steering wheel to select the **Audio** menu.
- ▶ **To select a stored station:** briefly press the  or  button.
- ▶ **To select a station from the station list:** press and briefly hold the  or  button.

If no station list is received:

- ▶ **To select a station using the station search:** press and briefly hold the  or  button.

- i** For information on switching waveband and storing stations; see the separate operating instructions.
- i** SIRIUS XM satellite radio functions like a normal radio.
For more information on satellite radio operation, see the separate operating instructions.

Operating an audio player or audio media



Display CD/DVD changer (example)

- ① Current CD in the CD/DVD changer
- ② Current title

Audio data from various audio devices or media can be played, depending on the equipment installed in the vehicle.

- ▶ Switch on COMAND and activate audio CD/DVD mode or MP3 mode; see the separate operating instructions.
- ▶ Press the ◀ or ▶ button on the steering wheel to select the **Audio** menu.
- ▶ **To select the next/previous track:** briefly press the ▲ or ▼ button.
- ▶ **To select a track from the track list (rapid scrolling):** press and hold the ▲ or ▼ button until desired track ② has been reached.

If you press and hold ▲ or ▼, the rapid scrolling speed is increased. Not all audio drives or data carriers support this function.

If track information is stored on the audio device or medium, the multifunction display will show the number and title of the track. The current track does not appear in audio AUX mode (**A**uxiliary audio mode: external audio source connected).

Video DVD operation

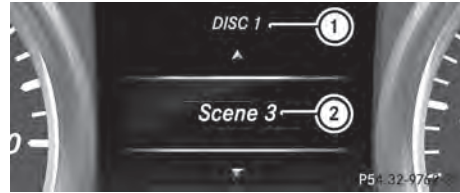

Display CD/DVD changer (example)

- ① Current DVD in the CD/DVD changer
- ② Current scene

- ▶ Switch on COMAND and select video DVD; see the separate operating instructions.
- ▶ Press the ◀ or ▶ button on the steering wheel to select the **Audio** menu.
- ▶ **To select the next/previous scene:** briefly press the ▲ or ▼ button.
- ▶ **To select a scene from the scene list (rapid scrolling):** press and hold the ▲ or ▼ button until desired scene ② has been reached.

Telephone menu



Introduction

WARNING

The driver's attention to the road must always be his/her primary focus when driving. For your safety and the safety of others, we recommend that you pull over to a safe location and stop before placing or taking a telephone call. If you choose to use the telephone while driving, please use the hands-free device and only use the telephone when road, weather and traffic conditions permit.

Some jurisdictions prohibit the driver from using a mobile phone while driving a vehicle.

Bear in mind that at a speed of just 30 mph (approximately 50 km/h), your vehicle covers a distance of 44 feet (approximately 14 m) every second.

- ▶ Switch on the mobile phone (see the separate operating instructions).
- ▶ Switch on COMAND (see the separate operating instructions).
- ▶ Establish a Bluetooth® connection to COMAND; see the separate operating instructions.
- ▶ Press the  or  button on the steering wheel to select the **Te1** menu.

You will see one of the following display messages in the multifunction display:

- **Phone READY** or the name of the network provider: the mobile phone has found a network and is ready to receive.
- **Telephone No Service**: there is no network available or the mobile phone is searching for a network.

Accepting a call

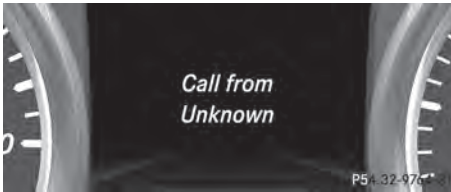

Example: incoming call

If someone calls you when you are in the **Te1** menu, a display message appears in the multifunction display.

- ▶ Press the  button on the steering wheel to accept an incoming call.







You can accept a call even if you are not in the **Te1** menu.

Rejecting or ending a call



- ▶ Press the  button on the steering wheel.



You can end or reject a call even if you are not in the **Te1** menu.

Dialing a number from the phone book



- ▶ Press the  or  button on the steering wheel to select the **Te1** menu.
- ▶ Press the ,  or  button to switch to the phone book.
- ▶ Press the  or  button to select the desired name.





or

- ▶ **To begin rapid scrolling:** press and hold the  or  button for longer than one second. Rapid scrolling stops when you release the button or reach the end of the list.



- ▶ **If only one telephone number is stored for a name:** press the  or  button to start dialing.

or

- ▶ **If there is more than one number for a particular name:** press the  or  button to display the numbers.







- ▶ Press the  or  button to select the number you want to dial.
- ▶ Press the  or  button to start dialing.

or

- ▶ **To exit the telephone book:** press the  or  button.

Redialing

The on-board computer saves the last names or numbers dialed in the redial memory.

- ▶ Press the  or  button on the steering wheel to select the **Te1** menu.
- ▶ Press the  button to switch to the redial memory.
- ▶ Press the ,  button to select the desired name or number.
- ▶ Press the  or  button to start dialing.

or

- ▶ **To exit the redial memory:** press the  or  button.

Assistance menu

Introduction



In the **DriveAssist** menu, you have the following options:

- showing the distance display (▷ page 272)
- activating/deactivating the distance warning function (▷ page 272)
- activating/deactivating the PRE-SAFE® Brake (▷ page 272)
- activating/deactivating ATTENTION ASSIST (▷ page 273)
- activating/deactivating Blind Spot Assist or Active Blind Spot Assist (▷ page 273)
- activating/deactivating Lane Keeping Assist or Active Lane Keeping Assist (▷ page 273)

Showing the distance display

- ▶ Press or on the steering wheel to select the **DriveAssist** menu.
- ▶ Press the or button to select **Distance Display**.
- ▶ Press the button.
The DISTRONIC PLUS distance display appears in the multifunction display (▷ page 202).

If the **Sensors Deactivated** message appears, the radar sensor system is deactivated.

- ▶ Activate the radar sensor system (▷ page 277).

Switching the distance warning function on and off

- ▶ Press or on the steering wheel to select the **DriveAssist** menu.
- ▶ Press or to select **Dist. Warning**.
- ▶ Press the button.
The current selection is displayed.
- ▶ **To activate/deactivate:** press the button again.

When the distance warning function is activated, the multifunction display shows the symbol if the HOLD function is not activated (▷ page 207).

Vehicles with Active Parking Assist: if PARKTRONIC is activated and you are driving at a speed under 22 mph (35 km/h), the Active Parking Assist symbol is shown instead of the symbol (▷ page 217).

Further information on the distance warning function (▷ page 68).

Activating/deactivating PRE-SAFE® Brake

PRE-SAFE® Brake is only available in vehicles with DISTRONIC PLUS.

- ▶ Press or on the steering wheel to select the **DriveAssist** menu.
- ▶ Press the or button to select **PRE-SAFE Brake**.
- ▶ Press the button.
The current selection is displayed.
- ▶ **To activate/deactivate:** press the button again.

When PRE-SAFE® Brake is activated, the multifunction display shows the symbol as long as the HOLD function is not activated (▷ page 207).







Vehicles with Active Parking Assist: if PARKTRONIC is activated and you are driving at a speed under 22 mph (35 km/h), the Active Parking Assist symbol is shown instead of the symbol (▷ page 217).

If the **PRE-SAFE Brake: Sensors Deactivated** message appears, the radar sensor system is deactivated.

- ▶ Activate the radar sensor system (▷ page 277).

For more information on PRE-SAFE® Brake, see (▷ page 73).







Activating/deactivating ATTENTION ASSIST

- ▶ Press  or  on the steering wheel to select the **DriveAssist** menu.
- ▶ Press the  or  button to select **Attention Asst.**
- ▶ Press the  button.
The current selection is displayed.
- ▶ **To activate/deactivate:** press the  button again.

When ATTENTION ASSIST is activated, the  symbol appears in the multifunction display when the ignition is on.

For further information about ATTENTION ASSIST, see (▷ page 230).

Activating/deactivating Blind Spot Assist

- ▶ Press  or  on the steering wheel to select the **DriveAssist** menu.
- ▶ Press the  or  button to select **Blind Spot Asst..**
- ▶ Press the  button.
The current selection is displayed.
- ▶ **To activate/deactivate:** press the  button again.









If the **Blind Spot Assist Sensors Deactivated** or **Active Blind Spot Assist Sensors Deactivated** message appears, the radar sensor system is deactivated.

- ▶ Activate the radar sensor system (▷ page 277).

For further information about Blind Spot Assist, see (▷ page 233).

For further information about Active Blind Spot Assist, see (▷ page 237).

Activating/deactivating Lane Keeping Assist

- ▶ Press  or  on the steering wheel to select the **DriveAssist** menu.
- ▶ Press the  or  button to select **Lane Keep. Asst.**
- ▶ Press the  button.
The current selection is displayed.
- ▶ Press  to confirm.
- ▶ Press  or  to set **Off, Standard** or **Adaptive**.
- ▶ Press the  button to save the setting.

When Lane Keeping Assist or Active Lane Keeping Assist is activated, the  symbol appears in the multifunction display when the ignition is on.

For further information about Lane Keeping Assist, see (▷ page 235).

For further information about Active Lane Keeping Assist, see (▷ page 241).

Maintenance menu



In the **Serv** menu, you have the following options:

- call up display messages in message memory (▷ page 282)
- restart the tire pressure loss warning system (▷ page 406)

- check the tire pressure electronically (▷ page 406)
- call up service due date (▷ page 369)

Settings menu

Introduction

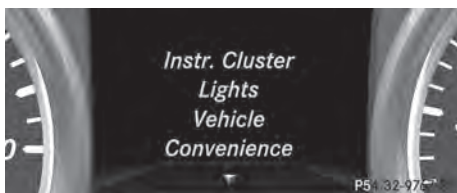

In the **Sett.** menu, you have the following options:

- changing the instrument cluster settings (▷ page 274)
- changing the light settings (▷ page 274)
- changing the vehicle settings (▷ page 276)
- changing the convenience settings (▷ page 277)
- restoring the factory settings (▷ page 278)

Instrument cluster submenu

Selecting the unit of measurement for distance

The **Display Unit Speed-/Odometer:** function allows you to choose whether certain displays appear in kilometers or miles in the multifunction display.

You can determine whether the multifunction display shows some messages in miles or kilometers.

- ▶ Press the or button on the steering wheel to select the **Sett.** menu.
- ▶ Press the or button to select the **Inst. Cluster** submenu.
- ▶ Press to confirm.

- ▶ Press the or button to select the **Display Unit Speed-/Odometer:** function.
You will see the selected setting: **km** or **miles**.
- ▶ Press the button to save the setting.

The selected unit of measurement for distance applies to:

- the digital speedometer in the **Trip** menu
- the odometer and the trip odometer
- the trip computer
- current consumption and the range
- the navigation instructions in the **Navi** menu
- cruise control
- DISTRONIC PLUS
- ASSYST PLUS service interval display

Selecting the permanent display function

You can determine whether the multifunction display permanently shows your speed or the outside temperature.







- ▶ Press the or button on the steering wheel to select the **Sett.** menu.
- ▶ Press the or button to select the **Inst. Cluster** submenu.
- ▶ Press to confirm.
- ▶ Press the or button to select the **Permanent Display:** function.
You will see the selected setting: **Outside Temperature** or **Speedometer km/h** (USA)/**Speedometer mph** (Canada).
- ▶ Press the button to save the setting.

- i** The speed is shown in km/h (USA)/mph (Canada).

Light submenu

Setting the daytime running lamps

- i** This function is not available in Canada.







- ▶ Press the  or  button on the steering wheel to select the **Sett.** menu.
- ▶ Press the  or  button to select the **Lights** submenu.
- ▶ Press  to confirm.
- ▶ Press  or  to select the **Daytime Running Lights:** function.

If the **Daytime Running Lights:** have been switched on, the cone of light and the  symbol in the multifunction display are shown in red.

- ▶ Press the  button to save the setting.

Further information on daytime running lamps (▷ page 120).

Switching Adaptive Highbeam Assist on/off









- ▶ Press the  or  button on the steering wheel to select the **Sett.** menu.
- ▶ Press the  or  button to select the **Lights** submenu.
- ▶ Press  to confirm.
- ▶ Press the  or  button to select the **Adaptive Highbeam** function.





If the **Adaptive Highbeam** function has been switched on, the cone of light and the  symbol in the upper multifunction display are shown in red.

- ▶ Press the  button to save the setting.













For further information about Adaptive Highbeam Assist, see (▷ page 126).

Setting the brightness of the ambient lighting









- ▶ Press the  or  button on the steering wheel to select the **Sett.** menu.
 - ▶ Press the  or  button to select the **Lights** submenu.
 - ▶ Press  to confirm.
 - ▶ Press the  or  button to select the **Amb. Light +/-** function.
- You will see the selected setting.
- ▶ Press  to confirm.

- ▶ Press the  or  button to adjust the brightness to any level from **Off** to **Level 5** (bright).
- ▶ Press the  or  button to save the setting.

Setting the ambient lighting color

- ▶ Press the  or  button on the steering wheel to select the **Sett.** menu.
- ▶ Press the  or  button to select the **Lights** submenu.
- ▶ Press  to confirm.
- ▶ Press the  or  button to select the **Ambient Light Color** function.
- ▶ Press  to confirm.
- ▶ Press the  or  button to set the color to **SOLAR**, **NEUTRAL** or **POLAR**.
- ▶ Press the  or  button to save the setting.

Surround lighting and exterior lighting delayed switch-off

- ▶ Press the  or  button on the steering wheel to select the **Sett.** menu.
 - ▶ Press the  or  button to select the **Light** submenu.
 - ▶ Press  to confirm.
 - ▶ Press  or  to select the **Surround Lighting** function.
- When the **Surround Lighting** function is activated, the light cone and the area around the vehicle are displayed in red in the multifunction display.
- ▶ Press the  button to save the setting.

Deactivating delayed switch-off of the exterior lighting temporarily:

- ▶ Before leaving the vehicle, turn the SmartKey to position **0** in the ignition lock.
 - ▶ Turn the SmartKey to position **2** in the ignition lock.
- The exterior lighting delayed switch-off is deactivated.

Delayed switch-off of the exterior lighting is reactivated the next time you start the engine.

If you have activated the **Surround Lighting** function and the light switch is set to **AUTO**, the following functions are activated when it is dark:







- **Surround lighting:** the exterior lighting remains lit for 40 seconds after unlocking with the SmartKey. If you start the engine, the surround lighting is switched off and the automatic headlamp mode is activated (▷ page 120).
- **Exterior lighting delayed switch-off:** the exterior lighting remains lit for 60 seconds after the engine is switched off. If you close all the doors and the tailgate, the exterior lighting goes off after 5 seconds.

i Depending on your vehicle's equipment, when the surround lighting and delayed switch-off exterior lighting are on, the following light up:

- Parking lamps
- Daytime running lamps
- Side marker lamps
- Surround lighting in the exterior mirrors

Activating/deactivating the interior lighting delayed switch-off

If you activate the **Interior Lighting Delay** function, the interior lighting remains on for 20 seconds after you remove the SmartKey from the ignition lock.

- ▶ Press the  or  button on the steering wheel to select the **Sett.** menu.
- ▶ Press the  or  button to select the **Lights** submenu.
- ▶ Press **OK** to confirm.
- ▶ Press  or  to select the **Interior Lighting Delay** function. When the **Interior Lighting Delay** function is activated, the vehicle interior is







displayed in red in the multifunction display.

- ▶ Press the **OK** button to save the setting.

Vehicle submenu

Activating/deactivating the automatic door locking mechanism







If you activate the **Automatic Door Lock** function, the vehicle is centrally locked above a speed of around 9 mph (15 km/h).

- ▶ Press the  or  button on the steering wheel to select the **Sett.** menu.
- ▶ Press  or  to select the **Vehicle** submenu.
- ▶ Press **OK** to confirm.
- ▶ Press  or  to select the **Automatic Door Lock** function. When the **Automatic Door Lock** function is activated, the vehicle doors are displayed in red in the multifunction display.
- ▶ Press the **OK** button to save the setting.









For further information on the automatic locking feature, see (▷ page 86).

Activating/deactivating the acoustic locking verification signal

If you switch on the **Acoustic Lock** function, an acoustic signal sounds when you lock the vehicle.

- ▶ Press the  or  button on the steering wheel to select the **Sett.** menu.
- ▶ Press  or  to select the **Vehicle** submenu.
- ▶ Press **OK** to confirm.
- ▶ Press the  or  button to select the **Acoustic Lock** function. If the **Acoustic Lock** function is activated, the  symbol in the multifunction display lights up red.
- ▶ Press the **OK** button to save the setting.

Activating/deactivating the radar sensor system

- ▶ Press the  or  button on the steering wheel to select the **Sett.** menu.
- ▶ Press  or  to select the **Vehicle** submenu.
- ▶ Press  to confirm.
- ▶ Press the  or  button to select **Radar Sensor (See Oper. Manual)**. You will see the selected setting: **Enabled** or **Disabled**.
- ▶ Press the  button to save the setting.

The following systems are switched off when the radar sensor system is deactivated:

- DISTRONIC PLUS (▷ page 194)
- BAS PLUS (▷ page 67)
- PRE-SAFE® Brake (▷ page 73)
- Blind Spot Assist (▷ page 233)
- Active Blind Spot Assist (▷ page 237)

Convenience submenu





Activating/deactivating the EASY-ENTRY/EXIT feature





WARNING

You must make sure no one can become trapped or injured by the moving steering wheel when the easy-entry/exit feature is activated.









To stop steering wheel movement, move steering wheel adjustment lever or press one of the memory position buttons.

Do not leave children unattended in the vehicle, or with access to an unlocked vehicle. Children could open the driver's door and unintentionally activate the easy-entry/exit feature, which could result in an accident and/or serious personal injury.

- ▶ Press the  or  button on the steering wheel to select the **Sett.** menu.
- ▶ Press the  or  button to select the **Convenience** submenu.

- ▶ Press  to confirm.
- ▶ Press  or  to select the **Easy Entry/Exit** function. If the **Easy Entry/Exit** function is activated, the vehicle steering wheel is displayed in red in the multifunction display.
- ▶ Press the  button to save the setting. Further information on the EASY-ENTRY/EXIT feature (▷ page 112).

Switching the belt adjustment on/off





- ▶ Press the  or  button on the steering wheel to select the **Sett.** menu.
- ▶ Press the  or  button to select the **Convenience** submenu.
- ▶ Press  to confirm.
- ▶ Press the  or  button to select the **Belt Adjustment** function. When the **Belt Adjustment** function is activated, the vehicle seat belt is displayed in red in the multifunction display.
- ▶ Press the  button to save the setting.



For further information on belt adjustment, see (▷ page 57).

Switching the fold-in mirrors when locking feature on/off

This function is only available on vehicles with the memory function (▷ page 116).

When you activate the **Auto. Mirror Folding** function, the exterior mirrors are folded in when the vehicle is locked. If you unlock the vehicle and then open a door, the exterior mirrors fold out again.

- ▶ Press the  or  button on the steering wheel to select the **Sett.** menu.
- ▶ Press the  or  button to select the **Convenience** submenu.
- ▶ Press  to confirm.

- ▶ Press  or  to select the **Auto. Mirror Folding** function. If the **Auto. Mirror Folding** function is activated, the vehicle's exterior mirror is displayed in red in the multifunction display.
- ▶ Press the  button to save the setting.











- ① To fold the exterior mirrors in or out

If you have switched the **Auto. Mirror Folding** on and you fold the exterior mirrors in using button ①, they will not fold out automatically (▷ page 114).

You can then only fold out the exterior mirrors using button ①.

Restoring the factory settings



- ▶ Press the  or  button on the steering wheel to select the **Sett.** menu.
- ▶ Press the  or  button to select the **Factory Setting** submenu.
- ▶ Press  to confirm. The **Reset All Settings?** message appears.
- ▶ Press the  or  button to select **No** or **Yes**.
- ▶ Press  to confirm the selection. If you select **Yes**, the multifunction display shows a confirmation message.

For safety reasons, the **Daytime Running Lights** function in the **Lights** submenu is only reset if the vehicle is stationary.

ON&OFFROAD menu



Multifunction display (example)

- ▶ Press the  or  button on the steering wheel to select the **ON&OFFROAD** menu.

You can set the following current settings to appear in the **ON&OFFROAD** menu:



- On-road program (▷ page 243)
- Off-road program (▷ page 248)

AMG menu in AMG vehicles

AMG displays



- ① Digital speedometer
- ② Gear indicator
- ③ Upshift indicator
- ④ Engine oil temperature
- ⑤ Coolant temperature
- ⑥ ECO start/stop function status indicator (▷ page 161)

- ▶ Press the  or  button on the steering wheel to select the **AMG** menu.

Upshift indicator **UP** ③ indicates that the engine has reached the overrevving range when in the manual gearshift program. Upshift indicator **UP** ③ fades out other messages until you have shifted up.

When the engine oil temperature is below 176 °F (80 °C) the oil temperature is shown in

blue. Avoid driving at full engine output during this time.

SETUP

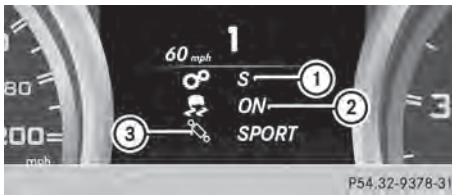

- ① Drive program (C/S/M)
- ② ESP® mode (ON/OFF)
- ③ Suspension tuning (COMFORT/SPORT/SPORT+)

SETUP shows the drive program, the ESP® (Electronic Stability Program) mode and the suspension tuning.

- ▶ Press the ◀ or ▶ button on the steering wheel to select the **AMG** menu.
- ▶ Press the ▲ button repeatedly until SETUP is displayed.

RACETIMER

Displaying and starting RACETIMER

The RACETIMER is only intended for use on a closed race circuit. Do not use the function on public roads.



- ① Lap
- ② RACETIMER

You can start the RACETIMER when the engine is running or if the SmartKey is in position **2** in the ignition lock.

- ▶ Press the ◀ or ▶ button on the steering wheel to select the **AMG** menu.
- ▶ Press the ▲ button repeatedly until the RACETIMER is shown.
- ▶ **To start:** press the OK button to start the RACETIMER.

Displaying the intermediate time



- ▶ Press the ◀ or ▶ button to select **Interm. Time**.
- ▶ Press OK to confirm.
The intermediate time is displayed for five seconds.

Starting a new lap





- ① RACETIMER
 - ② Fastest lap time (best lap)
 - ③ Lap
- ▶ Press OK to confirm **New Lap**.

- ❗ It is possible to store a maximum of sixteen laps. The 16th lap can only be completed with **Finish Lap**.



Stopping the RACETIMER



- ▶ Press the  button on the steering wheel.
- ▶ Press  to confirm **Yes**.

The RACETIMER interrupts timing when you stop the vehicle and turn the SmartKey to position **1** in the ignition lock. If you turn the SmartKey to position **2** or **3** and then press  to confirm **Start**, timing is continued.

Resetting the current lap



- ▶ Stop the RACETIMER.
- ▶ Press the  or  button to select **Reset Lap**.
- ▶ Press  to reset the lap time to "0".

Deleting all laps



If you switch off the engine, the RACETIMER is reset to "0" after 30 seconds. All laps are deleted.

You cannot delete individual stored laps. If you have stopped 16 laps, the current lap does not have to be reset.



- ▶ Reset the current lap.
- ▶ Press  to confirm **Reset**. **Reset Race Timer?** appears in the multifunction display.
- ▶ Press the  button to select **Yes** and press the  button to confirm. All laps are deleted.

Overall statistics



- ① RACETIMER overall evaluation
- ② Total time driven
- ③ Average speed
- ④ Distance covered
- ⑤ Maximum speed

This function is shown if you have stored at least one lap and stopped the RACETIMER.



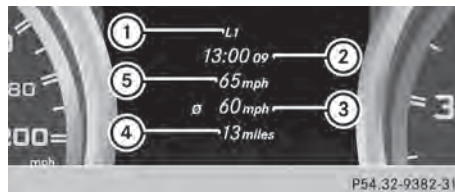

- ▶ Press the  or  button on the steering wheel to select the **AMG** menu.
- ▶ Press the  button repeatedly until the overall evaluation is shown.

Lap statistics



- ① Lap
- ② Lap time
- ③ Average lap speed
- ④ Lap length
- ⑤ Top speed during lap

This function is only available if you have stored at least two laps and have stopped the RACETIMER.

- ▶ Press the  or  button on the steering wheel to select the **AMG** menu.
- ▶ Press the  button repeatedly until the lap evaluation is shown.
Each lap is shown in a separate submenu.
The fastest lap is indicated by flashing symbol ①.
- ▶ Press the  or  button to select a different lap evaluation.

Display messages

Introduction

General notes

Display messages appear in the multifunction display.

Display messages with graphic displays may be shown in simplified form in the Operator's Manual and may differ from the messages shown in the multifunction display.



Please respond in accordance with the display messages and follow the additional notes in this Operator's Manual.

Certain display messages are accompanied by an audible warning tone or a continuous tone.

When you stop and park the vehicle, please observe the notes on:

- HOLD function (▷ page 207)
- Parking (▷ page 179)

Hiding display messages







- ▶ Press the  or  button on the steering wheel to hide the display message. The display message is cleared.

The multifunction display shows high-priority display messages in red. Some high-priority display messages cannot be hidden.

The multifunction display shows these messages continuously until the causes for the messages have been remedied.











Message memory



The on-board computer saves certain display messages in the **message memory**. You can call up the display messages:









- ▶ Press the  or  button on the steering wheel to select the **Serv.** menu. If there are display messages, the multifunction display shows **2 Messages**, for example.
- ▶ Press the  or  button to select the entry, e.g. **2 Messages**.
- ▶ Press  to confirm.
- ▶ Press the  or  button to scroll through the display messages.







When the ignition is switched off, all display messages are deleted, apart from some high-priority display messages. Once the causes of the high-priority display messages have been rectified, the corresponding display messages are also deleted.









Safety systems















| Display messages | Possible causes/consequences and ► Solutions |
|--|--|
|   Currently Unavailable See Operator's Manual | <p>ABS (Anti-lock Braking System), ESP® (Electronic Stability Program), BAS (Brake Assist), PRE-SAFE®, the HOLD function, hill start assist and ESP® trailer stabilization are temporarily unavailable.</p> <p>COLLISION PREVENTION ASSIST, BAS PLUS and PRE-SAFE® Brake may also have failed.</p> <p>In addition, the ,  and  warning lamps light up in the instrument cluster.</p> <p>ATTENTION ASSIST is deactivated.</p> <p>Possible causes are:</p> <ul style="list-style-type: none"> • Self-diagnosis is not yet complete. • The on-board voltage may be insufficient. <p>⚠ WARNING</p> <p>The brake system continues to function normally, but without the functions listed above. The wheels could therefore lock if you brake hard, for example.</p> <p>The steerability and braking characteristics may be severely affected. The braking distance in an emergency braking situation can increase.</p> <p>If ESP® is not operational, ESP® is unable to stabilize the vehicle. There is an increased risk of skidding and an accident.</p> <p>► Carefully drive a short distance on a suitable stretch of road, making slight steering movements at a speed above 12 mph (20 km/h).</p> <p>If the display message disappears, the functions mentioned above are available again.</p> <p>If the display message continues to be displayed:</p> <ul style="list-style-type: none"> ► Drive on carefully. ► Visit a qualified specialist workshop. |
|   Inoperative See Operator's Manual | <p>ABS, ESP®, BAS, PRE-SAFE®, the HOLD function, hill start assist and ESP® trailer stabilization are unavailable due to a malfunction. COLLISION PREVENTION ASSIST, BAS PLUS and PRE-SAFE® Brake may also have failed.</p> <p>The BRAKE (USA only)/ (Canada only), ,  and  warning lamps in the instrument cluster also light up.</p> <p>ATTENTION ASSIST is deactivated.</p> <p>⚠ WARNING</p> |







| Display messages | Possible causes/consequences and ► Solutions |
|--|---|
| | <p>The brake system continues to function normally, but without the functions listed above. The wheels could therefore lock if you brake hard, for example.</p> <p>The steerability and braking characteristics may be severely affected. The braking distance in an emergency braking situation can increase.</p> <p>If ESP® is not operational, ESP® is unable to stabilize the vehicle. There is an increased risk of skidding and an accident.</p> <ul style="list-style-type: none"> ► Drive on carefully. ► Visit a qualified specialist workshop immediately. |
|  <p>Currently Unavailable See Operator's Manual</p> | <p>ESP®, BAS, PRE-SAFE®, the HOLD function, hill start assist and ESP® trailer stabilization are unavailable due to a malfunction. COLLISION PREVENTION ASSIST, BAS PLUS and PRE-SAFE® Brake may also have failed.</p> <p>In addition, the  and  warning lamps light up in the instrument cluster.</p> <p>The self-diagnosis function might not be complete, for example. ATTENTION ASSIST is deactivated.</p> <p>⚠ WARNING</p> <p>The brake system continues to function normally, but without the functions listed above. The wheels could therefore lock if you brake hard, for example.</p> <p>The braking distance in an emergency braking situation can thus increase.</p> <p>If ESP® is not operational, ESP® is unable to stabilize the vehicle. There is an increased risk of skidding and an accident.</p> <ul style="list-style-type: none"> ► Carefully drive a short distance on a suitable stretch of road, making slight steering movements at a speed above 12 mph (20 km/h). <p>If the display message disappears, the functions mentioned above are available again.</p> <p>If the display message continues to be displayed:</p> <ul style="list-style-type: none"> ► Drive on carefully. ► Visit a qualified specialist workshop. |

| Display messages | Possible causes/consequences and ► Solutions |
|--|--|
|  <p>Inoperative See Operator's Manual</p> | <p>ESP®, BAS, PRE-SAFE®, the HOLD function, hill start assist and ESP® trailer stabilization are unavailable due to a malfunction. COLLISION PREVENTION ASSIST, BAS PLUS and PRE-SAFE® Brake may also have failed.</p> <p>In addition, the  and  warning lamps light up in the instrument cluster.</p> <p>ATTENTION ASSIST is deactivated.</p> <p>⚠ WARNING</p> <p>The brake system continues to function normally, but without the functions listed above. The wheels could therefore lock if you brake hard, for example.</p> <p>The braking distance in an emergency braking situation can thus increase.</p> <p>If ESP® is not operational, ESP® is unable to stabilize the vehicle. There is an increased risk of skidding and an accident.</p> <ul style="list-style-type: none"> ► Drive on carefully. ► Visit a qualified specialist workshop. |
|    <p>Inoperative See Operator's Manual</p> | <p>EBD (electronic brake force distribution), ABS, ESP®, BAS, PRE-SAFE®, the HOLD function, hill start assist and ESP® trailer stabilization are unavailable due to a malfunction. COLLISION PREVENTION ASSIST, BAS PLUS and PRE-SAFE® Brake may also have failed.</p> <p>In addition, the ,  and  warning lamps light up in the instrument cluster and a warning tone sounds.</p> <p>ATTENTION ASSIST is deactivated.</p> <p>⚠ WARNING</p> <p>The brake system continues to function normally, but without the functions listed above. The wheels could therefore lock if you brake hard, for example.</p> <p>The steerability and braking characteristics may be severely affected. The braking distance in an emergency braking situation can increase.</p> <p>If ESP® is not operational, ESP® is unable to stabilize the vehicle. There is an increased risk of skidding and an accident.</p> <ul style="list-style-type: none"> ► Drive on carefully. ► Visit a qualified specialist workshop immediately. |



| Display messages | Possible causes/consequences and ► Solutions |
|--|---|
| <p>PARK (USA only)  (Canada only)</p> <p>Please Release Parking Brake</p> | <p>The red PARK (USA only)/ (Canada only) indicator lamp flashes and a warning tone sounds. A condition for automatic release of the electric parking brake is not fulfilled (► page 180). You are driving with the electric parking brake applied.</p> <p>► Release the electric parking brake manually.</p> <p>The red PARK (USA only)/ (Canada only) indicator lamp flashes and a warning tone sounds. You are using the electric parking brake for emergency braking (► page 180).</p> |
| <p>PARK (USA only)  (Canada only)</p> <p>Parking Brake See Operator's Manual</p> | <p>The yellow  warning lamp lights up. The electric parking brake is malfunctioning.</p> <p>To apply:</p> <ul style="list-style-type: none"> ► Switch the ignition off. ► Press the electric parking brake handle for at least ten seconds. ► Shift the transmission to P. ► Consult a qualified specialist workshop. <p>The yellow  warning lamp and the red PARK (USA only)/ (Canada only) indicator lamp light up. The electric parking brake is malfunctioning.</p> <p>To release:</p> <ul style="list-style-type: none"> ► Switch off the ignition and turn it back on. ► Release the electric parking brake manually. <p>or</p> <ul style="list-style-type: none"> ► Release the electric parking brake automatically (► page 180). <p>If the electric parking brake still cannot be released:</p> <ul style="list-style-type: none"> ► Do not drive on. ► Consult a qualified specialist workshop. |









| Display messages | Possible causes/consequences and ► Solutions |
|------------------|---|
| | <p>The red  (USA only)/ (Canada only) indicator lamp flashes and the yellow  warning lamp lights up. The electric parking brake is malfunctioning.</p> <p>To release:</p> <ul style="list-style-type: none"> ▶ Switch off the ignition and turn it back on. ▶ Release the electric parking brake manually. <p>To apply:</p> <ul style="list-style-type: none"> ▶ Switch off the ignition and turn it back on. ▶ Apply the electric parking brake manually. <p>If the red  (USA only)/ (Canada only) indicator lamp continues to flash:</p> <ul style="list-style-type: none"> ▶ Do not drive on. ▶ Secure the vehicle against rolling away (▷ page 422). ▶ Shift the transmission to P. ▶ Turn the front wheels towards the curb. ▶ Consult a qualified specialist workshop. |
| | <p>The yellow  warning lamp lights up. The red  (USA only)/ (Canada only) indicator lamp flashes for about ten seconds after the electric parking brake has been applied or released. It then goes out or remains lit. The electric parking brake is malfunctioning.</p> <ul style="list-style-type: none"> ▶ Switch off the ignition and turn it back on. ▶ Apply the electric parking brake. <p>If it is not possible to engage the electric parking brake:</p> <ul style="list-style-type: none"> ▶ Shift the transmission to P. ▶ Visit a qualified specialist workshop. <p>If it is not possible to release the electric parking brake:</p> <ul style="list-style-type: none"> ▶ Release the electric parking brake automatically (▷ page 180). <p>If the electric parking brake still cannot be released:</p> <ul style="list-style-type: none"> ▶ Consult a qualified specialist workshop. |



| Display messages | Possible causes/consequences and ► Solutions |
|--|--|
| | <p>The yellow  warning lamp lights up. If you manually apply or release the electric parking brake, the red  (USA only)/ (Canada only) indicator lamp flashes.</p> <p>The electric parking brake is malfunctioning. It is not possible to apply the electric parking brake manually.</p> <ul style="list-style-type: none"> ► Shift the transmission to P. ► Visit a qualified specialist workshop. |
| <p> (USA only)  (Canada only)</p> <p>Parking Brake Inoperative</p> | <p>The yellow  warning lamp lights up. The red  (USA only)/ (Canada only) indicator lamp flashes for about ten seconds after the electric parking brake has been applied or released. It then goes out or remains lit.</p> <p>The electric parking brake is malfunctioning, e.g. because of overvoltage or undervoltage.</p> <ul style="list-style-type: none"> ► Remove the cause for the overvoltage or undervoltage, e.g. by charging the battery or restarting the engine. ► Engage or release the electric parking brake. <p>If it remains impossible to apply or release the electric parking brake:</p> <ul style="list-style-type: none"> ► Switch off the ignition and turn it back on. ► Engage or release the electric parking brake. <p>If the electric parking brake still cannot be released:</p> <ul style="list-style-type: none"> ► Consult a qualified specialist workshop. <p>The display message is only shown while the vehicle is in motion. The yellow  warning lamp lights up and the red  (USA only)/ (Canada only) indicator lamp flashes.</p> <p>It is not possible to apply the electric parking brake manually.</p> <ul style="list-style-type: none"> ► Shift the transmission to P. ► Visit a qualified specialist workshop. |
| <p> (USA only)  (Canada only)</p> <p>Turn On the Ignition to Release the Parking Brake</p> | <p>The red  (USA only)/ (Canada only) indicator lamp lights up.</p> <p>You attempted to release the electric parking brake while the ignition was switched off.</p> <ul style="list-style-type: none"> ► SmartKey: turn the SmartKey to position 1 in the ignition lock. ► KEYLESS-GO: switch on the ignition. |



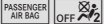

| Display messages | Possible causes/consequences and ► Solutions |
|--|--|
| <p> (USA only)  (Canada only)</p> <p>Check Brake Fluid Level</p> | <p>There is not enough brake fluid in the brake fluid reservoir. In addition, the  (USA only)/ (Canada only) warning lamp lights up in the instrument cluster and a warning tone sounds.</p> <p> WARNING</p> <p>The braking effect may be impaired. There is a risk of an accident.</p> <ul style="list-style-type: none"> ► Pull over and stop the vehicle safely as soon as possible, paying attention to road and traffic conditions. Do not continue driving under any circumstances. ► Secure the vehicle against rolling away (> page 179). ► Consult a qualified specialist workshop. ► Do not add brake fluid. This does not correct the malfunction. |
| <p></p> <p>Check Brake Pad Wear</p> | <p>The brake pads/linings have reached their wear limit.</p> <ul style="list-style-type: none"> ► Visit a qualified specialist workshop. |
| <p></p> <p>mbrace Inoperative</p> | <p>USA only: one or more of the main functions in the mbrace system are malfunctioning.</p> <p>Canada only: one or more of the main functions of the TELEAID system are malfunctioning.</p> <ul style="list-style-type: none"> ► USA only: have the mbrace system checked at a qualified specialist workshop. ► Canada only: have the TELEAID system checked at a qualified specialist workshop. |
| <p>PRE-SAFE Inoperative See Operator's Manual</p> | <p>Important functions of PRE-SAFE® have failed. All other occupant safety systems, e.g. air bags, remain available.</p> <ul style="list-style-type: none"> ► Visit a qualified specialist workshop immediately. |

| Display messages | Possible causes/consequences and ► Solutions |
|---|---|
| <p>PRE-SAFE Functions Currently Limited See Operator's Manual</p> | <p>Vehicles without the Active Driving Assistance package: Adaptive Brake Assist is temporarily inoperative. Possible causes are:</p> <ul style="list-style-type: none"> • function is impaired due to heavy rain or snow. • the sensor in the bumper is dirty. • the radar sensor system is temporarily inoperative, e.g. due to electromagnetic radiation emitted by nearby TV or radio stations or other sources of electromagnetic radiation. • AMG vehicles: ESP® is deactivated. • the system is outside the operating temperature range. • the on-board voltage is too low. <p>When the causes stated above no longer apply, the display message disappears.</p> <p>Adaptive Brake Assist is operational again.</p> <p>If the display message does not disappear:</p> <ul style="list-style-type: none"> ► Pull over and stop the vehicle safely as soon as possible, paying attention to road and traffic conditions. ► Secure the vehicle against rolling away (▷ page 179). ► Clean the bumpers (▷ page 373). ► Restart the engine. ► AMG vehicles: reactivate ESP® (▷ page 71). |

| Display messages | Possible causes/consequences and ► Solutions |
|---|--|
| <p>PRE-SAFE Functions Currently Limited See Operator's Manual</p> | <p>Vehicles with the Active Driving Assistance package: PRE-SAFE® Brake is temporarily inoperative. Possible causes are:</p> <ul style="list-style-type: none"> • function is impaired due to heavy rain or snow. • the sensors in the radiator grill and the bumper are dirty. • the radar sensor system is temporarily inoperative, e.g. due to electromagnetic radiation emitted by nearby TV or radio stations or other sources of electromagnetic radiation. • AMG vehicles: ESP® is deactivated. • the system is outside the operating temperature range. • the on-board voltage is too low. <p>When the causes stated above no longer apply, the display message disappears. PRE-SAFE® Brake is operational again.</p> <p>If the display message does not disappear:</p> <ul style="list-style-type: none"> ► Pull over and stop the vehicle safely as soon as possible, paying attention to road and traffic conditions. ► Secure the vehicle against rolling away (> page 179). ► Clean the sensors in the radiator grill and the bumper (> page 373). ► Restart the engine. ► AMG vehicles: reactivate ESP® (> page 71). |
| <p>PRE-SAFE Functions Limited See Operator's Manual</p> | <p>Vehicles without the Active Driving Assistance package: Adaptive Brake Assist is faulty. The distance warning function may also have failed.</p> <p>Vehicles with the Active Driving Assistance package: PRE-SAFE® Brake is faulty. BAS PLUS or the distance warning function may also have failed.</p> <ul style="list-style-type: none"> ► Visit a qualified specialist workshop. |
| <p> SRS Malfunction Service Required</p> | <p>There is a malfunction in the SRS (Supplemental Restraint System). The  warning lamp also lights up in the instrument cluster.</p> <p>⚠ WARNING</p> <p>The air bags or Emergency Tensioning Devices may either be triggered unintentionally or, in the event of an accident, may not be triggered.</p> <p>There is an increased risk of injury.</p> <ul style="list-style-type: none"> ► Visit a qualified specialist workshop. <p>Further information on occupant safety (> page 43).</p> |

| Display messages | Possible causes/consequences and ► Solutions |
|--|---|
|  <p>Front Left Malfunction Service Required or Front Right Malfunction Service Required</p> | <p>SRS has malfunctioned at the front on the left or right. The  warning lamp also lights up in the instrument cluster.</p> <p>⚠ WARNING</p> <p>The air bags or Emergency Tensioning Devices may either be triggered unintentionally or, in the event of an accident, may not be triggered.</p> <p>There is an increased risk of injury.</p> <p>► Visit a qualified specialist workshop.</p> |
|  <p>Rear Left Malfunction Service Required or Rear Right Malfunction Service Required</p> | <p>SRS has malfunctioned at the rear on the left or right. The  warning lamp also lights up in the instrument cluster.</p> <p>⚠ WARNING</p> <p>The air bags or Emergency Tensioning Devices may either be triggered unintentionally or, in the event of an accident, may not be triggered.</p> <p>There is an increased risk of injury.</p> <p>► Visit a qualified specialist workshop.</p> |
|  <p>Rear Center Malfunction Service Required</p> | <p>SRS has malfunctioned at the rear center. The  warning lamp also lights up in the instrument cluster.</p> <p>⚠ WARNING</p> <p>The air bags or Emergency Tensioning Devices may either be triggered unintentionally or, in the event of an accident, may not be triggered.</p> <p>There is an increased risk of injury.</p> <p>► Visit a qualified specialist workshop.</p> |
|  <p>Left Side Curtain Airbag Malfunction Service Required or Right Side Curtain Airbag Malfunction Service Required</p> | <p>There is a malfunction in the left-hand or right-hand window curtain air bag. The  warning lamp also lights up in the instrument cluster.</p> <p>⚠ WARNING</p> <p>The left or right window curtain air bag may either be triggered unintentionally or, in the event of an accident, may not be triggered.</p> <p>There is an increased risk of injury.</p> <p>► Visit a qualified specialist workshop.</p> |

| Display messages | Possible causes/consequences and ► Solutions |
|---|---|
| <p>Front Passenger Airbag Enabled See Operator's Manual</p> | <p>The front-passenger air bag is enabled during the journey, even though:</p> <ul style="list-style-type: none"> • a child, a small adult or an object weighing less than the system's weight threshold is located on the front-passenger seat. or • the front-passenger seat is unoccupied. <p>The system may detect objects or forces applying additional weight on the seat.</p> <p> WARNING</p> <p>The air bag may deploy unintentionally. There is an increased risk of injury.</p> <ul style="list-style-type: none"> ► Pull over and stop the vehicle safely as soon as possible, paying attention to road and traffic conditions. ► Secure the vehicle against rolling away (► page 179). ► Switch the ignition off. ► Open the front-passenger door. ► Remove the child and the child restraint system from the front-passenger seat. ► Make sure that there are no objects on the seat adding to the weight. <p>The system may otherwise detect the additional weight and interpret the seat occupant's weight as greater than it actually is.</p> <ul style="list-style-type: none"> ► Keep the seat unoccupied, close the front-passenger door and switch on the ignition. ► Observe the  indicator lamp in the center console and the multifunction display and check the following: <p>Seat unoccupied and ignition switched on:</p> <ul style="list-style-type: none"> • the  indicator lamp must light up and remain lit. When the indicator lamp is on, OCS (Occupant Classification System) has disabled the front-passenger air bag (► page 48). • the Front Passenger Airbag Enabled See Operator's Manual or Front Passenger Airbag Disabled See Operator's Manual display messages must not be shown in the multifunction display. <ul style="list-style-type: none"> ► Wait for a period of at least 60 seconds until the necessary system checks have been completed. ► Make sure that the display messages do not appear in the multifunction display. |





| Display messages | Possible causes/consequences and ► Solutions |
|--|--|
| | <p>If these conditions are fulfilled, the front-passenger seat can be occupied again. Whether the  indicator lamp remains lit or goes out depends on how OCS classifies the occupant. If the conditions are not fulfilled, the system is not operating correctly.</p> <p>► Visit a qualified specialist workshop immediately.</p> |
| <p>Front Passenger Airbag Disabled See Operator's Manual</p> | <p>The front-passenger air bag is disabled during the journey, even though:</p> <ul style="list-style-type: none"> • an adult or • a person larger than a certain size is occupying the front-passenger seat. <p>If additional forces are applied to the seat, the system may interpret the occupant's weight as lower than it actually is.</p> <p> WARNING</p> <p>The front-passenger air bag does not deploy during an accident. There is an increased risk of injury.</p> <ul style="list-style-type: none"> ► Pull over and stop the vehicle safely as soon as possible, paying attention to road and traffic conditions. ► Secure the vehicle against rolling away (▷ page 179). ► Switch the ignition off. ► Have the occupant get out of the vehicle. ► Keep the seat unoccupied, close the front-passenger door and switch on the ignition. ► Observe the  indicator lamp in the center console and the multifunction display and check the following: <p>Seat unoccupied and ignition switched on:</p> <ul style="list-style-type: none"> • the  indicator lamp must light up and remain lit. When the indicator lamp is on, OCS has disabled the front-passenger air bag (▷ page 48). • the Front Passenger Airbag Enabled See Operator's Manual or Front Passenger Airbag Disabled See Operator's Manual display messages must not be shown in the multifunction display. <ul style="list-style-type: none"> ► Wait for a period of at least 60 seconds until the necessary system checks have been completed. ► Make sure that the display messages do not appear in the multifunction display. |







| Display messages | Possible causes/consequences and ► Solutions |
|------------------|--|
| | <p>If these conditions are fulfilled, the front-passenger seat can be occupied again. Whether the  indicator lamp remains lit or goes out depends on how OCS classifies the occupant. If the conditions are not fulfilled, the system is not operating correctly.</p> <p>► Visit a qualified specialist workshop immediately.</p> |







Lights





i Display messages about LEDs:



This display message will only appear if all LEDs have failed.



| Display messages | Possible causes/consequences and ► Solutions |
|--|--|
|  Check Left Cornering Light or Check Right Cornering Light | <p>The left or right-hand cornering light is defective.</p> <p>► Check whether you are permitted to replace the bulb yourself (► page 129).</p> <p>or</p> <p>► Visit a qualified specialist workshop.</p> |
|  Check Left Low Beam or Check Right Low Beam | <p>The left or right-hand low-beam headlamp is defective.</p> <p>► Check whether you are permitted to replace the bulb yourself (► page 129).</p> <p>or</p> <p>► Visit a qualified specialist workshop.</p> |
|  Check Trailer Left Turn Signal or Check Trailer Right Turn Signal | <p>The left or right-hand trailer turn signal lamp is defective.</p> <p>► Check whether you are permitted to change the bulb yourself.</p> <p>or</p> <p>► Visit a qualified specialist workshop.</p> |
|  Check Rear Left Turn Signal or Check Rear Right Turn Signal | <p>The rear left-hand or rear right-hand turn signal is defective.</p> <p>► Check whether you are permitted to replace the bulb yourself (► page 129).</p> <p>or</p> <p>► Visit a qualified specialist workshop.</p> |







| Display messages | Possible causes/consequences and ► Solutions |
|--|---|
|  <p>Check Front Left Turn Signal or Check Front Right Turn Signal</p> | <p>The front left-hand or front right-hand turn signal is defective.</p> <ul style="list-style-type: none"> ► Check whether you are permitted to replace the bulb yourself (▷ page 129). <p>or</p> <ul style="list-style-type: none"> ► Visit a qualified specialist workshop. |
|  <p>Check Left Mirror Turn Signal or Check Right Mirror Turn Signal</p> | <p>The turn signal in the left-hand or right-hand exterior mirror is defective.</p> <ul style="list-style-type: none"> ► Check whether you are permitted to replace the bulb yourself (▷ page 129). <p>or</p> <ul style="list-style-type: none"> ► Visit a qualified specialist workshop. |
|  <p>Check Center Brake Lamp</p> | <p>The high-mounted brake lamp is faulty.</p> <ul style="list-style-type: none"> ► Check whether you are permitted to replace the bulb yourself (▷ page 129). <p>or</p> <ul style="list-style-type: none"> ► Visit a qualified specialist workshop. |
|  <p>Check Left Brake Lamp or Check Right Brake Lamp</p> | <p>The left or right-hand brake lamp is defective.</p> <ul style="list-style-type: none"> ► Check whether you are permitted to replace the bulb yourself (▷ page 129). <p>or</p> <ul style="list-style-type: none"> ► Visit a qualified specialist workshop. |
|  <p>Check Left Tail and Brake Lamps or Check Right Tail and Brake Lamps</p> | <p>The left or right-hand tail lamp/brake lamp is defective.</p> <ul style="list-style-type: none"> ► Check whether you are permitted to replace the bulb yourself (▷ page 129). <p>or</p> <ul style="list-style-type: none"> ► Visit a qualified specialist workshop. |
|  <p>Check Left High Beam or Check Right High Beam</p> | <p>The left or right-hand high beam is defective.</p> <ul style="list-style-type: none"> ► Check whether you are permitted to replace the bulb yourself (▷ page 129). <p>or</p> <ul style="list-style-type: none"> ► Visit a qualified specialist workshop. |



| Display messages | Possible causes/consequences and ► Solutions |
|--|---|
|  <p>License Plate Lamp</p> | <p>The left or right-hand license plate lamp is defective.</p> <ul style="list-style-type: none"> ► Check whether you are permitted to replace the bulb yourself (> page 129). <p>or</p> <ul style="list-style-type: none"> ► Visit a qualified specialist workshop. |
|  <p>Check Front Left Parking Lamp or Check Front Right Parking Lamp</p> | <p>The front left or front right parking or standing lamp is defective.</p> <ul style="list-style-type: none"> ► Check whether you are permitted to replace the bulb yourself (> page 129). <p>or</p> <ul style="list-style-type: none"> ► Visit a qualified specialist workshop. |
|  <p>Backup Light</p> | <p>The backup lamp is defective.</p> <ul style="list-style-type: none"> ► Check whether you are permitted to replace the bulb yourself (> page 129). <p>or</p> <ul style="list-style-type: none"> ► Visit a qualified specialist workshop. |
|  <p>Check Front Left Sidemarker Lamp or Check Front Right Sidemarker Lamp</p> | <p>The left or right front side marker lamp is defective.</p> <ul style="list-style-type: none"> ► Check whether you are permitted to replace the bulb yourself (> page 129). <p>or</p> <ul style="list-style-type: none"> ► Visit a qualified specialist workshop. |
|  <p>Check Left Tail Lamp or Check Right Tail Lamp</p> | <p>The left or right-hand tail lamp is defective.</p> <p>or</p> <p>The rear left or right side marker lamp is defective.</p> <ul style="list-style-type: none"> ► Check whether you are permitted to replace the bulb yourself (> page 129). <p>or</p> <ul style="list-style-type: none"> ► Visit a qualified specialist workshop. |
|  <p>Check Left Daytime Running Light or Check Right Daytime Running Light</p> | <p>The left-hand or right-hand daytime running lamp is faulty.</p> <ul style="list-style-type: none"> ► Check whether you are permitted to replace the bulb yourself (> page 129). <p>or</p> <ul style="list-style-type: none"> ► Visit a qualified specialist workshop. |

| Display messages | Possible causes/consequences and ► Solutions |
|--|---|
|  <p>Active Headlamps Inoperative</p> | <p>The active light function is defective.</p> <p>► Visit a qualified specialist workshop.</p> |
|  <p>Malfunction See Operator's Manual</p> | <p>The exterior lighting is defective.</p> <p>► Visit a qualified specialist workshop.</p> <p>Vehicles with trailer tow hitch: a fuse may have blown.</p> <p>► Check the fuses (▷ page 394).</p> <p>► If necessary, replace the blown fuse. Observe the warning notes.</p> <p>If the display message continues to be displayed:</p> <p>► Visit a qualified specialist workshop.</p> |
|  <p>Auto Lamp Function Inoperative</p> | <p>The light sensor is defective.</p> <p>► Visit a qualified specialist workshop.</p> |
|  <p>Switch Off Lights</p> | <p>The lights are still switched on when you leave the vehicle. A warning tone also sounds.</p> <p>► Turn the light switch to AUTO.</p> |
| <p>Adaptive Highbeam Assist Inoperative</p> | <p>Adaptive Highbeam Assist is faulty.</p> <p>► Visit a qualified specialist workshop.</p> |
| <p>Adaptive Highbeam Assist Currently Unavailable See Operator's Manual</p> | <p>Adaptive Highbeam Assist is deactivated and temporarily inoperative. Possible causes are:</p> <ul style="list-style-type: none"> • the windshield in the camera's field of vision is dirty. • visibility is impaired due to heavy rain, snow or fog. <p>► Clean the windshield.</p> <p>If the system detects that the camera is fully operational again, the Adaptive Highbeam Assist Now Available message is displayed.</p> <p>Adaptive Highbeam Assist is operational again.</p> |



| Engine | |
|---|---|
| Display messages | Possible causes/consequences and ► Solutions |
|  <p>Check Coolant Level See Operator's Manual</p> | <p>The coolant level is too low.</p> <p>! Avoid making long journeys with too little coolant in the engine cooling system. The engine will otherwise be damaged.</p> <ul style="list-style-type: none"> ► Add coolant, observing the warning notes before doing so (► page 367). ► If coolant needs to be added more often than usual, have the engine coolant system checked at a qualified specialist workshop. |
|  | <p>The fan motor is faulty.</p> <ul style="list-style-type: none"> ► At coolant temperatures under 248 °F (120 °C), drive to the next qualified specialist workshop. ► Avoid subjecting the engine to heavy loads, e.g. driving in mountainous terrain, and stop-and-go traffic. |
|  <p>Coolant Too Hot Stop Vehicle Turn Engine Off</p> | <p>The coolant is too hot. A warning tone also sounds.</p> <p>⚠ WARNING</p> <p>Do not drive when your engine is overheated. This can cause some fluids which may have leaked into the engine compartment to catch fire.</p> <p>Steam from the overheated engine can also cause serious burns which can occur just by opening the hood.</p> <p>There is a risk of injury.</p> <ul style="list-style-type: none"> ► Pull over and stop the vehicle safely and switch off the engine, paying attention to road and traffic conditions. ► Secure the vehicle against rolling away (► page 179). ► Wait until the engine has cooled down. ► Make sure that the air supply to the engine radiator is not blocked, e.g. by snow, slush or ice. ► Do not start the engine again until the display message goes out and the coolant temperature is under 248 °F (120 °C). Otherwise, the engine could be damaged. ► Pay attention to the coolant temperature display. ► If the temperature increases again, visit a qualified specialist workshop immediately. <p>Under normal operating conditions and with the specified coolant level, the coolant temperature may rise to 248 °F (120 °C).</p> |





| Display messages | Possible causes/consequences and ► Solutions |
|---|---|
|  | <p>The battery is not being charged. A warning tone also sounds. Possible causes are:</p> <ul style="list-style-type: none"> • a defective alternator • a torn poly-V-belt • a malfunction in the electronics <p>► Pull over and stop the vehicle safely and switch off the engine, paying attention to road and traffic conditions. ► Open the hood. ► Check whether the poly-V-belt is torn.</p> <p>If the poly-V-belt is torn:</p> <p>! Do not continue driving. The engine could otherwise overheat. ► Consult a qualified specialist workshop.</p> <p>If the poly-V-belt is not damaged:</p> <p>► Visit a qualified specialist workshop.</p> |
|  <p>Check Engine Oil At Next Refueling</p> | <p>The engine oil level has dropped to the minimum level. A warning tone also sounds.</p> <ul style="list-style-type: none"> ► Check the oil level when next refueling, at the latest (> page 366). ► If necessary, add engine oil (> page 366). ► Have the engine checked at a qualified specialist workshop if engine oil needs to be added more often than usual. <p>! Avoid long journeys with too little engine oil. The engine will otherwise be damaged.</p> <p>Information on approved engine oils can be obtained from any qualified specialist workshop or on the Internet at http://www.mbusa.com (USA only).</p> |





| Display messages | Possible causes/consequences and ► Solutions |
|---|---|
|  <p>Check Engine Oil Level (Add 1 quart)</p> | <p>AMG vehicles: the engine oil level is too low.</p> <ul style="list-style-type: none"> ► Check the oil level when next refueling, at the latest (> page 366). ► If necessary, add engine oil (> page 366). ► Have the engine checked at a qualified specialist workshop if engine oil needs to be added more often than usual. <p>! Avoid long journeys with too little engine oil. The engine will otherwise be damaged.</p> <p>Information on approved engine oils can be obtained from any qualified specialist workshop or on the Internet at http://www.mbusa.com (USA only).</p> |
|  <p>Fuel Level Low</p> | <p>The fuel level has dropped into the reserve range.</p> <ul style="list-style-type: none"> ► Refuel at the nearest gas station. |
|  | <p>There is only a very small amount of fuel in the fuel tank.</p> <ul style="list-style-type: none"> ► Refuel at the nearest gas station without fail. |
|  <p>Gas Cap Loose</p> | <p>The fuel system pressure is too low. The fuel filler cap is not closed correctly or the fuel system is leaking.</p> <ul style="list-style-type: none"> ► Check that the fuel filler cap is correctly closed. <p>If the fuel filler cap is not correctly closed:</p> <ul style="list-style-type: none"> ► Close the fuel filler cap. <p>If the fuel filler cap is correctly closed:</p> <ul style="list-style-type: none"> ► Visit a qualified specialist workshop. |
|  <p>Ultra Low-sulfur Diesel Fuel Only</p> | <p>Vehicles with a diesel engine: the fuel level has fallen below the reserve range.</p> <ul style="list-style-type: none"> ► Refuel at the nearest gas station. ► Only use commercially available vehicular ULTRA-LOW SULFUR HIGHWAY DIESEL FUEL (ULSD, 15ppm SULFUR MAXIMUM). |
|  <p>Replace Air Filter</p> | <p>Vehicles with a diesel engine: the engine air filter is dirty and must be replaced.</p> <ul style="list-style-type: none"> ► Visit a qualified specialist workshop. |
|  <p>Check Fuel Filter</p> | <p>Vehicles with a diesel engine: there is water in the fuel filter. The water must be drained off.</p> <ul style="list-style-type: none"> ► Visit a qualified specialist workshop. |



| Display messages | Possible causes/consequences and ► Solutions |
|---|--|
|  <p>Check Additive See Operator's Manual</p> | <p>The DEF tank is almost empty.</p> <ul style="list-style-type: none"> ► Have the DEF tank filled as soon as possible at a qualified specialist workshop (▷ page 177). |
|  <p>Remaining Starts: 16</p> | <p>The DEF level has fallen to a minimum. You can start the engine a further 16 times.</p> <ul style="list-style-type: none"> ► Have the DEF tank filled immediately at a qualified specialist workshop (▷ page 177). <p>i You can start the engine a further 16 times. If DEF is not added, it will then not be possible to restart the engine. Fill the DEF tank with about 1 gal (3.8 l) of DEF (▷ page 177).</p> |

Driving systems



| Display messages | Possible causes/consequences and ► Solutions |
|--|---|
|  <p>Attention Assist: Take a Break!</p> | <p>Based on certain criteria, ATTENTION ASSIST has detected fatigue or a lack of concentration on the part of the driver. A warning tone also sounds.</p> <ul style="list-style-type: none"> ► If necessary, take a break. <p>During long journeys, take regular breaks in good time so you get enough rest.</p> |
|  <p>Attention Assist Inoperative</p> | <p>ATTENTION ASSIST is inoperative.</p> <ul style="list-style-type: none"> ► Visit a qualified specialist workshop. |
|  <p>Drive More Slowly</p> | <p>You cannot change the vehicle level. Possible causes are:</p> <ul style="list-style-type: none"> • you are driving too fast for the selected vehicle level. • you are towing a trailer. • the trailer-coupling socket is being used, e.g. for a bicycle rack. <ul style="list-style-type: none"> ► Drive more slowly and then select the desired vehicle level again. <ul style="list-style-type: none"> • Vehicles with the ON&OFFROAD package (▷ page 204) • Vehicles with the AIRMATIC package (▷ page 210) ► Observe the notes on towing a trailer (▷ page 253). |

| Display messages | Possible causes/consequences and ► Solutions |
|--|--|
|  <p>Compressor Is Cooling</p> | <p>You have selected a higher vehicle level. The compressor first needs to cool down because of frequent level changes.</p> <ul style="list-style-type: none"> ► Drive in a manner appropriate for the current vehicle level. ► Make sure that there is sufficient ground clearance. ► Allow the compressor to cool down. <p>When the compressor has cooled down, the display message disappears. The vehicle then continues rising to the selected level.</p> |
|  <p>Malfunction</p> | <p>AIRMATIC is malfunctioning.</p> <ul style="list-style-type: none"> ► Drive in a manner appropriate for the current vehicle level, but no faster than 50 mph (80 km/h). ► Make sure that there is sufficient ground clearance. ► Have the vehicle checked at a qualified specialist workshop. |
|  <p>Max. Speed 12 mph</p> | <p>You are exceeding the speed permissible for the selected off-road level.</p> <p>In addition, the vehicle level display appears between the vehicle icon and the display message, and a warning tone sounds.</p> <p> WARNING</p> <p>The vehicle could tip and rollover. There is a risk of an accident.</p> <ul style="list-style-type: none"> ► Adjust your driving style to the altered handling characteristics. ► Only make slight steering movements and avoid fast steering movements. ► Do not drive faster than 12 mph (20 km/h) until off-road level 2 has been reached. |
| <p>ACTIVE CURVE SYSTEM Malfunctioning</p> | <p>The Active Curve System is faulty. The vehicle's handling characteristics may be affected.</p> <ul style="list-style-type: none"> ► Do not drive faster than 50 mph (80 km/h). ► Have the vehicle checked at a qualified specialist workshop. |

| Display messages | Possible causes/consequences and ► Solutions |
|---|--|
| <p>ACTIVE CURVE SYSTEM Malfunction See Operator's Manual</p> | <p>The Active Curve System is faulty. The vehicle's handling characteristics are severely impaired. A warning tone also sounds.</p> <p> WARNING</p> <p>There is a risk of an accident.</p> <ul style="list-style-type: none"> ► Drive on carefully. ► Adjust your driving style to the altered handling characteristics. ► Avoid sudden acceleration in tight bends and fast steering movements. ► Do not drive faster than 50 mph (80km/h). ► Visit a qualified specialist workshop immediately. |
| <p> Raising Max. Speed 12 mph</p> | <p>The vehicle is being adjusted to off-road level 3. The display message informs you of the maximum speed permissible for off-road level 3.</p> <ul style="list-style-type: none"> ► Do not drive faster than 12 mph (20 km/h). |
| <p> Lowering Max. Speed 12 mph</p> | <p>The vehicle is being lowered from off-road level 3 to off-road level 2. The display message informs you of the maximum speed permissible for off-road level 3.</p> <ul style="list-style-type: none"> ► Do not drive faster than 12 mph (20 km/h) until off-road level 2 has been reached. |
| <p> Different. Lock Sys. Malfunction</p> | <p>The differential lock is malfunctioning.</p> <ul style="list-style-type: none"> ► Do not drive faster than 50 mph (80km/h). ► Have the vehicle checked at a qualified specialist workshop. |
| <p> Different. Locking Sys. Cooling Down Please Wait</p> | <p>The differential lock is too hot and has been disengaged.</p> <ul style="list-style-type: none"> ► Drive on carefully. ► Allow the differential lock to cool down. The differential lock reengages as soon as it has cooled down. |
| <p>LOW RANGE Stop Apply Parking Brake</p> | <p>A gearshift process has been canceled. LOW RANGE is in the neutral position. There is no connection between the engine and the drive wheels.</p> <ul style="list-style-type: none"> ► Pull over and stop the vehicle safely as soon as possible, paying attention to road and traffic conditions. ► Apply the electric parking brake. Do not continue driving under any circumstances. ► Repeat the gearshift process. |

| Display messages | Possible causes/consequences and ► Solutions |
|--|--|
| LOW RANGE Malfunction To Park Apply Brake | LOW RANGE is malfunctioning. <ul style="list-style-type: none"> ► Do not drive faster than 50 mph (80km/h). ► When parking, secure the vehicle against rolling away (> page 179). ► Have the vehicle checked at a qualified specialist workshop. |
| LOW RANGE Max. Speed 25 mph | You have exceeded the maximum speed for the gearshift process. <ul style="list-style-type: none"> ► Drive more slowly. The gear change is made. |
| LOW RANGE Max. Speed 40 mph | You have exceeded the maximum speed for the gearshift process. <ul style="list-style-type: none"> ► Drive more slowly. The gear change is made. |
| LOW RANGE Shift to Position N Briefly | You have reduced the vehicle speed, but the automatic transmission is not in position N . <ul style="list-style-type: none"> ► Briefly shift the automatic transmission to position N. |
| LOW RANGE Shifting Canceled Please Reactivate | The gearshift process has been canceled. <ul style="list-style-type: none"> ► Repeat the gearshift process. |
|  Inoperative | DSR (Downhill Speed Regulation) is deactivated due to a malfunction. <ul style="list-style-type: none"> ► Have DSR checked at a qualified specialist workshop. |
|  Off | The HOLD function is deactivated. The vehicle is skidding. A warning tone also sounds. <ul style="list-style-type: none"> ► Reactivate the HOLD function later (> page 207). |
| Radar Sensors Deactivated See Operator's Manual | The radar sensor system is deactivated. <ul style="list-style-type: none"> ► Switch on the radar sensor system (> page 277). |



| Display messages | Possible causes/consequences and ► Solutions |
|--|---|
| <p>Lane Keeping Assist Currently Unavailable See Operator's Manual or Active Lane Keeping Assist Currently Unavailable See Operator's Manual</p> | <p>Lane Keeping Assist or Active Lane Keeping Assist is deactivated and temporarily inoperative. Possible causes are:</p> <ul style="list-style-type: none"> • the windshield in the camera's field of vision is dirty. • visibility is impaired due to heavy rain, snow or fog. • there are no lane markings for a longer period. • the lane markings are worn, dark or covered, e.g. by dirt or snow. <p>When the causes stated above no longer apply, the display message disappears.</p> <p>Lane Keeping Assist or Active Lane Keeping Assist is operational again.</p> <p>If the display message does not disappear:</p> <ul style="list-style-type: none"> ► Pull over and stop the vehicle safely as soon as possible, paying attention to road and traffic conditions. ► Secure the vehicle against rolling away (▷ page 179). ► Clean the windshield. |
| <p>Lane Keeping Assist Inoperative or Active Lane Keeping Assist Inoperative</p> | <p>Lane Keeping Assist or Active Lane Keeping Assist is defective.</p> <ul style="list-style-type: none"> ► Visit a qualified specialist workshop. |
| <p>Blind Spot Assist Currently Unavailable See Operator's Manual or Active Blind Spot Assist Currently Unavailable See Operator's Manual</p> | <p>Blind Spot Assist or Active Blind Spot Assist is temporarily inoperative.</p> <p>You have established the electrical connection between the trailer and your vehicle.</p> <ul style="list-style-type: none"> ► Press <input type="button" value="OK"/> on the steering wheel to confirm the display message. <p>Blind Spot Assist or Active Blind Spot Assist is deactivated while towing a trailer.</p> |

| Display messages | Possible causes/consequences and ► Solutions |
|--|---|
| | <p>Blind Spot Assist or Active Blind Spot Assist is temporarily inoperative. Possible causes are:</p> <ul style="list-style-type: none"> • the sensors are dirty. • function is impaired due to heavy rain or snow. • the radar sensor system is outside the operating temperature range. • the radar sensor system is temporarily inoperative, e.g. due to electromagnetic radiation emitted by nearby TV or radio stations or other sources of electromagnetic radiation. <p>The yellow  indicator lamps also light up in the exterior mirrors.</p> <p>When the causes stated above no longer apply, the display message disappears.</p> <p>Blind Spot Assist or Active Blind Spot Assist is operational again.</p> <p>If the display message does not disappear:</p> <ul style="list-style-type: none"> ► Pull over and stop the vehicle safely as soon as possible, paying attention to road and traffic conditions. ► Secure the vehicle against rolling away (▷ page 179). ► Clean the sensors (▷ page 373). ► Restart the engine. |
| <p>Blind Spot Assist Inoperative or Active Blind Spot Assist Inoperative</p> | <p>Blind Spot Assist or Active Blind Spot Assist is defective.</p> <p>The yellow  indicator lamps also light up in the exterior mirrors.</p> <ul style="list-style-type: none"> ► Visit a qualified specialist workshop. |
| <p>Park Assist Canceled</p> | <p>The driver's door is open and the driver's seat belt has not been fastened.</p> <ul style="list-style-type: none"> ► Repeat the parking process with the seat belt fastened and the driver's door closed. <p>You have inadvertently touched the multifunction steering wheel while steering intervention was active.</p> <ul style="list-style-type: none"> ► While steering intervention is active, make sure that the multifunction steering wheel is not touched unintentionally. <p>The vehicle has started to skid and ESP® has intervened.</p> <ul style="list-style-type: none"> ► Use Active Parking Assist again later (▷ page 217). |

| Display messages | Possible causes/consequences and ► Solutions |
|--|---|
| Park Assist Inoperative | <p>You have just carried out a large number of turning or parking maneuvers.</p> <p>Active Parking Assist will become available again after approximately ten minutes (▷ page 217).</p> <ul style="list-style-type: none"> ► Pull over and stop the vehicle safely as soon as possible, paying attention to road and traffic conditions. ► Switch off and restart the engine. <p>If the display message continues to be displayed:</p> <ul style="list-style-type: none"> ► Visit a qualified specialist workshop. <p>PARKTRONIC is defective.</p> <ul style="list-style-type: none"> ► Visit a qualified specialist workshop. |
| Park Assist Finished | <p>The vehicle is parked. A warning tone also sounds.</p> <p>The display message disappears automatically.</p> |
| DISTRONIC PLUS Off | <p>DISTRONIC PLUS has been deactivated (▷ page 194).</p> <p>If it was deactivated automatically, a warning tone also sounds.</p> |
| DISTRONIC PLUS Now Available | <p>DISTRONIC PLUS is operational again after having been temporarily unavailable. You can now reactivate DISTRONIC PLUS (▷ page 194).</p> |
| DISTRONIC PLUS Currently Unavailable See Operator's Manual | <p>DISTRONIC PLUS is temporarily inoperative. Possible causes are:</p> <ul style="list-style-type: none"> • function is impaired due to heavy rain or snow. • the sensors in the radiator grill and the bumper are dirty. • the radar sensor system is temporarily inoperative, e.g. due to electromagnetic radiation emitted by nearby TV or radio stations or other sources of electromagnetic radiation. • the system is outside the operating temperature range. • the on-board voltage is too low. <p>A warning tone also sounds.</p> <p>When the causes stated above no longer apply, the display message disappears.</p> <p>DISTRONIC is operational again.</p> <p>If the display message does not disappear:</p> <ul style="list-style-type: none"> ► Pull over and stop the vehicle safely as soon as possible, paying attention to road and traffic conditions. ► Secure the vehicle against rolling away (▷ page 179). ► Clean the sensors in the radiator grill and the bumper (▷ page 373). ► Restart the engine. |

| Display messages | Possible causes/consequences and ► Solutions |
|-------------------------------|---|
| DISTRONIC PLUS Inoperative | DISTRONIC PLUS is defective. BAS PLUS (Brake Assist PLUS) and PRE-SAFE® Brake may be inoperative as well. A warning tone also sounds. ► Visit a qualified specialist workshop. |
| DISTRONIC PLUS Inactive | You have depressed the accelerator pedal. DISTRONIC PLUS is no longer controlling the speed of the vehicle. ► Remove your foot from the accelerator pedal. |
| DISTRONIC PLUS --- mph | An activation condition for DISTRONIC PLUS is not fulfilled. ► Check the activation conditions for DISTRONIC PLUS (► page 194). |
| Cruise Control Inoperative | Cruise control is defective. ► Visit a qualified specialist workshop. |
| Cruise Control --- mph | A condition for activating cruise control has not been fulfilled. You have tried to store a speed below 20 mph (30 km/h), for example. ► If conditions permit, drive faster than 20 mph (30 km/h) and store the speed. ► Check the activation conditions for cruise control (► page 192). |



| Tires | |
|---|---|
| Display messages | Possible causes/consequences and ► Solutions |
| Check Tire Pressure Soon | <p>The tire pressure loss warning system has detected a significant loss in pressure. A warning tone also sounds.</p> <p> WARNING</p> <p>With tire pressures which are too low, there is a risk of the following hazards:</p> <ul style="list-style-type: none"> • they may burst, especially as the load and vehicle speed increase. • they may wear excessively and/or unevenly, which may greatly impair tire traction. • the driving characteristics, as well as steering and braking, may be greatly impaired. <p>There is a risk of an accident.</p> <ul style="list-style-type: none"> ► Stop the vehicle without making any sudden steering or braking maneuvers. Pay attention to the traffic conditions as you do so. ► Secure the vehicle against rolling away (▷ page 179). ► Check the tires and, if necessary, follow the instructions for a flat tire (▷ page 381). ► Check the tire pressures and, if necessary, correct the tire pressure. ► Restart the tire pressure loss warning system when the tire pressure is correct (▷ page 406). |
| Check Tire Pressure Then Restart Run Flat Indicator | <p>The tire pressure loss warning system generated a display message and has not been restarted since.</p> <ul style="list-style-type: none"> ► Set the correct tire pressure in all four tires. ► Restart the tire pressure loss warning system (▷ page 406). |
| Run Flat Indicator Inoperative | <p>The tire pressure loss warning system is faulty.</p> <ul style="list-style-type: none"> ► Visit a qualified specialist workshop. |
| Correct Tire Pressure | <p>The tire pressure is too low in at least one of the tires, or the tire pressure difference between the wheels is too great.</p> <ul style="list-style-type: none"> ► Check the tire pressures at the next opportunity (▷ page 406). ► If necessary, correct the tire pressure. ► Restart the tire pressure monitor (▷ page 409). |



| Display messages | Possible causes/consequences and ► Solutions |
|---------------------------------|--|
| <p>Check Tires</p> | <p>The tire pressure in one or more tires has dropped significantly. The wheel position is displayed in the multifunction display. A warning tone also sounds.</p> <p> WARNING</p> <p>With tire pressures which are too low, there is a risk of the following hazards:</p> <ul style="list-style-type: none"> • they may burst, especially as the load and vehicle speed increase. • they may wear excessively and/or unevenly, which may greatly impair tire traction. • the driving characteristics, as well as steering and braking, may be greatly impaired. <p>There is a risk of an accident.</p> <ul style="list-style-type: none"> ► Stop the vehicle without making any sudden steering or braking maneuvers. Pay attention to the traffic conditions as you do so. ► Secure the vehicle against rolling away (► page 179). ► Check the tires and, if necessary, follow the instructions for a flat tire (► page 381). ► Check the tire pressure (► page 406). ► If necessary, correct the tire pressure. |
| <p>Warning Tire Malfunction</p> | <p>The tire pressure in one or more tires has dropped suddenly. The wheel position is shown in the multifunction display.</p> <p> WARNING</p> <p>If you drive with a flat tire, there is a risk of the following hazards:</p> <ul style="list-style-type: none"> • A flat tire affects the ability to steer or brake the vehicle. • You could lose control of the vehicle. • Continued driving with a flat tire will cause excessive heat build-up and possibly a fire. <p>There is a risk of an accident.</p> <ul style="list-style-type: none"> ► Stop the vehicle without making any sudden steering or braking maneuvers. Pay attention to the traffic conditions as you do so. ► Secure the vehicle against rolling away (► page 179). ► Check the tires and, if necessary, follow the instructions for a flat tire (► page 381). |

| Display messages | Possible causes/consequences and ► Solutions |
|---|---|
| Tire Press. Monitor Currently Unavailable | Due to a source of radio interference, no signals can be received from the wheel sensors. The tire pressure monitor is temporarily malfunctioning. ► Drive on. The tire pressure monitor restarts automatically as soon as the problem has been solved. |
| TirePress. Sensor(s) Missing | There is no signal from the tire pressure sensor of one or several wheels. The pressure of the affected tire is not displayed in the multifunction display. ► Have the faulty tire pressure sensor replaced at a qualified specialist workshop. |
| Tire Pressure Monitor Inoperative No Wheel Sensors | The wheels mounted do not have a suitable tire pressure sensor. The tire pressure monitor is deactivated. ► Mount wheels with suitable tire pressure sensors. The tire pressure monitor is activated automatically after driving for a few minutes. |
| Tire Press. Monitor Inoperative | The tire pressure monitor is faulty. ► Visit a qualified specialist workshop. |



Vehicle





| Display messages | Possible causes/consequences and ► Solutions |
|--|---|
| Shift to 'P' or 'N' to Start Engine | You have attempted to start the engine with the transmission in position R or D . ► Shift the transmission to position P or N . |
| Auxiliary Battery Malfunction | The auxiliary battery for the automatic transmission is no longer being charged. ► Visit a qualified specialist workshop at the next opportunity. ► Until then, set the automatic transmission to position P before you switch off the engine. ► Before leaving the vehicle, apply the electric parking brake. ► Secure the vehicle against rolling away (▷ page 179). |
| Apply Brake to Shift from 'P' | You have attempted to move the transmission selector lever to position D , R or N without depressing the brake pedal. ► Depress the brake pedal. |



| Display messages | Possible causes/consequences and ► Solutions |
|---|--|
| Transmission Not in P Risk of Vehicle Rolling Away | <p>The driver's door is open and the transmission is in position R, N or D.</p> <p>A warning tone also sounds.</p> <ul style="list-style-type: none"> ► Shift the transmission to position P. ► Secure the vehicle against rolling away (▷ page 179). |
| Service Required Do Not Shift Gears Visit Dealer | <p>You cannot change the transmission position due to a malfunction. A warning tone also sounds.</p> <p>If transmission position D is selected:</p> <ul style="list-style-type: none"> ► Drive to a qualified specialist workshop without shifting the transmission from position D. <p>If transmission position R, N or P is selected:</p> <ul style="list-style-type: none"> ► Notify a qualified specialist workshop or breakdown service. |
| Only Shift to 'P' when Vehicle is Stationary | <p>The vehicle is moving.</p> <ul style="list-style-type: none"> ► Pull over and stop the vehicle safely as soon as possible, paying attention to road and traffic conditions. ► Shift the transmission to position P. |
|  | <p>The tailgate is open.</p> <p>⚠ WARNING</p> <p>When the engine is running, exhaust gases can enter the vehicle interior if the tailgate is open. There is a risk of poisoning.</p> <ul style="list-style-type: none"> ► Close the tailgate. |
|  | <p>The hood is open.</p> <p>⚠ WARNING</p> <p>The open hood may block your view when the vehicle is in motion. There is a risk of an accident.</p> <ul style="list-style-type: none"> ► Pull over and stop the vehicle safely as soon as possible, paying attention to road and traffic conditions. ► Secure the vehicle against rolling away (▷ page 179). ► Close the hood. |
|  | <p>At least one door is open. A warning tone also sounds.</p> <ul style="list-style-type: none"> ► Close all the doors. |

| Display messages | Possible causes/consequences and ► Solutions |
|---|---|
|  Power Steering Malfunction See Operator's Manual | The power steering is malfunctioning. A warning tone also sounds. ⚠ WARNING You will need to use more force to steer. There is a risk of an accident. <ul style="list-style-type: none"> ► Check whether you are able to apply the extra force required. ► If you are able to steer safely: carefully drive on to a qualified specialist workshop. ► If you are unable to steer safely: do not drive on. Contact the nearest qualified specialist workshop. |
| Phone No Service | Your vehicle is outside the network provider's transmitter/receiver range. <ul style="list-style-type: none"> ► Wait until the mobile phone operational readiness symbol appears in the multifunction display. |
|  Check Washer Fluid | The washer fluid level in the washer fluid reservoir has dropped below the minimum. <ul style="list-style-type: none"> ► Add washer fluid (► page 368). |
| Wiper Malfunctioning | The windshield wipers are malfunctioning. <ul style="list-style-type: none"> ► Visit a qualified specialist workshop. |
| Hazard Warning Flashers Malfunctioning | The hazard warning lamps are faulty. <ul style="list-style-type: none"> ► Visit a qualified specialist workshop. |

SmartKey



















| Display messages | Possible causes/consequences and ► Solutions |
|---|---|
|  Key Does Not Belong to Vehicle | You have put the wrong SmartKey in the ignition lock. <ul style="list-style-type: none"> ► Use the correct SmartKey. |
|  Take Your Key from Ignition | The SmartKey is in the ignition lock. <ul style="list-style-type: none"> ► Remove the SmartKey. |
|  Obtain a New Key | The SmartKey needs to be replaced. <ul style="list-style-type: none"> ► Visit a qualified specialist workshop. |

| Display messages | Possible causes/consequences and ► Solutions |
|---|--|
|  <p>Replace Key Battery</p> | <p>The batteries of the KEYLESS-GO key are discharged.</p> <ul style="list-style-type: none"> ► Change the batteries (▷ page 81). |
|  <p>Don't Forget Your Key</p> | <p>This display message is displayed for a maximum of 60 seconds and is simply a reminder.</p> <p>You have opened the driver's door with the engine switched off. The KEYLESS-GO key is not in the ignition lock.</p> <ul style="list-style-type: none"> ► Remember to take the KEYLESS-GO key with you when you leave the vehicle. |
|  <p>Key Not Detected (red display message)</p> | <p>The KEYLESS-GO key is not in the vehicle.</p> <p>A warning tone also sounds.</p> <p>If the engine is switched off, you can no longer lock the vehicle centrally or start the engine.</p> <ul style="list-style-type: none"> ► Pull over and stop the vehicle safely as soon as possible, paying attention to road and traffic conditions. ► Secure the vehicle against rolling away (▷ page 179). ► Locate the KEYLESS-GO key. <p>The KEYLESS-GO key is not detected while the engine is running because there is interference from a strong source of radio waves.</p> <p>A warning tone also sounds.</p> <ul style="list-style-type: none"> ► Pull over and stop the vehicle safely as soon as possible, paying attention to road and traffic conditions. ► Secure the vehicle against rolling away (▷ page 179). ► Operate the vehicle with the SmartKey in the ignition lock. |
|  <p>Key Not Detected (white display message)</p> | <p>The KEYLESS-GO key cannot be detected at present.</p> <ul style="list-style-type: none"> ► Change the location of the SmartKey with the KEYLESS-GO functions in the vehicle. <p>If the KEYLESS-GO key is still not detected:</p> <ul style="list-style-type: none"> ► Operate the vehicle with the SmartKey in the ignition lock. |
|  <p>Key Detected in Vehicle</p> | <p>The KEYLESS-GO key has been detected inside the vehicle during locking.</p> <ul style="list-style-type: none"> ► Remove the KEYLESS-GO key from the vehicle. |

| Display messages | Possible causes/consequences and ► Solutions |
|---|---|
|  Remove 'Start' Button and Insert Key | KEYLESS-GO is temporarily malfunctioning or is defective. A warning tone also sounds. <ul style="list-style-type: none"> ► Insert the SmartKey into the ignition lock and turn it to the desired position. ► Visit a qualified specialist workshop. |
|  Close Doors to Lock Vehicle | At least one door is open. A warning tone also sounds. <ul style="list-style-type: none"> ► Close all doors and lock the vehicle again. |

Warning and indicator lamps in the instrument cluster

Overview

| | |
|---|---|
|  | Low-beam headlamps (▷ page 121) |
|  | Parking lamps (▷ page 122) |
|  | High-beam headlamps (▷ page 124) |
|   | Turn signal (▷ page 123) |
|  | Seat belts (▷ page 317) |
|  (USA) | Brakes (▷ page 318) |
|  (Canada) | Brakes (▷ page 318) |
|  | ABS (▷ page 319) |
|  | ESP® (▷ page 321) |
|  | ESP® OFF (▷ page 321) |
|  (USA) | Electric parking brake (red) (▷ page 324) |
|  (Canada) | Electric parking brake (red) (▷ page 324) |
|  | Electric parking brake (yellow) (▷ page 324) |
|  | SRS (▷ page 324) |
|  | Check Engine (▷ page 325) |
|  | Reserve fuel (▷ page 325) |
|  | Coolant (▷ page 326) |
|  | Distance warning function (▷ page 328) |







Diesel engine: preglow
(▷ page 159)









Tire pressure monitor
(▷ page 329)



Safety



Seat belts









| Problem | Possible causes/consequences and ► Solutions |
|---|---|
|  <p>After starting the engine, the red seat belt warning lamp lights up for 6 seconds.</p> | <p>The seat belt warning lamp reminds the driver and front passenger to fasten their seat belts.</p> <ul style="list-style-type: none"> ► Fasten your seat belt (▷ page 56). |
|  <p>After starting the engine, the red seat belt warning lamp lights up. In addition, a warning tone sounds for up to six seconds.</p> | <p>The driver's seat belt is not fastened.</p> <ul style="list-style-type: none"> ► Fasten your seat belt (▷ page 56). The warning tone ceases. |
|  <p>The red seat belt warning lamp lights up after the engine starts, as soon as the driver's or the front-passenger door is closed.</p> | <p>The driver or front passenger has not fastened their seat belt.</p> <ul style="list-style-type: none"> ► Fasten your seat belt (▷ page 56). The warning lamp goes out. <p>There are objects on the front-passenger seat.</p> <ul style="list-style-type: none"> ► Remove the objects from the front-passenger seat and stow them in a secure place. The warning lamp goes out. |
|  <p>The red seat belt warning lamp flashes and an intermittent audible warning sounds.</p> | <p>The driver or front passenger has not fastened their seat belt. You are driving faster than 15 mph (25 km/h) or have briefly driven faster than 15 mph (25 km/h).</p> <ul style="list-style-type: none"> ► Fasten your seat belt (▷ page 56). The warning lamp goes out and the intermittent warning tone ceases. <p>There are objects on the front-passenger seat. You are driving faster than 15 mph (25 km/h) or have briefly driven faster than 15 mph (25 km/h).</p> <ul style="list-style-type: none"> ► Remove the objects from the front-passenger seat and stow them in a secure place. The warning lamp goes out and the intermittent warning tone ceases. |





Safety systems



| Problem | Possible causes/consequences and ► Solutions |
|---|---|
| <p> (USA only)  (Canada only)</p> <p>The red brake system warning lamp comes on while the engine is running. A warning tone also sounds.</p> | <p> WARNING</p> <p>The brake boosting effect is malfunctioning and the braking characteristics may be affected. There is a risk of an accident.</p> <ul style="list-style-type: none"> ► Pull over and stop the vehicle safely as soon as possible, paying attention to road and traffic conditions. Do not continue driving under any circumstances. ► Secure the vehicle against rolling away (▷ page 179). ► Consult a qualified specialist workshop. ► Observe the additional display messages in the multifunction display. |
| <p> (USA only)  (Canada only)</p> <p>The red brake system warning lamp comes on while the engine is running. A warning tone also sounds.</p> | <p>There is not enough brake fluid in the brake fluid reservoir.</p> <p> WARNING</p> <p>The braking effect may be impaired. There is a risk of an accident.</p> <ul style="list-style-type: none"> ► Pull over and stop the vehicle safely as soon as possible, paying attention to road and traffic conditions. Do not continue driving under any circumstances. ► Secure the vehicle against rolling away (▷ page 179). ► Do not add brake fluid. Adding more will not remedy the malfunction. ► Consult a qualified specialist workshop. ► Observe the additional display messages in the multifunction display. |





| Problem | Possible causes/consequences and ► Solutions |
|--|--|
|  <p>The yellow ABS warning lamp is lit while the engine is running.</p> | <p>ABS (Anti-lock Braking System) is deactivated due to a malfunction. For this reason, BAS (Brake Assist), BAS PLUS, ESP® (Electronic Stability Program), PRE-SAFE®, PRE-SAFE® Brake, COLLISION PREVENTION ASSIST, the HOLD function, hill start assist and ESP® trailer stabilization are also deactivated, for example.</p> <p>ATTENTION ASSIST is deactivated.</p> <p> WARNING</p> <p>The brake system continues to function normally, but without the functions listed above. The wheels could therefore lock if you brake hard, for example.</p> <p>The steerability and braking characteristics may be severely affected. The braking distance in an emergency braking situation can increase.</p> <p>If ESP® is not operational, ESP® is unable to stabilize the vehicle. There is an increased risk of skidding and an accident.</p> <ul style="list-style-type: none"> ► Observe the additional display messages in the multifunction display. ► Drive on carefully. ► Visit a qualified specialist workshop. <p>If the ABS control unit is faulty, there is also a possibility that other systems, such as the navigation system or the automatic transmission, will not be available.</p> |





| Problem | Possible causes/consequences and ► Solutions |
|--|--|
|  <p>The yellow ABS warning lamp is lit while the engine is running.</p> | <p>ABS is temporarily unavailable. Therefore, BAS, BAS PLUS, ESP®, EBD (electronic brake force distribution), PRE-SAFE®, PRE-SAFE® Brake, COLLISION PREVENTION ASSIST, the HOLD function, hill start assist, and ESP® trailer stabilization, for example, are also deactivated.</p> <p>ATTENTION ASSIST is deactivated.</p> <p>Possible causes are:</p> <ul style="list-style-type: none"> • Self-diagnosis is not yet complete. • The on-board voltage may be insufficient. <p> WARNING</p> <p>The brake system continues to function normally, but without the functions listed above. The front and rear wheels could therefore lock if you brake hard, for example.</p> <p>The steerability and braking characteristics may be severely affected. The braking distance in an emergency braking situation can increase.</p> <p>If ESP® is not operational, ESP® is unable to stabilize the vehicle. There is a risk of an accident.</p> <p>► Carefully drive a short distance on a suitable stretch of road, making slight steering movements at a speed above 12 mph (20 km/h). The functions mentioned above are available again when the warning lamp goes out.</p> <p>If the warning lamp is still on:</p> <ul style="list-style-type: none"> ► Observe the additional display messages in the multifunction display. ► Drive on carefully. ► Visit a qualified specialist workshop. |

| Problem | Possible causes/consequences and ► Solutions |
|---|---|
|  <p>The yellow ABS warning lamp is lit while the engine is running. A warning tone also sounds.</p> | <p>EBD is malfunctioning. Therefore, ABS, BAS, BAS PLUS, ESP[®], PRE-SAFE[®], PRE-SAFE[®] Brake, COLLISION PREVENTION ASSIST, the HOLD function, hill start assist and ESP[®] trailer stabilization, for example, are not available either. ATTENTION ASSIST is deactivated.</p> <p> WARNING</p> <p>The brake system continues to function normally, but without the functions listed above. The front and rear wheels could therefore lock if you brake hard, for example.</p> <p>The steerability and braking characteristics may be severely affected. The braking distance in an emergency braking situation can increase.</p> <p>If ESP[®] is not operational, ESP[®] is unable to stabilize the vehicle. There is an increased risk of skidding and an accident.</p> <ul style="list-style-type: none"> ► Observe the additional display messages in the multifunction display. ► Drive on carefully. ► Visit a qualified specialist workshop. |
| <p> (USA only)</p> <p> (Canada only)</p> <p>  </p> <p>The red brake warning lamp, the yellow ESP[®] and ESP[®] OFF warning lamps and the yellow ABS warning lamp are lit while the engine is running.</p> | <p>ABS and ESP[®] are malfunctioning. Therefore, BAS, BAS PLUS, PRE-SAFE[®], PRE-SAFE[®] Brake, COLLISION PREVENTION ASSIST, the HOLD function, hill start assist and ESP[®] trailer stabilization, for example, are also not available. ATTENTION ASSIST is deactivated.</p> <p> WARNING</p> <p>The brake system continues to function normally, but without the functions listed above. The front and rear wheels could therefore lock if you brake hard, for example.</p> <p>The steerability and braking characteristics may be severely affected. The braking distance in an emergency braking situation can increase.</p> <p>If ESP[®] is not operational, ESP[®] is unable to stabilize the vehicle. There is an increased risk of skidding and an accident.</p> <ul style="list-style-type: none"> ► Observe the additional display messages in the multifunction display. ► Drive on carefully. ► Visit a qualified specialist workshop. |



| Problem | Possible causes/consequences and ► Solutions |
|---|--|
|  <p>The yellow ESP[®] warning lamp flashes while the vehicle is in motion.</p> | <p>ESP[®] or traction control has intervened because there is a risk of skidding or at least one wheel has started to spin. Cruise control or DISTRONIC PLUS is deactivated.</p> <ul style="list-style-type: none"> ► When pulling away, only depress the accelerator pedal as far as necessary. ► Ease off the accelerator pedal while the vehicle is in motion. ► Adapt your driving style to suit the road and weather conditions. ► Do not deactivate ESP[®]. <p>In rare cases (► page 71), it may be best to deactivate ESP[®].</p> |
|  <p>The yellow ESP[®] OFF warning lamp is lit while the engine is running.</p> | <p>ESP[®] is deactivated.</p> <p> WARNING</p> <p>If ESP[®] is switched off, ESP[®] is unable to stabilize the vehicle. There is an increased risk of skidding and an accident.</p> <ul style="list-style-type: none"> ► Reactivate ESP[®]. <p>In rare cases (► page 71), it may be best to deactivate ESP[®].</p> <ul style="list-style-type: none"> ► Adapt your driving style to suit the road and weather conditions. <p>If ESP[®] cannot be activated:</p> <ul style="list-style-type: none"> ► Have ESP[®] checked at a qualified specialist workshop. |
|  <p>The yellow ESP[®] and ESP[®] OFF warning lamps are lit while the engine is running.</p> | <p>ESP[®], BAS, BAS PLUS, PRE-SAFE[®], PRE-SAFE[®] Brake, COLLISION PREVENTION ASSIST, the HOLD function, hill start assist and ESP[®] trailer stabilization are not available due to a malfunction. ATTENTION ASSIST is deactivated.</p> <p> WARNING</p> <p>The brake system continues to function normally, but without the functions listed above. The braking distance in an emergency braking situation can thus increase.</p> <p>If ESP[®] is not operational, ESP[®] is unable to stabilize the vehicle. There is an increased risk of skidding and an accident.</p> <ul style="list-style-type: none"> ► Observe the additional display messages in the multifunction display. ► Drive on carefully. ► Visit a qualified specialist workshop. |

| Problem | Possible causes/consequences and ► Solutions |
|--|---|
|  <p>The yellow ESP[®] and ESP[®] OFF warning lamps are lit while the engine is running.</p> | <p>ESP[®], BAS, PRE-SAFE[®], the HOLD function, hill start assist and ESP[®] trailer stabilization are temporarily unavailable. COLLISION PREVENTION ASSIST, BAS PLUS and PRE-SAFE[®] Brake may also have failed. ATTENTION ASSIST is deactivated. Self-diagnosis is not yet complete.</p> <p> WARNING</p> <p>The brake system continues to function normally, but without the functions listed above. The braking distance in an emergency braking situation can thus increase. If ESP[®] is not operational, ESP[®] is unable to stabilize the vehicle. There is an increased risk of skidding and an accident.</p> <p>► Carefully drive a short distance on a suitable stretch of road, making slight steering movements at a speed above 12 mph (20 km/h). The functions mentioned above are available again when the warning lamp goes out.</p> <p>If the warning lamp is still on:</p> <ul style="list-style-type: none"> ► Observe the additional display messages in the multifunction display. ► Drive on carefully. ► Visit a qualified specialist workshop. |

| Problem | Possible causes/consequences and ► Solutions |
|--|---|
| <p> (USA only)  (Canada only)</p> <p>The red electric parking brake indicator lamp flashes or lights up and/or</p> <p></p> <p>warning lamp for the electric parking brake lights up.</p> | <p>► Observe the additional display messages in the multifunction display.</p> |
| <p></p> <p>The red SRS warning lamp is lit while the engine is running.</p> | <p>There is a malfunction in the SRS (Supplemental Restraint System).</p> <p> WARNING</p> <p>The air bags or Emergency Tensioning Devices may either be triggered unintentionally or, in the event of an accident, may not be triggered.</p> <p>There is an increased risk of injury.</p> <p>► Drive on carefully.</p> <p>► Have SRS checked at a qualified specialist workshop immediately.</p> <p>For further information about SRS, see (► page 43).</p> |

| Engine | |
|---|--|
| Problem | Possible causes/consequences and ► Solutions |
|  The yellow Check Engine warning lamp lights up while the engine is running. | <p>There may be a malfunction, for example:</p> <ul style="list-style-type: none"> • in the engine management • in the fuel injection system • in the exhaust system • in the ignition system (for vehicles with a gasoline engine) • in the fuel system <p>The emission limit values may be exceeded and the engine may be running in emergency mode.</p> <p>► Have the vehicle checked as soon as possible at a qualified specialist workshop.</p> <p>i In some states, you must immediately visit a qualified specialist workshop as soon as the yellow Check Engine warning lamp lights up. This is due to the legal requirements in effect in these states. If in doubt, check whether such legal regulations apply in the state in which you are currently driving.</p> <p>Vehicles with a diesel engine: the fuel tank has been run dry (► page 176).</p> <p>► Start the engine three to four times after refueling. If the yellow Check Engine warning lamp goes out, emergency running mode is canceled. The vehicle need not be checked.</p> |
|  The yellow reserve fuel warning lamp lights up while the engine is running. | <p>The fuel level has dropped into the reserve range.</p> <p>► Refuel at the nearest gas station.</p> |
|  The yellow reserve fuel warning lamp flashes while the vehicle is in motion. In addition, the  Check Engine warning lamp may light up. | <p>The fuel system pressure is too low. The fuel filler cap is not closed correctly or the fuel system is leaking.</p> <p>► Check that the fuel filler cap is correctly closed.</p> <p>► If the fuel filler cap is not correctly closed: close the fuel filler cap.</p> <p>► If the fuel filler cap is closed: visit a qualified specialist workshop.</p> |





| Problem | Possible causes/consequences and ► Solutions |
|---|---|
|  <p>The red coolant warning lamp lights up while the engine is running and the coolant temperature gauge is at the start of the scale.</p> | <p>The temperature sensor for the coolant temperature gauge is defective.</p> <p>The coolant temperature is no longer being monitored. There is a risk of engine damage if the coolant temperature is too high.</p> <ul style="list-style-type: none">► Pull over and stop the vehicle safely and switch off the engine, paying attention to road and traffic conditions. Do not continue driving under any circumstances.► Secure the vehicle against rolling away (▷ page 179).► Consult a qualified specialist workshop. |

| Problem | Possible causes/consequences and ► Solutions |
|---|--|
|  <p>The red coolant warning lamp comes on while the engine is running.</p> | <p>The coolant level is too low.</p> <p>! Avoid making long journeys with too little coolant in the engine cooling system. The engine will otherwise be damaged.</p> <p>If the coolant level is correct, the airflow to the engine radiator may be blocked or the electric engine radiator fan may be malfunctioning.</p> <p>The coolant is too hot and the engine is no longer being cooled sufficiently.</p> <ul style="list-style-type: none"> ► Observe the additional display messages in the multifunction display. ► Pull over and stop the vehicle safely and switch off the engine, paying attention to road and traffic conditions. ► Secure the vehicle against rolling away (► page 179). ► Leave the vehicle and keep a safe distance from the vehicle until the engine has cooled down. ► Check the coolant level and add coolant, observing the warning notes (► page 367). ► If you need to add coolant more often than usual, have the engine coolant system checked. ► Make sure that the air supply to the engine radiator is not blocked, e.g. by snow, slush or ice. ► Do not start the engine again until the coolant temperature is under 248 °F (120 °C). Otherwise, the engine could be damaged. ► Drive to the nearest qualified specialist workshop. ► Avoid subjecting the engine to heavy loads, e.g. driving in mountainous terrain, and stop-and-go traffic. |
|  <p>The red coolant warning lamp comes on while the engine is running. A warning tone also sounds.</p> | <p>The coolant temperature has exceeded 248 °F (120 °C). The airflow to the engine radiator may be blocked or the coolant level may be too low.</p> <p>⚠ WARNING</p> <p>The engine is not being cooled sufficiently and may be damaged. Do not drive when your engine is overheated. This can cause some fluids which may have leaked into the engine compartment to catch fire.</p> <p>Steam from the overheated engine can also cause serious burns which can occur just by opening the hood.</p> <p>There is a risk of injury.</p> |

| Problem | Possible causes/consequences and ► Solutions |
|---------|---|
| | <ul style="list-style-type: none"> ► Observe the additional display messages in the multifunction display. ► Pull over and stop the vehicle safely and switch off the engine, paying attention to road and traffic conditions. ► Secure the vehicle against rolling away (▷ page 179). ► Leave the vehicle and keep a safe distance from the vehicle until the engine has cooled down. ► Check the coolant level and add coolant, observing the warning notes (▷ page 367). ► If you need to add coolant more often than usual, have the engine coolant system checked. ► Make sure that the air supply to the engine radiator is not blocked, e.g. by snow, slush or ice. ► At coolant temperatures under 248 °F (120 °C), drive to the next qualified specialist workshop. ► Avoid subjecting the engine to heavy loads, e.g. driving in mountainous terrain, and stop-and-go traffic. |

Driving systems

| Problem | Possible causes/consequences and ► Solutions |
|---|---|
|  <p>The red distance warning lamp comes on while the vehicle is moving. A warning tone also sounds.</p> | <p>You are approaching a vehicle or a stationary obstacle in your line of travel at too high a speed.</p> <ul style="list-style-type: none"> ► Be prepared to brake immediately. ► Pay careful attention to the traffic situation. You may have to brake or take evasive action. <p>Further information on DISTRONIC PLUS (▷ page 194). Further information on PRE-SAFE® Brake (▷ page 73). Further information on the distance warning function (▷ page 68).</p> |

| Tires | |
|--|---|
| Problem | Possible causes/consequences and ► Solutions |
|  USA only: The yellow tire pressure monitor warning lamp (pressure loss/malfunction) is lit. Canada only: The yellow tire pressure monitor warning lamp (pressure loss) is lit. | <p>The tire pressure monitor has detected a loss of pressure in at least one of the tires.</p> <p> WARNING</p> <p>With tire pressures which are too low, there is a risk of the following hazards:</p> <ul style="list-style-type: none"> • they may burst, especially as the load and vehicle speed increase. • they may wear excessively and/or unevenly, which may greatly impair tire traction. • the driving characteristics, as well as steering and braking, may be greatly impaired. <p>There is a risk of an accident.</p> <ul style="list-style-type: none"> ► Stop the vehicle without making any sudden steering or braking maneuvers. Pay attention to the traffic conditions as you do so. ► Secure the vehicle against rolling away (▷ page 179). ► Observe the additional display messages in the multifunction display. ► Check the tires and, if necessary, follow the instructions for a flat tire (▷ page 381). ► Check the tire pressure (▷ page 406). ► If necessary, correct the tire pressure. |
|  USA only: The yellow tire pressure monitor warning lamp (pressure loss/malfunction) flashes for approximately one minute and then remains lit. | <p>The tire pressure monitor is faulty.</p> <p> WARNING</p> <p>The system is possibly unable to recognize or register low tire pressure.</p> <p>There is a risk of an accident.</p> <ul style="list-style-type: none"> ► Observe the additional display messages in the multifunction display. ► Visit a qualified specialist workshop. |

| | |
|--------------------------|-----|
| Useful information | 332 |
| Stowage areas | 332 |
| Features | 343 |

Useful information

- i** This Operator's Manual describes all models and all standard and optional equipment of your vehicle available at the time of publication of the Operator's Manual. Country-specific differences are possible. Please note that your vehicle may not be equipped with all features described. This also applies to safety-related systems and functions.
- i** Read the information on qualified specialist workshops: (▷ page 27).

Stowage areas

Loading guidelines

WARNING

If objects, luggage or loads are not secured or not secured sufficiently, they could slip, tip over or be flung around and thereby hit vehicle occupants. There is a risk of injury, particularly in the event of sudden braking or a sudden change in direction.

Always store objects so that they cannot be flung around. Secure objects, luggage or loads against slipping or tipping before the journey.

WARNING

Combustion engines emit poisonous exhaust gases such as carbon monoxide. If the tailgate is open when the engine is running, particularly if the vehicle is moving, exhaust fumes could enter the passenger compartment. There is a risk of poisoning.

Turn off the engine before opening the tailgate. Never drive with the tailgate open.

The gross vehicle weight (GVW) is the vehicle weight including fuel, vehicle tool kit, spare wheel, installed accessories, vehicle occupants and luggage/cargo.

The gross load limit and the gross vehicle weight rating (GVWR) for your vehicle must

never be exceeded. The gross load limit and the GVWR are specified on the vehicle identification plate on the B-pillar of the driver's door (▷ page 410).

The load must also be distributed so that the weight on each axle never exceeds the gross axle weight rating (GAWR) for the front and rear axles. The specifications for GVWR and GAWR are on the vehicle identification plate on the B-pillar of the driver's door (▷ page 410).

Observe the notes on the loading the vehicle (▷ page 410).

The handling characteristics of a laden vehicle are dependent on the distribution of the load within the vehicle. For this reason, you should observe the following notes when transporting a load:

- Never exceed the maximum permissible gross vehicle weight or the gross axle weight rating of the vehicle (including occupants).
- The cargo compartment is the preferred place to carry objects.
- Position heavy loads as far forwards as possible and as low down in the cargo compartment as possible.
- The load must not protrude above the upper edge of the seat backrests.
- Always place the load against the rear or front seat backrests. Make sure that the seat backrests are securely locked into place.
- Always place the load behind unoccupied seats if possible.
- Use the cargo tie down rings and the parcel nets to transport loads and luggage.
- Use cargo tie-down rings and fastening materials appropriate for the weight and size of the load.
- Hook in the cargo net when loading.
- Secure the load with sufficiently strong and wear-resistant tie-downs. pad sharp edges for protection.

Stowage space

Important safety notes

WARNING

If objects in the passenger compartment are stowed incorrectly, they can slide or be thrown around and hit vehicle occupants. There is a risk of injury, particularly in the event of sudden braking or a sudden change in direction.

- Always stow objects so that they cannot be thrown around in such situations.
- Always make sure that objects do not protrude from stowage spaces, parcel nets or stowage nets.
- Close the lockable stowage spaces while driving.
- Stow and secure objects that are heavy, hard, pointy, sharp-edged, fragile or too large in the cargo compartment.

Observe the loading guidelines (▷ page 332).

Glove box



- ▶ **To open:** pull handle ① and open glove box flap ②.
- ▶ **To close:** fold glove box flap ② upwards until it engages.

i The glove box can be cooled (▷ page 152).



- ① Glove box unlocked
- ② Glove box locked

The glove box can be locked and unlocked using the mechanical key.

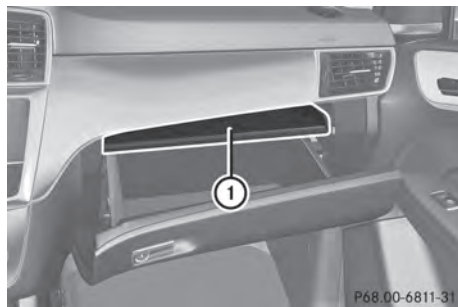

Partition ① for stowing flat objects is located in the upper section of the glove box. It can be removed to increase the stowage space in the glove box.

- ▶ **To remove:** pull partition ① forwards and out
- ▶ **To install:** insert partition ① and push it back until it engages.

Stowage compartment under the armrest

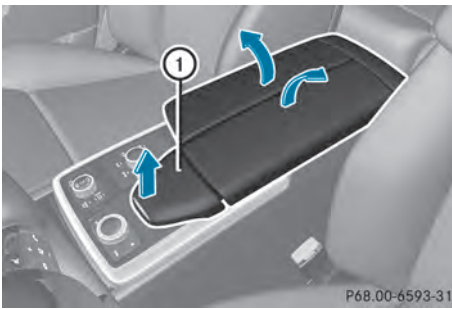

P68.00-6593-31

- **To open:** pull handle ① up. The armrest folds out.

In the stowage compartment, there is a stowage tray.

- ❗ Depending on the vehicle's equipment, a USB connection and an AUX IN connection or a Media Interface are installed in the stowage compartment.

Media Interface is a universal interface for mobile audio equipment, e.g. for an iPod® or MP3 Player.

- ❗ There is a removable stowage tray in the storage compartment, in which objects such as an iPod® can be stored.

Eyeglasses compartment



P68.00-6670-31

- **To open:** press marking ①.

The eyeglasses compartment opens downwards.

- **To close:** press marking ① again and eyeglasses compartment returns upwards and engages.

Make sure that the eyeglasses compartment is always closed while the vehicle is in motion.

Stowage compartment in the front center console

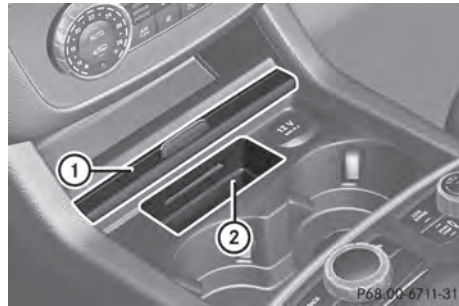

P68.00-6711-31

- **To open:** slide cover ① forwards. Stowage compartment ② appears.
- **To close:** pull cover ① back as far as it will go.

Stowage compartment in the rear center console



P68.00-6595-31

- **To open:** briefly press the stowage compartment marking. The stowage compartment opens.

- i** Depending on the vehicle's equipment, there may be open stowage spaces above and below the stowage compartment.

Stowage net

WARNING

Vehicles with the Occupant Classification System (OCS):

If the gross weight of the objects in the stowage net on the back of the front-passenger seat is greater than 4.4 lb (2 kg), OCS cannot correctly assess the occupant's weight category. The front-passenger front air bag could deploy without cause, or may fail to deploy in the event of an accident. This poses an increased risk of injury or even fatal injury. Never exceed the permissible gross weight of 4.4 lb (2 kg). Stow and secure heavy objects in the cargo compartment.

Stowage nets are located in the front-passenger footwell and on the back of the driver's and the front-passenger seat.

Observe the loading guidelines (▷ page 332) and the safety notes regarding stowage spaces (▷ page 333).

Through-loading facility in the rear

If objects or loads are not secured when being transported in the through-loading facility, they could slip or be thrown around and thereby hit vehicle occupants.

Observe the loading guidelines (▷ page 332) and the safety notes regarding stowage spaces (▷ page 333).

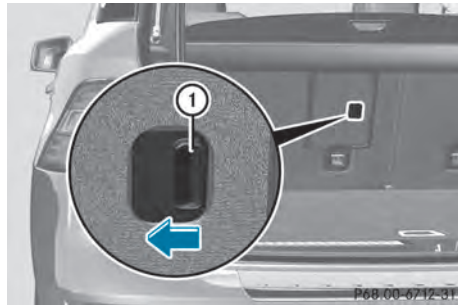

The through-loading facility is opened from the cargo compartment.

- ▶ Release the seat backrests in the second row of seats and tilt them in the cargo/load position (▷ page 106).
- ▶ Fold down the rear seat armrest.
- ▶ Pull the center head restraint on the rear bench seat into the uppermost position (▷ page 104).
- ▶ Slide release catch ① to the left and swing flap ② to the left until it is lying on the rear side of the rear bench seat.

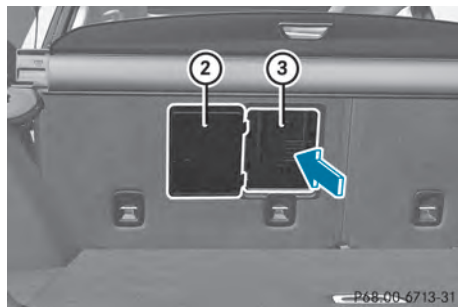

- ▶ Push cover ③ forward until it is lying on the rear seat armrest.

Cargo compartment enlargement

Important safety notes

WARNING

If the rear bench seat/rear seat and seat backrest are not engaged they could fold

forwards, e.g. when braking suddenly or in the event of an accident.

- The vehicle occupant would thereby be pushed into the seat belt by the rear bench seat/rear seat or by the seat backrest. The seat belt can no longer offer the intended level of protection and could even cause injuries.
- Objects or loads in the trunk/cargo compartment cannot be restrained by the seat backrest.

There is an increased risk of injury.

Before every trip, make sure that the seat backrests and the rear bench seat/rear seat are engaged.

- ❗ Fold the seat cushion upwards before folding the rear bench seat forward. Otherwise, the backrests may be damaged.

When the backrest is folded forwards, the front seats should not be moved to their rearmost position. Otherwise, the front seats and the rear bench seat could be damaged.

Observe the loading guidelines (▷ page 332).

The left-hand and right-hand rear seat backrests can be folded forwards separately to increase the cargo compartment capacity.

Folding the rear bench seat forwards

- ❗ The backrest is heavy. Therefore, take care when folding it down. Make sure that the head restraints are pushed all the way in so that the backrests and seat cushions are not damaged.



- ❗ If the driver's or front-passenger seat is set for a larger person, it may not be possible to fold the rear bench seat forwards. In this case, move the front seats as far forward as possible.

- ▶ Move the head restraints to the lowest position (▷ page 106).
- ▶ Fold seat cushion ① upwards.

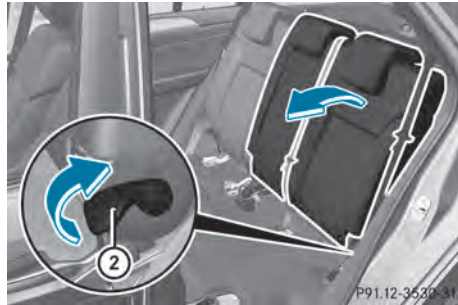

- ▶ Pull release handle ② upwards in the direction of the arrow until the backrest is fully released.
- ▶ Fold the backrest forwards until it reaches the cargo compartment position.

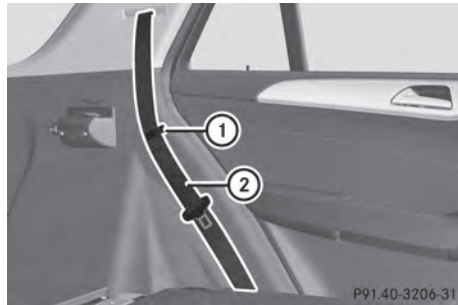

- ▶ Guide seat belts ② under respective clips ①.

Folding the rear bench seat back

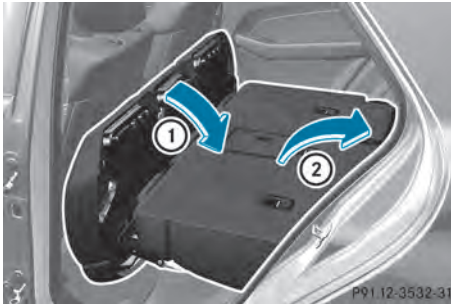

- ▶ Fold seat backrest ② back until it engages. Make sure not to trap the seat belt while doing so.
- ▶ Swing seat cushion ① back.
- ▶ Pull up and adjust the head restraints if necessary (▶ page 106).

Securing cargo

Cargo tie-down rings

General notes

WARNING

The Top Tether anchorages cannot secure a load. If you secure a load with the Top Tether anchorages, the Top Tether anchorages could be pulled out during braking, abrupt changes in direction or in the event of an accident. The load could slip, tip over or be flung around and thereby hit vehicle occupants. There is a risk of injury.

Only use the cargo tie down rings when securing a load.

Observe the following notes on securing loads:

- Secure the load using the cargo tie-down rings.
- Distribute the load on the cargo tie down rings evenly.
- Do not use elastic straps or nets to secure a load, as these are only intended as an anti-slip protection for light loads.

- Do not route tie-downs across sharp edges or corners.
- Pad sharp edges for protection.

Cargo compartment

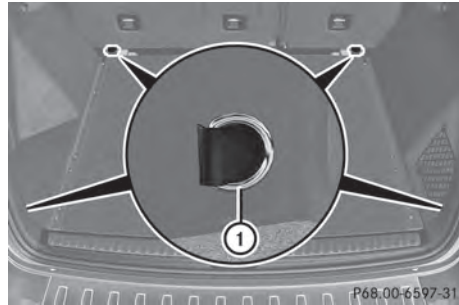

There are four cargo tie-down rings ① in the cargo compartment.

Before using the cargo tie-down rings on the front right-hand side of the cargo compartment, the stowage net must be pushed down.

Bag hook

WARNING

The bag hooks cannot restrain heavy objects or items of luggage. Objects or items of luggage could be flung around and thereby hit vehicle occupants when braking or abruptly changing directions. There is a risk of injury.

Only hang light objects on the bag hooks. Never hang hard, sharp-edged or fragile objects on the bag hooks.

- ❗ The bag hook can bear a maximum load of 6.6lbs (3kg) and should not be used to secure a load.

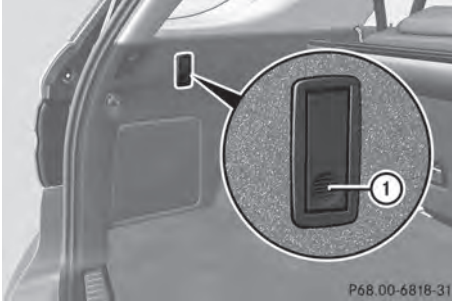

There is a bag hook in the cargo compartment on the left-hand side.

- ▶ Press bag hook marking ①.
- ▶ Turn bag hook ① until it engages.

Securing hooks



There are two securing hooks ① on each side of the cargo compartment.

Only secure lightweight luggage items on the mounting hooks to a maximum of 9 lbs (4 kg).

Cargo compartment cover

Important safety notes

WARNING

On its own, the cargo compartment cover cannot secure or restrain heavy objects, items of luggage and heavy loads. You could be hit by an unsecured load during sudden changes in direction, braking or in the event

of an accident. There is an increased risk of injury or even fatal injury.

Always store objects so that they cannot be flung around. Secure objects, luggage or loads against slipping or tipping over, e.g. by using tie downs, even if you are using the cargo compartment cover.

- ❗ When loading the vehicle, make sure that you do not stack the load in the cargo compartment higher than the lower edge of the side windows. Do not place heavy objects on top of the cargo compartment cover.

A cargo compartment cover or a combined cargo cover and net (cargo compartment cover with cargo net) is installed, depending on equipment, behind the rear bench seat backrest.

Extending/retracting the cargo compartment cover

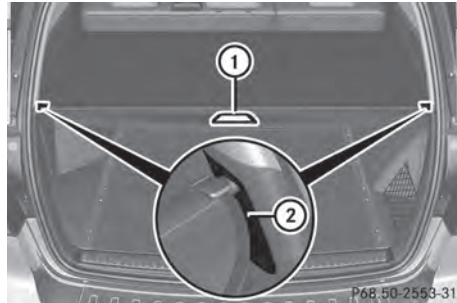

- ▶ **To extend:** pull the cargo compartment cover back by grab handle ① and clip it into retainers ② on the left and right.
- ▶ **To retract:** unhook the cargo compartment cover from left-hand and right-hand retainers ②.
- ▶ Guide cargo compartment cover forwards by grab handle ① until it is completely rolled up.

Removing/installing the cargo compartment cover (without integrated cargo net)

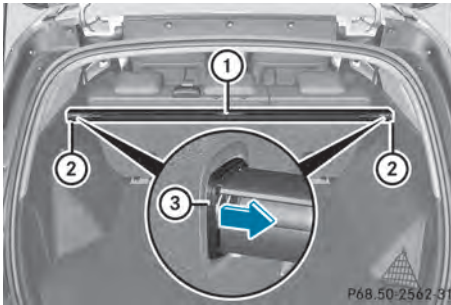

- ▶ **To remove:** make sure that cargo compartment cover ① is rolled up.
- ▶ Push end cap ③ of cargo compartment cover ① in the direction of the arrow on the right or left-hand side.
- ▶ Push cargo compartment cover ① into opposite anchorage ②.
- ▶ Remove cargo compartment cover ①.
- ▶ **To install:** if installed, remove the protective caps from the side panels of the seat row in which the cargo compartment cover is to be installed. Use a suitable object here, e.g. a coin.
- ▶ Install the protective caps to the side panels of the other seat row.
- ▶ Place cargo compartment cover ① into anchorage ② on the right or left-hand side.
- ▶ Push in opposite end cap ③ of cargo compartment cover ① in the direction of the arrow and insert cargo compartment cover ① into opposite anchorage ②.

Removing/installing the combined cargo cover and net (cargo compartment cover with integrated cargo net)

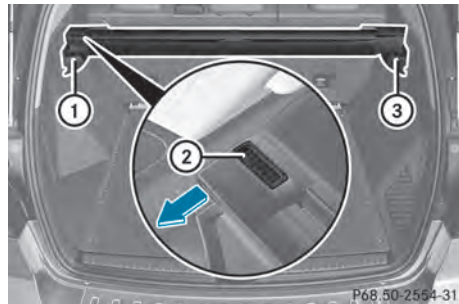

You can install and remove the combined cargo cover and net from the cargo compartment.

- ▶ Make sure that the cargo net and the cargo compartment cover are rolled up.
- ▶ **To remove:** press button ②.
- ▶ Swing the combined cargo cover and net in the direction of the arrow.
- ▶ First, detach the combined cargo cover and net from left-hand catch ① and then remove it from right-hand fixture ③.
- ▶ **To install:** push the combined cargo cover and net up to the stop into right-hand fixture ③.
- ▶ Place the combined cargo cover and net into the left-hand fixture and push it into catch ① until the combined cargo cover and net engages audibly.

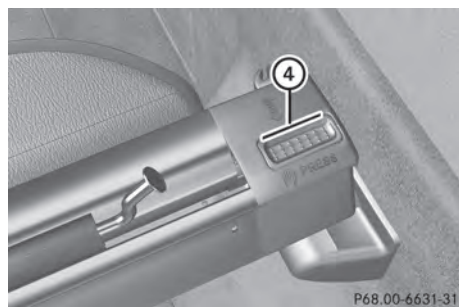

- Make sure that red lock status indicator ④ is no longer visible. The combined cargo cover and net will otherwise not be locked in place.

Cargo net in combined cargo cover and net

Important safety notes

WARNING

On its own, the cargo net cannot secure or restrain heavy objects, items of luggage and heavy loads. You could be hit by an unsecured load during sudden changes in direction, braking or in the event of an accident. There is an increased risk of injury or even fatal injury.

Always store objects so that they cannot be flung around. Secure objects, luggage or loads against slipping or tipping over, e.g. by using tie downs, even if you are using the cargo net.

It is important to use a cargo net if you load the vehicle with small objects above the seat backrests. For safety reasons, always use a cargo net when transporting loads.

Attaching the cargo net

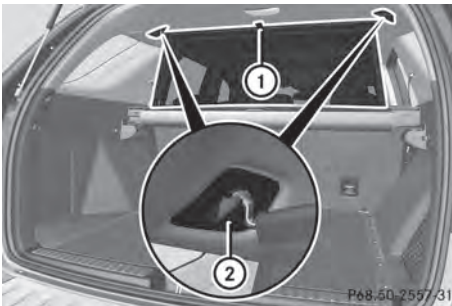

- Pull the cargo net up by tab ① and hook it into eyelets ② using both hands.

Coat hooks on the tailgate

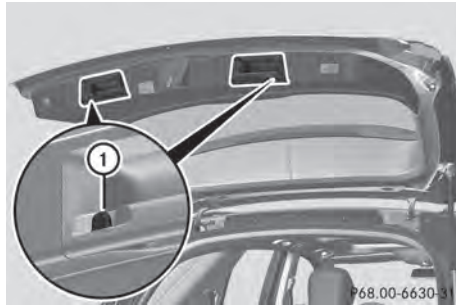

- ① Coat hook

EASY-PACK load-securing kit

Components and storage

The EASY-PACK load-securing kit allows you to use your cargo compartment for a variety of purposes. The accessory parts are located under the cargo compartment floor.

- Open the cargo compartment floor (► page 342).

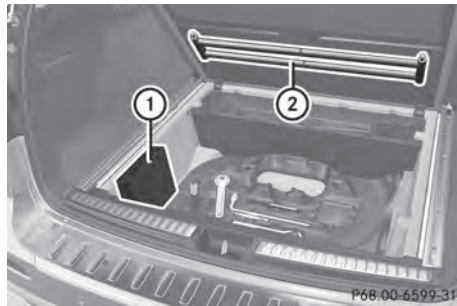

EASY-PACK load-securing kit accessory parts

- ① Bag containing the brackets and luggage holder
- ② Telescopic rod

Inserting the brackets into the loading rail

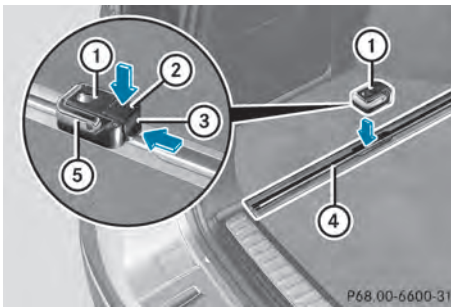

- ▶ Insert bracket ① into the center of loading rail ④.
- ▶ Press release button ② and push bracket ① into the desired position in loading rail ④.
- ▶ Let go of release button ②.
- ▶ Press locking button ③. Bracket ① is locked in loading rail ④.
- ▶ If necessary, fold cargo tie-down ring ⑤ upwards.

Luggage holder

! Only use the luggage holder to secure cargo with a maximum weight of 15.4 lbs (7 kg) and with dimensions that the luggage holder can safely and securely contain.

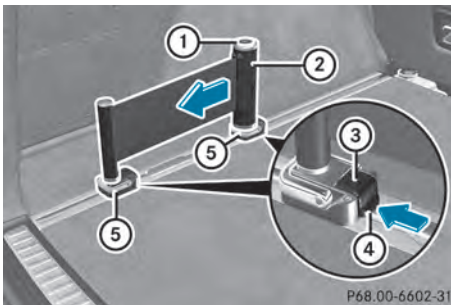

The luggage holder can be used to secure light loads against the side wall of the cargo compartment to prevent them from moving around.

- ▶ **To install:** insert two brackets ⑤ into the left or right loading rail (▷ page 340).
- ▶ Press release button ① of the luggage holder and pull the strap out slightly.
- ▶ Insert luggage holder ② into brackets ⑤ and, while doing so, press release button ③ and push the luggage holder downwards until it engages.
- ▶ Press release button ① of the luggage holder and pull the strap out in the direction of the arrow.
- ▶ Place the load between the strap and the cargo compartment side wall.
- ▶ Using one hand, press locking button ① of the luggage holder.
- ▶ With your other hand, let the strap go slowly until the load is secured.
- ▶ Make sure that locking button ④ on brackets ⑤ is pressed. This keeps brackets ⑤ in place on the loading rail.
- ▶ **To remove:** press release button ③ on respective bracket ⑤ and remove luggage holder ② by pulling upwards and out.

Telescopic rod

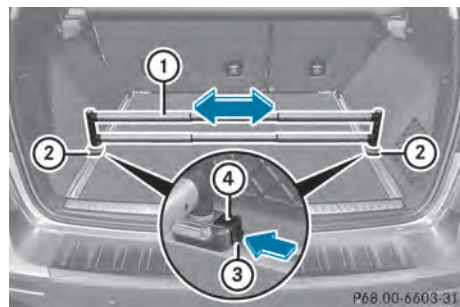

The telescopic rod can be used to secure the load against the rear seats to prevent it from moving around.

- ▶ **To install:** insert one bracket ② into both the left and the right loading rails and slide it to the desired position (▷ page 340).
- ▶ Insert telescopic rod ① into brackets ② and, while doing so, press release button ④ and push the rod downwards until it engages.
- ▶ Make sure that locking button ③ on brackets ② is pressed. This keeps brackets ② in place on the loading rail.
- ▶ **To remove:** press release button ④ on respective bracket ② and remove telescopic rod ① by pulling it upwards and out.

Stowage well under the cargo compartment floor

⚠ WARNING

If you drive when the cargo compartment floor is open, objects could be flung around, thus striking vehicle occupants. There is a risk of injury, particularly in the event of sudden braking or a sudden change in direction.

Always close the cargo compartment floor before a journey.

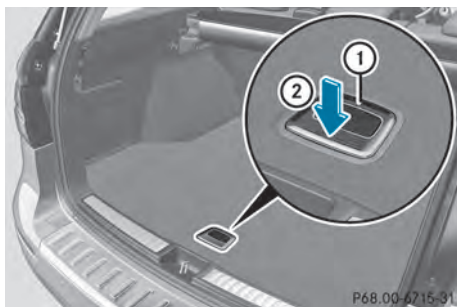

A removable insert under the cargo compartment floor contains the parts of the EASY-PACK load-securing kit. The tire-change tool kit is stored beneath this insert.

- ▶ **To open:** holding the ribbing, press handle ① downwards ②. Handle ① folds up.
- ▶ Swing the cargo compartment floor upwards using handle ① until it rests against the cargo compartment cover.

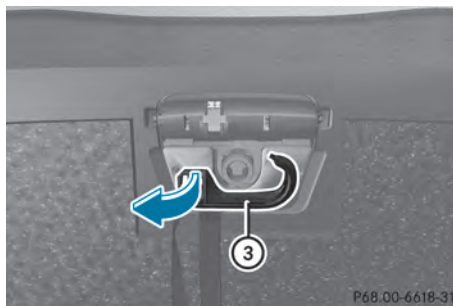

- ▶ Fold out hook ③ on the underside of the cargo compartment floor in the direction of the arrow.

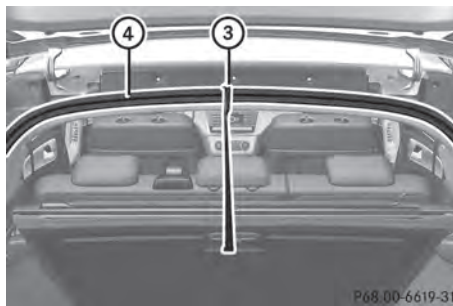

- ▶ Attach hook ③ to the cargo compartment's upper seal ④.
- ▶ **To close:** detach hook ③ from the cargo compartment's upper seal ④.
- ▶ Fasten hook ③ to the bracket on the underside of the cargo compartment floor.
- ▶ Fold the trunk floor down.
- ▶ Press the cargo compartment floor down ② until it engages.

- ▶ **i** To remove the cargo compartment floor, undo the press studs below the cargo compartment floor. When you re-install the

cargo compartment floor, fasten it with the press studs.

Roof carrier

Important safety notes

WARNING

When you load the roof, the center of gravity of the vehicle rises and the driving characteristics change. If you exceed the maximum roof load, the driving characteristics, as well as steering and braking, will be greatly impaired. There is a risk of an accident.

Never exceed the maximum roof load and adjust your driving style.

! Mercedes-Benz recommends that you only use roof carriers that have been tested and approved for Mercedes-Benz vehicles. This helps to prevent damage to the vehicle.

Position the load on the roof carrier in such a way that the vehicle will not sustain damage even when it is in motion.

Depending on the vehicle equipment, ensure that when the roof carrier is installed you can:

- raise the sliding sunroof fully
- open the panorama roof with power tilt/sliding panel fully
- open the tailgate fully

The maximum roof load is 220 lbs(100 kg).

Attaching the roof carrier



- ▶ Secure the roof carrier to roof rails **①**. In doing so, observe the manufacturer's installation instructions.

Features

Cup holder

Important safety notes

WARNING

If objects in the passenger compartment are stowed incorrectly, they can slide or be thrown around and hit vehicle occupants. There is a risk of injury, particularly in the event of sudden braking or a sudden change in direction.

- Always stow objects so that they cannot be thrown around in such situations.
- Always make sure that objects do not protrude from stowage spaces, parcel nets or stowage nets.
- Close the lockable stowage spaces while driving.
- Stow and secure objects that are heavy, hard, pointy, sharp-edged, fragile or too large in the cargo compartment.

! Only use the cup holders for containers of the right size and which have lids. The drinks could otherwise spill.

The stowage compartments in the doors provide space for bottles with a capacity of up to 34 fl. oz. (1.0 liter).

The bottles are not secured or prevented from tipping over. Therefore, do not place any open drink containers in the stowage compartments.

Cup holder in the front-compartment center console

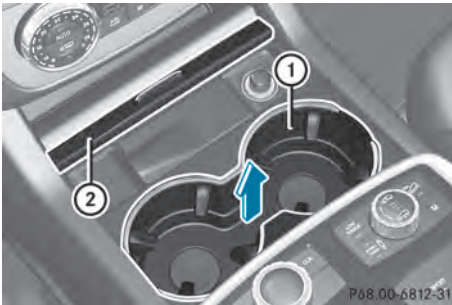

- ① Cup holder
- ② Cover

- ▶ **To open:** slide cover ② to its foremost position.
- ▶ **To close:** pull cover ② back as far as it will go.

You can remove the cup holder's rubber mat for cleaning. Clean with clear, lukewarm water only.

Temperature-controlled cup holder in the front-compartment center console



- ① Cup holder
- ② Residual heat indicator lamp
- ③ Switch

The temperature-controlled cup holder can be used to keep cold drinks cool and warm drinks warm.

- ▶ Turn the SmartKey to position **2** in the ignition lock.
- ▶ **To switch on the cooling function:** press and hold button ③ until the blue indicator lamp on the button lights up.
- ▶ **To switch on the heating function:** press and hold button ③ until the red indicator lamp on the button lights up.
- ▶ **To switch off the function:** press and hold button ③ until the indicator lamp on the button goes out.

When the heating function is used, the metal insert of the cup holder is heated. Once a certain temperature is reached, residual heat indicator lamp ② lights up. This means that the metal insert of the cup holder is hot. For this reason, you must not reach into the cup holder metal insert.

Do not use hard or sharp objects to clean the cup holder. Use only a soft cloth to clean it.

Cup holder in the rear seat armrest

- ⚠ Do not sit on or support your body weight on the rear seat armrest when it is folded down, as you could otherwise damage it.



- ▶ Fold down the rear seat armrest. Cup holder ① is located in the rear seat armrest.

Sun visors

Overview

WARNING

If the mirror cover of the vanity mirror is folded up when the vehicle is in motion, you could be blinded by incident light. There is a risk of an accident.

Always keep the mirror cover folded down while driving.

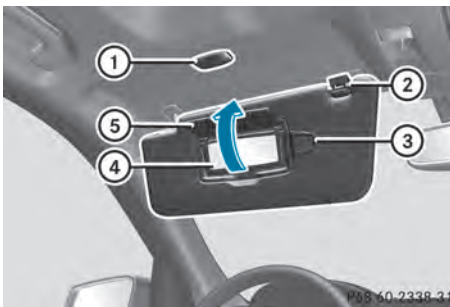

- ① Mirror light
- ② Bracket
- ③ Retaining clip, e.g. for a car park ticket
- ④ Vanity mirror
- ⑤ Mirror cover

Vanity mirror in the sun visor

Mirror light ① only functions if the sun visor is clipped into bracket ② and mirror cover ⑤ has been folded up.

Glare from the side

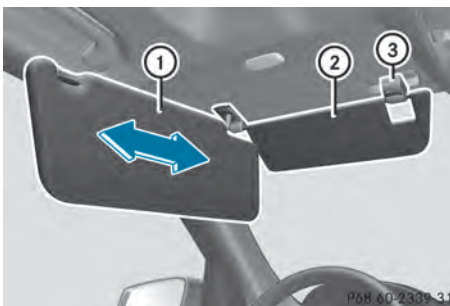

- ▶ Fold down sun visor ①.
- ▶ Pull sun visor ① out of retainer ③.
- ▶ Swing sun visor ① to the side.
- ▶ Slide sun visor ① horizontally as required.
- ▶ Fold down additional sun visor ② to the windshield.

Roller sunblinds on the rear side windows

! Always guide the roller sunblind by hand. Do not let it snap back suddenly as this would damage the automatic roller mechanism.

! Do not drive the vehicle with the roller sunblind hooked in and the side windows opened simultaneously. The roller sunblind can jump out of the retainers and spring back suddenly when driving at high speeds, e.g. when driving on the freeway. This could damage the inertia reel. Therefore, either close the side window or retract the roller sunblind before driving at high speeds.



- ▶ **To extend:** pull the roller sunblind out by tab ① and hook it onto retainers ② at the back of the window.

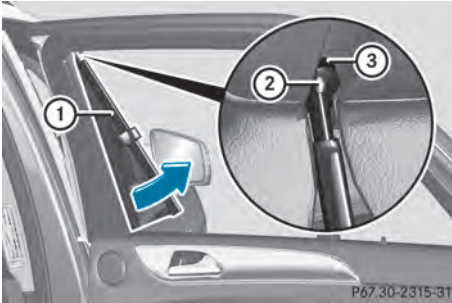

The roller sunblind can be hooked back into place should it pop out from the top of the guide rail.

- ▶ Tilt pull-out profile ① as illustrated.
- ▶ Slip guide bush ② into open area of guide rail ③.
- ▶ Straighten up pull-out profile ① again.

Ashtray

Front ashtray

❗ The holder under the ashtray is not heat resistant. Before placing lit cigarettes in the ashtray, make sure that the ashtray is properly engaged. Otherwise, the holder could be damaged.

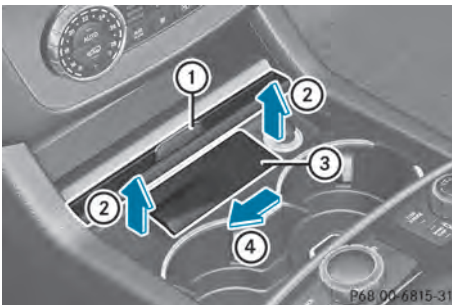

- ▶ **To open:** slide cover ① to its foremost position.
- ▶ Fold cover ② of the insert upwards.
- ▶ **To remove the insert:** push insert ③ to the left ④. Insert ③ slides out slightly to the right.

- ▶ Lift insert ③ up ② and out.
- ▶ **To re-install the insert:** place insert ③ into the holder and press it down on the right until it engages.
- ▶ **To close:** pull cover ① back as far as it will go.

Rear-compartment ashtray

❗ Close the ashtray when it is not in use and before you fold the rear seats forward. You can otherwise damage the ashtray.

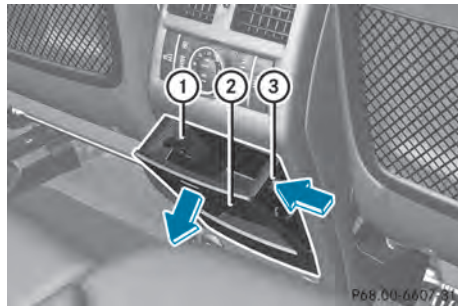

- ▶ **To open:** briefly press cover ② at the top. The ashtray opens.
- ▶ **To remove the insert:** push into recess ③ from the right. Ashtray insert ① slides out slightly to the right.
- ▶ Lift insert ① up and out.
- ▶ **To re-install the insert:** place insert ① into the holder and press down on the right until it engages.

Vehicles without a Rear Seat Entertainment System have an ashtray in the center console in the rear compartment.

Cigarette lighter

⚠ WARNING

You can burn yourself if you touch the hot heating element or the socket of the cigarette lighter.

In addition, flammable materials can ignite if:

- the hot cigarette lighter falls
- a child holds the hot cigarette lighter to objects, for example

There is a risk of fire and injury.

Always hold the cigarette lighter by the knob. Always make sure that the cigarette lighter is out of reach of children. Never leave children unsupervised in the vehicle.

- !** The cigarette lighter in the center console in the front compartment is not intended for operating the tire inflation compressor.

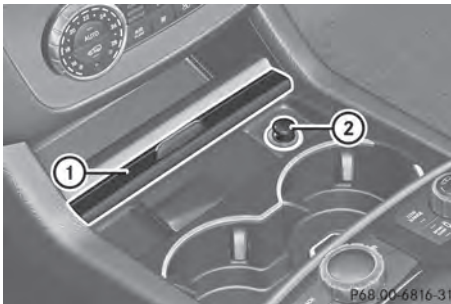

Your attention must always be focused on the traffic conditions. Only use the cigarette lighter when road and traffic conditions permit.

- ▶ Turn the SmartKey to position **2** in the ignition lock (▷ page 157).
- ▶ **To open:** slide cover (1) to its foremost position.
- ▶ Press in cigarette lighter (2). Cigarette lighter (2) will pop out automatically when the heating element is red-hot.
- ▶ **To close:** pull cover (1) back as far as it will go.

12 V sockets

General notes

- ▶ Turn the SmartKey to position **1** in the ignition lock (▷ page 157).

With the exception of the socket in the front center console, all sockets can be used for accessories with a maximum current draw of 240 W (20 A). The socket in the front center console can be used for accessories with a maximum current draw of 180 W (15 A). Accessories include such items as lamps or chargers for mobile phones.

If you use the sockets for long periods when the engine is switched off, the battery may discharge.

- i** An emergency cut-out ensures that the on-board voltage does not drop too low. If the on-board voltage is too low, the power to the sockets is automatically cut. This ensures that there is sufficient power to start the engine.

Socket in the front-compartment center console

- !** The socket is not suitable for operating the tire inflation compressor.

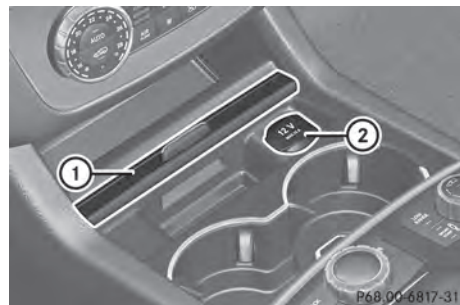

- ▶ **To open:** slide cover (1) to its foremost position.
- ▶ Lift up the cover of socket (2).
- ▶ **To close:** pull cover (1) back as far as it will go.

Socket in the rear-compartment center console



- Lift up the cover of socket ①.

Vehicles with the Rear Seat Entertainment System have two sockets in the center console in the rear compartment.

Socket in the cargo compartment

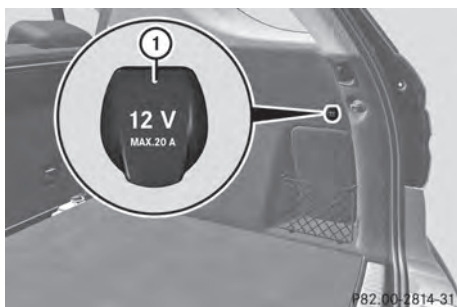

- Lift up the cover of socket ①.

115 V socket

Important safety notes

DANGER

When a suitable device is connected, the 115 V power socket will be carrying a high voltage. You could receive an electric shock if the connector cable or the 115 V power socket is pulled out of the trim or is damaged or wet. There is a risk of fatal injury.

- Use only connector cables that are dry and free of damage.
- When the ignition is off, make sure that the 115 V power socket is dry.
- Have the 115 V power socket checked or replaced immediately at a qualified specialized workshop if it is damaged or has been pulled out of the trim.
- Never plug the connector cable into a 115 V power socket that is damaged or has been pulled out of the trim.

DANGER

If you reach into the power socket or plug inappropriate devices into the power socket, you could receive an electric shock. There is a risk of fatal injury.

Only connect appropriate devices to the power socket.

- Note that work and repairs on the 115 V power socket should only be carried out by qualified specialist personnel.

General notes

115 V power socket provides an alternating voltage of 115 V so that small electronic devices can be connected. These devices, such as games consoles, chargers and laptops, should not consume more than a maximum of 150 watts altogether.

Requirements for operation of these devices:

- the electronic device that you connect has a suitable connector and conforms to standards specific to the country you are in.
- the plug of the electronic device is plugged correctly into 115 V power socket.
- the maximum wattage of the device to be connected must not exceed 150 watts.
- the on-board power supply is within a permissible voltage range.
- the 12 V sockets in the rear compartment and the cargo compartment are operational.

Using the 115 V power socket

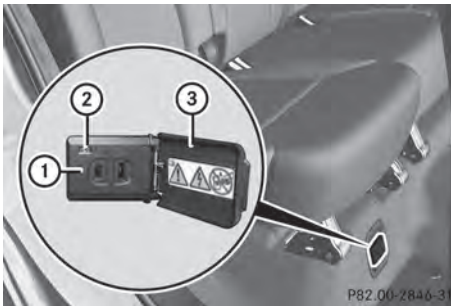

- ▶ **To switch on:** switch the ignition on.
- ▶ Open flap ③.
- ▶ Insert the plug of the electronic device into 115 V power socket ①.
Indicator lamp ② lights up.
- ▶ **To turn off:** disconnect the plug from 115 V power socket ①.
Ensure that you do not pull on the cord.

Problems with the 115 V power socket

| Problem | Possible causes/consequences and ► Solutions |
|--|---|
| The warning lamp on the 115 V power socket is not lit. | The on-board voltage is too low because the battery is too weak. ► Start the engine. or ► Charge the battery (> page 387). If the indicator lamp still does not light up: ► Visit a qualified specialist workshop. |
| | The temperature of the DC/AC converter is temporarily too high. ► Remove the electronic device connector from the 115 V socket. ► Let the DC/AC converter cool down. If the indicator lamp still does not light up after cooling down the converter: ► Visit a qualified specialist workshop. |
| | You have connected an electronic device that has a constant nominal power of less than 150 watts, but a very high switch-on current. This device will not work. If you connect such a device, the 115 V power socket will not supply it with power. ► Connect a suitable device. |
| | |

mbrace

Important safety notes

! You must have a license agreement to activate the mbrace service. Make sure that your system is activated and ready for use. To register, press the  MB Info call button. If any of the steps mentioned are not carried out, the system may not be activated.

If you have questions about the activation, contact one of the following telephone hotlines:

- **USA:** Mercedes-Benz Customer Assistance Center at 1-800-FOR-MERCEdes (1-800-367-6372) or 1-866-990-9007
- **Canada:** Customer Service at 1-888-923-8367



Shortly after successfully registering with the mbrace service (Canada: TELEAID), a user ID and password will be sent to you by post. USA only: you can use this password to log onto the mbrace area under "Owners Online" at <http://www.mbusa.com>.

The mbrace system is available if:

- it has been activated and is operational
 - the corresponding mobile phone network is available for transmitting data to the Customer Center
 - a service subscription is available
 - the starter battery is sufficiently charged
- i** Determining the location of the vehicle on a map is only possible if:
- GPS reception is available.
 - the vehicle position can be forwarded to the Customer Assistance Center.

The mbrace system

To adjust the volume during an mbrace call, proceed as follows:

- ▶ Press the  or  button on the multifunction steering wheel.

or

- ▶ Use the volume controller of the audio system/COMAND.

The mbrace system provides various services, e.g.:





- automatic and manual emergency call
- Roadside Assistance call
- MB Info call

USA only: you can find information and a description of all available features under "Owners Online" at <http://www.mbusa.com>.

System self-test

After you have switched on the ignition, the system carries out a self-diagnosis.

A malfunction in the system has been detected if one of the following occurs:

- The indicator lamp in the SOS button does not come on during the system self-test.
- The indicator lamp in the  Roadside Assistance button does not light up during self-diagnosis of the system.
- The indicator lamp in the  MB Info call button does not light up during self-diagnosis of the system.
- The indicator lamp in one or more of the following buttons continues to light up red after the system self-diagnosis:
 - SOS button
 - the  Roadside Assistance call button
 - the  MB Info call button
- The **mbrace Inoperative** or **mbrace Service Not Activated** message appears in the multifunction display after the system self-diagnosis.



If a malfunction is indicated as outlined above, the system may not operate as expected. In the event of an emergency, help will have to be summoned by other means.

Have the system checked at the nearest authorized Mercedes-Benz Center or contact the following service hotlines:

- **USA:** Mercedes-Benz Customer Assistance Center at 1-800-FOR-MERCEdes (1-800-367-6372) or 1-866-990-9007
- **Canada:** Customer Service at 1-888-923-8367

Emergency call

Important safety notes

 You must have a license agreement to activate the mbrace service. Make sure that your system is activated and ready for use. To register, press the  MB Info call button. If any of the steps mentioned are not carried out, the system may not be activated.

If you have questions about the activation, contact one of the following telephone hotlines:

- **USA:** Mercedes-Benz Customer Assistance Center at 1-800-FOR-MERCEdes (1-800-367-6372) or 1-866-990-9007
- **Canada:** Customer Service at 1-888-923-8367

General notes

An emergency call is dialed automatically if an air bag or Emergency Tensioning Device is triggered.

 You cannot end an automatically triggered emergency call yourself.

An emergency call can also be initiated manually.

As soon as the emergency call has been initiated, the indicator lamp in the SOS button

flashes. The **Connecting Call** message appears in the multifunction display.

The audio output is muted.

Once the connection has been made, the **Call Connected** message appears in the multifunction display.

All important information on the emergency call is transmitted, for example:

- Current location of the vehicle (as determined by the GPS system)
- Vehicle identification number
- Information on the severity of the accident

Shortly after the emergency call has been initiated, a voice connection is automatically established between the Mercedes-Benz Customer Assistance Center and the vehicle occupants.

- If the vehicle occupants respond, the Mercedes-Benz Customer Assistance Center attempts to get more information on the emergency.
- If there is no response from the vehicle occupants, an ambulance is immediately sent to the vehicle.

The mbrace system has not been able to initiate an emergency call if no voice connection to the Response Center has been established. This can occur, for example, if the relevant mobile phone network is not available. The indicator lamp in the SOS button flashes continuously.

The **Call Failed** message appears in the multifunction display and must be confirmed. In this case, seek assistance by other means.

Making an emergency call

WARNING

It can be dangerous to remain in the vehicle, even if you have pressed the SOS button in an emergency if:

- you see smoke inside or outside of the vehicle, e.g. if there is a fire after an accident
- the vehicle is on a dangerous section of road
- the vehicle is not visible or cannot easily be seen by other road users, particularly when dark or in poor visibility conditions

There is a risk of an accident and injury.

Leave the vehicle immediately in this or similar situations as soon as it is safe to do so. Move to a safe location along with other vehicle occupants. In such situations, secure the vehicle in accordance with national regulations, e.g. with a warning triangle.



- ▶ **To initiate an emergency call manually:** press cover ① briefly to open.
- ▶ Press SOS button ② briefly. The indicator lamp in SOS button ② flashes until the emergency call is concluded.
- ▶ Wait for a voice connection to the Mercedes-Benz Customer Assistance Center.
- ▶ After the emergency call, close cover ①.

i If the mobile phone network is not available, mbrace is not able to make an emergency call. If you leave the vehicle

immediately after pressing the SOS button, you do not know if mbrace has successfully made the emergency call. In this situation, seek additional assistance by other means.

Roadside Assistance button



- ▶ Press Roadside Assistance button ①. This initiates a call to the Mercedes-Benz Customer Assistance Center. The indicator lamp in Roadside Assistance button ① flashes while the call is active. The **Connecting Call** message appears on the multifunction display. The audio output is muted.

If a connection can be made, the **Call Connected** message appears in the multifunction display.

If a cellular phone network is available and there is sufficient GPS reception, the mbrace system transmits data to the Mercedes-Benz Customer Assistance Center, for example:

- Current location of the vehicle
- Vehicle identification number

- ❗ The display of the audio system or COMAND shows that an mbrace call is active. During the call, you can change to the navigation menu by pressing the NAVI button on COMAND, for example. Voice output is not available.

A voice connection is established between the Mercedes-Benz Customer Assistance Center and the vehicle occupants.

From the vehicle remote malfunction diagnosis, the Mercedes-Benz Customer

Assistance center can ascertain the nature of the problem (▷ page 357).

The Mercedes-Benz Customer Assistance Center either sends a qualified Mercedes-Benz technician or arranges for your vehicle to be transported to the nearest authorized Mercedes-Benz Center. You may be charged for services such as repair work and/or towing. Further details are available in your mbrace manual.

- ❗ The mbrace system failed to initiate a Roadside Assistance call if:

- the indicator lamp for Roadside Assistance call button ① is flashing continuously.
- no voice connection to the Mercedes-Benz Customer Assistance Center was established.

This may be because the corresponding mobile phone network is not available.

The **Call Failed** message appears in the multifunction display.



- ▶ **To end a call:** press the  button on the multifunction steering wheel.

or

- ▶ Press the corresponding button for ending a phone call on the audio system or on COMAND.

MB Info call button



- ▶ Press MB Info call button . This initiates a call to the Mercedes-Benz Customer Assistance Center. The indicator lamp in MB Info call button  flashes while the connection is being made. The **Connecting Call** message appears on the multifunction display. The audio system is muted.

If a connection can be made, the **Call Connected** message appears in the multifunction display.



If a cellular phone network is available and there is sufficient GPS reception, the mbrace system transmits data to the Mercedes-Benz Customer Assistance Center, for example:

- Current location of the vehicle
 - Vehicle identification number
-  The display of the audio system or COMAND shows that an mbrace call is active. During the call, you can change to the navigation menu by pressing the NAVI button on COMAND, for example.

Voice output is not available.

A voice connection is established between the Mercedes-Benz Customer Assistance Center and the vehicle occupants. You can obtain information on how to operate your vehicle's systems, on the location of the nearest authorized Mercedes-Benz Center, and on further products and services offered by Mercedes-Benz USA.

USA only: you can find further information on the mbrace system under "Owners Online" at <http://www.mbusa.com>.

-  The mbrace system failed to initiate an MB Info call if:
- the indicator lamp in MB Info call button  is flashing continuously.
 - no voice connection to the Mercedes-Benz Customer Assistance Center was established.

This may be because the corresponding mobile phone network is not available.

The **Call Failed** message appears in the multifunction display.

- ▶ **To end a call:** press the  button on the multifunction steering wheel.
- or
- ▶ Press the corresponding button for ending a phone call on the audio system or on COMAND.

Call priority

When service calls are active, e.g. Roadside Assistance or MB Info calls, an emergency call can still be initiated. In this case, an emergency call will take priority and override all other active calls.

The indicator lamp of the respective button flashes until the call is ended. An emergency call can only be terminated by the Mercedes-Benz Customer Assistance Center.

All other calls can be ended by pressing:

- the  button on the multifunction steering wheel
- the corresponding button on the audio system or on COMAND for ending a telephone call

-  If an mbrace call is initiated, audio output is muted. The mobile phone is no longer connected to COMAND. However, if you would like to use your mobile phone, do so only when the vehicle is stationary and in a safe location.

Downloading destinations in COMAND

Downloading destinations

Destination Download gives you access to a data bank with over 15 million Points of Interest (POIs). These can be downloaded on the navigation system in your vehicle. If you know the destination, the address can be downloaded. Alternatively, you can obtain the location of Points of Interest (POIs)/ important destinations in the vicinity.

Furthermore, you can download routes with up to 20 way points.

You are prompted to confirm route guidance to the address entered.

The system calculates the route and subsequently starts the route guidance with the address entered.

- i** If you select **No**, the address can be stored in the address book.
- i** The Destination Download function is available if the corresponding mobile phone network is available and data transfer is possible.
- i** You can only use the Destination Download function if the vehicle is equipped with a navigation system.

Route Assistance

This service is part of the mbrace PLUS Package and cannot be purchased separately.

- i** You can also use the Route Assistance function if your vehicle is not equipped with a navigation system.

Within the framework of this service, you receive a professional and reliable form of navigation support without having to leave your vehicle.

The customer service representative finds a suitable route depending on your vehicle's current position and the desired destination. You will then be guided live through the current route section.

Search & Send

General notes

- i** To use "Search & Send", your vehicle must be equipped with mbrace and a navigation system. You must also have an mbrace service subscription.

"Search & Send" is a destination entry service. A destination address which is found on Google Maps® can be transferred via

mbrace directly to your vehicle's navigation system.

Specifying and sending the destination address

- ▶ Go to the website <http://www.maps.google.com> and enter a destination address into the entry field.
- ▶ **To send the destination address to the e-mail address of your mbrace account:** click on the corresponding button.

i Example:

If you select 'Send to vehicle' and then 'Mercedes-Benz', the destination address will be sent to your vehicle.

- ▶ When the "Send" dialog window appears: In the relevant field, enter the e-mail address which you specified when activating your mbrace account.
- ▶ Click "Send".

- i** Information on specific commands such as "Address entry" or "Sending" can be found on the website.

Calling up destination addresses

- ▶ Switch on the ignition.
The destination address is loaded into the vehicle's navigation system.
A display message appears, asking whether navigation should be started.
- ▶ Select **Yes** by sliding **←** **⊙** **→** and turning **Ⓢ** **⊙** the COMAND controller and press **Ⓢ** to confirm.
The system calculates the route and subsequently starts the route guidance with the address entered.

- i** If you select **No**, the address can be stored in the address book.
- i** If you have sent more than one destination address, each individual destination must be confirmed separately.
- i** Destination addresses are loaded in the same order as the order in which they were

sent. If you have multiple Mercedes-Benz vehicles with mbrace and active mbrace accounts:

if multiple vehicles are registered under the same e-mail address, the destination will be sent to all the vehicles.

Vehicle remote opening

You can use the vehicle remote opening if you have unintentionally locked your vehicle and a replacement SmartKey is not available. The vehicle can be opened by the Mercedes-Benz Customer Assistance Center.

The vehicle can be immediately opened remotely within four days of the ignition being turned off. After this time, the remote opening may be delayed by 15 to 60 minutes. After 30 days the vehicle can no longer be opened remotely.

► Contact the following service hotlines:

- **USA:** Mercedes-Benz Customer Assistance Center at 1-800-FOR-MERCEdes (1-800-367-6372) or 1-866-990-9007
- **Canada:** Customer Service at 1-888-923-8367

You will be asked for your password.

► Return to your vehicle at the time agreed upon with the Mercedes-Benz Customer Assistance Center.

USA only: alternatively, the vehicle can be opened via:

- the Internet, under the "Owners Online" section
- the telephone application (e.g. iPhone®, Blackberry)

To do this, you will need your identification number and password.

- **i** Vehicle remote opening is only possible if the corresponding mobile phone network is accessible.

Vehicle remote closing

The remote closing feature can be used when you have forgotten to lock the vehicle and you are no longer nearby. The vehicle can then be locked by the Mercedes-Benz Customer Assistance Center.

The vehicle can be immediately remotely locked within four days of the ignition being turned off. After this time, the remote closing may be delayed by 15 to 60 minutes. After 30 days the vehicle can no longer be closed remotely.

► Contact the following service hotlines:

- **USA:** Mercedes-Benz Customer Assistance Center at 1-800-FOR-MERCEdes (1-800-367-6372) or 1-866-990-9007
- **Canada:** Customer Service at 1-888-923-8367

You will be asked for your PIN.

The next time you are inside the vehicle and you switch on the ignition, the **Doors Locked Remotely** message appears in the multifunction display.

USA only: alternatively, the vehicle can be locked via:

- the Internet, under the "Owners Online" section
- the telephone application (e.g. iPhone®, Blackberry)

To do this, you will need your identification number and password.

- **i** The vehicle remote closing feature is available when the relevant mobile phone network is available and data connection is possible.

Stolen vehicle recovery service

If your vehicle has been stolen:

- ▶ Notify the police.
The police will issue a numbered incident report.
 - ▶ This number will be forwarded to the Mercedes-Benz Customer Assistance Center together with your PIN.
The Mercedes-Benz Customer Assistance Center then attempts to locate the mbrace system. The Mercedes-Benz Customer Assistance Center contacts you and the local law enforcement agency if the vehicle is located. However, only the law enforcement agency is informed of the location of the vehicle.
- i** If the anti-theft alarm system is activated for longer than 30 seconds, the Mercedes-Benz Customer Assistance center is automatically informed.

Vehicle remote malfunction diagnosis

With the vehicle remote malfunction diagnosis (Vehicle Health Check), the Customer Assistance center can provide improved support for problems with your vehicle. During an existing call, vehicle data is transferred to the Customer Assistance center. The customer service representative can use the received data to decide what kind of assistance is required. You are then, for example, guided to the nearest Mercedes-Benz Service center or a recovery vehicle is called.

If vehicle data needs to be transferred during an MB Info call or a Roadside Assistance call, this is initiated by the Customer Assistance center. You will see the **Roadside Assistance Connected** message in the COMAND display. If the vehicle remote malfunction diagnosis is able to be started, the **Request for vehicle diagnosis received. Start vehicle diagnosis?** message appears in the display.

- ▶ Press **Yes** to confirm the message.
- ▶ If the **Vehicle Diagnosis: Please switch on ignition.** message appears: turn the key to position **2** in the ignition lock.
- ▶ If the **Please follow the instructions received by phone and move your vehicle to a safe position.** message appears: follow the instructions of the customer service representative.
The message in the display disappears.
If you select **Cancel**, the vehicle remote malfunction diagnosis is canceled completely.
The vehicle operating state check begins. Meanwhile, the **Vehicle diagnosis activated** message appears.

When the check is finished, the **Sending vehicle diagnosis data...(Voice connection may be interrupted during data transfer.)** message appears. The vehicle data can now be sent to the Customer Assistance center.

- ▶ Press **OK** to confirm the message.
The voice connection with the Customer Assistance center is terminated.
The **Vehicle Diagnosis: Transferring data...** appears.
The vehicle data is sent to the Customer Assistance center.

Depending on what the customer service representative agreed with you, the voice connection is re-established after the transfer is complete. If necessary, you will be contacted at a later time by another means, e.g. by E-Mail or telephone.

Further functions of the vehicle remote malfunction diagnosis include, for example:

- transfer of service data to the Customer Assistance center. If a service is overdue, the COMAND display shows a message

about various special offers at your workshop.

- monthly status information E-Mail on oil level, air pressure, maintenance, brakes, etc. If applicable, you will receive information on special offers in the E-Mail. USA only: this information can also be called up under "Owners Online" at <http://www.mbUSA.com>.

Information on the data stored in the vehicle (▷ page 28).

Information on roadside assistance (▷ page 25).

Downloading routes

Downloading routes allows you to transfer and save predefined routes in the navigation system. To do this, an SD memory card must be inserted into the COMAND system. If no SD memory card is inserted, you must insert the card into the card slot on the COMAND system before saving.

A route can be prepared and sent either by a customer service representative or via the mbrace portal on the Internet. Each route can include up to 20 way points. When a route has been received by the navigation system, the **'Route name' has been saved to memory card. Do you want to start route guidance?** message appears on the COMAND display. The route is saved to the SD memory card.

- ▶ **To start route guidance:** select **Yes**.

An overview of the route is shown in the display.

- ❗ If you select **No**, the saved route can be called up later in the navigation menu.
- ▶ Select **Start**.
Route guidance is started.
- ❗ Downloaded and saved data can be called up again in COMAND.
You can find further information in the separate COMAND operating instructions.

Speed alert

You can define the upper speed limit, which must not be exceeded by the vehicle. If this selected speed is exceeded by the vehicle, a message will be sent to the Customer Assistance center. The Customer Assistance center then forwards this information to you. You can select the way in which you receive this information beforehand. Possible options include SMS, E-Mail or an automated call.

The data which is sent to the Customer Assistance center contains the following information:

- the location where the speed limit was exceeded
- the time at which the speed limit was exceeded
- the selected speed limit which was exceeded

Geo fencing

Geo fencing allows you to select areas which the vehicle should not enter or leave. You will be informed if the vehicle crosses the boundaries of the selected areas. You can select the way in which you receive this information beforehand. Possible options include SMS, E-Mail or an automated call. The area can be determined as either a circle or a polygon with a maximum of ten corners. You can specify up to ten areas simultaneously. Different settings are possible for each area.

USA only: these settings can be called up under "Owners Online" at <http://www.mbUSA.com>.

Alternatively, you can trigger an MB Info call and inform the customer service representative that you wish to activate geo fencing.

Currently inactive areas can be activated by SMS.

Triggering the vehicle alarm

With this function, you can trigger the vehicle's panic alarm via SMS. An alarm sounds and the exterior lighting flashes. Depending on the setting, the panic alarm lasts five or ten seconds. Afterwards, the alarm switches off.

Garage door opener

Important safety notes

WARNING

When you operate or program the garage door with the integrated garage door opener, persons in the range of movement of the garage door can become trapped or struck by the garage door. There is a risk of injury.

When using the integrated garage door opener, always make sure that nobody is within the range of movement of the garage door.

WARNING

Combustion engines emit poisonous exhaust gases such as carbon monoxide. Inhaling these exhaust gases leads to poisoning. There is a risk of fatal injury. Therefore never leave the engine running in enclosed spaces without sufficient ventilation.

The HomeLink® garage door opener integrated in the rear-view mirror allows you to operate up to three different door and gate systems.

Only operate garage doors using the integrated garage door opener if:

- they are equipped with a safety stop and reverse feature, and
- they conform to the current U.S. safety standards.

When programming a garage door opener, park vehicle outside the garage.

-  Certain garage door drives are incompatible with the integrated garage

door opener. If you have difficulty programming the integrated garage door opener, contact an authorized Mercedes-Benz Center.

Alternatively, you can call the following telephone assistance services:

- **USA:** Mercedes-Benz Customer Assistance Center at 1-800-FOR-MERCEdes
- **Canada:** Customer Service at 1-800-387-0100
- HomeLink® hotline 1-800-355-3515 (free of charge)

More information on HomeLink® and/or compatible products is also available online at <http://www.homelink.com>.

-  Notes on the declaration of conformity (▷ page 27).

Programming

Programming buttons

Observe the "Important safety notes" (▷ page 359).



Integrated garage door opener in the rear-view mirror

Garage door remote control  is not part of the integrated garage door opener.

- ▶ The first time before programming, clear the integrated garage door opener memory (▷ page 361).
- ▶ Turn the SmartKey to position **2** in the ignition lock.

- ▶ Press and hold one of buttons ② to ④ on the integrated garage door opener. After a short time, indicator lamp ① lights up yellow.
 - ❗ Indicator lamp ① lights up yellow as soon as button ②, ③ or ④ is programmed for the first time. If the selected button has already been programmed, indicator lamp ① will only light up yellow after ten seconds have elapsed.
- ▶ Release button ②, ③ or ④. Indicator lamp ① flashes yellow.
- ▶ Point garage door remote control ⑤ towards buttons ② to ④ on the rear-view mirror at a distance of 2 to 8 inches (5 to 20 cm).
 - ❗ The required distance between remote control ⑤ and the integrated garage door opener depends on the garage door drive system. Several attempts might be necessary. You should test every position for at least 25 seconds before trying another position.
- ▶ Press and hold button ⑥ on remote control ⑤ until indicator lamp ① lights up green. If indicator lamp ① lights up green or flashes, then programming has been successful.
- ▶ Release button ⑥ on remote control ⑤ for the garage door drive system.
- ▶ If indicator lamp ① lights up red: repeat the programming procedure for the corresponding button on the rear-view mirror. When doing so, vary the distance between remote control ⑤ and the rear-view mirror.
 - ❗ If the indicator lamp flashes green after successful programming, the garage door system is using a rolling code. After programming, you must synchronize the garage door opener integrated in the rear-view mirror with the receiver of the garage door system.

Synchronizing the rolling code

Observe the "Important safety notes" (> page 359).

Your vehicle must be within reach of the garage door or exterior gate drive. Make sure that neither your vehicle nor any persons/objects are present within the sweep of the door or gate.

- ▶ Turn the SmartKey to position **2** in the ignition lock.
- ▶ Press the program button of the door or gate drive (see the door or gate drive operating instructions, e.g. under "programming of additional remote controls").
 - ❗ Usually, you now have 30seconds to initiate the next step.
- ▶ Press previously programmed button ②, ③ or ④ of the integrated garage door opener until the door closes. The rolling code synchronization is then complete.

Notes on programming the remote control

Canadian radio frequency laws require a "break" (or interruption) of the transmission signals after broadcasting for a few seconds. Therefore, these signals may not last long enough for the integrated garage door opener. The signal is not recognized during programming. Comparable with Canadian law, some U.S. garage door openers also feature a "break".

Proceed as follows:

- if you live in Canada
- if you have difficulties programming the garage door opener (regardless of where you live) when using the programming steps

- ▶ Press and hold one of buttons ② to ④ on the integrated garage door opener. After a short time, indicator lamp ① lights up yellow.
- ▶ Release the button. Indicator lamp ① flashes yellow.
- ▶ Press button ⑥ of garage door remote control ⑤ for two seconds, then release it for two seconds.
- ▶ Press button ⑥ again for two seconds.
- ▶ Repeat this sequence on button ⑥ of remote control ⑤ until indicator lamp ① lights up green. If indicator lamp ① turns red, repeat the process.
- ▶ Continue with the other programming steps (see above).

Problems when programming

If you are experiencing problems programming the integrated garage door opener on the rear-view mirror, take note of the following instructions:

- Check the transmitter frequency of garage door drive remote control ⑤. This can usually be found on the back of the remote control. The integrated garage door opener is compatible with devices that have units which operate in the frequency range of 280to 433MHz.
- Replace the batteries in garage door remote control ⑤. This increases the likelihood that garage door remote control ⑤ will transmit a strong and precise signal to the integrated garage door opener in the rear-view mirror.
- When programming, hold remote control ⑤ at varying distances and angles from the button that you are programming. Try various angles at a distance between 2and 12 inches (5to 30 cm) or at the same angle but at varying distances.
- If another remote control for the same garage door drive is available, repeat the

same programming steps with this remote control. Before performing these steps, make sure that new batteries have been installed in garage door drive remote control ⑤.

- Note that some remote controls only transmit for a limited amount of time (the indicator lamp on the remote control goes out). Press button ⑥ on remote control ⑤ again before transmission ends.
- Align the antenna cable of the garage door opener unit. This can improve signal reception/transmission.

Opening/closing the garage door

After it has been programmed, the integrated garage door opener performs the function of the garage door system remote control. Please also read the operating instructions for the garage door system.

- ▶ Turn the SmartKey to position **2** in the ignition lock.
- ▶ Press button ②, ③ or ④ which you have programmed to operate the garage door. Garage door system with a fixed code: indicator lamp ① lights up green. Garage door system with a rolling code: indicator lamp ① flashes green.

- i** The transmitter will transmit a signal as long as the button is pressed. The transmission is halted after a maximum of ten seconds and indicator lamp ① lights up yellow. Press button ②, ③ or ④ again if necessary.

Clearing the memory

- ▶ Turn the SmartKey to position **2** in the ignition lock.
- ▶ Press buttons ② and ④. The indicator lamp lights up yellow.
- ▶ Press and hold buttons ② and ④ until the indicator lamp turns green.

- ▶ **i** Make sure that you clear the memory of the integrated garage door opener before selling the vehicle.

- ▶ **To remove:** pull the floormat from retainers ②.
- ▶ Remove the floormat.

Compass

Calling up the compass

Information on operating the compass can be found in the separate COMAND Operating Instructions.

Floormats

⚠ WARNING

Objects in the driver's footwell can restrict the pedal travel or obstruct a depressed pedal.

The operating and road safety of the vehicle is jeopardized. There is a risk of an accident.

Make sure that all objects in the vehicle are stowed correctly, and that they cannot enter the driver's footwell. Install the floormats securely and as specified in order to ensure sufficient clearance for the pedals. Do not use loose floormats.

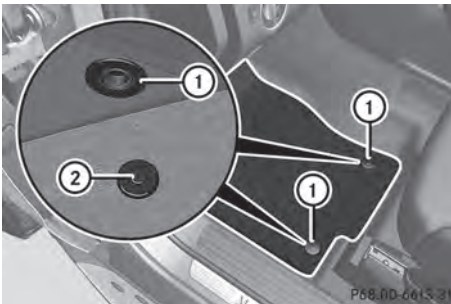

Floormat on the driver's side (example)

- ▶ **Driver's seat/front-passenger seat:** slide the respective seat back.
- ▶ **Rear seats:** slide the respective seat forwards.
- ▶ **To install:** place the floormat in the footwell.
- ▶ Press studs ① onto retainers ②.

Infrared reflective windshield

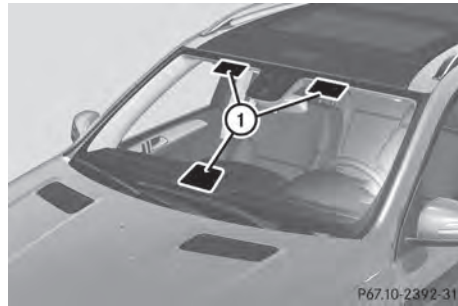

The infrared reflecting glass prevents the vehicle interior from becoming too hot. It also blocks radio waves up into the gigahertz range.

To enable operation of radio-controlled equipment, e.g. toll recording systems, areas on the windshield are permeable to radio waves ①. In these areas, you can install radio-controlled systems.

These areas can best be seen from outside the vehicle by observing the light reflected off the windshield.

| | |
|--------------------------|-----|
| Useful information | 364 |
| Engine compartment | 364 |
| Maintenance | 368 |
| Care | 369 |

Useful information

- i** This Operator's Manual describes all models and all standard and optional equipment of your vehicle available at the time of publication of the Operator's Manual. Country-specific differences are possible. Please note that your vehicle may not be equipped with all features described. This also applies to safety-related systems and functions.
- i** Read the information on qualified specialist workshops: (▷ page 27).

Engine compartment

Hood

Important safety notes

WARNING

If the hood is unlatched, it may open up when the vehicle is in motion and block your view. There is a risk of an accident.
Never unlatch the hood while driving.

WARNING

When opening and closing the hood, it may suddenly fall into the closed position. There is a risk of injury to persons within range of movement of the hood.
Open and close the hood only when no one is within its range of movement.

WARNING

Certain components in the engine compartment, such as the engine, radiator and parts of the exhaust system, can become very hot. Working in the engine compartment poses a risk of injury.
Where possible, let the engine cool down and touch only the components described in the following.

WARNING

Opening the hood when the engine is overheated or when there is a fire in the engine compartment could expose you to hot gases or other service products. There is a risk of injury.

Let an overheated engine cool down before opening the hood. If there is a fire in the engine compartment, keep the hood closed and contact the fire department.

WARNING

The engine compartment contains moving components. Certain components, such as the radiator fan, may continue to run or start again suddenly when the ignition is off. There is a risk of injury.

If you need to do any work inside the engine compartment,

- switch off the ignition
- never reach into the area where there is a risk of danger from moving components, such as the fan rotation area
- keep clothing away from moving parts

WARNING

The ignition system and the fuel injection system work under high voltage. If you touch components which are under voltage, you could get an electric shock. There is a risk of injury.

Never touch components of the ignition system or fuel injection system when the ignition is switched on.

Opening the hood

WARNING

When the hood is open and the windshield wipers are set in motion, you can be injured by the wiper linkage. There is a risk of injury.
Always switch off the windshield wipers and the ignition before opening the hood.

! Make sure that the windshield wipers are not folded away from the windshield. You could otherwise damage the windshield wipers or the hood.

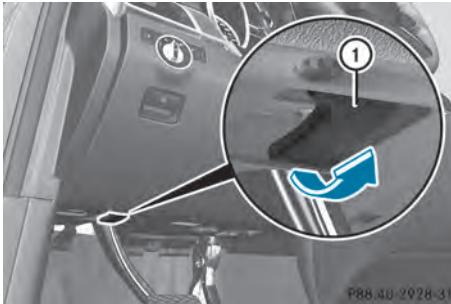

- ▶ Make sure that the windshield wipers are turned off.
- ▶ Pull release lever ① on the hood. The hood is released.

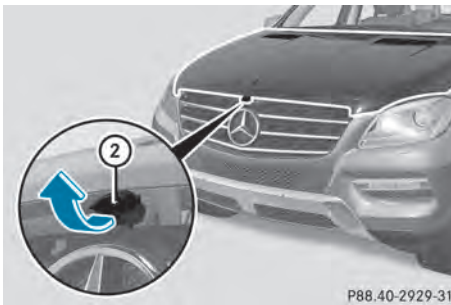

- ▶ Reach into the gap, pull hood catch handle ② up and lift the hood. If you lift the hood approximately 15 inches (40cm) the hood is opened and held open automatically by the gas-filled struts.

Closing the hood

- ▶ Lower the hood and let it fall from a height of approximately 8 in (20 cm).
- ▶ Check that the hood has engaged properly. If the hood can be raised slightly, it is not properly engaged. Open it again and close it with a little more force.

Radiator

Vehicles with a diesel engine: do not cover the radiator, for example with a winter front or bug cover. The readings of the on-board-diagnostic system may otherwise be inaccurate. Some of these readings are required by law and must be accurate at all times.

Engine oil

General notes

Depending on the driving style, the vehicle consumes up to 0.9 US qts (0.8 l) of oil over a distance of 600 miles (1000 km). The oil consumption may be higher than this when the vehicle is new or if you frequently drive at high engine speeds.

Depending on the engine, the oil dipstick may be in a different location.

When checking the oil level:

- park the vehicle on a level surface.
- the engine should be switched off for approximately five minutes if the engine is at normal operating temperature.
- if the engine is not at normal operating temperature, e.g. if the engine was only started briefly: wait about 30 minutes before carrying out the measurement.

Checking the oil level using the oil dipstick

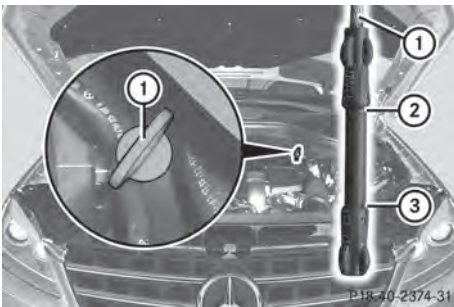

Example: vehicles with a gasoline engine

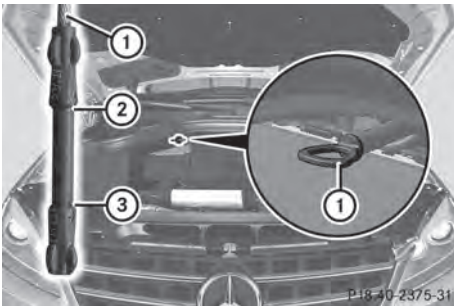

Example: vehicles with a diesel engine

- ▶ Pull oil dipstick ① out of the dipstick guide tube.
- ▶ Wipe off oil dipstick ①.
- ▶ Slowly slide oil dipstick ① into the guide tube to the stop, and take it out again. If the level is between MIN mark ③ and MAX mark ②, the oil level is correct.
- ▶ If the oil level has dropped to MIN mark ③ or below, add 1.1 US qt (1.0 liter) of engine oil.

Adding engine oil

WARNING

If engine oil comes into contact with hot components in the engine compartment, it may ignite. There is a risk of fire and injury. Make sure that engine oil is not spilled next to the filler neck. Let the engine cool down

and thoroughly clean the engine oil off the components before starting the engine.

Environmental note

When adding oil, take care not to spill any. If oil enters the soil or waterways, it is harmful to the environment.

- ❗ Only use engine oils and oil filters that have been approved for vehicles with a service system. You can obtain a list of the engine oils and oil filters tested and approved in accordance with the Mercedes-Benz Specifications for Service Products at any Mercedes-Benz Service center.

Damage to the engine or exhaust system is caused by the following:

- using engine oils and oil filters that have not been specifically approved for the service system
- replacing engine oil and oil filters after the interval for replacement specified by the service system has been exceeded
- using engine oil additives.

- ❗ Do not add too much oil. adding too much engine oil can result in damage to the engine or to the catalytic converter. Have excess engine oil siphoned off.



Example: engine oil cap

- ▶ Turn cap ① counter-clockwise and remove it.
- ▶ Add engine oil.
If the oil level is at or below the MIN mark on the oil dipstick, add 1.1 US qt (1.0 liter) of engine oil.
- ▶ Replace cap ① on the filler neck and turn clockwise.
Ensure that the cap locks into place securely.
- ▶ Check the oil level again with the oil dipstick (▷ page 366).

Further information on engine oil (▷ page 449).

Additional service products

Checking coolant level

WARNING

The engine cooling system is pressurized, particularly when the engine is warm. When opening the cap, you could be scalded by hot coolant spraying out. There is a risk of injury. Let the engine cool down before opening the cap. Wear eye and hand protection when opening the cap. Open the cap slowly half a turn to allow pressure to escape.

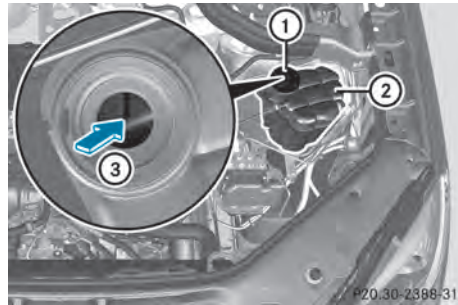

- ▶ Park the vehicle on a level surface.
Only check the coolant level when the vehicle is on a level surface and the engine has cooled down.
- ▶ Turn the SmartKey to position 2 in the ignition lock (▷ page 157).
On vehicles with KEYLESS-GO, press the Start/Stop button twice (▷ page 158).
- ▶ Check the coolant temperature gauge in the multifunction display.
The coolant temperature must be below 158 °F (70 °C).
- ▶ Turn the SmartKey to position 0 (▷ page 157) in the ignition lock.
- ▶ Slowly turn cap ① half a turn counter-clockwise to allow excess pressure to escape.
- ▶ Turn cap ① further counter-clockwise and remove it.
If the coolant is at the level of marker bar ③ in the filler neck when cold, there is enough coolant in coolant expansion tank ②.
If the coolant level is approximately 0.6 in (1.5 cm) above marker bar ③ in the fuel filler neck when warm, there is enough coolant in expansion tank ②.
- ▶ If necessary, add coolant that has been tested and approved by Mercedes-Benz.
- ▶ Replace cap ① and turn it clockwise as far as it will go.

For further information on coolant, see (▷ page 451).

Adding washer fluid to the windshield washer system/headlamp cleaning system

WARNING

Windshield washer concentrate is highly flammable. If it comes into contact with hot engine components or the exhaust system it could ignite. There is a risk of fire and injury.

Make sure that no windshield washer concentrate is spilled next to the filler neck.

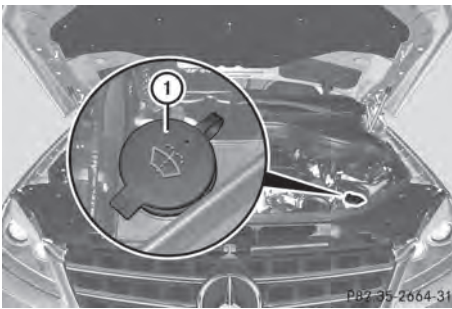

Example: washer fluid reservoir

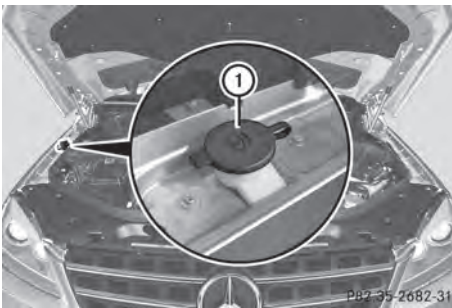

Example: washer fluid reservoir in AMG vehicles

- ▶ **To open:** pull cap ① upwards by the tab.
- ▶ Add the premixed washer fluid.
- ▶ **To close:** press cap ① onto the filler neck until it engages.

The washer fluid reservoir is used for both the windshield washer system and the headlamp cleaning system.

Further information on windshield washer fluid/antifreeze (▷ page 452).

Maintenance

ASSYST PLUS

Service message

The ASSYST PLUS service interval display informs you of the next service due date.

Information on the type of service and service intervals (see the separate Maintenance Booklet).

You can obtain further information from an authorized Mercedes-Benz Center or at <http://www.mbusa.com> (USA only).

- i** The ASSYST PLUS service interval display does not show any information on the engine oil level. Observe the notes on the engine oil level (▷ page 365).

The multifunction display shows a service message for several seconds, e.g.:

- Next Service A in .. Days
- Service A Due
- Service A Exceeded by ... Days

Depending on the operating conditions of the vehicle, the remaining time or distance until the next service due date is displayed.

The letter **A** or **B**, possibly in connection with a number or another letter, shows the type of service. **A** stands for a minor service and **B** for a major service.

You can obtain further information from an authorized Mercedes-Benz Center.

The ASSYST PLUS service interval display does not take into account any periods of time during which the battery is disconnected.



Maintaining the time-dependent service schedule:

- ▶ Note down the service due date displayed in the multifunction display before disconnecting the battery.





or

- ▶ After reconnecting the battery, subtract the battery disconnection periods from the service date shown on the display.

Hiding a service message

- ▶ Press the  or  button on the steering wheel.

Displaying service messages

- ▶ Switch on the ignition.
- ▶ Press the  or  button on the steering wheel to select the **Serv.** menu.
- ▶ Press the  or  button to select the **ASSYST PLUS** submenu and confirm by pressing the  button.
The service due date appears in the multifunction display.

Information about Service

Resetting the ASSYST PLUS service interval display

- ❗ If the ASSYST PLUS service interval display has been inadvertently reset, this setting can be corrected at a qualified specialist workshop.

Have service work carried out as described in the Maintenance Booklet. This may otherwise lead to increased wear and damage to the major assemblies or the vehicle.

A qualified specialist workshop, e.g. an authorized Mercedes-Benz Center, will reset the ASSYST PLUS service interval display after the service work has been carried out. You can also obtain further information on maintenance work, for example.

Special service requirements

The specified maintenance interval takes only the normal operation of the vehicle into account. Under arduous operating conditions or increased load on the vehicle, maintenance work must be carried out more frequently, for example:

- regular city driving with frequent intermediate stops
- if the vehicle is primarily used to travel short distances

- use in mountainous terrain or on poor road surfaces
- if the engine is often left idling for long periods

Under these or similar conditions, have, for example, the air filter, engine oil and oil filter replaced or changed more frequently. Under arduous operating conditions, the tires must be checked more often. Further information can be obtained at a qualified specialist workshop, e.g. an authorized Mercedes-Benz Center.

Driving abroad

An extensive Mercedes-Benz Service network is also available in other countries. You can obtain further information from any authorized Mercedes-Benz Center.

Care

General notes

Environmental note

Dispose of empty packaging and cleaning cloths in an environmentally responsible manner.

- ❗ For cleaning your vehicle, do not use any of the following:

- dry, rough or hard cloths
- abrasive cleaning agents
- solvents
- cleaning agents containing solvents

Do not scrub.

Do not touch the surfaces or protective films with hard objects, e.g. a ring or ice scraper. You could otherwise scratch or damage the surfaces and protective film.

- ❗ Do not park the vehicle for an extended period straight after cleaning it, particularly after having cleaned the wheels with wheel cleaner. Wheel cleaners could cause increased corrosion of the brake discs and brake pads/linings. For this reason, you

should drive for a few minutes after cleaning. Braking heats the brake discs and the brake pads/linings, thus drying them. The vehicle can then be parked.

Regular care of your vehicle is a condition for retaining the quality in the long term.

Use care products and cleaning agents recommended and approved by Mercedes-Benz.

Washing the vehicle and cleaning the paintwork

Automatic car wash

WARNING

Braking efficiency is reduced after washing the vehicle. There is a risk of an accident.

After the vehicle has been washed, brake carefully while paying attention to the traffic conditions until full braking power is restored.

! If DISTRONIC PLUS or the HOLD function is activated, the vehicle brakes automatically in certain situations. To prevent damage to the vehicle, deactivate DISTRONIC PLUS and the HOLD function in the following or other similar situations:

- when towing the vehicle
- in the car wash

! Never clean your vehicle in a Touchless Automatic Car Wash as these use special cleaning agents. These cleaning agents can damage the paintwork or plastic parts.

! Make sure that:

- the side windows and the sliding sunroof are fully closed.
- the ventilation/heating is switched off (the OFF button has been pressed).
- the windshield wiper switch is in position **0**.

Otherwise, the vehicle might be damaged.

! In car washes with a towing mechanism, make sure that the automatic transmission

is in transmission position **N**, otherwise the vehicle could be damaged.

- Vehicles with a SmartKey:

Do not remove the SmartKey from the ignition lock. Do not open the driver's door or front-passenger door when the engine is switched off. Otherwise, the automatic transmission selects park position **P** automatically and locks the wheels. You can prevent this by shifting the automatic transmission to **N** beforehand.

- Vehicles with KEYLESS-GO:

Do not open the driver's door or front-passenger door when the engine is switched off. Otherwise, the automatic transmission selects park position **P** automatically and locks the wheels.

Observe the following to make sure that the automatic transmission stays in position **N**:

- ▶ Make sure the vehicle is stationary and the ignition is switched off.
- ▶ Turn the SmartKey to position **2** (▷ page 157) in the ignition lock. Use the SmartKey instead of the Start/Stop button on vehicles with KEYLESS-GO.
- ▶ Depress and hold the brake pedal.
- ▶ Shift the automatic transmission to position **N**.
- ▶ Release the brake pedal.
- ▶ Release the electric parking brake.
- ▶ Switch off the ignition and leave the SmartKey in the ignition lock.

You can wash the vehicle in an automatic car wash from the very start.

If the vehicle is very dirty, pre-wash it before cleaning it in an automatic car wash.

After using an automatic car wash, wipe off wax from the windshield and the wiper blades. This will prevent smears and reduce wiping noises caused by residue on the windshield.

Washing by hand

In some countries, washing by hand is only allowed at specially equipped washing bays. Observe the legal requirements in all countries concerned.

- ▶ Do not use hot water and do not wash the vehicle in direct sunlight.
- ▶ Use a soft sponge to clean.
- ▶ Use a mild cleaning agent, such as a car shampoo approved by Mercedes-Benz.
- ▶ Thoroughly hose down the vehicle with a gentle jet of water.
- ▶ Do not point the water jet directly towards the air inlets.
- ▶ Use plenty of water and rinse out the sponge frequently.
- ▶ Rinse the vehicle with clean water and dry thoroughly with a chamois.
- ▶ Do not let the cleaning agent dry on the paintwork.

When using the vehicle in winter, remove all traces of road salt deposits carefully and as soon as possible.

Power washers

WARNING

The water jet from a circular jet nozzle (dirt blasters) can cause invisible exterior damage to the tires or chassis components. Components damaged in this way may fail unexpectedly. There is a risk of an accident. Do not use power washers with circular jet nozzles to clean the vehicle. Have damaged tires or chassis components replaced immediately.

- ❗ Always maintain a distance of at least 11.8 in (30 cm) between the vehicle and the power washer nozzle. Information about the correct distance is available from the equipment manufacturer. Move the power washer nozzle around when cleaning your vehicle.

Do not aim directly at any of the following:

- tires
- door gaps, roof gaps, joints, etc.
- electrical components
- battery
- connectors
- lights
- seals
- trim
- ventilation slots

Damaged seals or electrical components can lead to leaks or failures.

Cleaning the paintwork

❗ Do not affix:

- stickers
- films
- magnetic plates or similar items

to painted surfaces. You could otherwise damage the paintwork.

Scratches, corrosive deposits, areas affected by corrosion and damage caused by inadequate care cannot always be completely repaired. In such cases, visit a qualified specialist workshop.

- ▶ Remove dirt immediately, where possible, while avoiding rubbing too hard.
- ▶ Soak insect remains with insect remover and rinse off the treated areas afterwards.
- ▶ Soak bird droppings with water and rinse off the treated areas afterwards.
- ▶ Remove coolant, brake fluid, tree resin, oils, fuels and greases by rubbing gently with a cloth soaked in petroleum ether or lighter fluid.
- ▶ Use tar remover to remove tar stains.
- ▶ Use silicone remover to remove wax.

If water no longer forms "beads" on the paint surface, use the paint care products recommended and approved by Mercedes-Benz. This is the case approximately every

three to five months, depending on the climate conditions and the care product used. If dirt has penetrated the paint surface or if the paint has become dull, the paint cleaner recommended and approved by Mercedes-Benz should be used.

Do not use these care products in the sun or on the hood while the hood is hot.

- ▶ Use a suitable touch-up stick, e.g. MB Touch-Up Stick, to repair slight damage to the paintwork quickly and provisionally.

Matte finish care

❗ Never polish the vehicle or the light alloy wheels. Polishing causes the finish to shine.

❗ The following may cause the paint to become shiny and thus reduce the matte effect:

- Vigorous rubbing with unsuitable materials.
- Frequent use of car washes.
- Washing the vehicle in direct sunlight.

❗ Never use paint cleaner, buffing or polishing products, or gloss preserver, e.g. wax. These products are only suitable for high-gloss surfaces. Their use on vehicles with matte finish leads to considerable surface damage (shiny, spotted areas).

Always have paintwork repairs performed at a qualified specialist workshop, e.g. an authorized Mercedes-Benz Center.

❗ Do not use wash programs with a hot wax treatment under any circumstances.

Observe these notes if your vehicle has a clear matte finish. This will help you to avoid damage to the paintwork due to incorrect treatment.

These notes also apply to light alloy wheels with a clear matte finish.

- ❗ The vehicle should preferably be washed by hand using a soft sponge, car shampoo and plenty of water.

- ❗ Use only insect remover and car shampoo from the range of recommended and approved Mercedes-Benz care products.

Cleaning the vehicle parts

Cleaning the wheels

- ❗ Do not use acidic wheel cleaning products to remove brake dust. This could damage wheel bolts and brake components.
- ❗ Do not park the vehicle for an extended period straight after cleaning it, particularly after having cleaned the wheels with wheel cleaner. Wheel cleaners could cause increased corrosion of the brake discs and brake pads/linings. For this reason, you should drive for a few minutes after cleaning. Braking heats the brake discs and the brake pads/linings, thus drying them. The vehicle can then be parked.

Cleaning the windows

WARNING

You could become trapped by the windshield wipers if they start moving while cleaning the windshield or wiper blades. There is a risk of injury.

Always switch off the windshield wipers and the ignition before cleaning the windshield or wiper blades.

- ❗ Do not use dry cloths, abrasive products, solvents or cleaning agents containing solvents to clean the inside of the windows. Do not touch the insides of the windows with hard objects, e.g. an ice scraper or ring. There is otherwise a risk of damaging the windows.
- ❗ Clean the water drainage channels of the windshield and the rear window at regular intervals. Deposits such as leaves, petals and pollen may under certain circumstances prevent water from draining

away. This can lead to corrosion damage and damage to electronic components.

- ▶ Clean the inside and outside of the windows with a damp cloth and a cleaning product that is recommended and approved by Mercedes-Benz.

Cleaning wiper blades

WARNING

You could become trapped by the windshield wipers if they start moving while cleaning the windshield or wiper blades. There is a risk of injury.

Always switch off the windshield wipers and the ignition before cleaning the windshield or wiper blades.

- ❗ Do not pull the wiper blade. Otherwise, the wiper blade could be damaged.
- ❗ Do not clean wiper blades too often and do not rub them too hard. Otherwise, the graphite coating could be damaged. This could cause wiper noise.
- ❗ Hold the wiper arm securely when folding back. The windshield could be damaged if the wiper arm smacks against it suddenly.
- ▶ Fold the windshield wiper arms away from the windshield.
- ▶ Carefully clean the wiper blades with a damp cloth.
- ▶ Fold the windshield wiper arms back again before switching on the ignition.

Cleaning the exterior lighting

- ❗ Only use cleaning agents or cleaning cloths which are suitable for plastic light lenses. Unsuitable cleaning agents or cleaning cloths could scratch or damage the plastic light lenses.
- ▶ Clean the plastic lenses of the exterior lighting using a wet sponge and a mild cleaning agent, e.g. Mercedes-Benz car shampoo or cleaning cloths.

Mirror turn signals

- ❗ Only use cleaning agents or cleaning cloths that are suitable for plastic lenses. Unsuitable cleaning agents or cleaning cloths could scratch or damage the plastic lenses of the mirror turn signals.
- ▶ Clean the plastic lenses of the mirror turn signals in the exterior mirror housing using a wet sponge and mild cleaning agent, e.g. Mercedes-Benz car shampoo or cleaning cloths.

Cleaning the sensors

- ❗ If you clean the sensors with a power washer, make sure that you keep a distance of at least 11.8 in (30 cm) between the vehicle and the power washer nozzle. Information about the correct distance is available from the equipment manufacturer.

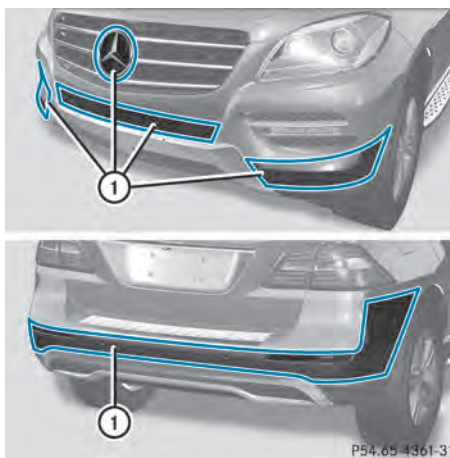

- ▶ Clean sensors ① of the driving systems with water, car shampoo and a soft cloth.

Cleaning the rear view camera

- ❗ Do not clean the camera lens and the area around the rear view camera with a power washer.



- ▶ Use clear water and a soft cloth to clean camera lens ①.

Cleaning the exhaust pipe

- ❗ Do not clean the exhaust pipe with acid-based cleaning agents such as sanitary cleansers or wheel cleaners.

Impurities combined with the effects of road grit and corrosive environmental factors may cause flash rust to form on the surface. You can restore the original shine of the exhaust pipe by cleaning it regularly, especially in winter and after washing.

- ▶ Clean the exhaust pipe with a chrome care product tested and approved by Mercedes-Benz.

Cleaning the trailer tow hitch

🌿 Environmental note

Dispose of rags soaked in oil and grease in an environmentally responsible manner.

- ❗ Do not clean the ball coupling with a power washer. Do not use solvents.
- ❗ Observe the note on care provided by the trailer manufacturer.



The ball coupling must be cleaned if it becomes dirty or corroded.

- ▶ Remove rust on the ball of the ball coupling, e.g. with a wire brush.
- ▶ Remove dirt with a clean, lint-free cloth or a brush.
- ▶ After cleaning, lightly oil or grease ball coupling ①.
- ▶ Check that the vehicle's trailer tow hitch is working properly.

- 📘 You can also have the maintenance work on the ball coupling and the trailer tow hitch carried out by a qualified specialist workshop.

Interior care

Cleaning the display

- ❗ For cleaning, do not use any of the following:

- alcohol-based thinner or gasoline
- abrasive cleaning agents
- commercially-available household cleaning agents

These may damage the display surface. Do not put pressure on the display surface when cleaning. This could lead to irreparable damage to the display.

- ▶ Before cleaning the display, make sure that it is switched off and has cooled down.
- ▶ Clean the display surface using a commercially available microfiber cloth and TFT/LCD display cleaner.
- ▶ Dry the display surface using a dry microfiber cloth.

Cleaning Night View Assist Plus

WARNING

Always remember that your primary responsibility is to drive the vehicle. The driver must always concentrate on the road. For your safety and the safety of others, stop the vehicle before trying to clean fogged-up windows or to clean the window in front of the Night View Assist Plus camera.

Bear in mind that at a speed of only 30 mph (approximately 50 km/h), the vehicle covers a distance of 44 feet (approximately 14 m) per second.

- ❗ Never clean the camera lens. When cleaning the field of vision of the driving systems, make sure that you do not spray glass cleaner on the camera lens. If the camera lens is dirty, visit a qualified specialist workshop.

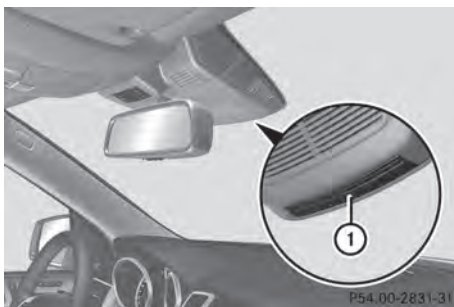

- ▶ Fold down the camera cover by recess ①.

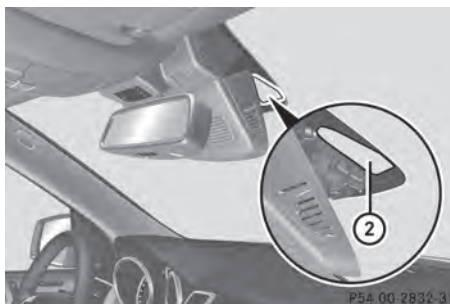

- ▶ Use a soft cloth to clean the windshield in front of camera ②.

Cleaning the plastic trim

WARNING

Care products and cleaning agents containing solvents cause surfaces in the cockpit to become porous. As a result, plastic parts may come loose in the event of air bag deployment. There is a risk of injury.

Do not use any care products and cleaning agents to clean the cockpit.

- ❗ Do not affix the following to plastic surfaces:

- stickers
- films
- scented oil bottles or similar items

You can otherwise damage the plastic.

- ❗ Do not allow cosmetics, insect repellent or sunscreen to come into contact with the plastic trim. This maintains the high-quality look of the surfaces.

- ▶ Wipe the plastic trim with a damp, lint-free cloth, e.g. a microfiber cloth.

- ▶ **Heavy soiling:** use care and cleaning products recommended and approved by Mercedes-Benz.

The surface may change color temporarily. Wait until the surface is dry again.

Cleaning the steering wheel and gear or selector lever

- ▶ Thoroughly wipe with a damp cloth or use leather care agents that have been recommended and approved by Mercedes-Benz.

Cleaning genuine wood and trim elements

❗ Do not use solvent-based cleaning agents such as tar remover, wheel cleaners, polishes or waxes. There is otherwise a risk of damaging the surface.

❗ Do not use chrome polish on trim pieces. The trim pieces have a chrome look but are mostly made of anodized aluminum and can lose their shine if chrome polish is used. Use a damp, lint-free cloth instead when cleaning the trim pieces.

If the chrome-plated trim pieces are very dirty, you can use a chrome polish. If you are unsure as to whether the trim pieces are chrome-plated or not, consult an authorized Mercedes-Benz Center.

- ▶ Wipe the wooden trim and trim pieces with a damp, lint-free cloth, e.g. a microfiber cloth.
- ▶ **Heavy soiling:** use car care and cleaning products recommended and approved by Mercedes-Benz.

Cleaning the seat covers

General notes

❗ Do not use microfiber cloths to clean genuine leather, artificial leather or Alcantara® covers. If used often, these can damage the cover.

i Note that regular care is essential to ensure that the appearance and comfort of the covers is retained over time.

Genuine leather seat covers

❗ To retain the natural appearance of the leather, observe the following cleaning instructions:

- Clean genuine leather covers carefully with a damp cloth and then wipe the covers down with a dry cloth.
- Make sure that the leather does not become soaked. It may otherwise become rough and cracked.
- Only use leather care agents that have been tested and approved by Mercedes-Benz. You can obtain these from a qualified specialist workshop.

Leather is a natural product.

It exhibits natural surface characteristics, for example:

- Differences in the texture
- Signs of stretching and marking
- Slight nuances of color

These are characteristics of leather and not material defects.

Seat covers of other materials

❗ Observe the following when cleaning:

- Clean artificial leather covers with a cloth moistened with a solution containing 1% detergent (e.g. dish washing liquid).
- Clean cloth covers with a microfiber cloth moistened with a solution containing 1% detergent (e.g. dish washing liquid). Rub carefully and always wipe entire seat sections to avoid leaving visible lines. Leave the seat to dry afterwards. Cleaning results depend on the type of dirt and how long it has been there.
- Clean Alcantara® covers with a damp cloth. Make sure that you wipe entire seat sections to avoid leaving visible lines.

Cleaning the seat belts

 **WARNING**

Seat belts can become severely weakened if bleached or dyed. This could cause the seat belts to tear or fail, for instance, in the event of an accident. This poses an increased risk of injury or fatal injury.

Never bleach or dye the seat belts.

- !** Do not clean the seat belts using chemical cleaning agents. Do not dry the seat belts by warming them above 176 °F (80 °C) or placing them in direct sunlight.
- ▶ Use clean, lukewarm water and soap solution.

Cleaning the roof lining and carpets

- ▶ **Headliner:** if it is very dirty, use a soft brush or dry shampoo.
- ▶ **Carpets:** use the carpet and textile cleaning agents recommended and approved by Mercedes-Benz.

| | |
|-------------------------------|-----|
| Useful information | 380 |
| Where will I find...? | 380 |
| Flat tire | 381 |
| Battery (vehicle) | 385 |
| Jump-starting | 389 |
| Towing and tow-starting | 391 |
| Fuses | 394 |

Useful information

- i** This Operator's Manual describes all models and all standard and optional equipment of your vehicle available at the time of publication of the Operator's Manual. Country-specific differences are possible. Please note that your vehicle may not be equipped with all features described. This also applies to safety-related systems and functions.
- i** Read the information on qualified specialist workshops: (▷ page 27).

Where will I find...?

First-aid kit



- ▶ Open the tailgate.
- ▶ Remove first-aid kit ① from the parcel net.
- i** Check the expiration date on the first-aid kit at least once a year. Replace the contents if necessary, and replace missing items.

Vehicle tool kit

General notes

The vehicle tool kit can be found in the stowage well under the cargo compartment floor.

- i** Apart from certain country-specific variations, the vehicles are not equipped with a tire-change tool kit. Some tools for

changing a wheel are specific to the vehicle. For more information on which tools are required to perform a wheel change on your vehicle, consult a qualified specialist workshop.

Tools required for changing a wheel may include, for example:

- Jack
- Wheel chock
- Lug wrench
- Ratchet wrench
- Alignment bolt

Vehicles with a TIREFIT kit

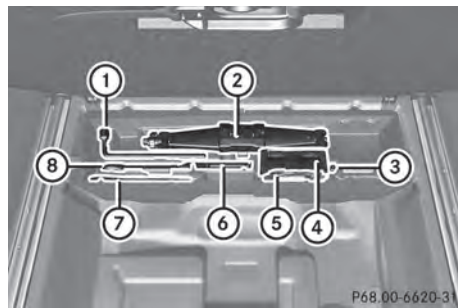

Vehicle tool kit (example)

- ① Lug wrench
- ② Jack
- ③ Alignment bolt
- ④ Tire inflation compressor
- ⑤ Tire sealant filler bottle
- ⑥ Folding wheel chock
- ⑦ Towing eye
- ⑧ Ratchet wrench

Use the TIREFIT kit (▷ page 383).

Vehicles with a "Minispare" emergency spare wheel

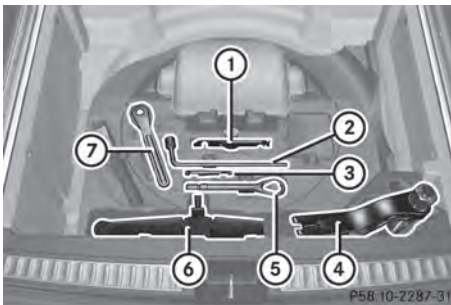

Example: vehicles with AIRMATIC and trailer tow hitch

- ① Folding wheel chock
 - ② Lug wrench
 - ③ Alignment bolt
 - ④ Ball coupling of the trailer tow hitch
 - ⑤ Towing eye
 - ⑥ Jack
 - ⑦ Ratchet wrench
- ▶ Lift the cargo compartment floor up (▷ page 342).
 - ▶ Remove the "Minispare" emergency spare wheel (▷ page 437).

Flat tire

Preparing the vehicle

Your vehicle may be equipped with:

- MOExtended tires (tires with run-flat properties) (▷ page 382)
Vehicle preparation is not necessary on vehicles with MOExtended tires.
- a TIREFIT kit (▷ page 380)
- an emergency spare wheel (only for certain countries) (▷ page 436)

Information on changing/mounting a wheel (▷ page 421).

- ▶ Stop the vehicle on solid, non-slippery and level ground, as far away as possible from traffic.
 - ▶ Switch on the hazard warning lamps.
 - ▶ Secure the vehicle against rolling away (▷ page 179).
 - ▶ If possible, bring the front wheels into the straight-ahead position.
 - ▶ **Vehicles with the AIRMATIC package:** make sure that highway level is selected (▷ page 209).
 - ▶ Switch off the engine.
 - ▶ **Vehicles without KEYLESS-GO:** remove the SmartKey from the ignition lock.
 - ▶ **Vehicles with KEYLESS-GO:** open the driver's door.
The on-board electronics now have status **0**. This is the same as the key having been removed.
 - ▶ **Vehicles with KEYLESS-GO:** remove the Start/Stop button from the ignition lock (▷ page 158).
 - ▶ All occupants must get out of the vehicle. Make sure that they are not endangered as they do so.
 - ▶ Make sure that no one is near the danger area while a wheel is being changed. Anyone who is not directly assisting in the wheel change should, for example, stand behind the barrier.
 - ▶ Get out of the vehicle. Pay attention to traffic conditions when doing so.
 - ▶ Close the driver's door.
 - ▶ Unload heavy luggage.
- i** Only operate the tire inflation compressor using a 12 V socket, even if the ignition is turned off (▷ page 347).
- An emergency cut-out ensures that the on-board voltage does not drop too low. If the on-board voltage is too low, the power to the sockets is automatically cut. This ensures that there is sufficient power to start the engine.

MOExtended tires (tires with run-flat properties)**General notes**

With MOExtended tires (tires with run flat characteristics), you can continue to drive your vehicle even if there is a total loss of pressure in one or more tires. The affected tire must not show any clearly visible damage.

You can recognize MOExtended tires by the MOExtended marking which appears on the sidewall of the tire. You will find this marking next to the tire size designation, the load-bearing capacity and the speed index (▷ page 415).

MOExtended tires may only be used in conjunction with an active tire pressure loss warning system or with an active tire pressure monitor.

If the pressure loss warning message appears in the multifunction display:

- Observe the instructions in the display messages (▷ page 310).
- Check the tire for damage.
- If driving on, observe the following notes.

The maximum driving distance is approximately 50 miles (80 km) when the vehicle is partially laden and approximately 18 miles (30 km) when the vehicle is fully laden.

In addition to the vehicle load, the driving distance possible depends upon:

- speed
- road condition
- outside temperature

The driving distance possible in run-flat mode may be reduced by extreme driving conditions/maneuvers, or it can be increased through a moderate style of driving.

The maximum permissible distance which can be driven in run-flat mode is counted from the moment the tire pressure loss warning appears in the multifunction display.

You must not exceed a maximum speed of 50 mph (80 km/h).

i When replacing one or all tires, make sure that you use only tires:

- of the size specified for the vehicle and
- marked "MOExtended"

If a tire has gone flat and cannot be replaced with a MOExtended tire, a standard tire may be used as a temporary measure. Make sure that you use the proper size and type (summer or winter tire).

i Vehicles with MOExtended tires are not equipped with a TIREFIT kit at the factory. It is therefore recommended that you additionally equip your vehicle with a TIREFIT kit if you mount tires that do not feature run-flat properties, e.g. winter tires. A TIREFIT kit may be obtained from a qualified specialist workshop.

Important safety notes** WARNING**

When driving in emergency mode, the driving characteristics deteriorate, e.g. when cornering, accelerating quickly and when braking. There is a risk of an accident.

Do not exceed the stated maximum speed. Avoid abrupt steering and driving maneuvers, and driving over obstacles (curbs, potholes, off-road). This applies in particular to a laden vehicle.

Stop driving in emergency mode if:

- you hear banging noises.
- the vehicle starts to shake.
- you see smoke and smell rubber.
- ESP[®] is intervening constantly.
- there are tears in the sidewalls of the tire.

After driving in emergency mode, have the wheel rims checked at a qualified specialist workshop with regard to their further use. The defective tire must be replaced in every case.

TIREFIT kit**Using the TIREFIT kit**

TIREFIT is a tire sealant.

TIREFIT can be used to seal small punctures of up to 0.16 inches (4 mm), particularly on the tire tread. You can use TIREFIT at outside temperatures down to -4 °F (-20 °C).

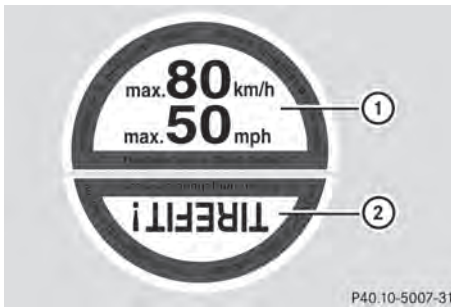

TIREFIT sticker, 2-part

- ▶ Do not remove any foreign objects which have penetrated the tire, e.g. screws or nails.
- ▶ Remove the tire sealant bottle, the accompanying TIREFIT sticker and the tire inflation compressor from the stowage well underneath the cargo compartment floor (▷ page 380).
- ▶ Affix part ① of the TIREFIT sticker within the driver's field of vision.
- ▶ Affix part ② of the TIREFIT sticker near the valve on the wheel with the defective tire.

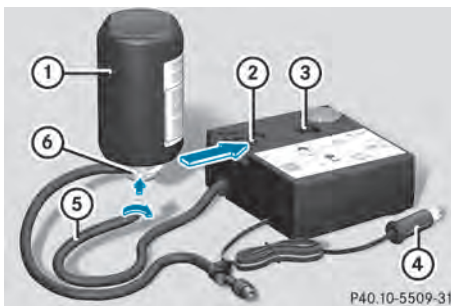

- ▶ Pull plug ④ with the cable and hose ⑤ out of the housing.
- ▶ Screw hose ⑤ onto flange ⑥ of tire sealant bottle ①.
- ▶ Place tire sealant bottle ① head downwards into recess ② of the tire inflation compressor.

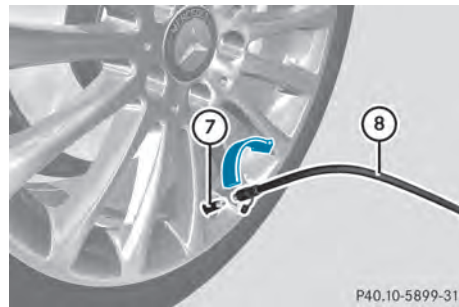

- ▶ Remove the cap from valve ⑦ on the faulty tire.
- ▶ Screw filler hose ⑧ onto valve ⑦.
- ▶ Insert connector ④ into a 12 V socket in your vehicle. Observe the notes on sockets (▷ page 347).
- ▶ Turn the SmartKey to position 1 in the ignition lock (▷ page 157).
- ▶ Press on/off switch ③ on the tire inflation compressor to I. The tire inflation compressor is switched on. The tire is inflated.

i First, tire sealant is pumped into the tire. The pressure can briefly rise to approximately 500 kPa (5 bar/73 psi).

Do not switch off the tire inflation compressor during this phase.

- ▶ Allow the tire inflation compressor to run for five minutes. The tire should then have attained a pressure of at least 180 kPa (1.8 bar/26 psi).

If a tire pressure of 180 kPa (1.8 bar/26 psi) has been attained after five minutes:

(▷ page 384).

If a tire pressure of 180 kPa (1.8 bar/26 psi) has not been attained after five minutes: (▷ page 384).

i If tire sealant leaks out, allow it to dry. It can then be removed like a layer of film.

If your clothes are soiled with tire sealant, have them cleaned with perchloroethylene at a dry cleaner as soon as possible.

Tire pressure not reached

If a pressure of 180 kPa (1.8 bar/26 psi) has not been achieved after five minutes:

- ▶ Switch off the tire inflation compressor.
- ▶ Unscrew the filler hose from the valve of the faulty tire.
- ▶ Very slowly drive forwards or reverse approximately 30 ft (10 m).
- ▶ Pump up the tire again.
After a maximum of five minutes the tire pressure must be at least 180 kPa (1.8 bar/26 psi).

WARNING

If the required tire pressure is not reached after the specified time, the tire is too badly damaged. The tire sealant cannot repair the tire in this instance. Damaged tires and a tire pressure that is too low can significantly impair the vehicle's braking and driving characteristics. There is a risk of accident.

Do not continue driving. Contact a qualified specialist workshop.

Tire pressure reached

WARNING

A tire temporarily sealed with tire sealant impairs the driving characteristics and is not suitable for higher speeds. There is a risk of accident.

You should therefore adapt your driving style accordingly and drive carefully. Do not exceed the specified maximum speed with a tire that has been repaired using tire sealant.

! Residue from the tire sealant may come out of the filler hose after use. This could cause stains.

Therefore, place the filler hose in the plastic bag which contained the TIREFIT kit.

Environmental note

Have the used tire sealant bottle disposed of professionally, e.g. at a qualified specialist workshop.

If a tire pressure of 180 kPa (1.8 bar/26 psi) has been attained after five minutes:

- ▶ Switch off the tire inflation compressor.
- ▶ Unscrew the filler hose from the valve of the faulty tire.
- ▶ Stow the tire sealant bottle and the tire inflation compressor.
- ▶ **Pull away immediately.**

The maximum speed for a tire sealed with tire sealant is 50 mph (80 km/h). The upper part of the TIREFIT sticker must be affixed to the instrument cluster in the driver's field of vision.

- ▶ Stop after driving for approximately ten minutes and check the tire pressure with the tire inflation compressor.
The tire pressure must now be at least 130 kPa (1.3 bar/19 psi).

WARNING

If the required tire pressure is not reached after driving for a short period, the tire is too badly damaged. The tire sealant cannot repair the tire in this instance. Damaged tires and a tire pressure that is too low can significantly impair the vehicle's braking and driving characteristics. There is a risk of accident.

Do not continue driving. Contact a qualified specialist workshop.

- ▶ Correct the tire pressure if it is still at least 130 kPa (1.3 bar/19 psi) (for the values, see the Tire and Loading Information

placard on the B-pillar on the driver's side or tire pressure table on the fuel filler flap).

- ▶ **To increase the tire pressure:** switch on the tire inflation compressor.

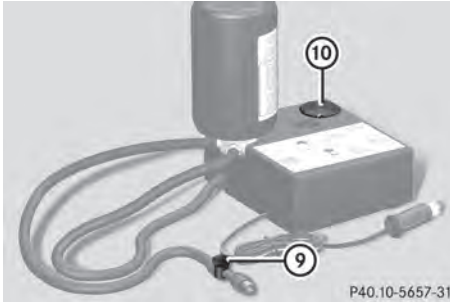

- ⑨ Pressure release button
- ⑩ Pressure gauge

- ▶ **To reduce the tire pressure:** press pressure release button ⑨ on the filler hose.
- ▶ Stow the tire sealant bottle and the tire inflation compressor.
- ▶ Drive to the nearest qualified specialist workshop and have the tire changed there.
- ▶ Have the tire sealant bottle replaced as soon as possible at a qualified specialist workshop.
- ▶ Have the tire sealant bottle replaced every four years at a qualified specialist workshop.

Battery (vehicle)

Important safety notes

Special tools and expert knowledge are required when working on the battery, e.g. removal and installing. You should therefore have all work involving the battery carried out at a qualified specialist workshop.

⚠ WARNING

Work carried out incorrectly on the battery can, for example, lead to a short circuit and damage your vehicle's electronic system. This

can disrupt driving safety systems such as ABS (anti-lock braking system) or ESP® (Electronic Stability Program).

- If ABS malfunctions, the wheels can lock during braking. This limits the steerability of the vehicle when braking and the braking distance may increase. There is a risk of accident.
- If ESP® malfunctions, the vehicle will not be stabilized if it starts to skid or a wheel starts to spin. There is a risk of accident.

You should therefore have all work involving the battery carried out at a qualified specialist workshop.

⚠ WARNING

Electrostatic build-up can lead to the creation of sparks, which could ignite the highly explosive gases of a battery. There is a risk of an explosion.

Before handling the battery, touch the vehicle body to remove any existing electrostatic build-up.

The highly flammable gas mixture forms when charging the battery as well as when jump-starting.

Always make sure that neither you nor the battery is electrostatically charged. There is a build-up of electrostatic charge, e.g.:

- by wearing clothing made from synthetic fibers
- due to friction between clothing and seats
- if you push or pull the battery across the carpet or other synthetic materials
- if you wipe the battery with a cloth.

⚠ WARNING

During the charging process, a battery produces hydrogen gas. If a short circuit occurs or sparks are created, the hydrogen gas can ignite. There is a risk of an explosion.

- Make sure that the positive terminal of a connected battery does not come into contact with vehicle parts.
- Never place metal objects or tools on a battery.
- It is important that you observe the described order of the battery terminals when connecting and disconnecting a battery.
- When jump-starting, make sure that the battery poles with identical polarity are connected.
- It is particularly important to observe the described order when connecting and disconnecting the jumper cables.
- Never connect or disconnect the battery terminals while the engine is running.

 **WARNING**

Battery acid is caustic. There is a risk of injury. Avoid contact with the skin, eyes or clothing. Do not inhale any battery gases. Do not lean over the battery. Keep children away from batteries. Wash battery acid immediately with water and seek medical attention.

 **Environmental note**



Batteries contain dangerous substances. It is against the law to dispose of them with the household rubbish. They must be collected separately and recycled to protect the environment.



Dispose of batteries in an environmentally friendly manner. Take discharged batteries to a qualified specialist workshop or a special collection point for used batteries.

- ❗ Have the battery checked regularly at a qualified specialist workshop.

Observe the service intervals in the Maintenance Booklet or contact a qualified specialist workshop for more information.

- ❗ You should have all work involving the battery carried out at a qualified specialist workshop. In the exceptional case that it is necessary for you to disconnect the battery yourself, make sure that:

- you switch off the engine and remove the SmartKey. On vehicles with KEYLESS-GO, ensure that the ignition is switched off. Check that all the indicator lamps in the instrument cluster are off. Otherwise, electronic components, such as the alternator, may be damaged.
- you first remove the negative terminal clamp and then the positive terminal clamp. Never swap the terminal clamps. Otherwise, the vehicle's electronic system may be damaged.
- the transmission is locked in position **P** after disconnecting the battery. The vehicle is secured against rolling away. You can then no longer move the vehicle.

The battery and the cover of the positive terminal clamp must be installed securely during operation.

Comply with safety precautions and take protective measures when handling batteries.



WARNING



Fire, open flames and smoking are prohibited when handling the battery. Avoid creating sparks.



Battery acid is caustic. Avoid contact with the skin, eyes or clothing.

Wear suitable protective clothing, in particular gloves, an apron and a face mask.

Immediately rinse acid splashes off with clean water. Consult a doctor if necessary.



Wear eye protection.



Keep children away.



Observe this Operator's Manual.

For safety reasons, Mercedes-Benz recommends that you only use batteries which have been tested and approved for your vehicle by Mercedes-Benz. These batteries provide increased impact protection to prevent vehicle occupants from suffering acid burns should the battery be damaged in the event of an accident.

In order for the battery to achieve the maximum possible service life, it must always be sufficiently charged.

The vehicle battery, like other batteries, can discharge over time if you do not use the vehicle. In this case, have the battery disconnected at a qualified specialist workshop. You can also charge the battery with a charger recommended by Mercedes-Benz. Contact a qualified specialist workshop for further information.

Have the battery charge level checked more frequently if you use the vehicle mainly for short trips or if you leave it standing idle for a lengthy period. Consult a qualified specialist workshop if you wish to leave your vehicle parked for a long period of time.

- i** Remove the SmartKey if you park the vehicle and do not require any electrical consumers. The vehicle will then use very little energy, thus conserving battery power.

Charging the battery

WARNING

During charging and jump-starting, explosive gases can escape from the battery. There is a risk of an explosion.

Particularly avoid fire, open flames, creating sparks and smoking. Ensure there is sufficient ventilation while charging and jump-starting. Do not lean over a battery.

WARNING

Battery acid is caustic. There is a risk of injury. Avoid contact with the skin, eyes or clothing. Do not inhale any battery gases. Do not lean over the battery. Keep children away from batteries. Wash battery acid immediately with water and seek medical attention.

WARNING

A discharged battery can freeze at temperatures below freezing point. When jump-starting the vehicle or charging the battery, gases can escape from the battery. There is a risk of an explosion.

Allow the frozen battery to thaw out before charging it or jump-starting.

- !** Only use battery chargers with a maximum charging voltage of 14.8 V.

- !** Only charge the battery using the jump-starting connection point.

Never charge a battery still installed in the vehicle unless a battery charger unit approved by Mercedes-Benz is being used. A battery charger unit specially adapted for Mercedes-Benz vehicles and tested and approved by Mercedes-Benz is available as an accessory. It permits the charging of the battery in its installed position. Contact an authorized Mercedes-Benz Center for further information and availability. Charge the battery in accordance with the separate instructions for the battery charger.

The jump-starting connection point is in the engine compartment (▷ page 389).

Read the battery charger's operating instructions before charging the battery.

- ▶ Open the hood (▷ page 364).
- ▶ Connect the battery charger to the positive terminal and ground point in the same order as when connecting the donor battery in the jump-starting procedure (▷ page 389).

Jump-starting

For the jump-starting procedure, use only the jump-starting connection point, consisting of a positive terminal and an earth point, in the engine compartment.

WARNING

Battery acid is caustic. There is a risk of injury.

Avoid contact with the skin, eyes or clothing. Do not inhale any battery gases. Do not lean over the battery. Keep children away from batteries. Wash battery acid immediately with water and seek medical attention.

WARNING

During charging and jump-starting, explosive gases can escape from the battery. There is a risk of an explosion.

Particularly avoid fire, open flames, creating sparks and smoking. Ensure there is sufficient ventilation while charging and jump-starting. Do not lean over a battery.

WARNING

During the charging process, a battery produces hydrogen gas. If a short circuit occurs or sparks are created, the hydrogen gas can ignite. There is a risk of an explosion.

- Make sure that the positive terminal of a connected battery does not come into contact with vehicle parts.
- Never place metal objects or tools on a battery.
- It is important that you observe the described order of the battery terminals when connecting and disconnecting a battery.
- When jump-starting, make sure that the battery poles with identical polarity are connected.
- It is particularly important to observe the described order when connecting and disconnecting the jumper cables.
- Never connect or disconnect the battery terminals while the engine is running.

WARNING

A discharged battery can freeze at temperatures below freezing point. When jump-starting the vehicle or charging the battery, gases can escape from the battery. There is a risk of an explosion. Allow the frozen battery to thaw out before charging it or jump-starting.

WARNING

Non-combusted fuel can collect in the exhaust system and ignite. There is a risk of fire. Avoid repeated and lengthy starting attempts.

- ❗ Avoid repeated and lengthy starting attempts. Otherwise, the catalytic converter could be damaged by the non-combusted fuel.

Do not start the vehicle using a rapid charging device. If your vehicle's battery is discharged, the engine can be jump-started from another vehicle or from a second battery using jumper cables. Observe the following points:

- The battery is not accessible in all vehicles. If the other vehicle's battery is not accessible, jump-start the vehicle using a second battery or a jump-starting device.
- You may only jump-start the vehicle when the engine and exhaust system are cold.
- Do not start the engine if the battery is frozen. Let the battery thaw first.
- Only jump-start from batteries with a 12 V voltage rating.
- Only use jumper cables which have a sufficient cross-section and insulated terminal clamps.
- If the battery is fully discharged, leave the battery that is being used to jump-start connected for a few minutes before attempting to start. This charges the battery slightly.
- Make sure that the two vehicles do not touch.

Make sure that:

- the jumper cables are not damaged.
- when the jumper cables are connected to the battery, uninsulated sections of the terminal clamp do not come into contact with other metal sections.
- the jumper cables cannot come into contact with parts such as the V-belt pulley or the fan. These parts move when the engine is started and while it is running.
- ▶ Secure the vehicle by applying the electric parking brake.
- ▶ Shift the transmission to position **P**.
- ▶ Turn the SmartKey to position **0** in the ignition lock and remove it (▷ page 157). On vehicles with KEYLESS-GO, make sure the ignition is switched off (▷ page 158). All indicator lamps in the instrument cluster must be off.
- ▶ Switch off all electrical consumers (e.g. radio, blower, etc.).
- ▶ Open the hood (▷ page 364).

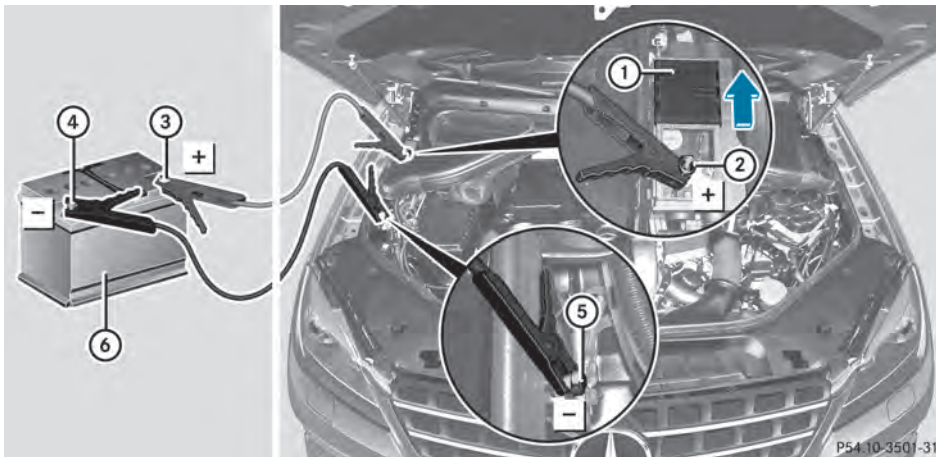

Position number ⑥ identifies the charged battery of the other vehicle or an equivalent jump-starting device.

- ▶ Slide cover ① of positive terminal ② in the direction of the arrow.
 - ▶ Connect positive terminal ② on your vehicle to positive terminal ③ of donor battery ⑥ using the jumper cable, always begin with positive terminal ② on your own vehicle first.
 - ▶ Start the engine of the donor vehicle and run it at idling speed.
 - ▶ Connect negative terminal ④ of donor battery ⑥ to ground point ⑤ of your vehicle using the jumper cable, connecting the jumper cable to donor battery ⑥ first.
 - ▶ Start the engine.
 - ▶ Before disconnecting the jumper cables, let the engine run for several minutes.
 - ▶ First, remove the jumper cables from earth point ⑤ and negative terminal ④, then from positive clamp ② and positive terminal ③. Begin each time at the contacts on your own vehicle first.
 - ▶ Close cover ① of positive terminal ② after removing the jumper cables.
 - ▶ Have the battery checked at a qualified specialist workshop.
- i** Jump-starting is not considered to be a normal operating condition.
- i** Jumper cables and further information regarding jump-starting can be obtained at any qualified specialist workshop.

Towing and tow-starting

Important safety notes

WARNING

Functions relevant to safety are restricted or no longer available if:

- the engine is not running.
- the brake system or the power steering is malfunctioning.
- there is a malfunction in the voltage supply or the vehicle's electrical system.

If your vehicle is being towed, much more force may be necessary to steer or brake.

There is a risk of an accident.

In such cases, use a tow bar. Before towing, make sure that the steering moves freely.

WARNING

If the weight of the vehicle to be towed or tow-started is greater than the permissible gross weight of your vehicle:

- the towing eye could detach itself
- the vehicle/trailer combination could rollover.

There is a risk of an accident.

When towing or tow-starting another vehicle, its weight should not be greater than the permissible gross weight of your vehicle.

WARNING

The vehicle is braked when the HOLD function or DISTRONIC PLUS is activated. Therefore, deactivate HOLD and DISTRONIC PLUS if the vehicle is to be towed.

- !** Make sure that the electric parking brake is released. If the electric parking brake is faulty, visit a qualified specialist workshop.
- !** Only secure the tow rope or tow bar at the towing eyes. Otherwise, the vehicle could be damaged.
- !** Do not use the towing eye for recovery, this could damage the vehicle. If in doubt, recover the vehicle with a crane.
- !** When towing, pull away slowly and smoothly. If the tractive power is too high, the vehicles could be damaged.

❗ When towing vehicles with KEYLESS-GO, use the key instead of the Start/Stop button. Otherwise, the automatic transmission may shift to position **P** when the driver's or front-passenger door are opened, which could lead to damage to the transmission.

❗ Do not tow with sling-type equipment. This could damage the vehicle.

❗ Vehicles with differential locks: make sure the differential locks are in automatic mode. When towing, the differential locks must not be switched on. The transmission may otherwise be damaged.

❗ The vehicle can be towed a maximum of 30 miles (50km). The towing speed of 30 mph (50 km/h) must not be exceeded. If the vehicle has to be towed more than 30 miles (50km), the entire vehicle must be raised and transported.

❗ If you tow or tow-start another vehicle, its weight must not exceed the maximum permissible gross vehicle weight of your vehicle.

Information on your vehicle's gross vehicle weight rating can be found on the vehicle identification plate (▷ page 443).

It is better to have the vehicle transported than to have it towed.

If the vehicle has suffered transmission damage, have it transported on a transporter or trailer.

The automatic transmission must be in position **N** when the vehicle is being towed. The battery must be connected and charged. Otherwise, you:

- cannot turn the SmartKey to position **2** in the ignition lock
- cannot release the electric parking brake
- cannot shift the automatic transmission to position **N**

i Deactivate the automatic locking feature (▷ page 276). You could otherwise be

locked out when pushing or towing the vehicle.

Installing/removing the towing eye

Installing the towing eye

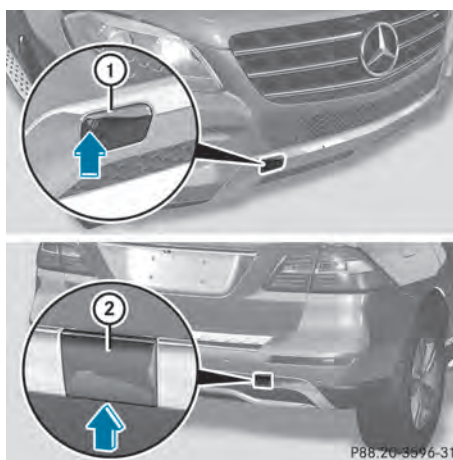

Example: towing eye mounting covers

- ① Front cover
- ② Back cover

Vehicles with a trailer tow hitch: if possible, connect the towbar to the trailer tow hitch (▷ page 253).

The brackets for the screw-in towing eyes are located in the bumpers. They are at the front and at the rear, under the covers.

- ▶ Remove the towing eye from the vehicle tool kit (▷ page 380).
- ▶ **To open the cover at the front:** press the mark on cover ① inwards in the direction of the arrow.
- ▶ **To open the cover at the rear:** insert a flat, blunt object into the cutout and lever cover ② out of the bumper.
- ▶ Take cover ① or ② off the opening.
- ▶ Screw the towing eye in clockwise to the stop and tighten it.

Removing the towing eye

- ▶ Loosen the towing eye and unscrew it.
- ▶ Attach cover ① or ② to the bumper and press until it engages.
- ▶ Place the towing eye in the vehicle tool kit.

Towing the vehicle with the rear axle raised

! The ignition must be switched off if you are towing the vehicle with the rear axle raised. Intervention by ESP® could otherwise damage the brake system.

Only possible for vehicles without 4MATIC.

- ▶ Switch on the hazard warning lamps (▷ page 124).
- ▶ Turn the SmartKey to position **0** in the ignition lock and remove the SmartKey from the ignition lock.
- ▶ When leaving the vehicle, take the SmartKey or the KEYLESS-GO key with you.

When towing your vehicle with the rear axle raised, it is important that you observe the safety instructions (▷ page 391).

Towing a vehicle with both axles on the ground

It is important that you observe the safety instructions when towing away your vehicle (▷ page 391).

The automatic transmission automatically shifts to position **P** when you open the driver's or front-passenger door or when you remove the SmartKey from the ignition lock.

In order to ensure that the automatic transmission stays in position **N** when towing the vehicle, you must observe the following points:

- ▶ Make sure that the vehicle is stationary and the SmartKey in the ignition lock is in position **0**.
- ▶ Turn the SmartKey to position **2** in the ignition lock.
On vehicles with KEYLESS-GO, use the SmartKey instead of the Start/Stop button (▷ page 158).
- ▶ Depress and hold the brake pedal.
- ▶ Shift the automatic transmission to position **N**.
- ▶ Release the brake pedal.
- ▶ Release the electric parking brake.
- ▶ Leave the SmartKey in position **2** in the ignition lock.
- ▶ Switch on the hazard warning lamps (▷ page 124).

i In order to signal a change of direction when towing the vehicle with the hazard warning lamps switched on, use the combination switch as usual. In this case, only the indicator lamps for the direction of travel flash. After resetting the combination switch, the hazard warning lamp starts flashing again.

Transporting the vehicle

! Only lash the vehicle down by the wheels or wheel rims, not by parts of the vehicle such as axle or steering components. Otherwise, the vehicle could be damaged.

The towing eyes or trailer tow hitch can be used to pull the vehicle onto a trailer or transporter if you wish to transport it.

- ▶ Turn the SmartKey to position **2** in the ignition lock.
- ▶ Shift the automatic transmission to position **N**.

As soon as the vehicle is loaded:

- ▶ Prevent the vehicle from rolling away by applying the electric parking brake.
- ▶ Shift the automatic transmission to position **P**.
- ▶ Turn the SmartKey to position **0** in the ignition lock and remove it.
- ▶ Secure the vehicle.

Information on 4MATIC vehicles

! Vehicles with 4MATIC must not be towed with either the front or the rear axle raised, as doing so will damage the transmission.

If the vehicle has transmission damage or damage to the front or rear axle, have it transported on a transporter or trailer.

In the event of damage to the electrical system

If the battery is defective, the automatic transmission will be locked in position **P**. To shift the automatic transmission to position **N**, you must provide power to the vehicle's electrical system in the same way as when jump-starting (▷ page 389).

Have the vehicle transported on a transporter or trailer.

Recovering a vehicle that has become stuck

! Pull away smoothly, slowly, and in a straight line when pulling out a vehicle that has become stuck. Excessive tractive power could damage the vehicles.

If the drive wheels get trapped on loose or muddy ground, recover the vehicle with the utmost care, especially so if the vehicle is laden.

Never attempt to recover a vehicle with a trailer attached.

Pull out the vehicle backwards, if possible, using the tracks it made when it became stuck.

Tow-starting (emergency engine starting)

! Vehicles with an automatic transmission must not be tow-started. You could otherwise damage the automatic transmission.

You can find information on "Jump-starting" at (▷ page 389).

Fuses**Important safety notes****⚠ WARNING**

Only use fuses that have been approved for Mercedes-Benz vehicles and that have the correct fuse rating for the systems concerned. Do not attempt to repair or bridge faulty fuses. Using fuses that have not been approved or attempting to repair or bridge faulty fuses could cause the fuse to be overloaded and result in a fire. Have the cause traced and rectified at a qualified specialist workshop.

! For the fuse boxes in the engine compartment and under the rear bench seat, only use fuses with the suffix "S". Otherwise, components or systems could be damaged.

The fuses in your vehicle serve to close down faulty circuits. If a fuse blows, all the components on the circuit and their functions stop operating.

Blown fuses must be replaced with fuses of the same rating, which you can recognize by the color and value. The fuse ratings are listed in the fuse allocation chart.

If a newly inserted fuse also blows, have the cause traced and rectified at a qualified specialist workshop, e.g. an authorized Mercedes-Benz Center.

Before changing a fuse

- ▶ Secure the vehicle against rolling away (▷ page 179).
- ▶ Switch off all electrical consumers.
- ▶ Turn the SmartKey to position **0** in the ignition lock and remove it (▷ page 157). On vehicles with KEYLESS-GO, make sure the ignition is switched off (▷ page 158). All indicator lamps in the instrument cluster must be off.

The fuses are located in various fuse boxes:

- fuse box on the front-passenger side of the dashboard
- fuse box in the engine compartment on the right-hand side of the vehicle, when viewed in the direction of travel
- Fuse box under the rear bench seat

The fuse allocation chart is located in the fuse box under the rear bench seat (▷ page 395).

Dashboard fuse box

- ❗ Do not use a pointed object such as a screwdriver to open the cover in the dashboard. You could damage the dashboard or the cover.
- ❗ Make sure that no moisture can enter the fuse box when the cover is open.
- ❗ When closing the cover, make sure that it is lying correctly on the fuse box. Moisture seeping in or dirt could otherwise impair the operation of the fuses.

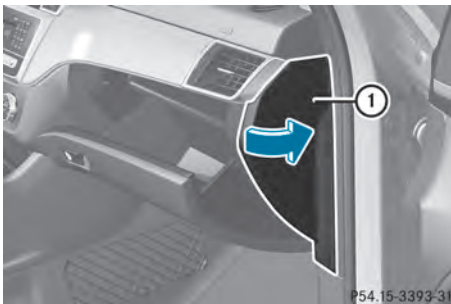

- ▶ **To open:** pull cover ① outwards in the direction of the arrow and remove it.
- ▶ **To close:** clip in cover ① on the front of the dashboard.
- ▶ Fold cover ① inwards until it engages.

Fuse box in the engine compartment

- ❗ Make sure that no moisture can enter the fuse box when the cover is open.
- ❗ When closing the cover, make sure that it is lying correctly on the fuse box. Moisture seeping in or dirt could otherwise impair the operation of the fuses.

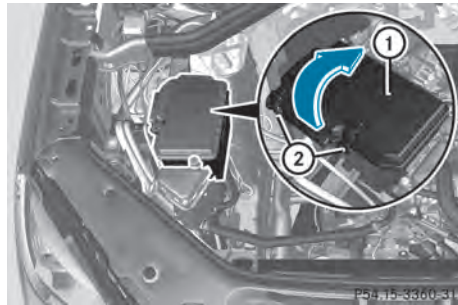

- ▶ Open the hood.
- ▶ Remove any existing moisture from the fuse box using a dry cloth.
- ▶ **To open:** open clamps ②.
- ▶ Fold up cover ① in the direction of the arrow and remove it.
- ▶ **To close:** check whether the seal is seated correctly in cover ①.
- ▶ Insert cover ① at the side of the fuse box into the retainers.
- ▶ Fold down cover ① and close clamps ②.
- ▶ Close the hood.

Fuse box under the rear bench seat

- ❗ Make sure that no moisture can enter the fuse box when the cover is open.

! When closing the cover, make sure that it is lying correctly on the fuse box. Moisture seeping in or dirt could otherwise impair the operation of the fuses or the cover could be damaged by the rear bench seat.

- ▶ Fold the right-hand rear bench seat forward (▷ page 335).

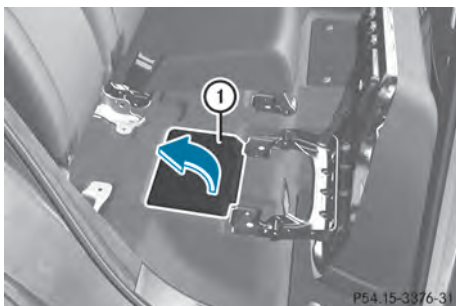

- ▶ **To open:** lift and fold out carpet ① in the direction of the arrow.

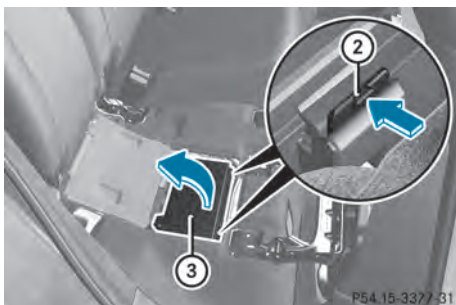

- ▶ Release clamps ② by pressing them in the direction of the arrow.
- ▶ Fold cover ③ up in the direction of the arrow and remove it.
- i** The fuse allocation chart is located under cover ③.
- ▶ **To close:** insert cover ③ into the retainers on the side of the fuse box.
- ▶ Fold down cover ③ until clamps ② engage audibly.
- ▶ Fold the right-hand rear bench seat back (▷ page 335).

| | |
|-----------------------------------|-----|
| Useful information | 398 |
| Important safety notes | 398 |
| Operation | 398 |
| Winter operation | 400 |
| Tire pressure | 402 |
| Loading the vehicle | 410 |
| All about wheels and tires | 413 |
| Changing a wheel | 421 |
| Wheel and tire combinations | 426 |
| Emergency spare wheel | 436 |

Useful information

- i** This Operator's Manual describes all models and all standard and optional equipment of your vehicle available at the time of publication of the Operator's Manual. Country-specific differences are possible. Please note that your vehicle may not be equipped with all features described. This also applies to safety-related systems and functions.
- i** Read the information on qualified specialist workshops: (> page 27).

Important safety notes

WARNING

If wheels and tires of the wrong size are used, the wheel brakes or suspension components may be damaged. There is a risk of an accident.

Always replace wheels and tires with those that fulfill the specifications of the original part.

When replacing wheels, make sure to use the correct:

- designation
- model

When replacing tires, make sure to use the correct:

- designation
- manufacturer
- model

WARNING

A flat tire severely impairs the driving, steering and braking characteristics of the vehicle. There is a risk of accident.

Tires without run-flat characteristics:

- do not drive with a flat tire.
- immediately replace the flat tire with your emergency spare wheel or spare wheel, or consult a qualified specialist workshop.

Tires with run-flat characteristics:

- pay attention to the information and warning notices on MOExtended tires (tires with run-flat characteristics).

Accessories that are not approved for your vehicle by Mercedes-Benz or are not being used correctly can impair the operating safety.

Before purchasing and using non-approved accessories, visit a qualified specialist workshop and inquire about:

- suitability
- legal stipulations
- factory recommendations

Information on the dimensions and types of wheels and tires for your vehicle can be found in the "Wheel/tire combinations" section (> page 426).

Information on air pressure for the tires on your vehicle can be found:

- on the vehicle's Tire and Loading Information placard on the B-pillar (> page 410)
- on the tire pressure label on the fuel filler flap (> page 174)
- in the "Tire pressure" section
- under "Tire pressure" (> page 402)

Operation

Information on driving

If the vehicle is heavily loaded, check the tire pressures and correct them if necessary.

While driving, pay attention to vibrations, noises and unusual handling characteristics, e.g. pulling to one side. This may indicate that the wheels or tires are damaged. If you suspect that a tire is defective, reduce your speed immediately. Stop the vehicle as soon as possible to check the wheels and tires for damage. Hidden tire damage could also be causing the unusual handling characteristics. If you find no signs of damage, have the tires

and wheels checked at a qualified specialist workshop.

When parking your vehicle, make sure that the tires do not get deformed by the curb or other obstacles. If it is necessary to drive over curbs, speed humps or similar elevations, try to do so slowly and at an obtuse angle. Otherwise, the tires, particularly the sidewalls, may be damaged.

Regular checking of wheels and tires

WARNING

Damaged tires can cause tire inflation pressure loss. As a result, you could lose control of your vehicle. There is a risk of accident.

Check the tires regularly for signs of damage and replace any damaged tires immediately.

Regularly check the wheels and tires of your vehicle for damage at least once a month, as well as after driving off-road or on rough roads. Damaged wheels can cause a loss of tire pressure. Pay particular attention to damage such as:

- cuts in the tires
- punctures
- tears in the tires
- bulges on tires
- deformation or severe corrosion on wheels

Regularly check the tire tread depth and the condition of the tread across the whole width of the tire (▷ page 399). If necessary, turn the front wheels to full lock in order to inspect the inner side of the tire surface.

All wheels must have a valve cap to protect the valve against dirt and moisture. Do not mount anything onto the valve other than the standard valve cap or other valve caps approved by Mercedes-Benz for your vehicle. Do not use any other valve caps or systems, e.g. tire pressure monitoring systems.

Regularly check the pressure of all the tires particularly prior to long trips. Adjust the tire pressure as necessary (▷ page 402).

Observe the notes on the emergency spare wheel (▷ page 436).

The service life of tires depends on the following factors amongst other things:

- Driving style
- Tire pressure
- Distance covered

Tire tread

WARNING

Insufficient tire tread will reduce tire traction. The tire is no longer able to dissipate water. This means that on wet road surfaces, the risk of hydroplaning increases, in particular where speed is not adapted to suit the driving conditions. There is a risk of accident.

If the tire pressure is too high or too low, tires may exhibit different levels of wear at different locations on the tire tread. Thus, you should regularly check the tread depth and the condition of the tread across the entire width of all tires.

Minimum tire tread depth for:

- Summer tires: $\frac{1}{8}$ in (3 mm)
- M+S tires: $\frac{1}{8}$ in (4 mm)

For safety reasons, replace the tires before the legally prescribed limit for the minimum tire tread depth is reached.

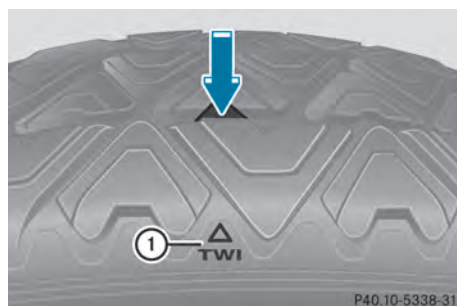

P40.10-5338-31

Bar indicator ① for tread wear is integrated into the tire tread.

Treadwear indicators (TWI) are required by law. Six indicators are positioned on the tire tread. They are visible once the tread depth is approximately $\frac{1}{16}$ in (1.6 mm). If this is the case, the tire is so worn that it must be replaced.

Selecting, mounting and replacing tires

- Only mount tires and wheels of the same type and make.
Exception: it is permissible to install a different type or make in the event of a flat tire. Observe the "MOExtended tires (tires with run-flat characteristics)" section (▷ page 382).
- Only mount tires of the correct size onto the wheels.
- Break in new tires at moderate speeds for the first 60 miles (100 km). They only reach their full performance after this distance.
- Do not drive with tires which have too little tread depth, as this significantly reduces the traction on wet roads (hydroplaning).
- Replace the tires after six years at the latest, regardless of wear.

Observe the notes on the emergency spare wheel (▷ page 436).

MOExtended tires (tires with run-flat properties)

With MOExtended tires (tires with run flat characteristics), you can continue to drive your vehicle even if there is a total loss of pressure in one or more tires.

MOExtended tires may only be used in conjunction with an active tire pressure loss warning system or with an active tire pressure monitor and on wheels specifically tested by Mercedes-Benz.

Notes on driving with MOExtended tires with a flat tire (▷ page 382).

- **i** Vehicles equipped with MOExtended tires are not equipped with a TIREFIT kit at the factory. It is therefore recommended that you additionally equip your vehicle with a TIREFIT kit if you mount tires that do not feature run-flat properties, e.g. winter tires. A TIREFIT kit can be obtained from a qualified specialist workshop.

Winter operation

General notes

Have your vehicle winterproofed at a qualified specialist workshop at the onset of winter.

Observe the notes in the "Changing a wheel" section (▷ page 421).

Driving with summer tires

At temperatures below 45 °F (+7 °C), summer tires lose elasticity and therefore traction and braking power. Change the tires on your vehicle to M+S tires. Using summer tires at very cold temperatures could cause cracks to form, thereby damaging the tires permanently. Mercedes-Benz cannot accept responsibility for this type of damage.

M+S tires

WARNING

M+S tires with a tire tread depth of less than $\frac{1}{8}$ in (4 mm) are not suitable for use in winter and do not provide sufficient traction. There is a risk of an accident.

M+S tires with a tread depth of less than $\frac{1}{8}$ in (4 mm) must be replaced immediately.

At temperatures below 45 °F (+7 °C), use winter tires or all-season tires. Both types of tire are identified by the M+S marking.

Only winter tires bearing the  snowflake symbol in addition to the M+S marking provide the best possible grip in wintry road conditions.

Only these tires will allow driving safety systems such as ABS and ESP® to function optimally in winter. These tires have been developed specifically for driving in snow.

Use M+S tires of the same make and tread on all wheels to maintain safe handling characteristics.

Always observe the maximum permissible speed specified for the M+S tires you have mounted.

Once the winter tires are mounted:

- ▶ Check the tire pressures (▷ page 405).
- ▶ Restart the tire pressure monitor (▷ page 406).
- ▶ **Vehicles for Canada:** restart the tire pressure loss warning system (▷ page 406).

For more information on driving with the emergency spare wheel, see (▷ page 436).

Snow chains

WARNING

If snow chains are installed to the front wheels, they may drag against the vehicle body or chassis components. This could cause damage to the vehicle or the tires. There is a risk of an accident.

To avoid hazardous situations:

- never install snow chains to the front wheels
- always install snow chains in pairs to the rear wheels.

! You must drive at raised vehicle level (height 1) if snow chains have been installed. The vehicle may otherwise be damaged.

! **Vehicles with Adaptive Damping System (ADS):** do not use the sports mode

if you have installed snow chains. The vehicle may otherwise be damaged.

! On some tire sizes there is not enough space for snow chains. To avoid damage to the vehicle or tires, observe the "Wheel and tire combinations" section under "Tires and wheels".

For safety reasons, Mercedes-Benz recommends that you only use snow chains that have been specially approved for your vehicle by Mercedes-Benz, or are of a corresponding standard of quality.

If you intend to mount snow chains, please bear the following points in mind:

- Only use snow chains when driving on roads completely covered by snow. Remove the snow chains as soon as possible when you come to a road that is not snow-covered.
- Do not exceed the maximum permissible speed of 30 mph (50 km/h).
- Local regulations may restrict the use of snow chains. Observe the appropriate regulations if you wish to mount snow chains.
- Snow chains may not be mounted on all wheel/tire combinations. Permissible wheel-tire combinations (▷ page 426).

i You may wish to deactivate ESP® when pulling away with snow chains installed (▷ page 71). This way you can allow the wheels to spin in a controlled manner, achieving an increased driving force (cutting action).

For more information on driving with an emergency spare wheel, see (▷ page 436).

Tire pressure

Tire pressure specifications

Important safety notes

WARNING

Tires with tire pressures that are too low or too high are associated with the following hazards:

- they can burst, in particular if the vehicle is heavily laden or when driven at high speeds.
- the tires can wear excessively and/or unevenly, which can severely impair tire traction.
- the driving, steering and braking characteristics may be severely impaired.

There is a risk of accident.

Follow recommended tire inflation pressures and check the pressure of all the tires including the spare wheel:

- monthly, at least
- if the load changes
- before beginning a long journey
- under different operating conditions, e.g. off-road driving

If necessary, correct the tire pressure.

 The specifications on the sample Tire and Loading Information placard and tire pressure tables are examples. Tire pressure specifications are vehicle-specific and may deviate from the data shown here. The tire pressure specifications that are valid for your vehicle can be found on the Tire and Loading Information placard and tire pressure table on the vehicle.

General notes

The recommended tire pressures for the tires mounted at the factory can be found on the labels described here.

Operation with the emergency spare wheel (> page 436).

Operation with a trailer: the applicable value for the rear tires is the maximum tire pressure value stated in the table inside the fuel filler flap.

Further information on tire pressures can be obtained at a qualified specialist workshop.

Tire and Loading Information placard

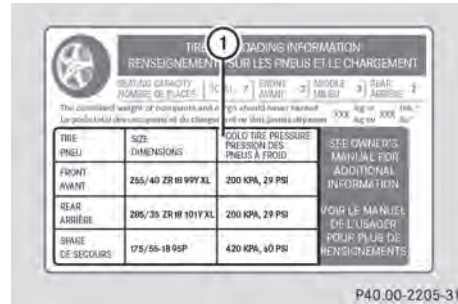

① Recommended tire pressures

The Tire and Loading Information placard is on the B-pillar on the driver's side of the vehicle (> page 410).

The Tire and Loading Information placard contains the recommended tire pressures for cold tires. The recommended tire pressures are valid for the maximum permissible load and up to the maximum permissible vehicle speed.

Tire pressure table

The tire pressure table is on the inside of the fuel filler flap.

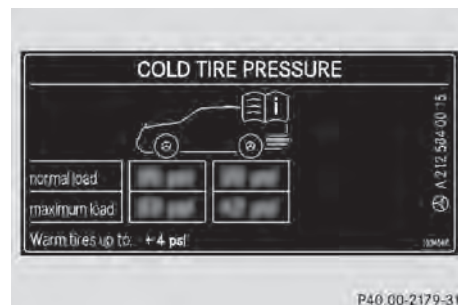

Example: tire pressure table for all tires permitted for this vehicle by the factory

The tire pressure table contains the recommended pressures for cold tires for various operating conditions, i.e. differing load and speed conditions.

LUFTDRUCK PRESSURE PRESSION PRESIÓN
für kalte Reifen for cold tires des pneus froids de inflado

100 kPa = 1 bar

| | front | rear | front | rear |
|------------|-------|------|-------|------|
| 195/55 R16 | 2.3 | 2.5 | 2.3 | 2.5 |
| 215/45 R17 | 2.3 | 2.5 | 2.3 | 2.5 |
| 215/40 R18 | 2.3 | 2.5 | 2.3 | 2.5 |

Warme Reifen: Warm tires up to: + 30 kPa + 4 psi
Pneus échauffés jusqu'à: Neumáticos calientes hasta:

P40.00-2183-31

Example: tire pressure table with tire dimensions

If a tire size precedes a tire pressure, the tire pressure information following is only valid for that tire size. The load conditions "partially laden" and "fully laden" are defined in the table for different numbers of occupants and amounts of luggage. The actual number of seats may differ.

Luftdruck für kalte Reifen
Tire pressure cold tires
Pression des pneus froids
Presión de inflado

100 kPa = 1 bar

| | front | rear | front | rear |
|-----|-------|------|-------|------|
| R18 | 2.3 | 2.5 | 2.3 | 2.5 |
| R19 | 2.3 | 2.5 | 2.3 | 2.5 |

Wichtig!
240 km/h
150 mph

Warme Reifen bis: Warm tires up to: + 30 kPa + 4 psi
Pneus échauffés jusqu'à: Neumáticos calientes hasta: + 30 kPa + 4 psi

P40.00-2184-31

Some tire pressure tables show only the rim diameters instead of the full tire size, e.g.

R18. The rim diameter is part of the tire size and can be found on the tire sidewall (▷ page 415).

If the tire pressures have been set to the lower values for lighter loads and/or lower road speeds, the pressures should be reset to the higher values:

- if you want to drive with an increased load and/or
- if you want to drive at higher road speeds.

- **i** The tire pressures for increased loads and/or higher road speeds, shown in the tire pressure table, may have a negative effect on driving comfort.

If the tire pressure is not set correctly, this can lead to an excessive build up of heat and a sudden loss of pressure.

For more information, contact a qualified specialist workshop.

Important notes on tire pressure

⚠ WARNING

If the tire pressure drops repeatedly, the wheel, valve or tire may be damaged. Tire pressure that is too low may result in a tire blow-out. There is a risk of an accident.

- Check the tire for foreign objects.
- Check whether the wheel is losing air or the valve is leaking.

If you are unable to rectify the damage, contact a qualified specialist workshop.

⚠ WARNING

If you fit unsuitable accessories onto tire valves, the tire valves may be overloaded and malfunction, which can cause tire pressure loss. Due to their design, retrofitted tire pressure monitors keep the tire valve open. This can also result in tire pressure loss. There is a risk of an accident.

Only screw the standard valve cap or other valve caps approved by Mercedes-Benz for your vehicle onto the tire valve.

Use a suitable pressure gauge to check the tire pressure. The outer appearance of a tire does not permit any reliable conclusion about the tire pressure. On vehicles equipped with the electronic tire pressure monitoring system, the tire pressure can be checked using the on-board computer.

The tire temperature and pressure increase when the vehicle is in motion. This is dependent on the driving speed and the load.

Therefore, you should only correct tire pressures when the tires are cold.

The tires are cold:

- if the vehicle has been parked without direct sunlight on the tires for at least three hours and
- if the vehicle has not been driven further than 1 mile (1.6 km)

The tire temperature changes depending on the outside temperature, the vehicle speed and the tire load. If the tire temperature changes by 18 °F (10 °C), the tire pressure changes by approximately 10 kPa (0.1 bar/ 1.5 psi). Take this into account when checking the pressure of warm tires. Only correct the tire pressure if it is too low for the current operating conditions. If you check the tire pressure when the tires are warm, the resulting value will be higher than if the tires were cold. This is normal. Do not reduce the tire pressure to the value specified for cold tires. The tire pressure would otherwise be too low.

Observe the recommended tire pressures for cold tires:

- on the Tire and Loading Information placard on the B-pillar on the driver's side
- in the tire pressure table on the inside of the fuel filler flap
- printed in yellow on the rim of the emergency/collapsible spare wheel (depending on vehicle equipment)

Underinflated or overinflated tires

Underinflation

WARNING

Tires with pressure that is too low can overheat and burst as a consequence. In addition, they also suffer from excessive and/or irregular wear, which can severely impair the braking properties and the driving characteristics. There is a risk of an accident.

Avoid tire pressures that are too low in all the tires, including the spare wheel.

Underinflated tires may:

- overheat, leading to tire defects
- have an adverse effect on handling characteristics
- wear quickly and unevenly
- have an adverse effect on fuel consumption

Overinflation

WARNING

Tires with excessively high pressure can burst because they are damaged more easily by road debris, potholes etc. In addition, they also suffer from irregular wear, which can severely impair the braking properties and the driving characteristics. There is a risk of an accident.

Avoid tire pressures that are too high in all the tires, including the spare wheel.

Overinflated tires may:

- increase the braking distance
- have an adverse effect on handling characteristics
- wear quickly and unevenly
- have an adverse effect on ride comfort
- be more susceptible to damage

Maximum tire pressures



- ① Example: maximum permissible tire pressure

Never exceed the maximum permissible tire inflation pressure. Always observe the recommended tire pressure for your vehicle when adjusting the tire pressure (▷ page 402).

- i** The actual values for tires are vehicle-specific and may deviate from the values in the illustration.

Checking the tire pressures

Important safety notes

Observe the notes on tire pressure (▷ page 402).

Information on air pressure for the tires on your vehicle can be found:

- on the vehicle's Tire and Loading Information placard loading information table on the B-pillar (▷ page 410)
- on the tire pressure label on the fuel filler flap
- in the "Tire pressure" section
- under "Tire pressure" (▷ page 402)

Checking tire pressures manually

To determine and set the correct tire pressure, proceed as follows:

- ▶ Remove the valve cap of the tire that is to be checked.
- ▶ Press the tire pressure gauge securely onto the valve.
- ▶ Read the tire pressure and compare it with the recommended value on the Tire and Loading Information placard (▷ page 402).
- ▶ If the tire pressure is too low, increase it to the recommended value.
- ▶ If the tire pressure is too high, release air by pressing down the metal pin in the valve. Use the tip of a pen, for example. Then, check the tire pressure again using the tire pressure gauge.
- ▶ Screw the valve cap onto the valve.
- ▶ Repeat these steps for the other tires.

Tire pressure loss warning system (Canada only)

General notes

While the vehicle is in motion, the tire pressure loss warning system monitors the set tire pressure using the rotational speed of the wheels. This enables the system to detect significant pressure loss in a tire. If the speed of rotation of a wheel changes as a result of a loss of pressure, a corresponding warning message will appear in the multifunction display.

You can recognize the tire pressure loss warning by the **Run Flat Indicator Active Press 'OK' to Restart** message which appears in the **Serv.** menu of the multifunction display. Information on the message display can be found under "Restarting the tire pressure loss warning system" (▷ page 406).

Important safety notes

The tire pressure warning system does not warn you of an incorrectly set tire pressure. Observe the notes on the recommended tire pressure (▷ page 402).

The tire pressure loss warning does not replace the need to regularly check the tire pressure. An even loss of pressure on several tires at the same time cannot be detected by the tire pressure loss warning system.

The tire pressure monitor is not able to warn you of a sudden loss of pressure, e.g. if the tire is penetrated by a foreign object. In the event of a sudden loss of pressure, bring the vehicle to a halt by braking carefully. Avoid abrupt steering maneuvers.





The function of the tire pressure loss warning system is limited or delayed if:

- snow chains are mounted on your vehicle's tires.
- road conditions are wintry.
- you are driving on sand or gravel.





- you adopt a very sporty driving style (cornering at high speeds or driving with high rates of acceleration).
- you are towing a very heavy or large trailer.
- you are driving with a heavy load (in the vehicle or on the roof).

Restarting the tire pressure loss warning system





Restart the tire pressure loss warning system if you have:

- changed the tire pressure
 - changed the wheels or tires
 - mounted new wheels or tires
- ▶ Before restarting, make sure that the tire pressures are set properly on all four tires for the respective operating conditions. The recommended tire pressures can be found on the Tire and Loading Information placard on the B-pillar on the driver's side or the tire pressure table on the fuel filler flap.
- The tire pressure loss warning system can only give reliable warnings if you have set the correct tire pressure. If an incorrect tire pressure is set, these incorrect values will be monitored.
- ▶ Also observe the notes in the section on tire pressures (▷ page 402).
 - ▶ Make sure that the SmartKey is in position **2** in the ignition lock (▷ page 157).
 - ▶ Press the  or  button on the steering wheel to select the **Serv.** menu.
 - ▶ Press the  or  button to select **Tire Pressure**.
 - ▶ Press the  button. The **Run Flat Indicator active Restart with OK** message appears in the multifunction display.

If you wish to confirm the restart:

- ▶ Press the  button. The **Tire Pressure Now OK?** message appears in the multifunction display.
 - ▶ Press the  or  button to select **Yes**.
 - ▶ Press the  button. The **Run Flat Indicator Restarted** message appears in the multifunction display.
- After a teach-in period, the tire pressure loss warning system will monitor the set tire pressures of all four tires.

If you wish to cancel the restart:

- ▶ Press the  button.
- or
- ▶ If the **Tire Pressure Now OK?** message appears, use the  or  button to select **Cancel**.
 - ▶ Press the  button. The tire pressure values stored at the last restart will continue to be monitored.

Tire pressure monitor

General notes

If a tire pressure monitor is installed, the vehicle's wheels have sensors that monitor the tire pressures in all four tires. The tire pressure monitor warns you if the pressure drops in one or more of the tires. The tire pressure monitor only functions if the correct sensors are installed on all wheels.

Information on tire pressures is displayed in the multifunction display. After a few minutes of driving, the current tire pressure of each tire is shown in the **Serv.** menu of the multifunction display. For further information on displaying this message, refer to the "Checking the tire pressure electronically" section (▷ page 408).



Example: current tire pressure display

Important safety notes

WARNING

Each tire, including the spare (if provided), should be checked at least once a month when cold and inflated to the pressure recommended by the vehicle manufacturer on the Tire and Loading Information placard on the driver's door B-pillar or the tire pressure label on the inside of the fuel filler flap. If your vehicle has tires of a different size than the size indicated on the Tire and Loading Information placard or the tire pressure label, you should determine the proper tire pressure for those tires.

As an added safety feature, your vehicle has been equipped with a tire pressure monitoring system (TPMS) that illuminates a low tire pressure telltale when one or more of your tires are significantly underinflated.

Accordingly, when the low tire pressure telltale illuminates, you should stop and check your tires as soon as possible, and inflate them to the proper pressure. Driving on a significantly underinflated tire causes the tire to overheat and can lead to tire failure.

Underinflation also reduces fuel efficiency and tire tread life, and may affect the vehicle's handling and stopping ability.

Please note that the TPMS is not a substitute for proper tire maintenance, and it is the driver's responsibility to maintain correct tire pressure, even if underinflation has not reached the level to trigger illumination of the TPMS low tire pressure telltale.

USA only:

Your vehicle has also been equipped with a TPMS malfunction indicator to indicate if the

system is not operating properly. The TPMS malfunction indicator is combined with the low tire pressure telltale. When the system detects a malfunction, the warning lamp will flash for approximately a minute and then remain continuously illuminated. This sequence will be repeated every time the vehicle is started as long as the malfunction exists.

When the malfunction indicator is illuminated, the system may not be able to detect or signal low tire pressure as intended. TPMS malfunctions may occur for a variety of reasons, including the installation of incompatible replacement or alternate tires or wheels on the vehicle that prevent the TPMS from functioning properly. Always check the TPMS malfunction telltale after replacing one or more tires or wheels on your vehicle to ensure that the replacement or alternate tires and wheels allow the TPMS to continue to function properly.

It is the driver's responsibility to set the tire pressure to that recommended for cold tires which is suitable for the operating situation (> page 402). Note that the correct tire pressure for the current operating situation must first be taught-in to the tire pressure monitor. If there is a substantial loss of pressure, the warning threshold for the warning message is aligned to the reference values taught-in. Restart the tire pressure monitor after adjusting the pressure of the cold tires (> page 409). The current pressures are saved as new reference values. As a result, a warning message will appear if the tire pressure drops significantly.

The tire pressure monitor does not warn you of an incorrectly set tire pressure. Observe the notes on the recommended tire pressure (> page 402).

The tire pressure monitor is not able to warn you of a sudden loss of pressure, e.g. if the tire is penetrated by a foreign object. In the event of a sudden loss of pressure, bring the

vehicle to a halt by braking carefully. Avoid abrupt steering maneuvers.

The tire pressure monitor has a yellow warning lamp in the instrument cluster for indicating pressure loss/malfunctions (USA) or pressure loss (Canada). Whether the warning lamp flashes or lights up indicates whether a tire pressure is too low or the tire pressure monitor is malfunctioning:





- if the warning lamp is lit continuously, the tire pressure on one or more tires is significantly too low. The tire pressure monitor is not malfunctioning.
- USA only: if the warning lamp flashes for around a minute and then remains lit constantly, the tire pressure monitor is malfunctioning.

USA only: if there is a malfunction with the tire pressure monitor it can take more than ten minutes until the malfunction is shown by the tire pressure warning lamp flashing for approximately one minute and then lighting up continuously. When the malfunction has been rectified, the tire pressure warning lamp goes out after a few minutes of driving.

The tire pressure values indicated by the on-board computer may differ from those measured at a gas station with a pressure gauge. The tire pressures shown by the on-board computer refer to those measured at sea level. At high altitudes, the tire pressure values indicated by a pressure gauge are higher than those shown by the on-board computer. In this case, do not reduce the tire pressures.

The operation of the tire pressure monitor can be affected by interference from radio transmitting equipment (e.g. radio headphones, two-way radios) that may be being operated in or near the vehicle.

Checking the tire pressure electronically

- ▶ Make sure that the SmartKey is in position **2** in the ignition lock (> page 157).
- ▶ Press the  or  button on the steering wheel to select the **Service** menu.
- ▶ Press the  or  button to select **Tire Pressure**.
- ▶ Press the  button.

The current tire pressure of each tire is shown in the multifunction display.

If the vehicle has been parked for longer than 20 minutes, the **Tire pressure will be displayed after driving a few minutes** message appears.

After a teach-in process, the tire pressure monitor automatically detects new wheels or new sensors. As long as a clear allocation of the tire pressure value to the individual wheels is not possible, the **Tire Pressure Monitor Active** display message is shown instead of the tire pressure display. The tire pressures are already being monitored.

- i** If an emergency spare wheel is mounted, the system may continue to show the tire pressure of the wheel that has been removed for a few minutes. If this occurs, note that the value displayed for the position where the spare wheel is mounted is not the same as the current tire pressure of the emergency spare wheel.

Tire pressure monitor warning messages

If the tire pressure monitor detects a pressure loss in one or more tires, a warning message is shown in the multifunction display. A warning tone also sounds and the tire pressure warning lamp lights up in the instrument cluster. Each tire that is affected by a significant loss of pressure is highlighted in the pressure display.

- If the **Correct Tire Pressure** message appears in the multifunction display, the tire pressure in at least one tire is too low and must be corrected at the next opportunity.
 - If the **Check Tires** message appears in the multifunction display, the tire pressure in one or more tires has dropped significantly and the tires must be checked.
 - If the **Warning Tire Malfunction** message appears in the multifunction display, the tire pressure in one or more tires has dropped suddenly and the tires must be checked.
- i** If the wheel positions on the vehicle are rotated, the tire pressures may be displayed for the wrong positions for a short time. This is rectified after a few minutes of driving, and the tire pressures are displayed for the correct positions.

Restarting the tire pressure monitor

When you restart the tire pressure monitor, all existing warning messages are deleted and the warning lamps go out. The monitor uses the currently set tire pressures as the reference values for monitoring. In most cases, the tire pressure monitor will automatically detect the new reference values after you have changed the tire pressure. However, you can also define reference values manually as described here. The tire pressure monitor then monitors the new tire pressure values.

- ▶ Set the tire pressure to the value recommended for the corresponding driving situation on the Tire and Loading Information placard on the B-pillar on the driver's side (▷ page 402).
Additional tire pressure values for different loads can also be found on the tire pressure table on the inside of the fuel filler flap (▷ page 174).
- ▶ Make sure that the tire pressure is correct on all four wheels.
- ▶ Make sure that the SmartKey is in position **2** in the ignition lock.
- ▶ Press the ◀ or ▶ button on the steering wheel to select the **Serv.** menu.
- ▶ Press the ▲ or ▼ button to select **Tire Pressure**.
- ▶ Press the **OK** button.
The multifunction display shows the current tire pressure for the individual tires or the **Tire pressure will be displayed after driving a few minutes** message.
- ▶ Press the ▼ button.
The **Use current pressures as new reference values** message appears in the multifunction display.

If you wish to confirm the restart:

- ▶ Press the **OK** button.
The **Tire Press. Monitor Restarted** message appears in the multifunction display.

After driving for a few minutes, the system checks whether the current tire pressures are within the specified range. The new tire pressures are then accepted as reference values and monitored.

If you wish to cancel the restart:

- ▶ Press the ↩ button.
The tire pressure values stored at the last restart will continue to be monitored.

Loading the vehicle

Instruction labels for tires and loads

WARNING

Overloaded tires can overheat, causing a blowout. Overloaded tires can also impair the steering and driving characteristics and lead to brake failure. There is a risk of accident.

Observe the load rating of the tires. The load rating must be at least half of the GAWR of your vehicle. Never overload the tires by exceeding the maximum load.

Two instruction labels on your vehicle show the maximum possible load.

- (1) The Tire and Loading Information placard is on the B-pillar on the driver's side. The Tire and Loading Information placard shows the maximum permissible number of occupants and the maximum permissible vehicle load. It also contains details of the tire sizes and corresponding pressures for tires mounted at the factory.
- (2) The vehicle identification plate is on the B-pillar on the driver's side. The vehicle identification plate informs you of the gross vehicle weight rating. It is made up of the vehicle weight, all vehicle occupants, the fuel and the cargo. You can also find information about the maximum gross axle weight rating on the front and rear axle.

The maximum gross axle weight rating is the maximum weight that can be carried by one axle (front or rear axle). Never exceed the maximum load or the maximum gross axle weight rating for the front or rear axle.



① B-pillar, driver's side

Maximum permissible gross vehicle weight rating

| TIRE | | LOADING INFORMATION | |
|----------------|--------------------|--------------------------------|--------|
| RENSEIGNEMENTS | | SUR LES PNEUS ET LE CHARGEMENT | |
| TIRES | RECHARGEMENT | POIDS MAXI | CHARGE |
| FRONT | 236/40 ZR19 99Y XL | 200 kPa, 29 PSI | |
| REAR | 275/35 ZR19 01Y XL | 200 kPa, 29 PSI | |
| SHOCK | 175/55-16 95P | 420 kPa, 60 PSI | |

| VEHICLE IDENTIFICATION | |
|-------------------------------------|--------------------|
| RENSEIGNEMENTS | |
| VEHICLE WEIGHT | 1500 kg (3300 lbs) |
| MAXIMUM GROSS VEHICLE WEIGHT RATING | 2000 kg (4400 lbs) |
| MAXIMUM GROSS AXLE WEIGHT RATING | 1000 kg (2200 lbs) |

P40.00-2206-31

- Specification for maximum gross vehicle weight ① is listed in the Tire and Loading Information placard: "The combined weight of occupants and cargo should never exceed XXX kilograms or XXX lbs."

The gross weight of all vehicle occupants, load and luggage must not exceed the specified value.

- ① The specifications shown on the Tire and Loading Information placard in the illustration are examples. The maximum permissible gross vehicle weight rating is vehicle-specific and may differ from that in the illustration. You can find the valid

maximum permissible gross vehicle weight rating for your vehicle on the Tire and Loading Information placard.

Number of seats

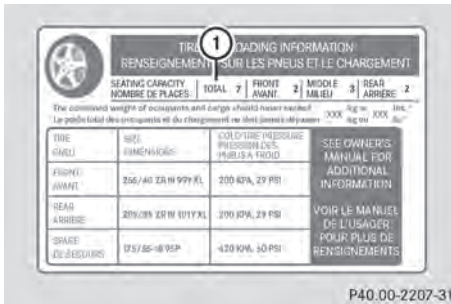

Maximum number of seats ① indicates the maximum number of occupants allowed to travel in the vehicle. This information can be found on the Tire and Loading Information placard.

i The specifications shown on the Tire and Loading Information placard in the illustration are examples. The number of seats is vehicle-specific and can differ from the details shown. The number of seats in your vehicle can be found on the Tire and Loading Information placard.

Determining the correct load limit

Step-by-step instructions

The following steps have been developed as required of all manufacturers under Title 49, Code of U.S. Federal Regulations, Part 575 pursuant to the "National Traffic and Motor Vehicle Safety Act of 1966".

► **Step 1:** Locate the statement "The combined weight of occupants and cargo should never exceed XXX kg or XXX lbs."

your vehicle's Tire and Loading Information placard.

► **Step 2:** Determine the combined weight of the driver and passengers that will be riding in your vehicle.

► **Step 3:** Subtract the combined weight of the driver and passengers from XXX kilograms or XXX lbs.

► **Step 4:** The resulting figure equals the available amount of cargo and luggage load capacity. For example, if the "XXX" amount equals 1,400 lbs and there will be five 150 lbs passengers in your vehicle, the amount of available cargo and luggage load capacity is 650 lbs (1,400 – 750 (5 x 150) = 650 lbs).

► **Step 5:** Determine the combined weight of luggage and cargo being loaded on the vehicle. That weight may not safely exceed the available cargo and luggage load capacity calculated in step 4.

Example: steps 1 to 3

The following table shows examples on how to calculate total and cargo load capacities with varying seating configurations and number and size of occupants. The following examples use a maximum load of 1,500 lbs (680 kg). **This is for illustration purposes only.** Make sure you are using the actual load limit for your vehicle stated on your vehicle's Tire and Loading Information placard (▷ page 410).

The greater the combined weight of the occupants, the lower the maximum luggage load. Additional information when towing a trailer (▷ page 253).

Step 1

| | Example 1 | Example 2 | Example 3 |
|--|-------------------|-------------------|-------------------|
| Combined maximum weight of occupants and cargo (data from the Tire and Loading Information placard) | 1500 lbs (680 kg) | 1500 lbs (680 kg) | 1500 lbs (680 kg) |

Step 2

| | Example 1 | Example 2 | Example 3 |
|---|--|--|--------------------------------|
| Number of people in the vehicle (driver and occupants) | 5 | 3 | 1 |
| Distribution of the occupants | Front: 2 Rear: 3 | Front: 1 Rear: 2 | Front: 1 |
| Weight of the occupants | Occupant 1: 150 lbs (68 kg) Occupant 2: 180 lbs (82 kg) Occupant 3: 160 lbs (73 kg) Occupant 4: 140 lbs (63 kg) Occupant 5: 120 lbs (54 kg) | Occupant 1: 200 lbs (91 kg) Occupant 2: 190 lbs (86 kg) Occupant 3: 150 lbs (68 kg) | Occupant 1: 150 lbs (68 kg) |
| Gross weight of all occupants | 750 lbs (340 kg) | 540 lbs (245 kg) | 150 lbs (68 kg) |

Step 3

| | Example 1 | Example 2 | Example 3 |
|---|--|--|--|
| Permissible load (maximum gross vehicle weight rating from the Tire and Loading Information placard minus the gross weight of all occupants) | 1500 lbs (680 kg) -750 lbs (340 kg) = 750 lbs (340 kg) | 1500 lbs (680 kg) -540 lbs (245 kg) = 960 lbs (435 kg) | 1500 lbs (680 kg) -150 lbs (68 kg) = 1350 lbs (612 kg) |

Vehicle identification plate

Even if you have calculated the total cargo carefully, you should still make sure that the gross vehicle weight rating and the gross axle weight rating are not exceeded. Details can be found on the vehicle identification plate on the B-pillar on the driver's side of the vehicle (► page 410).

Permissible gross vehicle weight: the gross weight of the vehicle, all passengers, load and trailer load/noseweight (if applicable) must not exceed the permissible gross vehicle weight.

Gross axle weight rating: the maximum permissible weight that can be carried by one axle (front or rear axle).

To ensure that your vehicle does not exceed the maximum permissible values (gross vehicle weight and maximum gross axle weight rating), have your loaded vehicle (including driver, occupants, cargo, and full trailer load if applicable) weighed on a suitable vehicle weighbridge.

Trailer load/noseweight

The trailer load/noseweight affects the gross weight of the vehicle. If a trailer is attached, the trailer load/noseweight is included in the load along with occupants and luggage. The trailer load/noseweight is usually approximately 8% of the gross weight of the trailer and its cargo.

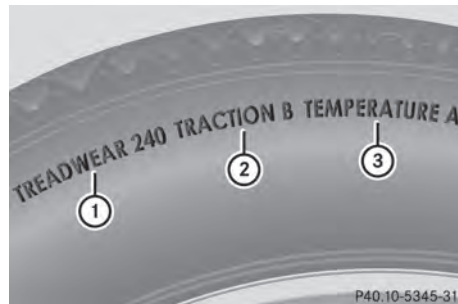
All about wheels and tires**Uniform Tire Quality Grading Standards****Overview of Tire Quality Grading Standards**

Uniform Tire Quality Grading Standards are U.S. government specifications. Their purpose is to provide drivers with uniform reliable information on tire performance data. Tire manufacturers have to grade tires using three performance factors: ① tread wear grade, ② traction grade and ③ temperature grade. These regulations do not apply to Canada. Nevertheless, all tires sold in North America are provided with the corresponding quality grading markings on the sidewall of the tire.

Where applicable, the tire grading information can be found on the tire sidewall between the tread shoulder and maximum tire width.

Example:

- **Treadwear grade:** 200
- **Traction grade:** AA
- **Temperature grade:** A

All passenger car tires must conform to the statutory safety requirements in addition to these grades.

- i** The actual values for tires are vehicle-specific and may deviate from the values in the illustration.

Treadwear

The treadwear grade is a comparative rating based on the wear rate of the tire when tested under controlled conditions on a specified U.S. government course. For example, a tire graded 150 would wear one and one-half times as well on the government test track as a tire graded 100.

The relative performance of tires depends upon the actual conditions of their use, however, and may depart significantly from the norm, due to variations in driving habits, service practices and differences in road characteristics and climate conditions.

Traction

WARNING

The traction grade assigned to this tire is based on straight-ahead braking traction tests, and does not include acceleration, cornering, hydroplaning, or peak traction characteristics.

- !** Avoid wheelspin. This can lead to damage to the drive train.

The traction grades, from highest to lowest, are AA, A, B, and C. Those grades represent the tire's ability to stop on a wet surface as measured under controlled conditions on specified government test surfaces of asphalt and concrete. A tire marked C may have poor traction performance.

The safe speed on a wet, snow covered or icy road is always lower than on dry road surfaces.

You should pay special attention to road conditions when temperatures are around freezing point.

Mercedes-Benz recommends a minimum tread depth of $\frac{1}{8}$ in (4 mm) on all four winter tires. Observe the legally required minimum tire tread depth (▷ page 399). Winter tires can reduce the braking distance on snow-covered surfaces in comparison with summer tires. The braking distance is still much further than on surfaces that are not icy or covered with snow. Take appropriate care when driving. Further information on winter tires (M+S tires) (▷ page 400).

Temperature

WARNING

The temperature grade for this tire is established for a tire that is properly inflated and not overloaded. Excessive speed, underinflation, or excessive loading, either separately or in combination, can cause excessive heat build-up and possible tire failure.

The temperature grades are A (the highest), B, and C. These represent the tire's resistance to the generation of heat and its ability to dissipate heat when tested under controlled conditions on a specified indoor laboratory test wheel. Sustained high temperature can cause the material of the tire to degenerate and reduce tire life, and excessive temperature can lead to sudden tire failure. The grade C corresponds to a level of performance which all passenger car tires must meet under the Federal Motor Vehicle Safety Standard No. 109. Grades B and A represent higher levels of performance on the laboratory test wheel than the minimum required by law.

Tire labeling

Overview

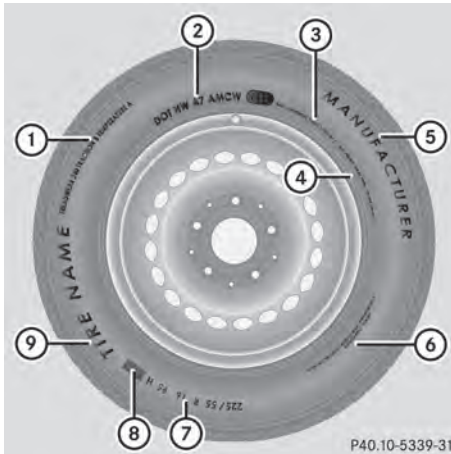

- ① Uniform Tire Quality Grading Standard (▷ page 419)
- ② DOT, Tire Identification Number (▷ page 418)
- ③ Maximum tire load (▷ page 417)
- ④ Maximum tire pressure (▷ page 404)
- ⑤ Manufacturer
- ⑥ Tire material (▷ page 418)
- ⑦ Tire size designation, load-bearing capacity and speed index (▷ page 415)
- ⑧ Load index (▷ page 417)
- ⑨ Tire name

The markings described above are on the tire in addition to the tire name (sales designation) and the manufacturer's name.

- ❗ Tire data is vehicle-specific and may deviate from the data in the example.

Tire size designation, load-bearing capacity and speed rating

⚠ WARNING

Exceeding the stated tire load-bearing capacity and the approved maximum speed could lead to tire damage or the tire bursting. There is a risk of accident.

Therefore, only use tire types and sizes approved for your vehicle model. Observe the tire load rating and speed rating required for your vehicle.



- ① Tire width
- ② Nominal aspect ratio in %
- ③ Tire code
- ④ Rim diameter
- ⑤ Load bearing index
- ⑥ Speed rating

General: depending on the manufacturer's standards, the size imprinted in the tire wall may not contain any letters or may contain one letter that precedes the size description.

If there is no letter preceding the size description (as shown above): these are passenger vehicle tires according to European manufacturing standards.

If "P" precedes the size description: these are passenger vehicle tires according to U.S. manufacturing standards.

If "LT" precedes the size description: these are light truck tires according to U.S. manufacturing standards.

If "T" precedes the size description: these are compact emergency spare wheels at high tire pressure, to be used only temporarily in an emergency.

Tire width: tire width ① shows the nominal tire width in millimeters.

Height-width ratio: aspect ratio ② is the size ratio between the tire height and tire width and is shown as a percentage. The

aspect ratio is calculated by dividing the tire width by the tire height.

Tire code: tire code ③ specifies the tire type. "R" represents radial tires; "D" represents diagonal tires; "B" represents diagonal radial tires.

Optionally, tires with a maximum speed of over 149 mph (240 km/h) may have "ZR" in the size description, depending on the manufacturer (e.g. 245/40 ZR 18).

Rim diameter: rim diameter ④ is the diameter of the bead seat, not the diameter of the rim flange. The rim diameter is specified in inches (in).

Load-bearing index: load-bearing index ⑤ is a numerical code that specifies the maximum load-bearing capacity of a tire.

Do not overload the tires by exceeding the specified load limit. The maximum permissible load can be found on the vehicle's Tire and Loading Information placard on the B-pillar on the driver's side (▷ page 410).

Example:

The load bearing index 91 indicates a maximum load of 1356 lb (615 kg) that the tires can bear. For further information on the maximum tire load in kilograms and pounds, see (▷ page 417).

For further information on the load bearing index, see "Load index" (▷ page 417).

Speed rating: speed rating ⑥ specifies the approved maximum speed of the tire.

- ❗ Tire data is vehicle-specific and may deviate from the data in the example.

Regardless of the speed rating, always observe the speed limits. Drive carefully and adapt your driving style to the traffic conditions.

Summer tires

| Index | Speed rating |
|-------|--------------------------|
| Q | up to 100 mph (160 km/h) |
| R | up to 106 mph (170 km/h) |

| Index | Speed rating |
|------------|--------------------------|
| S | up to 112 mph (180 km/h) |
| T | up to 118 mph (190 km/h) |
| H | up to 130mph (210 km/h) |
| V | up to 149 mph (240 km/h) |
| W | up to 168 mph (270 km/h) |
| Y | up to 186 mph (300 km/h) |
| ZR...Y | up to 186 mph (300 km/h) |
| ZR...(..Y) | over 186 mph (300 km/h) |
| ZR | over 149 mph (240 km/h) |

- Optionally, tires with a maximum speed of over 149 mph (240 km/h) may have a "ZR" in the size description, depending on the manufacturer (e.g. 245/40 ZR18). The service specification is made up of load-bearing index ⑤ and speed rating ⑥.
- If the size description of your tire includes "ZR" and there are no service specifications, ask the tire manufacturer in order to find out the maximum speed. If a service specification is available, the maximum speed is limited according to the speed rating in the service specification. Example: 245/40 ZR 18 97 Y. In this example, "97 Y" is the service specification. The letter "Y" represents the speed rating and the maximum speed of the tire is limited to 186 mph (300km/h).
- Every tire that has a maximum speed of more than 186 mph (300 km/h) must have a "ZR" in the size description **and** the service specification must be given in parentheses. Example: 275/40 ZR 18 (99 Y). The speed rating "(Y)" indicates that the maximum speed of the tire is over 186 mph (300 km/h). Ask the tire manufacturer about the maximum speed.

All-weather tires and winter tires

| Index | Speed rating |
|--------------------|--------------------------|
| Q M+S ² | up to 100 mph (160 km/h) |
| T M+S ² | up to 118 mph (190 km/h) |
| H M+S ² | up to 130 mph (210 km/h) |
| V M+S ² | up to 149 mph (240 km/h) |

i Not all tires with the M+S marking provide the driving characteristics of winter tires. In addition to the M+S marking, winter tires also have the  snowflake symbol on the tire wall. Tires with this marking fulfill the requirements of the Rubber Manufacturers Association (RMA) and the Rubber Association of Canada (RAC) regarding the tire traction on snow. They have been especially developed for driving on snow.

An electronic speed limiter prevents your vehicle from exceeding the following speeds:

- all vehicles (except AMG vehicles): 130 mph (210 km/h)
- AMG vehicles: 155 mph (250 km/h)
- AMG vehicles with increased top speed: 174 mph (280 km/h)
-

The speed rating of tires mounted at the factory may be higher than the maximum speed that the electronic speed limiter permits.

Make sure that your tires have the required speed rating, e.g. when buying new tires. The required speed rating for your vehicle can be found in the "Tires" section (▷ page 426).

Further information about reading tire data can be obtained from any qualified specialist workshop.

² or M+S  for winter tires.

Load index



In addition to the load bearing index, load index **①** may be imprinted after the letters that identify the speed index **⑥** on the sidewall of the tire (▷ page 415).

- If no specification is given: no text (as in the example above), represents a standard load (SL) tire
- XL or Extra Load: represents a reinforced tire
- Light Load: represents a light load tire
- C, D, E: represents a load range that depends on the maximum load that the tire can carry at a certain pressure

i Tire data is vehicle-specific and may deviate from the data in the example.

Maximum load rating



Maximum tire load **①** is the maximum permissible weight for which the tire is approved.

Do not overload the tires by exceeding the specified load limit. The maximum permissible load can be found on the vehicle's Tire and Loading Information placard on the B-pillar on the driver's side (▷ page 410).

- i** The actual values for tires are vehicle-specific and may deviate from the values in the illustration.

DOT, Tire Identification Number (TIN)

U.S. tire regulations prescribe that every tire manufacturer or retreader must imprint a TIN in or on the sidewall of every tire produced.

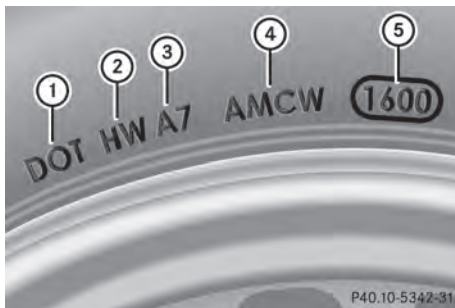

The TIN is a unique identification number. The TIN enables the tire manufacturers or retreaders to inform purchasers of recalls and other safety-relevant matters. It makes it possible for the purchaser to easily identify the affected tires.

The TIN is made up of manufacturer identification code (2), tire size (3), tire type code (4) and manufacturing date (5).

DOT (Department of Transportation): tire symbol (1) indicates that the tire complies with the requirements of the U.S. Department of Transportation.

Manufacturer identification code: manufacturer identification code (2) provides details on the tire manufacturer. New tires have a code with two symbols. Retreaded tires have a code with four symbols.

For further information about retreaded tires, see (▷ page 426).

Tire size: identifier (3) describes the tire size.

Tire type code: tire type code (4) can be used by the manufacturer as a code to describe specific characteristics of the tire.

Date of manufacture: date of manufacture (5) provides information about the age of a tire. The first and second positions represent the week of manufacture, starting with "01" for the first calendar week. Positions three and four represent the year of manufacture. For example, a tire that is marked with "3208", was manufactured in week 32 in 2008.

- i** Tire data is vehicle-specific and may deviate from the data in the example.

Tire characteristics



This information describes the type of tire cord and the number of layers in sidewall (1) and under tire tread (2).

- i** Tire data is vehicle-specific and may deviate from the data in the example.

Definition of terms for tires and loading

Tire ply composition and material used

Describes the number of plies or the number of layers of rubber-coated fabric in the tire tread and sidewall. These are made of steel, nylon, polyester and other materials.

Bar

Metric unit for tire pressure.

14.5038 pounds per square inch (psi) and

100 kilopascals (kPa) are the equivalent of 1 bar.

DOT (Department of Transportation)

DOT marked tires fulfill the requirements of the United States Department of Transportation.

Normal occupant weight

The number of occupants which the vehicle is designed for, multiplied by 68 kilograms (150 lb).

Uniform Tire Quality Grading Standards

A uniform standard to grade the quality of tires with regards to tread quality, tire traction and temperature characteristics. Ratings are determined by tire manufacturers using U.S. government testing procedures. The ratings are molded into the sidewall of the tire.

Recommended tire pressure

The recommended tire pressure applies to the tires mounted at the factory.

The Tire and Loading Information placard contains the recommended tire pressures for cold tires on a fully loaded vehicle and for the maximum permissible vehicle speed.

The tire pressure table contains the recommended pressures for cold tires for various operating conditions, i.e. differing load and speed conditions.

Increased vehicle weight due to optional equipment

This is the combined weight of all standard and optional equipment available for the vehicle, regardless of whether it is actually installed on the vehicle or not.

Rim

This is the part of the wheel on which the tire is mounted.

GAWR (Gross Axle Weight Rating)

The GAWR is the maximum gross axle weight rating. The actual load on an axle must never exceed the gross axle weight rating. The gross axle weight rating can be found on the

vehicle identification plate on the B-pillar on the driver's side.

Speed rating

The speed rating is part of the tire identification. It specifies the speed range for which the tire is approved.

GTW (Gross Trailer Weight)

The GTW is the weight of a trailer including the weight of the load, luggage, accessories etc. on the trailer.

GVW (Gross Vehicle Weight)

The gross vehicle weight includes the weight of the vehicle including fuel, tools, the spare wheel, accessories installed, occupants, luggage and the drawbar noseweight, if applicable. The gross vehicle weight must not exceed the gross vehicle weight rating GVWR as specified on the vehicle identification plate on the B-pillar on the driver's side.

GVWR (Gross Vehicle Weight Rating)

The GVWR is the maximum permissible gross weight of a fully loaded vehicle (the weight of the vehicle including all accessories, occupants, fuel, luggage and the drawbar noseweight, if applicable). The gross vehicle weight rating is specified on the vehicle identification plate on the B-pillar on the driver's side.

Maximum loaded vehicle weight

The maximum weight is the sum of:

- the curb weight of the vehicle
- the weight of the accessories
- the load limit
- the weight of the factory installed optional equipment

Kilopascal (kPa)

Metric unit for tire pressure. 6.9 kPa corresponds to 1 psi. Another unit for tire pressure is bar. There are 100 kilopascals (kPa) to 1 bar.

Load index

In addition to the load-bearing index, the load index may also be imprinted on the sidewall of the tire. This specifies the load-bearing capacity more precisely.

Curb weight

The weight of a vehicle with standard equipment including the maximum capacity of fuel, oil and coolant. It also includes the air-conditioning system and optional equipment if these are installed in the vehicle, but does not include passengers or luggage.

Maximum load rating

The maximum tire load is the maximum permissible weight in kilograms or lbs for which a tire is approved.

Maximum permissible tire pressure

Maximum permissible tire pressure for one tire.

Maximum load on one tire

Maximum load on one tire. This is calculated by dividing the maximum axle load of one axle by two.

PSI (pounds per square inch)

A standard unit of measure for tire pressure.

Aspect ratio

Relationship between tire height and tire width in percent.

Tire pressure

This is pressure inside the tire applying an outward force to each square inch of the tire's surface. The tire pressure is specified in pounds per square inch (psi), in kilopascal (kPa) or in bar. The tire pressure should only be corrected when the tires are cold.

Cold tire pressure

The tires are cold:

- if the vehicle has been parked without direct sunlight on the tires for at least three hours and
- if the vehicle has been driven for less than 1 mile (1.6 km).

Tread

The part of the tire that comes into contact with the road.

Bead

The tire bead ensures that the tire sits securely on the wheel. There are several steel wires in the bead to prevent the tire from coming loose from the wheel rim.

Sidewall

The part of the tire between the tread and the bead.

Weight of optional extras

The combined weight of those optional extras that weigh more than the replaced standard parts and more than 2.3 kilograms (5 lbs). These optional extras, such as high-performance brakes, level control, a roof rack or a high-performance battery, are not included in the curb weight and the weight of the accessories.

TIN (Tire Identification Number)

This is a unique identifier which can be used by a tire manufacturer to identify tires, for example for a product recall, and thus identify the purchasers. The TIN is made up of the manufacturer's identity code, tire size, tire type code and the manufacturing date.

Load bearing index

The load bearing index (also load index) is a code that contains the maximum load bearing capacity of a tire.

Traction

Traction is the result of friction between the tires and the road surface.

TWR (Tongue Weight Rating)

The TWR specifies the maximum permissible weight that the ball coupling of the trailer tow hitch can support.

Treadwear indicators

Narrow bars (tread wear bars) that are distributed over the tire tread. If the tire tread is level with the bars, the wear limit of $\frac{1}{16}$ in (1.6 mm) has been reached.

Occupant distribution

The distribution of occupants in a vehicle at their designated seating positions.

Total load limit

Rated cargo and luggage load plus 68 kilograms (150 lb) multiplied by the number of seats in the vehicle.

Changing a wheel

Flat tire

You can find information on what to do in the event of a flat tire in the "Breakdown assistance" section (▷ page 381).

Information on driving with MOExtended tires in the event of a flat tire can be found under "MOExtended tires (tires with run-flat characteristics)" (▷ page 382).

The "Breakdown assistance" section (▷ page 381) contains information and notes on how to deal with a flat tire. Information on driving with MOExtended tires in the event of a flat tire can be found under "MOExtended tires (tires with run-flat characteristics)" (▷ page 382).

Vehicles with an emergency spare

wheel: in the event of a flat tire, mount the emergency spare wheel according to the description under "Mounting a wheel" (▷ page 422).

Rotating the wheels

WARNING

Interchanging the front and rear wheels may severely impair the driving characteristics if the wheels or tires have different dimensions. The wheel brakes or suspension components may also be damaged. There is a risk of accident.

Rotate front and rear wheels only if the wheels and tires are of the same dimensions.

! On vehicles equipped with a tire pressure monitor, electronic components are located in the wheel.

Tire-mounting tools should not be used near the valve. This could damage the electronic components.

Only have tires changed at a qualified specialist workshop.

Always observe the instructions and safety notes in the "Mounting a wheel" section (▷ page 422).

The wear patterns on the front and rear tires differ, depending on the operating conditions. Rotate the wheels before a clear wear pattern has formed on the tires. Front tires typically wear more on the shoulders and the rear tires in the center.

If your vehicle's tire configuration allows, you can rotate the wheels according to the intervals in the tire manufacturer's warranty book in your vehicle documents. If this is not available, the tires should then be rotated every 3000 to 6000 miles (5000 to 10,000 km), or earlier if the tire wear requires this. Do not change the direction of wheel rotation.

Clean the contact surfaces of the wheel and the brake disc thoroughly every time a wheel is interchanged. Check the tire pressure and, if necessary, restart the tire pressure loss warning system or the tire pressure monitor.

Direction of rotation

Tires with a specified direction of rotation have additional benefits, e.g. if there is a risk of hydroplaning. You will only gain these benefits if the correct direction of rotation is observed.

An arrow on the sidewall of the tire indicates its correct direction of rotation.

Storing wheels

Store wheels that are not being used in a cool, dry and preferably dark place. Protect the tires from oil, grease, gasoline and diesel.

Cleaning the wheels

WARNING

The water jet from a circular jet nozzle (dirt blasters) can cause invisible exterior damage to the tires or chassis components.

Components damaged in this way may fail unexpectedly. There is a risk of an accident.

Do not use power washers with circular jet nozzles to clean the vehicle. Have damaged tires or chassis components replaced immediately.

Mounting a wheel

Preparing the vehicle

- ▶ **Vehicle with emergency spare wheel:** when mounting the emergency spare wheel in the event of a flat tire, follow the additional notes on vehicle preparation under "Flat tire" (▷ page 381).
- ▶ Park the vehicle on firm, non-slippery and level ground.
- ▶ Unload heavy luggage.
- ▶ Apply the electric parking brake manually.
- ▶ Bring the front wheels into the straight-ahead position.
- ▶ Shift the transmission to position **P**.

- ▶ **Vehicles with the AIRMATIC package:** make sure that highway level is selected (▷ page 209).
- ▶ Switch off the engine.
- ▶ **Vehicles without KEYLESS-GO:** remove the SmartKey from the ignition lock.
- ▶ **Vehicles with KEYLESS-GO:** open the driver's door. The on-board electronics have status **0**, which is the same as the SmartKey having been removed.
- ▶ **Vehicles with KEYLESS-GO:** remove the Start/Stop button from the ignition lock (▷ page 158).
- ▶ If included in the vehicle equipment, take the tire-change tool kit out of the vehicle.
- ▶ Secure the vehicle to prevent it from rolling away.

i Apart from certain country-specific variations, vehicles are not equipped with a tire-change tool kit. For information on which tools are required to perform a wheel change on your vehicle, consult an authorized Mercedes-Benz Center. Necessary wheel-changing tools can include, for example:

- Jack
- Wheel chock
- Lug wrench

Securing the vehicle to prevent it from rolling away

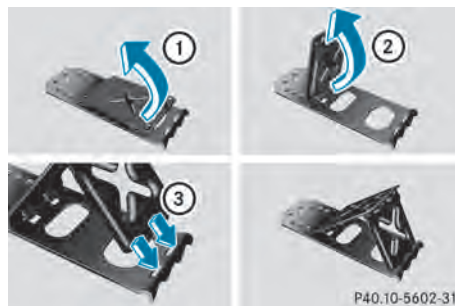

P40.10-5602-31

If your vehicle is equipped with a wheel chock, it can be found in the tire-change tool kit (▷ page 380).

The folding wheel chock is an additional securing measure to prevent the vehicle from rolling away, for example when changing a wheel.

- ▶ Fold both plates upwards ①.
- ▶ Fold out lower plate ②.
- ▶ Guide the lugs on the lower plate fully into the openings in base plate ③.



P40.00-2193-31

Securing the vehicle on level ground

- ▶ **On level ground:** place chocks or other suitable items under the front and rear of the wheel that is diagonally opposite the wheel you wish to change.



P40.00-2194-31

Securing the vehicle on slight downhill gradients

- ▶ **On light downhill gradients:** place chocks or other suitable items in front of the wheels of the front and rear axle.

Raising the vehicle

⚠ WARNING

If you do not position the jack correctly at the appropriate jacking point of the vehicle, the jack could tip over with the vehicle raised. There is a risk of injury.

Only position the jack at the appropriate jacking point of the vehicle. The base of the jack must be positioned vertically, directly under the jacking point of the vehicle.

❗ **AMG vehicles with "Minispare" emergency spare wheel:** use the "Minispare" emergency spare wheel **only on the rear axle**. If you mount the "Minispare" emergency spare wheel on the front axle, this could result in damage to the brake system.

If a tire on the front axle is defective, an intact wheel from the rear axle must first be replaced with the "Minispare" emergency spare wheel. The defective wheel on the front axle can then be replaced with the intact wheel from the rear axle.

Make sure to note the placard on the "Minispare" emergency spare wheel.

❗ The jack is designed exclusively for jacking up the vehicle at the jacking points. Otherwise, your vehicle could be damaged.

The following must be observed when raising the vehicle:

- to raise the vehicle, only use the vehicle-specific jack that has been tested and approved by Mercedes-Benz. If used incorrectly, the jack could tip over with the vehicle raised.
- the jack is designed only to raise and hold the vehicle for a short time while a wheel is being changed. It is not suited for performing maintenance work under the vehicle.
- avoid changing the wheel on uphill and downhill slopes.

- before raising the vehicle, secure it from rolling away by applying the parking brake and inserting wheel chocks. Never disengage the parking brake while the vehicle is raised.
- the jack must be placed on a firm, flat and non-slip surface. On a loose surface, a large, load-bearing underlay must be used. On a slippery surface, a non-slip underlay must be used, e.g. rubber mats.
- do not use wooden blocks or similar objects as a jack underlay. Otherwise, the jack will not be able to achieve its load-bearing capacity due to the restricted height.
- the maximum clearance between the underside of the tire and the ground must be 1.2 in (3 cm).
- never place your hands and feet under the raised vehicle.
- never lie under the raised vehicle.
- never start the engine when the vehicle is raised.
- never open or close a door or the tailgate when the vehicle is raised.
- make sure that no persons are present in the vehicle when the vehicle is raised.



- Using lug wrench ①, loosen the bolts on the wheel you wish to change by about one full turn. Do not unscrew the bolts completely.



The jacking points are located just behind the front wheel housings and just in front of the rear wheel housings (arrows).

- Take the ratchet wrench out of the vehicle tool kit and place it on the hexagon nut of the jack so that the letters **AUF** are visible.

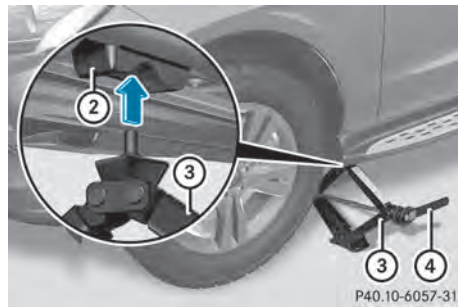

- ② Jacking points
- ③ Jack
- ④ Crank

- Position jack ③ at jacking point ②.

The alignment bolt on the jack must be inserted into the intended jacking point hole.

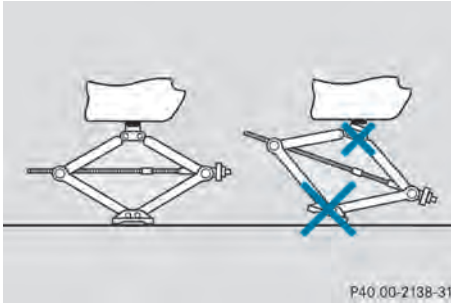

P40.00-2138-31

Example

- ▶ Make sure the foot of the jack is directly beneath the jacking point.
- ▶ Turn ratchet wrench ④ until jack ③ sits completely on jacking point ② and the base of the jack lies evenly on the ground.
- ▶ Turn ratchet wrench ④ until the tire is raised a maximum of 1.2 in (3 cm) from the ground.

Removing a wheel

- ❗ Do not place wheel bolts in sand or on a dirty surface. The bolt and wheel hub threads could otherwise be damaged when you screw them in.

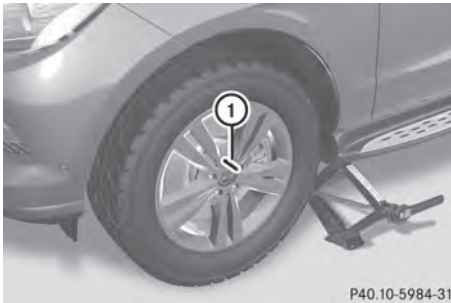

P40.10-5984-31

- ▶ Unscrew the uppermost wheel bolt completely.
- ▶ Screw alignment bolt ① into the thread instead of the wheel bolt.
- ▶ Unscrew the remaining wheel bolts fully.
- ▶ Remove the wheel.

Mounting a new wheel**⚠ WARNING**

Oiled or greased wheel bolts or damaged wheel bolts/hub threads can cause the wheel bolts to come loose. As a result, you could lose a wheel while driving. There is a risk of accident.

Never oil or grease wheel bolts. In the event of damage to the threads, contact a qualified specialist workshop immediately. Have the damaged wheel bolts or hub threads replaced/renewed. Do not continue driving.

⚠ WARNING

If you tighten the wheel bolts or wheel nuts when the vehicle is raised, the jack could tip over. There is a risk of injury.

Only tighten the wheel bolts or wheel nuts when the vehicle is on the ground.

- ❗ To prevent damage to the paintwork, hold the wheel securely against the wheel hub while screwing in the first wheel bolt.

Always pay attention to the instructions and safety notes in the "Changing a wheel" section (> page 421).

Only use wheel bolts that have been designed for the wheel and the vehicle. For safety reasons, Mercedes-Benz recommends that you only use wheel bolts which have been approved for Mercedes-Benz vehicles and the respective wheel.

- ❗ Always use wheel bolts ② to mount the "Minispare" emergency spare wheel. Using other wheel bolts to mount the "Minispare" emergency spare wheel could damage the brake system.

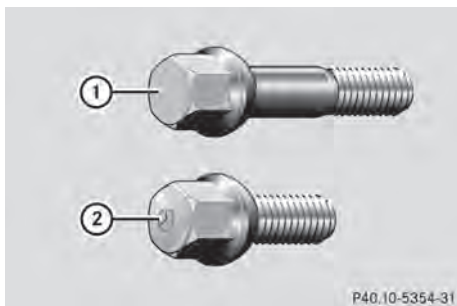

P40.10-5354-31

- ① Wheel bolts for all wheels supplied by the factory
- ② Wheel bolts for the "Minispare" emergency spare wheel



P40.10-6164-31

- ▶ Clean the wheel and wheel hub contact surfaces.
- ▶ Slide the wheel to be mounted onto the alignment bolt and push it on.
- ▶ Tighten the wheel bolts until they are finger-tight.
- ▶ Unscrew the alignment bolt.
- ▶ Tighten the last wheel bolt until it is finger-tight.

Lowering the vehicle

WARNING

The wheels could work loose if the wheel nuts and bolts are not tightened to the specified tightening torque. There is a risk of accident. Have the tightening torque immediately checked at a qualified specialist workshop after a wheel is changed.

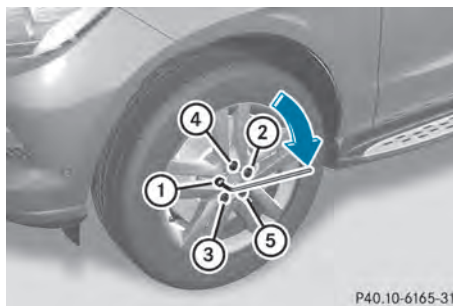

P40.10-6165-31

- ▶ Place the ratchet wrench onto the hexagon nut of the jack so that the letters **AB** are visible.
- ▶ Turn the ratchet wrench until the vehicle is once again standing firmly on the ground.
- ▶ Place the jack to one side.
- ▶ Tighten the wheel bolts evenly in a crosswise pattern in the sequence indicated (① to ⑤). The tightening torque must be **110 lb-ft (150 Nm)**.
- ▶ Turn the jack back to its initial position.
- ▶ Stow the jack and the rest of the tire-change tool kit in the stowage well under the cargo compartment floor again.
- ▶ Check the tire pressure of the newly installed wheel and adjust it if necessary. Observe the recommended tire pressure (▷ page 402).

- ① Vehicles with tire pressure monitor: all wheels mounted must be equipped with functioning sensors.

Wheel and tire combinations

General notes

- ❗ For safety reasons, Mercedes-Benz recommends that you only use tires and wheels which have been approved by Mercedes-Benz specifically for your vehicle.

These tires have been specially adapted for use with the control systems, such as ABS or ESP®, and are marked as follows:

- MO = Mercedes-Benz Original
- MOE = Mercedes-Benz Original Extended (tires featuring run-flat characteristics)
- MO1 = Mercedes-Benz Original (only certain AMG tires)

Mercedes-Benz Original Extended tires may only be used on wheels that have been specifically approved by Mercedes-Benz.

Only use tires, wheels or accessories tested and approved by Mercedes-Benz. Certain characteristics, e.g. handling, vehicle noise emissions or fuel consumption, may otherwise be adversely affected. In addition, when driving with a load, tire dimension variations could cause the tires to come into contact with the bodywork and axle components. This could result in damage to the tires or the vehicle.

Mercedes-Benz accepts no liability for damage resulting from the use of tires, wheels or accessories other than those tested and approved.

Information on tires, wheels and approved combinations can be obtained from any qualified specialist workshop.

- !** Retreaded tires are neither tested nor recommended by Mercedes-Benz, since previous damage cannot always be detected on retreaded tires. As a result, Mercedes-Benz cannot guarantee vehicle safety if retreaded tires are mounted. Do not mount used tires if you have no information about their previous usage.

Overview of abbreviations used in the following tire tables:

- BA: both axles
- FA: front axle
- RA: rear axle

The recommended pressures for various operating conditions can be found:

- on the Tire and Loading Information placard with the recommended tire pressures on the B-pillar on the driver's side
- in the tire pressure table on the inside of the fuel filler flap

Observe the notes on recommended tire pressures under various operating conditions (> page 402).

Check tire pressures regularly, and only when the tires are cold. Comply with the maintenance recommendations of the tire manufacturer in the vehicle document wallet.

Notes on the vehicle equipment – always equip the vehicle with:

- tires of the same size on a given axle (left/right)
- the same type of tires at a given time (summer tires, winter tires, MOExtended tires)

Vehicles with MOExtended tires are not equipped with a TIREFIT kit at the factory. It is therefore recommended that you additionally equip your vehicle with a TIREFIT kit if you mount tires that do not feature run-flat properties, e.g. winter tires. A TIREFIT kit may be obtained from a qualified specialist workshop.

- i** Not all wheel and tire combinations are available at the factory for all countries.
- i** On the following pages, you can find information on approved wheel rims and tire sizes for equipping your vehicle with winter tires. Winter tires are not available at the factory as standard equipment or optional extras.

If you would like to equip your vehicle with approved winter tires, you may also, in certain circumstances, require rims of the appropriate size. The sizes of the approved winter tires may deviate from that of the standard tires. This is dependent on the model and the equipment installed at the factory.

The tires and wheel rims, as well as further information, can be obtained at a qualified specialist workshop.

Tires**ML 350 BlueEFFICIENCY****All-weather tires****R 18**

| Tires | Alloy wheels |
|---------------------------|--|
| BA: 255/55 R 18 105 H M+S | BA: 8.0 J x 18 H2 Wheel offset: 2.21 in (56 mm) |

R 19

| Tires | Alloy wheels |
|--|--|
| BA: 225/50 R 19 103 W | BA: 8,5 J x 19 H2 Wheel offset: 2,44 in (62 mm) |
| BA: 225/50 R 19 103 W MOExtended ³ | BA: 8,5 J x 19 H2 Wheel offset: 2,44 in (62 mm) |
| BA: 255/50 R 19 107 H XL M+S | BA: 8.0 J x 19 H2 Wheel offset: 2.21 in (56 mm) |
| BA: 255/50 R 19 107 H XL M+SMOExtended ³ | BA: 8.0 J x 19 H2 Wheel offset: 2.21 in (56 mm) |
| BA: 255/50 R 19 107 H XLM+S ⁴ | BA: 8.5 J x 19 H2 Wheel offset: 2.32 in (59 mm) |
| BA: 255/50 R 19 107 H XL M+SMOExtended ^{3, 4} | BA: 8.5 J x 19 H2 Wheel offset: 2.32 in (59 mm) |
| BA: 255/50 R 19 107 H XL M+S ⁴ | BA: 8.5 J x 19 H2 Wheel offset: 2.44 in (62 mm) |
| BA: 255/50 R 19 107 H XL M+SMOExtended ^{3, 4} | BA: 8.5 J x 19 H2 Wheel offset: 2.44 in (62 mm) |

³ MOExtended tires (tires featuring run-flat characteristics) only in combination with an activated tire pressure loss warning system or tire pressure monitor.

⁴ Use of snow chains not permitted. Observe the notes under "Snow chains".

R 20





| Tires | Alloy wheels |
|--|--|
| BA: 265/45 R 20 108 H XL M+S ⁴ | BA: 9.0 J x 20 H2 Wheel offset: 2.24 in (57 mm) |
| BA: 265/45 R 20 108 H XL M+SMOExtended ^{3, 4} | BA: 9.0 J x 20 H2 Wheel offset: 2.24 in (57 mm) |

Winter tires

R 18

| Tires | Alloy wheels |
|---|--|
| BA: 255/55 R 18 105 H M+S  | BA: 8.0 J x 18 H2 Wheel offset: 2.21 in (56 mm) |

R 19

| Tires | Alloy wheels |
|---|--|
| BA: 225/50 R 19 103 W | BA: 8,5 J x 19 H2 Wheel offset: 2,44 in (62 mm) |
| BA: 225/50 R 19 103 W MOExtended ³ | BA: 8,5 J x 19 H2 Wheel offset: 2,44 in (62 mm) |
| BA: 255/50 R 19 107 H XL M+S  | BA: 8.0 J x 19 H2 Wheel offset: 2.21 in (56 mm) |
| BA: 255/50 R 19 107 H XL M+S  MOExtended ³ | BA: 8.0 J x 19 H2 Wheel offset: 2.21 in (56 mm) |
| BA: 255/50 R 19 107 H XL M+S  ⁴ | BA: 8.5 J x 19 H2 Wheel offset: 2.32 in (59 mm) |
| BA: 255/50 R 19 107 H XL M+S  MOExtended ^{3, 4} | BA: 8.5 J x 19 H2 Wheel offset: 2.32 in (59 mm) |

⁴ Use of snow chains not permitted. Observe the notes under "Snow chains".

³ MOExtended tires (tires featuring run-flat characteristics) only in combination with an activated tire pressure loss warning system or tire pressure monitor.

ML 350 4MATIC BlueEFFICIENCY**All-weather tires****R 18**

| Tires | Alloy wheels |
|---------------------------|--|
| BA: 255/55 R 18 105 H M+S | BA: 8.0 J x 18 H2 Wheel offset: 2.21 in (56 mm) |

R 19

| Tires | Alloy wheels |
|--|--|
| BA: 225/50 R 19 103 W | BA: 8,5 J x 19 H2 Wheel offset: 2,44 in (62 mm) |
| BA: 225/50 R 19 103 W MOExtended ³ | BA: 8,5 J x 19 H2 Wheel offset: 2,44 in (62 mm) |
| BA: 255/50 R 19 107 H XL M+S | BA: 8.0 J x 19 H2 Wheel offset: 2.21 in (56 mm) |
| BA: 255/50 R 19 107 H XL M+SMOExtended ³ | BA: 8.0 J x 19 H2 Wheel offset: 2.21 in (56 mm) |
| BA: 255/50 R 19 107 H XL M+S ⁴ | BA: 8.5 J x 19 H2 Wheel offset: 2.32 in (59 mm) |
| BA: 255/50 R 19 107 H XL M+SMOExtended ^{3, 4} | BA: 8.5 J x 19 H2 Wheel offset: 2.32 in (59 mm) |
| BA: 255/50 R 19 107 H XL M+S ⁴ | BA: 8.5 J x 19 H2 Wheel offset: 2.44 in (62 mm) |
| BA: 255/50 R 19 107 H XL M+SMOExtended ^{3, 4} | BA: 8.5 J x 19 H2 Wheel offset: 2.44 in (62 mm) |

R 20

| Tires | Alloy wheels |
|--|--|
| BA: 265/45 R 20 108 H XL M+S ⁴ | BA: 9.0 J x 20 H2 Wheel offset: 2.24 in (57 mm) |
| BA: 265/45 R 20 108 H XL M+SMOExtended ^{3, 4} | BA: 9.0 J x 20 H2 Wheel offset: 2.24 in (57 mm) |

³ MOExtended tires (tires featuring run-flat characteristics) only in combination with an activated tire pressure loss warning system or tire pressure monitor.





⁴ Use of snow chains not permitted. Observe the notes under "Snow chains".

Winter tires

R 18

| Tires | Alloy wheels |
|---|--|
| BA: 255/55 R 18 105 H M+S  | BA: 8.0 J x 18 H2 Wheel offset: 2.21 in (56 mm) |

R 19

| Tires | Alloy wheels |
|--|--|
| BA: 225/50 R 19 103 W | BA: 8,5 J x 19 H2 Wheel offset: 2,44 in (62 mm) |
| BA: 225/50 R 19 103 W MOExtended ³ | BA: 8,5 J x 19 H2 Wheel offset: 2,44 in (62 mm) |
| BA: 255/50 R 19 107 H XL M+S  | BA: 8.0 J x 19 H2 Wheel offset: 2.21 in (56 mm) |
| BA: 255/50 R 19 107 H XL M+S  MOExtended ³ | BA: 8.0 J x 19 H2 Wheel offset: 2.21 in (56 mm) |
| BA: 255/50 R 19 107 H XL M+S  ⁴ | BA: 8.5 J x 19 H2 Wheel offset: 2.32 in (59 mm) |
| BA: 255/50 R 19 107 H XL M+S  MOExtended ^{3, 4} | BA: 8.5 J x 19 H2 Wheel offset: 2.32 in (59 mm) |

ML 350 BlueTEC 4MATIC

All-weather tires

R 18

| Tires | Alloy wheels |
|---------------------------|--|
| BA: 255/55 R 18 105 H M+S | BA: 8.0 J x 18 H2 Wheel offset: 2.21 in (56 mm) |

³ MOExtended tires (tires featuring run-flat characteristics) only in combination with an activated tire pressure loss warning system or tire pressure monitor.

⁴ Use of snow chains not permitted. Observe the notes under "Snow chains".

R 19

| Tires | Alloy wheels |
|--|--|
| BA: 225/50 R 19 103 W | BA: 8,5 J x 19 H2 Wheel offset: 2,44 in (62 mm) |
| BA: 225/50 R 19 103 W MOExtended ³ | BA: 8,5 J x 19 H2 Wheel offset: 2,44 in (62 mm) |
| BA: 255/50 R 19 107 H XL M+S | BA: 8.0 J x 19 H2 Wheel offset: 2.21 in (56 mm) |
| BA: 255/50 R 19 107 H XL M+S ^{MOExtended} ³ | BA: 8.0 J x 19 H2 Wheel offset: 2.21 in (56 mm) |
| BA: 255/50 R 19 107 H XL M+S ⁴ | BA: 8.5 J x 19 H2 Wheel offset: 2.32 in (59 mm) |
| BA: 255/50 R 19 107 H XL M+S ^{MOExtended} ^{3, 4} | BA: 8.5 J x 19 H2 Wheel offset: 2.32 in (59 mm) |
| BA: 255/50 R 19 107 H XL M+S ⁴ | BA: 8.5 J x 19 H2 Wheel offset: 2.44 in (62 mm) |
| BA: 255/50 R 19 107 H XL M+S ^{MOExtended} ^{3, 4} | BA: 8.5 J x 19 H2 Wheel offset: 2.44 in (62 mm) |

R 20

| Tires | Alloy wheels |
|--|--|
| BA: 265/45 R 20 108 H XL M+S ⁴ | BA: 9.0 J x 20 H2 Wheel offset: 2.24 in (57 mm) |
| BA: 265/45 R 20 108 H XL M+S ^{MOExtended} ^{3, 4} | BA: 9.0 J x 20 H2 Wheel offset: 2.24 in (57 mm) |

Winter tires





R 18

| Tires | Alloy wheels |
|---|--|
| BA: 255/55 R 18 105 H M+S  | BA: 8.0 J x 18 H2 Wheel offset: 2.21 in (56 mm) |

³ MOExtended tires (tires featuring run-flat characteristics) only in combination with an activated tire pressure loss warning system or tire pressure monitor.

⁴ Use of snow chains not permitted. Observe the notes under "Snow chains".

R 19

| Tires | Alloy wheels |
|---|--|
| BA: 225/50 R 19 103 W | BA: 8,5 J x 19 H2 Wheel offset: 2,44 in (62 mm) |
| BA: 225/50 R 19 103 W MOExtended ³ | BA: 8,5 J x 19 H2 Wheel offset: 2,44 in (62 mm) |
| BA: 255/50 R 19 107 H XL M+S  | BA: 8.0 J x 19 H2 Wheel offset: 2.21 in (56 mm) |
| BA: 255/50 R 19 107 H XL M+S  MOExtended ³ | BA: 8.0 J x 19 H2 Wheel offset: 2.21 in (56 mm) |
| BA: 255/50 R 19 107 H XL M+S  ⁴ | BA: 8.5 J x 19 H2 Wheel offset: 2.32 in (59 mm) |
| BA: 255/50 R 19 107 H XL M+S  MOExtended ^{3, 4} | BA: 8.5 J x 19 H2 Wheel offset: 2.32 in (59 mm) |

ML 550 4MATIC BlueEFFICIENCY

All-weather tires

R 19

| Tires | Alloy wheels |
|--|--|
| BA: 225/50 R 19 103 W | BA: 8,5 J x 19 H2 Wheel offset: 2,44 in (62 mm) |
| BA: 225/50 R 19 103 W MOExtended ³ | BA: 8,5 J x 19 H2 Wheel offset: 2,44 in (62 mm) |
| BA: 255/50 R 19 107 H XL M+S | BA: 8.0 J x 19 H2 Wheel offset: 2.21 in (56 mm) |
| BA: 255/50 R 19 107 H XL M+SMOExtended ³ | BA: 8.0 J x 19 H2 Wheel offset: 2.21 in (56 mm) |
| BA: 255/50 R 19 107 H XL M+S ⁴ | BA: 8.5 J x 19 H2 Wheel offset: 2.32 in (59 mm) |
| BA: 255/50 R 19 107 H XL M+SMOExtended ^{3, 4} | BA: 8.5 J x 19 H2 Wheel offset: 2.32 in (59 mm) |

³ MOExtended tires (tires featuring run-flat characteristics) only in combination with an activated tire pressure loss warning system or tire pressure monitor.





⁴ Use of snow chains not permitted. Observe the notes under "Snow chains".

| Tires | Alloy wheels |
|--|--|
| BA: 255/50 R 19 107 H XL M+S ⁴ | BA: 8.5 J x 19 H2 Wheel offset: 2.44 in (62 mm) |
| BA: 255/50 R 19 107 H XL M+S ^{MOExtended} ^{3, 4} | BA: 8.5 J x 19 H2 Wheel offset: 2.44 in (62 mm) |

R 20

| Tires | Alloy wheels |
|--|--|
| BA: 265/45 R 20 108 H XL M+S ⁴ | BA: 9.0 J x 20 H2 Wheel offset: 2.24 in (57 mm) |
| BA: 265/45 R 20 108 H XL M+S ^{MOExtended} ^{3, 4} | BA: 9.0 J x 20 H2 Wheel offset: 2.24 in (57 mm) |

Winter tires**R 19**

| Tires | Alloy wheels |
|--|--|
| BA: 225/50 R 19 103 W | BA: 8,5 J x 19 H2 Wheel offset: 2,44 in (62 mm) |
| BA: 225/50 R 19 103 W ^{MOExtended} ³ | BA: 8,5 J x 19 H2 Wheel offset: 2,44 in (62 mm) |
| BA: 255/50 R 19 107 H XL M+S  | BA: 8.0 J x 19 H2 Wheel offset: 2.21 in (56 mm) |
| BA: 255/50 R 19 107 H XL M+S  ^{MOExtended} ³ | BA: 8.0 J x 19 H2 Wheel offset: 2.21 in (56 mm) |
| BA: 255/50 R 19 107 H XL M+S  ⁴ | BA: 8.5 J x 19 H2 Wheel offset: 2.32 in (59 mm) |
| BA: 255/50 R 19 107 H XL M+S  ^{MOExtended} ^{3, 4} | BA: 8.5 J x 19 H2 Wheel offset: 2.32 in (59 mm) |

⁴ Use of snow chains not permitted. Observe the notes under "Snow chains".

³ MOExtended tires (tires featuring run-flat characteristics) only in combination with an activated tire pressure loss warning system or tire pressure monitor.

ML 63 AMG 4MATIC

Summer tires

R 20

| Tires | Alloy wheels |
|--|--|
| BA: 265/45 ZR 20 108 Y XL ⁴ | BA: 9.0 J x 20 H2 Wheel offset: 1.61 in (41 mm) |

R 21

| Tires | Alloy wheels |
|--|---|
| BA: 295/35 ZR 21 107 Y XL ⁴ | BA: 10.0 J x 21 H2 Wheel offset: 2.21 in (56 mm) |

Winter tires

R 20

| Tires | Alloy wheels |
|--|--|
| BA: 255/45 R 20 105 V XL M+S  | BA: 9.0 J x 20 H2 Wheel offset: 1.61 in (41 mm) |

R 21

| Tires | Alloy wheels |
|---|---|
| BA: 295/35 R 21 107 V XL M+S  ⁴ | BA: 10.0 J x 21 H2 Wheel offset: 2.21 in (56 mm) |

Emergency spare wheel

Important safety notes

 **WARNING**

The wheel or tire size as well as the tire type of the spare wheel or emergency spare wheel and the wheel to be replaced may differ. Mounting an emergency spare wheel may severely impair the driving characteristics. There is a risk of an accident.

To avoid hazardous situations:

- adapt your driving style accordingly and drive carefully.
- never mount more than one spare wheel or emergency spare wheel that differs in size.
- only use a spare wheel or emergency spare wheel of a different size briefly.
- do not switch ESP[®] off.
- have a spare wheel or emergency spare wheel of a different size replaced at the nearest qualified specialist workshop. Observe that the wheel and tire dimensions as well as the tire type must be correct.

⁴ Use of snow chains not permitted. Observe the notes under "Snow chains".

! **AMG vehicles with "Minispare" emergency spare wheel:** use the "Minispare" emergency spare wheel **only on the rear axle**. If you mount the "Minispare" emergency spare wheel on the front axle, this could result in damage to the brake system.

If a tire on the front axle is defective, an intact wheel from the rear axle must first be replaced with the "Minispare" emergency spare wheel. The defective wheel on the front axle can then be replaced with the intact wheel from the rear axle.

Make sure to note the placard on the "Minispare" emergency spare wheel.

When using an emergency spare wheel or spare wheel of a different size, you must not exceed the maximum speed of 50 mph (80 km/h).

Snow chains must not be mounted on emergency spare wheels.

General notes

Mounting the emergency spare wheel is described under "Mounting a wheel" (▷ page 422).

You should regularly check the pressure of the emergency spare wheel, particularly prior to long trips, and correct the pressure as necessary (▷ page 402). The applicable value can be found on the wheel or under "Technical data" (▷ page 439).

An emergency spare wheel may also be mounted against the direction of rotation. Observe the time restriction on use as well as the speed limitation specified on the emergency spare wheel.

Replace the tires after six years at the latest, regardless of wear. This also applies to the emergency spare wheel.

Removing the emergency spare wheel

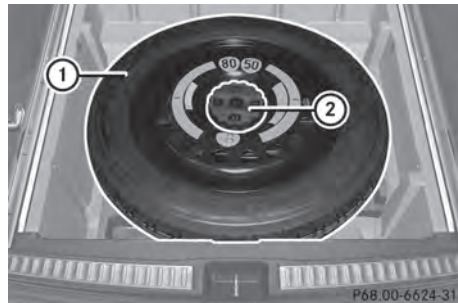

Emergency spare wheel (example: vehicle without lockable cargo compartment floor)

- ① "Minispare" emergency spare wheel
- ② Emergency spare wheel retainer

The "Minispare" emergency spare wheel can be found in the stowage well under the cargo compartment floor.

- ▶ Lift the cargo compartment floor up (▷ page 342).
- ▶ **Vehicles with trailer tow hitch:** remove the ball coupling stowage tray (▷ page 255).
- ▶ **Vehicles without a lockable cargo compartment floor:** turn emergency spare wheel retainer ② counter-clockwise and remove it.
- ▶ Remove "Minispare" emergency spare wheel ①.

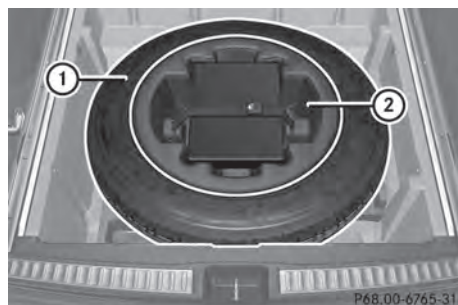

Vehicles with a lockable cargo compartment floor

- ① "Minispare" emergency spare wheel
- ② Stowage well

- ▶ **Vehicles with a lockable cargo compartment floor:** remove the contents of stowage tray (2).
- ▶ Turn the central retaining screw of stowage tray (2) and "Minispare" emergency spare wheel (1) counter-clockwise and remove it.
- ▶ Remove stowage well (2).
- ▶ Remove "Minispare" emergency spare wheel (1).

- ▶ Hook retaining spring hooks (1) and (3) on tensioning straps (2) in the cargo tie-down rings.
- ▶ Tighten tensioning straps (2) on both sides.

For further information on changing and mounting a wheel, see (▷ page 422).

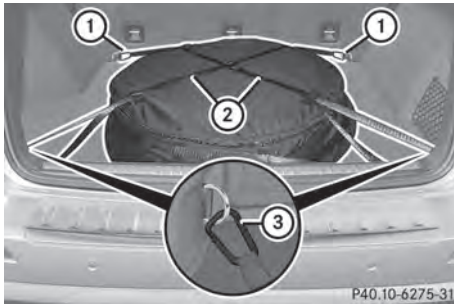

In vehicles with a Bang & Olufsen sound system, the "Minispare" emergency spare wheel is stored in a bag. The bag is secured to the cargo tie-down rings in the cargo compartment.

- ▶ **To remove the emergency spare wheel:** open the tailgate.
- ▶ Loosen tensioning straps (2) on both sides.
- ▶ Unhook retaining spring hooks (1) and (3) on tensioning straps (2) from the cargo tie-down rings.
- ▶ Remove the bag with the "Minispare" emergency spare wheel.
- ▶ Open the bag and remove the "Minispare" emergency spare wheel.
- ▶ **To stow the emergency spare wheel:** place the "Minispare" emergency spare wheel in the bag and close the bag.
- ▶ Lay the bag with the "Minispare" emergency spare wheel in the cargo compartment, with the carrying strap to the rear.

Technical data**ML 350 BlueEFFICIENCY****"Minispare" emergency spare wheel**

| Tires | Alloy wheels |
|---|--|
| T 155/90 R18 113 M Tire pressure: 420 kPa (4.2 bar/61 psi) | 4.0 B x 18 H2 Wheel offset: 1.58 in (40 mm) |

ML 350 4MATIC BlueEFFICIENCY**"Minispare" emergency spare wheel**

| Tires | Alloy wheels |
|---|--|
| T 155/90 R18 113 M Tire pressure: 420 kPa (4.2 bar/61 psi) | 4.0 B x 18 H2 Wheel offset: 1.58 in (40 mm) |

ML 350 BlueTEC 4MATIC**"Minispare" emergency spare wheel**

| Tires | Alloy wheels |
|---|--|
| T 155/90 R18 113 M Tire pressure: 420 kPa (4.2 bar/61 psi) | 4.0 B x 18 H2 Wheel offset: 1.58 in (40 mm) |

ML 550 4MATIC BlueEFFICIENCY**"Minispare" emergency spare wheel**

| Tires | Alloy wheels |
|---|--|
| T 155/80 R19 114 M Tire pressure: 420 kPa (4.2 bar/61 psi) | 4.5 B x 19 H2 Wheel offset: 1.58 in (40 mm) |

ML 63 AMG**"Minispare" emergency spare wheel**

| Tires | Alloy wheels |
|---|--|
| T 155/80 R19 114 M Tire pressure: 420 kPa (4.2 bar/61 psi) | 4.5 B x 19 H2 Wheel offset: 1.58 in (40 mm) |

| | |
|--|------------|
| Useful information | 442 |
| Information regarding technical data | 442 |
| Genuine Mercedes-Benz parts | 442 |
| Warranty | 442 |
| Identification plates | 443 |
| Service products and filling capacities | 444 |
| Vehicle data | 452 |
| Trailer tow hitch | 454 |

Useful information

- i** This Operator's Manual describes all models and all standard and optional equipment of your vehicle available at the time of publication of the Operator's Manual. Country-specific differences are possible. Please note that your vehicle may not be equipped with all features described. This also applies to safety-related systems and functions.
- i** Read the information on qualified specialist workshops: (▷ page 27).

Information regarding technical data

- i** The data stated here specifically refers to a vehicle with standard equipment. Consult an authorized Mercedes-Benz Center for the data for all vehicle variants and trim levels.

Genuine Mercedes-Benz parts

WARNING

Driving safety may be impaired if non-approved parts, tires and wheels or safety-relevant accessories are used.

This could lead to malfunctions in safety-relevant systems, e.g. the brake system. This could cause you to lose control of your vehicle and cause an accident.

For this reason, Mercedes-Benz recommends that you use genuine Mercedes-Benz parts or parts of equal quality. Only use tires, wheels and accessories that have been specifically approved for your vehicle.

Environmental note

Daimler AG also supplies reconditioned major assemblies and parts which are of the same quality as new parts. They are covered by the same Limited Warranty entitlements as new parts.

- !** Air bags and Emergency Tensioning Devices, as well as control units and sensors for these restraint systems, may be installed in the following areas of your vehicle:

- doors
- door pillars
- door sills
- seats
- cockpit
- instrument cluster
- center console

Do not install accessories such as audio systems in these areas. Do not carry out repairs or welding. You could impair the operating efficiency of the restraint systems.

Have aftermarket accessories installed at a qualified specialist workshop.

Genuine Mercedes-Benz parts are subject to strict quality control. Each part has been specially developed, manufactured or selected for Mercedes-Benz vehicles and fine-tuned for them. Only genuine Mercedes-Benz parts should therefore be used.

More than 300,000 different genuine Mercedes-Benz parts are available for Mercedes-Benz models.

All authorized Mercedes-Benz Centers maintain a supply of genuine Mercedes-Benz parts for necessary service and repair work. In addition, strategically located parts delivery centers provide quick and reliable parts service.

Always specify the vehicle identification number (VIN) (▷ page 443) and the engine number (▷ page 444) when ordering genuine Mercedes-Benz parts.

Warranty

Your vehicle is covered under the terms of the warranties printed in the Service and Warranty Information booklet.

Your authorized Mercedes-Benz Center will replace and repair all factory-installed parts in accordance with the following warranty terms and conditions:

- New Vehicle Limited Warranty
- Emission Systems Warranty
- Emission Performance Warranty
- California, Connecticut, Maine, Massachusetts, New York, Pennsylvania, Rhode Island and Vermont Emission Control System Warranty
- State warranty enforcement laws (Lemon Laws)

Replacement parts and accessories are covered by the Mercedes-Benz Parts and Accessories warranties. These are available at any authorized Mercedes-Benz Center.

- i** If you lose the Service and Warranty Information booklet, contact an authorized Mercedes-Benz Center to arrange a replacement. It will be mailed to you.

Identification plates

Vehicle identification plate with vehicle identification number (VIN)



- Open the driver's door. You will see vehicle identification plate ①.

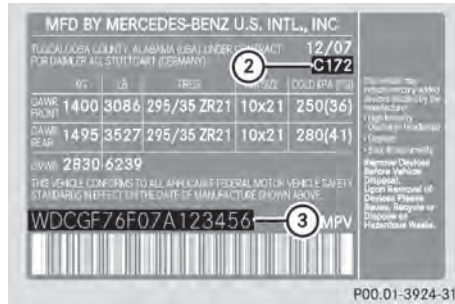

Example: vehicle identification plate (USA only)

- ② Paint code
- ③ VIN

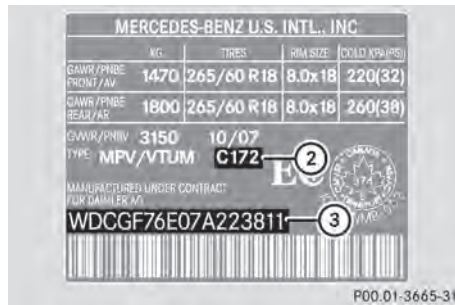

Example: vehicle identification plate (Canada only)

- ② Paint code
- ③ VIN
- i** The data shown on the vehicle identification plate is used only as an example. This data is different for every vehicle and can deviate from the data shown here. You can find the data applicable to your vehicle on the vehicle's identification plate.

VIN



- ▶ Open the front right-hand door.
- ▶ Open cover ① in the direction of the arrow and remove it.
You will see the VIN.

The VIN can also be found in the following locations:

- on the lower edge of the windshield (▷ page 444)
- on the vehicle identification plate (▷ page 443)

Engine number

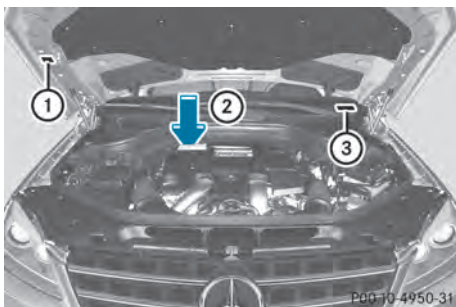

- ① Emission control information plate, including the certification of both federal and Californian emissions standards
- ② Engine number (stamped into the crankcase)
- ③ VIN (on the lower edge of the windshield)

Service products and filling capacities

Important safety notes

⚠ WARNING

Service products may be poisonous and hazardous to health. There is a risk of injury. Comply with instructions on the use, storage and disposal of service products on the labels of the respective original containers. Always store service products sealed in their original containers. Always keep service products out of the reach of children.

♻ Environmental note

Dispose of service products in an environmentally responsible manner.

Service products include the following:

- fuels (e.g. gasoline, diesel)
- exhaust gas aftertreatment additives, e.g. DEF
- lubricants (e.g. engine oil, transmission oil)
- coolant
- brake fluid
- windshield washer fluid
- climate control system refrigerant

Comply with all valid regulations with respect to handling, storing, and disposing of service fluids.

Components and service products must be matched. You should therefore only use products that have been tested and approved by Mercedes-Benz.

Information on tested and approved products can be obtained at an authorized Mercedes-Benz Center or on the Internet at <http://bevo.mercedes-benz.com>.

You can recognize service products approved by Mercedes-Benz by the following inscription on the containers:

- MB-Freigabe (e.g. MB-Freigabe 229.51)
- MB Approval (e.g. MB Approval 229.51)

Other designations or recommendations indicate a level of quality or a specification in accordance with an MB Sheet number (e.g. MB 229.5). They have not necessarily been approved by Mercedes-Benz.

Fuel

Important safety notes

WARNING

Fuel is highly flammable. If you handle fuel incorrectly, there is a risk of fire and explosion.

You must avoid fire, open flames, creating sparks and smoking. Switch off the engine and, if applicable, the auxiliary heating before refueling.

WARNING

Fuel is poisonous and hazardous to health. There is a risk of injury.

You must make sure that fuel does not come into contact with your skin, eyes or clothing and that it is not swallowed. Do not inhale fuel vapors. Keep fuel away from children.

If you or others come into contact with fuel, observe the following:

- Wash away fuel from skin immediately using soap and water.
- If fuel comes into contact with your eyes, immediately rinse them thoroughly with clean water. Seek medical assistance without delay.
- If fuel is swallowed, seek medical assistance without delay. Do not induce vomiting.
- Immediately change out of clothing which has come into contact with fuel.

Tank capacity

| Model | Total capacity |
|------------|-------------------------|
| All models | 24.6 US gal (93.0 l) |

| Model | Of which reserve |
|------------|-----------------------------------|
| All models | Approx. 3.2 US gal (12.0 l) |
| ML 63 AMG | Approx. 3.7 US gal (14.0 l) |

Gasoline

Fuel grade

 Do not use diesel to refuel vehicles with a gasoline engine. Do not switch on the ignition if you accidentally refuel with the wrong fuel. Otherwise, the fuel will enter the fuel system. Even small amounts of the wrong fuel could result in damage to the fuel system and the engine. The repair costs are high. Notify a qualified specialist workshop and have the fuel tank and fuel lines drained completely.

 You should only refuel with unleaded premium-grade gasoline as this avoids damaging the catalytic converter. If engine running problems are apparent, have the cause checked immediately and repaired. Excess unburned fuel can otherwise enter the catalytic converter, leading to overheating and possibly causing a fire.

 To ensure the longevity and full performance of the engine, only premium-grade unleaded gasoline may be used.

If there is no premium-grade unleaded gasoline available and regular unleaded gasoline must be used, please observe the following precautions:

- only fill the fuel tank to half full with regular unleaded gasoline and fill the rest with premium-grade unleaded gasoline as soon as possible.
- do not drive at the maximum speed.
- avoid sudden acceleration.
- if the vehicle is carrying a light load, e.g. two passengers without luggage, do not allow the engine to rev above 3000 rpm.
- if the vehicle is fully loaded or is being operated in mountainous terrain, do not depress the accelerator pedal further than $\frac{2}{3}$ of the pedal travel.

Only refuel using premium-grade unleaded gasoline with a minimum octane rating of 91. Reformulated Gasoline (RFG) and/or unleaded gasoline with additives can be used. The concentration of additives in the fuel, however, must not exceed 10%, e.g.:

- Ethanol
- TAME
- ETBE
- IPA
- TBA

For MTBE, the concentration should not exceed 15%.

The concentration of methanol in gasoline, including other additives, must not exceed 3%.

Using mixtures of methanol and ethanol is not permitted. Gasohol, a mixture of 10% ethanol and 90% unleaded gasoline, may be used.

All of these blends must fulfill the fuel requirements, e.g.:

- knock resistance
- boiling point
- vapor pressure

You will usually find information about the fuel grade on the pump. If you cannot find the

label on the pump, ask the staff for assistance.

- i** For further information, consult a qualified specialist workshop or on the Internet at <http://www.mbusa.com> (USA only).

Information on refueling (▷ page 174).

Additives

- !** Operating the engine with fuel additives can increase wear and tear to the fuel system high-pressure pump and lead to contamination of the entire fuel system. The repair costs are high. This does not include additives for the removal and prevention of residue buildup. Gasoline must only be mixed with additives recommended by Mercedes-Benz. More information about recommended additives can be obtained from any authorized Mercedes-Benz Center.

One of the main problems of poor fuel quality is the forming of deposits that are created during the gasoline combustion process. Mercedes-Benz recommends that you use branded fuels that have additives.

If you use fuels without these additives over a longer period of time, carbon deposits may build up. These deposits form at the inlet valves and in the combustion chamber in particular.

This could lead to engine problems, e.g.:

- longer engine warm-up phase
- uneven idle
- engine noise
- misfiring
- loss of power

Carbon deposits may form if the availability of gasoline with relevant additives is insufficient (in certain regions). In this case, Mercedes-Benz recommends additives approved for use in Mercedes-Benz vehicles; see <http://bevo.mercedes-benz.com>.

For a list of approved products, consult an authorized Mercedes-Benz Center. Comply

with the instructions for use on the product label.

Do not mix other fuel additives with fuel. This causes unnecessary costs and could damage the engine.

Diesel

Fuel grade

WARNING

If you mix diesel fuel with gasoline, the flash point is lower than that of pure diesel fuel. When the engine is running, exhaust system components could overheat without being noticed. There is a risk of fire.

Never refuel with gasoline. Never mix gasoline with diesel fuel.

! Only use commercially available vehicular ULTRA-LOW SULFUR DIESEL FUEL (ULSD, 15 ppm maximum sulfur content) that meets the ASTM D975 standard. If you do not refuel with ULSD, you may damage the BlueTEC exhaust gas aftertreatment system of the vehicle.

! Do not use gasoline to refuel vehicles with a diesel engine. Do not mix diesel fuel with gasoline, kerosene or paraffin. This may otherwise result in damage to the fuel system and engine.

You will usually find information about the fuel grade on the pump. If you cannot find the label on the pump, ask the staff for assistance.

i For further information, consult a qualified specialist workshop or on the Internet at <http://www.mbusa.com> (USA only).

Information on refueling (▷ page 174).

Bio-diesel - FAME (fatty acid methyl ester)

Mercedes-Benz USA approves the use of bio-diesel B5 for all BlueTEC diesel engines. The concentration of bio-diesel in the ULSD may not exceed 5% by volume.

Pure bio-diesel and diesel fuel with a higher percentage of bio-diesel, such as B20, can damage the engine and the fuel system. For this reason, they are not approved.

For more information, consult the gas station staff. The bio-diesel B5 label on the gasoline pump must clearly state that the standard for ULSD has been fulfilled. If the label is not clear, do not refuel the vehicle.

Do not refuel your vehicle with fuels unless they have been approved by Mercedes-Benz. Information on refueling (▷ page 174).

Low outside temperatures

i Diesel fuel with improved cold flow properties is available during the winter months. Further information about fuel properties can be obtained from oil companies, e.g. at gas stations.

Flow improver

To improve the low-temperature resistance of diesel fuel, a flow improver can be attached. The effectiveness of a flow improver is not guaranteed for every fuel.

Only use flow improvers tested and approved by Mercedes-Benz. During use, please observe the information on operation.

Correct dosage and sufficient mixing are decisive in improving low-temperature resistance with the flow improver.

Overdosage can potentially even decrease low-temperature resistance and must therefore be avoided. Follow the manufacturer's guidelines on dosage.

Mix the additive into the diesel in good time, before the flow characteristics of the diesel become insufficient. Otherwise, malfunctions can arise through heating the fuel system, e.g. through parking in a heated garage.

More information about recommended flow improvers can be obtained from any qualified specialist workshop.

Flexible Fuel vehicles

Important safety notes

WARNING

Fuel is highly flammable. If you handle fuel incorrectly, there is a risk of fire and explosion.

You must avoid fire, open flames, creating sparks and smoking. Switch off the engine and, if applicable, the auxiliary heating before refueling.

WARNING

Fuel is poisonous and hazardous to health. There is a risk of injury.

You must make sure that fuel does not come into contact with your skin, eyes or clothing and that it is not swallowed. Do not inhale fuel vapors. Keep fuel away from children.

If you or others come into contact with fuel, observe the following:

- Wash away fuel from skin immediately using soap and water.
- If fuel comes into contact with your eyes, immediately rinse them thoroughly with clean water. Seek medical assistance without delay.
- If fuel is swallowed, seek medical assistance without delay. Do not induce vomiting.
- Immediately change out of clothing which has come into contact with fuel.

Flexible Fuel vehicles can be refueled with the following fuel types:

- premium-grade unleaded gasoline
 - E85 fuel
 - a mixture of E85 fuel and premium-grade unleaded gasoline
-  Flexible Fuel vehicles can be recognized by the **Ethanol up to E85** sticker on the inside of the fuel filler flap.

Fuel consumption

The energy content of E85 fuel is less than that of the same amount of premium-grade gasoline. The amount of fuel consumed when operating the vehicle with E85 fuel is therefore higher than with premium-grade gasoline.

Maintenance

Inform your authorized Mercedes-Benz Center that you are operating or have operated the vehicle with E85 fuel.

Low outside temperatures

If the outside temperature is below 32 °F (0 °C) the starting procedure can take noticeably longer when operating with E85 fuel.

E85 fuel is not suitable for use at outside temperatures under -4 °F (-20 °C).

DEF

Important safety notes

Comply with the important safety notes for service products when handling DEF (> page 444).

DEF is a water-soluble fluid for the exhaust gas aftertreatment of diesel engines. It is:

- not poisonous
- colorless and odorless
- not flammable

When you open the DEF container, small amounts of ammonia vapor may be released.

Ammonia vapors have a pungent odor and are particularly irritating to the skin, to mucous membranes and to the eyes. You may experience a burning sensation in your eyes, nose and throat. Coughing and watering of the eyes are possible.

Do not inhale ammonia vapors. Fill the DEF tank only in well-ventilated areas.

Low outside temperatures

DEF freezes at a temperature of approximately 12 °F (-11 °C). The vehicle is delivered from the factory equipped with a DEF preheating system. Winter operation can thus be guaranteed even at temperatures below 12 °F (-11 °C).

Additives

! Only use DEF in accordance with ISO 22241. Do not use additives with DEF and do not dilute DEF with water. This may destroy the BlueTEC exhaust gas aftertreatment system.

Purity

! Impurities in DEF (e.g. due to other service products, cleaning agents or dust) lead to:

- increased emission values
- damage to the catalytic converter
- engine damage
- malfunctions in the BlueTEC exhaust gas aftertreatment system

Assuring the purity of DEF is particularly important with respect to avoiding malfunctions in the BlueTEC exhaust gas aftertreatment system.

If DEF is pumped out of the DEF tank, e.g. during repair work, it must not be returned to the tank. The purity of the fluid can no longer be guaranteed.

Filling capacities

| Model | Total capacity |
|-----------------------|---------------------|
| ML 350 BlueTEC 4MATIC | 7.3 US gal (27.5 l) |

Engine oil

General notes

! Never use engine oil or an oil filter of a specification other than is necessary to fulfill the prescribed service intervals. Do not change the engine oil or oil filter in order to achieve longer replacement intervals than those prescribed. You could otherwise cause engine damage or damage to the exhaust gas aftertreatment.

Follow the instructions in the service interval display regarding the oil change. Otherwise, you may damage the engine and the exhaust gas aftertreatment.

Comply with the important safety notes for service products when handling engine oil (> page 444).

The engine oils are matched to the performance of Mercedes-Benz engines and service intervals. You should therefore only use engine oils and oil filters that are approved for vehicles with maintenance systems.

For a list of approved engine oils and oil filters, consult an authorized Mercedes-Benz Center. Or visit the website <http://bevo.mercedes-benz.com>.

The table shows which engine oils have been approved for your vehicle.

| Model | Engine model | MB Approval |
|--|--------------|------------------------|
| ML 350 BlueEFFICIENCY ML 350 4MATIC BlueEFFICIENCY | 276 | 229.5 |
| ML 550 4MATIC BlueEFFICIENCY | 278 | 229.5 |
| ML 63 AMG | 157 | 229.5 |
| ML 350 BlueTEC 4MATIC | 642 | 228.51, 229.31, 229.51 |

Use only SAE 0W-40 or SAE 5W-40 engine oils for AMG vehicles.

- i** MB approval is indicated on the oil containers.

Filling capacities

The following values refer to an oil change including the oil filter.

| Model | Capacity |
|---------------------------------|--|
| ML 350 BlueEFFICIENCY | 7.4 US qt (7.0 l) |
| ML 350 4MATIC BlueEFFICIENCY | |
| ML 550 4MATIC BlueEFFICIENCY | 9.0 US qt (8.5 l) |
| ML 63 AMG | Without external oil cooler: 9.0 US qt (8.5 l) |
| ML 350 BlueTEC 4MATIC | 8.5 US qt (8.0 l) |

Additives

- !** Do not use any additives in the engine oil. This could damage the engine.

Engine oil viscosity

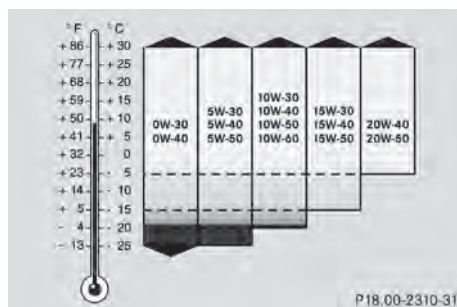

Viscosity describes the flow characteristics of a fluid. If an engine oil has a high viscosity, this means that it is thick; a low viscosity means that it is thin.

Select an engine oil with an SAE (viscosity) classification suitable for the prevailing outside temperatures. The table shows you which SAE classifications are to be used. The low-temperature characteristics of engine oils can deteriorate significantly, e.g. as a result of aging, soot and fuel deposits. It is therefore strongly recommended that you carry out regular oil changes using an approved engine oil with the appropriate SAE classification.

Brake fluid

! WARNING

The brake fluid constantly absorbs moisture from the air. This lowers the boiling point of the brake fluid. If the boiling point of the brake fluid is too low, vapor pockets may form in the brake system when the brakes are applied hard. This would impair braking efficiency. There is a risk of an accident.

You should have the brake fluid renewed at the specified intervals.

Comply with the important safety notes for service products when handling brake fluid (> page 444).

The brake fluid change intervals can be found in the Maintenance Booklet.

Only use brake fluid approved by Mercedes-Benz according to MB Approval 331.0.

Information about approved brake fluid can be obtained at any qualified specialist workshop or on the Internet at <http://bevo.mercedes-benz.com>.

- i** Have the brake fluid regularly replaced at a qualified specialist workshop and have this confirmed in the Maintenance Booklet.

Coolant

Important safety notes

WARNING

If antifreeze comes into contact with hot components in the engine compartment, it may ignite. There is a risk of fire and injury. Let the engine cool down before you add antifreeze. Make sure that antifreeze is not spilled next to the filler neck. Thoroughly clean the antifreeze from components before starting the engine.

! Only add coolant that has been premixed with the desired antifreeze protection. You could otherwise damage the engine. Further information on coolants can be found in the Mercedes-Benz Specifications for Service Products, MB Specifications for Service Products 310.1, e.g. on the Internet at <http://bevo.mercedes-benz.com>. Or contact a qualified specialist workshop.

! Always use a suitable coolant mixture, even in countries where high temperatures prevail. Otherwise, the engine cooling system is not sufficiently protected from corrosion and overheating.

Comply with the important safety precautions for service products when handling coolant (▷ page 444).

The coolant is a mixture of water and antifreeze/corrosion inhibitor. It performs the following tasks:

- corrosion protection
- antifreeze protection
- raising the boiling point

If the coolant has antifreeze protection down to -35 °F (-37 °C), the boiling point of the coolant during operation is approximately 266 °F (130 °C).

The antifreeze/corrosion inhibitor concentration in the engine cooling system should:

- be at least 50%. This will protect the engine cooling system against freezing down to approximately -35 °F (-37 °C).
- not exceed 55% (antifreeze protection down to -49 °F [-45 °C]). Otherwise, heat will not be dissipated as effectively.

If the vehicle has lost coolant, add equal amounts of water and antifreeze/corrosion inhibitor.

Mercedes-Benz recommends an antifreeze/corrosion inhibitor concentrate in accordance with MB Specifications for Service Products 310.1.

The coolant is checked with every maintenance interval at a qualified specialist workshop.

i When the vehicle is first delivered, it is filled with a coolant mixture that ensures adequate antifreeze and corrosion protection.

Filling capacities

| Model | Capacity |
|-------------------------------------|-----------------------------|
| ML 350 BlueEFFICIENCY | Approx. 11.1 US qt (10.5 l) |
| ML 350 4MATIC BlueEFFICIENCY | |
| ML 550 4MATIC BlueEFFICIENCY | Approx. 13.6 US qt (12.9 l) |
| ML 63 AMG | Approx. 12.4 US qt (11.7 l) |
| ML 350 BlueTEC 4 MATIC | Approx. 12.2 US qt (11.5 l) |

i Use MB 325.0 or MB 326.0 corrosion inhibitor/antifreeze.

Windshield washer system and headlamp cleaning system

Important safety notes

WARNING

Windshield washer concentrate is highly flammable. If it comes into contact with hot engine components or the exhaust system it could ignite. There is a risk of fire and injury. Make sure that no windshield washer concentrate is spilled next to the filler neck.

! Only use washer fluid that is suitable for plastic lamp lenses, e.g. MB SummerFit or MB WinterFit. Unsuitable washer fluid could damage the plastic lenses of the headlamps.

! Do not add distilled or de-ionized water to the washer fluid container. Otherwise, the level sensor may be damaged.

! Only MB SummerFit and MB WinterFit washer fluid should be mixed together. The spray nozzles may otherwise become blocked.

Comply with the important safety notes for service products when handling washer fluid (▷ page 444).

At temperatures above freezing:

► Fill the washer fluid reservoir with a mixture of water and windshield washer fluid, e.g. MB SummerFit.

Add 1 part MB SummerFit to 100 parts water.

At temperatures below freezing:

► Fill the washer fluid reservoir with a mixture of water and washer fluid, e.g. MB WinterFit.

Adapt the mixing ratio to the outside temperature.

- Down to 14 °F (-10 °C): mix 1 part MB WinterFit to 2 parts water.
- Down to -4 °F (-20 °C): mix 1 part MB WinterFit to 1 part water.
- Down to -20.2 °F (-29 °C): mix 2 parts MB WinterFit to 1 part water.

i Add windshield washer fluid, e.g. MB SummerFit or MB WinterFit, to the washer fluid all year round.

Filling capacities

| Model | Capacity |
|--------------------------------------|-------------------|
| All models (except for AMG vehicles) | 5.5 US qt (5.2 l) |
| AMG vehicles | 6.3 US qt (6.0 l) |

Vehicle data

General notes

Please note that for the specified vehicle data:

- The heights specified may vary as a result of:
 - tires
 - load
 - condition of the suspension
 - optional equipment

Observe the information relating to level control:

- AIRMATIC package (▷ page 210)
- ON&OFFROAD package (▷ page 204)

Dimensions and weights



| Models with: | ① Opening height | ② Max. headroom |
|--------------------|--|--|
| Steel suspension | 86.4 in (2195 mm) | 78.2 in (1987 mm) |
| AIRMATIC package | 84.3 in - 87.2 in (2140 mm - 2215 mm) | 76.0 in - 79.0 in (1931 mm - 2006 mm) |
| ON&OFFROAD package | 84.3 in - 88.4 in (2140 mm - 2245 mm) | 76.0 in - 80.2 in (1931 mm - 2036 mm) |

| | ① Opening height | ② Max. headroom |
|--------------|--|--|
| AMG vehicles | 84.6 in - 86.9 in (2148 mm - 2208 mm) | 76.3 in - 78.7 in (1938 mm - 1998 mm) |

| All models (except for AMG vehicles) | |
|--|----------------------|
| Vehicle width including exterior mirrors | 84.3 in (2141 mm) |
| Vehicle height (steel suspension) | 70.7 in (1796 mm) |

| All models (except for AMG vehicles) | |
|--|-----------------------|
| Maximum vehicle height (AIRMATIC package) | 71.6 in (1818 mm) |
| Maximum vehicle height (ON&OFFROAD package) | 72.8 in (1848 mm) |
| Minimum vehicle height (highway driving level) | 69.2 in (1758 mm) |
| Wheelbase | 114.8 in (2915 mm) |
| Maximum ground clearance (AIRMATIC package) | 10.0 in (255 mm) |
| Maximum ground clearance (ON&OFFROAD package) | 11.2 in (285 mm) |
| Minimum ground clearance (AIRMATIC package) (ON&OFFROAD package) | 7.1 in (180 mm) |
| Ground clearance (steel suspension) | 8.0 in (202 mm) |
| Turning radius | 38.7 ft (11.80 m) |
| Maximum roof load | 220 lb (100 kg) |

| ML 350 BlueEFFICIENCY ML 350 4MATIC BlueEFFICIENCY ML 350 BlueTEC 4MATIC | |
|---|-----------------------|
| Vehicle length | 189.1 in (4804 mm) |

**ML 550 4MATIC
BlueEFFICIENCY**

| | |
|-----------------------|-----------------------|
| Vehicle length | 190.5 in (4839 mm) |
|-----------------------|-----------------------|

ML 63 AMG

| | |
|-----------------------|-----------------------|
| Vehicle length | 189.6 in (4817 mm) |
|-----------------------|-----------------------|

| | |
|---|----------------------|
| Vehicle width including exterior mirrors | 84.3 in (2141 mm) |
|---|----------------------|

| | |
|-------------------------------|----------------------|
| Maximum vehicle height | 71.3 in (1812 mm) |
|-------------------------------|----------------------|

| | |
|-------------------------------|----------------------|
| Minimum vehicle height | 69.0 in (1752 mm) |
|-------------------------------|----------------------|

| | |
|------------------|-----------------------|
| Wheelbase | 114.8 in (2915 mm) |
|------------------|-----------------------|

| | |
|---------------------------------|--------------------|
| Maximum ground clearance | 9.1 in (231 mm) |
|---------------------------------|--------------------|

| | |
|---------------------------------|--------------------|
| Minimum ground clearance | 6.7 in (171 mm) |
|---------------------------------|--------------------|

| | |
|-----------------------|----------------------|
| Turning radius | 38.7 ft (11.80 m) |
|-----------------------|----------------------|

| | |
|--------------------------|--------------------|
| Maximum roof load | 220 lb (100 kg) |
|--------------------------|--------------------|

Technical data

Trailer tow hitch**Mounting dimensions**

! If you have a trailer tow hitch retrofitted, changes to the cooling system and drive train may be necessary, depending on the vehicle type.

If you have a trailer tow hitch retrofitted, observe the anchorage points on the chassis frame.

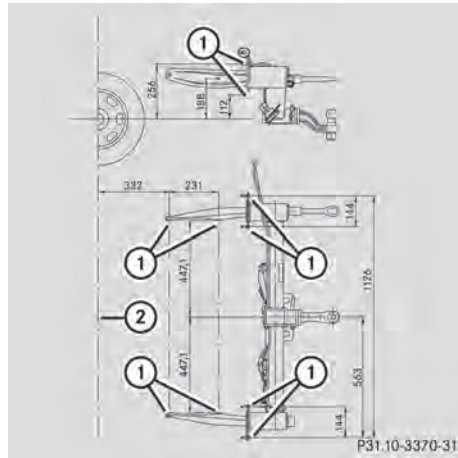

Anchorage points for the trailer tow hitch (example)

- ① Anchorage points
- ② Rear axle center line

Trailer loads

Trailer loads, trailer drawbar noseweights and axle loads

Missing values were not available at time of going to print.

| | All models (except AMG vehicles and ML 350 BlueEFFICIENCY) |
|---|--|
| Permissible trailer load, unbraked | |
| Permissible trailer load, braked (at a minimum gradient-climbing capability of 12% from a standstill) | 7 198 lbs (3265 kg) |
| Maximum drawbar noseweight (the drawbar noseweight is not included in the trailer load) | 575 lbs (261 kg) |
| Permissible rear axle load when towing a trailer | 3527 lbs (1600 kg) For model ML 350 BlueTEC 4MATIC: 3637 lbs (1650 kg) |

| | ML 350 BlueEFFICIENCY |
|---|-----------------------|
| Permissible trailer load, unbraked | |
| Permissible trailer load, braked (at a minimum gradient-climbing capability of 12% from a standstill) | 6613 lbs (3000 kg) |
| Maximum drawbar noseweight (the drawbar noseweight is not included in the trailer load) | 529 lbs (240 kg) |
| Permissible rear axle load when towing a trailer | 3527 lbs (1600 kg) |

| | ML 63 AMG |
|---|---------------------|
| Permissible trailer load, unbraked | 1653 lbs (750 kg) |
| Permissible trailer load, braked (at a minimum gradient-climbing capability of 12% from a standstill) | 7 198 lbs (3265 kg) |

| | ML 63 AMG |
|--|--------------------|
| Maximum drawbar noseweight (the drawbar noseweight is not included in the trailer load) | 575 lbs (261 kg) |
| Permissible rear axle load when towing a trailer | 3637 lbs (1650 kg) |

Ball position

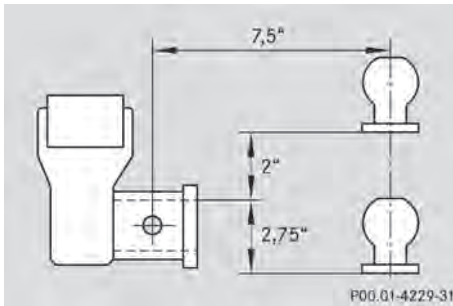

Ball position of the ball coupling

When choosing a ball coupling, the dimensions stated in the illustration must not be exceeded.



1665848681

Order no. 6515 0442 13 Part no. 166 584 86 81 Edition B 2013