



# CLS

Operator's Manual



Mercedes-Benz

## Symbols

Registered trademarks:

- Bluetooth® is a registered trademark of Bluetooth SIG Inc.
- DTS is a registered trademark of DTS, Inc.
- Dolby and MLP are registered trademarks of DOLBY Laboratories.
- BabySmart™, ESP® and PRE-SAFE® are registered trademarks of Daimler AG.
- HomeLink® is a registered trademark of Johnson Controls.
- iPod® and iTunes® are registered trademarks of Apple Inc.
- Logic7® is a registered trademark of Harman International Industries.
- Microsoft® and Windows media® are registered trademarks of Microsoft Corporation.
- SIRIUS is a registered trademark of Sirius XM Radio Inc.
- HD Radio is a registered trademark of iBiquity Digital Corporation.
- Gracenote® is a registered trademark of Gracenote, Inc.
- ZAGATSurvey® and related brands are registered trademarks of ZagatSurvey, LLC.

In this Operator's Manual you will find the following symbols:

### **WARNING**

Warning notes make you aware dangers which could pose a threat to your health or life, or to the health and life of others.

### **Environmental note**

Environmental notes provide you with information on environmentally aware actions or disposal.

- ! Notes on material damage alert you to dangers that could lead to damage to your vehicle.

- i Practical tips or further information that could be helpful to you.

▶ This symbol indicates an instruction that must be followed.

▶ Several of these symbols in succession indicate an instruction with several steps.

(▷ page) This symbol tells you where you can find more information about a topic.

▷▷ This symbol indicates a warning or an instruction that is continued on the next page.

**Display** This font indicates a display in the multifunction display/COMAND display.



This symbol tells you that you can find further information in the Digital Operator's Manual.

Parts of the software in the vehicle are protected by copyright © 2005 The FreeType Project <http://www.freetype.org>. All rights reserved.

## **Welcome to the world of Mercedes-Benz**

We urge you to read this Operator's Manual carefully and familiarize yourself with the vehicle before driving. For your own safety and a longer vehicle life, follow the instructions and warning notices in this manual. Ignoring them could result in damage to the vehicle or personal injury to you or others.

Vehicle damage caused by failure to follow instructions is not covered by the Mercedes-Benz Limited Warranty.

This Operator's Manual provides information on the most important functions of your vehicle.

Additional information on convenience functions can be found in COMAND in your Digital Operator's Manual.

The equipment or product designation of your vehicle may vary depending on:

- model
- order
- country specification
- availability

Mercedes-Benz therefore reserves the right to introduce changes in the following areas:

- design
- equipment
- technical features

The equipment in your vehicle may therefore differ from that shown in the descriptions and illustrations.

The following are integral components of the vehicle:

- Digital Operator's Manual
- Operator's Manual
- Maintenance Booklet
- Equipment-dependent supplements

Keep printed copies of the documents in the vehicle at all times. If you sell the vehicle, always pass the documents on to the new owner.

The technical documentation team at Daimler AG wishes you safe and pleasant motoring.

Mercedes-Benz USA, LLC

Mercedes-Benz Canada, Inc.

A Daimler Company

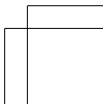
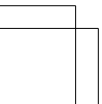
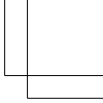
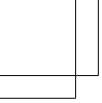

<b>Index</b> .....	<b>4</b>	<b>At a glance</b> .....	<b>35</b>
<b>Digital Operator's Manual</b> .....	<b>22</b>	<b>Safety</b> .....	<b>45</b>
<b>Introduction</b> .....	<b>27</b>	<b>Opening and closing</b> .....	<b>83</b>
		<b>Seats, steering wheel and mirrors</b> ....	<b>99</b>
		<b>Lights and windshield wipers</b> .....	<b>105</b>
		<b>Climate control</b> .....	<b>113</b>
		<b>Driving and parking</b> .....	<b>119</b>
		<b>On-board computer and displays</b> ....	<b>159</b>
		<b>COMAND</b> .....	<b>187</b>
		<b>Stowage and features</b> .....	<b>203</b>
		<b>Maintenance and care</b> .....	<b>219</b>
		<b>Breakdown assistance</b> .....	<b>227</b>
		<b>Wheels and tires</b> .....	<b>241</b>
		<b>Technical data</b> .....	<b>279</b>

## 1, 2, 3 ...

**12 V socket**

see Sockets

**4ETS**see ETS/4ETS (Electronic  
Traction System)**4MATIC (permanent four-wheel  
drive)** ..... 142**A****ABS (Anti-lock Braking System)**

Display message ..... 163, 164

Function/notes ..... 72

Important safety notes ..... 72

Warning lamp ..... 177

**Activating/deactivating cooling  
with air dehumidification** ..... 118**Active Blind Spot Assist**Activating/deactivating (on-  
board computer) ..... 161

Display message ..... 163

Function/information ..... 152

**Active Driving Assistance package** . 152**Active Lane Keeping Assist**Activating/deactivating (on-  
board computer) ..... 161

Display message ..... 163

Function/information ..... 155

**Active light function** ..... 108**Active Parking Assist**

Display message ..... 163

Function/notes ..... 144

Important safety notes ..... 144

**ADAPTIVE BRAKE** ..... 78**Adaptive Damping System (ADS)** ..... 141**Adaptive Highbeam Assist**

Display message ..... 163

Function/notes ..... 108

Switching on/off ..... 109

**Address book**

see also Digital Operator's Manual 188

**Air bags**

Display message ..... 169

Front air bag (driver, front  
passenger) ..... 50

Important safety notes ..... 48

Knee bag ..... 51

PASSENGER AIR BAG OFF

indicator lamp ..... 53

Pelvis air bag ..... 52

Safety guidelines ..... 47

Side impact air bag ..... 51

Window curtain air bag ..... 53

**Air-conditioning system**

see Climate control

**AIR FLOW** ..... 118**AIRMATIC**

Function/notes ..... 140

**AIRSCARF**

Switching on/off ..... 102

**Air vents**

Switching AIRSCARF on/off ..... 102

see Climate control

**Alarm**

ATA (Anti-Theft Alarm system) ..... 80

Switching off (ATA) ..... 80

Switching the function on/off  
(ATA) ..... 80**Alarm system**

see ATA (Anti-Theft Alarm system)

**Ambient lighting**Setting the brightness (on-board  
computer) ..... 161Setting the color (on-board  
computer) ..... 161**AMG adaptive sport suspension**

system ..... 141

**AMG menu (on-board computer)** ..... 161**Anti-lock braking system**

see ABS (Anti-lock Braking System)

**Anti-Theft Alarm system**

see ATA (Anti-Theft Alarm system)

**Ashtray** ..... 208**Assistance display (on-board****computer)** ..... 161**Assistance menu (on-board****computer)** ..... 161**ASSYST PLUS**

Displaying a service message ..... 224

Hiding a service message ..... 224

Notes ..... 224

Resetting the service interval

display ..... 224

- Service message ..... 224
  - Special service requirements ..... 224
  - ATA (Anti-Theft Alarm system)**
    - Activating/deactivating ..... 80
    - Function ..... 80
    - Switching off the alarm ..... 80
  - ATTENTION ASSIST**
    - Activating/deactivating ..... 161
    - Display message ..... 163
    - Function/notes ..... 146
    - see ATTENTION ASSIST
  - Authorized Mercedes-Benz Center**
    - see Qualified specialist workshop
  - Authorized workshop**
    - see Qualified specialist workshop
  - AUTO lights**
    - Display message ..... 163
  - Automatic engine start (ECO start/stop function)** ..... 125
  - Automatic engine switch-off (ECO start/stop function)** ..... 125
  - Automatic headlamp mode** ..... 107
  - Automatic transmission**
    - Automatic drive program ..... 126
    - Changing gear ..... 126
    - DIRECT SELECT lever ..... 126
    - Display message ..... 163
    - Driving tips ..... 126
    - Emergency running mode ..... 126
    - Kickdown ..... 126
    - Manual drive program (AMG vehicles) ..... 126
    - Manual drive program (vehicles with Sports package AMG) ..... 126
    - Overview ..... 125
    - Problem (malfunction) ..... 126
    - Program selector button ..... 126
    - Pulling away ..... 124
    - Selector lever ..... 125
    - Starting the engine ..... 123
    - Steering wheel paddle shifters ..... 126
    - Transmission position display ..... 125
    - Transmission positions ..... 126
  - Automatic transmission emergency mode** ..... 126
- B**
- Back button** ..... 197
  - Backup lamp**
    - Changing bulbs ..... 110
  - Bag hook** ..... 207
  - BAS (Brake Assist System)** ..... 73
  - BAS PLUS (Brake Assist System PLUS)** ..... 73
  - Battery (SmartKey)**
    - Checking ..... 87
    - Replacing ..... 87
  - Battery (vehicle)**
    - Charging ..... 232
    - Important safety notes ..... 230
    - Jump starting ..... 234
  - Belt**
    - see Seat belts
  - Belt force limiter**
    - Activation ..... 65
    - Function ..... 65
  - Blind Spot Assist**
    - Activating/deactivating ..... 161
    - Notes/function ..... 149
    - see Active Blind Spot Assist
  - Bluetooth®**
    - see also Digital Operator's Manual 188
  - Bottle holder** ..... 208
  - Brake Assist**
    - see BAS (Brake Assist System)
  - Brake fluid**
    - Display message ..... 166
    - Notes ..... 282
  - Brake lamps**
    - Display message ..... 163
  - Brakes**
    - ABS ..... 72
    - BAS ..... 73
    - BAS PLUS ..... 73
    - Brake fluid (notes) ..... 282
    - Display message ..... 163, 164
    - High-performance brake system .... 131
    - HOLD function ..... 139
    - Important safety notes ..... 131
    - Maintenance ..... 131
    - Parking brake ..... 131
    - Warning lamp ..... 174, 176

- Breakdown**
    - see Flat tire
    - see Towing away
  - Bulbs**
    - see Replacing bulbs
  - Buttons on the COMAND controller** 197
- C**
- California**
    - Important notice for retail customers and lessees ..... 29
  - Calling up a malfunction**
    - see Display messages
  - Car**
    - see Vehicle
  - Care**
    - Carpets ..... 226
    - Car wash ..... 224
    - Display ..... 226
    - Exterior lights ..... 225
    - Gear or selector lever ..... 226
    - Interior ..... 226
    - Matte finish ..... 225
    - Night View Assist Plus ..... 226
    - Notes ..... 224
    - Paint ..... 225
    - Plastic trim ..... 226
    - Power washer ..... 225
    - Rear view camera ..... 225
    - Roof lining ..... 226
    - Seat belt ..... 226
    - Seat cover ..... 226
    - Sensors ..... 225
    - Tail pipes ..... 225
    - Trim pieces ..... 226
    - Washing by hand ..... 225
    - Wheels ..... 225
    - Windows ..... 225
    - Wiper blades ..... 225
    - Wooden trim ..... 226
  - Cargo tie down rings** ..... 206
  - Car key**
    - see SmartKey
  - Car wash (care)** ..... 224
  - CD**
    - see also Digital Operator's Manual 188
  - CD player/CD changer (on-board computer)** ..... 161
  - Center console**
    - Lower section ..... 41
    - Lower section (AMG vehicles) ..... 42
    - Upper section ..... 40
  - Central locking**
    - Automatic locking (on-board computer) ..... 161
    - Locking/unlocking (SmartKey) ..... 85
  - Changing bulbs**
    - Reversing lamps ..... 110
  - Child-proof locks**
    - Important safety notes ..... 71
    - Rear doors ..... 71
  - Children**
    - In the vehicle ..... 66
    - Restraint systems ..... 66
    - Special seat belt retractor ..... 69
  - Child seat**
    - LATCH-type (ISOFIX) child seat anchors ..... 69
    - Top Tether ..... 70
  - Cigarette lighter** ..... 208
  - Cleaning**
    - Mirror turn signal ..... 225
  - Clear button** ..... 197
  - Climate control**
    - Automatic climate control (3-zone) 117
    - Controlling automatically ..... 118
    - Cooling with air dehumidification . . 118
    - Defrosting the windows ..... 118
    - Defrosting the windshield ..... 118
    - Dual-zone automatic climate control ..... 115
    - Important safety notes ..... 114
    - Indicator lamp ..... 118
    - Maximum cooling ..... 118
    - Overview of systems ..... 114
    - Problems with cooling with air dehumidification ..... 118
    - Problem with the rear window defroster ..... 118
    - Rear control panel ..... 117
    - Refrigerant ..... 284
    - Refrigerant filling capacity ..... 284
    - Setting the air distribution ..... 118
    - Setting the airflow ..... 118



- Setting the air vents ..... 118
  - Setting the climate mode (AIR FLOW) ..... 118
  - Setting the temperature ..... 118
  - Switching air-recirculation mode on/off ..... 118
  - Switching on/off ..... 118
  - Switching residual heat on/off ..... 118
  - Switching the rear window defroster on/off ..... 118
  - Switching the ZONE function on/off ..... 118
  - Cockpit**
    - Overview ..... 36
    - see Instrument cluster
  - Collapsible spare wheel**
    - Inflating ..... 276
    - see Emergency spare wheel
  - COMAND**
    - Display ..... 191
    - Examples of operation ..... 197
    - Menu overview ..... 192
  - COMAND controller** ..... 196
  - COMAND control panel** ..... 195
  - Combination switch** ..... 107
  - Connecting a USB device**
    - see also Digital Operator's Manual ..... 188
  - Consumption statistics (on-board computer)** ..... 161
  - Convenience telephony**
    - see also Digital Operator's Manual ..... 188
  - Coolant (engine)**
    - Checking the level ..... 223
    - Display message ..... 171
    - Filling capacity ..... 283
    - Important safety notes ..... 282
    - Temperature (on-board computer) ..... 161
    - Temperature gauge ..... 160
    - Warning lamp ..... 183
  - Cooling**
    - see Climate control
  - Copyright** ..... 34
  - Cornering light function**
    - Display message ..... 163
    - Function/notes ..... 107
  - Crash-responsive emergency lighting** ..... 109
  - Cruise control**
    - Activation conditions ..... 132
    - Cruise control lever ..... 132
    - Deactivating ..... 132
    - Display message ..... 163
    - Driving system ..... 131
    - Function/notes ..... 131
    - Important safety notes ..... 131
    - Selecting ..... 132
    - Setting a speed ..... 132
    - Storing and maintaining current speed ..... 132
  - Cup holder**
    - Center console ..... 208
    - Important safety notes ..... 208
    - Rear compartment ..... 208
    - see Cup holder
  - Customer Assistance Center (CAC) ...** 32
  - Customer Relations Department** ..... 32
- ## D
- Dashboard**
    - see Instrument cluster
  - Data**
    - see Technical data
  - Daytime running lamps**
    - Display message ..... 163
    - Switching on/off (on-board computer) ..... 161
    - Switching on/off (switch) ..... 107
  - Declarations of conformity** ..... 31
  - Delayed switch-off**
    - Exterior lighting (on-board computer) ..... 161
    - Interior lighting ..... 161
  - Diagnostics connection** ..... 31
  - Digital Operator's Manual**
    - Contents ..... 25
    - Installation ..... 22
    - Introduction ..... 22
    - Keyword search ..... 24
    - Operating notes ..... 23
    - Visual search ..... 23
  - Digital speedometer** ..... 161
  - DIRECT SELECT lever**
    - see Automatic transmission
  - Display (cleaning instructions)** ..... 226

- Display messages**
  - ASSYST PLUS ..... 224
  - Calling up (on-board computer) ..... 163
  - Driving systems ..... 163
  - Engine ..... 163, 171
  - General notes ..... 163
  - Hiding (on-board computer) ..... 163
  - KEYLESS-GO ..... 163
  - Lights ..... 163
  - Safety systems ..... 163, 164
  - SmartKey ..... 163
  - Tires ..... 163, 172
  - Vehicle ..... 163, 173
- Distance recorder** ..... 161
  - see Odometer
  - see Trip odometer
- Distance warning (warning lamp)** ..... 174, 184
- DISTRONIC PLUS**
  - Activating ..... 134
  - Activation conditions ..... 134
  - Deactivating ..... 137
  - Display message ..... 163
  - Displays in the multifunction display ..... 137
  - Function/notes ..... 132
  - Important safety notes ..... 133
  - Setting the specified minimum distance ..... 137
  - Warning lamp ..... 174, 184
- Doors**
  - Automatic locking (on-board computer) ..... 161
  - Automatic locking (switch) ..... 90
  - Central locking/unlocking (SmartKey) ..... 85
  - Control panel ..... 44
  - Display message ..... 163
  - Emergency locking ..... 90
  - Emergency unlocking ..... 90
  - Important safety notes ..... 89, 90
  - Opening (from inside) ..... 90
- Drive program**
  - Automatic ..... 126
  - Display ..... 125
  - Manual (AMG vehicles) ..... 126
  - Manual (vehicles with Sports package AMG) ..... 126
  - SETUP (on-board computer) ..... 161
- Drive program selector** ..... 126
- Driver's door**
  - see Doors
- Driving abroad**
  - Mercedes-Benz Service ..... 224
  - Symmetrical low beam ..... 106
- Driving on flooded roads** ..... 131
- Driving safety systems**
  - ABS (Anti-lock Braking System) ..... 72
  - ADAPTIVE BRAKE ..... 78
  - BAS (Brake Assist System) ..... 73
  - BAS PLUS (Brake Assist System PLUS) ..... 73
  - Electronic brake force distribution ... 78
  - ESP® (Electronic Stability Program) . 74
  - ETS/4ETS (Electronic Traction System) ..... 75
  - Important safety information ..... 72
  - Overview ..... 72
  - PRE-SAFE® Brake ..... 78
- Driving systems**
  - Active Blind Spot Assist ..... 152
  - Active Driving Assistance package 152
  - Active Lane Keeping Assist ..... 155
  - Active Parking Assist ..... 144
  - AIRMATIC ..... 140
  - AMG adaptive sport suspension system ..... 141
  - ATTENTION ASSIST ..... 146
  - Blind Spot Assist ..... 149
  - Cruise control ..... 131
  - Display message ..... 163
  - DISTRONIC PLUS ..... 132
  - HOLD function ..... 139
  - Lane Keeping Assist ..... 151
  - Lane Tracking package ..... 149
  - Night View Assist Plus ..... 147
  - PARKTRONIC ..... 142
  - RACE START (AMG vehicles) ..... 140
  - Rear view camera ..... 145
- Driving tips**
  - AMG ceramic brakes ..... 131
  - Automatic transmission ..... 126
  - Break-in period ..... 120

- Downhill gradient ..... 131
  - Driving abroad ..... 106
  - Driving on flooded roads ..... 131
  - Driving on wet roads ..... 131
  - General ..... 131
  - Hydroplaning ..... 131
  - Icy road surfaces ..... 131
  - Limited braking efficiency on salted roads ..... 131
  - Snow chains ..... 244
  - Symmetrical low beam ..... 106
  - Wet road surface ..... 131
  - DVD audio**
    - Operating (on-board computer) ..... 161
    - see also Digital Operator's Manual 188
  - DVD video**
    - Operating (on-board computer) ..... 161
    - see also Digital Operator's Manual 188
- E**
- EASY-ENTRY feature**
    - Activating/deactivating ..... 161
    - Function/notes ..... 103
  - EASY-EXIT feature**
    - Function/notes ..... 103
    - Switching on/off ..... 161
  - EBD (electronic brake force distribution)**
    - Display message ..... 166
    - Function/notes ..... 78
  - ECO display**
    - Function/notes ..... 131
  - ECO start/stop function**
    - Automatic engine start ..... 125
    - Automatic engine switch-off ..... 125
    - Deactivating/activating ..... 125
    - General information ..... 125
    - Important safety notes ..... 125
    - Introduction ..... 124
  - Electronic Stability Program**
    - see ESP® (Electronic Stability Program)
  - Emergency release**
    - Driver's door ..... 90
    - Fuel filler flap ..... 129
  - Trunk ..... 93
  - Vehicle ..... 90
  - Emergency spare wheel**
    - General notes ..... 274
    - Important safety notes ..... 274
    - Removing ..... 275
    - Storage location ..... 275
    - Stowing ..... 275
    - Technical data ..... 277
  - Emergency Tensioning Devices**
    - Function ..... 65
    - Safety guidelines ..... 47
  - Emissions control**
    - Service and warranty information .... 28
  - Engine**
    - Check Engine warning lamp ..... 174
    - Display message ..... 163, 171
    - ECO start/stop function ..... 124
    - Engine number ..... 280
    - Irregular running ..... 125
    - Jump-starting ..... 234
    - Starting problems ..... 125
    - Starting the engine with the SmartKey ..... 123
    - Starting with KEYLESS-GO ..... 123
    - Switching off ..... 131
    - Tow-starting (vehicle) ..... 239
  - Engine electronics**
    - Problem (malfunction) ..... 125
  - Engine jump starting**
    - see Jump starting (engine)
  - Engine oil**
    - Adding ..... 222
    - Checking the oil level ..... 221
    - Checking the oil level using the dipstick ..... 221
    - Display message ..... 163
    - Filling capacity ..... 282
    - Notes about oil grades ..... 282
    - Notes on oil level/consumption .... 221
    - Temperature (on-board computer) ..... 161
  - Entering a city**
    - see also Digital Operator's Manual 188
  - Entering an address**
    - see also Digital Operator's Manual 188

**ESP® (Electronic Stability Program)**

AMG menu (on-board computer) .....	161
Characteristics .....	75
Deactivating/activating (AMG vehicles) .....	76
Deactivating/activating (except AMG vehicles) .....	161
Deactivating/activating (notes; except AMG vehicles) .....	76
Display message .....	163, 164
ETS/4ETS .....	75
Function/notes .....	74
General notes .....	74
Important safety information .....	75
Warning lamp .....	179

**ETS/4ETS (Electronic Traction System)**

.....	75
-------	----

**Exhaust tail pipe (cleaning instructions)**

.....	225
-------	-----

**Exterior lighting**

Setting options .....	106
see Lights	

**Exterior mirrors**

Adjusting .....	103
Dipping (automatic) .....	103
Folding in/out (automatically) .....	103
Folding in/out (electrically) .....	103
Folding in when locking (on-board computer) .....	161
Setting .....	103
Storing settings (memory function) .....	103
Storing the parking position .....	103

<b>Eyeglasses compartment</b> .....	205
-------------------------------------	-----

**F****Filler cap**

see Fuel filler flap	
----------------------	--

**Flat tire**

MOExtended tires .....	229
Preparing the vehicle .....	228

<b>Floormats</b> .....	216
------------------------	-----

**Front fog lamps**

Display message .....	163
-----------------------	-----

**Front windshield**

see Windshield	
----------------	--

**Fuel**

Consumption statistics .....	161
Displaying the current consumption .....	161
Displaying the range .....	161
Fuel gauge .....	37, 160
Important safety notes .....	281
Problem (malfunction) .....	130
Refueling .....	127
Tank content/reserve fuel .....	281

**Fuel filler flap**

Emergency release .....	129
Opening .....	128

**Fuel level**

Calling up the range (on-board computer) .....	161
------------------------------------------------	-----

**Fuel tank**

Capacity .....	281
Problem (malfunction) .....	130

**Fuse allocation chart (vehicle tool kit)**

.....	228
-------	-----

**Fuses**

Allocation chart .....	239
Before changing .....	239
Fuse box in the engine compartment .....	240
Fuse box in the trunk .....	240
Important safety notes .....	239
see Fuses	

**G****Garage door opener**

Clearing the memory .....	216
General notes .....	213
Important safety notes .....	214
Opening/closing the garage door ..	216
Programming (button in the rear-view mirror) .....	214

**Gear indicator (on-board computer)**

.....	161
-------	-----

**Gear or selector lever (cleaning guidelines)**

.....	226
-------	-----

**Genuine parts**

.....	27
-------	----

**Glove box**

.....	205
-------	-----

**Google™ Local Search**

see also Digital Operator's Manual	188
------------------------------------	-----

**H**

<b>Hazard warning lamps</b> .....	106
<b>Head bags</b>	
Display message .....	167
<b>Headlamps</b>	
Adding fluid to cleaning system .....	223
Cleaning system (function) ....	106, 107
Cleaning system (notes) .....	283
Fogging up .....	106
see Automatic headlamp mode	
<b>Head level heating (AIRSCARF)</b> .....	102
<b>Head restraints</b>	
Adjusting .....	102
Adjusting (rear) .....	102
<b>Heating</b>	
see Climate control	
<b>High-beam headlamps</b>	
Adaptive Highbeam Assist .....	108
Display message .....	163
Switching on/off .....	107
<b>Hill start assist</b> .....	124
<b>HOLD function</b>	
Activating .....	139
Deactivating .....	139
Function/notes .....	139
<b>Home address</b>	
see also Digital Operator's Manual	188
<b>Hood</b>	
Closing .....	221
Display message .....	173
Important safety notes .....	220
Opening .....	220
<b>Hydroplaning</b> .....	131

**I**

<b>Ignition lock</b>	
see Key positions	
<b>Immobilizer</b> .....	80
<b>Indicator lamps</b>	
see Warning and indicator lamps	
<b>Indicators</b>	
see Turn signals	
<b>Instrument cluster</b>	
Overview .....	37, 160
Settings .....	161
Warning and indicator lamps ...	38, 174

<b>Instrument cluster lighting</b> .....	161
------------------------------------------	-----

**Interior lighting**

Automatic control .....	109
Delayed switch-off (on-board computer) .....	161
Emergency lighting .....	109
Manual control .....	109
Overview .....	109
Reading lamp .....	109
Setting the brightness of the ambient lighting (on-board computer) .....	161
Setting the brightness of the display/switch (on-board computer) .....	161
Setting the color of the ambient lighting (on-board computer) .....	161

**Internet**

Calling up the carousel view .....	200
Conditions for access .....	198
Entering the URL .....	200

**Internet radio**

Calling up .....	199
Searching for stations .....	199

**iPod®**

see also Digital Operator's Manual	188
------------------------------------	-----

**J****Jack**

Storage location .....	228
Using .....	266

<b>Jump starting (engine)</b> .....	234
-------------------------------------	-----

**K****KEYLESS-GO**

Display message .....	163
Locking .....	85
Start/Stop button .....	121
Starting the engine .....	123
Unlocking .....	85

**Key positions**

KEYLESS-GO .....	121
SmartKey .....	121

**Kickdown**

Driving tips .....	126
Manual drive program .....	127

- Knee bag** ..... 51
- L**
- Lamps**  
see Warning and indicator lamps
- Lane Keeping Assist**  
Activating/deactivating ..... 161  
Function/information ..... 151
- Lane Tracking package** ..... 149
- Lap time (RACETIMER)** ..... 161
- LATCH-type (ISOFIX) child seat anchors** ..... 69
- License plate lamp (display message)** ..... 163
- Light function, active**  
Display message ..... 163
- Lighting**  
Light switch ..... 106
- Lights**  
Activating/deactivating the interior lighting delayed switch-off ..... 161  
Active light function ..... 108  
Adaptive Highbeam Assist ..... 108  
Automatic headlamp mode ..... 107  
Cornering light function ..... 107  
Driving abroad ..... 106  
Hazard warning lamps ..... 106  
High beam flasher ..... 107  
High-beam headlamps ..... 107  
Low-beam headlamps ..... 107  
Parking lamps ..... 107  
Setting the brightness of the ambient lighting (on-board computer) ..... 161  
Setting the brightness of the display/switch (on-board computer) ..... 161  
Setting the color of the ambient lighting (on-board computer) ..... 161  
Standing lamps ..... 107  
Switching the daytime running lamps on/off (on-board computer) ..... 161  
Switching the daytime running lamps on/off (switch) ..... 107  
Switching the exterior lighting delayed switch-off on/off (on-board computer) ..... 161  
Switching the surround lighting on/off (on-board computer) ..... 161  
Turn signals ..... 107  
see Lighting  
see Replacing bulbs
- Light sensor (display message)** ..... 163
- Loading guidelines** ..... 204
- Locking**  
see Central locking
- Locking (doors)**  
Automatic ..... 90  
Emergency locking ..... 90  
From inside (central locking button) ..... 90
- Locking centrally**  
see Central locking
- Locking verification signal (on-board computer)** ..... 161
- Low-beam headlamps**  
Display message ..... 163  
Setting for driving abroad (symmetrical) ..... 106  
Switching on/off ..... 107
- Lumbar support**  
Adjusting the 4-way lumbar support ..... 102
- M**
- M+S tires** ..... 244
- Maintenance**  
see ASSYST PLUS
- Malfunction message**  
see Display messages
- Matte finish (cleaning instructions)** 225
- mbrace**  
Call priority ..... 213  
Display message ..... 163  
Downloading destinations (COMAND) ..... 208  
Downloading routes ..... 208  
Emergency call ..... 210  
General notes ..... 209  
Geo fencing ..... 208  
Locating a stolen vehicle ..... 208

- MB info call button ..... 212
  - Remote vehicle locking ..... 208
  - Roadside Assistance button ..... 211
  - Search & Send ..... 208
  - Self-test ..... 209
  - Speed alert ..... 208
  - System ..... 209
  - Triggering the vehicle alarm ..... 208
  - Vehicle remote malfunction diagnosis ..... 208
  - Vehicle remote unlocking ..... 208
  - Mechanical key**
    - Function/notes ..... 86
    - Inserting ..... 86
    - Locking vehicle ..... 90
    - Removing ..... 86
    - Unlocking the driver's door ..... 90
  - Media Interface**
    - see Separate operating instructions
  - Memory card (audio)** ..... 161
  - Memory function** ..... 103
  - Message memory (on-board computer)** ..... 163
  - Messages**
    - see Display messages
  - Mirrors**
    - see Exterior mirrors
    - see Vanity mirror (in the sun visor)
  - Mobile phone**
    - Menu (on-board computer) ..... 161
  - Modifying the programming (SmartKey)** ..... 86
  - MOExtended tires** ..... 229
  - Mounting wheels**
    - Lowering the vehicle ..... 268
    - Mounting a new wheel ..... 267
    - Preparing the vehicle ..... 265
    - Raising the vehicle ..... 266
    - Removing a wheel ..... 267
    - Securing the vehicle against rolling away ..... 265
  - MP3**
    - Operation ..... 161
    - see also Digital Operator's Manual 188
    - see separate operating instructions
  - Multifunction display**
    - Function/notes ..... 160
    - Permanent display ..... 161
  - Multifunction steering wheel**
    - Operating the on-board computer ..... 160
    - Overview ..... 39
  - Music files**
    - see also Digital Operator's Manual 188
- ## N
- Navigation**
    - Menu (on-board computer) ..... 161
    - see also Digital Operator's Manual 188
    - see separate operating instructions
  - NECK-PRO head restraints**
    - Operation ..... 59
    - Resetting after being triggered ..... 60
  - NECK-PRO luxury head restraints**
    - Operation ..... 59
    - Resetting after being triggered ..... 60
  - Night View Assist Plus**
    - Activating/deactivating ..... 148
    - Cleaning ..... 226
    - Function/notes ..... 147
    - Problem (malfunction) ..... 149
  - Notes on breaking-in a new vehicle** 120
- ## O
- Occupant Classification System (OCS)**
    - Faults ..... 58
    - Operation ..... 53
    - System self-test ..... 56
  - Occupant safety**
    - Air bags ..... 48
    - Important safety notes ..... 46
    - PRE-SAFE® (anticipatory occupant protection) ..... 60
    - SRS (Supplemental Restraint System) ..... 47
  - OCS**
    - Faults ..... 58
    - Operation ..... 53
    - System self-test ..... 56
  - Odometer** ..... 161
  - Oil**
    - see Engine oil

- On-board computer**
    - AMG menu ..... 161
    - Assistance menu ..... 161
    - Audio menu ..... 161
    - Convenience submenu ..... 161
    - Displaying a service message ..... 224
    - Display messages ..... 163
    - DISTRONIC PLUS ..... 137
    - Factory settings submenu ..... 161
    - Important safety notes ..... 160
    - Instrument cluster submenu ..... 161
    - Lighting submenu ..... 161
    - Menu overview ..... 161
    - Message memory ..... 163
    - Navigation menu ..... 161
    - Operation ..... 160
    - RACETIMER ..... 161
    - Service menu ..... 161
    - Settings menu ..... 161
    - Standard display ..... 161
    - Telephone menu ..... 161
    - Trip menu ..... 161
    - Vehicle submenu ..... 161
    - Video DVD operation ..... 161
  - Online and Internet functions**
    - Ending the connection ..... 199
    - Establishing/ending the connection ..... 198
  - Operating safety**
    - Declaration of conformity ..... 31
    - Important safety notes ..... 30
  - Operating system**
    - see On-board computer
  - Operator's Manual**
    - Vehicle equipment ..... 28
  - Outside temperature display** ..... 160
  - Overhead control panel** ..... 43
  - Override feature**
    - Rear side windows ..... 72
- P**
- Paint code number** ..... 280
  - Paintwork (cleaning instructions)** ... 225
  - Panic alarm** ..... 46
  - Parking** ..... 130
    - Important safety notes ..... 130
    - Parking brake ..... 131
    - Position of exterior mirror, front-  
passenger side ..... 103
    - Rear view camera ..... 145
    - see PARKTRONIC
  - Parking aid**
    - Active Parking Assist ..... 144
    - see Exterior mirrors
    - see PARKTRONIC
  - Parking assistance**
    - see PARKTRONIC
  - Parking brake**
    - Display message ..... 163
    - Notes/function ..... 131
  - PARKTRONIC**
    - Deactivating/activating ..... 144
    - Driving system ..... 142
    - Function/notes ..... 142
    - Important safety notes ..... 142
    - Problem (malfunction) ..... 144
    - Range of the sensors ..... 143
    - Warning display ..... 144
  - PASSENGER AIR BAG OFF**
    - Problem (malfunction) ..... 58
    - Problems (malfunction) ..... 169
  - PASSENGER AIR BAG OFF indicator lamp** ..... 53
  - Phone book**
    - see also Digital Operator's Manual 188
  - Plastic trim (cleaning instructions)** . 226
  - Power closing feature** ..... 90
  - Power washers** ..... 225
  - Power windows**
    - see Side windows
  - PRE-SAFE® (anticipatory occupant protection)**
    - Display message ..... 163
    - Operation ..... 60
  - PRE-SAFE® Brake**
    - Activating/deactivating ..... 161
    - Display message ..... 163
    - Function/notes ..... 78
    - Warning lamp ..... 174, 184
  - Program selector button** ..... 126
  - Protection of the environment**
    - General notes ..... 27
  - Pulling away (automatic transmission)** ..... 124



**Q**

**Qualified specialist workshop** ..... 32

**R**

**RACE START (AMG vehicles)** ..... 140

**RACETIMER (on-board computer)** ..... 161

**Radar sensor system**

Activating/deactivating ..... 161

Display message ..... 163

**Radio**

Selecting a station ..... 161

see separate operating instructions

**Radio mode**

see also Digital Operator's Manual 188

**Radio-wave reception/transmission in the vehicle**

Declaration of conformity ..... 31

**Reading lamp** ..... 109

**Rear fog lamp**

Display message ..... 163

**Rear seat (folding the backrest forwards/back)** ..... 205**Rear seats**

Display message ..... 173

**Rear view camera**

Cleaning instructions ..... 225

Function/notes ..... 145

Switching on/off ..... 146

**Rear-view mirror**

Dipping (automatic) ..... 103

**Rear window blind** ..... 208

**Rear window defroster**

Problem (malfunction) ..... 118

Switching on/off ..... 118

**Refrigerant (air-conditioning system)**

Important safety notes ..... 284

**Refueling**

Fuel gauge ..... 37, 160

Important safety notes ..... 127

Refueling process ..... 128

see Fuel

**Remote control**

Garage door opener ..... 213

Programming (garage door opener) 214

**Replacing bulbs**

Important safety notes ..... 109

Overview of bulb types ..... 110

**Reporting safety defects** ..... 32

**Reserve (fuel tank)**

see Fuel

**Reserve fuel**

Display message ..... 163

Warning lamp ..... 174

see Fuel

**Residual heat (climate control)** ..... 118

**Restraint system**

see SRS (Supplemental Restraint System)

**Reverse gear (selector lever)** ..... 125

**Reversing feature**

Side windows ..... 94

Sliding sunroof ..... 96

Trunk lid ..... 90

**Reversing lamps (display message)** 163

**Roadside Assistance (breakdown)** .... 29

**Roller sunblind**

Rear window ..... 208

**Roof**

Display message ..... 163

**Roof carrier** ..... 207

**Roof lining and carpets (cleaning**

**guidelines)** ..... 226

**Roof load (maximum)** ..... 285

**Route (navigation)**

see Route guidance (navigation)

**Route guidance**

see also Digital Operator's Manual 188

**Route guidance (navigation)** ..... 161

**S****Safety**

Child restraint systems ..... 66

Occupant Classification System (OCS) ..... 53

**Safety system**

see Driving safety systems

**SD memory card**

see also Digital Operator's Manual 188

**Search & Send**

see also Digital Operator's Manual 188

**Seat belts**

- Adjusting the driver's and front-passenger seat belt ..... 63
- Adjusting the height ..... 64
- Belt force limiters ..... 65
- Cleaning ..... 226
- Correct usage ..... 62
- Emergency Tensioning Devices ..... 65
- Fastening ..... 62
- Important safety guidelines ..... 61
- Releasing ..... 64
- Safety guidelines ..... 47
- Switching belt adjustment on/off (on-board computer) ..... 161
- Warning lamp ..... 174, 175
- Warning lamp (function) ..... 64

**Seats**

- Adjusting (electrically) ..... 102
- Adjusting the 4-way lumbar support ..... 102
- Adjusting the head restraint ..... 102
- Cleaning the cover ..... 226
- Correct driver's seat position ..... 100
- Folding the backrests forward/back ..... 102
- Important safety notes ..... 101
- Seat backrest display message .... 174
- Seat heating problem ..... 102
- Storing settings (memory function) 103
- Switching AIRSCARF on/off ..... 102
- Switching seat heating on/off ..... 102
- Switching seat ventilation on/off .. 102

**Sensors (cleaning instructions) ..... 225****Service center**

see Qualified specialist workshop

**Service Center**

see Qualified specialist workshop

**Service menu (on-board****computer) ..... 161****Service products**

- Brake fluid ..... 282
- Coolant (engine) ..... 282
- Engine oil ..... 282
- Fuel ..... 281
- Important safety notes ..... 280
- Refrigerant (air-conditioning system) ..... 284
- Washer fluid ..... 283

**Settings**

- Factory (on-board computer) ..... 161
- Menu overview ..... 192
- On-board computer ..... 161
- Setting the air distribution** ..... 118
- Setting the airflow** ..... 118
- Setting the date/time format**  
see also Digital Operator's Manual 188
- Setting the language**  
see also Digital Operator's Manual 188
- Setting the time**  
see also Digital Operator's Manual 188
- SETUP (on-board computer)** ..... 161
- Side impact air bag** ..... 51
- Side marker lamp (display message)** ..... 163

**Side windows**

- Cleaning ..... 225
- Important safety information ..... 94
- Opening/closing (all) ..... 94
- Opening/closing (front) ..... 94
- Problem (malfunction) ..... 95
- Resetting ..... 94

**SIRIUS services**

see also Digital Operator's Manual 188

**Sliding sunroof**

- Important safety notes ..... 95
- Opening/closing ..... 96
- Problem (malfunction) ..... 98
- Resetting ..... 97

**SmartKey**

- Changing the battery ..... 87
- Changing the programming ..... 86
- Checking the battery ..... 87
- Display message ..... 163
- Door central locking/unlocking ..... 85
- Important safety notes ..... 84
- Loss ..... 88
- Mechanical key ..... 86
- Overview ..... 84
- Positions (ignition lock) ..... 121
- Problem (malfunction) ..... 88
- Starting the engine ..... 123

**SMS**

see also Digital Operator's Manual 188

**Snow chains** ..... 244

- Sockets**
    - Center console ..... 208
    - General notes ..... 208
    - Rear compartment ..... 208
    - Trunk ..... 208
    - Under the armrest ..... 208
  - Spare wheel**
    - Stowing ..... 275
  - Specialist workshop** ..... 32
  - Special seat belt retractor** ..... 69
  - Speed, controlling**
    - see Cruise control
  - Speedometer**
    - Digital ..... 161
    - In the Instrument cluster ..... 37, 160
    - Segments ..... 160
    - Selecting the unit of measurement ..... 161
    - see Instrument cluster
  - SPORT handling mode**
    - Activating/deactivating (AMG vehicles) ..... 76
    - Warning lamp ..... 180
  - SRS (Supplemental Restraint System)**
    - Display message ..... 167
    - Introduction ..... 47
    - Warning lamp ..... 182
    - Warning lamp (function) ..... 47
  - Standing lamps**
    - Display message ..... 163
    - Switching on/off ..... 107
  - Start/stop function**
    - see ECO start/stop function
  - Starting (engine)** ..... 123
  - Steering (display message)** ..... 174
  - Steering wheel**
    - Adjusting (electrically) ..... 103
    - Button overview ..... 39
    - Buttons (on-board computer) ..... 160
    - Important safety notes ..... 103
    - Paddle shifters ..... 126
    - Steering wheel heating ..... 103
    - Storing settings (memory function) ..... 103
  - Steering wheel heating**
    - Switching on/off ..... 103
  - Steering wheel paddle shifters** ..... 126
  - Stopwatch (RACETIMER)** ..... 161
  - Stowage areas** ..... 204
  - Stowage compartments**
    - Armrest (under) ..... 205
    - Center console ..... 205
    - Cup holders ..... 208
    - Display message) ..... 163
    - Eyeglasses compartment ..... 205
    - Glove box ..... 205
    - Important safety information ..... 204
    - Rear ..... 205
    - Stowage net ..... 205
    - Under driver's seat/front-passenger seat ..... 205
  - Stowage net** ..... 205
  - Stowage well beneath the trunk floor** ..... 207
  - Summer tires** ..... 244
  - Sun visor** ..... 208
  - Supplemental restraint system**
    - see SRS (Supplemental Restraint System)
  - Surround lighting (on-board computer)** ..... 161
  - Suspension tuning**
    - AIRMATIC ..... 141
    - SETUP (on-board computer) ..... 161
  - Switching air-recirculation mode on/off** ..... 118
  - Systems settings (COMAND)**
    - see also Digital Operator's Manual 188
- T**
- Tachometer** ..... 160
  - Tail lamps**
    - Display message ..... 163
  - Tank**
    - see Fuel tank
  - Tank content**
    - Fuel gauge ..... 37, 160
  - Technical data**
    - Capacities ..... 280
    - Emergency spare wheel ..... 277
    - Information ..... 280

- Tires/wheels ..... 269
- Vehicle data ..... 285
- TELEAID**
- Call priority ..... 213
- Downloading destinations (COMAND) ..... 208
- Downloading routes ..... 208
- Emergency call ..... 210
- Geo fencing ..... 208
- Locating a stolen vehicle ..... 208
- MB info call button ..... 212
- Remote vehicle locking ..... 208
- Roadside Assistance button ..... 211
- Search & Send ..... 208
- Self-test ..... 209
- Speed alert ..... 208
- System ..... 209
- Triggering the vehicle alarm ..... 208
- Vehicle remote malfunction diagnosis ..... 208
- Vehicle remote unlocking ..... 208
- Tele Aid**
- General notes ..... 209
- Telephone**
- Accepting a call ..... 161
- Menu (on-board computer) ..... 161
- Number from the phone book ..... 161
- Redialing ..... 161
- Rejecting/ending a call ..... 161
- see also Digital Operator's Manual 188
- Temperature**
- Coolant ..... 160
- Coolant (on-board computer) ..... 161
- Engine oil (on-board computer) ..... 161
- Outside temperature ..... 160
- Setting (climate control) ..... 118
- Theft deterrent systems**
- ATA (Anti-Theft Alarm system) ..... 80
- Immobilizer ..... 80
- Through-loading feature** ..... 205
- Timing (RACETIMER)** ..... 161
- Tire pressure**
- Calling up (on-board computer) ..... 249
- Checking manually ..... 248
- Display message ..... 163, 172
- Important safety notes ..... 249
- Maximum ..... 247
- Notes ..... 246
- Recommended ..... 244
- see Tire pressure
- Tire pressure loss warning system**
- General notes ..... 248
- Important safety notes ..... 248
- Restarting ..... 248
- Tire pressure monitoring system**
- Checking the tire pressure electronically ..... 251
- Function/notes ..... 249
- General notes ..... 249
- Important safety notes ..... 249
- Restarting ..... 251
- Warning lamp ..... 174, 185
- Warning message ..... 251
- Tires**
- Aspect ratio (definition) ..... 263
- Average weight of the vehicle occupants (definition) ..... 262
- Bar (definition) ..... 261
- Changing a wheel ..... 264
- Characteristics ..... 261
- Checking ..... 243
- Definition of terms ..... 261
- Direction of rotation ..... 264
- Display message ..... 163, 172
- Distribution of the vehicle occupants (definition) ..... 264
- DOT, Tire Identification Number (TIN) ..... 261
- DOT (Department of Transportation) (definition) ..... 262
- GAWR (Gross Axle Weight Rating) (definition) ..... 262
- GVW (Gross Vehicle Weight) (definition) ..... 262
- GVWR (Gross Vehicle Weight Rating) (definition) ..... 262
- Important safety notes ..... 242
- Increased vehicle weight due to optional equipment (definition) ..... 262
- Kilopascal (kPa) (definition) ..... 262
- Labeling (overview) ..... 258
- Load bearing index (definition) ..... 263
- Load index ..... 260
- Load index (definition) ..... 262

- Maximum loaded vehicle weight
  - (definition) ..... 262
- Maximum load on a tire (definition) 263
- Maximum permissible tire pressure (definition) ..... 263
- Maximum tire load ..... 260
- Maximum tire load (definition) ..... 263
- MOExtended tires ..... 244
- Optional equipment weight (definition) ..... 263
- PSI (pounds per square inch) (definition) ..... 263
- Replacing ..... 264
- Service life ..... 244
- Sidewall (definition) ..... 263
- Speed rating (definition) ..... 262
- Storing ..... 264
- Structure and characteristics (definition) ..... 261
- Temperature ..... 257
- TIN (Tire Identification Number) (definition) ..... 263
- Tire bead (definition) ..... 263
- Tire pressure (definition) ..... 263
- Tire pressures (recommended) ..... 262
- Tire size (data) ..... 269
- Tire size designation, load-bearing capacity, speed rating ..... 258
- Tire tread ..... 243
- Tire tread (definition) ..... 263
- Total load limit (definition) ..... 264
- Traction ..... 257
- Traction (definition) ..... 263
- Tread wear ..... 257
- Uniform Tire Quality Grading Standards ..... 256
- Uniform Tire Quality Grading Standards (definition) ..... 262
- Unladen weight (definition) ..... 263
- Wear indicator (definition) ..... 263
- Wheel and tire combination ..... 271
- Wheel rim (definition) ..... 262
- see Flat tire
- Top Tether** ..... 70
- Towing**
  - Important safety guidelines ..... 236
  - Installing the towing eye ..... 237
  - Removing the towing eye ..... 238
  - With the rear axle raised ..... 238
- Towing away**
  - With both axles on the ground ..... 238
- Tow-starting**
  - Emergency engine starting ..... 239
  - Important safety notes ..... 236
- Traffic reports**
  - see also Digital Operator's Manual 188
- Transmission**
  - see Automatic transmission
- Transporting the vehicle** ..... 238
- Trim pieces (cleaning instructions)** . 226
- Trip computer (on-board computer)** ..... 161
- Trip meter**
  - see Trip odometer
- Trip odometer**
  - Calling up ..... 161
  - Resetting (on-board computer) ..... 161
- Trunk**
  - Emergency release ..... 93
  - Important safety notes ..... 90
  - Opening/closing (automatically from inside) ..... 92
  - Opening/closing (automatically from outside) ..... 91
  - Opening/closing (manually from outside) ..... 91
- Trunk lid**
  - Display message ..... 163
  - Opening/closing ..... 90
  - Opening dimensions ..... 285
  - Power closing feature ..... 90
- Trunk load (maximum)** ..... 285
- Trunk partition**
  - Display message ..... 163
- Turn signals**
  - Display message ..... 163
  - Switching on/off ..... 107
- Type identification plate**
  - see Vehicle identification plate

**U****Unlocking**

- Emergency unlocking ..... 90
- From inside the vehicle (central unlocking button) ..... 90

**V****Vanity mirror (in the sun visor) ..... 208****Vehicle**

- Correct use ..... 32
- Data acquisition ..... 33
- Display message ..... 163, 173
- Equipment ..... 28
- Individual settings ..... 161
- Limited Warranty ..... 33
- Loading ..... 252
- Locking (in an emergency) ..... 90
- Locking (SmartKey) ..... 85
- Lowering ..... 268
- Maintenance ..... 29
- Parking for a long period ..... 131
- Pulling away ..... 124
- Raising ..... 266
- Reporting problems ..... 32
- Securing from rolling away ..... 265
- Towing away ..... 236
- Transporting ..... 238
- Unlocking (in an emergency) ..... 90
- Unlocking (SmartKey) ..... 85
- Vehicle data ..... 285

**Vehicle data ..... 285****Vehicle dimensions ..... 285****Vehicle emergency locking ..... 90****Vehicle identification number**

see VIN

**Vehicle identification plate ..... 280****Vehicle level**

- AIRMATIC ..... 140

**Vehicle maintenance**

see ASSYST PLUS

**Vehicle tool kit ..... 228****Video**

- Operating the DVD ..... 161
- see also Digital Operator's Manual 188

**Video (DVD) ..... 161****VIN ..... 280****Voice Control System**

see Separate operating instructions

**W****Warning and indicator lamps**

- ABS ..... 177
- Brakes ..... 174, 176
- Check Engine ..... 174
- Coolant ..... 183
- Distance warning ..... 174, 184
- DISTRONIC PLUS ..... 174, 184
- ESP® ..... 179
- ESP® OFF ..... 180
- Fuel tank ..... 174
- General notes ..... 174
- Overview ..... 38, 174
- PASSENGER AIRBAG OFF ..... 53
- Reserve fuel ..... 174
- Seat belt ..... 174, 175
- SPORT handling mode ..... 180
- SRS ..... 182
- Tire pressure monitor ..... 174, 185

**Warranty ..... 28, 280****Washer fluid**

- Display message ..... 163

**Weather display (COMAND)**

see also Digital Operator's Manual 188

**Wheel and tire combination**

see Tires

**Wheel bolt tightening torque ..... 268****Wheel chock ..... 265****Wheels**

- Changing a wheel ..... 264
- Checking ..... 243
- Cleaning ..... 225
- Cleaning (warning) ..... 264
- Emergency spare wheel ..... 274
- Important safety notes ..... 242
- Interchanging/changing ..... 264
- Mounting a new wheel ..... 267
- Mounting a wheel ..... 265
- Removing a wheel ..... 267
- Storing ..... 264
- Tightening torque ..... 268
- Wheel size/tire size ..... 269

**Window curtain air bag**

- Operation ..... 53

**Windows**

see Side windows

**Windshield**

Defrosting ..... 118

**Windshield washer fluid**

see Windshield washer system

**Windshield washer system**

Adding washer fluid ..... 223

Notes ..... 283

**Windshield wipers**

Problem (malfunction) ..... 112

Replacing the wiper blades ..... 111

Switching on/off ..... 111

**Winter driving**

Important safety notes ..... 244

Slippery road surfaces ..... 131

Snow chains ..... 244

**Winter tires**

M+S tires ..... 244

**Wiper blades**

Cleaning ..... 225

Important safety notes ..... 111

Replacing ..... 111

**Wooden trim (cleaning instructions)** 226**workshop**

see Qualified specialist workshop

**Z****ZONE function**

Switching on/off ..... 118

## Introduction

In addition to the printed Operator's Manual, the vehicle document wallet also contains further operating instructions, such as:

- Digital Operator's Manual on CD
- Maintenance Booklet
- Equipment-dependent supplements

The printed Operator's Manual provides information on selected functions of your vehicle.

You can also access the Digital Operator's Manual via COMAND. If you have further questions that are not covered in the printed Operator's Manual, please consult the Digital Operator's Manual.

- i** You will not incur any costs when calling up the Digital Operator's Manual. It works without connecting to the Internet.

In the following sections you will find further information about:

- how to install the Digital Operator's Manual on your COMAND (▷ page 22)
- how to access and operate the Digital Operator's Manual
- various options for accessing the individual topics covered by the Digital Operator's Manual.



There are three options for accessing via the basic menu of the Digital Operator's Manual:

- Visual search
- Keyword Search
- Contents

You can change the set language for the Digital Operator's Manual under "Settings" in the basic menu.

## Installation

Check whether or not the Digital Operator's Manual has already been installed. To do so, call up the Digital Operator's Manual via COMAND as follows:

- ▶ Using the COMAND controller, select the  symbol from the menu bar in the COMAND display and press  to confirm.
- ▶ Choose the "Operator's Manual" selection card and press  to confirm. There are two possibilities:
  1. The Digital Operator's Manual is installed. The basic menu for the Digital Operator's Manual opens.
  2. The Digital Operator's Manual is not installed. The following message appears: **The Operator's Manual has not yet been installed. Please insert the correct disc.**

If the Digital Operator's Manual has not yet been installed, you have the option of installing it yourself. You will find the installation CD required in the vehicle document wallet.

The duration of the installation process can vary.

The installation process takes approximately 5 minutes. This timespan only applies if you install the Digital Operator's Manual while the vehicle is at a standstill and no other COMAND functions are in use at the time. The duration of the installation process may increase accordingly if other COMAND functions such as navigation or telephony are in use at the time.

If you encounter any problems during installation, please contact your authorized Mercedes-Benz Center.

- ▶ **To install the Digital Operator's Manual:** stop the vehicle safely, paying attention to road and traffic conditions.
- ▶ Turn the SmartKey to position **2** in the ignition lock (▷ page 121).
- ▶ Switch on COMAND.
- ▶ Insert the installation CD into the CD/DVD drive.
- ▶ Select the desired language for the installation.
- ▶ Follow the installation steps on the COMAND display.







- i** If the check was not successful, a message appears, e.g. **The disc containing the Digital Operator's Manual is not supported by the system. Ejecting disc.** Please contact your authorized Mercedes-Benz Center.



- ▶ **When the installation has been completed:** press  the COMAND controller to confirm ejection of the installation CD.
- i** **To cancel the installation:** you can cancel the installation of the Digital Operator's Manual during the installation process. The installation can be continued at a later date.
- To continue the installation:** insert the installation CD into the CD/DVD drive again. Follow the installation instructions as described above.

## Operation

### Calling up the Digital Operator's Manual

- ▶ Press the  control knob on COMAND. COMAND switches on. The previously selected menu appears after a warning message.
- ▶ Using the COMAND controller, select the  symbol in the menu bar and press  to confirm.
- ▶ Choose the "Operator's Manual" page and press  to confirm. The basic menu for the Digital Operator's Manual opens.

## Visual search

The visual search allows you to explore your vehicle "virtually". Starting from either the vehicle exterior view or interior view, you can access many of the different topics covered by the Operator's Manual. To access the vehicle interior section, select the "Interior" view.

If a vehicle has several body styles, you can choose between the different body styles when the visual search is started for the first time. You can change the selected body style in the basic menu under "Settings".

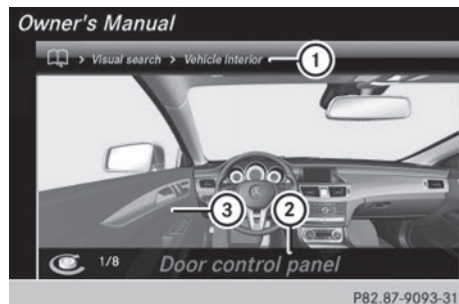

- ① Topic bar
- ② Selected section heading
- ③ Active vehicle component

- ▶ Turn **⏏** or slide **←** to the COMAND controller to select individual vehicle components.

Individual vehicle components are highlighted in color. Just one vehicle component per view is highlighted.

- ▶ To confirm the currently selected section, press **⏏** the COMAND controller.

After you have selected a section, one of the following happens:

- you go straight to the corresponding section in the Digital Operator's Manual.
- a list opens up with further, in-depth headings that you can select using the COMAND controller.
- you go down a level to the visual search. You can refine your search here. Turn **⏏** or slide **←** to the COMAND controller to select individual vehicle components highlighted in red **③**.

- ▶ **To access the previous view/the previous section:** press the **⏏** back button next to the COMAND controller. The previous view or previous section opens.

- i** If you are in the vehicle exterior view and you press the **⏏** back button, you will exit the visual search. The basic menu for the Digital Operator's Manual opens.

### Keyword search

The keyword search allows you to perform a keyword search using character entry. A detailed description of character entry can be found in the section "COMAND" under the keyword "Character entry (telephony)".

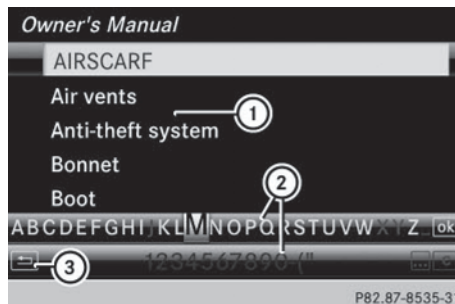

- ① Selection list of available keywords
- ② Character bar
- ③ **⏏** Back symbol

- ▶ **To enter a keyword:** turn **⏏** or slide **←** to the COMAND controller to select a character. Slide **↑** the COMAND controller to change the character bar.

- i** If you are in the upper character bar, you can access the selection list by sliding **↑** the COMAND controller up.

- ▶ To confirm the character, press **⏏** the COMAND controller. Selection list **①** is then filtered.
- ▶ Select characters in the same way until COMAND jumps automatically to selection list **①**. Alternatively, you can call up selection list **①** by pressing **OK**.

- ▶ **To access the previous selection list:** slide **←** the COMAND controller to the left. Press the **⏏** back symbol to open the previous selection list.

or



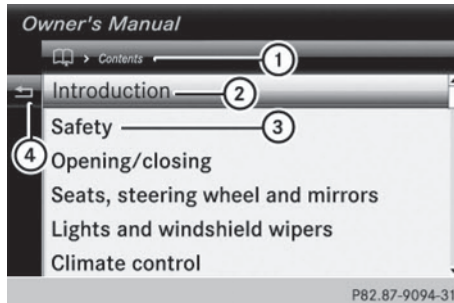

- ▶ Press the **⏏** back button next to the COMAND controller. The previous selection list opens.
- i** If you are in the character bar and you press the **⏏** back button, you will exit the visual search. The basic menu for the Digital Operator's Manual opens.

## Contents



In the contents, the topics are listed in the same order as in the printed Operator's Manual. You can select a section and then a subsection.



- ① Topic bar
- ② Currently selected section in the contents
- ③ Section not currently selected in the contents
- ④  Back symbol

- ▶ Turn  or slide  the COMAND controller to select the desired section.
- ▶ To confirm the selection press  the COMAND controller.  
A further selection list with the corresponding subsection opens.
- ▶ Select the corresponding subsection in the same way.
- ▶ **To access the previous selection list:** slide  the COMAND controller to the left.  
Press the  back symbol to open the previous selection list.



or

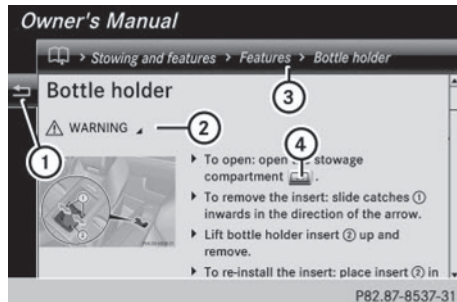

- ▶ Press the  back button next to the COMAND controller.  
The previous selection list opens.
- i** If you are on the uppermost level in the list of contents, press the  back button. You will then exit the list of contents and the basic menu for the Digital Operator's Manual opens.

## Content pages



- ①  Back symbol
- ② Hidden warning
- ③ Topic bar
- ④ Link to a continuing chapter







- ▶ **To navigate within a contents page:** turn  or slide  the COMAND controller to scroll the text up and down.

- ▶ **To navigate away from the content page:** slide  the COMAND controller to the left.  
Press the  back symbol to open the previous page.











or

- ▶ Press the  back button next to the COMAND controller.

or

- ▶ Turn  or slide  the COMAND controller up to scroll to the very top of the contents page.
- ▶ Slide  the COMAND controller up again to select topic bar ③.
- ▶ Turn  or slide  the COMAND controller to select the desired section or subsection. To confirm the selection press  the COMAND controller.  
The selected topic bar opens including all the subsections.

- ▶ **To select a link ④:** links are automatically highlighted when you scroll in a text. When you have selected a link, press  the COMAND controller.  
The desired contents page opens.

- ▶ **To open up warning notes, environmental notes and malfunction information:** when scrolling through the text, the cursor jumps automatically to the drop down warnings, environmental information and malfunction information. When you have selected the note, press  the COMAND controller.  
The warning note, environmental note or malfunction information opens up on the same page.
  - ▶ **To navigate away from the Digital Operator's Manual:** press and hold the  back button next to the COMAND controller.  
A window opens and you are asked if you would like to exit the browser.
  - ▶ Confirm with "Yes".  
The overview of COMAND functions opens.
  - ▶ **To switch functions from the Digital Operator's Manual to COMAND using the COMAND function buttons:** press the , , ,  or  button in COMAND.  
The desired menu opens.
  - ▶ **To go back to the Digital Operator's Manual:** use the COMAND controller to select the  symbol in the menu bar and press  to confirm.  
The last page called up in the Digital Operator's Manual is opened.
-  For safety reasons, the "Digital Operator's Manual" function is switched off while you are driving.

## Protection of the environment

### General notes

#### Environmental note

Daimler's declared policy is one of comprehensive environmental protection.

The objectives are for the natural resources that form the basis of our existence on this planet to be used sparingly and in a manner that takes the requirements of both nature and humanity into account.

You too can help to protect the environment by operating your vehicle in an environmentally responsible manner.

Fuel consumption and the rate of engine, transmission, brake and tire wear are affected by these factors:

- operating conditions of your vehicle
- your personal driving style

You can influence both factors. You should bear the following in mind:

Operating conditions:

- avoid short trips as these increase fuel consumption.
- always make sure that the tire pressures are correct.
- do not carry any unnecessary weight.
- remove roof racks once you no longer need them.
- a regularly serviced vehicle will contribute to environmental protection. You should therefore adhere to the service intervals.
- always have service work carried out at a qualified specialist workshop.

Personal driving style:

- do not depress the accelerator pedal when starting the engine.
- do not warm up the engine when the vehicle is stationary.
- drive carefully and maintain a safe distance from the vehicle in front.
- avoid frequent, sudden acceleration and braking.

- change gear in good time and use each gear only up to  $\frac{2}{3}$  of its maximum engine speed.
- switch off the engine in stationary traffic.
- keep an eye on the vehicle's fuel consumption.

### Environmental concerns and recommendations

Wherever the operating instructions require you to dispose of materials, first try to regenerate or re-use them. Observe the relevant environmental rules and regulations when disposing of materials. In this way you will help to protect the environment.

### Genuine Mercedes-Benz parts

#### Environmental note

Daimler AG also supplies reconditioned major assemblies and parts which are of the same quality as new parts. They are covered by the same Limited Warranty entitlements as new parts.

**!** Air bags and Emergency Tensioning Devices, as well as control units and sensors for these restraint systems, may be installed in the following areas of your vehicle:

- doors
- door pillars
- door sills
- seats
- cockpit
- instrument cluster
- center console

Do not install accessories such as audio systems in these areas. Do not carry out repairs or welding. You could impair the operating efficiency of the restraint systems.

Have aftermarket accessories installed at a qualified specialist workshop.

You could jeopardize the operating safety of your vehicle if you use parts, tires and wheels as well as accessories relevant to safety which have not been approved by Mercedes. This could lead to malfunctions in safety-relevant systems, e.g. the brake system. Use only genuine Mercedes-Benz parts or parts of equal quality. Only use tires, wheels and accessories that have been specifically approved for your vehicle.

Genuine Mercedes-Benz parts are subject to strict quality control. Every part has been specifically developed, manufactured or selected for and adapted to Mercedes-Benz vehicles. Only genuine Mercedes-Benz parts should therefore be used.

More than 300,000 different genuine Mercedes-Benz parts are available for Mercedes-Benz models.

All authorized Mercedes-Benz Centers maintain a supply of genuine Mercedes-Benz parts for necessary service and repair work. In addition, strategically located parts delivery centers provide quick and reliable parts service.

Always specify the vehicle identification number (VIN) when ordering genuine Mercedes-Benz parts (▷ page 280).

### Operator's Manual

### Vehicle equipment

This Operator's Manual describes all models and all standard and optional equipment of your vehicle available at the time of going to print. Country-specific differences are possible. Bear in mind that your vehicle may not feature all functions described here. This also applies to safety-relevant systems and functions. The equipment in your vehicle may therefore differ from that shown in the descriptions and illustrations.

The original purchase agreement lists all systems installed in your vehicle.

Should you have any questions concerning equipment and operation, please consult an authorized Mercedes-Benz Center.

The Operator's Manual and Maintenance Booklet are important documents and should be kept in the vehicle.

## Service and vehicle operation

### Warranty

The implied warranty for your vehicle applies in accordance with the warranty terms and conditions in the Service and Warranty Information booklet.

Your authorized Mercedes-Benz Center will replace and repair all factory-installed parts in accordance with the following warranty terms and conditions:

- New Vehicle Limited Warranty
- Emission System Warranty
- Emission Performance Warranty
- California, Connecticut, Maine, Massachusetts, New York, Pennsylvania, Rhode Island and Vermont Emission Control System Warranty
- State warranty enforcement laws (lemon laws)

Replacement parts and accessories are covered by the Mercedes-Benz Parts and Accessories warranties. These are available at any authorized Mercedes-Benz Center.

- i** Should you lose your Service and Warranty Information booklet, have an authorized Mercedes-Benz Center arrange for a replacement. The new Service and Warranty Information booklet will be posted to you.

### Information for customers in California

Under California law you may be entitled to a replacement of your vehicle or a refund of the purchase price or lease price, if after a reasonable number of repair attempts Mercedes-Benz USA, LLC and/or its authorized repair or service facilities fail to fix one or more substantial defects or malfunctions in the vehicle that are covered by its express warranty. During the period of 18 months from original delivery of the vehicle or the accumulation of 18,000 miles (approximately 29,000 km) on the odometer of the vehicle, whichever occurs first, a reasonable number of repair attempts is presumed for a retail buyer or lessee if one or more of the following occurs:

- (1) the same substantial defect or malfunction results in a condition that is likely to cause death or serious bodily injury if the vehicle is driven, that defect or malfunction has been subject to repair two or more times, and you have directly notified Mercedes-Benz USA, LLC in writing of the need for its repair,
- (2) the same substantial defect or malfunction of a less serious nature than category (1) has been subject to repair four or more times and you have directly notified us in writing of the need for its repair, or
- (3) the vehicle is out of service by reason of repair of the same or different substantial defects or malfunctions for a cumulative total of more than 30 calendar days.

Please send your written notice to:  
Mercedes-Benz USA, LLC  
Customer Assistance Center  
One Mercedes Drive  
Montvale, NJ 07645-0350

### Maintenance

The Service and Warranty Booklet describes all the necessary maintenance work which should be done at regular intervals.

Always have the Service and Warranty Booklet with you when you bring the vehicle to an authorized Mercedes-Benz Center. The service advisor will record every service for you in the Service and Warranty Booklet.

### Roadside Assistance

The Mercedes-Benz Roadside Assistance Program offers technical help in the event of a breakdown. Calls to the toll-free Roadside Assistance Hotline are answered by our agents 24 hours a day, 365 days a year.

**1-800-FOR-MERCEdes(1-800-367-6372) (USA)**

**1-800-387-0100 (Canada)**

For additional information, refer to the Mercedes-Benz Roadside Assistance Program brochure (USA) or the "Roadside Assistance" section in the Service and Warranty booklet (Canada). You will find both in your vehicle literature portfolio.

### Change of address or change of ownership

In the event of a change of address, please send us the "Notification of Address Change" in the Service and Guarantee booklet or simply call the Mercedes-Benz Customer Assistance Center (USA) at the hotline number

1-800-FOR-MERCEdes(1-800-367-6372) or Customer Service Center (Canada) at 1-800-387-0100. This will assist us in contacting you in a timely manner should the need arise.

If you sell your Mercedes, please leave the entire literature in the vehicle so that it is available to the next owner.

If you have purchased a used car, please send us the "Notification of Used Car Purchase" in the Service and Guarantee booklet or simply call the Mercedes-Benz Customer Assistance Center (USA) at the hotline number 1-800-FOR-MERCEdes(1-800-367-6372) or Customer Service (Canada) at 1-800-387-0100.

### Vehicle operation outside the USA and Canada

If you plan to operate your vehicle in foreign countries, please be aware that:

- service facilities or replacement parts may not be readily available.
- unleaded fuel for vehicles with a catalytic converter may not be available. Leaded fuel may cause damage to the catalytic converter.
- the fuel may have a considerably lower octane rating. Unsuitable fuel can cause engine damage.

Some Mercedes-Benz models are available for delivery in Europe through our European Delivery Program. For details, consult an authorized Mercedes-Benz Center or write to one of the following addresses.

#### In the USA

Mercedes-Benz USA, LLC  
European Delivery Department  
One Mercedes Drive  
Montvale, NJ 07645-0350

#### In Canada

Mercedes-Benz Canada, Inc.  
European Delivery Department  
98 Vanderhoof Avenue  
Toronto, Ontario M4G 4C9

## Operating safety

### Important safety notes

#### WARNING

If you do not have the prescribed service/maintenance work or any required repairs carried out, this can result in malfunctions or system failures. There is a risk of an accident.

Always have the prescribed service/maintenance work as well as any required repairs carried out at a qualified specialist workshop.

#### WARNING

If you switch off the ignition while driving, safety-relevant functions are only available with limitations, or not at all. This could affect, for example, the power steering and the brake boosting effect. You will require considerably more effort to steer and brake. There is a risk of an accident.

Do not switch off the ignition while driving.

#### WARNING

Flammable material such as leaves, grass or twigs may ignite if they come into contact with hot parts of the exhaust system. There is a risk of fire.

When driving off road or on unpaved roads, check the vehicle's underside regularly. In particular, remove parts of plants or other flammable materials which have become trapped. In the case of damage, contact a qualified specialist workshop.

#### WARNING

Modifications to electronic components, their software as well as wiring can impair their function and/or the function of other networked components. In particular, systems relevant to safety could also be affected. As a result, these may no longer function as intended and/or jeopardize the operating safety of the vehicle. There is an increased risk of an accident and injury.



Never tamper with the wiring as well as electronic components or their software. You should have all work to electrical and electronic equipment carried out at a qualified specialist workshop.

If you make any changes to the vehicle electronics, the general operating permit is rendered invalid.

**!** There is a risk of damage to the vehicle if:

- the vehicle becomes stuck, e.g. on a high curb or an unpaved road
- you drive too fast over an obstacle, e.g. a curb or a hole in the road
- a heavy object strikes the undercarriage or parts of the chassis

In situations like this, the body, the undercarriage, chassis parts, wheels or tires could be damaged without the damage being visible. Components damaged in this way can unexpectedly fail or, in the case of an accident, no longer withstand the strain they are designed to.

If the underbody paneling is damaged, combustible materials such as leaves, grass or twigs can gather between the underbody and the underbody paneling. If these materials come in contact with hot parts of the exhaust system, they can catch fire.

In such situations, have the vehicle checked and repaired immediately at a qualified specialist workshop. If on continuing your journey you notice that driving safety is impaired, pull over and stop the vehicle immediately, paying attention to road and traffic conditions. In such cases, visit a qualified specialist workshop.

## Declarations of conformity

### Vehicle components which receive and/or transmit radio waves

**USA:** "The wireless devices of this vehicle comply with Part 15 of the FCC Rules. Operation is subject to the following two conditions: 1) These devices may not cause harmful interference, and 2) These devices must accept any interference received, including interference that may cause undesired operation. Changes or modifications not expressly approved by the party responsible for compliance could void the user's authority to operate the equipment."

**Canada:** "The wireless devices of this vehicle comply with Industry Canada license-exempt RSS standard(s). Operation is subject to the following two conditions: (1) These devices may not cause interference, and (2) These devices must accept any interference, including interference that may cause undesired operation of the device."

## Diagnostics connection

The diagnostics connection is only intended for the connection of diagnostic equipment at a qualified specialist workshop.

### WARNING

If you connect equipment to the diagnostics connection in the vehicle, it may affect the operation of the vehicle systems. As a result, the operating safety of the vehicle could be affected. There is a risk of an accident.

Do not connect any equipment to a diagnostics connection in the vehicle.

### WARNING

Objects in the driver's footwell can restrict the pedal travel or obstruct a depressed pedal. The operating and road safety of the vehicle is jeopardized. There is a risk of an accident.

Make sure that all objects in the vehicle are stowed correctly, and that they cannot enter the driver's footwell. Install the floor mats securely and as specified in order to ensure sufficient clearance for the pedals. Do not use loose floor mats and do not place floor mats on top of one another.

**!** If the engine is switched off and equipment on the diagnostics connection is used, the starter battery may discharge.

Connecting equipment to the diagnostics connection can lead to emissions monitoring information being reset, for example. This may lead to the vehicle failing to meet the requirements of the next emissions test during the main inspection.

### Qualified specialist workshop

An authorized Mercedes-Benz Center is a qualified specialist workshop. It has the necessary specialist knowledge, tools and qualifications to correctly carry out the work required on your vehicle. This is especially the case for work relevant to safety.

Observe the notes in the Maintenance Booklet.

Always have the following work carried out at an authorized Mercedes-Benz Center:

- work relevant to safety
- service and maintenance work
- repair work
- alterations, installation work and modifications
- work on electronic components

### Correct use

If you remove any warning stickers, you or others could fail to recognize certain dangers. Leave warning stickers in position.

Observe the following information when driving your vehicle:

- the safety notes in this manual
- the Technical Data section in this manual
- traffic rules and regulations
- laws and safety standards pertaining to motor vehicles

### Problems with your vehicle

If you should experience a problem with your vehicle, particularly one that you believe may affect its safe operation, we urge you to contact an authorized Mercedes-Benz Center immediately to have the problem diagnosed and rectified. If the problem is not resolved to your satisfaction, please discuss the problem again with a Mercedes-Benz Center or contact us at one of the following addresses.

#### In the USA

Customer Assistance Center  
Mercedes-Benz USA, LLC  
One Mercedes Drive  
Montvale, NJ 07645-0350

#### In Canada

Customer Relations Department  
Mercedes-Benz Canada, Inc.  
98 Vanderhoof Avenue  
Toronto, Ontario M4G 4C9

### Reporting safety defects

USA only:

The following text is published as required of manufacturers under Title 49, Code of U.S. Federal Regulations, Part 575 pursuant to the "National Traffic and Motor Vehicle Safety Act of 1966".

If you believe that your vehicle has a defect which could cause a crash or could cause injury or death, you should immediately inform the National Highway Traffic Safety Administration (NHTSA) in addition to notifying Mercedes-Benz USA, LLC.

If NHTSA receives similar complaints, it may open an investigation, and if it finds that a safety defect exists in a group of vehicles, it may order a recall and remedy campaign. However, NHTSA cannot become involved in individual problems between you, your dealer, or Mercedes-Benz USA, LLC.

To contact NHTSA, you may call the Vehicle Safety Hotline toll-free at 1-888-327-4236 (TTY: 1-800-424-9153); go to <http://www.safercar.gov>; or write to: Administrator, NHTSA, 400 Seventh Street, SW., Washington, DC 20590.

You can also obtain other information about motor vehicle safety from

<http://www.safercar.gov>

### Limited Warranty

**I** Follow the instructions in this manual about the proper operation of your vehicle as well as about possible vehicle damage. Damage to your vehicle that arises from culpable contraventions against these instructions is not covered either by the Mercedes-Benz Limited Warranty or by the New or Used-Vehicle Warranty.

### Data stored in the vehicle

#### Information about electronic data acquisition in the vehicle

(Including notice pursuant to California Code § 9951)

Please note that your vehicle is equipped with devices that can record vehicle systems data.

If your vehicle is equipped with mbrace (Canada: TELE AID), data is transmitted in the event of an accident.

This information helps, for example, to test vehicle systems after an accident and to continually improve vehicle safety.

Daimler AG can access these data and submit them:

- for safety research or vehicle diagnosis purposes
- with the consent of the vehicle owner
- on the instruction of prosecuting authorities
- for use in arbitration of disputes that involve Daimler AG, its subsidiaries or its sales and service organizations
- as otherwise required or permitted by law

Please check your mbrace (Canada: TELE AID) purchase agreement to find out more about data that can be recorded and transmitted by this system.

This vehicle is equipped with an event data recorder (EDR). The main purpose of an EDR is to record data that will assist in understanding how a vehicle's systems performed in certain crash or near crash-like situations, such as during air bag deployment or when hitting a road obstacle. The EDR is designed to record data related to vehicle dynamics and safety systems for a short period of time, typically 30 seconds or less.

The EDR in this vehicle is designed to record such data as:

- how various systems in your vehicle are operating
- whether or not the driver and passenger seat belts are fastened
- how far (if at all) the driver is depressing the accelerator and/or brake pedal and
- how fast the vehicle is traveling

This data can help provide a better understanding of the circumstances in which crashes and injuries occur. NOTE: EDR data is recorded by your vehicle only if a non-trivial crash situation occurs; no data is recorded by the EDR under normal driving conditions and no personal data (e.g., name, gender, age, and crash location) are recorded. However,

other parties, such as law enforcement, can combine the EDR data with the type of personal identification data routinely acquired during a crash investigation.

To read data recorded by an EDR, special equipment is required, and access to the vehicle or the EDR is needed. In addition to the vehicle manufacturer, other parties, such as law enforcement, who have the special equipment, can read the information if they have access to the vehicle or the EDR.

### Information on copyright

#### General information

Information on license for free and open-source software used in your vehicle and its electronic components is available on the following website:

<http://www.mercedes-benz.com/opensource>



Dashboard ..... 36  
Instrument cluster ..... 37  
Multifunction steering wheel ..... 39  
Center console ..... 40  
Overhead control panel ..... 43  
Door control panel ..... 44



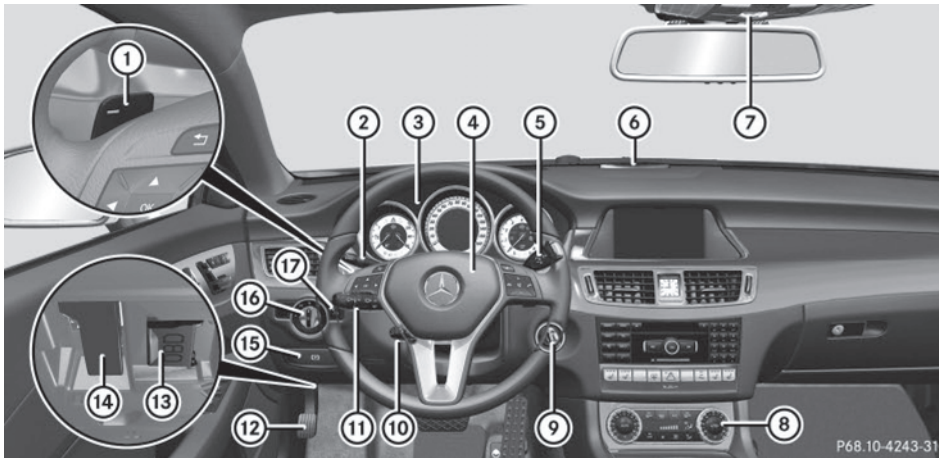

## Dashboard

At a glance



	Function	Page
①	Steering wheel paddle shifters	
②	Cruise control lever	132
③	Instrument cluster	37
④	Horn	
⑤	DIRECT SELECT lever	126
⑥	PARKTRONIC warning display	142
⑦	Overhead control panel	43
⑧	Climate control systems	114
⑨	Ignition lock	121
	Start/Stop button	121

	Function	Page
⑩	Adjusts the steering wheel	103
	Steering wheel heating	103
⑪	Combination switch	107
⑫	Parking brake	
⑬	Diagnostics connection	31
⑭	Opens the hood	220
⑮	Releases the parking brake	
⑯	Light switch	106
⑰	Night View Assist Plus	147

Instrument cluster

Displays

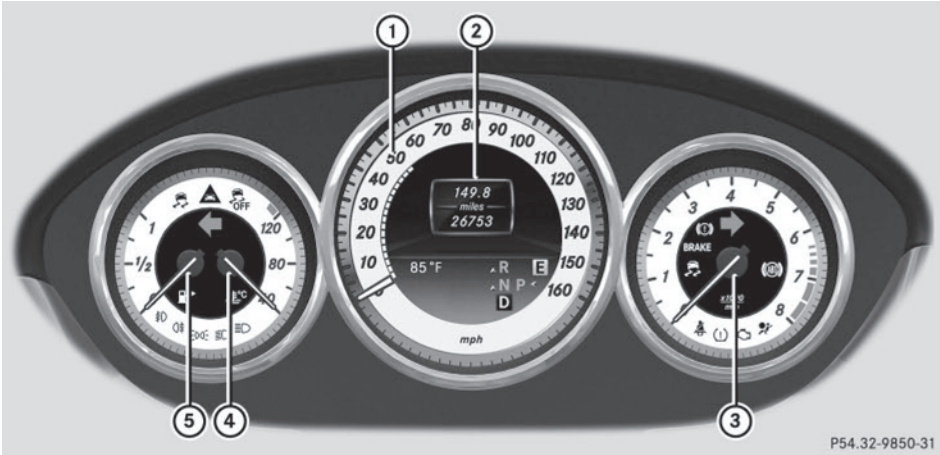

At a glance

P54.32-9850-31

	Function	Page
①	Speedometer with segments	
②	Multifunction display	
③	Tachometer	

	Function	Page
④	Coolant temperature	
⑤	Fuel gauge	

**i** Adjust the instrument cluster lighting using the on-board computer, see the Digital Operator's Instructions.

## Warning and indicator lamps

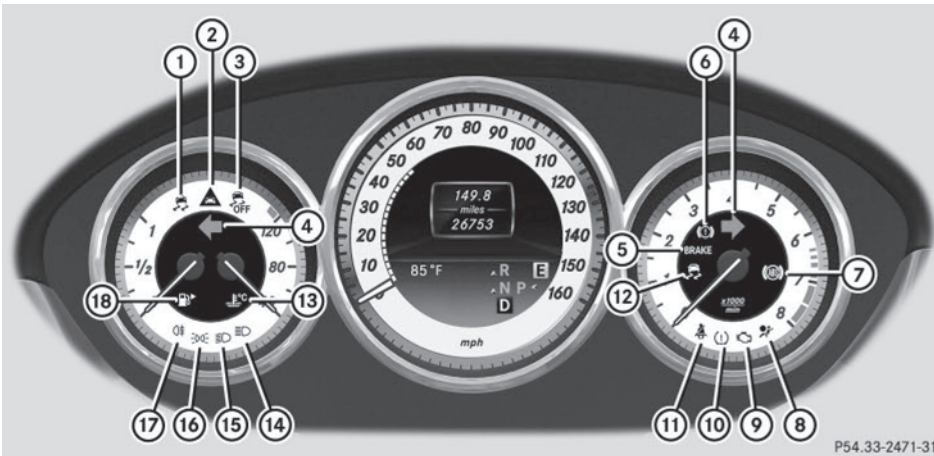

P54.33-2471-31

	Function	Page
①	ESP® SPORT handling mode in AMG vehicles	179 180
②	Distance warning	174
③	ESP® OFF	179
④	Turn signals	
⑤	Brakes (USA only)	174
⑥	Brakes (Canada only)	174
⑦	ABS	177
⑧	SRS	182
⑨	Check Engine	
⑩	Tire pressure monitor	174









	Function	Page
⑪	Seat belt	174
⑫	ESP® in AMG vehicles	180
⑬	Coolant	183
⑭	High-beam headlamps	
⑮	Low-beam headlamps	
⑯	Parking lamps	
⑰	This lamp has no function	
⑱	Reserve fuel	













Multifunction steering wheel



At a glance

	Function	Page
①	Multifunction display	
②	COMAND display	
③	 Switches on the Voice Control System; see the separate operating instructions	
④	 Rejects or ends a call Exits phone book/redial memory  Makes or accepts a call Switches to the redial memory   Adjusts the volume  Mute	

	Function	Page
⑤	  Selects a menu   Selects a submenu or scrolls through lists  Confirms your selection Hides display messages	   
⑥	 Back Switches off the Voice Control System; see the separate operating instructions	

## Center console

## Center console, upper section

At a glance

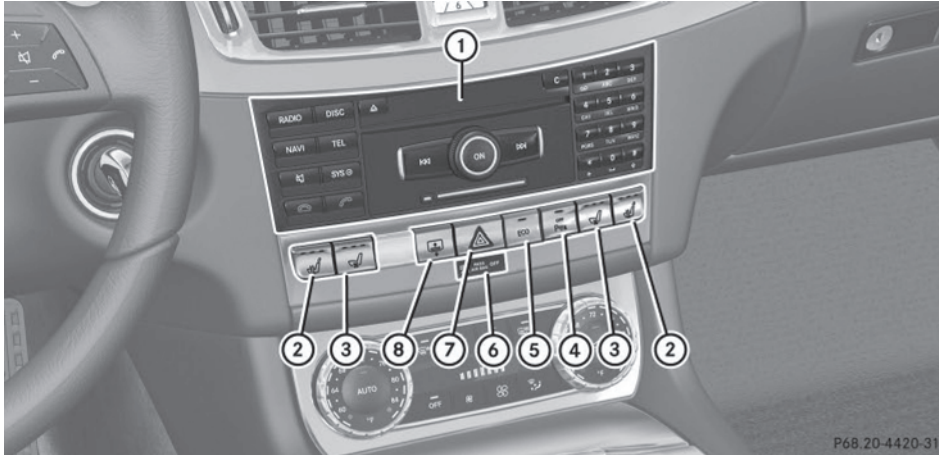

P68.20-4420-31

	Function	Page
①	COMAND	
②	Seat heating	102
③	Seat ventilation	
④	PARKTRONIC	142
⑤	ECO ECO start/stop function (AMG vehicles)	

	Function	Page
⑥	Indicator lamp	53
⑦	Hazard warning lamps	106
⑧	Roller sunblind in the rear window	

## Center console, lower section

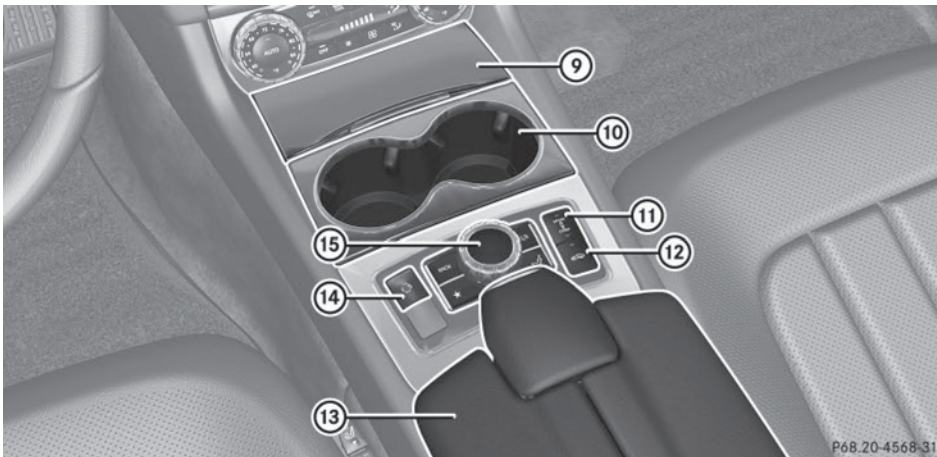

At a glance

	Function	Page		Function	Page
⑨	Stowage compartment Ashtray Cigarette lighter Socket Cup holder		⑫	Sets the vehicle level	
⑩	Cup holder		⑬	Stowage compartment with Media Interface	
⑪	Sets the suspension tuning		⑭	Selects the drive program	
			⑮	COMAND controller	

## Center console, lower section (AMG vehicles)

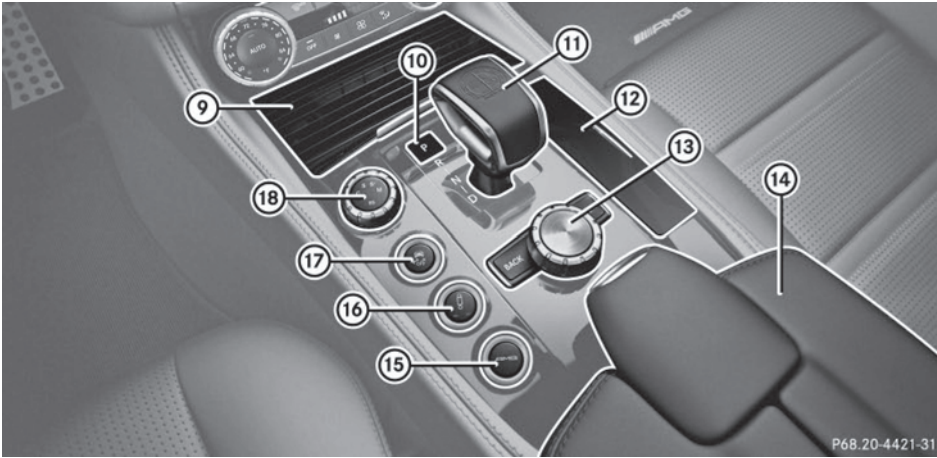

P68.20-4421-31

	Function	Page
⑨	Cup holder	
⑩	Engages parking position <b>P</b>	131
⑪	Selector lever	125
⑫	Ashtray	
	Cigarette lighter	
	Socket	
⑬	COMAND controller	
⑭	Stowage compartment with Media Interface	





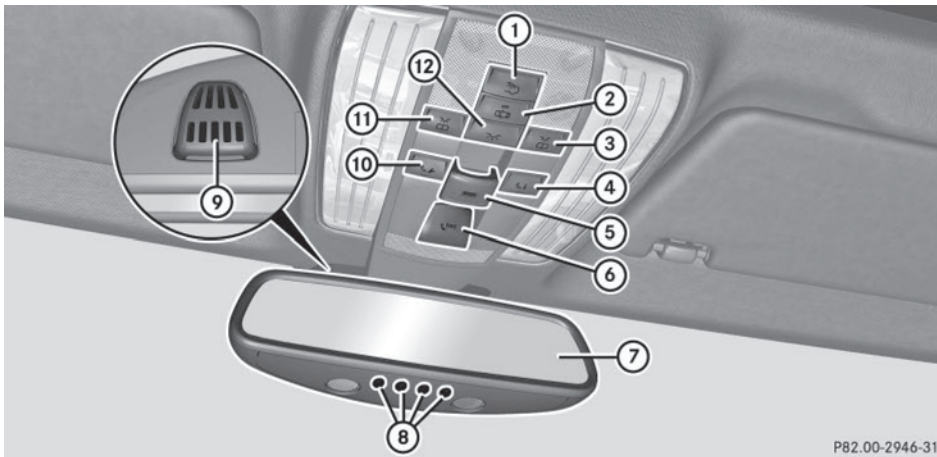









	Function	Page
⑮	Calls up/saves the suspension tuning	
⑯	Sets the suspension tuning	
⑰	ESP®	76
⑱	Drive program selector	

## Overhead control panel



P82.00-2946-31

At a glance

	Function	Page		Function	Page
①	 Switches the rear interior lighting on/off		⑧	Buttons for the garage door opener	214
②	 Switches the automatic interior lighting control on/off		⑨	Microphone for mbrace (emergency call system), telephone and the Voice Control System; see the separate operating instructions	
③	 Switches the right-hand reading lamp on/off		⑩	 Roadside Assistance call button (mbrace system)	211
④	 MB Info call button (mbrace system)	212	⑪	 Switches the left-hand reading lamp on/off	
⑤	 Opens/closes the sliding sunroof	96	⑫	 Switches the front interior lighting on/off	
⑥	 SOS button (mbrace system)	210			
⑦	Rear-view mirror				

## Door control panel

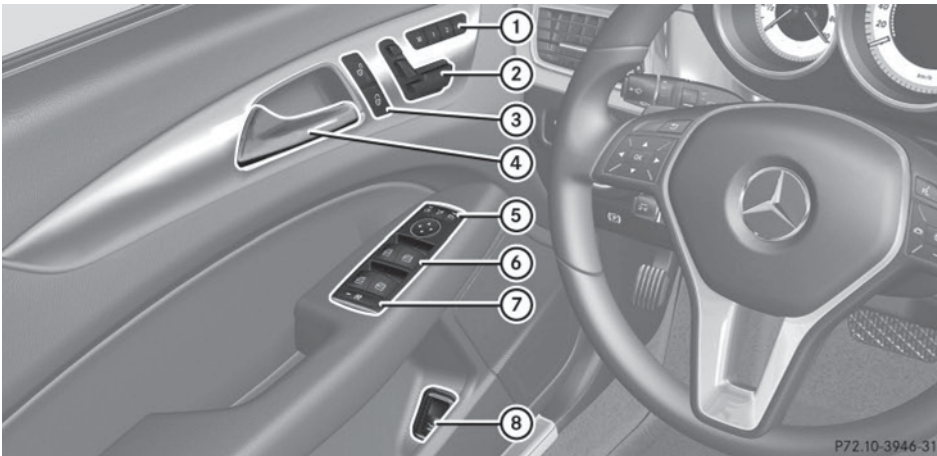

P72.10-3946-31

	Function	Page
①	<b>M</b> <b>1</b> <b>2</b> <b>3</b> Stores settings for the seat, exterior mirrors and steering wheel	
②	Adjusts the seats electrically	
③	Unlocks/locks the vehicle	
④	Opens the door	
⑤	 Adjusts and folds the exterior mirrors in/out electrically	

	Function	Page
⑥	Opens/closes the side windows	
⑦	Activates/deactivates the override feature for the side windows in the rear compartment	
⑧	Opens/closes the trunk lid	92

Useful information ..... 46  
Panic alarm ..... 46  
Occupant safety ..... 46  
Children in the vehicle ..... 66  
Driving safety systems ..... 72  
Theft deterrent locking system ..... 80



## Useful information

- i** This Operator's Manual describes all models and all standard and optional equipment of your vehicle available at the time of publication of the Operator's Manual. Country-specific differences are possible. Please note that your vehicle may not be equipped with all features described. This also applies to safety-related systems and functions.
- i** Read the information on qualified specialist workshops: (> page 32).

## Panic alarm



- ▶ **To activate:** press **PANIC** button ① for at least one second.  
An alarm sounds and the exterior lighting flashes.
  - ▶ **To deactivate:** press **PANIC** button ① again.
- or
- ▶ Insert the SmartKey into the ignition lock.
- or
- ▶ Press the KEYLESS-GO Start/Stop button.  
The KEYLESS-GO key must be in the vehicle.

## Occupant safety

## Important safety notes

**⚠ WARNING**

Modifications to the restraint systems could result in them not functioning properly any more. The restraint systems could then no longer protect vehicle occupants as they are designed to do and could fail in the event of an accident or activate unexpectedly, for example. There is an increased risk of injury. Never modify parts of the restraint systems. Do not attempt to modify the wiring as well as electronic components or their software. If it is necessary to modify an air bag system to accommodate a person with disabilities, contact an authorized Mercedes-Benz center. USA only: for further information contact our Customer Assistance Center at 1-800-FOR-MERCEdes (1800-367-6372).

In this section, you will learn the most important facts about the restraint system components of the vehicle.

The restraint system consists of:

- Seat belts
- Child restraint systems
- LATCH-type (ISOFIX) child seat securing system

Additional protection is provided by:

- SRS (Supplemental Restraint System)
- NECK-PRO head restraints/NECK-PRO luxury head restraints
- PRE-SAFE®
- Air bag system components with:
  - PASSENGER AIR BAG OFF indicator lamp
  - Front-passenger seat with Occupant Classification System (OCS)

Although the systems are independent, their protective functions work in conjunction with each other. Not all air bags are deployed in an accident.

- i** For information on infants and children traveling with you in the vehicle as well as



restraint systems for infants and children, see "Children in the vehicle" (> page 66).

## SRS (Supplemental Restraint System)

### Introduction

SRS consists of:

- The  SRS warning lamp
- Air bags
- The air bag control unit with crash sensors
- Emergency Tensioning Devices for the front seat belts and the outer seat belts in the rear
- Seat belt force limiters for the front seat belts and the outer seat belts in the rear

SRS reduces the risk of occupants coming into contact with the vehicle's interior in the event of an accident. It can also reduce the forces to which vehicle occupants are subjected during an accident.

### SRS warning lamp

#### WARNING

If SRS is malfunctioning, child restraint system components may be triggered unintentionally or might not be triggered at all in the event of an accident with a high rate of vehicle deceleration. There is an increased risk of injury, possibly even fatal.



Have SRS checked and repaired immediately at a qualified specialist workshop.

SRS functions are checked regularly when you switch on the ignition and when the engine is running. Therefore, malfunctions can be detected in good time.

The  SRS warning lamp in the instrument cluster lights up when the ignition is switched on. It goes out no later than a few seconds after the engine is started.

The SRS components are in operational readiness when the  SRS indicator lamp goes out while the engine is running.

There is a malfunction if:

- the  SRS warning lamp does not light up when the ignition is switched on
- the engine is running and the  SRS warning lamp does not go out after a few seconds
- the engine is running and the  SRS warning lamp lights up again

### Safety guidelines for seat belts, Emergency Tensioning Devices (ETDs) and air bags

#### WARNING

- Damaged seat belts or seat belts that have been subjected to stress in an accident must be replaced. Their anchoring points must also be checked. Only use seat belts installed or supplied by an authorized Mercedes-Benz Center.
- Air bags and pyrotechnic Emergency Tensioning Devices (ETDs) contain perchlorate material, which may require special handling and regard for the environment. Check your national disposal guidelines. California residents, see [www.dtsc.ca.gov/HazardousWaste/Perchlorate/index.cfm](http://www.dtsc.ca.gov/HazardousWaste/Perchlorate/index.cfm).
- Air bags and ETDs are designed to function on a one-time-only basis. An air bag or ETD that has deployed must be replaced. PRE-SAFE® has electrically operated reversible belt tensioners in addition to the pyrotechnic ETDs.
- Do not pass seat belts over sharp edges. They could tear.
- Do not make any modification that could change the effectiveness of the seat belts.
- Do not bleach or dye seat belts as this may severely weaken them. In a crash they may not be able to provide adequate protection.
- No modifications of any kind may be made to any components or wiring of the SRS.
- Do not change or remove any component or part of the SRS.

- Do not install additional trim material, seat covers, badges, etc. to the:
  - padded steering wheel boss
  - knee bag covers
  - front-passenger air bag cover
  - outer side of front seat bolsters
  - side trim next to the rear seat backrest
  - roof lining trim
- Do not install additional electrical/ electronic equipment on or near SRS components and wiring.
- Keep area between air bags and occupants free of objects (e.g. packages, purses, umbrellas, etc.).
- Do not hang items such as coat hangers from the coat hooks or handles over the door. These items may be thrown around in the vehicle and cause head and other injuries when the window curtain air bag is deployed.
- Air bag system components will be hot after an air bag has inflated. Do not touch them.
- Never place your feet on the instrument panel, dashboard, or on the seat. Always keep both feet on the floor in front of the seat.
- Improper repair work on the SRS creates a risk of rendering the SRS inoperative or causing unintended air bag deployment. Work on the SRS must therefore only be performed by qualified technicians. Contact an authorized Mercedes-Benz Center.
- For your protection and the protection of others, when scrapping the air bag unit or ETD, our safety instructions must be followed. These instructions are available from any authorized Mercedes-Benz Center.
- Given the considerable deployment speed, required inflation volume, and the material of the air bags, there is the possibility of abrasions or other, potentially more serious injuries resulting from air bag deployment.

If you sell your vehicle, Mercedes-Benz strongly recommends that you inform the subsequent owner that the vehicle is equipped with SRS. Also, refer them to the applicable section in the Operator's Manual.

## Air bags

### Important safety notes

NEVER use a rearward facing child restraint system on a seat protected by an ACTIVE AIR BAG in front of it, DEATH or SERIOUS INJURY to the CHILD can occur.

#### WARNING

If you modify the air bag covers or affix objects such as stickers to them, the air bags may not function correctly. There is an increased risk of injury.

Never modify the air bag covers or affix objects to them.

#### WARNING

Using unsuitable seat covers could restrict or even prevent deployment of the air bags integrated into the seats. Consequently, the air bags cannot protect vehicle occupants as they are designed to do. In addition, the function of the air bag deactivation system could be restricted. This poses an increased risk of injury or even fatal injury.

You should only use seat covers that have been approved for the respective seat by Mercedes-Benz.

#### WARNING

The air bag parts are hot after the airbag has been deployed. There is a risk of injury.

Do not touch the air bag parts. Have the deployed air bags replaced at a qualified specialist workshop as soon as possible.

 **WARNING**

Air bags are designed to reduce the incidence of injuries and fatalities in certain situations:

- frontal impacts (driver's and front-passenger front air bags and knee bags)
- side impacts (side impact air bags, window curtain air bags and pelvis air bags)
- rollover (window curtain air bags)

However, no system available today can completely eliminate injuries and fatalities.

When the air bags are deployed, a small amount of powder is released. The powder generally does not constitute a health hazard and does not indicate that there is a fire in the vehicle. In order to prevent potential breathing difficulties, you should leave the vehicle as soon as it is safe to do so. If you have any breathing difficulty but cannot get out of the vehicle after the air bag inflates, then get fresh air by opening a window or door.

 **WARNING**

In order to reduce the potential danger of injuries caused during the deployment of the front air bags, the driver and front passenger must always be correctly seated and wear their seat belts.

For maximum protection in the event of a collision, you must always be in the normal seat position with your back against the backrest. Fasten your seat belt and make sure that it is correctly positioned on your body.

As the air bag inflates with considerable speed and force, a proper seating position and correct positioning of the hands on the steering wheel will help to keep you at a safe distance from the air bag. Occupants who are not wearing their seat belt, are not seated properly or are too close to the air bag can be seriously injured or killed by an air bag, as it inflates with great force instantaneously:

- sit with the seat belt fastened correctly and in a position that is as upright as possible with your back against the backrest.
- move the driver's seat as far back as possible, still permitting proper operation of vehicle controls. The distance from the center of the driver's chest to the center of the air bag cover on the steering wheel must be at least 10 inches (25 cm). You should be able to accomplish this by adjusting the seat and steering wheel. If you have any difficulties, please contact an authorized Mercedes-Benz Center.
- do not lean your head or chest close to the steering wheel or dashboard.
- only hold the steering wheel on the outside. Placing hands and arms inside the rim can increase the risk and potential severity of hand/arm injury if the driver front air bag inflates.
- adjust the front-passenger seat as far back as possible from the dashboard when the seat is occupied.
- occupants, especially children, should never place their bodies or lean their heads in the area of the door where the side impact air bag inflates. This could result in serious or fatal injuries should the side impact air bag be deployed. Always sit as upright as possible, wear the seat belt properly and use an appropriately sized infant restraint, toddler restraint or booster seat recommended for the size and weight of the child.

Failure to follow these instructions can result in severe injuries to you or other occupants.

If you sell your vehicle, it is important that you make the buyer aware of this safety information. Be sure to give the buyer this Operator's Manual.

If the air bags are deployed, you will hear a bang, and a small amount of powder may also be released. Only in rare cases will the bang affect your hearing. The powder that is released generally does not constitute a health hazard and does not indicate that there is a fire in the vehicle. The dust might cause some temporary breathing difficulty for people with asthma or other breathing trouble. To avoid this, you may wish to get out of the vehicle as soon as it is safe to do so. You can also open the window to allow fresh air to enter the vehicle interior. The  SRS warning lamp lights up.

The air bag installation locations are identified by the AIR BAG symbol.

The air bags are deployed if the air bag control unit detects the need for deployment. Only in the event of such a situation will the air bags provide their supplemental protection.

If the driver and front passenger do not wear their seat belts, it is not possible for the air bags to provide their supplemental protection.

In the event of other types of impacts and impacts below air bag deployment thresholds, the air bags will not deploy. The driver and passenger will then be protected to the extent possible by a properly fastened seat belt. A properly fastened seat belt is also needed to provide the best possible protection in a rollover.

Air bags provide additional protection; they are not, however, a substitute for seat belts. All vehicle occupants must fasten their seat belts regardless of whether your vehicle is equipped with air bags or not.

It is important for your safety and that of your passenger to have deployed air bags replaced and to have any malfunctioning air bags repaired. This will help to make sure the air bags continue to perform their protective

function for the vehicle occupants in the event of a crash.

- i** After an air bag has been deployed, have the vehicle towed to the nearest qualified specialist workshop, even if your vehicle is ready to drive.

### Front air bags

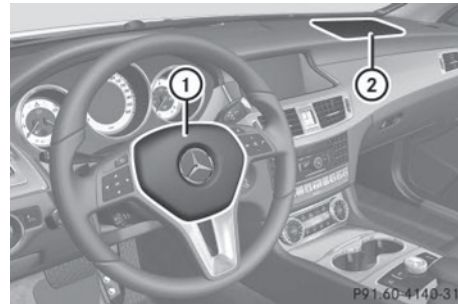

Driver's air bag ① deploys in front of the steering wheel; front-passenger front air bag ② deploys in front of and above the glove box.

The front air bags increase protection for the driver's and front passenger's head and chest.

They are deployed:

- at the start of an accident with a high rate of vehicle acceleration or deceleration in a longitudinal direction
- if the system determines that air bag deployment can offer additional protection to that provided by the seat belt
- independently of other air bags in the vehicle

The release time of the front air bags is dependent upon the use of the seat belt.

If the vehicle rolls over, the front air bags are generally not deployed.

Your vehicle has adaptive, two-stage front air bags. In the event of a collision, the air bag control unit evaluates the vehicle deceleration. In the first deployment stage, the front air bag is filled with enough propellant gas to reduce the risk of injuries.

The front air bag is fully deployed if a second deployment threshold is exceeded within a few milliseconds.

The deployment of the front-passenger front air bag is also influenced by the weight category of the front passenger, which is determined by the Occupant Classification System (OCS) (> page 53).

The lighter the passenger-side occupant, the higher the vehicle deceleration rate required (predicted at the start of the impact) for second-stage inflation of the front-passenger front air bag. In the second stage, the front air bags are inflated with the maximum amount of propellant gas available.

The front air bags are not deployed in situations where a low impact severity is predicted. You will then be protected by the fastened seat belt.

The front-passenger front air bag will only deploy if:

- the system, based on the OCS weight sensor readings, detects that the front-passenger seat is occupied
- the PASSENGER AIR BAG OFF indicator lamp on the center console is not lit (> page 53)
- the air bag control unit predicts a high impact severity

### Knee bags

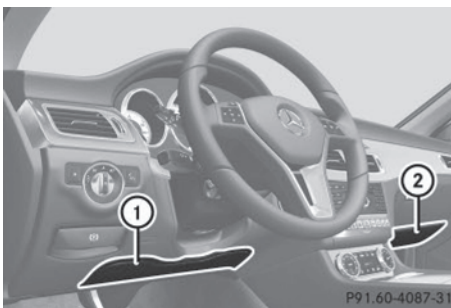

Driver's knee bag ① deploys underneath the steering column and front-passenger knee bag ② underneath the glove box. They

deploy together with the front air bags. They are designed to operate together with the front air bags in frontal impacts if certain thresholds are exceeded. The knee bags operate at best in conjunction with correctly positioned and fastened seat belts.

Knee bags provide increased protection for the driver and front passenger against the risk of:

- knee injuries
- thigh injuries
- lower leg injuries

### Side impact air bags

#### WARNING

Using unsuitable seat covers could restrict or even prevent deployment of the air bags integrated into the seats. Consequently, the air bags cannot protect vehicle occupants as they are designed to do. In addition, the function of the air bag deactivation system could be restricted. This poses an increased risk of injury or even fatal injury.

You should only use seat covers that have been approved for the respective seat by Mercedes-Benz.

#### WARNING

Sensors to control the air bags are located in the doors. Modifications or work not performed correctly to the doors or door paneling, as well as damaged doors, can lead to the function of the sensors being impaired. The air bags might therefore not function properly any more. Consequently, the air bags cannot protect vehicle occupants as they are designed to do. There is an increased risk of injury.

Never modify the doors or parts of the doors. Always have work on the doors or door paneling carried out at a qualified specialist workshop.

You should only use seat covers that have been approved for your vehicle by Mercedes-

Benz. The seat covers must have a special tear seam for side impact air bags. Otherwise, the side impact air bags cannot deploy correctly and therefore cannot provide the intended protection in the event of an accident.

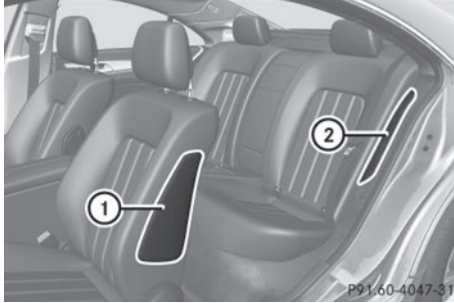

Front side impact air bags ① and rear side impact air bags ② deploy next to the outer seat cushions.

When deployed, the side impact air bags offer additional protection for the thorax of the vehicle occupants on the side of the vehicle on which the impact occurs. However, they do not protect the:

- head
- neck
- arms

The side impact air bags are deployed:

- on the side on which an impact occurs
- at the start of an accident with a high rate of lateral vehicle deceleration or acceleration, e.g. in a side impact
- independently of the use of the seat belt
- independently of the front air bags
- independently of the ETDs

If the vehicle rolls over, the side impact air bags are generally not deployed. Side impact air bags are deployed if the system detects high vehicle deceleration or acceleration in a lateral direction and determines that side impact air bag deployment can offer additional protection to that provided by the seat belt.

Side impact air bags will not deploy in side impacts which do not exceed the system's preset deployment thresholds for lateral acceleration/deceleration. You will then be protected by the fastened seat belt.

The side impact air bag on the front-passenger side is not deployed in the following situations:

- OCS has detected that the front-passenger seat is unoccupied.
- the front-passenger seat belt is not fastened.

The side impact air bag on the front-passenger side will deploy if the front-passenger seat belt is fastened, regardless of whether the front-passenger seat is occupied or not.

### Pelvis air bags

#### WARNING

Only use seat covers which have been tested and approved by Mercedes-Benz for your vehicle model. Using seat covers or other seat coverings can cause a malfunction of the side impact air bags and/or the pelvis air bags. Contact an authorized Mercedes-Benz Center for availability.



Pelvis air bags ① enhance the level of protection of the vehicle occupants on the side of the vehicle on which the impact occurs.

The pelvis air bags deploy next to and below the outer seat cushions. They are deployed:

- on the side on which an impact occurs
- at the start of an accident with a high rate of lateral vehicle deceleration or acceleration, e.g. in a side impact
- independently of the use of the seat belt
- independently of the front air bags
- independently of the ETDs

If the vehicle rolls over, the pelvis air bags are generally not deployed. Side impact air bags are deployed if the system detects high vehicle deceleration or acceleration in a lateral direction and determines that side impact air bag deployment can offer additional protection to that provided by the seat belt.

Pelvis air bags ① will not deploy in side impacts which do not exceed the system's preset deployment thresholds for lateral acceleration/deceleration. You will then be protected by the fastened seat belt.

The pelvis air bag on the front-passenger side is not deployed in the following situations:

- OCS has detected that the front-passenger seat is unoccupied.
- the front-passenger seat belt is not fastened.

The pelvis air bag on the front-passenger side will deploy if the front-passenger seat belt is fastened, regardless of whether the front-passenger seat is occupied or not.

### Window curtain air bags

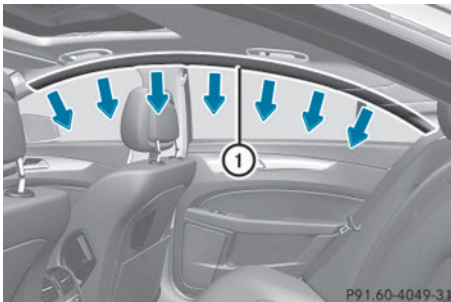

Window curtain air bags ① enhance the level of protection for the head, but not chest or arms, of the vehicle occupants on the side of the vehicle on which the impact occurs.

The window curtain air bags are integrated into the side of the roof frame and deploy in the area from the A-pillar to the C-pillar.

Window curtain air bags are deployed:





- at the start of an accident with a high rate of lateral vehicle deceleration or acceleration, e.g. in a side impact
- on the side on which an impact occurs
- on the driver's side and passenger side, in the event of a vehicle rollover and if the system determines that air bag deployment can offer the vehicle occupants additional protection to that provided by the seat belt
- independently of the use of the seat belt
- regardless of whether the front-passenger seat is occupied
- independently of the front air bags

Window curtain air bags ① will not deploy in the event of impacts which do not exceed the system's preset deployment thresholds for vehicle acceleration/deceleration. You will then be protected by the fastened seat belt.

### Occupant Classification System (OCS)

#### Method of operation

#### ⚠ WARNING

If the   indicator lamp illuminates when an adult or someone larger than a small individual is in the front-passenger seat, have the front passenger reposition himself or herself in the seat until the   indicator lamp goes out.

In the event of a collision, the air bag control unit will not allow front-passenger front air bag deployment when the OCS has classified the front-passenger seat occupant as weighing as much as or less than a typical 12-month-old child in a standard child restraint



or if the front-passenger seat is classified as being empty.

When the OCS senses that the front-passenger seat occupant is classified as being up to or less than the weight of a typical 12-month-old child in a standard child restraint, the  indicator lamp will illuminate when the engine is started and remain illuminated, indicating that the front-passenger front air bag is deactivated.

When the OCS senses that the front-passenger seat is classified as being empty, the  indicator lamp will illuminate when the engine is started and remain illuminated, indicating that the front-passenger front air bag is deactivated.

When the OCS senses that the front-passenger seat occupant is classified as being heavier than the weight of a typical 12-month-old child seated in a standard child restraint or as being a small individual (such as a young teenager or a small adult), the

 indicator lamp will illuminate for approximately 6 seconds when the engine is started and then, depending on occupant weight sensor readings from the front-passenger seat, remain illuminated or go out.

With the  indicator lamp illuminated, the front-passenger front air bag is deactivated. With the  indicator lamp out, the front-passenger front air bag is activated.

When the OCS senses that the front-passenger seat occupant is classified as an adult or someone larger than a small individual, the  indicator lamp will illuminate for approximately 6 seconds when the engine is started and then go out, indicating that the front-passenger front air bag is activated.

If the  indicator lamp is illuminated, the front-passenger front air bag and the front-passenger knee bag are deactivated and will not be deployed.

If the  indicator lamp is not illuminated, the front-passenger front air bag and the front-passenger knee bag are activated and will be deployed:

- in the event of certain frontal impacts
- if impact exceeds a preset deployment threshold
- independently of the side impact air bag or pelvis air bag

If the front-passenger front air bag is deployed, the rate of inflation will be influenced by:

- the rate of relevant vehicle deceleration as assessed by the air bag control unit
- the front passenger's weight category as identified by OCS

#### WARNING

According to accident statistics, children are safer when properly restrained on the rear seats than on the front-passenger seat. Thus, we strongly recommend that children be placed in the rear seats whenever possible. Regardless of seating position, children 12 years old and under must be seated and properly secured in an appropriate infant restraint, toddler restraint, or booster seat recommended for the size and weight of the child.





The infant or child restraint must be properly secured with the vehicle's seat belt, the seat belt and Top Tether strap, or lower LATCH-type (ISOFIX) child seat retaining loops and Top Tether strap, fully in accordance with the infant or child seat manufacturer's instructions.

Occupants, especially children, should always sit as upright as possible, wear the seat belt properly and use an appropriately sized infant restraint, toddler restraint, or booster seat recommended for the size and weight of the child.

Children can be killed or seriously injured by an inflating air bag.





Note the following important information if it is necessary to carry a child on the front-passenger seat:

- Your vehicle is equipped with air bag technology designed to deactivate the front-passenger front air bag and the front-passenger knee bag in your vehicle when the system senses the weight of a typical 12-month-old child or less along with the weight of a standard appropriate child restraint on the front-passenger seat.
- A child in a rear-facing child restraint on the front-passenger seat will be seriously injured or even killed if the front-passenger front air bag inflates in a collision which could occur under some circumstances, even with the air bag technology installed in your vehicle. The only means to eliminate this risk completely is never to place a child in a rear-facing child restraint in the front-passenger seat. We therefore strongly recommend that you always place a child in a rear-facing child restraint on the rear seat.
- If you install a rear-facing child restraint on the front-passenger seat, make sure the  indicator lamp is illuminated, indicating that the front-passenger front air bag and front-passenger knee bag are deactivated. Should the  indicator lamp not illuminate or go out while the restraint is installed, please check installation. Periodically check the  indicator lamp while driving to make sure that the  indicator lamp is illuminated. If the  indicator lamp goes out or remains out, do not transport a child on the front-passenger seat until the system has been repaired. A child in a rear-facing child restraint on the front-passenger seat could be seriously injured or even killed if the front-passenger front air bag is deployed.

- If you place a child in a forward-facing child restraint on the front-passenger seat:
  - move the seat as far back as possible
  - use the proper child restraint recommended for the age, size and weight of the child
  - secure child restraint with the vehicle's seat belt according to the child seat manufacturer's instructions
- For children larger than the typical 12-month-old child, the front-passenger front air bag and the front-passenger knee bag may or may not be activated.

#### **WARNING**

If the red  SRS warning lamp in the instrument cluster and the  indicator lamp light up simultaneously, the OCS is malfunctioning. The front passenger front air bag and the front passenger knee bag will be deactivated in this case. Have the system checked by qualified technicians as soon as possible. Contact an authorized Mercedes-Benz Center.

Only have the seat repaired or replaced at an authorized Mercedes-Benz Center.

In order to ensure proper operation of the air bag system and OCS:

- Sit with the seat belt properly fastened in a position that is as upright as possible with your back against the seat backrest.
- When seated, a passenger should not position him/herself in such a way as to cause the passenger's weight to be lifted from the seat cushion as this may result in the OCS being unable to correctly approximate the passenger's weight category.
- Read and observe all warnings in this chapter.



If the SmartKey is removed from the ignition lock or is in position **0**, PASSENGER AIR BAG OFF indicator lamp **1** does not light up.

The Occupant Classification System (OCS) categorizes the occupant on the front-passenger seat using a weight sensor.

The front-passenger front air bag and the front-passenger knee bag are deactivated automatically for certain weight categories.

If the PASSENGER AIR BAG OFF indicator lamp lights up, the front-passenger front air bag and the front-passenger knee bag are disabled.

The PASSENGER AIR BAG OFF indicator lamp shows you the current status.

The system does not deactivate:

- the side impact air bag
- the pelvis air bag
- the window curtain air bag
- the Emergency Tensioning Devices

To be classified correctly, the front passenger must sit:

- with the seat belt fastened correctly
- in a position that is as upright as possible with their back against the seat backrest
- with their feet on the floor

The OCS weight sensor reading is affected if the occupant's weight is transferred, e.g. by leaning on the armrest.

If the front-passenger seat, the seat cover or the seat cushion are damaged, have the necessary repair work carried out at a qualified specialist workshop.

For safety reasons, Mercedes-Benz recommends that you only use seat accessories that have been approved by Mercedes-Benz.

Both the driver and the front passenger should always observe the PASSENGER AIR BAG OFF indicator lamp as an indication of whether or not the front passenger is positioned correctly. Observe also the air bag display messages that can be displayed in the instrument cluster (▷ page 169).

If the driver's air bag deploys, this does not mean that the front-passenger front air bag will also deploy.

The OCS may have detected that the seat:

- is empty or occupied by the weight of a typical child up to twelve months old, seated in a child restraint system.
- is occupied by a small individual, such as a young teenager or a small adult.
- is occupied by a child in a child restraint system whose weight is greater than that of a typical twelve month old child.

These are examples of when the OCS deactivates the front-passenger front air bag and front-passenger knee bag. Deactivation takes place although the collision fulfills the criteria for deploying the driver's air bag.

For further information, see "Air bag display messages" (▷ page 169).

### System self-test

#### WARNING

If the  indicator lamp does not illuminate, the system is not functioning. You must contact an authorized Mercedes-Benz Center before seating any child on the front passenger seat.

#### WARNING

Objects between the seat surface and the child restraint system could affect the function of the OCS. This could result in the front-passenger front air bag not functioning

as intended during an accident. This poses an increased risk of injury or even fatal injury.

Do not place any objects between the seat surface and the child restraint system. Make sure that the bottom and back of the child restraint system make full contact with the front-passenger seat cushion and backrest. Always comply with the child restraint system manufacturer's installation instructions.

The PASSENGER AIR BAG OFF indicator lamp lights up:

- if you turn the SmartKey in the ignition lock to position **1** or **2**
- if you press the KEYLESS-GO Start/Stop button once or twice on vehicles with KEYLESS-GO
- if an adult is seated properly on the front-passenger seat and the OCS classifies the occupant as an adult

The PASSENGER AIR BAG OFF indicator lamp goes out again after approximately six seconds.

If the seat is not occupied and the OCS detects that the front-passenger seat is empty, the PASSENGER AIR BAG OFF indicator lamp will continue to light up. The PASSENGER AIR BAG OFF indicator lamp will not go out.

For more information about the OCS, see "Problems with the Occupant Classification System" (▷ page 58).

### Problems with the Occupant Classification System

#### WARNING

If the  indicator lamp illuminates and remains illuminated when the weight of a typical adult or someone larger than a small individual has been detected on the passenger seat, do not allow any occupant to use the passenger seat until the system has been repaired.

#### WARNING

If the  indicator lamp does not illuminate or remains out with the weight of a typical 12-month-old child in a standard child restraint or less, or is unoccupied, on the front-passenger seat, do not transport a child on the front-passenger seat until the system has been repaired.

Problem	Possible causes/consequences and ► Solutions
<p>The PASSENGER AIR BAG OFF indicator lights up and remains on.</p> <p>The person on the front-passenger seat:</p> <ul style="list-style-type: none"> <li>• has the weight of a typical adult</li> <li>• has been determined by the system not to be a child</li> </ul>	<p>The OCS is malfunctioning.</p> <ul style="list-style-type: none"> <li>► Make sure that the front passenger is sitting in a correct, upright position.</li> <li>► Have the OCS checked as soon as possible at a qualified specialist workshop.</li> <li>► Observe the additional display messages in the multifunction display (► page 169).</li> </ul>

Problem	Possible causes/consequences and ► Solutions
<p>The PASSENGER AIR BAG OFF indicator lamp does not light up and/or stays on.</p> <p>The front-passenger seat is:</p> <ul style="list-style-type: none"> <li>• unoccupied</li> <li>• occupied with the weight of a child up to twelve months old in a child restraint system</li> </ul>	<p>The OCS is malfunctioning.</p> <ul style="list-style-type: none"> <li>► Make sure there is nothing between the seat cushion and the child seat.</li> <li>► Make sure that the backrest and base of the child restraint system are resting securely on the front-passenger seat. If necessary, adjust the position of the front-passenger seat.</li> <li>► When installing the child restraint system, make sure that the seat belt is tight. Do not pull the seat belt tight with the front-passenger seat adjustment. This could result in the seat belt being pulled too tightly.</li> <li>► Check the installation of the child restraint system.</li> <li>► Make sure that no objects are applying additional weight onto the seat.</li> <li>► If the PASSENGER AIR BAG OFF indicator lamp remains off, have the OCS checked immediately at a qualified specialist workshop. Do not transport a child on the front-passenger seat until the OCS has been repaired.</li> <li>► Observe the additional display messages in the multifunction display (► page 169).</li> </ul>

### NECK-PRO head restraints/NECK-PRO luxury head restraints

#### Important safety notes

##### WARNING

The function of the head restraint may be impaired if you:

- attach objects such as coat hangers to the head restraints, for example
- use head restraint covers

If you do so, the head restraints cannot fulfill their intended protective function in the event of an accident. In addition, objects attached to the head restraints could endanger other vehicle occupants. There is an increased risk of injury.

Do not attach any objects to the head restraints and do not use head restraint covers.

NECK-PRO head restraints/NECK-PRO luxury head restraints increase protection of the

driver's and front-passenger's head and neck. In the event of a rear collision of a certain severity, the NECK-PRO head restraints/NECK-PRO luxury head restraints on the driver's and the front-passenger seats are moved forwards and upwards. This provides better head support.

If the NECK-PRO head restraints/NECK-PRO luxury head restraints have been triggered in an accident, reset the NECK-PRO head restraints/NECK-PRO luxury head restraints on the driver's and front-passenger seats (► page 60). Otherwise, the additional protection will not be available in the event of another rear-end collision. NECK-PRO head restraints/NECK-PRO luxury head restraints that have been triggered are moved forwards and can no longer be adjusted.

Mercedes-Benz recommends that you have the NECK-PRO head restraints/NECK-PRO luxury head restraints checked at a qualified specialist workshop after a rear-end collision.

## Resetting triggered NECK-PRO head restraints/NECK-PRO luxury head restraints

### NECK-PRO head restraints

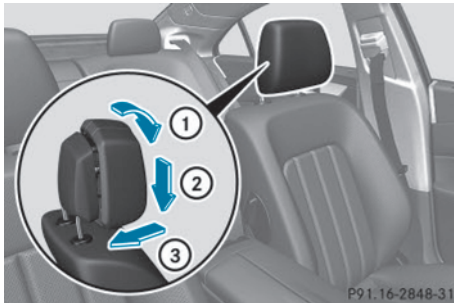

#### NECK-PRO head restraints

- ▶ Tilt the top of the NECK-PRO head restraint cushion forwards in the direction of arrow ①.
- ▶ Push the NECK-PRO head restraint cushion down in the direction of arrow ② as far as it will go.
- ▶ With your hand flat, firmly push the NECK-PRO head restraint cushion backwards in the direction of arrow ③ until it engages.
- ▶ Repeat this procedure for the second NECK-PRO head restraint.

### NECK-PRO luxury head restraints

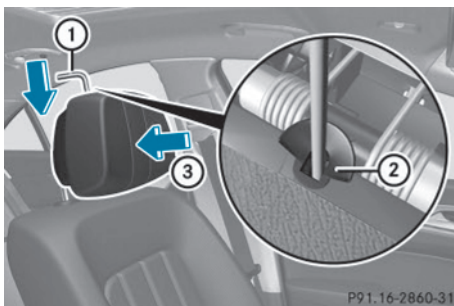

#### NECK-PRO luxury head restraints

- ▶ Remove resetting tool ① from the vehicle document wallet.
- ▶ Slide resetting tool ① into guide ② between the NECK-PRO luxury head

restraint and the rear cover of the head restraint.

- ▶ Push resetting tool ① downwards until you hear the head restraint deployment mechanism engage.
- ▶ Pull out resetting tool ①.
- ▶ With your hand flat, firmly push the NECK-PRO luxury head restraint cushion backwards in the direction of arrow ③ until it engages.
- ▶ Repeat this procedure for the second NECK-PRO luxury head restraint.
- ▶ Put resetting tool ① back into the vehicle document wallet.

**i** If you have difficulty resetting the NECK-PRO luxury head restraints, have this work carried out at a qualified specialist workshop.

### PRE-SAFE® (anticipatory occupant protection system)

**!** Make sure that there are no objects in the footwell or behind the seats when resetting the seats. There is a risk that the seats and/or the objects could be damaged.

PRE-SAFE® takes preemptive measures to protect occupants in certain hazardous situations. Despite your vehicle being equipped with the PRE-SAFE® system, the possibility of personal injuries occurring as a result of an accident cannot be eliminated.

Always adapt your driving style to suit the prevailing road and weather conditions and maintain a safe distance from the vehicle in front. Drive carefully.

PRE-SAFE® intervenes:

- if BAS intervenes, e.g. in emergency braking situations.
- if BAS PLUS intervenes powerfully – on vehicles with DISTRONIC PLUS.

- if, on vehicles with DISTRONIC PLUS, the radar sensor system detects an imminent danger of collision in certain situations.
- in critical driving situations, e.g. when physical limits are exceeded and the vehicle understeers or oversteers severely.

PRE-SAFE® takes the following measures depending on the hazardous situation detected:

- the front seat belts are pre-tensioned.
- the front-passenger seat is adjusted if it is in an unfavorable position.
- vehicles with a multicontour seat or active multicontour seat: the air pressure in the side bolsters of the seat cushion and backrest is increased.
- if the vehicle skids, the sliding sunroof and the side windows are closed so that only a small gap remains.

If the hazardous situation passes without resulting in an accident, PRE-SAFE® slackens the belt pre-tensioning. The air pressure in the side bolsters on the multicontour seat/ active multicontour seat is reduced again. All settings made by PRE-SAFE® can then be reversed.

If the seat belts are not released:

- ▶ When the vehicle is stationary, move the backrest or seat back slightly. The seat belt pre-tensioning is reduced and the locking mechanism is released.

Information about seat belt adjustment, a convenience function integrated into PRE-SAFE®, can be found in the "Seat belt adjustment" section (▷ page 63).

## Seat belts

### Important safety notes

#### WARNING

The seat belt does not offer the intended level of protection if the backrest is not in the upright position. When braking or in the event

of an accident, you could slide underneath the seat belt and sustain abdomen or neck injuries, for example. This poses an increased risk of injury or even fatal injury.

Adjust the seat properly before beginning your journey. Always make sure that the seat is in the upright position.

#### WARNING

Seat belts cannot protect as intended, if:

- they are damaged, extremely dirty, bleached or dyed
- the seat belt buckle is damaged or extremely dirty
- the Emergency Tensioning Devices or the belt anchorage has been modified.

Damage caused to seat belts in an accident may not be visible, e.g. by splinters of glass. Modified or damaged seat belts can tear or fail, for example in the event of an accident. Modified Emergency Tensioning Devices may be deployed unintentionally or fail to be deployed when required. There is an increased risk of injury, possibly even fatal.

Never modify seat belts, Emergency Tensioning Devices, seat belt anchorages and inertia reels. Ensure that seat belts are not damaged or worn and are clean.

Only use seat belts that have been approved for your vehicle by Mercedes-Benz.

The use of seat belts and infant and child restraint systems is required by law in:

- all 50 states
- the U.S. territories
- the District of Columbia
- all Canadian provinces

Even where this is not required by law, all vehicle occupants should correctly fasten their seat belts before starting the journey.

-  See "Children in the vehicle" (▷ page 66) for further information on infants and children traveling in the vehicle as well as on child restraint systems.

### Correct use of the seat belts

#### WARNING

##### USE SEAT BELTS PROPERLY

- Seat belts can only work when used properly. Never wear seat belts in any other way than as described in this section, as that could result in serious injuries in the event of an accident.
- Each occupant should wear their seat belt at all times, because seat belts help reduce the likelihood of and potential severity of injuries in accidents, including rollovers. The integrated restraint system includes SRS (driver front air bag, driver's side knee bag, front-passenger front air bag, side impact air bags, pelvis air bags, window curtain air bags for the side windows), Emergency Tensioning Devices, seat belt force limiters, and front seat knee bolsters. The system is designed to enhance the protection offered to properly belted occupants in certain frontal (front air bags, driver's side knee bag and ETDs) and side (side impact air bags, window curtain air bags, and ETDs) impacts which exceed preset deployment thresholds and in certain rollovers (window curtain air bags and ETDs).
- Never wear the shoulder belt under your arm, across your neck or off your shoulder. In a frontal crash, your body would move too far forward. That would increase the chance of head and neck injuries. The seat belt would also apply too much force to the ribs or abdomen, which could severely injure internal organs such as your liver or spleen.  
Adjust the seat belt so that the shoulder section is located as close as possible to the middle of the shoulder. It should not touch the neck. Never pass the shoulder portion of the seat belt under your arm. For this purpose, you can adjust the height of the seat belt outlet.

- Position the lap belt as low as possible on your hips and not across the abdomen. If the lap belt is positioned across your abdomen, it could cause serious injuries in a crash.
- Never wear seat belts over rigid or breakable objects in or on your clothing, such as eyeglasses, pens, keys etc., as these might cause injuries.
- Make sure the seat belt is always fitted snugly. Take special care of this when wearing loose clothing.
- Never use a seat belt for more than one person at a time. Do not fasten a seat belt around a person and another person or other objects at the same time.
- Seat belts should not be worn twisted. In a crash, you would not have the full width of the seat belt to distribute impact forces. The twisted seat belt against your body could cause injuries.
- Pregnant women should also always use a lap-shoulder belt. The lap belt portion should be positioned as low as possible on the hips to avoid any possible pressure on the abdomen.
- Place the seat backrest in a position that is as upright as possible.
- Check your seat belt during travel to make sure it is properly positioned.
- Never place your feet on the instrument panel, dashboard, or on the seat. Always keep both feet on the floor in front of the seat.
- When using a seat belt to secure infant restraints, toddler restraints, or children in booster seats, always follow the child seat manufacturer's instructions.

### Fastening seat belts

#### WARNING

According to accident statistics, children are safer when properly restrained on the rear seats than on the front-passenger seat. Thus, we strongly recommend that children be



placed in the rear seat whenever possible. Regardless of seating position, children 12 years old and under must be seated and properly secured in an appropriately sized child restraint system or booster seat recommended for the size and weight of the child. For additional information, see the "Children in the vehicle" section.

A child's risk of serious or fatal injuries is significantly increased if the child restraints are not properly secured in the vehicle and/or the child is not properly secured in the child restraint.

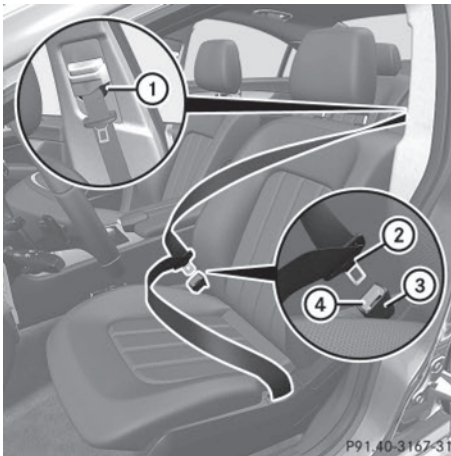

- ▶ Adjust the seat and move the backrest to an almost vertical position (▷ page 100).
- ▶ Pull the seat belt smoothly through belt sash guide ①.
- ▶ Without twisting it, guide the shoulder section of the seat belt across the middle of your shoulder and the lap section across your pelvis.
- ▶ Engage belt tongue ② in buckle ③. Seat-belt adjustment: if necessary, the driver's and front-passenger seat belts automatically adjust to the upper body (▷ page 63).

- ▶ If necessary, adjust the seat belt to the appropriate height (▷ page 64).
- ▶ If necessary, pull upwards on the shoulder section of the seat belt to tighten the belt across your body.

All seat belts except the driver's seat belt are equipped with a special seat belt retractor to securely fasten child restraint systems in the vehicle. Further information can be found under "Special seat belt retractor" (▷ page 69).

Information on releasing the seat belt with release button ④ (▷ page 64).

### Seat belt adjustment

The seat-belt adjustment function adjusts the driver's and front-passenger seat belt to the upper body of the occupants.

The belt strap is tightened slightly when:

- you engage the belt tongue in the belt buckle and you then turn the SmartKey to position 2 in the ignition lock.
- the SmartKey is in position 2 in the ignition lock and you then engage the belt tongue in the buckle.

The seat-belt adjustment will apply a retraction force if any slack is detected between the occupant and the seat belt. Do not hold on to the seat belt tightly while it is adjusting. You can switch the seat-belt adjustment on and off in the on-board computer (▷ page 161).

The seat-belt adjustment is an integral part of the PRE-SAFE® convenience function. More information about PRE-SAFE® can be found under "PRE-SAFE® (preventative occupant protection)" (▷ page 60).

### Belt height adjustment

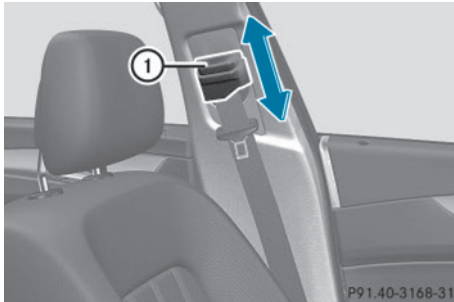

You can adjust the seat belt height on the front seats. Adjust the belt to a height that allows the upper part of the seat belt to be routed across the center of your shoulder.

- ▶ **To raise:** slide the belt sash guide upwards. The belt sash guide engages in various positions.
- ▶ **To lower:** press and hold belt sash guide release ①.
- ▶ Slide the belt sash guide downwards.
- ▶ Release belt sash guide release ① and make sure that the belt sash guide has engaged.

### Releasing seat belts

❗ Make sure that the seat belt is fully rolled up. Otherwise, the seat belt or belt tongue will be trapped in the door or in the seat mechanism. This could damage the door, the door trim panel and the seat belt. Damaged seat belts can no longer fulfill their protective function and must be replaced. Visit a qualified specialist workshop.

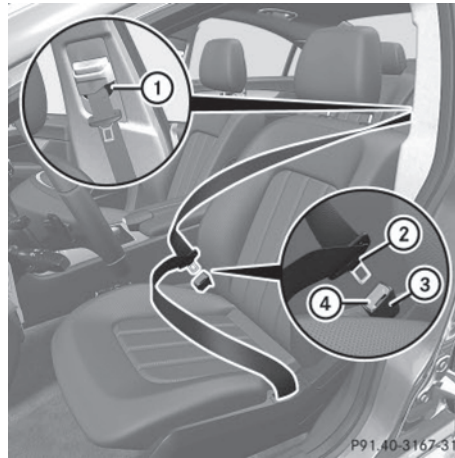



- ▶ Press release button ④ on belt buckle ③.
- ▶ Guide belt tongue ② to belt sash guide ①.

### Belt warning for the driver and front passenger

Regardless of whether the driver's and front-passenger seat belts have already been fastened, the  seat belt warning lamp lights up for six seconds each time the engine is started. It then goes out if the driver and the front passenger have already fastened their seat belts.

If the driver's seat belt is not fastened when the engine is started, an additional warning tone will sound. This warning tone stops after a maximum of six seconds or once the driver's seat belt is fastened.

If after six seconds, the driver or front passenger have not fastened their seat belts and the doors are closed:

- the  seat belt warning lamp remains lit as long as the driver's or front-passenger's seat belt is not fastened and
- if a vehicle speed of 15 mph (25 km/h) is exceeded, the  seat belt warning lamp begins to flash. A warning tone also sounds with increasing intensity for a maximum of

60 seconds or until the driver or front passenger have fastened their seat belts. If the driver/front passenger unfasten their seat belt while the vehicle is in motion, the  seat belt warning lamp lights up and a warning tone sounds again.

The warning tone ceases even if the driver or front-passenger seat belt has still not been fastened after 60 seconds. The  seat belt warning lamp stops flashing but remains illuminated.

After the vehicle comes to a standstill, the warning tone is reactivated and the  seat belt warning lamp flashes again if the vehicle speed again exceeds 15 mph (25 km/h).

The  seat belt warning lamp only goes out if:

- both the driver and the front passenger have fastened their seat belts.  
or
- the vehicle is stationary and a door is open.

**i** For more information on the  seat belt warning lamp, see "Warning and indicator lamps in the instrument cluster, seat belts" (> page 174).

### Emergency Tensioning Devices, seat belt force limiters

#### WARNING

Pyrotechnic Emergency Tensioning Devices that have been deployed are no longer operational and are unable to perform their intended protective function. This poses an increased risk of injury or even fatal injury.

Therefore, have pyrotechnic Emergency Tensioning Devices which have been triggered immediately replaced at a qualified specialist workshop.

**!** If the front-passenger seat is not occupied, do not engage the seat belt tongue in the buckle on the front-passenger seat. Otherwise, the Emergency

Tensioning Device could be triggered in the event of an accident.

**i** Vehicles with PRE-SAFE®: an electric motor is used by PRE-SAFE® to trigger the tightening of the seat belt in hazardous situations. This procedure is reversible.

The front seat belts and the outer seat belts in the rear are equipped with Emergency Tensioning Devices and seat belt force limiters.

The ETDs tighten the seat belts in an accident, pulling them close against the body.

The ETDs do not correct incorrect seat positions or incorrectly fastened seat belts.

The ETDs do not pull vehicle occupants back towards the backrest.

The ETDs can only be activated when:

- the ignition is switched on
- the restraint systems are operational; see "SRS warning lamp " (> page 47)
- the belt tongue is engaged in the buckle on each of the front seat belts

The ETDs on the outside seats in the rear compartment are triggered independently of the lock status of the seat belts.

The ETDs are triggered depending on the type and severity of an accident:

- in the event of a head-on or rear-end collision if the vehicle decelerates or accelerates rapidly in a longitudinal direction during the initial stages of the impact.
- in the event of a side impact if the vehicle decelerates or accelerates rapidly in a lateral direction on the side opposite to the impact.
- in certain situations where the vehicle rolls over if the system determines that it can provide additional protection.

If the ETDs are deployed, you will hear a bang, and a small amount of powder may also be released. Only in rare cases will the bang affect your hearing. The powder that is released generally does not constitute a

health hazard and does not indicate that there is a fire in the vehicle. The dust might cause some temporary breathing difficulty for people with asthma or other breathing trouble. To avoid this, you may wish to get out of the vehicle as soon as it is safe to do so. You can also open the window to allow fresh air to enter the vehicle interior. The  SRS warning lamp lights up.

If the seat belt is also equipped with a seat belt force limiter and this is triggered, the force exerted by the seat belt on the vehicle occupant is reduced.

The seat belt force limiters for the front seats are synchronized with the front air bags, which absorb part of the deceleration force. This results in the force exerted on the occupant being distributed over a greater area.

## Children in the vehicle

### Child restraint systems

#### Important safety notes

##### WARNING







According to accident statistics, children are safer when properly restrained in the rear seating positions than in the front seating position. Thus, we strongly recommend that children be placed in the rear seats whenever possible. Regardless of seating position, children 12 years old and under must be seated and properly secured in an appropriate infant restraint, toddler restraint, or booster seat recommended for the size and weight of the child.

The infant or child restraint must be properly secured with the vehicle's seat belt, the seat belt and top tether strap, or lower anchors and top tether strap, fully in accordance with the child seat manufacturer's instructions.

Occupants, especially children, should always sit as upright as possible, wear the seat belt properly and use an appropriately sized infant restraint, toddler restraint, or booster seat

recommended for the size and weight of the child.

Children can be killed or seriously injured by an inflating air bag. Note the following important information when circumstances require you to place a child in the front passenger seat:

- Your vehicle is equipped with air bag technology designed to deactivate the front passenger front air bag in your vehicle when the system senses the weight of a typical 12-month-old child or less along with the weight of a standard appropriate child restraint on the front passenger seat.
- For children larger than the typical 12-month-old child, the front passenger front air bag may or may not be activated. Always make sure the  indicator lamp is illuminated, indicating that the front passenger front air bag is deactivated.
- A child in a rear-facing child restraint on the front passenger seat will be seriously injured or even killed if the front passenger front air bag inflates in a collision which could occur under some circumstances, even with the air bag technology installed in your vehicle. The only means to completely eliminate this risk is to never place a child in a rear-facing child restraint in the front seat. We therefore strongly recommend that you always place a child in a rear-facing child restraint in a backseat.
- If you must install a rear-facing child restraint on the front passenger seat because circumstances require you to do so, make sure the  indicator lamp is illuminated, indicating that the front passenger front air bag is deactivated. Should the  indicator lamp not illuminate or go out while the restraint is installed, please check installation. Periodically check the  indicator lamp while driving to make sure the  indicator lamp is illuminated. If the  indicator lamp goes out or remains out, do not transport a child on the

front passenger seat until the system has been repaired.

A child in a rear-facing child restraint on the front passenger seat will be seriously injured or even killed if the front passenger front air bag inflates.

- If you have to place a child in a forward-facing child restraint on the front passenger seat, move the seat as far back as possible, use the proper child restraint recommended for the age, size and weight of the child, and secure child restraint with the vehicle's seat belt according to the child seat manufacturer's instructions.

#### **WARNING**

If the child restraint system is installed incorrectly on a suitable seat, it cannot protect as intended. The child cannot then be restrained in the event of an accident, heavy braking or sudden changes of direction. There is an increased risk of injury, possibly even fatal.

Make sure that you observe the child restraint system manufacturer's installation instructions and the notes on use. Please ensure, that the base of the child restraint system is always resting completely on the seat cushion. Never place objects, e.g. cushions, under or behind the child restraint system. Only use child restraint systems with the original cover designed for them. Only replace damaged covers with genuine covers.

#### **WARNING**

If the child restraint system is installed incorrectly or is not secured, it can come loose in the event of an accident, heavy braking or a sudden change in direction. The child restraint system could be thrown about, striking vehicle occupants. There is an increased risk of injury, possibly even fatal.

Always install child restraint systems properly, even if they are not being used. Make sure that you observe the child restraint

system manufacturer's installation instructions.

#### **WARNING**

Child restraint systems or their securing systems which have been damaged or subjected to a load in an accident can no longer protect as intended. The child cannot then be restrained in the event of an accident, heavy braking or sudden changes of direction. There is an increased risk of injury, possibly even fatal.

Replace child restraint systems which have been damaged or subjected to a load in an accident as soon as possible. Have the securing systems on the child restraint system checked at a qualified specialist workshop, before you install a child restraint system again.

#### **WARNING**

Infants and small children should never share a seat belt with another occupant. In the event of an accident, they could be crushed between the occupant and seat belt.

A child's risk of serious or fatal injuries is significantly increased if the child restraints are not properly secured in the vehicle and/or the child is not properly secured in the child restraint.

Children that are too large for a child restraint must travel in seats using normal seat belts. Position the shoulder belt across the chest and shoulder, not the face or neck. A booster seat may be necessary to achieve proper seat belt positioning for children over 41 lbs (18 kg) until they reach a height where a lap/shoulder belt fits properly without a booster seat.

When the child restraint is not in use, remove it from the vehicle or secure it with the seat belt to prevent the child restraint from becoming a projectile in the event of an accident.

 **WARNING**

If children are left unsupervised in the vehicle, they could:

- open the doors, thus endangering other people or road users.
- get out and disrupt traffic.
- operate the vehicle's equipment.

Additionally, children could set the vehicle in motion if, for example, they:

- release the parking brake.
- shifting the automatic transmission out of park position **P**
- Start the engine.

There is a risk of an accident and injury.

When leaving the vehicle, always take the SmartKey with you and lock the vehicle. Never leave children or animals unattended in the vehicle. Always keep the SmartKey out of reach of children.

 **WARNING**

If persons, particularly children are subjected to prolonged exposure to extreme heat or cold, there is a risk of injury, possibly even fatal. Never leave children unattended in the vehicle.

 **WARNING**

If the child restraint system is subjected to direct sunlight, parts may get very hot. Children may burn themselves on these parts, particularly on the metal parts of the child restraint system. There is a risk of injury.

If you leave the vehicle, taking the child with you, always ensure that the child restraint system is not exposed to direct sunlight. Protect it with a blanket, for example. If the child restraint system has been exposed to direct sunlight, let it cool down before securing the child in it. Never leave children unattended in the vehicle.

If an infant or child is traveling in the vehicle:

- Secure the child with a child or infant seat restraint system appropriate to the age and weight of the child.
- Make sure that the infant or child is properly secured at all times while the vehicle is in motion.

Mercedes-Benz recommends that you always properly secure all infants and children with a child or infant seat restraint system for the trip.

The use of seat belts and infant and child restraint systems is required by law in:

- all 50 states
- the U.S. territories
- the District of Columbia
- all Canadian provinces

Infants and children must always be seated in an appropriate infant or child restraint system recommended for the size and weight of the child. The infant or child restraint system must be properly secured in accordance with the manufacturer's instructions.

All infant or child restraint systems must meet the following standards:

- U.S. Federal Motor Vehicle Safety Standards 213 and 225
- Canadian Motor Vehicle Safety Standards 213 and 210.2

Confirmation that the child restraint system corresponds to the standards can be found on an instruction label on the child restraint system. This confirmation can also be found in the installation instructions that are included with the child restraint system.

Always read and follow the manufacturer's instructions when using an infant or child restraint system or booster seat.

Observe the warning labels in the vehicle interior or on the infant or child restraint.

### Special seat belt retractor

#### WARNING

If the seat belt is released while driving, the child restraint system will no longer be secured properly. The special seat belt retractor is disabled and the inertia reel draws in a portion of the seat belt. The seat belt cannot be immediately refastened. There is an increased risk of injury, possibly even fatal. Stop the vehicle immediately, paying attention to road and traffic conditions. Reactivate the special seat belt retractor and secure the child restraint system properly.

All seat belts except the driver's seat belt are equipped with a special seat belt retractor. When activated, the special seat belt retractor ensures that the seat belt will not slacken once the child restraint system has been secured.

Installing a child restraint system:

- ▶ Always comply with the manufacturer's installation instructions.
- ▶ Pull the seat belt smoothly from the seat belt retractor.
- ▶ Engage the seat belt tongue in the belt buckle.

Activating the special seat belt retractor:

- ▶ Pull the seat belt out fully and let the seat belt retractor retract it again. While the seat belt is retracting, you should hear a ratcheting sound. The special seat belt retractor is activated.
- ▶ Push down on the child restraint system to take up any slack.

Removing a child restraint system/  
deactivating the special seat belt retractor:

- ▶ Always comply with the manufacturer's installation instructions.
- ▶ Press the seat belt release button and guide the belt tongue to the belt outlet. The special seat belt retractor is deactivated.

For more information about releasing the seat belt with the release button, see "Releasing seat belts" (▷ page 64).

### LATCH-type (ISOFIX) child seat anchors in the rear

#### WARNING

LATCH-type (ISOFIX) child restraint systems do not offer sufficient protective effect for children whose weight is greater than 48 lbs (22 kg) who are secured using the safety belt integrated in the child restraint system. In the event of an accident, a child might not be restrained correctly. This poses an increased risk of injury or even fatal injury.

If the child weighs more than 48 lbs (22 kg), only use LATCH-type (ISOFIX) child restraint systems with which the child is also secured with the vehicle seat belt. Also secure the child restraint system with the Top Tether belt, if available.

When installing a child restraint system, be sure to observe the manufacturer's installation instructions and the instructions for correct use of the child restraint system.

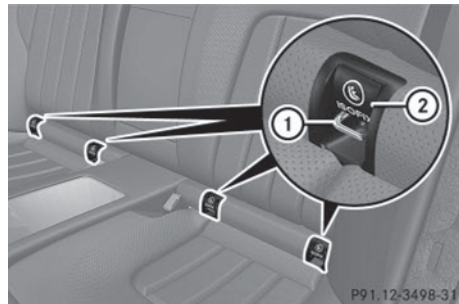

Securing ring

When installing the LATCH-type (ISOFIX) child restraint system, fold protective caps ② of securing rings ① inwards.

- ▶ Install the LATCH-type (ISOFIX) child restraint system on both LATCH-type (ISOFIX) securing rings ①. Comply with the child restraint system manufacturer's

instructions when installing the LATCH-type (ISOFIX) child restraint system.

LATCH-type (ISOFIX) is a standardized securing system for specially designed child restraint systems on the rear seats. The LATCH-type (ISOFIX) securing rings for two LATCH-type (ISOFIX) child restraint systems are installed on the left and right of the rear seats.

Non-LATCH-type (ISOFIX) child seats may also be used and can be installed using the vehicle's seat belt system. Install the child seat according to the manufacturer's instructions.

### Top Tether

#### Top Tether anchorages

##### WARNING

If the rear seat backrests are not locked, they could fold forwards in the event of an accident, heavy braking or sudden changes of direction. As a result, child restraint systems cannot perform their intended protective function. Rear seat backrests that are not locked can also cause additional injuries, e.g. in the event of an accident. This poses an increased risk of injury or even fatal injury. Always lock rear seat backrests after installing a Top Tether belt. Observe the lock verification indicator. Adjust the rear seat backrests so that they are positioned vertically.

Top Tether provides an additional connection between the LATCH-type (ISOFIX) child restraint system secured with LATCH-type (ISOFIX) and the rear seat. This helps reduce the risk of injury even further. If the child restraint system is equipped with Top Tether, this should always be used.

The Top Tether anchorage points are installed in the rear compartment behind the head restraints.

If the rear seat backrest is not engaged and locked, this will be shown in the multifunction

display in the instrument cluster. A warning tone also sounds.

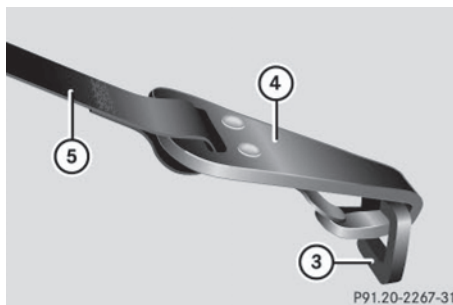
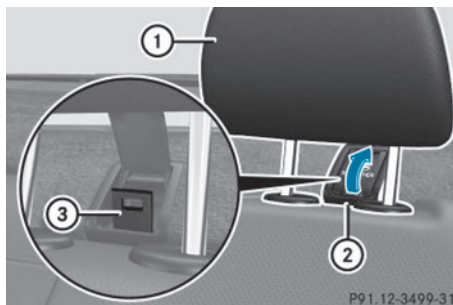

- ▶ Move head restraint ① upwards.
- ▶ Fold up cover ② of Top Tether anchorage ③.
- ▶ Route Top Tether belt ⑤ under head restraint ① between the two head restraint bars.
- ▶ Hook Top Tether hook ④ into Top Tether anchorage ③.
- ▶ Make sure that Top Tether belt ⑤ is not twisted.
- ▶ Fold down cover ② of Top Tether anchorage ③.
- ▶ Slide down head restraint ① until it engages (> page 102).  
Make sure that you do not interfere with the correct routing of Top Tether belt ⑤.
- ▶ Install the LATCH-type (ISOFIX) child restraint system with Top Tether. Always comply with the child restraint system manufacturer's installation instructions



when doing so. Make sure that Top Tether belt ⑤ is tight.

### Child-proof locks

#### Important safety notes

##### WARNING

If children are left unsupervised in the vehicle, they could:

- open the doors, thus endangering other people or road users.
- get out and disrupt traffic.
- operate the vehicle's equipment.

Additionally, children could set the vehicle in motion if, for example, they:

- release the parking brake.
- shifting the automatic transmission out of park position **P**
- Start the engine.

There is a risk of an accident and injury.

When leaving the vehicle, always take the SmartKey with you and lock the vehicle. Never leave children or animals unattended in the vehicle. Always keep the SmartKey out of reach of children.

##### WARNING

If persons, particularly children are subjected to prolonged exposure to extreme heat or cold, there is a risk of injury, possibly even fatal. Never leave children unattended in the vehicle.

##### WARNING

If children are traveling in the vehicle, they could:

- open doors, thus endangering other people or road users
- exit the vehicle and be caught by oncoming traffic
- operate vehicle equipment and become trapped

There is a risk of an accident and injury.

Always activate the child-proof locks and override feature if children are traveling in the vehicle. When leaving the vehicle, always take the key with you and lock the vehicle. Never leave children unattended in the vehicle.

You can activate the following child-proof locks:

- rear doors (▷ page 71)
- rear side windows (▷ page 72)

#### Child-proof locks for the rear doors

##### WARNING

Children could open a rear door from inside the vehicle. This could result in serious injuries or an accident. Therefore, when children ride in the rear always secure the rear doors with the child-proof locks.

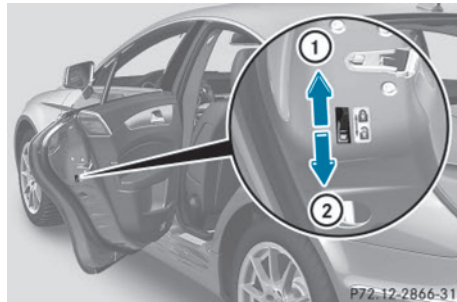

You secure each door individually with the child-proof locks on the rear doors. A door secured with a child-proof lock cannot be opened from inside the vehicle. When the vehicle is unlocked, the door can be opened from the outside.

- ▶ **To activate:** press the child-proof lock lever up in the direction of arrow ①.
- ▶ Make sure that the child-proof locks are working properly.
- ▶ **To deactivate:** press the child-proof lock lever down in the direction of arrow ②.

### Override feature for the rear side windows

#### WARNING

When children ride on the vehicle's rear seats, activate the override switch. Otherwise, the children could be injured, e.g. by trapping themselves in the rear side window.

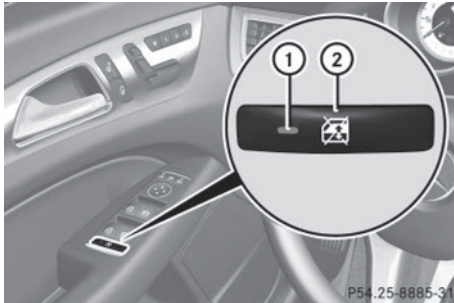

- ▶ **To activate/deactivate:** press button ②. If indicator lamp ① is lit, operation of the rear side windows is disabled. Operation is only possible using the switches in the driver's door. If indicator lamp ① is off, operation is possible using the switches in the rear compartment.

## Driving safety systems

### Overview of driving safety systems

In this section, you will find information about the following driving safety systems:

- **ABS (Anti-lock Braking System)** (▷ page 72)
- **BAS (Brake Assist System)** (▷ page 73)
- **BAS PLUS (Brake Assist System Plus)** (▷ page 73)
- **ESP® (Electronic Stability Program)** (▷ page 74)
- **EBD (Electronic Brake force Distribution)** (▷ page 78)
- **ADAPTIVE BRAKE** (▷ page 78)
- **PRE-SAFE® Brake** (▷ page 78)

### Important safety notes

If you fail to adapt your driving style or become distracted, the driving safety systems can neither reduce the risk of accident nor override the laws of physics. Driving safety systems are merely aids designed to assist driving. You are responsible for the distance to the vehicle in front, for vehicle speed and for braking in good time. Always adapt your driving style to suit the prevailing road, weather and traffic conditions and maintain a safe distance from the vehicle in front. Drive carefully.

- i** The driving safety systems described only work as effectively as possible when there is adequate contact between the tires and the road surface. Pay particular attention to the information regarding tires, recommended minimum tire tread depths etc. in the "Wheels and tires" section (▷ page 242).

In wintry driving conditions, always use winter tires (M+S tires) and if necessary, snow chains. Only in this way will the driving safety systems described in this section work as effectively as possible.

## ABS (Anti-lock Braking System)

### General information

ABS regulates brake pressure in such a way that the wheels do not lock when you brake. This allows you to continue steering the vehicle when braking.

The yellow  ABS warning lamp in the instrument cluster lights up when the ignition is switched on. It goes out when the engine is running.

### Important safety notes

- i** Observe the "Important safety notes" section (▷ page 72).

**⚠ WARNING**

If ABS is faulty, the wheels could lock when braking. The steerability and braking characteristics may be severely impaired. Additionally, further driving safety systems are deactivated. There is an increased danger of skidding and accidents.

Drive on carefully. Have ABS checked immediately at a qualified specialist workshop.

When ABS is malfunctioning, other systems, including driving safety systems, will also become inoperative. Observe the information on the ABS warning lamp (▷ page 177) and display messages which may be shown in the instrument cluster (▷ page 163).

ABS works from a speed of about 5 mph (8 km/h), regardless of road-surface conditions. ABS works on slippery surfaces, even if you only brake gently.

**Braking**

▶ **If ABS intervenes:** continue to depress the brake pedal vigorously until the braking situation is over.

▶ **To make a full brake application:** depress the brake pedal with full force.

If ABS intervenes when braking, you will feel a pulsing in the brake pedal.

The pulsating brake pedal can be an indication of hazardous road conditions, and functions as a reminder to take extra care while driving.

**BAS (Brake Assist System)****General information**

BAS operates in emergency braking situations. If you depress the brake pedal quickly, BAS automatically boosts the braking force, thus shortening the stopping distance.

**Important safety notes**

**i** Observe the "Important safety notes" section (▷ page 72).

**⚠ WARNING**

If BAS is malfunctioning, the braking distance in an emergency braking situation is increased. There is a risk of an accident.

In an emergency braking situation, depress the brake pedal with full force. ABS prevents the wheels from locking.

**Braking**

▶ Keep the brake pedal firmly depressed until the emergency braking situation is over. ABS prevents the wheels from locking.

The brakes will function as usual once you release the brake pedal. BAS is deactivated.

**BAS PLUS (Brake Assist System PLUS)****General information**

**i** Observe the "Important safety notes" section (▷ page 72).

BAS PLUS is only available in vehicles equipped with DISTRONIC PLUS.

For BAS PLUS to assist you when driving, the radar sensor system must be switched on and operational; see "Radar sensor system" in the index.

With the help of the radar sensor system, BAS PLUS can detect obstacles that are in the path of your vehicle for an extended period of time.

If the radar sensor system is malfunctioning, BAS PLUS will not be available. The brake system is still available with complete brake boosting effect and BAS.

### Important safety notes

#### WARNING

BAS PLUS cannot always clearly identify objects and complex traffic situations.

In such cases, BAS PLUS may:

- intervene unnecessarily
- not intervene

There is a risk of an accident.

Always pay careful attention to the traffic situation and be ready to brake. Terminate the intervention in a non-critical driving situation.

#### WARNING

BAS PLUS does not react:

- to people or animals
- to oncoming vehicles
- to crossing traffic
- when cornering

As a result, BAS PLUS may not intervene in all critical situations. There is a risk of an accident.

Always pay careful attention to the traffic situation and be ready to brake.

In the event of snowfall or heavy rain, the recognition can be impaired.

Recognition by the radar sensor system is also impaired in the event of:

- dirt on the sensors or anything else covering the sensors
- interference by other radar sources
- strong radar reflections, for example in parking garages
- a narrow vehicle traveling in front, e.g. a motorbike
- a vehicle traveling in front on a different line

Following damage to the front end of the vehicle, have the configuration and operation of the radar sensors checked at a qualified specialist workshop. This also applies to collisions at low speeds where there is no visible damage to the front of the vehicle.

### Function

To avoid a collision, BAS PLUS calculates the brake force necessary if:

- you approach an obstacle, and
- BAS PLUS has detected a risk of collision

**When driving at a speed under 20 mph (30 km/h):** if you depress the brake pedal, BAS PLUS is activated. The increase in brake pressure will be carried out at the last possible moment.

**When driving at a speed above 20 mph (30 km/h):** if you depress the brake pedal sharply, BAS PLUS automatically raises the brake pressure to a value adapted to the traffic situation.

BAS PLUS provides braking assistance in hazardous situations at speeds above 4 mph (7 km/h).

At speeds of up to approximately 40 mph (70 km/h), BAS PLUS can also react to stationary objects. Examples of stationary objects are stopped or parked vehicles.

 If BAS PLUS demands particularly high braking force, preventative passenger protection measures (PRE-SAFE®) are activated simultaneously.

- ▶ Keep the brake pedal depressed until the emergency braking situation is over. ABS prevents the wheels from locking.

BAS PLUS is deactivated and the brakes function as usual, if:

- you release the brake pedal.
- there is no longer a risk of collision.
- no obstacle is detected in front of your vehicle.

### ESP® (Electronic Stability Program)

#### General notes

-  Observe the "Important safety notes" section (▷ page 72).

ESP® monitors driving stability and traction, i.e. power transmission between the tires and the road surface.

If ESP® detects that the vehicle is deviating from the direction desired by the driver, one or more wheels are braked to stabilize the vehicle. The engine output is also modified to keep the vehicle on the desired course within physical limits. ESP® assists the driver when pulling away on wet or slippery roads. ESP® can also stabilize the vehicle during braking.

### ETS/4ETS (Electronic Traction System)

**i** Observe the "Important safety notes" section (▷ page 72).

ETS/4ETS traction control is part of ESP®. Traction control brakes the drive wheels individually if they spin. This enables you to pull away and accelerate on slippery surfaces, for example if the road surface is slippery on one side. In addition, more drive torque is transferred to the wheel or wheels with traction.

Traction control remains active, even if you deactivate ESP®.

### Important safety notes

**i** Observe the "Important safety notes" section (▷ page 72).

#### WARNING

If ESP® is malfunctioning, ESP® is unable to stabilize the vehicle. Additionally, further driving safety systems are deactivated. This increases the risk of skidding and an accident. Drive on carefully. Have ESP® checked at a qualified specialist workshop.



**!** Vehicles with 4MATIC: switch off the ignition when the parking brake is being tested on a brake dynamometer.

Application of the brakes by ESP® may otherwise destroy the brake system.

**!** Vehicles with 4MATIC: function or performance tests may only be carried out on a 2-axle dynamometer. Before you operate the vehicle on such a dynamometer, please consult a qualified workshop. You could otherwise damage the drive train or the brake system.

Vehicles without 4MATIC: observe the notes on ESP® (▷ page 238) when towing the vehicle with a raised rear axle.

ESP® is deactivated if the  warning lamp in the instrument cluster lights up continuously when the engine is running.

If the  warning lamp and the  warning lamp are lit continuously, ESP® is not available due to a malfunction.

Observe the information on warning lamps (▷ page 179) and display messages which may be shown in the instrument cluster (▷ page 163).

**i** Only use wheels with the recommended tire sizes. Only then will ESP® function properly.

### Characteristics of ESP®

#### General information

If the  ESP warning lamp goes out before beginning the journey, ESP® is automatically active.

If ESP® intervenes, the  ESP® warning lamp flashes in the instrument cluster.

If ESP® intervenes:

- ▶ Do not deactivate ESP® under any circumstances.
- ▶ Only depress the accelerator pedal as far as necessary when pulling away.
- ▶ Adapt your driving style to suit the prevailing road and weather conditions.

#### ECO start/stop function

The ECO start/stop function switches the engine off automatically when the vehicle stops moving. The engine starts

automatically when the driver wants to pull away again. ESP® remains in its previously selected status. **Example:** if ESP® was deactivated before the engine was switched off, ESP® remains deactivated when the engine is switched on again.

### Deactivating/activating ESP® (except AMG vehicles)

#### Important safety notes

- 📌 Observe the "Important safety notes" section (▷ page 72).

You can select between the following statuses of ESP:

- ESP® is activated.
- ESP® is deactivated.

#### WARNING

If you deactivate ESP®, ESP® no longer stabilizes the vehicle. There is an increased risk of skidding and an accident.

Only deactivate ESP® in the situations described in the following.

- ⚠️ Avoid spinning the driven wheels for an extended period with ESP® deactivated. You could otherwise damage the drivetrain.

It may be best to deactivate ESP® in the following situations:

- when using snow chains
- in deep snow
- on sand or gravel
- 📌 Activate ESP® as soon as the situations described above no longer apply. ESP® will otherwise not be able to stabilize the vehicle if the vehicle starts to skid or a wheel starts to spin.

#### Deactivating/activating ESP®

- ▶ **To deactivate:**(▷ page 161).  
The  ESP® OFF warning lamp in the instrument cluster lights up.

- ▶ **To activate:**(▷ page 161).

The  ESP® OFF warning lamp in the instrument cluster goes out.

#### Characteristics when ESP® is deactivated

If ESP® is deactivated and one or more wheels start to spin, the  ESP® warning lamp in the instrument cluster flashes. In such situations, ESP® will not stabilize the vehicle. If you deactivate ESP®:

- ESP® no longer improves driving stability.
- engine torque is no longer limited and the drive wheels are able to spin.  
The spinning of the wheels results in a cutting action for better traction on loose surfaces.
- traction control is still activated.
- ESP® still provides support when you brake.

### Deactivating/activating ESP® (AMG vehicles)

#### Important safety notes

- 📌 Observe the "Important safety notes" section (▷ page 72).

You can select between the following statuses of ESP:

- ESP® is activated.
- SPORT handling mode is activated.
- ESP® is deactivated.

#### WARNING

When SPORT handling mode is activated, there is a greater risk of skidding and accidents.

Only activate SPORT handling mode in the situations described in the following.

#### WARNING

If you deactivate ESP®, ESP® no longer stabilizes the vehicle. There is an increased risk of skidding and an accident.

Only deactivate ESP® in the situations described in the following.

- ❗ Avoid spinning the driven wheels for an extended period with ESP® deactivated. You could otherwise damage the drivetrain.

It may be best to activate SPORT handling mode in the following situations:

- when using snow chains
- in deep snow
- on sand or gravel
- on designated roads when the vehicle's own oversteering and understeering characteristics are desired

Driving in SPORT handling mode or without ESP® requires an extremely qualified and experienced driver.

- ❗ Activate ESP® as soon as the situations described above no longer apply. ESP® will otherwise not be able to stabilize the vehicle if the vehicle starts to skid or a wheel starts to spin.

### Deactivating/activating ESP®

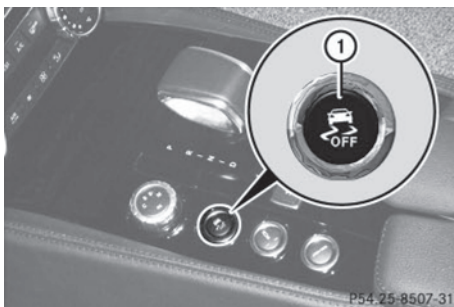

- ▶ **To activate SPORT handling mode:** briefly press button ①. The **SPORT** SPORT handling mode warning lamp in the instrument cluster lights up. The **SPORT handling mode** message appears in the multifunction display.
- ▶ **To deactivate SPORT handling mode:** briefly press button ①. The **SPORT** SPORT handling mode warning lamp in the instrument cluster goes out.

- ▶ **To deactivate ESP®:** press button ① until the **ESP OFF** ESP® OFF warning lamp lights up in the instrument cluster.

The **ESP OFF** message appears in the multifunction display.

- ▶ **To activate ESP®:** briefly press button ①.

The **ESP OFF** ESP® OFF warning lamp in the instrument cluster goes out. The **ESP ON** message appears in the multifunction display.

### Characteristics of activated SPORT handling mode

If SPORT handling mode is activated and one or more wheels start to spin, the **ESP** ESP® warning lamp in the instrument cluster flashes. ESP® only stabilizes the vehicle to a limited degree.

When SPORT handling mode is activated:

- ESP® only improves driving stability to a limited degree.
- traction control is still activated.
- engine torque is only restricted to a limited degree, and the drive wheels are able to spin.

The spinning of the wheels results in a cutting action for better traction on loose surfaces.

- ESP® still provides support when you brake.

### Characteristics when ESP® is deactivated

If ESP® is deactivated and one or more wheels start to spin, the **ESP** ESP® warning lamp in the instrument cluster does not flash. In such situations, ESP® will not stabilize the vehicle.

If you deactivate ESP®:

- ESP® no longer improves driving stability.
- engine torque is restricted to a limited degree and the drive wheels are able to spin.

The spinning of the wheels results in a cutting action for better traction on loose surfaces.

- traction control is still activated.
- PRE-SAFE® is no longer available, nor is it activated if you brake firmly and ESP® intervenes.
- PRE-SAFE® Brake is no longer available, it is also not activated if you brake firmly and ESP® intervenes.
- ESP® still provides support when you brake.

### EBD (electronic brake force distribution)

#### General information

EBD monitors and controls the brake pressure on the rear wheels to improve driving stability while braking.

#### Important safety notes

- i** Observe the "Important safety notes" section for driving safety systems (▷ page 72).

#### WARNING

If EBD has malfunctioned, the rear wheels can still lock, e.g. under full braking. This increases the risk of skidding and an accident. You should therefore adapt your driving style to the different handling characteristics. Have the brake system checked at a qualified specialist workshop.

Observe information regarding indicator and warning lamps (▷ page 177) as well as display messages (▷ page 166).

### ADAPTIVE BRAKE

ADAPTIVE BRAKE enhances braking safety and offers increased braking comfort. In addition to the braking function, ADAPTIVE BRAKE also has the HOLD function (▷ page 139) and hill start assist (▷ page 124).

### PRE-SAFE® Brake

#### General information

- i** Observe the "Important safety notes" section (▷ page 72).

PRE-SAFE® Brake is only available in vehicles with DISTRONIC PLUS.

For PRE-SAFE® Brake to assist you when driving, the radar sensor system must be switched on and operational; see "Radar sensor system" in the index.

With the help of the radar sensor system, PRE-SAFE® Brake can detect obstacles that are in front of your vehicle for an extended period of time.

PRE-SAFE® Brake can help you to minimize the risk of a collision with a vehicle ahead or reduce the effects of such a collision. If PRE-SAFE® Brake has detected a risk of collision, you will be warned visually and acoustically as well as by automatic braking. PRE-SAFE® Brake cannot prevent a collision without your intervention.

#### Important safety notes

#### WARNING

PRE-SAFE® Brake will initially brake your vehicle by a partial application of the brakes if a danger of collision is detected. There may be a collision unless you also brake. Automatic emergency braking cannot prevent a collision. There is a risk of an accident. Always apply the brakes yourself and try to take evasive action.

#### WARNING

PRE-SAFE® Brake cannot always clearly identify objects and complex traffic conditions.

In these cases, PRE-SAFE® Brake may:

- give an unnecessary warning and then brake the vehicle
- not give a warning or intervene



There is a risk of an accident.

Always pay particular attention to the traffic situation and be ready to brake, especially if PRE-SAFE® Brake warns you. Terminate the intervention in a non-critical driving situation.

In order to maintain the appropriate distance to the vehicle in front and thus prevent a collision, you must apply the brakes yourself.

### WARNING

PRE-SAFE® Brake does not react:

- to people or animals
- to oncoming vehicles
- to crossing traffic
- when cornering

As a result, PRE-SAFE® Brake may neither give warnings nor intervene in all critical situations. There is a risk of an accident.

Always pay careful attention to the traffic situation and be ready to brake.

In the event of snowfall or heavy rain, the recognition can be impaired.

Recognition by the radar sensor system is also impaired in the event of:

- dirt on the sensors or anything else covering the sensors
- interference by other radar sources
- strong radar reflections, for example in parking garages
- a narrow vehicle traveling in front, e.g. a motorbike
- a vehicle traveling in front on a different line relative to the center of your vehicle

Following damage to the front end of the vehicle, have the configuration and operation of the radar sensors checked at a qualified specialist workshop. This also applies to collisions at low speeds where there is no visible damage to the front of the vehicle.

## Function

► **To activate/deactivate:** activate or deactivate PRE-SAFE® Brake in the on-board computer (▷ page 161).

If the PRE-SAFE® Brake is not activated, the  symbol appears in the multifunction display.

Starting at a speed of around 4 mph (7 km/h), this function warns you if you rapidly approach a vehicle in front. An intermittent warning tone will then sound and the  distance warning lamp will light up in the instrument cluster.

► Brake immediately to defuse the situation.  
or

► Take evasive action provided it is safe to do so.

PRE-SAFE® Brake can also brake the vehicle automatically under the following conditions:

- the driver and front-passenger have their seat belts fastened  
and
- the vehicle speed is between approximately 4 mph (7 km/h) and 124 mph (200 km/h)

At speeds of up to approximately 40 mph (70 km/h) PRE-SAFE® Brake can also detect stationary objects. Examples of stationary objects are stopped or parked vehicles.

You can prevent the intervention of the PRE-SAFE® Brake at any time by:

- depressing the accelerator pedal further
- activating kickdown
- releasing the brake pedal

The braking action of PRE-SAFE® Brake is ended automatically if:

- you maneuver to avoid the obstacle.
- there is no longer any danger of a collision.
- there is no longer an obstacle detected in front of your vehicle.

If you approach an obstacle and PRE-SAFE® Brake detects a risk of a collision, the system

will alert you both visually and acoustically. If you do not brake or take evasive action, the system will warn you by automatically braking the vehicle gently. If there is an increased risk of collision, preventative passenger protection measures (PRE-SAFE®) are activated (▷ page 60). If a risk of collision remains at speeds of over 20 mph (30 km/h) and you do not brake, take evasive action or significantly accelerate, automatic braking may be performed up to and including emergency braking. Automatic emergency braking is not performed until immediately prior to an accident that can no longer be avoided.

## Theft deterrent locking system

### Immobilizer

The immobilizer prevents your vehicle from being started without the correct SmartKey.

- ▶ **To activate with the SmartKey:** remove the SmartKey from the ignition lock.
- ▶ **To activate with KEYLESS-GO:** switch the ignition off and open the driver's door.
- ▶ **To deactivate:** switch on the ignition.

When leaving the vehicle, always take the SmartKey with you and lock the vehicle. Anyone can start the engine if a valid SmartKey has been left inside the vehicle.

**i** The immobilizer is always deactivated when you start the engine.

In the event that the engine cannot be started when the starter battery is fully charged, the immobilizer may be faulty. Contact an authorized Mercedes-Benz Center or call 1-800-FOR-MERCEDES (in the USA) or 1-800-387-0100 (in Canada).

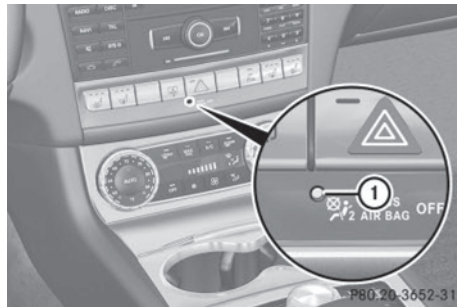

### ATA (anti-theft alarm system)



- ▶ **To arm:** lock the vehicle with the SmartKey or KEYLESS-GO. Indicator lamp ① flashes. The alarm system is armed after approximately 15 seconds.
- ▶ **To deactivate:** unlock the vehicle with the SmartKey or KEYLESS-GO.

A visual and audible alarm is triggered if the alarm system is armed and you open:

- a door
- the vehicle with the mechanical key
- the trunk lid
- the hood

- ▶ **To turn the alarm off with the SmartKey:** press the  or  button on the SmartKey. The alarm is switched off.

or

- ▶ Insert the SmartKey into the ignition lock. The alarm is switched off.

- ▶ **To stop the alarm using KEYLESS-GO:** grasp the outside door handle. The SmartKey must be outside the vehicle. The alarm is switched off.

or

- ▶ Press the Start/Stop button on the dashboard. The SmartKey must be inside the vehicle. The alarm is switched off.

The alarm is not switched off, even if you close the open door that triggered it, for example.

**i** If the alarm continues for more than 30 seconds, the mbrace emergency call system automatically notifies the Customer Assistance Center. This is done either by text message or data connection. The emergency call system sends the message or data provided that:

- you have subscribed to the mbrace service.
- the mbrace service has been activated properly.
- the necessary mobile phone network is available.



Useful information .....	84
SmartKey .....	84
Doors .....	89
Trunk .....	90
Side windows .....	94
Sliding sunroof .....	95

### Useful information

- i** This Operator's Manual describes all models and all standard and optional equipment of your vehicle available at the time of publication of the Operator's Manual. Country-specific differences are possible. Please note that your vehicle may not be equipped with all features described. This also applies to safety-related systems and functions.
- i** Read the information on qualified specialist workshops: (▷ page 32).

### SmartKey

#### Important safety notes

##### WARNING

If children are left unsupervised in the vehicle, they could:

- open the doors, thus endangering other people or road users.
  - get out and disrupt traffic.
  - operate the vehicle's equipment.
- Additionally, children could set the vehicle in motion if, for example, they:
- release the parking brake.
  - shift the automatic transmission out of park position P or shift manual transmission into neutral.
  - start the engine.

There is a risk of an accident and injury.

When leaving the vehicle, always take the SmartKey with you and lock the vehicle. Never leave children or animals unattended in the vehicle. Always keep the SmartKey out of reach of children.

##### WARNING

If children are left unsupervised in the vehicle, they could:

- open the doors, thus endangering other people or road users.
- get out and disrupt traffic.
- operate the vehicle's equipment.

Additionally, children could set the vehicle in motion if, for example, they:

- release the parking brake.
- shifting the automatic transmission out of park position **P**
- Start the engine.

There is a risk of an accident and injury.

When leaving the vehicle, always take the SmartKey with you and lock the vehicle. Never leave children or animals unattended in the vehicle. Always keep the SmartKey out of reach of children.

##### WARNING

If persons, particularly children are subjected to prolonged exposure to extreme heat or cold, there is a risk of injury, possibly even fatal. Never leave children unattended in the vehicle.

##### WARNING

If you attach heavy or large objects to the SmartKey, the SmartKey could be unintentionally turned in the ignition lock. This could cause the engine to be switched off. There is a risk of an accident.

Do not attach any heavy or large objects to the SmartKey. Remove any bulky key rings before inserting the SmartKey into the ignition lock.

- i** Keep the SmartKey away from strong magnetic fields. Otherwise, the remote control function could be affected. Strong magnetic fields can occur in the vicinity of powerful electrical installations.



Do not keep the SmartKey:

- with electronic devices, e.g. a mobile phone or another SmartKey
- with metallic objects, e.g. coins or metal foil
- inside metallic objects, e.g. a metal case  
This can affect the functionality of the SmartKey.

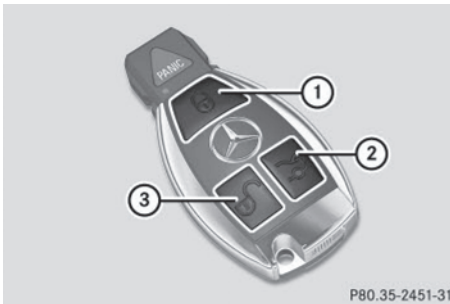
### SmartKey functions



P80.35-2451-31

- ①  To lock the vehicle
- ②  To unlock the trunk lid
- ③  To unlock the vehicle

► **To unlock centrally:** press the  button.

If you do not open the vehicle within approximately 40 seconds of unlocking:

- the vehicle is locked again.
- the theft deterrent locking system is armed again.

► **To lock centrally:** press the  button.

The SmartKey centrally locks/unlocks:

- the doors
- the trunk lid
- the fuel filler flap

The turn signals flash once when unlocking and three times when locking.

You can also set an audible signal to confirm that the vehicle has been locked. The audible signal can be activated and deactivated using the on-board computer (► page 161).

When it is dark, the surround lighting also comes on if it is activated in the on-board computer (► page 161).

### KEYLESS-GO

#### General notes

Bear in mind that the engine can be started by any of the vehicle occupants if there is a KEYLESS-GO key in the vehicle.

#### Locking/unlocking centrally

You can start, lock or unlock the vehicle using KEYLESS-GO. To do this, you only need carry the SmartKey with you. You can combine the functions of KEYLESS-GO with those of a conventional SmartKey. Unlock the vehicle by using KEYLESS-GO, for instance, and lock it using the  button on the SmartKey.

When locking or unlocking with KEYLESS-GO, the distance between the SmartKey and the corresponding door handle must not be greater than 3 ft (1 m).

A check which periodically establishes a radio connection between the vehicle and the SmartKey determines whether a valid SmartKey is in the vehicle. This occurs, for example:

- when the external door handles are touched
- when starting the engine
- while the vehicle is in motion

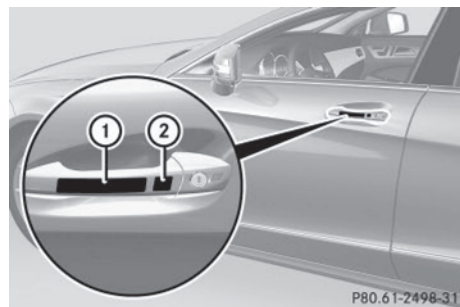

P80.61-2498-31

- ▶ **To unlock the vehicle:** touch the inner surface of the door handle.
- ▶ **To lock the vehicle:** touch sensor surface ①.
- ▶ **Convenience closing feature:** touch recessed sensor surface ② for an extended period.  
For further information on the convenience closing feature, see the Digital Operator's Manual, keyword "Convenience closing".
- ▶ **To unlock the trunk lid:** pull the handle on the trunk lid.  
The vehicle only unlocks the trunk lid.

### Changing the settings of the locking system

You can find information about this in the Digital Operator's Manual.



### Mechanical key

#### General notes

If the vehicle can no longer be locked or unlocked with the SmartKey, use the mechanical key.

If you use the mechanical key to unlock and open the driver's door or the trunk lid, the anti-theft alarm system will be triggered (▷ page 80).

There are several ways to turn off the alarm:

- ▶ **To turn the alarm off with the SmartKey:** press the  or  button on the SmartKey.

or

- ▶ Insert the SmartKey into the ignition lock.

or

- ▶ **To disarm the alarm with KEYLESS-GO:** press the Start/Stop button in the ignition lock. The SmartKey must be in the vehicle.

or

- ▶ Lock or unlock the vehicle using KEYLESS-GO. The SmartKey must be outside the vehicle.

If you unlock the vehicle using the mechanical key, the fuel filler flap will not be unlocked automatically.

- ▶ **To unlock the fuel filler flap:** insert the SmartKey into the ignition lock.

### Removing the mechanical key



- ▶ Push release catch ① in the direction of the arrow and at the same time remove mechanical key ② from the SmartKey.

For further information about:

- unlocking the driver's door (▷ page 90)
- unlocking the trunk (▷ page 93)
- locking the vehicle (▷ page 90)

### Inserting the mechanical key





- ▶ Push mechanical key ② completely into the SmartKey until it engages and release catch ① is back in its basic position.



## SmartKey battery

### Checking the battery



- ▶ Press the  or  button.  
The battery is working properly if battery check lamp ① lights up briefly.  
The battery is discharged if battery check lamp ① does not light up briefly.
- ▶ Change the battery (▶ page 87).
- i** If the SmartKey battery is checked within the signal reception range of the vehicle, pressing the  or  button:
  - locks or
  - unlocks the vehicle
- i** You can get a battery at any qualified specialist workshop.

### Replacing the battery

You require a CR 2025 3 V cell battery.

- ▶ Take the mechanical key out of the SmartKey (▶ page 86).

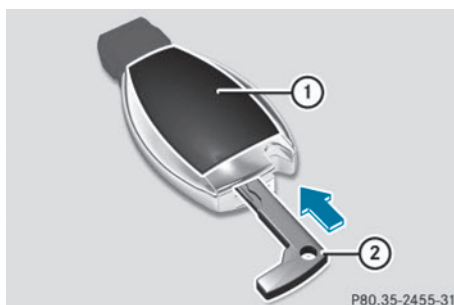

- ▶ Press mechanical key ② into the opening in the SmartKey in the direction of the arrow until battery compartment cover ① opens. Do not hold battery compartment cover ① closed while doing so.
- ▶ Remove battery compartment cover ①.

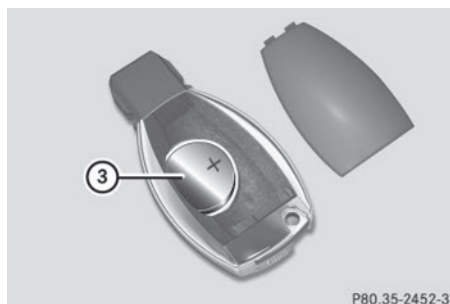

- ▶ Repeatedly tap the SmartKey against your palm until battery ③ falls out.
- ▶ Insert the new battery with the positive terminal facing upwards. Use a lint-free cloth to do so.
- ▶ Make sure that the surface of the battery is free of lint, grease and other contaminants.
- ▶ Insert the front tabs of battery compartment cover ① into the housing and then press to close it.
- ▶ Insert mechanical key ② into the SmartKey.
- ▶ Check the function of all SmartKey buttons on the vehicle.

### Problems with the SmartKey

Problem	Possible causes/consequences and ► Solutions
You can no longer lock or unlock the vehicle using the SmartKey.	<p>The SmartKey battery is discharged or nearly discharged.</p> <ul style="list-style-type: none"> <li>► Check the SmartKey battery (▷ page 87) and replace it if necessary (▷ page 87).</li> </ul> <p>If this does not work:</p> <ul style="list-style-type: none"> <li>► Lock (▷ page 90) or unlock (▷ page 90) the vehicle using the mechanical key.</li> </ul> <p>The SmartKey is faulty.</p> <ul style="list-style-type: none"> <li>► Lock (▷ page 90) or unlock (▷ page 90) the vehicle using the mechanical key.</li> <li>► Have the SmartKey checked at a qualified specialist workshop.</li> </ul>
You can no longer lock or unlock the vehicle using KEYLESS-GO.	<p>The SmartKey battery is discharged or nearly discharged.</p> <ul style="list-style-type: none"> <li>► Check the SmartKey battery (▷ page 87) and replace it if necessary (▷ page 87).</li> </ul> <p>If this does not work:</p> <ul style="list-style-type: none"> <li>► Lock (▷ page 90) or unlock (▷ page 90) the vehicle using the mechanical key.</li> </ul> <p>There is interference from a powerful source of radio waves.</p> <ul style="list-style-type: none"> <li>► Lock (▷ page 90) or unlock (▷ page 90) the vehicle using the mechanical key.</li> </ul> <p>KEYLESS-GO is malfunctioning.</p> <ul style="list-style-type: none"> <li>► Lock/unlock the vehicle using the remote control function of the SmartKey.</li> <li>► Have the vehicle and SmartKey checked at a qualified specialist workshop.</li> </ul> <p>If the vehicle can also not be locked/unlocked using the remote control function:</p> <ul style="list-style-type: none"> <li>► Lock (▷ page 90) or unlock (▷ page 90) the vehicle using the mechanical key.</li> <li>► Have the vehicle and SmartKey checked at a qualified specialist workshop.</li> </ul>
You have lost a SmartKey.	<ul style="list-style-type: none"> <li>► Have the SmartKey deactivated at a qualified specialist workshop.</li> <li>► Report the loss immediately to the vehicle insurers.</li> <li>► If necessary, have the locks changed as well.</li> </ul>

Problem	Possible causes/consequences and ► Solutions
You have lost the mechanical key.	<ul style="list-style-type: none"> <li>► Report the loss immediately to the vehicle insurers.</li> <li>► If necessary, have the locks changed as well.</li> </ul>
The engine cannot be started using the SmartKey.	<p>The on-board voltage is too low.</p> <ul style="list-style-type: none"> <li>► Switch off non-essential consumers, e.g. seat heating or interior lighting, and try to start the engine again.</li> </ul> <p>If this does not work:</p> <ul style="list-style-type: none"> <li>► Check the starter battery and charge it if necessary (&gt; page 232).</li> </ul> <p>or</p> <ul style="list-style-type: none"> <li>► Jump-start the vehicle (&gt; page 234).</li> </ul> <p>or</p> <ul style="list-style-type: none"> <li>► Consult a qualified specialist workshop.</li> </ul>
The engine cannot be started using KEYLESS-GO. The SmartKey is in the vehicle.	<p>The vehicle is locked.</p> <ul style="list-style-type: none"> <li>► Unlock the vehicle and try to start the vehicle again.</li> </ul> <p>There is interference from a powerful source of radio waves.</p> <ul style="list-style-type: none"> <li>► Start your vehicle with the SmartKey in the ignition lock.</li> </ul>

## Doors

### Important safety notes

#### WARNING

If children are left unsupervised in the vehicle, they could:

- open the doors, thus endangering other people or road users.
- get out and disrupt traffic.
- operate the vehicle's equipment.

Additionally, children could set the vehicle in motion if, for example, they:

- release the parking brake.
- shifting the automatic transmission out of park position **P**
- Start the engine.

There is a risk of an accident and injury.

When leaving the vehicle, always take the SmartKey with you and lock the vehicle. Never leave children or animals unattended in the

vehicle. Always keep the SmartKey out of reach of children.

#### WARNING

If persons, particularly children are subjected to prolonged exposure to extreme heat or cold, there is a risk of injury, possibly even fatal. Never leave children unattended in the vehicle.

You should preferably place luggage or loads in the cargo compartment. Observe the loading guidelines (> page 204).

### Information in the Digital Operator's Manual

In the Digital Operator's Manual you will find information on the following topics:

- Unlocking and opening doors from the inside
- Centrally locking and unlocking the vehicle from the inside
- Automatic locking feature
- Unlocking the driver's door (mechanical key)
- Locking the vehicle (mechanical key)

### Trunk

#### Important safety notes

##### WARNING

Combustion engines emit poisonous exhaust gases such as carbon monoxide. Exhaust gases can enter the vehicle interior if the trunk lid is open when the engine is running, especially if the vehicle is in motion. There is a risk of poisoning.

Always switch off the engine before opening the trunk lid. Never drive with the trunk lid open.

##### WARNING

If persons, particularly children are subjected to prolonged exposure to extreme heat or cold, there is a risk of injury, possibly even fatal. Never leave children unattended in the vehicle.

 The trunk lid swings upwards when opened. Therefore, make sure that there is sufficient clearance above the trunk lid.

 Opening dimensions of the trunk lid (> page 285).

You should preferably place luggage or loads in the cargo compartment. Observe the loading guidelines (> page 204).

Do not leave the SmartKey in the trunk. You could otherwise lock yourself out.

**Vehicles without trunk lid remote closing feature:** the trunk lid can be:

- opened and closed manually from outside
- opened automatically from outside
- opened automatically from inside
- locked separately
- unlocked with the mechanical key
- opened with the emergency release button

**Vehicles with trunk lid remote closing feature:** the trunk lid can be:

- opened and closed manually from outside
- opened and closed automatically from outside
- opened and closed automatically from inside
- locked separately
- unlocked with the mechanical key
- opened with the emergency release button

#### Trunk lid reversing feature

The trunk lid is equipped with an automatic reversing feature. It reacts if a solid object obstructs or restricts the trunk lid during the closing procedure. The trunk lid opens again automatically. The automatic reversing feature is only an aid and is not a substitute for your attentiveness to the trunk lid while it is closing.

##### WARNING

The reversing feature does not react:

- to soft, light and thin objects, e.g. small fingers
- over the last 1/3 in(8 mm) of the closing movement

This means that the reversing feature cannot prevent someone being trapped in these situations. There is a risk of injury.

Make sure that no body parts are in close proximity during the closing procedure.

If somebody becomes trapped:

- press the  button on the SmartKey, or
- press the remote operating switch on the driver's door, or
- press the closing or locking button on the trunk lid, or
- pull on the trunk lid handle

### Opening/closing from outside

#### Opening

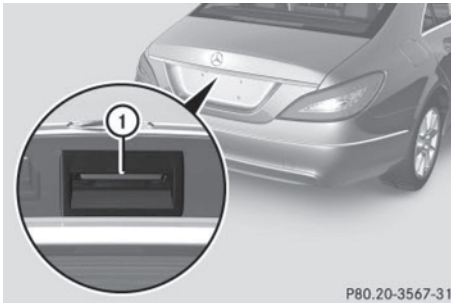

- ▶ Press the  button on the SmartKey.
- ▶ Pull handle ①.

#### Closing



- ▶ Pull the trunk lid down using recess ①.
- ▶ If necessary, lock the vehicle with the  button on the SmartKey (> page 85) or with KEYLESS-GO (> page 85).

- ⓘ If a KEYLESS-GO key is detected in the trunk, the trunk lid cannot be locked and will open again.

### Opening/closing automatically from outside

#### Important safety notes

##### WARNING

Combustion engines emit poisonous exhaust gases such as carbon monoxide. Exhaust gases can enter the vehicle interior if the trunk lid is open when the engine is running, especially if the vehicle is in motion. There is a risk of poisoning.

Always switch off the engine before opening the trunk lid. Never drive with the trunk lid open.

- ⚠ The trunk lid swings upwards when opened. Therefore, make sure that there is sufficient clearance above the trunk lid.

- ⓘ Opening dimensions of the trunk lid (> page 285).
- ⓘ The opening dimensions of the trunk lid can be found in the printed Operator's Manual.

#### Opening

You can open the trunk lid automatically using the SmartKey or the handle in the trunk lid.

- ▶ Press and hold the  button on the SmartKey until the trunk lid opens.
- or
- ▶ If the trunk is unlocked, pull the trunk lid handle and release it again immediately (> page 91).

## Closing

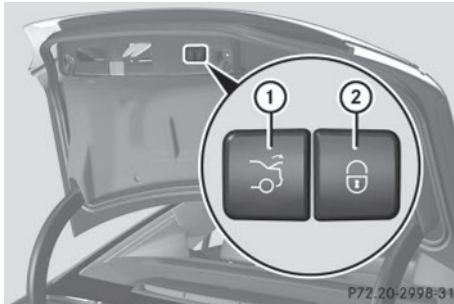

Example: closing and locking button (vehicle with the trunk lid remote closing feature and KEYLESS-GO)

► **To close:** press closing button ① in the trunk lid.

**Vehicles with trunk lid remote closing feature and KEYLESS-GO:** you can simultaneously close the trunk lid and lock the vehicle. The KEYLESS-GO key must be in the rear detection range of the vehicle.

► Press locking button ② in the trunk lid. If all the doors are closed, the vehicle locks.

**i** If KEYLESS-GO detects a SmartKey in the trunk, the trunk lid opens again after it is closed.

If KEYLESS-GO detects a second SmartKey outside the vehicle, the trunk lid remains closed.

### Opening/closing automatically from inside

#### Important safety notes

##### **⚠ WARNING**

Parts of the body could become trapped during automatic closing of the trunk lid. Moreover, people, e.g. children, may be standing in the closing area or may enter the closing area during the closing process. There is a risk of injury.

Make sure that nobody is in the vicinity of the closing area during the closing process.

Use one of the following options to stop the closing process:

- Press the  button on the key.
- press the remote operating switch on the driver's door.
- Press the closing or locking button on the trunk lid.
- Pull the trunk lid handle.

##### **⚠ WARNING**

The trunk lid can be automatically opened or closed even if the SmartKey is not in the vehicle. If children are left unsupervised in the vehicle, they could activate the functions. There is a risk of injury.

When leaving the vehicle, always take the SmartKey with you and lock the vehicle. Never leave children unsupervised in the vehicle.

##### **⚠ WARNING**

Combustion engines emit poisonous exhaust gases such as carbon monoxide. Exhaust gases can enter the vehicle interior if the trunk lid is open when the engine is running, especially if the vehicle is in motion. There is a risk of poisoning.

Always switch off the engine before opening the trunk lid. Never drive with the trunk lid open.

**i** Opening dimensions of the trunk lid (► page 285).

**i** The opening dimensions of the trunk lid can be found in the printed Operator's Manual.

## Opening and closing

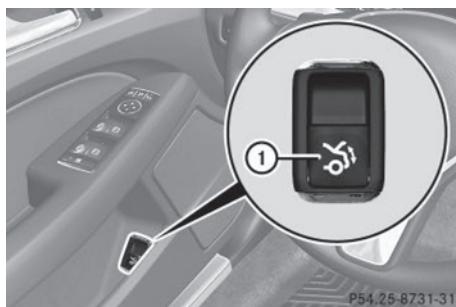

- ▶ **To open:** pull remote operating switch for trunk lid ① until the trunk lid opens.
- ▶ **To close:** press remote operating switch for trunk lid ① until the trunk lid is completely closed.

You can open the trunk lid from the driver's seat when the vehicle is stationary and unlocked.

### Unlocking the trunk (mechanical key)

**!** The trunk lid swings upwards when opened. Therefore, make sure that there is sufficient clearance above the trunk lid.

If the trunk cannot be unlocked with the SmartKey or KEYLESS-GO, use the mechanical key.

If you use the mechanical key to unlock and open the trunk lid, the anti-theft alarm system will be triggered (▷ page 80).

- ▶ Take the mechanical key out of the SmartKey (▷ page 86).
- ▶ Insert the mechanical key into the trunk lid lock as far as it will go.

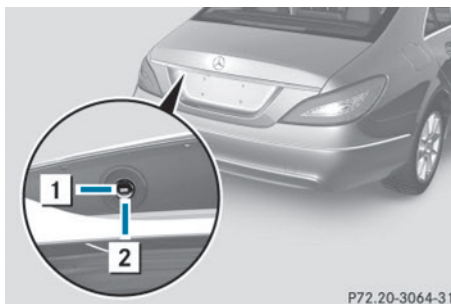

- ▶ Turn the mechanical key counter-clockwise from position ① as far as it will go to position ②.  
The trunk is unlocked.
- ▶ Turn the mechanical key back to position ① and remove it.
- ▶ Insert the mechanical key into the SmartKey.

**i** When you lock the vehicle (▷ page 90), the trunk is also locked.

### Trunk emergency release

You can open the trunk lid from inside the vehicle with the emergency release button.

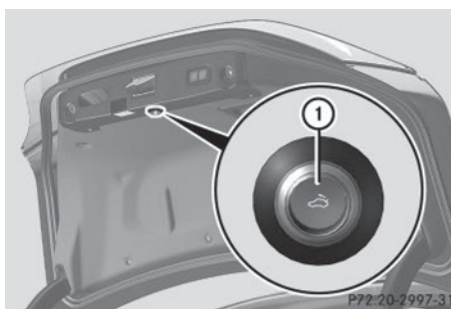

- ▶ Press emergency release button ① briefly.  
The trunk lid unlocks and opens.

The trunk lid can be unlocked and opened with the trunk lid emergency release when the vehicle is stationary or while driving.

The trunk lid emergency release does not open the trunk lid if the battery is disconnected or discharged.

Trunk lid emergency release light:

- emergency release button ① flashes for 30 minutes after the trunk lid is opened.
- emergency release button ① flashes for 60 minutes after the trunk lid is closed.

## Side windows

### Important safety notes

#### WARNING

While opening the side windows, body parts could become trapped between the side window and the door frame as the side window moves. There is a risk of injury.

Make sure that nobody touches the side window during the opening procedure. If somebody becomes trapped, release the switch or pull the switch to close the side window again.

#### WARNING

While opening the side windows, body parts in the closing area could become trapped. There is a risk of injury.

Make sure that no body parts are in close proximity during the closing procedure. If somebody becomes trapped, release the switch or press the switch to open the side window again.

#### WARNING

If children operate the side windows they could become trapped, particularly if they are left unsupervised. There is a risk of injury.

Activate the override feature for the rear side windows. When leaving the vehicle, always take the SmartKey with you and lock the vehicle. Never leave children unsupervised in the vehicle.

### Side window reversing feature

The side windows are equipped with an automatic reversing feature. If a solid object

blocks or restricts a side window during the closing process, the side window opens again automatically. However, the automatic reversing feature is only an aid and does not relieve you of the responsibility of paying attention when closing a side window.

#### WARNING

The reversing feature does not react:

- to soft, light and thin objects, e.g. small fingers
- over the last 1/6 in(4 mm) of the closing movement
- during resetting
- when closing the side window again manually immediately after automatic reversing

This means that the reversing feature cannot prevent someone being trapped in these situations. There is a risk of injury.

Make sure that no body parts are in close proximity during the closing procedure. If someone becomes trapped, press the switch to open the side window again.

### Information in the Digital Operator's Manual

In the Digital Operator's Manual you will find information on the following topics:

- Opening and closing the side windows
- Convenience opening
- Convenience closing
- Resetting the side windows



### Problems with the side windows

#### WARNING

If you close a side window again immediately after it has been blocked or reset, the side window closes with increased or maximum force. The reversing feature is then not active. Parts of the body could be trapped in the closing area in the process. This poses an increased risk of injury or even fatal injury.

Make sure that no parts of the body are in the closing area. To stop the closing process, release the switch or push the switch again to reopen the side window.

Problem	Possible causes/consequences and ► Solutions
A side window cannot be closed because it is blocked by objects, e.g. leaves in the window guide.	<ul style="list-style-type: none"> <li>► Remove the objects.</li> <li>► Close the side window.</li> </ul>
A side window cannot be closed and you cannot see the cause.	<p>If a side window is obstructed during closing and reopens again slightly:</p> <ul style="list-style-type: none"> <li>► Immediately after the window blocks, pull the corresponding switch again until the side window has closed. The side window is closed with increased force.</li> </ul> <p>If a side window is obstructed again during closing and reopens again slightly:</p> <ul style="list-style-type: none"> <li>► Immediately after the window blocks, pull the corresponding switch again until the side window has closed. The side window is closed without the anti-entrapment feature.</li> </ul>

### Sliding sunroof

#### Important safety notes

#### WARNING

While opening and closing the sliding sunroof, body parts in close proximity could become trapped. There is a risk of injury.

Make sure that no body parts are in close proximity during the opening and closing procedures.

If somebody becomes trapped:

- release the switch immediately, or
- during automatic operation, push the switch briefly in any direction

The opening or closing procedure will be stopped.

#### WARNING

If children operate the sliding sunroof they could become trapped, particularly if they are left unsupervised. There is a risk of injury.

When leaving the vehicle, always take the SmartKey with you and lock the vehicle. Never leave children unsupervised in the vehicle.

- ❗ Only open the sliding sunroof if it is free of snow and ice. Otherwise, malfunctions may occur.

Do not allow anything to protrude from the sliding sunroof. Otherwise, the seals could be damaged.

**!** The weather can change abruptly. It could start to rain or snow. Make sure that the sliding sunroof is closed when you leave the vehicle. The vehicle electronics can be damaged if water enters the vehicle interior.

**i** Resonance noises can occur in addition to the usual airflow noises when the sliding sunroof is open. They are caused by minor pressure fluctuations in the vehicle interior. Change the position of the sliding sunroof or open a side window slightly to reduce or eliminate these noises.

### Sliding sunroof reversing feature

The sliding sunroof is equipped with an automatic reversing feature. If a solid object blocks or restricts the sliding sunroof during the closing process, the sliding sunroof opens again automatically. However, the automatic reversing feature is only an aid and does not relieve you of the responsibility of paying attention when closing the sliding sunroof.

#### **⚠ WARNING**

The reversing feature does not react:

- to soft, light and thin objects, e.g. small fingers
- over the last 1/6 in (4 mm) of the closing movement
- during resetting
- when closing the sliding sunroof again manually immediately after automatic reversing

This means that the reversing feature cannot prevent someone being trapped in these situations. There is a risk of injury.

Make sure that no body parts are in close proximity during the closing procedure.

If somebody becomes trapped:

- release the switch immediately, or
- during automatic operation, push the switch briefly in any direction

The closing process is stopped.

### Operating the sliding sunroof

#### Opening and closing

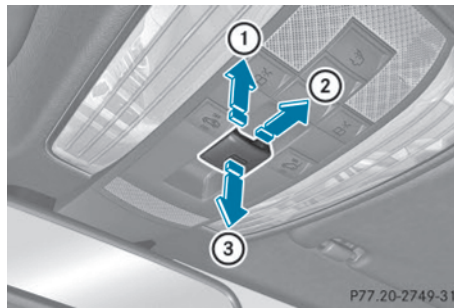

Overhead control panel

- ① To raise
- ② To open
- ③ To close/lower

► Turn the SmartKey to position **1** or **2** in the ignition lock.

► Press or pull the  switch in the corresponding direction.

**i** If you press the  switch beyond the point of resistance, an automatic opening/closing process is started in the corresponding direction. You can stop automatic operation by operating the switch again.

**i** The automatic opening and raising feature is available only when the sliding sunroof is closed.

The sun protection cover automatically opens along with the sliding sunroof. You can open or close the sun protection cover manually when the sliding sunroof is raised or closed.

**i** You can continue to operate the sliding sunroof after switching off the engine or

removing the SmartKey from the ignition lock. This function remains active for five minutes or until you open a front door.

### Resetting

---

**!** If the sliding sunroof still cannot be opened or closed fully after resetting, contact a qualified specialist workshop.

Reset the sliding sunroof if it does not move smoothly.

- ▶ Turn the SmartKey to position **2** in the ignition lock.
- ▶ Raise the sliding sunroof fully at the rear (▷ page 96).
- ▶ Keep the  switch pressed for another second.
- ▶ Make sure that the sliding sunroof can be fully opened and closed again (▷ page 96).
- ▶ If this is not the case, repeat the steps above again.

### Problems with the sliding sunroof

#### WARNING

If you close the sliding sunroof again immediately after it has been blocked or reset, the sliding sunroof closes with increased or maximum force. The reversing feature is then not active. Parts of the body could be trapped in the closing area in the process. This poses an increased risk of injury or even fatal injury.



Make sure that no parts of the body are in the closing area.

If somebody becomes trapped:

- release the switch immediately, or
- during automatic operation, push the switch briefly in any direction

The closing process is stopped.

**!** If the sliding sunroof still cannot be opened or closed as a result of a malfunction, contact a qualified specialist workshop.

Problem	Possible causes/consequences and ► Solutions
<p>The sliding sunroof cannot be closed and you cannot see the cause.</p>	<p>If the sliding sunroof is obstructed during closing and reopens again slightly:</p> <ul style="list-style-type: none"> <li>► Immediately after the sliding sunroof blocks, pull the  switch in the overhead control panel down to the point of resistance and hold it until the sliding sunroof is closed. The sliding sunroof is closed with increased force.</li> </ul> <p>If the sliding sunroof is obstructed again during closing and then reopens slightly:</p> <ul style="list-style-type: none"> <li>► Immediately after the sliding sunroof blocks, pull the  switch in the overhead control panel down to the point of resistance and hold it until the sliding sunroof is closed. The sliding sunroof is closed without the anti-entrapment feature.</li> </ul>

Useful information .....	100
Correct driver's seat position .....	100
Seats .....	101
Steering wheel .....	103
Mirrors .....	103
Memory function .....	103

## Useful information

- i** This Operator's Manual describes all models and all standard and optional equipment of your vehicle available at the time of publication of the Operator's Manual. Country-specific differences are possible. Please note that your vehicle may not be equipped with all features described. This also applies to safety-related systems and functions.
- i** Read the information on qualified specialist workshops: (▷ page 32).

## Correct driver's seat position

**⚠ WARNING**

You could lose control of your vehicle if you do the following while driving:

- adjust the driver's seat, head restraint, steering wheel or mirrors
- fasten the seat belt

There is a risk of an accident.

Adjust the driver's seat, head restraint, steering wheel and mirror and fasten your seat belt before starting the engine.



- ▶ Observe the safety guidelines on seat adjustment (▷ page 101).

- ▶ Make sure that seat ③ is adjusted properly.

Electrical seat adjustment (▷ page 102)

When adjusting the seat, make sure that:

- you are as far away from the driver's air bag as possible.
  - you are sitting in a normal upright position.
  - you can fasten the seat belt properly.
  - you have moved the backrest to an almost vertical position.
  - you have set the seat cushion angle so that your thighs are gently supported.
  - you can depress the pedals properly.
- ▶ Check whether the head restraint is adjusted properly.

When doing so, make sure that you have adjusted the head restraint so that the back of your head is supported at eye level by the center of the head restraint.

- ▶ Observe the safety guidelines on steering wheel adjustment (▷ page 103).
- ▶ Make sure that steering wheel ① is adjusted properly.

Adjusting the steering wheel electrically (▷ page 103)

When adjusting the steering wheel, make sure that:

- you can hold the steering wheel with your arms slightly bent.
  - you can move your legs freely.
  - you can see all the displays in the instrument cluster clearly.
- ▶ Observe the safety guidelines for seat belts (▷ page 61).
  - ▶ Check whether you have fastened seat belt ② properly (▷ page 62).

The seat belt should:

- fit snugly across your body
  - be routed across the middle of your shoulder
  - be routed in your pelvic area across the hip joints
- ▶ Before starting off, adjust the rear-view mirror and the exterior mirrors in such a way that you have a good view of road and traffic conditions (▷ page 103).
- ▶ **Vehicles with a memory function:** save the seat, steering wheel and exterior mirror settings with the memory function (▷ page 103).

## Seats

### Important safety notes

#### WARNING

Children could become trapped if they adjust the seats, particularly when unattended. There is a risk of injury.

When leaving the vehicle, always take the SmartKey with you and lock the vehicle. Never leave children unsupervised in the vehicle.

#### WARNING

You could lose control of your vehicle if you do the following while driving:

- adjust the driver's seat, head restraint, steering wheel or mirrors
- fasten the seat belt

There is a risk of an accident.

Adjust the driver's seat, head restraint, steering wheel and mirror and fasten your seat belt before starting the engine.

#### WARNING

If you adjust the seat height carelessly, you or other vehicle occupants could be trapped and thereby injured. Children in particular could accidentally press the electrical seat

adjustment buttons and become trapped. There is a risk of injury.

While moving the seats, make sure that your hands or other body parts do not get under the lever assembly of the seat adjustment system.

#### WARNING

When you adjust a seat, you or other vehicle occupants could become trapped, e.g. on the seat guide rail. There is a risk of injury.

Make sure when adjusting a seat that no one has any body parts in the sweep of the seat.

#### WARNING

If head restraints are not installed and adjusted correctly, they cannot provide protection as intended. There is an increased risk of injury in the head and neck area, e.g. in the event of an accident or when braking.

Always drive with the head restraints installed. Before driving off, make sure for every vehicle occupant that the center of the head restraint supports the back of the head at about eye level.

#### WARNING

The seat belt does not offer the intended level of protection if the backrest is not in the upright position. When braking or in the event of an accident, you could slide underneath the seat belt and sustain abdomen or neck injuries, for example. This poses an increased risk of injury or even fatal injury.

Adjust the seat properly before beginning your journey. Always make sure that the seat is in the upright position.

**!** To avoid damage to the seats and the seat heating, observe the following information:

- keep liquids from spilling on the seats. If liquid is spilled on the seats, dry them as soon as possible.
- if the seat covers are damp or wet, do not switch on the seat heating. The seat

heating should also not be used to dry the seats.

- clean the seat covers as recommended; see the "Interior care" section.
- do not transport heavy loads on the seats. Do not place sharp objects on the seat cushions, e.g. knives, nails or tools. The seats should only be occupied by passengers, if possible.
- when the seat heating is in operation, do not cover the seats with insulating materials, e.g. blankets, coats, bags, seat covers, child seats or booster seats.

**!** Make sure that there are no objects in the footwell or behind the seats when resetting the seats. There is a risk that the seats and/or the objects could be damaged.

**i** The head restraints in the front seats are installed with the NECK-PRO system (▷ page 59). For this reason, it is not possible to remove the head restraints from the front seats.

For more information, contact a qualified specialist workshop.

### Information in the Digital Operator's Manual

In the Digital Operator's Manual you will find information on the following topics:

- Adjusting the seats
- Adjusting the head restraints
- Adjusting the active multicontour seat
- Adjusting the 4-way lumbar support
- Switching the seat heating on/off
- Switching the seat ventilation on/off

### Switching the seat heating on/off

#### Activating/deactivating

#### WARNING

Repeatedly switching on the seat heating can cause the seat cushion and backrest pads to

become very hot. The health of persons with limited temperature sensitivity or a limited ability to react to excessively high temperatures may be affected or they may even suffer burn-like injuries. There is a risk of injury.

Therefore, do not switch the seat heating on repeatedly.

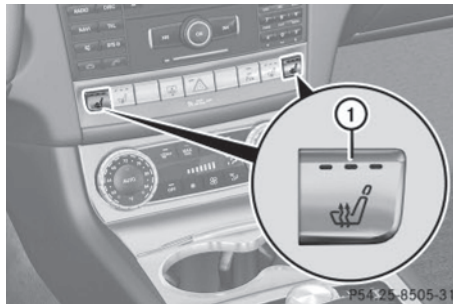

Driver's and front-passenger seat

The three red indicator lamps in the button indicate the heating level you have selected.

The system automatically switches down from level **3** to level **2** after approximately eight minutes.

The system automatically switches down from level **2** to level **1** after approximately ten minutes.

The system automatically switches off approximately 20 minutes after it is set to level **1**.

- ▶ Turn the SmartKey to position **1** or **2** in the ignition lock (▷ page 121).
- ▶ **To switch on:** press button **①** repeatedly until the desired heating level is set.
- ▶ **To switch off:** press button **①** repeatedly until all the indicator lamps go out.

**i** If the battery voltage is too low, the seat heating may switch off.

#### Problems with the seat heating

You can find information about this in the Digital Operator's Manual.



## Steering wheel

### Important safety notes

#### WARNING

You could lose control of your vehicle if you do the following while driving:

- adjust the driver's seat, head restraint, steering wheel or mirrors
- fasten the seat belt

There is a risk of an accident.

Adjust the driver's seat, head restraint, steering wheel and mirror and fasten your seat belt before starting the engine.

#### WARNING

Children could injure themselves if they adjust the steering wheel. There is a risk of injury.

When leaving the vehicle, always take the SmartKey with you and lock the vehicle. Never leave children unsupervised in the vehicle.

### Information in the Digital Operator's Manual

In the Digital Operator's Manual you will find information on the following topics:

- Adjusting the steering wheel
- Steering wheel heating
- EASY-ENTRY/EXIT feature

## Mirrors

In the Digital Operator's Manual you will find information on the following topics:

- Exterior mirrors
- Automatic anti-glare mirrors
- Parking position for the exterior mirror on the front-passenger side

## Memory function

In the Digital Operator's Manual you will find information on the following topics:

- Storing settings
- Calling up a stored setting



Useful information .....	106
Exterior lighting .....	106
Interior lighting .....	109
Replacing bulbs .....	109
Windshield wipers .....	111

### Useful information

- i** This Operator's Manual describes all models and all standard and optional equipment of your vehicle available at the time of publication of the Operator's Manual. Country-specific differences are possible. Please note that your vehicle may not be equipped with all features described. This also applies to safety-related systems and functions.
- i** Read the information on qualified specialist workshops: (> page 32).

### Exterior lighting

#### General notes

For reasons of safety, Mercedes-Benz recommends that you drive with the lights switched on even during the daytime. Therefore, your vehicle is equipped with special daytime running lamps. In some countries, operation of the headlamps varies due to legal requirements and self-imposed obligations.

If you wish to drive during the daytime without lights, switch off the daytime running lamps function in the on-board computer (> page 161).

#### Driving abroad

##### Symmetrical low-beam headlamps

Switch the headlamps to symmetrical low beam in countries in which traffic drives on the opposite side of the road from the country where the vehicle is registered. This prevents glare to oncoming traffic. When using symmetrical lights, the edge of the road is not lit as widely and as far ahead as normal.

Have the headlamps converted at a qualified specialist workshop as close to the border as possible before driving in these countries.

##### Asymmetrical low beam

Have the headlamps converted back to asymmetrical low-beam headlamps at a qualified specialist workshop as soon as possible after crossing the border again.

#### Information in the Digital Operator's Manual

In the Digital Operator's Manual you will find information on the following topics:

- Hazard warning lamps
- Headlamp cleaning system
- Headlamps fogged up on the inside

#### Setting the exterior lighting

##### Setting options

Exterior lighting can be set using:

- the light switch
- the combination switch (> page 107)
- the on-board computer (> page 161)

##### Light switch

##### Operation



- 1** Left-hand standing lamps
- 2** Right-hand standing lamps
- 3** Parking lamps, license plate and instrument cluster lighting

4 **AUTO** Automatic headlamp mode, controlled by the light sensor

5  Low-beam/high-beam headlamps

If you hear a warning tone when you leave the vehicle, the lights may still be switched on.

► Turn the light switch to **AUTO**.

The exterior lighting (except the parking/standing lamps) switches off automatically if you:

- remove the SmartKey from the ignition lock
- open the driver's door with the SmartKey in position **0**.

### Information in the Digital Operator's Manual

In the Digital Operator's Manual you will find information on the following topics:

- Automatic headlamp mode
- Daytime running lamps
- Low-beam headlamps
- Parking lamps
- Standing lamps

### Combination switch

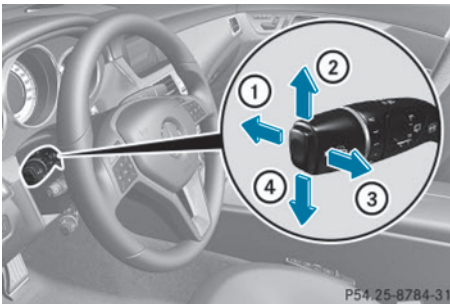

- ① High-beam headlamps
- ② Turn signal, right
- ③ High-beam flasher
- ④ Turn signal, left

In the Digital Operator's Manual you will find information on the following topics:

- turn signals
- high-beam headlamps
- high-beam flasher

### Headlamp cleaning system

The headlamps are cleaned automatically if the "Wipe with washer fluid" function is operated five times (► page 111) while the lights are on and the engine is running. When you switch off the ignition, the automatic headlamp cleaning system is reset and counting is resumed from 0.

### Cornering light function



The cornering light function improves the illumination of the road over a wide angle in the direction you are turning, enabling better visibility in tight bends, for example. It can only be activated when the low-beam headlamps are switched on.

#### Active:

- if you are driving at speeds below 25 mph (40 km/h) and switch on the turn signal or turn the steering wheel
- if you are driving at speeds between 25 mph (40 km/h) and 45 mph (70 km/h) and turn the steering wheel

**Not active:** if you are driving at speeds above 25 mph (40 km/h) or switch off the turn

signal or turn the steering wheel to the straight-ahead position.

The cornering lamp may remain lit for a short time, but is automatically switched off after no more than three minutes.

### Active light function

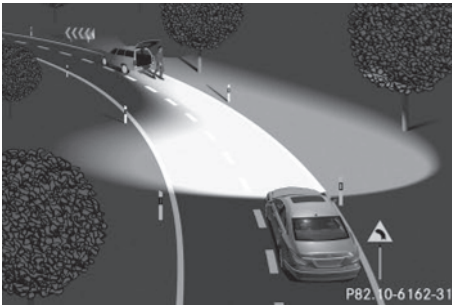

The active light function is a system that moves the headlamps according to the steering movements of the front wheels. In this way, relevant areas remain illuminated while driving. This allows you to identify pedestrians, cyclists and animals.

**Active:** when the lights are switched on.

### Adaptive Highbeam Assist

#### General notes



You can use this function to set the headlamps to change between low beam and high beam automatically. The system recognizes vehicles with their lights on, either approaching from the opposite direction or traveling in front of your vehicle, and consequently switches the headlamps from high beam to low beam.

The system automatically adapts the low-beam headlamp range depending on the distance to the other vehicle. Once the system no longer detects any other vehicles, it reactivates the high-beam headlamps.

The system's optical sensor is located behind the windshield near the overhead control panel.

### Important safety notes

#### WARNING

Adaptive Highbeam Assist does not recognize road users:

- who have no lights, e.g. pedestrians
- who have poor lighting, e.g. cyclists
- whose lighting is blocked, e.g. by a barrier

In very rare cases, Adaptive Highbeam Assist may fail to recognize other road users that have lights, or may recognize them too late. In this or similar situations, the automatic high-beam headlamps will not be deactivated or activated regardless. There is a risk of an accident.

Always carefully observe the traffic conditions and switch off the high-beam headlamps in good time.

Adaptive Highbeam Assist cannot take into account road, weather or traffic conditions. Adaptive Highbeam Assist is only an aid. You are responsible for adjusting the vehicle's lighting to the prevailing light, visibility and traffic conditions.

In particular, the detection of obstacles can be restricted if there is:

- poor visibility, e.g. due to fog, heavy rain or snow
- dirt on the sensors or the sensors are obscured

### Switching Adaptive Highbeam Assist on/off

► **To switch on:** turn the light switch to .

► Press the combination switch beyond the pressure point in the direction of arrow .

The  indicator lamp in the multifunction display lights up if it is dark and the light sensor activates the low-beam headlamps.



If you are driving at speeds above approximately 28 mph (45 km/h):

The headlamp range is set automatically depending on the distance between the vehicle and other road users.

If you are driving at speeds above approximately 35 mph (55 km/h) and no other road users have been detected:

The high-beam headlamps are switched on automatically. The  indicator lamp in the instrument cluster also lights up.

If you are driving at speeds below approximately 30 mph (45 km/h) or other road users have been detected or the roads are adequately lit:

The high-beam headlamps are switched off automatically. The  indicator lamp in the instrument cluster goes out. The  indicator lamp in the multifunction display remains lit.

► **To switch off:** move the combination switch back to its normal position or move the light switch to another position. The  indicator lamp in the instrument cluster goes out.

### Interior lighting

An overview of the interior lighting and the overhead control panel can be found in the "At a glance" section.

In the Digital Operator's Manual you will find information on the following topics:

- Automatic interior lighting control
- Manual interior lighting control
- Crash-responsive emergency lighting

### Replacing bulbs

#### Important safety notes

#### DANGER

Xenon bulbs carry a high voltage. You can get an electric shock if you remove the cover of the Xenon bulb and touch the electrical contacts. There is a risk of fatal injury.

Never touch the parts or the electrical contacts of the Xenon bulb. Always have work on the Xenon bulbs carried out at a qualified specialist workshop.

If your vehicle is equipped with Xenon bulbs, you can recognize this by the following: the cone of light from the Xenon bulbs moves from the top to the bottom and back again when you start the engine. For this to be observed, the lights must be switched on before starting the engine.

#### WARNING

Bulbs, lamps and connectors can get very hot when operating. If you change a bulb, you could burn yourself on these components. There is a risk of injury.

Allow these components to cool down before changing a bulb.

Do not use a bulb that has been dropped or if its glass tube has been scratched.

The bulb may explode if:

- you touch it
- it is hot

- you drop it
- you scratch it

Only operate bulbs in enclosed lamps designed for that purpose. Only install spare bulbs of the same type and the specified voltage.

Marks on the glass tube reduce the service life of the bulbs. Do not touch the glass tube with your bare hands. If necessary, clean the glass tube when cold with alcohol or spirit and rub it off with a lint-free cloth.

Protect bulbs from moisture during operation. Do not allow bulbs to come into contact with liquids.

You can replace neither Xenon bulbs nor LED bulbs. Have LED bulbs changed at a qualified specialist workshop.

Replace only the bulbs listed (▷ page 110). Have the bulbs that you cannot replace yourself changed at a qualified specialist workshop.

If you require assistance changing bulbs, consult a qualified specialist workshop.

If the new bulb still does not light up, consult a qualified specialist workshop.

Bulbs and lamps are an important aspect of vehicle safety. You must therefore make sure that these function correctly at all times. Have the headlamp setting checked regularly.

#### Overview: changing bulbs/bulb types

You can change the following bulbs. The bulb type can be found in the legend.

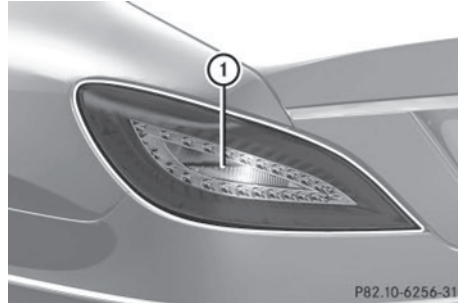

Tail lamp

- ① Backup lamp: W 16 W

#### Changing the rear bulbs

##### Backup lamp

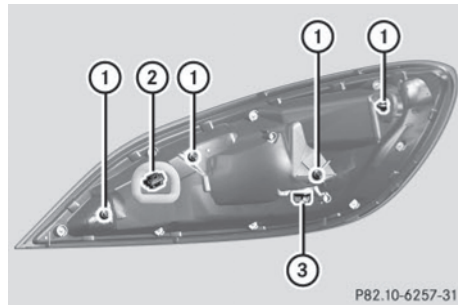

Lamp unit

- ▶ Switch off the lights.
- ▶ Open the trunk.
- ▶ Reach up into the side paneling and pull downwards until the lamp cluster is easily accessible.
- ▶ Press the detent of connector ② and pull out connector ②.
- ▶ Use a suitable tool to loosen and remove four nuts ①.
- ▶ Remove the entire lamp cluster.
- ▶ Turn bulb holder ③ counter-clockwise and pull it out.
- ▶ Pull out bulb.
- ▶ Insert the new bulb into bulb holder ③.



- ▶ Insert bulb holder ③ into the lamp and turn it clockwise.
- ▶ Re-insert the lamp cluster.
- ▶ Tighten four nuts ①.
- ▶ Push in connector ② until it engages.
- ▶ Insert the side paneling.

## Windshield wipers

### Switching the windshield wipers on/off

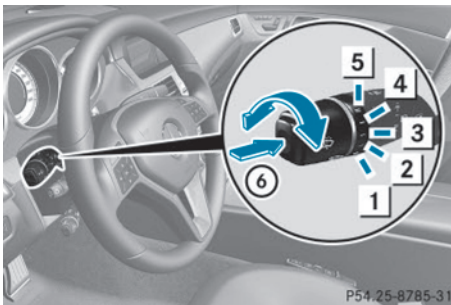

Combination switch

- 1 **0** Windshield wiper off
- 2 **•••** Intermittent wipe, low (rain sensor set to low sensitivity)
- 3 **••••** Intermittent wipe, high (rain sensor set to high sensitivity)
- 4 **—** Continuous wipe, slow
- 5 **==** Continuous wipe, fast
- 6 Single wipe/ To wipe the windshield using washer fluid

If the wiper blades are worn, the windshield will no longer be wiped properly. This could prevent you from observing the traffic conditions.

## Replacing the wiper blades

### Important safety notes

#### WARNING

If the windshield wipers begin to move while you are changing the wiper blades, you could be trapped by the wiper arm. There is a risk of injury.

Always switch off the windshield wipers and ignition before changing the wiper blades.

- !** To avoid damaging the wiper blades, make sure that you touch only the wiper arm of the wiper.
  - !** Never open the hood if a windshield wiper arm has been folded away from the windshield.
- Never fold a windshield wiper arm without a wiper blade back onto the windshield. Hold the windshield wiper arm firmly when you change the wiper blade. If you release the windshield wiper arm without a wiper blade and it falls onto the windshield, the windshield may be damaged by the force of the impact.
- Mercedes-Benz recommends that you have the wiper blades changed at a qualified specialist workshop.

Depending on the equipment level of your vehicle, there are two variants of wiper blade; these are installed and removed in different ways. Based on the diagrams, check which wiper blade is installed on your vehicle.

### Changing the wiper blades (version 1)

#### Removing the wiper blades

- ▶ Remove the SmartKey from the ignition lock or turn it to position **0** (KEYLESS-GO).
- ▶ Fold the wiper arm away from the windshield.
- ▶ Set the wiper blade at right angles to the wiper arm.

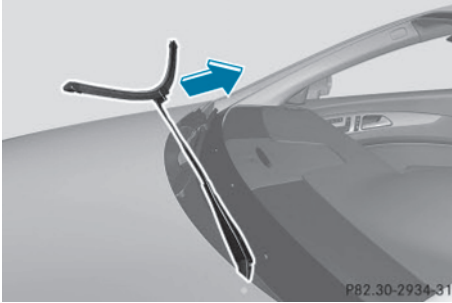

- ▶ Remove the wiper blade from the retaining pin on the wiper arm in the direction of the arrow.

#### Installing the wiper blades

- ▶ Push the new wiper blade onto the retaining pin on the wiper arm in the opposite direction to the arrow. Make sure that the wiper blade slides fully onto the retaining pin on the wiper arm.
- ▶ Turn the wiper blade parallel to the wiper arm.
- ▶ Fold the wiper arm back onto the windshield.

#### Changing the wiper blades (version 2)

##### Removing the wiper blades

- ▶ Remove the SmartKey from the ignition lock or turn it to position **0** (KEYLESS-GO).
- ▶ Fold the wiper arm away from the windshield.

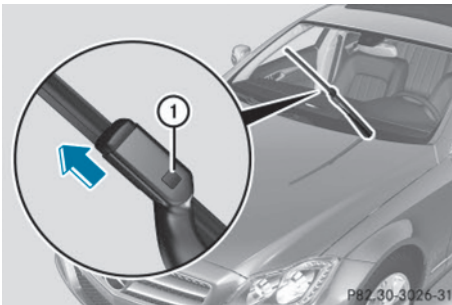

- ▶ Firmly press release knob ① and pull the wiper blade upwards from the wiper arm in the direction of the arrow.

#### Installing the wiper blades

- ▶ Position the new wiper blade in the retainer on the wiper arm and slide it into place in the opposite direction from the arrow. The wiper blade audibly engages.
- ▶ Make sure that the wiper blade is seated correctly.
- ▶ Fold the wiper arm back onto the windshield.

#### Problems with the windshield wipers

You can find information about this in the Digital Operator's Manual.

Useful information .....	114
Overview of climate control systems .....	114
Operating the climate control systems .....	118

### Useful information

- i** This Operator's Manual describes all models and all standard and optional equipment of your vehicle available at the time of publication of the Operator's Manual. Country-specific differences are possible. Please note that your vehicle may not be equipped with all features described. This also applies to safety-related systems and functions.
- i** Read the information on qualified specialist workshops: (> page 32).

the cooling process and the desired vehicle interior temperature will be reached more quickly.

- i** The integrated filter filters out most particles of dust and soot and completely filters out pollen. It also reduces gaseous pollutants and odors. A clogged filter reduces the amount of air supplied to the vehicle interior. For this reason, you should always observe the interval for replacing the filter, which is specified in the Maintenance Booklet. As it depends on environmental conditions, e.g. heavy air pollution, the interval may be shorter than stated in the Maintenance Booklet.

### Overview of climate control systems

#### Important safety notes

Observe the settings recommended on the following pages. The windows could otherwise fog up.

To prevent the windows from fogging up:

- switch off climate control only briefly
- switch on air-recirculation mode only briefly
- switch on the cooling with air dehumidification function
- switch on the defrost windshield function briefly, if required

Climate control regulates the temperature and the humidity in the vehicle interior and filters undesirable substances out of the air.

Climate control can only be operated when the engine is running. Optimum operation is only achieved with the side windows and roof closed.

The residual heat function can only be activated or deactivated if the ignition is switched off. See the Digital Operator's Manual, keyword "Residual heat".

- i** Ventilate the vehicle in briefly in warm weather conditions, e.g. with the "Convenience opening" function, see the Digital Operator's Manual, keyword "Convenience opening". This will speed up

## Control panel for dual-zone automatic climate control

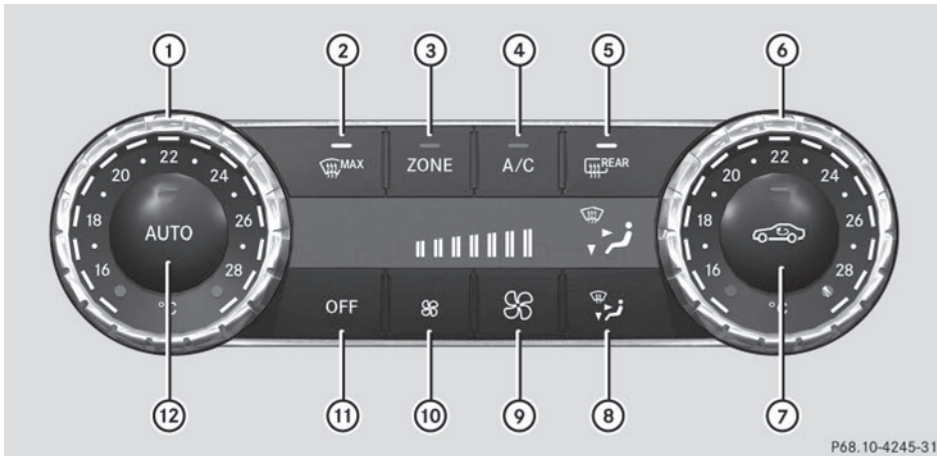

P68.10-4245-31

Canada only

- ① Sets the temperature, left
- ② Defrosts the windshield
- ③ Switches the ZONE function on/off
- ④ Switches cooling with air dehumidification on/off
- ⑤ Switches the rear window defroster on/off
- ⑥ Sets the temperature, right
- ⑦ Activates/deactivates air-recirculation mode
- ⑧ Sets the air distribution
- ⑨ Increases the airflow
- ⑩ Reduces the airflow
- ⑪ Switches climate control on/off
- ⑫ Sets climate control to automatic

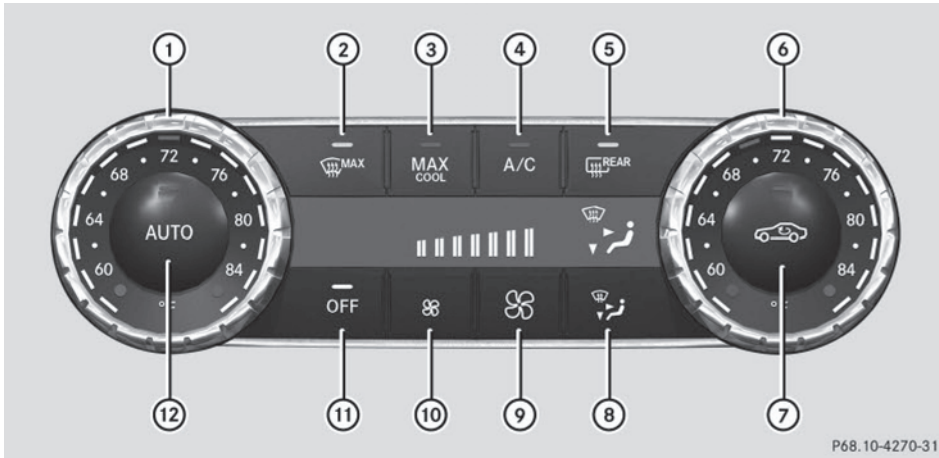

P68.10-4270-31

## Climate control

USA only

- ① Sets the temperature, left
- ② Defrosts the windshield
- ③ Switches maximum cooling on/off
- ④ Switches cooling with air dehumidification on/off
- ⑤ Switches the rear window defroster on/off
- ⑥ Sets the temperature, right
- ⑦ Activates/deactivates air-recirculation mode
- ⑧ Sets the air distribution
- ⑨ Increases the airflow
- ⑩ Reduces the airflow
- ⑪ Switches climate control on/off
- ⑫ Sets climate control to automatic

**Control panel for 3-zone automatic climate control**

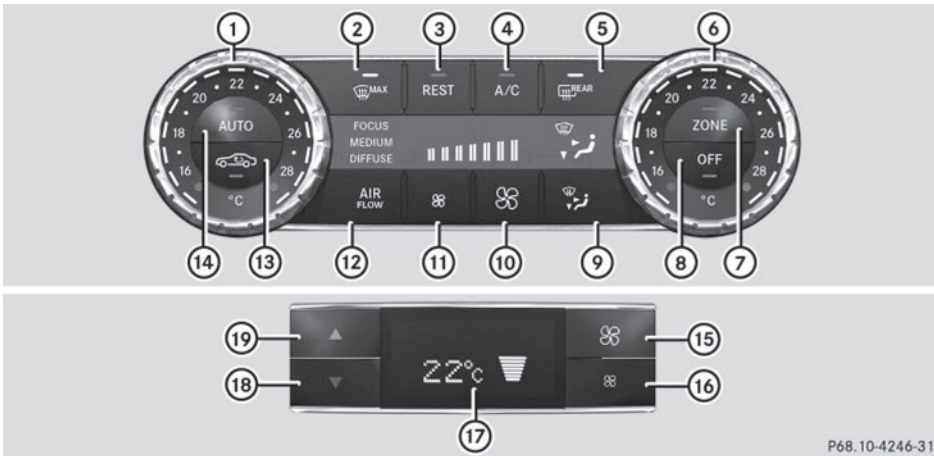

P68.10-4246-31

Canada only

**Front control panel**

- ① To set the temperature, left
- ② To defrost the windshield
- ③ To switch the residual heat function on/off
- ④ To switch cooling with air dehumidification on/off
- ⑤ To switch the rear window defroster on/off
- ⑥ To set the temperature, right
- ⑦ To switch the ZONE function on/off
- ⑧ To switch climate control on/off
- ⑨ To set the air distribution
- ⑩ To increase the airflow
- ⑪ To reduce the airflow
- ⑫ To adjust the climate mode settings
- ⑬ To activate/deactivate air-recirculation mode
- ⑭ To set climate control to automatic

**Rear control panel**

- ⑮ To increase the airflow
- ⑯ To reduce the airflow
- ⑰ Display
- ⑱ To reduce the temperature
- ⑲ To increase the temperature

### Operating the climate control systems

In the Digital Operator's Manual you will find information on the following topics:

- Switching climate control on/off
- Switching cooling with air dehumidification on/off
- Setting climate control to automatic
- Adjusting the climate mode settings
- Setting the temperature
- Setting the air distribution
- Setting the airflow
- Switching the ZONE function on/off
- Defrosting the windshield
- MAX COOL maximum cooling
- Defrosting the windows
- Switching the rear window defroster on/off
- Activating/deactivating air-recirculation mode
- Switching the residual heat function on/off
- Setting the air vents



Useful information .....	120
Notes on breaking-in a new vehicle	120
Driving .....	120
Automatic transmission .....	125
Refueling .....	127
Parking .....	130
Driving tips .....	131
Driving systems .....	131

### Useful information

- i** This Operator's Manual describes all models and all standard and optional equipment of your vehicle available at the time of publication of the Operator's Manual. Country-specific differences are possible. Please note that your vehicle may not be equipped with all features described. This also applies to safety-related systems and functions.
- i** Read the information on qualified specialist workshops: (> page 32).

### Notes on breaking-in a new vehicle

#### Important safety notes

New and replaced brake pads and discs only reach their optimum braking effect after several hundred kilometers of driving. Compensate for this by applying greater force to the brake pedal.

#### The first 1000 miles (1500 km)

The more you look after the engine when it is new, the more satisfied you will be with its performance in the future.

- You should therefore drive at varying vehicle and engine speeds for the first 1000 miles (1500 km).
- Avoid heavy loads, e.g. driving at full throttle, during this period.
- Change gear in good time, before the tachometer needle is  $\frac{2}{3}$  of the way to the red area of the tachometer.
- Do not manually shift to a lower gear to brake the vehicle.
- Try to avoid depressing the accelerator pedal beyond the point of resistance (kickdown).

After 1000 miles (1500 km), you can increase the engine speed gradually and accelerate the vehicle to full speed.

Additional breaking-in notes for AMG vehicles:

- Do not drive faster than 85 mph (140 km/h) for the first 1,000 miles (1,500 km).
- Only allow the engine to reach a maximum engine speed of 4,500 rpm briefly.
- Change gear in good time.
- i** You should also observe these notes on breaking in if the engine or parts of the drive train on your vehicle have been replaced.
- i** Always observe the respective speed limits.

#### AMG vehicles with self-locking rear axle differential

Your vehicle is equipped with a self-locking differential on the rear axle. To protect the differential on the rear axle, carry out an oil change after a breaking-in phase of 2,000 miles (3,000 km). This oil change prolongs the service life of the differential. Have the oil change carried out at a qualified specialist workshop.

### Driving

#### Important safety notes

##### WARNING

Objects in the driver's footwell can restrict the pedal travel or obstruct a depressed pedal. The operating and road safety of the vehicle is jeopardized. There is a risk of an accident. Make sure that all objects in the vehicle are stowed correctly, and that they cannot enter the driver's footwell. Install the floor mats securely and as specified in order to ensure sufficient clearance for the pedals. Do not use loose floor mats and do not place floor mats on top of one another.

**⚠ WARNING**

Unsuitable footwear can hinder correct usage of the pedals, e.g.:

- shoes with thick soles
- shoes with high heels
- slippers

There is a risk of an accident.

Wear suitable footwear to ensure correct usage of the pedals.

**⚠ WARNING**

If you switch off the ignition while driving, safety-relevant functions are only available with limitations, or not at all. This could affect, for example, the power steering and the brake boosting effect. You will require considerably more effort to steer and brake. There is a risk of an accident.

Do not switch off the ignition while driving.

**⚠ WARNING**

If the parking brake has not been fully released when driving, the parking brake can:

- overheat and cause a fire
- lose its hold function.

There is a risk of fire and an accident. Release the parking brake fully before driving off.

**!** Warm up the engine quickly. Do not use the engine's full performance until it has reached operating temperature.

Only shift the automatic transmission to the desired drive position when the vehicle is stationary.

Where possible, avoid spinning the drive wheels when pulling away on slippery roads. You could otherwise damage the drive train.

**!** **AMG vehicles:** at low engine oil temperatures below 68 °F (+20 °C), the maximum engine speed is restricted in order to protect the engine. To protect the engine and maintain smooth engine

operation, avoid driving at full throttle when the engine is cold.

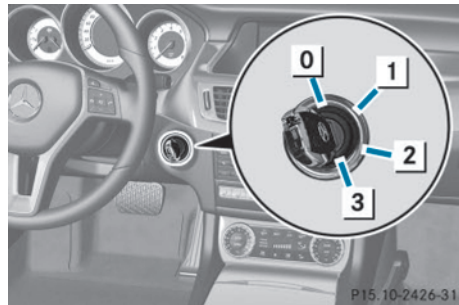
**Key positions****SmartKey**

- 0** To remove the SmartKey  
(shift the transmission to position **P**)
  - 1** Power supply for some consumers, such as the windshield wipers
  - 2** Ignition (power supply for all consumers) and drive position
  - 3** To start the engine
- i** The SmartKey can be turned in the ignition lock even if it is not the correct SmartKey for the vehicle. The ignition is not switched on. The engine cannot be started.

**KEYLESS-GO****General notes**

- Do not store the KEYLESS-GO key together with:
  - electronic devices, e.g. a mobile phone or another SmartKey
  - metallic objects, e.g. coins or metal film
- Do not keep the KEYLESS-GO key in metal objects, e.g. metal cases.  
This can affect the functionality of KEYLESS-GO.

Vehicles with KEYLESS-GO are equipped with SmartKeys featuring the integrated KEYLESS-GO function and a detachable Start/Stop button.

The Start/Stop button must be inserted in the ignition lock and the SmartKey must be in the vehicle.

Pressing the Start/Stop button several times in succession corresponds to the different key positions in the ignition lock. This is only the case if you are not depressing the brake pedal.

If you depress the brake pedal and press the Start/Stop button, the engine starts immediately.

The Start/Stop button can be removed from the ignition lock. Then, you can insert the SmartKey into the ignition lock.

**i** You do not have to remove the Start/Stop button from the ignition lock when you leave the vehicle. You should, however, always take the SmartKey with you when leaving the vehicle. As long as the SmartKey is in the vehicle:

- the vehicle can be started using the Start/Stop button and
- electrically powered equipment can be operated.

### Key positions with KEYLESS-GO



As soon as the ignition is switched on, all the indicator lamps in the instrument cluster light up. If an indicator lamp does not go out after starting the engine or lights up while driving, see (▷ page 174).

If Start/Stop button ① has not yet been pressed, this corresponds to the key being removed from the ignition.

▶ Insert Start/Stop button ① into ignition lock ②.

**i** When you insert Start/Stop button ① into ignition lock ②, the system needs approximately two seconds recognition time. You can then use Start/Stop button ①.

▶ **To switch on the power supply:** press Start/Stop button ① once.  
The power supply is switched on. You can now activate the windshield wipers, for example.

**i** If you then open the driver's door when in this position, the power supply is deactivated.

▶ **To switch on the ignition:** press Start/Stop button ① twice.  
The ignition is switched on.

**i** The ignition is switched off when:

- the driver's door is opened and
- you press Start/Stop button ① once when in this position.

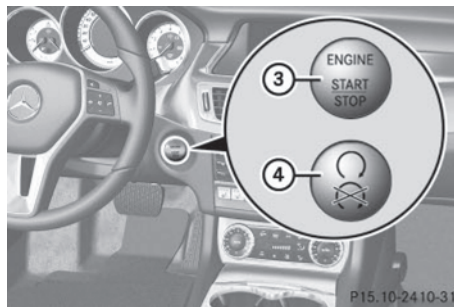

Start/Stop button

③ USA only

④ Canada only

## Starting the engine

### Important safety notes

#### WARNING

If children are left unsupervised in the vehicle, they could:

- open the doors, thus endangering other people or road users.
- get out and disrupt traffic.
- operate the vehicle's equipment.

Additionally, children could set the vehicle in motion if, for example, they:

- release the parking brake.
- shifting the automatic transmission out of park position **P**
- Start the engine.

There is a risk of an accident and injury.

When leaving the vehicle, always take the SmartKey with you and lock the vehicle. Never leave children or animals unattended in the vehicle. Always keep the SmartKey out of reach of children.

#### WARNING

Combustion engines emit poisonous exhaust gases such as carbon monoxide. Inhaling these exhaust gases leads to poisoning. There is a risk of fatal injury. Therefore never leave the engine running in enclosed spaces without sufficient ventilation.

#### WARNING

Flammable materials introduced through environmental influence or by animals can ignite if in contact with the exhaust system or parts of the engine that heat up. There is a risk of fire.

Carry out regular checks to make sure that there are no flammable foreign materials in the engine compartment or in the exhaust system.

-  Do not depress the accelerator pedal when starting the engine.

### General notes

-  The catalytic converter is preheated for up to 30 seconds after a cold start. The sound of the engine may change during this time.

### Automatic transmission

- ▶ Shift the transmission to position **P**. The transmission position display in the multifunction display shows **P**.
-  You can also start the engine when the transmission is in position **N**.

### Starting procedure with the SmartKey

-  To start the engine using the SmartKey instead of KEYLESS-GO, pull the Start/Stop button out of the ignition lock.
- ▶ Turn the SmartKey to position **3** in the ignition lock (▷ page 121) and release it as soon as the engine is running.

### Using KEYLESS-GO to start the engine

-  The Start/Stop button can be used to start the vehicle manually without inserting the SmartKey into the ignition lock. The Start/Stop button must be inserted in the ignition lock and the SmartKey must be in the vehicle. This mode for starting the engine operates independently of the ECO start/stop automatic engine start function.
- ▶ Depress the brake pedal and keep it depressed.
- ▶ Press the Start/Stop button once (▷ page 121). The engine starts.

### Pulling away

#### Automatic transmission

##### **WARNING**

If the engine speed is above the idling speed and you engage transmission position **D** or **R**, the vehicle could pull away suddenly. There is a risk of an accident.

When engaging transmission position **D** or **R**, always firmly depress the brake pedal and do not simultaneously accelerate.

**!** If a warning tone sounds and the **Release Park. Brake** message appears in the multifunction display, the parking brake is still applied. Release the parking brake.

- ▶ Depress the brake pedal and keep it depressed.
- ▶ Shift the transmission to position **D** or **R**.
- ▶ Release the parking brake, see the Digital Operator's Manual.
- ▶ Release the brake pedal.
- ▶ Carefully depress the accelerator pedal.

**i** It is only possible to shift the transmission from position **P** to the desired position if you depress the brake pedal. Only then is the parking lock released. If you do not depress the brake pedal, you can move the DIRECT SELECT lever but the parking lock remains engaged.

**i** The vehicle locks centrally once you have pulled away. The locking knobs in the doors drop down.

You can open the doors from the inside at any time.

You can also deactivate the automatic locking feature (> page 161).

**i** Upshifts take place at higher engine speeds after a cold start. This helps the catalytic converter to reach its operating temperature more quickly.

### Hill start assist

Hill start assist helps you when pulling away forwards or in reverse on an uphill gradient. It holds the vehicle for a short time after you have removed your foot from the brake pedal. This gives you enough time to move your foot from the brake pedal to the accelerator pedal and to depress it before the vehicle begins to roll.

##### **WARNING**

After a short time, hill start assist will no longer brake your vehicle and it could roll away. There is a risk of an accident and injury. Therefore, quickly move your foot from the brake pedal to the accelerator pedal. Never leave the vehicle when it is held by hill start assist.

- ▶ Take your foot off the brake pedal. The vehicle is then held for about a second.
- ▶ Pull away.

Hill start assist is not active if:

- you are pulling away on a level road or on a downhill gradient.
- the transmission is in position **N**.
- the parking brake is applied.
- ESP® is malfunctioning.

### ECO start/stop function

#### Introduction

The ECO start/stop function switches the engine off automatically if the vehicle is stopped under certain conditions.

The engine starts automatically when the driver wants to pull away again. The ECO start/stop function thereby helps you to reduce the fuel consumption and emissions of your vehicle.

## Important safety notes

### WARNING

If the engine is switched off automatically and you exit the vehicle, the engine is restarted automatically. The vehicle may begin moving. There is a risk of accident and injury.

If you wish to exit the vehicle, always turn off the ignition and secure the vehicle against rolling away.

## General notes



### ① ECO start/stop display

If the **ECO** symbol is shown in green in the multifunction display, the ECO start/stop function switches the engine off automatically if the vehicle stops moving. Every time you switch on the engine using the SmartKey or the Start/Stop button, the ECO start/stop function is activated.

If the ECO start/stop function has been manually deactivated (▷ page 125) or a malfunction has caused the system to be deactivated, the **ECO** symbol is not displayed.

**AMG vehicles:** the **Stop/Start active** or **Stop/Start inactive** message in the AMG menu in the multifunction display goes out.

**AMG vehicles:** the ECO start/stop function is only available in drive program **C**.

## Information in the Digital Operator's Manual

In the Digital Operator's Manual you will find information on the following topics:

- Automatic engine switch-off
- Automatic engine start
- Deactivating/activating the ECO start/stop function

## Problems with the engine

You can find information about this in the Digital Operator's Manual.

## Automatic transmission

### Selector lever

## Overview of transmission positions

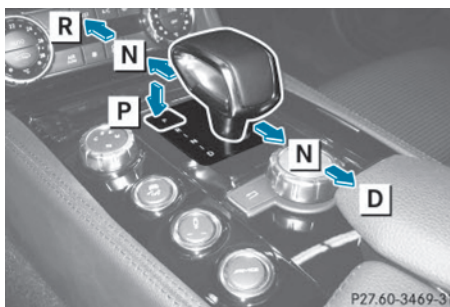

Selector lever in AMG vehicles with P button

- P** Park position with parking lock
- R** Reverse gear
- N** Neutral
- D** Drive

## Transmission position and drive program display

You can find information about this in the Digital Operator's Manual.

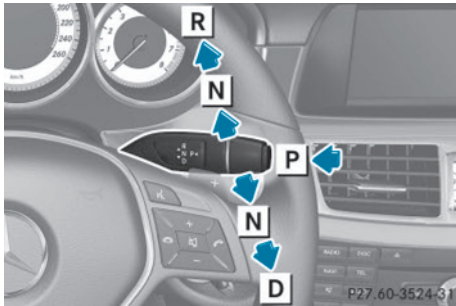
**DIRECT SELECT lever****Overview of transmission positions**

- P** Park position with parking lock
- R** Reverse gear
- N** Neutral
- D** Drive

The DIRECT SELECT lever is on the right of the steering column.

**i** The DIRECT SELECT lever always returns to its original position. The current transmission position **P**, **R**, **N** or **D** appears in the transmission position display in the multifunction display. You can find information about this in the Digital Operator's Manual.

In the Digital Operator's Manual you will find information on the following topics:

- Transmission position and drive program display
- Engaging park position **P**
- Engaging park position **P** in AMG vehicles
- Engaging reverse gear **R**
- Shifting to neutral **N**
- Engaging drive position **D**

**Information in the Digital Operator's Manual**

In the Digital Operator's Manual you will find information on the following topics:

- Important safety notes
- Transmission positions
- Changing gear
- Driving tips
- Program selector button
- Steering wheel paddle shifters
- Automatic drive program
- Problems with the transmission

**Manual drive program (AMG vehicles and vehicles with Sports package AMG)****General information**

In this drive program, you can permanently change gear yourself by using the steering wheel paddle shifters. The transmission must be in position **D**.

**i** As well as this permanent drive program **M**, you can also activate temporary drive program **M**, see the Digital Operator's Manual.

**Switching on the manual drive program**

- ▶ Turn the drive program selector (▷ page 126) until **M** appears in the multifunction display.  
The indicator **M** on the drive program selector lights up in red.

The manual drive program is only available for AMG vehicles.

Manual drive program **M** is different from drive programs **S** and **S+** with regard to spontaneity, responsiveness and smoothness of gear changes.

Manual drive program **M** can be selected using the drive program selector. In manual drive program **M**, you can change gear using



the steering wheel paddle shifters if the transmission is in position **D**. The gear currently selected and engaged is shown in the multifunction display.

### Shifting up (all vehicles except AMG vehicles)

- ▶ Pull the right-hand steering wheel paddle shifter. The automatic transmission shifts up to the next gear.

### Shifting up (AMG vehicles)

**I** In manual drive program **M**, the automatic transmission does not shift up automatically even when the engine limiting speed for the current gear is reached. When the engine limiting speed is reached, the fuel supply is cut to prevent the engine from overrevving. Always make sure that the engine speed does not reach the red area of the tachometer. There is otherwise a risk of engine damage.



- ① Gear indicator
- ② Upshift indicator

- ▶ If the color in the speedometer multifunction display changes to red and the **UP** display message is shown, shift up a gear.

### Shift recommendation



The gearshift recommendations assist you in adopting an economical driving style. The recommended gear is shown in the multifunction display.

- ▶ If relevant gearshift recommendation ① appears in the multifunction display on the instrument cluster, pull on the right-hand steering wheel paddle shifter; see the Digital Operator's Manual. The automatic transmission shifts to recommended gear ②.

### Information in the Digital Operator's Manual

In the Digital Operator's Manual you will find information on the following topics:

- Downshifting
- Kickdown
- Switching off the manual drive program

## Refueling

### Important safety notes

#### **⚠ WARNING**

Fuel is highly flammable. If you handle fuel incorrectly, there is a risk of fire and explosion.

You must avoid fire, open flames, creating sparks and smoking. Switch off the engine and, if applicable, the auxiliary heating before refueling.

#### **⚠ WARNING**

Fuel is poisonous and hazardous to health. There is a risk of injury.

You must make sure that fuel does not come into contact with your skin, eyes or clothing and that it is not swallowed. Do not inhale fuel vapors. Keep fuel away from children.

If you or others come into contact with fuel, observe the following:

- Wash away fuel from skin immediately using soap and water.
- If fuel comes into contact with your eyes, immediately rinse them thoroughly with clean water. Seek medical assistance without delay.
- If fuel is swallowed, seek medical assistance without delay. Do not induce vomiting.
- Immediately change out of clothing which has come into contact with fuel.

#### WARNING

Electrostatic buildup can create sparks and ignite fuel vapors. There is a risk of fire and explosion.

Always touch the vehicle body before opening the fuel filler flap or touching the fuel pump nozzle. Any existing electrostatic buildup is thereby discharged.

**!** Do not use diesel to refuel vehicles with a gasoline engine. Do not switch on the ignition if you accidentally refuel with the wrong fuel. Otherwise, the fuel will enter the fuel system. Even small amounts of the wrong fuel could result in damage to the fuel system and the engine. Notify a qualified specialist workshop and have the fuel tank and fuel lines drained completely.

**!** Overfilling the fuel tank could damage the fuel system.

**!** Take care not to spill any fuel on painted surfaces. You could otherwise damage the paintwork.

**!** Use a filter when refueling from a fuel can. Otherwise, the fuel lines and/or injection system could be blocked by particles from the fuel can.

Do not get into the vehicle again during the refueling process. Otherwise, electrostatic charge could build up again.

If you overfill the fuel tank, fuel could spray out when the fuel pump nozzle is removed.

For further information on fuel and fuel quality (> page 281).

## Refueling

### General information

Pay attention to the important safety notes (> page 127).

The fuel filler flap is unlocked or locked automatically when you open or close the vehicle with the SmartKey or with KEYLESS-GO.

The position of the fuel filler cap is shown in the instrument cluster . The arrow next to the filling pump indicates the side of the vehicle.

### Opening the fuel filler flap

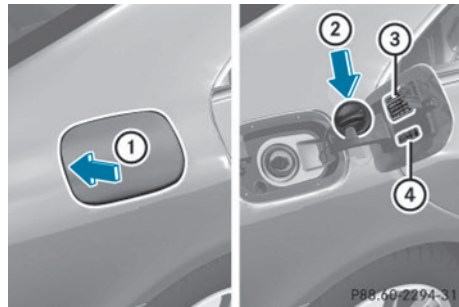

① To open the fuel filler flap

② To insert the fuel filler cap

③ Tire pressure table

④ Fuel type to be used

► Switch the engine off.



► Remove the SmartKey from the ignition lock.

► KEYLESS-GO: open the driver's door. This corresponds to key position **0**: "key removed".

The driver's door can be closed again.

- ▶ Press the fuel filler flap in the direction of arrow ①.  
The fuel filler flap opens slightly.
- ▶ Open the fuel filler flap fully.
- ▶ Turn the fuel filler flap counter-clockwise and remove it.
- ▶ Insert the fuel filler cap into the holder on the inside of filler flap ②.
- ▶ Completely insert the filler neck of the fuel pump nozzle into the tank, hook in place and refuel.
- ▶ Only fill the tank until the pump nozzle switches off.
- i** Do not add any more fuel after the pump stops filling for the first time. Otherwise, fuel may leak out.

### Closing the fuel filler flap

- ▶ Replace the cap on the filler neck and turn clockwise until it engages audibly.
- ▶ Close the fuel filler flap.
- i** Close the fuel filler flap before locking the vehicle. Otherwise, the locking pin of the central locking prevents the fuel filler flap from closing.
- i** If you are driving with the fuel filler cap open, the  reserve fuel warning lamp flashes. A message appears in the multifunction display (▷ page 163).  
In addition, the  Check Engine warning lamp may light up (▷ page 174).  
For further information on warning and indicator lamps in the instrument cluster, see (▷ page 174).

### Fuel filler flap emergency release

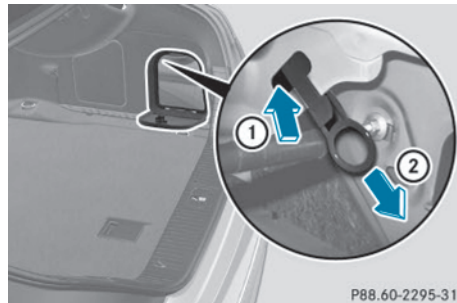

- ▶ open the trunk lid.
- ▶ Slide down the parcel net.
- ▶ Open the right-hand side trim panel.
- ▶ Detach the emergency release from retainer ①.
- ▶ Pull the emergency release in the direction of arrow ②.  
The fuel filler flap is unlocked.
- ▶ Open the fuel filler flap.

### Problems with fuel and the fuel tank

This section provides descriptions of and solutions to safety-relevant problems. Descriptions of and solutions to further problems can be found in the Digital Operator's Manual.

Problem	Possible causes/consequences and ► Solutions
Fuel is leaking from the vehicle.	<p>The fuel line or the fuel tank is faulty.</p> <p> <b>WARNING</b></p> <p>Risk of explosion or fire.</p> <ul style="list-style-type: none"> <li>► Turn the SmartKey to position <b>0</b> in the ignition lock and remove it immediately (&gt; page 121).</li> <li>► Do not restart the engine under any circumstances.</li> <li>► Consult a qualified specialist workshop.</li> </ul>

### Parking

#### Important safety notes

##### **WARNING**

Flammable material such as leaves, grass or twigs may ignite if they come into contact with hot parts of the exhaust system or exhaust gas flow. There is a risk of fire.

Park the vehicle so that no flammable materials come into contact with parts of the vehicle which are hot. Take particular care not to park on dry grassland or harvested grain fields.

##### **WARNING**

If you switch off the ignition while driving, safety-relevant functions are only available with limitations, or not at all. This could affect, for example, the power steering and the brake boosting effect. You will require considerably more effort to steer and brake. There is a risk of an accident.

Do not switch off the ignition while driving.

##### **WARNING**

If you leave children unsupervised in the vehicle, they could set it in motion by, for example:

- release the parking brake.
- shift the automatic transmission out of the parking position **P**.
- start the engine.

In addition, they may operate vehicle equipment and become trapped. There is a risk of an accident and injury.

When leaving the vehicle, always take the SmartKey with you and lock the vehicle. Never leave children unsupervised in the vehicle.

-  Always secure the vehicle correctly against rolling away. Otherwise, the vehicle or its drivetrain could be damaged.

To ensure that the vehicle is secured against rolling away unintentionally:

- the parking brake must be applied.
- the transmission must be in position **P** and the SmartKey must be removed from the ignition lock.
- the front wheels must be turned towards the curb on steep uphill or downhill gradients.

## Switching off the engine

### Important safety notes

#### WARNING

The automatic transmission switches to neutral position **N** when you switch off the engine. The vehicle may roll away. There is a risk of an accident.

After switching off the engine, always switch to parking position **P**. Prevent the parked vehicle from rolling away by applying the parking brake.

### Information in the Digital Operator's Manual

A description of how to switch off the engine on vehicles with automatic transmission can be found in the Digital Operator's Manual.

### Parking brake

You can find information about this in the Digital Operator's Manual.

### Parking the vehicle for a long period

You can find information about this in the Digital Operator's Manual.

### Driving tips

#### Information in the Digital Operator's Manual

In the Digital Operator's Manual you will find information on the following topics:

- General driving tips
- ECO display

- Braking:
  - Important safety notes
  - Downhill gradients
  - Heavy and light loads
  - Wet roads
  - Limited braking performance on salt-treated roads
  - Servicing the brakes
  - AMG high-performance and ceramic brakes
- Driving on wet roads
- Winter driving

### Driving systems

#### Cruise control

#### General notes

Cruise control maintains a constant road speed for you. It brakes automatically in order to avoid exceeding the set speed. On long and steep downhill gradients, especially if the vehicle is laden, you must shift to a lower gear in time. By doing so, you will make use of the braking effect of the engine. This relieves the load on the brake system and prevents the brakes from overheating and wearing too quickly.

Use cruise control only if road and traffic conditions make it appropriate to maintain a steady speed for a prolonged period. You can store any road speed above 20 mph (30 km/h).

#### Important safety notes

If you fail to adapt your driving style, cruise control can neither reduce the risk of an accident nor override the laws of physics. Cruise control cannot take into account the road, traffic and weather conditions. Cruise control is only an aid. You are responsible for the distance to the vehicle in front, for vehicle speed, for braking in good time and for staying in your lane.

Do not use cruise control:

- in road and traffic conditions which do not allow you to maintain a constant speed e.g. in heavy traffic or on winding roads
- on slippery road surfaces. Braking or accelerating could cause the drive wheels to lose traction and the vehicle could then skid
- when there is poor visibility, e.g. due to fog, heavy rain or snow

If there is a change of drivers, advise the new driver of the speed stored.

#### WARNING

If you call up the stored speed and it differs from the current speed, the vehicle accelerates or decelerates. If you do not know the stored speed, the vehicle could accelerate or brake unexpectedly. There is a risk of an accident.

Pay attention to the road and traffic conditions before calling up the stored speed. If you do not know the stored speed, store the desired speed again.

### Cruise control lever

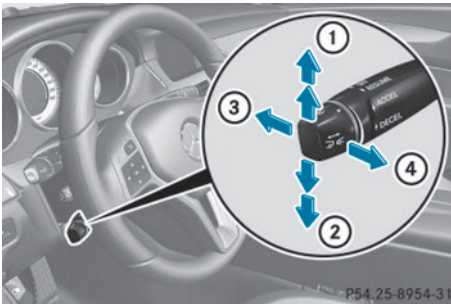

- ① To activate or increase speed
- ② To activate or reduce speed
- ③ To deactivate cruise control
- ④ To activate at the current speed/last stored speed

When you activate cruise control, the stored speed is shown in the multifunction display for five seconds.

### Information in the Digital Operator's Manual

In the Digital Operator's Manual you will find information on the following topics:

- Activation conditions
- Storing, maintaining and calling up a speed
- Setting a speed
- Deactivating cruise control

### DISTRONIC PLUS

#### General notes

DISTRONIC PLUS regulates the speed and automatically helps you maintain the distance to the vehicle detected in front. Vehicles are detected with the aid of the radar sensor system. DISTRONIC PLUS brakes automatically so that the set speed is not exceeded.

Change into a lower gear in good time on long and steep downhill gradients. This is especially important if the vehicle is laden. By doing so, you will make use of the braking effect of the engine. This relieves the load on the brake system and prevents the brakes from overheating and wearing too quickly.

If DISTRONIC PLUS detects that there is a risk of a collision, you will be warned visually and acoustically. DISTRONIC PLUS cannot prevent a collision without your intervention. An intermittent warning tone will then sound and the distance warning lamp will light up in the instrument cluster. Brake immediately in order to increase the distance to the vehicle in front or take evasive action provided it is safe to do so.

For DISTRONIC PLUS to assist you when driving, the radar sensor system must be switched on and operational; see "Radar sensor system" in the index.

If there is no vehicle in front, DISTRONIC PLUS operates in the same way as cruise control in the speed range between 20 mph (Canada: 30 km/h) and 120 mph (Canada:

200 km/h). If a vehicle is driving in front of you, it operates in the speed range between 0 mph (0 km/h) and 120 mph (Canada: 200 km/h).

Do not use DISTRONIC PLUS while driving on roads with steep gradients.

As DISTRONIC PLUS transmits radar waves, it can resemble the radar detectors of the responsible authorities. You can refer to the relevant chapter in the Operator's Manual if questions are asked about this.

**i** USA only: This device has been approved by the FCC as a "Vehicular Radar System". The radar sensor is intended for use in an automotive radar system only. Removal, tampering, or altering of the device will void any warranties, and is not permitted by the FCC. Do not tamper with, alter, or use in any non-approved way.

Any unauthorized modification to this device could void the user's authority to operate the equipment.

**i** Canada only: This device complies with RSS-210 of Industry Canada. Operation is subject to the following two conditions:

1. This device may not cause harmful interference, and
2. this device must accept any interference received, including interference that may cause undesired operation of the device.

Removal, tampering, or altering of the device will void any warranties, and is not permitted. Do not tamper with, alter, or use in any non-approved way.

Any unauthorized modification to this device could void the user's authority to operate the equipment.

## Important safety notes

### WARNING

DISTRONIC PLUS does not react to:

- people or animals
- stationary obstacles on the road, e.g. stopped or parked vehicles
- oncoming and crossing traffic

As a result, DISTRONIC PLUS may neither give warnings nor intervene in such situations. There is a risk of an accident.

Always pay careful attention to the traffic situation and be ready to brake.

### WARNING

DISTRONIC PLUS cannot always clearly identify other road users and complex traffic situations.

In such cases, DISTRONIC PLUS may:

- give an unnecessary warning and then brake the vehicle
- neither give a warning nor intervene
- accelerate unexpectedly

There is a risk of an accident.

Continue to drive carefully and be ready to brake, in particular when warned to do so by DISTRONIC PLUS.

### WARNING

DISTRONIC PLUS brakes your vehicle with up to 40% of the maximum braking force. If this braking force is insufficient, DISTRONIC PLUS warns you visually and audibly. There is a risk of an accident.

In such cases, apply the brakes yourself and try to take evasive action.

**!** If DISTRONIC PLUS or the HOLD function is activated, the vehicle brakes automatically in certain situations. To prevent damage to the vehicle, deactivate DISTRONIC PLUS and the HOLD function in the following or other similar situations:

- when towing the vehicle
- in the car wash

If you fail to adapt your driving style, DISTRONIC PLUS can neither reduce the risk of accident nor override the laws of physics. DISTRONIC PLUS cannot take into account the road, traffic and weather conditions. DISTRONIC PLUS is only an aid. You are responsible for the distance to the vehicle in front, for vehicle speed, for braking in good time and for staying in your lane.

Do not use DISTRONIC PLUS:

- in road and traffic conditions which do not allow you to maintain a constant speed e.g. in heavy traffic or on winding roads
- on slippery road surfaces. Braking or accelerating could cause the drive wheels to lose traction and the vehicle could then skid
- when there is poor visibility, e.g. due to fog, heavy rain or snow

DISTRONIC PLUS may not detect narrow vehicles driving in front, e.g. motorcycles, or vehicles driving on a different line.

In particular, the detection of obstacles can be impaired if:

- dirt on the sensors or anything else covering the sensors
- snow or heavy rain
- interference by other radar sources
- strong radar reflections, for example, in parking garages

If DISTRONIC PLUS no longer detects a vehicle in front, DISTRONIC PLUS may unexpectedly accelerate the vehicle to the stored speed.

This speed may:

- be too high if you are driving in a filter lane or an exit lane
- be so high in the right lane that you pass vehicles driving on the left (left-hand drive countries)
- be so high in the left lane that you pass vehicles driving on the right (right-hand drive countries)

If there is a change of drivers, advise the new driver of the speed stored.

### Cruise control lever

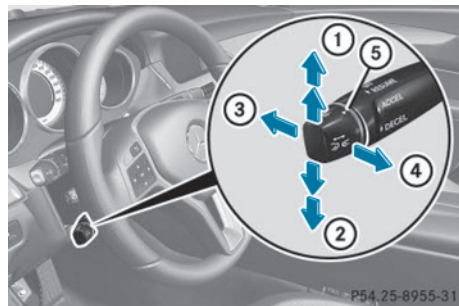

- ① To store the current speed or a higher speed
- ② To store the current speed or a lower speed
- ③ To deactivate DISTRONIC PLUS
- ④ To store the current speed or call up the last stored speed
- ⑤ To set the specified minimum distance

### Activating DISTRONIC PLUS

#### Activation conditions

In order to activate DISTRONIC PLUS, the following conditions must be fulfilled:

- the engine must be started. It may take up to two minutes after pulling away before DISTRONIC PLUS is operational.
- the parking brake must be released.
- ESP® must be active, but not intervening.
- Active Parking Assist must not be activated.



- the transmission must be in position **D**.
- the hood must be closed.
- the driver's door must be closed when you shift from **P** to **D** or your seat belt must be fastened.
- the front-passenger door and rear doors must be closed.
- the vehicle must not skid.

### Activating

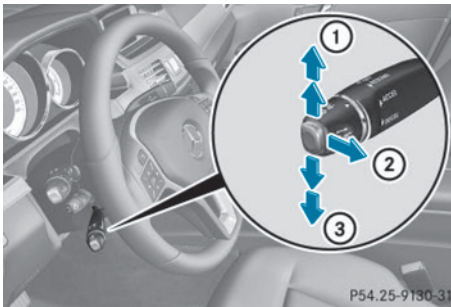

- ▶ Briefly pull the cruise control lever towards you ② or press it up ① or down ③. DISTRONIC PLUS is selected.
- ▶ Press the cruise control lever repeatedly up ① or down ③ until the desired speed is set.
- ▶ Remove your foot from the accelerator pedal.  
Your vehicle adapts its speed to that of the vehicle in front, but only up to the desired stored speed.

If the vehicle in front of you is stationary, you can only activate DISTRONIC PLUS once your vehicle is stationary as well.

When driving at speeds below 20 mph (30 km/h), you can only activate DISTRONIC PLUS if the vehicle in front has been detected and is shown in the multifunction display. If the vehicle in front is no longer detected and displayed, DISTRONIC PLUS switches off and a tone sounds. The DISTRONIC PLUS assistance graphic in the instrument cluster shows whether a vehicle in front has been detected. (> page 161)

- ❗ If you do not fully release the accelerator pedal, the **DISTRONIC PLUS Override** message appears in the multifunction display. The set distance to a slower-moving vehicle in front will then not be maintained. You will be driving at the speed you determine by the position of the accelerator pedal.

### Activating at the current speed/last stored speed

#### ⚠ WARNING

If you call up the stored speed and it differs from the current speed, the vehicle accelerates or decelerates. If you do not know the stored speed, the vehicle could accelerate or brake unexpectedly. There is a risk of an accident.

Pay attention to the road and traffic conditions before calling up the stored speed. If you do not know the stored speed, store the desired speed again.

- ▶ Briefly pull the cruise control lever towards you ④.
- ▶ Remove your foot from the accelerator pedal.  
DISTRONIC PLUS is activated. The first time it is activated, the current speed is stored. Otherwise, it sets the vehicle cruise speed to the previously stored value.

### Driving with DISTRONIC PLUS

#### Pulling away and driving

- ▶ **If you want to pull away with DISTRONIC PLUS:** remove your foot from the brake pedal.
  - ▶ Briefly pull the cruise control lever towards you ③.
- or
- ▶ Accelerate briefly.  
Your vehicle pulls away and adapts its speed to that of the vehicle in front.

- ❗ The vehicle can also pull away when it is facing an unidentified obstacle or is driving

on a different line from another vehicle. The vehicle then brakes automatically. There is a risk of an accident. Be ready to brake at all times.

If there is no vehicle in front, DISTRONIC PLUS operates in the same way as cruise control.

If DISTRONIC PLUS detects that the vehicle in front has slowed down, it brakes your vehicle. In this way, the distance you have selected is maintained.

If DISTRONIC PLUS detects a faster-moving vehicle in front, it increases the driving speed. However, the vehicle is only accelerated up to the speed you have stored.

### Changing lanes

If you change to the passing lane, DISTRONIC PLUS supports you when:

- you are driving faster than 40 mph (60 km/h)
- DISTRONIC PLUS is maintaining the distance to a vehicle in front
- you switch on the appropriate turn signal
- DISTRONIC PLUS does not detect a danger of collision

If these conditions are fulfilled, your vehicle is accelerated. Acceleration will be interrupted if changing lanes takes too long or if the distance between your vehicle and the vehicle in front becomes too small.

- i When changing lanes, DISTRONIC PLUS monitors the left lane on left-hand drive vehicles and the right lane on right-hand drive vehicles.

### Stopping

#### WARNING

When leaving the vehicle, even if it is braked only by DISTRONIC PLUS, it could roll away if:

- there is a malfunction in the system or in the voltage supply.
- DISTRONIC PLUS has been deactivated with the cruise control lever, e.g. by a

vehicle occupant or from outside the vehicle.

- the electrical system in the engine compartment, the battery or the fuses have been tampered with.
- the battery is disconnected.
- the accelerator pedal has been depressed, e.g. by a vehicle occupant.

There is a risk of an accident.

If you wish to exit the vehicle, always turn off DISTRONIC PLUS and secure the vehicle against rolling away.

If DISTRONIC PLUS detects that the vehicle in front is stopping, it brakes your vehicle until it is stationary.

Once your vehicle is stationary, it remains stationary and you do not need to depress the brake.

- i Depending on the specified minimum distance, your vehicle will come to a standstill at a sufficient distance behind the vehicle in front. The specified minimum distance is set using the control on the cruise control lever.

When DISTRONIC PLUS is activated, the transmission is shifted automatically to position **P** if:

- the driver's door is open and the driver's seat belt is unfastened.
- the engine is switched off, unless it is automatically switched off by the ECO start/stop function.
- the hood is opened.
- a system malfunction occurs.
- the power supply is not sufficient.

## Information in the Digital Operator's Manual

In the Digital Operator's Manual you will find information on the following topics:

- Setting a speed
- Setting the specified minimum distance
- DISTRONIC PLUS displays in the instrument cluster

## Deactivate DISTRONIC PLUS

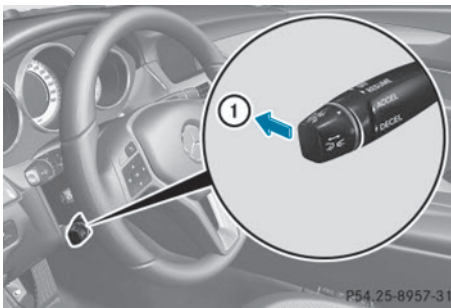

There are several ways to deactivate DISTRONIC PLUS:

- ▶ Briefly press the cruise control lever forwards ①.

or

- ▶ Brake, unless the vehicle is stationary.

When you deactivate DISTRONIC PLUS, you will see the **DISTRONIC PLUS Off** message in the multifunction display for approximately five seconds.

- ❗ The last speed stored remains stored until you switch off the engine.
- ❗ DISTRONIC PLUS is not deactivated if you depress the accelerator pedal.

DISTRONIC PLUS is automatically deactivated if:

- you engage the parking brake
- you are driving slower than 15 mph (25 km/h) and there is no vehicle in front, or if the vehicle in front is no longer detected
- ESP® intervenes or you deactivate ESP®

- the transmission is in the **P**, **R** or **N** position
- you pull the cruise control lever towards you in order to pull away and the front-passenger door or one of the rear doors is open
- the vehicle has skidded
- you activate Active Parking Assist

If DISTRONIC PLUS is deactivated, you will hear a warning tone. You will see the **DISTRONIC PLUS Off** message in the multifunction display for approximately five seconds.

## Tips for driving with DISTRONIC PLUS

### General notes

Pay particular attention in the following traffic situations:

- Cornering, going into and coming out of a bend
- Vehicles traveling on a different line
- Other vehicles changing lanes
- Narrow vehicles
- Obstructions and stationary vehicles
- Crossing vehicles

In such situations, brake if necessary. DISTRONIC PLUS is then deactivated.

### Cornering, going into and coming out of a bend

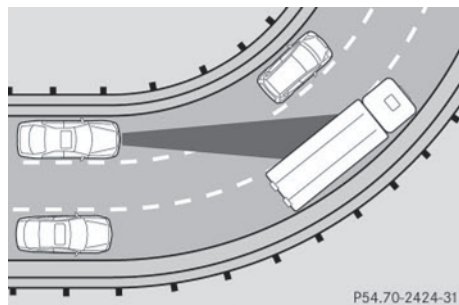

The ability of DISTRONIC PLUS to detect vehicles when cornering is limited. Your vehicle may brake unexpectedly or late.

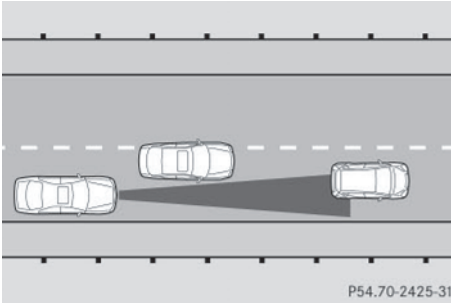
**Vehicles traveling on a different line**

P54.70-2425-31

DISTRONIC PLUS may not detect vehicles traveling on a different line. The distance to the vehicle in front will be too short.

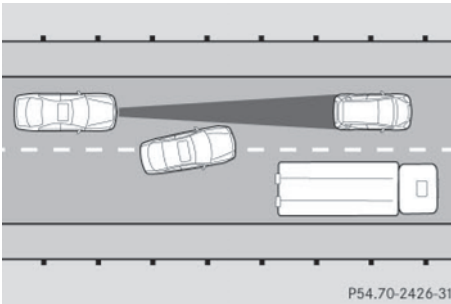
**Other vehicles changing lanes**

P54.70-2426-31

DISTRONIC PLUS has not detected the vehicle cutting in yet. The distance to this vehicle will be too short.

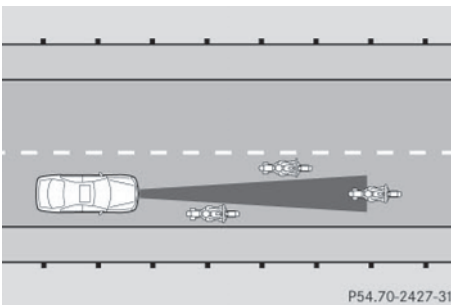
**Narrow vehicles**

P54.70-2427-31

DISTRONIC PLUS has not yet detected the vehicle in front on the edge of the road,

because of its narrow width. The distance to the vehicle in front will be too short.

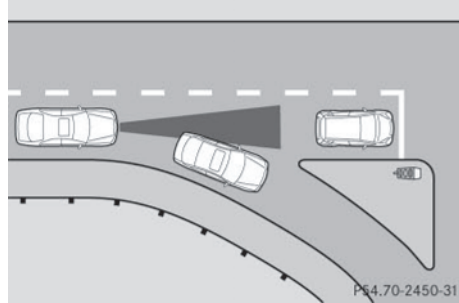
**Obstructions and stationary vehicles**

P54.70-2450-31

DISTRONIC PLUS does not brake for obstacles or stationary vehicles. If, for example, the detected vehicle turns a corner and reveals an obstacle or stationary vehicle, DISTRONIC PLUS will not brake for these.

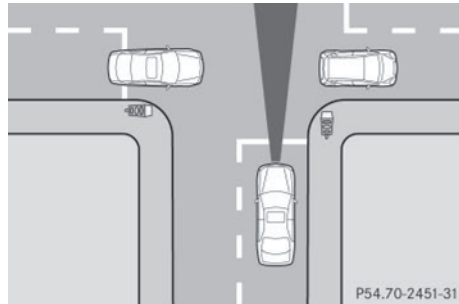
**Crossing vehicles**

P54.70-2451-31

DISTRONIC PLUS may mistakenly detect vehicles that are crossing your lane. Activating DISTRONIC PLUS at traffic lights with crossing traffic, for example, could cause your vehicle to pull away unintentionally.

## HOLD function

### General notes

The HOLD function can assist the driver in the following situations:

- when pulling away, especially on steep slopes
- when maneuvering on steep slopes
- when waiting in traffic

The vehicle is kept stationary without the driver having to depress the brake pedal.

The braking effect is canceled and the HOLD function deactivated when you depress the accelerator pedal to pull away.

### Important safety notes

#### WARNING

When leaving the vehicle, it can still roll away despite being braked by the HOLD function if:

- there is a malfunction in the system or in the voltage supply.
- the HOLD function has been deactivated by pressing the accelerator pedal or the brake pedal, e.g. by a vehicle occupant.
- the electrical system in the engine compartment, the battery or the fuses have been tampered with.
- the battery is disconnected

There is a risk of an accident.

If you wish to exit the vehicle, always turn off the HOLD function and secure the vehicle against rolling away.

**!** If DISTRONIC PLUS or the HOLD function is activated, the vehicle brakes automatically in certain situations. To prevent damage to the vehicle, deactivate DISTRONIC PLUS and the HOLD function in the following or other similar situations:

- when towing the vehicle
- in the car wash

### Activation conditions

You can activate the HOLD function if:

- the vehicle is stationary
- the engine is running or if it has been automatically switched off by the ECO start/stop function
- the driver's door is closed or your seat belt is fastened
- the parking brake is released
- the hood is closed
- the transmission is in position **D**, **R** or **N**
- DISTRONIC PLUS is deactivated

### Activating the HOLD function



- ▶ Make sure that the activation conditions are met.
- ▶ Depress the brake pedal.
- ▶ Quickly depress the brake pedal further until **HOLD** ① appears in the multifunction display. The HOLD function is activated. You can release the brake pedal.

**i** If depressing the brake pedal the first time does not activate the HOLD function, wait briefly and then try again.

### Deactivating the HOLD function

The HOLD function is deactivated automatically if:

- you accelerate and the transmission is in position **D** or **R**.
- you shift the transmission to position **P**.

- you depress the brake pedal again with a certain amount of pressure until **HOLD** disappears from the multifunction display.
- you activate DISTRONIC PLUS.

When the HOLD function is activated, the transmission is shifted automatically to position **P** if:

- the driver's door is open and the driver's seat belt is unfastened.
- the engine is switched off, unless it is automatically switched off by the ECO start/stop function.
- the hood is opened.
- a system malfunction occurs.
- the power supply is not sufficient.

## RACE START

### Important safety notes

- i** Observe the safety notes for the SPORT handling mode (▷ page 76).

RACE START is intended solely for activation on dedicated race circuits.

RACE START enables optimal acceleration from a standing start. The precondition for this is a suitable high-grip road surface.

- i** RACE START is only available in AMG vehicles.

### Information in the Digital Operator's Manual

In the Digital Operator's Manual you will find information on the following topics:

- Conditions for activation
- Activating RACE START

## AIRMATIC

### Vehicle level

#### Important safety notes

#### WARNING

When the vehicle is being lowered, people could become trapped if their limbs are between the vehicle body and the wheels or underneath the vehicle. There is a risk of injury.

Make sure no one is underneath the vehicle or in the immediate vicinity of the wheel arches when the vehicle is being lowered.

#### WARNING

Vehicles with level control:

The vehicle is slightly lowered if:

- you have selected comfort suspension tuning and
- you lock the vehicle within approximately 60 seconds of switching off the engine

You and people in the vicinity of the wheel arch or the underbody may thus become trapped. There is a risk of injury.

Make sure that nobody is in the vicinity of the wheel arch or the underbody when you lock the vehicle.

- !** The vehicle is lowered by about 15 mm if:

- you have selected "Comfort tuning"
- you switch off the engine and then
- you lock the vehicle within approximately 60 seconds

When parking, position your vehicle so that it does not make contact with the curb as the vehicle is lowered. Your vehicle could otherwise be damaged.

If you unlock the vehicle within 60 seconds of having switched the engine off, the vehicle is lowered slightly when Comfort suspension mode is selected.

Your vehicle regulates its height automatically. All-round level control ensures the best possible suspension and constant

ground clearance, even with a laden vehicle. Further general information on the vehicle level can be found in the Digital Operator's Manual.

### Setting the vehicle level

Select the "Normal" setting for normal road surfaces and "Raised" for driving with snow chains or on particularly poor road surfaces. Your selection remains stored even if you remove the SmartKey from the ignition lock.

### Setting raised level

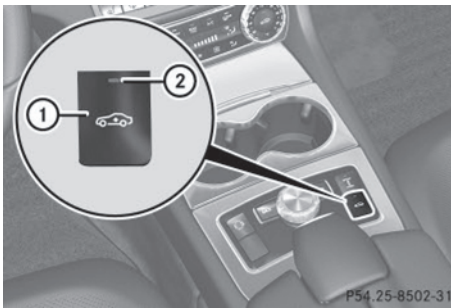

- ▶ Start the engine.

If indicator lamp ② is not lit:

- ▶ Press button ①.  
Indicator lamp ② lights up. The vehicle height is adjusted to raised level.  
The **Vehicle Rising** message appears in the display.

The "Raised level" setting is canceled if you:

- drive at a speed over approximately 75 mph (120 km/h)
- drive for approximately three minutes at a speed over 50 mph (80 km/h)

The "Raised level" remains active when you are not driving within these speed ranges.

### Setting the normal level

- ▶ Start the engine.

If indicator lamp ② is lit:

- ▶ Press button ①.  
Indicator lamp ② goes out. The vehicle is adjusted to normal level.

### Suspension tuning

#### General notes

You can find information about this in the Digital Operator's Manual.

### AMG adaptive sport suspension system

#### Information in the Digital Operator's Manual

In the Digital Operator's Manual you will find information on the following topics:

- Vehicle level
- Rear axle level control
- Suspension tuning

### Important safety notes

#### WARNING

When the vehicle is being lowered, people could become trapped if their limbs are between the vehicle body and the wheels or underneath the vehicle. There is a risk of injury.

Make sure no one is underneath the vehicle or in the immediate vicinity of the wheel arches when the vehicle is being lowered.

#### WARNING

Vehicles with level control:

The vehicle is slightly lowered if:

- you have selected comfort suspension tuning and
- you lock the vehicle within approximately 60 seconds of switching off the engine

You and people in the vicinity of the wheel arch or the underbody may thus become trapped. There is a risk of injury.

Make sure that nobody is in the vicinity of the wheel arch or the underbody when you lock the vehicle.

**!** The vehicle is lowered by about 0.8 in (20 mm) if:

- you have selected "Comfortable tuning"
- you switch off the engine and then
- you lock the vehicle within approximately 60 seconds

When parking, position your vehicle so that it does not make contact with the curb as the vehicle is lowered. Your vehicle could otherwise be damaged.

## Vehicle level

### Important safety notes

#### WARNING

When the vehicle is being lowered, people could become trapped if their limbs are between the vehicle body and the wheels or underneath the vehicle. There is a risk of injury.

Make sure no one is underneath the vehicle or in the immediate vicinity of the wheel arches when the vehicle is being lowered.

The vehicle lowers when you press the button for selecting the suspension tuning or the AMG button. The vehicle also lowers if it is stationary.

**!** If Sport or Sport + suspension tuning has been selected, the vehicle's ground clearance decreases. Make sure that no objects become trapped or that the vehicle does not become damaged, for example, on the curb.

**i** The vehicle level may change visibly at the rear axle if you park the vehicle and the outside temperature changes. If the temperature drops, the vehicle level

lowers; with an increase in temperature, the vehicle level rises.

## 4MATIC (permanent four-wheel drive)

If you fail to adapt your driving style, 4MATIC can neither reduce the risk of accident nor override the laws of physics. 4MATIC cannot take account of road, weather and traffic conditions. 4MATIC is only an aid. You are responsible for the distance to the vehicle in front, for vehicle speed, for braking in good time and for staying in your lane.

If a drive wheel spins due to insufficient grip:

- Only depress the accelerator pedal as far as necessary when pulling away.
- Accelerate less when driving.

**!** Never tow the vehicle with one axle raised. This may damage the transfer case. Damage of this sort is not covered by the Mercedes-Benz Limited Warranty. All wheels must remain either on the ground or be fully raised. Observe the instructions for towing the vehicle with all wheels in full contact with the ground.

**i** In wintry driving conditions, the maximum effect of 4MATIC can only be achieved if you use winter tires (M+S tires), with snow chains if necessary.

4MATIC ensures that all four wheels are permanently driven. Together with ESP®, it improves the traction of your vehicle whenever a drive wheel spins due to insufficient grip.

## PARKTRONIC

### Important safety notes

PARKTRONIC is an electronic parking aid with ultrasonic sensors. It indicates visually and audibly the distance between your vehicle and an object.

PARKTRONIC is only an aid. It is not a replacement for your attention to your



immediate surroundings. You are always responsible for safe maneuvering, parking and exiting a parking space. When maneuvering, parking or pulling out of a parking space, make sure that there are no persons, animals or objects in the area in which you are maneuvering.

**!** When parking, pay particular attention to objects above or below the sensors, such as flower pots or trailer drawbars.

PARKTRONIC does not detect such objects when they are in the immediate vicinity of the vehicle. You could damage the vehicle or the objects.

The sensors may not detect snow and other objects that absorb ultrasonic waves.

Ultrasonic sources such as an automatic car wash, the compressed-air brakes on a truck or a pneumatic drill could cause PARKTRONIC to malfunction.

PARKTRONIC may not function correctly on uneven terrain.

PARKTRONIC is activated automatically when you:

- switch on the ignition
- shift the transmission to position **D**, **R** or **N**
- release the parking brake

PARKTRONIC is deactivated at speeds above 11 mph (18 km/h). It is reactivated at lower speeds.

PARKTRONIC monitors the area around your vehicle using six sensors in the front bumper and four sensors in the rear bumper.

### Range of the sensors

#### General notes

PARKTRONIC does not take objects into consideration that are:

- below the detection range, e.g. people, animals or objects
- above the detection range, e.g. overhanging loads, truck overhangs or loading ramps.

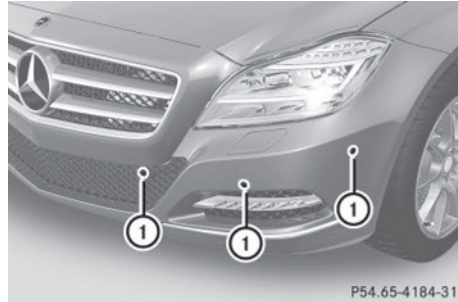

① Sensors in the front bumper, left-hand side (example)

The sensors must be free from dirt, ice or slush. They can otherwise not function correctly. Clean the sensors regularly, taking care not to scratch or damage them (▷ page 225).

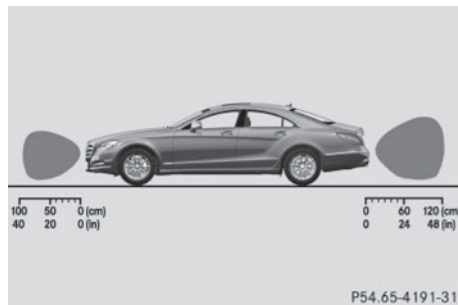

Example: side view

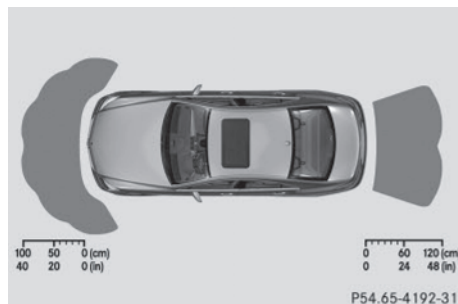

Example: top view

**Front sensors**

Center	Approx. 40 in (approx. 100 cm)
Corners	Approx. 24 in (approx. 60 cm)

**Rear sensors**

Center	Approx. 48 in (approx. 120 cm)
Corners	Approx. 32 in (approx. 80 cm)

**Minimum distance**

Center	Approx. 8 in (approx. 20 cm)
Corners	Approx. 6 in (approx. 15 cm)

If there is an obstacle within this range, the relevant warning displays light up and a warning tone sounds. If the distance falls below the minimum, the distance may no longer be shown.

**Information in the Digital Operator's Manual**

In the Digital Operator's Manual you will find information on the following topics:

- Warning displays
- Deactivating/activating PARKTRONIC
- Problems with PARKTRONIC

**Active Parking Assist****General notes**

Active Parking Assist is an electronic parking aid with ultrasound. It measures the road on both sides of the vehicle. A parking symbol indicates a suitable parking space. Active steering intervention can assist you during parking. You may also use PARKTRONIC (> page 142).

**Important safety notes**

Active Parking Assist is merely an aid. It is not a replacement for your attention to your immediate surroundings. You are always responsible for safe maneuvering, parking and exiting a parking space. Make sure that no persons, animals or objects are in the maneuvering range.

When PARKTRONIC is switched off, Active Parking Assist is also unavailable.

**⚠ WARNING**

If there are objects above the detection range, Active Parking Assist may turn prematurely. You may cause a collision as a result. There is a risk of an accident.

If there are objects above the detection range, stop and deactivate Active Parking Assist.

**⚠ WARNING**

Active Parking Assist merely aids you by intervening actively in the steering. If you do not brake there is a risk of an accident.

Always apply the brakes yourself when maneuvering and parking.

**⚠ WARNING**

The vehicle swings out when parking and in doing so could cross into the opposite lane. This could result in a collision with another road user. There is a risk of an accident.

Pay attention to other road users when parking. Stop the vehicle if necessary or cancel the Active Parking Assist parking procedure.

- If unavoidable, you should drive over obstacles such as curbs slowly and not at a sharp angle. Otherwise, you may damage the wheels or tires.

Active Parking Assist may possibly indicate parking spaces which are not suitable for parking, for example:

- where parking or stopping is prohibited
- in front of driveways or entrances and exits
- on unsuitable surfaces

Parking tips:

- On narrow roads, drive as close to the parking space as possible.
- Parking spaces that are littered or overgrown might be identified or measured incorrectly.
- Parking spaces that are partially occupied by trailer drawbars might not be identified as such or be measured incorrectly.
- Snowfall or heavy rain may lead to a parking space being measured inaccurately.
- Pay attention to the PARKTRONIC (▷ page 144) warning messages during the parking procedure.
- You can intervene in the steering procedure to correct it at any time. Active Parking Assist will then be canceled.
- When transporting a load which protrudes from your vehicle, you should not use Active Parking Assist.
- Never use Active Parking Assist when snow chains are installed.
- Make sure that the tire pressures are always correct. This has a direct influence on the parking characteristics of the vehicle.

Use Active Parking Assist for parking spaces:

- that are parallel to the direction of travel
- that are on straight roads, not bends
- that are on the same level as the road, e.g. not on the pavement

## Information in the Digital Operator's Manual

In the Digital Operator's Manual you will find information on the following topics:

- Detecting parking spaces
- Parking
- Exiting a parking space
- Canceling Active Parking Assist

### Rear view camera

#### General notes

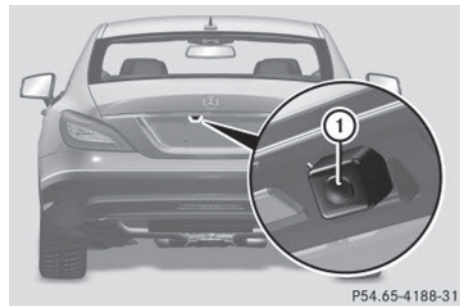

Example: Coupe

Rear view camera ① is located in the handle strip of the trunk lid.

Rear view camera ① is an optical parking and maneuvering aid. It shows the area behind your vehicle with guide lines in the COMAND display.

The area behind the vehicle is displayed as a mirror image, as in the rear view mirror.

**i** The text of messages shown in the COMAND display depends on the language setting. The following are examples of rear view camera messages in the COMAND display.

### Important safety notes

The rear view camera is only an aid. It is not a replacement for your attention to your immediate surroundings. You are always responsible for safe maneuvering and

parking. When maneuvering or parking, make sure that there are no persons, animals or objects in the area in which you are maneuvering.

Under the following circumstances, the rear view camera will not function, or will function in a limited manner:

- if the trunk lid/tailgate is open
- in heavy rain, snow or fog
- at night or in very dark places
- if the camera is exposed to very bright light
- if the area is lit by fluorescent light or LED lighting (the display may flicker)
- if there is a sudden change in temperature, e.g. when driving into a heated garage in winter
- if the camera lens is dirty or obstructed
- if the rear of your vehicle is damaged. In this event, have the camera position and setting checked at a qualified specialist workshop

The field of vision and other functions of the rear view camera may be restricted due to additional accessories on the rear of the vehicle (e.g. license plate holder, bicycle rack).

**!** Objects not at ground level may appear to be further away than they actually are, e.g.:

- the bumper of a parked vehicle
- the drawbar of a trailer
- the ball coupling of a trailer tow hitch
- the rear section of an HGV
- a slanted post

Use the guidelines only for orientation. Approach objects no further than the bottom-most guideline.

The rear view camera may show a distorted view of obstacles, show them incorrectly or not at all. The rear view camera does not show objects in the following positions:

- very close to the rear bumper
- under the rear bumper
- in the area immediately above the tailgate handle

### Activating/deactivating the rear view camera

- ▶ **To activate:** make sure that the SmartKey is in position **2** in the ignition lock.
- ▶ Make sure that the "Activation by R gear" function is selected in COMAND; see Digital Operator's Manual.
- ▶ Make sure that the "Activation by R gear" setting is active in COMAND, see the separate COMAND operating instructions.
- ▶ Engage reverse gear.  
The area behind the vehicle is shown in the COMAND display with guide lines.

**To deactivate:** the rear view camera deactivates if you shift the transmission to **P** or after driving forwards a short distance.

### Information in the Digital Operator's Manual

In the Digital Operator's Manual you will find information on the following topics:

- Displays in the COMAND display
- "Reverse parking" function

### ATTENTION ASSIST

#### Important safety notes

ATTENTION ASSIST is only an aid to the driver. It might not always recognize fatigue or increasing inattentiveness in time or fail to recognize them at all. The system is not a substitute for a well-rested and attentive driver.

## General notes

ATTENTION ASSIST helps you during long, monotonous journeys, such as on highways. It is active in the range between 50 mph (80 km/h) and 112 mph (180 km/h).

If ATTENTION ASSIST detects typical indicators of fatigue or increasing lapses in concentration on the part of the driver, it suggests you take a break.

ATTENTION ASSIST assesses your level of fatigue or lapses in concentration by taking the following criteria into account:

- your personal driving style, e.g. steering characteristics
- journey details, e.g. time of day and length of journey

The functionality of ATTENTION ASSIST is restricted and warnings may be delayed or not occur at all:

- if the road condition is poor, e.g. if the surface is uneven or if there are potholes
- if there is a strong side wind
- if you have adopted a sporty driving style with high cornering speeds or high rates of acceleration
- if you are predominantly driving slower than 50 mph (80 km/h) or faster than 112 mph (180 km/h)
- if you are currently using COMAND or making a telephone call with it
- if the time has been set incorrectly
- in active driving situations, such as when you change lanes or change your speed

## Warning and display messages in the multifunction display

You can find information about this in the Digital Operator's Manual.

## Night View Assist Plus

### Important safety notes

Night View Assist Plus is only an aid and is not a substitute for attentive driving. Do not rely on the Night View Assist Plus display. You are responsible for the distance to the vehicle in front, for vehicle speed and for braking in good time. Drive carefully and always adapt your driving style to suit the prevailing road and traffic conditions.

Night View Assist Plus cannot display objects directly in front of or beside the vehicle.

The system may be impaired or may not function if:

- there is poor visibility, e.g. due to snow, rain, fog or spray
- the windshield is dirty, fogged up or covered, for instance by a sticker, in the vicinity of the camera
- on bends, on uphill gradients or downhill gradients

Pedestrian recognition may be impaired or inoperative if:

- pedestrians are partially or entirely obscured by objects, e.g. parked vehicles
- the silhouette of the pedestrian in the Night View Assist Plus display is incomplete or interrupted, e.g. by powerful light reflections
- pedestrians do not contrast adequately from the background
- pedestrians are not in an upright position, e.g. sitting, squatting or lying

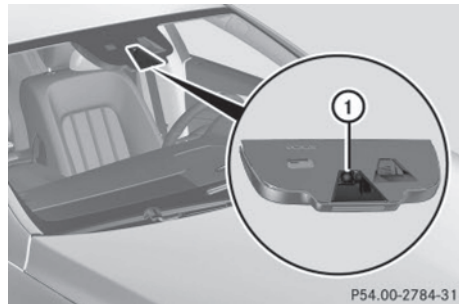

P54.00-2784-31

In addition to the illumination provided by the normal headlamps, Night View Assist Plus uses infrared light to illuminate the road. Night View Assist Plus camera ① picks up the infrared light and displays a monochrome image in COMAND. The image displayed in COMAND corresponds to a road lit up by high-beam headlamps. This enables you to see the road's course and any obstacles in good time. If pedestrian recognition is activated, pedestrians recognized by the system are highlighted in the Night View Assist Plus display.

Light from the headlamps of oncoming vehicles does not affect the Night View Assist Plus display in the multifunction display. This is also the case if you cannot switch on the high-beam headlamps due to oncoming traffic.

- i** Infrared light is not visible to the human eye and therefore does not glare. Night View Assist Plus can therefore remain switched on even if there is oncoming traffic.

### Activating Night View Assist Plus

#### Activation conditions

You can only activate Night View Assist Plus if:

- the SmartKey is in position **2** in the ignition lock.
- it is dark.
- the light switch is in the **AUTO** or  position.
- reverse gear has not been engaged.

### Activating Night View Assist Plus



- ▶ Make sure COMAND is switched on.
- ▶ Press button ①.

The Night View Assist Plus display appears in the COMAND display.

You can read about how to adjust the brightness of the COMAND display in the COMAND operating instructions.

- i** The infrared headlamps only switch on when the vehicle is being driven at speeds of approximately 6 mph (10 km/h). This means that you do not have the full visual range while the vehicle is stationary and cannot check whether Night View Assist Plus is working.

### Pedestrian recognition

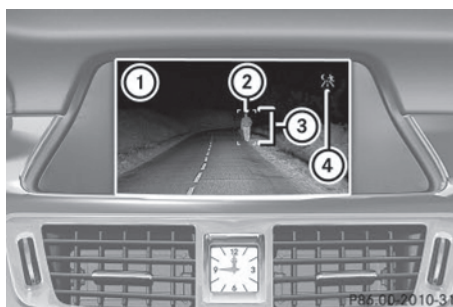

- ① Night View Assist Plus display
- ② Pedestrian recognized
- ③ Framing
- ④ Symbol for active pedestrian recognition

- i** Animals are not recognized by pedestrian recognition.

Night View Assist Plus is able to recognize pedestrians by typical characteristics, e.g. a silhouette in the shape of a person.

Pedestrian recognition is then switched on automatically:

- if Night View Assist Plus is activated
- if you are driving faster than approximately 6 mph (10 km/h)
- the surroundings are dark, e.g. when driving outside built-up areas without street lighting

If pedestrian recognition is active, symbol ④ appears. If pedestrians are detected, they are highlighted with framing ③. If the pedestrian recognition system has brought a pedestrian to your attention, look through the windshield to evaluate the situation. The actual distance to objects and pedestrians cannot be gaged accurately by looking at a screen.

It may be the case that objects are highlighted as well as pedestrians.

### Fogged up or dirty windshield

If the windshield in front of the camera is fogged up or dirty on the inside or outside, the Night View Assist Plus display is affected.

- ▶ **To defrost:** check the automatic air conditioning settings (▷ page 118) and fold down the camera cover (▷ page 226).
- ▶ **To defrost the inside of the windshield:** fold down the camera cover (▷ page 226) and clean the windshield (▷ page 225).

### Problems with Night View Assist Plus

You can find information about this in the Digital Operator's Manual.

## Lane Tracking package

### General notes

The Lane Tracking package consists of Blind Spot Assist (▷ page 149) and Lane Keeping Assist (▷ page 151).

### Blind Spot Assist

#### General notes

Blind Spot Assist uses a radar sensor system to monitor the areas on both sides of your vehicle. It supports you from a speed of approximately 20 mph (30 km/h). A warning display in the exterior mirrors draws your attention to vehicles detected in the monitored area. If you then switch on the corresponding turn signal to change lanes, you will also receive a visual and audible collision warning. Blind Spot Assist uses sensors in the rear bumper for monitoring purposes.

#### Important safety notes

##### WARNING

Blind Spot Assist does not react to:

- vehicles overtaken too closely on the side, placing them in the blind spot area
- vehicles which approach with a large speed differential and overtake your vehicle

As a result, Blind Spot Assist may not give warnings in such situations. There is a risk of an accident.

Always observe the traffic conditions carefully, and maintain a safe lateral distance.

Blind Spot Assist is only an aid. It may fail to detect some vehicles and is no substitute for attentive driving. Always ensure that there is sufficient distance to the side for other road users and obstacles.

#### USA only:

This device has been approved by the FCC as a "Vehicular Radar System". The radar sensor is intended for use in an automotive radar system only. Removing, tampering

with, or altering the device will void any warranties, and is not permitted by the FCC. Do not tamper with, alter, or use in any non-approved way.

Any unauthorized modification to this device could void the user's authority to operate the equipment.

### Monitoring range of the sensors

In particular, the detection of obstacles can be impaired if:

- dirt on the sensors or anything else covering the sensors
- poor visibility, e.g. due to fog, heavy rain, snow or spray
- narrow vehicles, e.g. motorcycles or bicycles
- the road has very wide lanes
- the road has narrow lanes
- you are not driving in the middle of the lane
- there are barriers or similar lane borders

Vehicles in the monitoring range are then not indicated.

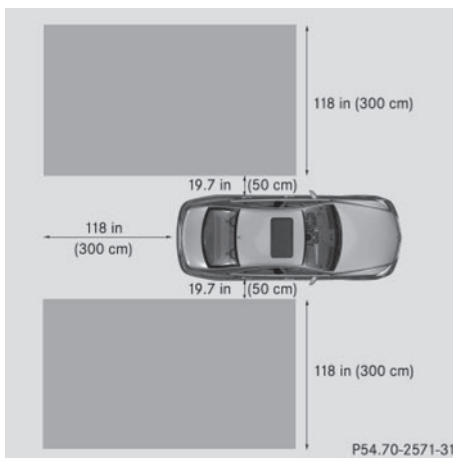

Blind Spot Assist monitors the area up to 10 ft (3 m) behind your vehicle and directly next to your vehicle, as shown in the diagram. If the lanes are narrow, vehicles driving in the lane beyond the lane next to your vehicle may be indicated, especially if the vehicles are not

driving in the middle of their lane. This may be the case if there are vehicles driving at the inner edge of their lanes.

Due to the nature of the system:

- warnings may be issued in error when driving close to crash barriers or similar solid lane borders.
- the warning is canceled when driving for an extended period next to long vehicles, such as trucks.

The two radar sensors for Blind Spot Assist are integrated into the sides of the rear bumper. Make sure that the bumper is free of dirt, ice or slush in the vicinity of the sensors. The sensors must not be covered, for example by cycle racks or overhanging loads. Following a severe impact or in the event of damage to the bumpers, have the function of the sensors checked at a qualified specialist workshop. Blind Spot Assist may otherwise not work properly.

### Indicator and warning display

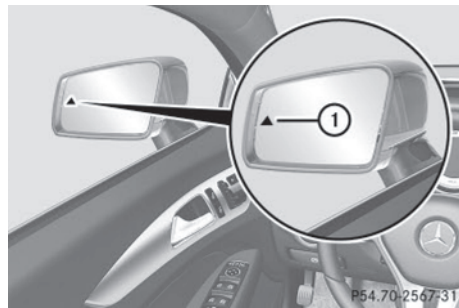

#### ① Yellow indicator lamp/red warning lamp

Blind Spot Assist is not active at speeds below approximately 20 mph (30 km/h). Vehicles in the monitoring range are then not indicated.

When Blind Spot Assist is activated, indicator lamp ① in the exterior mirrors lights up yellow at speeds of up to 20 mph (30 km/h). At speeds above 20 mph (30 km/h), the indicator lamp goes out and Blind Spot Assist is operational.

If a vehicle is detected within the blind spot monitoring range at speeds above 20 mph



(30 km/h), warning lamp ① on the corresponding side lights up red. This warning is always emitted when a vehicle enters the blind spot monitoring range from behind or from the side. When you overtake a vehicle, the warning only occurs if the difference in speed is less than 7 mph (12 km/h).

The yellow indicator lamp goes out if reverse gear is engaged. In this event, Blind Spot Assist is no longer active.

The brightness of the indicator/warning lamps is adjusted automatically according to the ambient light.

### Information in the Digital Operator's Manual

In the Digital Operator's Manual you can find information about:

- Collision warning
- Switching on Blind Spot Assist

### Lane Keeping Assist

#### General notes

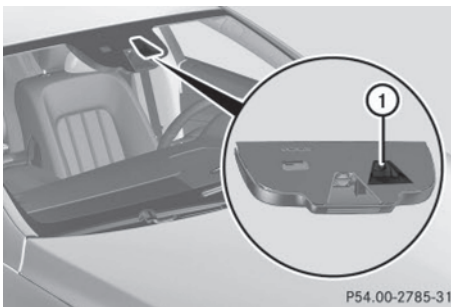

Lane Keeping Assist monitors the area in front of your vehicle with camera ①, which is mounted at the top of the windshield. Active Lane Keeping Assist detects lane markings on the road and can warn you before you leave your lane unintentionally.

This function is available in the range between 40 mph and 120 mph (60 km/h and 200 km/h).

A warning may be given if a front wheel passes over a lane marking. It will warn you

by means of intermittent vibration in the steering wheel for up to 1.5 seconds.

### Important safety notes

#### ⚠ WARNING

Lane Keeping Assist may not always clearly recognize lane markings.

In this case, Lane Keeping Assist may:

- give an unnecessary warning
- not give a warning

There is a risk of an accident.

Always pay particular attention to the traffic situation and stay in lane, in particular if warned by Lane Keeping Assist.

#### ⚠ WARNING

The Lane Keeping Assist warning does not return the vehicle to the original lane. There is a risk of an accident.

You should always steer, brake or accelerate yourself, in particular if warned by Lane Keeping Assist.

If you fail to adapt your driving style, Lane Keeping Assist can neither reduce the risk of an accident nor override the laws of physics. Lane Keeping Assist cannot take into account the road, traffic and weather conditions. Lane Keeping Assist is merely an aid. You are responsible for the distance to the vehicle in front, for vehicle speed, for braking in good time and for staying in your lane.

The Lane Keeping Assist does not keep the vehicle in the lane.

The system may be impaired or may not function if:

- there is poor visibility, e.g. due to insufficient illumination of the road, or due to snow, rain, fog or spray
- there is glare, e.g. from oncoming traffic, the sun or reflections (e.g. when the road surface is wet)
- the windshield is dirty, fogged up, damaged or covered, for instance by a sticker, in the vicinity of the camera

- there are no, several or unclear lane markings for a lane, e.g. in areas with road construction work
- the lane markings are worn away, dark or covered up, e.g. by dirt or snow
- the distance to the vehicle in front is too small and the lane markings thus cannot be detected
- the lane markings change quickly, e.g. lanes branch off, cross one another or merge
- the road is narrow and winding
- there are strong shadows cast on the lane

### Switching on Lane Keeping Assist

You can find information about this in the Digital Operator's Manual.

## Active Driving Assistance package

### General notes

The Active Driving Assistance package consists of DISTRONIC PLUS (▷ page 132), Active Blind Spot Assist (▷ page 152) and Active Lane Keeping Assist (▷ page 155).

### Active Blind Spot Assist

#### General notes

Active Blind Spot Assist uses a radar sensor system, pointed toward the rear of the vehicle, to monitor the area to the sides of the vehicle which the driver is unable to see. A warning display in the exterior mirrors draws your attention to vehicles detected in the monitored area. If you then switch on the corresponding turn signal to change lane, you will also receive an optical and audible warning. If a risk of lateral collision is detected, corrective braking may help you avoid a collision. Before a course-correcting brake application, Active Blind Spot Assist evaluates the space in the direction of travel and at the sides of the vehicle. For this, Active Blind Spot Assist uses radar sensors which are pointed in the direction of travel.

Active Blind Spot Assist supports you from a speed of approximately 20 mph (30 km/h).

### Important safety notes

Active Blind Spot Assist is only an aid and is not a substitute for attentive driving.

#### WARNING

Active Blind Spot Assist does not react to:

- vehicles overtaken too closely on the side, placing them in the blind spot area
- vehicles which approach with a large speed differential and overtake your vehicle

As a result, Active Blind Spot Assist may neither give warnings nor intervene in such situations. There is a risk of an accident.

Always observe the traffic conditions carefully, and maintain a safe lateral distance.

#### USA only:

This device has been approved by the FCC as a "Vehicular Radar System". The radar sensor is intended for use in an automotive radar system only. Removing, tampering with, or altering the device will void any warranties, and is not permitted by the FCC. Do not tamper with, alter, or use in any non-approved way.

Any unauthorized modification to this device could void the user's authority to operate the equipment.

#### Canada only: This device complies with RSS-210 of Industry Canada. Operation is subject to the following two conditions:

1. This device may not cause harmful interference, and
2. this device must accept any interference received, including interference that may cause undesired operation of the device.

Removal, tampering, or altering of the device will void any warranties, and is not permitted. Do not tamper with, alter, or use in any non-approved way.

Any unauthorized modification to this device could void the user's authority to operate the equipment.

### Radar sensors

The Active Blind Spot Assist radar sensors are integrated into the front and rear bumpers and behind a cover in the radiator grill. Make sure that the bumpers and the cover in the radiator grill are free of dirt, ice or slush. The rear sensors must not be covered, for example by cycle racks or overhanging cargo. Following a severe impact or in the event of damage to the bumpers, have the function of the radar sensors checked at a qualified specialist workshop. Active Blind Spot Assist may otherwise no longer work properly.

### Monitoring area

#### WARNING

Active Blind Spot Assist does not detect all traffic situations and road users. There is a risk of an accident.

Always make sure that there is sufficient distance on the side for other traffic or obstacles.

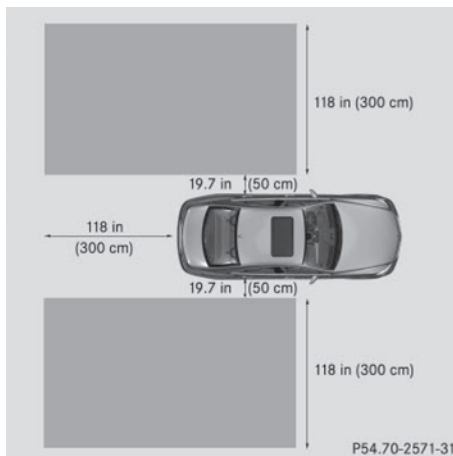

Active Blind Spot Assist monitors the area up to 10 ft (3.0 m) behind your vehicle and directly next to your vehicle, as shown in the diagram.

The detection of obstacles can be impaired in the case of:

- dirt on the sensors or anything else covering the sensors
- poor visibility, e.g. due to rain, snow or spray

Vehicles in the monitoring range are then not indicated or indicated with a delay.

Active Blind Spot Assist may not detect narrow vehicles, such as motorcycles or bicycles, or may only detect them too late.

If the lanes are narrow, vehicles driving in the lane beyond the lane next to your vehicle may be indicated, especially if the vehicles are not driving in the middle of their lane. This may be the case if there are vehicles at the edge of their lane.

Due to the nature of the system:

- warnings may be issued in error when driving close to crash barriers or similar solid lane borders.
- the warning is canceled when driving for an extended period next to long vehicles, such as trucks.

### Indicator and warning display

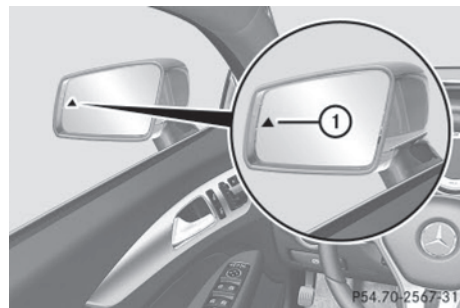

#### ① Yellow indicator lamp/red warning lamp

Active Blind Spot Assist is not active at speeds below approximately 20 mph (30 km/h). Vehicles in the monitoring range are then not indicated.

When Active Blind Spot Assist is activated, indicator lamp ① in the exterior mirrors lights up yellow at speeds of up to 20 mph

(30 km/h). At speeds above 20 mph (30 km/h), the indicator lamp goes out and Active Blind Spot Assist is operational.

If a vehicle is detected within the blind spot monitoring range at speeds above 20 mph (30 km/h), warning lamp ① on the corresponding side lights up red. This warning is always given when a vehicle enters the blind spot monitoring range from behind or from the side. When you overtake a vehicle, the warning only occurs if the difference in speed is less than 7 mph (12 km/h).

The yellow indicator lamp goes out if reverse gear is engaged. In this event, Active Blind Spot Assist is no longer active.

The brightness of the indicator/warning lamps is adjusted automatically according to the ambient light.

#### Visual and acoustic collision warning

If you switch on the turn signals to change lanes and a vehicle is detected in the side monitoring range, you receive a visual and acoustic collision warning. You then hear a double warning tone and red warning lamp ① flashes. If the turn signal remains on, detected vehicles are indicated by the flashing of red warning lamp ①. There are no further warning tones.

#### Course-correcting brake application

##### WARNING

A course-correcting brake application cannot always prevent a collision. There is a risk of an accident.

Always steer, brake or accelerate yourself, especially if Active Blind Spot Assist warns you or makes a course-correcting brake application. Always maintain a safe distance at the sides.

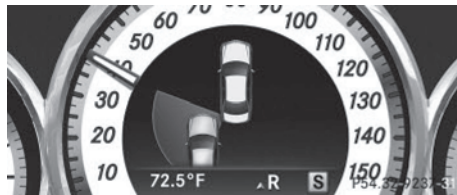
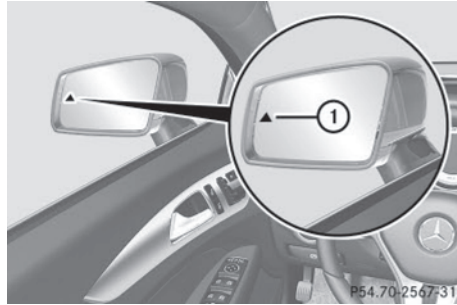

If Active Blind Spot Assist detects a risk of a lateral collision in the monitoring range, a course-correcting brake application is carried out. This is meant to assist you in avoiding a collision.

If a course-correcting brake application occurs, red warning lamp ① flashes in the exterior mirror and a dual warning tone sounds. In addition, the display shown in the lower image appears in the multifunction display.

In very rare cases, the system may make an inappropriate brake application. An inappropriate course-correcting brake application may be interrupted at any time if you steer slightly in the opposite direction or accelerate, for example.

The course-correcting brake application is available in the speed range between 20 mph (30 km/h) and 120 mph (200 km/h).

Either no braking application, or a course-correcting brake application adapted to the driving situation occurs if:

- there are vehicles or obstacles, e.g. crash barriers, located on both sides of your vehicle.
- a vehicle approaches you too closely at the side.
- you have adopted a sporty driving style with high cornering speeds.
- you clearly brake or accelerate.
- a driving safety system intervenes, e.g. ESP® or PRE-SAFE® Brake.
- ESP® is switched off.
- a loss of tire pressure or a defective tire is detected.

### Information in the Digital Operator's Manual

In the Digital Operator's Manual you will find information on the following topics:

- Switching on Active Blind Spot Assist

## Active Lane Keeping Assist

### General notes

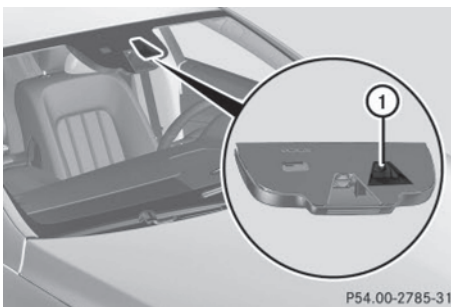

Active Lane Keeping Assist monitors the area in front of your vehicle by means of camera ① at the top of the windshield. Active Lane Keeping Assist detects lane markings on the road and warns you before you leave your lane unintentionally. If you do not react to the warning, a lane-correcting application of the brakes can bring the vehicle back into the original lane.

This function is available in the range between 40 mph and 120 mph (60 km/h and 200 km/h).

For Active Lane Keeping Assist to assist you when driving, the radar sensor system must be operational

### Important safety notes

If you fail to adapt your driving style, Active Lane Keeping Assist can neither reduce the risk of accident nor override the laws of physics. Active Lane Keeping Assist cannot take into account road, weather or traffic conditions. It may not recognize traffic situations. Active Lane Keeping Assist is only an aid. You are responsible for the distance to the vehicle in front, for vehicle speed, for braking in good time and for staying in your lane.

Active Lane Keeping Assist cannot continuously keep your vehicle in its lane.

### WARNING

Active Lane Keeping Assist cannot always clearly detect lane markings.

In such cases, Active Lane Keeping Assist can:

- give an unnecessary warning and then make a course-correcting brake application to the vehicle
- not give a warning or intervene

There is a risk of an accident.

Always pay particular attention to the traffic situation and keep within the lane, especially if Active Lane Keeping Assist alerts you.

Terminate the intervention in a non-critical driving situation.

The system may be impaired or may not function if:

- there is poor visibility, e.g. due to insufficient illumination of the road, or due to snow, rain, fog or spray
- there is glare, e.g. from oncoming traffic, the sun or reflections (e.g. when the road surface is wet)

- the windshield is dirty, fogged up, damaged or covered, for instance by a sticker, in the vicinity of the camera
  - the radar sensors in the front or rear bumpers or the radiator trim are dirty, e.g. obscured by snow
  - there are no, several or unclear lane markings for a lane, e.g. in areas with road construction work
  - the lane markings are worn away, dark or covered up, e.g. by dirt or snow
  - the distance to the vehicle in front is too small and the lane markings thus cannot be detected
  - the lane markings change quickly, e.g. lanes branch off, cross one another or merge
  - the road is narrow and winding
  - there are strong shadows cast on the lane
- If no vehicle is detected in the adjacent lane and broken lane markings are detected, no lane-correcting brake application is made.

#### Warning vibration in the steering wheel

A warning may be given if a front wheel passes over a lane marking. It will warn you by means of intermittent vibration in the steering wheel for up to 1.5 seconds.

#### Lane-correcting brake application

##### WARNING

A lane-correcting brake application cannot always bring the vehicle back into the original lane. There is a risk of an accident.

Always steer, brake or accelerate yourself, especially if Active Lane Keeping Assist warns you or makes a lane-correcting brake application.

##### WARNING

Active Lane Keeping Assist does not detect traffic conditions or road users. In very rare cases, the system may make an inappropriate brake application, e.g. after intentionally driving over a solid lane marking. There is a risk of an accident.

An inappropriate brake application may be interrupted at any time if you steer slightly in the opposite direction. Always make sure that there is sufficient distance on the side for other traffic or obstacles.

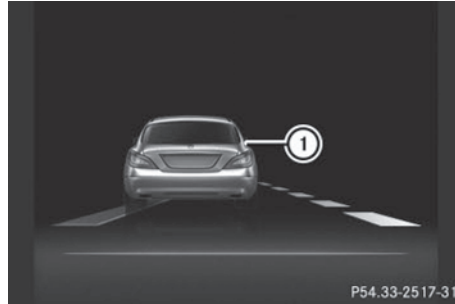

If you leave your lane, under certain circumstances the vehicle will brake briefly on one side. This is meant to assist you in bringing the vehicle back to the original lane. If a lane-correcting brake application occurs, display ① appears in the multifunction display.

A lane-correcting brake application can only be made after driving over a solid, recognizable lane marking. Before this, a warning must be given by means of intermittent vibration in the steering wheel. In addition, a lane with lane markings on both sides must be recognized. The brake application also slightly reduces vehicle speed.

 A further lane-correcting brake application can only occur after your vehicle has returned to the original lane.

No lane-correcting brake application occurs if:

- you clearly and actively steer, brake or accelerate.
- you cut the corner on a sharp bend.
- you have adopted a sporty driving style with high cornering speeds or high rates of acceleration.
- you have switched on the turn signals.

- a driving safety system intervenes, e.g. ESP®, PRE-SAFE® Brake or Active Blind Spot Assist.
- ESP® is switched off.
- the transmission is not in position **D**.
- a loss of tire pressure or a defective tire has been detected and displayed.

There is a possibility that the Active Lane Keeping Assist could misjudge the given traffic situation. An inappropriate brake application may be interrupted at any time if you:

- steer slightly in the opposite direction
- switch on the turn signal
- clearly brake or accelerate

A lane-correcting brake application is interrupted automatically if:

- a driving safety system intervenes, e.g. ESP®, PRE-SAFE® Brake or Active Blind Spot Assist.
- lane markings can no longer be recognized.

### **Information in the Digital Operator's Manual**

In the Digital Operator's Manual you will find information on the following topics:

- Switching on Active Lane Keeping Assist





Useful information .....	160
Important safety notes .....	160
Displays and controls .....	160
Menus and submenus .....	161
Display messages .....	163
Indicator and warning lamps in the instrument cluster .....	174

### Useful information

- i** This Operator's Manual describes all models and all standard and optional equipment of your vehicle available at the time of publication of the Operator's Manual. Country-specific differences are possible. Please note that your vehicle may not be equipped with all features described. This also applies to safety-related systems and functions.
- i** Read the information on qualified specialist workshops: (> page 32).

### Important safety notes

#### WARNING

If you operate information systems and communication equipment integrated in the vehicle while driving, you will be distracted from traffic conditions. You could also lose control of the vehicle. There is a risk of an accident.

Only operate the equipment when the traffic situation permits. If you are not sure that this is possible, park the vehicle paying attention to traffic conditions and operate the equipment when the vehicle is stationary.

#### WARNING

If the instrument cluster has failed or malfunctioned, you may not recognize function restrictions in systems relevant to safety. The operating safety of your vehicle may be impaired. There is a risk of an accident.

Drive on carefully. Have the vehicle checked at a qualified specialist workshop immediately.

You must observe the legal requirements for the country in which you are currently driving when operating the on-board computer.

The on-board computer only shows messages or warnings from certain systems in the

multifunction display. You should therefore make sure your vehicle is operating safely at all times. Otherwise, a vehicle that is not operating safely may cause an accident. For an overview, see the instrument panel illustration (> page 37).

### Displays and controls

#### Information in the Digital Operator's Manual

In the Digital Operator's Manual you will find information on the following topics:

- Coolant temperature display
- Tachometer
- Speedometer with segments
- Multifunction display
- Outside temperature display

#### Operating the on-board computer

##### Overview









- ① Multifunction display
- ② Right control panel
- ③ Switches on the Voice Control System; see the separate operating instructions

- ④ Back button
- ⑤ Left control panel





► **To activate the on-board computer:** turn the SmartKey to position **1** in the ignition lock.

You can control the multifunction display and the settings in the on-board computer using the buttons on the multifunction steering wheel.



### Left control panel

	• Calls up the menu and menu bar
	
	<b>Press briefly:</b>
	<ul style="list-style-type: none"> <li>• Scrolls in lists</li> <li>• Selects a submenu or function</li> <li>• In the <b>Audio</b> menu: selects a stored station, an audio track or a video scene</li> <li>• In the <b>Tel</b> (telephone) menu: switches to the phone book and selects a name or telephone number</li> </ul>
	<b>Press and hold:</b>
	<ul style="list-style-type: none"> <li>• In the <b>Audio</b> menu: selects the previous/next station or selects an audio track or a video scene using rapid scrolling</li> <li>• In the <b>Tel</b> (Telephone) menu: starts rapid scrolling if the phone book is open</li> </ul>
	<ul style="list-style-type: none"> <li>• Confirms a selection/display message</li> <li>• In the <b>Tel</b> (telephone) menu: switches to the telephone book and starts dialing the selected number</li> <li>• In the <b>Audio</b> menu: stops the station search function at the desired station</li> </ul>

### Right control panel



	<ul style="list-style-type: none"> <li>• Rejects or ends a call</li> <li>• Exits phone book/redial memory</li> </ul>
	<ul style="list-style-type: none"> <li>• Makes or accepts a call</li> <li>• Switches to the redial memory</li> </ul>
	• Adjusts the volume
	
	• Mute

### Back button

	<b>Press briefly:</b>
	<ul style="list-style-type: none"> <li>• Back</li> <li>• Switches off the Voice Control System; see the separate operating instructions</li> <li>• Hides display messages/calls up the last <b>Trip</b> menu function used</li> <li>• Exits the telephone book/redial memory</li> </ul>
	<b>Press and hold:</b>
	<ul style="list-style-type: none"> <li>• Calls up the standard display in the <b>Trip</b> menu</li> </ul>

## Menus and submenus

### Menu overview

Press the  or  button on the steering wheel to call up the menu bar and select a menu.

Operating the on-board computer (> page 160).

You can find more information on the individual menus in the Digital Operator's Manual.

Depending on the equipment installed in the vehicle, you can call up the following menus:

- **Trip** menu
- **Navi** menu (navigation details)
- **Audio** menu
- **Tel** menu (telephone)
- **DriveAssist** menu (assistance)
- **Serv.** menu
- **Sett.** menu (settings)
- **AMG** menu in AMG vehicles

## Display messages

### Introduction

#### General notes

This section describes display messages relevant to safety together with their solutions. A description of other messages and their solutions can be found in the Digital Operator's Manual.

Display messages appear in the multifunction display.

Display messages with graphic displays may be shown in simplified form in the Operator's Manual and may therefore differ from the multifunction display.



Please respond in accordance with the display messages and follow the additional notes in this Operator's Manual.

Certain display messages are accompanied by an audible warning tone or a continuous tone.

When the ignition is switched off, all display messages are deleted, apart from some high-priority display messages. Once the causes of the high-priority display messages have been rectified, the corresponding display messages are also deleted.

When you stop and park the vehicle, please observe the notes on the HOLD function (> page 139) and parking (> page 130).

#### Hiding display messages







- ▶ Press the  or  button on the steering wheel to hide the display message. The display message is cleared.

The multifunction display shows high-priority display messages in red. Some high-priority display messages cannot be hidden.

The multifunction display shows these messages continuously until the causes for the messages have been remedied.

#### Message memory

The on-board computer saves certain display messages in the **message memory**. You can call up the display messages:

- ▶ Press the  or  button on the steering wheel to select the **Serv.** menu. If there are display messages, the multifunction display shows **2 Messages**, for example.
- ▶ Press the  or  button to select the entry, e.g. **2 Messages**.
- ▶ Press  to confirm.
- ▶ Press the  or  button to scroll through the display messages.

## Safety systems

## Display messages





Currently  
Unavailable See  
Operator's Manual

## Possible causes/consequences and ► Solutions

ABS (Anti-lock Braking System), ESP® (Electronic Stability Program), BAS (Brake Assist), PRE-SAFE®, the HOLD function and hill start assist are temporarily unavailable.

BAS PLUS and PRE-SAFE® Brake may also have failed.

In addition, the ,  and  warning lamps light up in the instrument cluster.

ATTENTION ASSIST is deactivated.

Possible causes are:

- self-diagnosis is not yet complete.
- the on-board voltage may be insufficient.

 **WARNING**

The brake system continues to function normally, but without the functions listed above. The wheels could therefore lock if you brake hard, for example.

The steerability and braking characteristics may be severely affected. The braking distance in an emergency braking situation can increase.

If ESP® is not operational, ESP® is unable to stabilize the vehicle. There is an increased risk of skidding and an accident.

► Carefully drive a suitable distance, making slight steering movements at a speed above 12 mph (20 km/h).

If the display message disappears, the functions mentioned above are available again.

If the display message continues to be displayed:





- Drive on carefully.
- Visit a qualified specialist workshop.



Inoperative See  
Operator's Manual

ABS, ESP®, BAS, PRE-SAFE®, the HOLD function and hill start assist are unavailable due to a malfunction.





BAS PLUS and PRE-SAFE® Brake may also have failed.

The  (USA only)/ (Canada only), ,  and  warning lamps in the instrument cluster also light up.

ATTENTION ASSIST is deactivated.

 **WARNING**

The brake system continues to function normally, but without the functions listed above. The wheels could therefore lock if you brake hard, for example.

Display messages	Possible causes/consequences and ► Solutions
	<p>The steerability and braking characteristics may be severely affected. The braking distance in an emergency braking situation can increase.</p> <p>If ESP® is not operational, ESP® is unable to stabilize the vehicle. There is an increased risk of skidding and an accident.</p> <ul style="list-style-type: none"> <li>► Drive on carefully.</li> <li>► Visit a qualified specialist workshop immediately.</li> </ul>
<div style="border: 1px solid black; padding: 2px; width: 20px; height: 20px; margin-bottom: 5px;">  </div> <p>Inoperative See Operator's Manual</p>	<p>ESP®, BAS, PRE-SAFE®, the HOLD function and hill start assist are unavailable due to a malfunction.</p> <p>BAS PLUS and PRE-SAFE® Brake may also have failed.</p> <p>In addition, the  and  warning lamps light up in the instrument cluster.</p> <p>The self-diagnosis function might not be complete, for example. ATTENTION ASSIST is deactivated.</p> <p><b> WARNING</b></p> <p>The brake system continues to function normally, but without the functions listed above.</p> <p>The braking distance in an emergency braking situation can thus increase.</p> <p>If ESP® is not operational, ESP® is unable to stabilize the vehicle. There is an increased risk of skidding and an accident.</p> <ul style="list-style-type: none"> <li>► Carefully drive a suitable distance, making slight steering movements at a speed above 12 mph (20 km/h). If the display message disappears, the functions mentioned above are available again.</li> </ul> <p>If the display message continues to be displayed:</p> <ul style="list-style-type: none"> <li>► Drive on carefully.</li> <li>► Visit a qualified specialist workshop.</li> </ul>

## Display messages





Inoperative See  
Operator's Manual

## Possible causes/consequences and ► Solutions

EBD (electronic brake force distribution), ABS, ESP<sup>®</sup>, BAS, PRE-SAFE<sup>®</sup>, the HOLD function and hill start assist are unavailable due to a malfunction.

BAS PLUS and PRE-SAFE<sup>®</sup> Brake may also have failed.

In addition, the ,  and  warning lamps light up in the instrument cluster and a warning tone sounds.



 **WARNING**



The brake system continues to function normally, but without the functions listed above. The front and rear wheels could therefore lock if you brake hard, for example.

The steerability and braking characteristics may be severely affected. The braking distance in an emergency braking situation can increase.

If ESP<sup>®</sup> is not operational, ESP<sup>®</sup> is unable to stabilize the vehicle. There is an increased risk of skidding and an accident.

- Drive on carefully.
- Visit a qualified specialist workshop immediately.

 (USA only)  (Canada only)  
Check Brake Fluid  
Level

There is not enough brake fluid in the brake fluid reservoir. In addition, the  (USA only)/ (Canada only) warning lamp lights up in the instrument cluster and a warning tone sounds.







 **WARNING**

The braking effect may be impaired.

There is a risk of an accident.

- Pull over and stop the vehicle safely as soon as possible, paying attention to road and traffic conditions. Do not continue driving under any circumstances.
- Secure the vehicle against rolling away (► page 130).
- Consult a qualified specialist workshop.
- Do not add brake fluid. This does not correct the malfunction.



Display messages	Possible causes/consequences and ► Solutions
 <p>SRS Malfunction Service Required</p>	<p>There is a malfunction in the SRS (Supplemental Restraint System). The  warning lamp also lights up in the instrument cluster.</p> <p><b>⚠ WARNING</b></p> <p>The air bags or Emergency Tensioning Devices may either be triggered unintentionally or, in the event of an accident, may not be triggered.</p> <p>There is an increased risk of injury.</p> <p>► Visit a qualified specialist workshop.</p> <p>For further information about SRS, see (► page 47).</p>
 <p>Front Left Malfunction Service Required or Front Right Malfunction Service Required</p>	<p>SRS has malfunctioned at the front on the left or right. The  warning lamp also lights up in the instrument cluster.</p> <p><b>⚠ WARNING</b></p> <p>The air bags or Emergency Tensioning Devices may either be triggered unintentionally or, in the event of an accident, may not be triggered.</p> <p>There is an increased risk of injury.</p> <p>► Visit a qualified specialist workshop.</p>
 <p>Rear Left Malfunction Service Required or Rear Right Malfunction Service Required</p>	<p>SRS has malfunctioned at the rear on the left or right. The  warning lamp also lights up in the instrument cluster.</p> <p><b>⚠ WARNING</b></p> <p>The air bags or Emergency Tensioning Devices may either be triggered unintentionally or, in the event of an accident, may not be triggered.</p> <p>There is an increased risk of injury.</p> <p>► Visit a qualified specialist workshop.</p>
 <p>Left Side Curtain Airbag Malfunction Service Required or Right Side Curtain Airbag Malfunction Service Required</p>	<p>There is a malfunction in the left-hand or right-hand window curtain air bag.</p> <p>The  warning lamp also lights up in the instrument cluster.</p> <p><b>⚠ WARNING</b></p> <p>The left or right window curtain air bag may either be triggered unintentionally or, in the event of an accident, may not be triggered.</p> <p>There is an increased risk of injury.</p> <p>► Visit a qualified specialist workshop.</p>

**Display messages**

Front Passenger  
Airbag Disabled  
See Operator's  
Manual

**Possible causes/consequences and ► Solutions**

The front-passenger air bag and front-passenger knee bag are deactivated during the journey, although:

- an adult  
or
- a person larger than a certain size is occupying the front-passenger seat

If additional forces are applied to the seat, the system may interpret the occupant's weight as lower than it actually is.

 **WARNING**

The front-passenger front air bag and front passenger knee bag may not be triggered in the event of an accident.

There is an increased risk of injury.

- Pull over and stop the vehicle safely as soon as possible, paying attention to road and traffic conditions.
- Secure the vehicle against rolling away (▷ page 130).
- Switch the ignition off.
- Have the occupant get out of the vehicle.
- Keep the seat unoccupied, close the front-passenger door and switch on the ignition.
- Observe the PASSENGER AIR BAG OFF indicator lamp in the center console and the multifunction display and check the following:

Seat unoccupied and ignition switched on:

- the PASSENGER AIR BAG OFF indicator lamp must light up and remain lit. If the indicator lamp is on, OCS has disabled the front-passenger air bag and front-passenger knee bag (▷ page 53).
- the [Front Passenger Airbag Enabled See Operator's Manual](#) or [Front Passenger Airbag Disabled See Operator's Manual](#) display messages must not be shown in the multifunction display.
- Wait for a period of at least 60 seconds until the necessary system checks have been completed.
- Make sure that the display messages do not appear in the multifunction display.

If these conditions are fulfilled, the front-passenger seat can be occupied again. Whether the PASSENGER AIR BAG OFF indicator lamp remains lit or goes out depends on how OCS classifies the occupant.

If the conditions are not fulfilled, the system is not operating correctly.

Display messages	Possible causes/consequences and ► Solutions
	<p>► Visit a qualified specialist workshop immediately.</p> <p>For further information about the Occupant Classification System, see (► page 53).</p>
<p>Front Passenger Airbag Enabled See Operator's Manual</p>	<p>The front-passenger air bag and front-passenger knee bag are enabled during the journey, even though:</p> <ul style="list-style-type: none"> <li>• a child, a small adult or an object weighing less than the system's weight threshold is located on the front-passenger seat</li> <li>or</li> <li>• the front-passenger seat is unoccupied</li> </ul> <p>The system may detect objects or forces applying additional weight on the seat.</p> <p><b>⚠ WARNING</b></p> <p>The front-passenger front air bag and front passenger knee bag may be triggered unintentionally.</p> <p>There is an increased risk of injury.</p> <ul style="list-style-type: none"> <li>► Pull over and stop the vehicle safely as soon as possible, paying attention to road and traffic conditions.</li> <li>► Secure the vehicle against rolling away (► page 130).</li> <li>► Switch the ignition off.</li> <li>► Open the front-passenger door.</li> <li>► Remove the child and the child restraint system from the front-passenger seat.</li> <li>► Make sure that there are no objects on the seat adding to the weight.</li> </ul> <p>The system may otherwise detect the additional weight and interpret the seat occupant's weight as greater than it actually is.</p> <ul style="list-style-type: none"> <li>► Keep the seat unoccupied, close the front-passenger door and switch on the ignition.</li> <li>► Observe the PASSENGER AIR BAG OFF indicator lamp in the center console and the multifunction display and check the following:</li> </ul> <p>Seat unoccupied and ignition switched on:</p> <ul style="list-style-type: none"> <li>• the PASSENGER AIR BAG OFF indicator lamp must light up and remain lit. If the indicator lamp is on, OCS (Occupant Classification System) has disabled the front-passenger air bag and front-passenger knee bag (► page 53).</li> <li>• the <a href="#">Front Passenger Airbag Enabled See Operator's Manual</a> or <a href="#">Front Passenger Airbag Disabled See</a></li> </ul>

Display messages	Possible causes/consequences and ► Solutions
	<p data-bbox="461 261 1093 324"><a href="#">Operator's Manual</a> display messages must not be shown in the multifunction display.</p> <ul style="list-style-type: none"> <li data-bbox="439 333 1067 390">► Wait for a period of at least 60 seconds until the necessary system checks have been completed.</li> <li data-bbox="439 399 1056 456">► Make sure that the display messages do not appear in the multifunction display.</li> </ul> <p data-bbox="439 465 1102 582">If these conditions are fulfilled, the front-passenger seat can be occupied again. Whether the PASSENGER AIR BAG OFF indicator lamp remains lit or goes out depends on how OCS classifies the occupant.</p> <p data-bbox="439 591 1058 648">If the conditions are not fulfilled, the system is not operating correctly.</p> <ul style="list-style-type: none"> <li data-bbox="439 657 964 686">► Visit a qualified specialist workshop immediately.</li> </ul> <p data-bbox="439 695 1102 756">For further information about the Occupant Classification System, see (► page 53).</p>

## Engine

## Display messages



Coolant Too Hot  
Stop Vehicle Turn  
Engine Off

## Possible causes/consequences and ► Solutions

The coolant is too hot.  
A warning tone also sounds.

 **WARNING**



Do not drive when your engine is overheated. This can cause some fluids which may have leaked into the engine compartment to catch fire.

Steam from the overheated engine can also cause serious burns which can occur just by opening the hood.



There is a risk of injury.



- Pull over and stop the vehicle safely and switch off the engine, paying attention to road and traffic conditions.
- Secure the vehicle against rolling away (▷ page 130).
- Wait until the engine has cooled down.
- Make sure that the air supply to the engine radiator is not blocked, e.g. by snow, slush or ice.
- Do not start the engine again until the display message goes out and the coolant temperature is below 248 °F (120 °C). Otherwise, the engine could be damaged.
- Pay attention to the coolant temperature display.
- If the temperature increases again, visit a qualified specialist workshop immediately.

Under normal operating conditions and with the specified coolant level, the coolant temperature may rise to 248 °F (120 °C).

Tires	
Display messages	Possible causes/consequences and ► Solutions
<p>Check Tire Pressure Soon</p>	<p>The tire pressure loss warning system has detected a significant loss in pressure. A warning tone also sounds.</p> <p> <b>WARNING</b></p> <p>With tire pressures which are too low, there is a risk of the following hazards:</p> <ul style="list-style-type: none"> <li>• they may burst, especially as the load and vehicle speed increase.</li> <li>• they may wear excessively and/or unevenly, which may greatly impair tire traction.</li> <li>• the driving characteristics, as well as steering and braking, may be greatly impaired.</li> </ul> <p>There is a risk of an accident.</p> <ul style="list-style-type: none"> <li>► Stop the vehicle without making any sudden steering or braking maneuvers. Pay attention to the traffic conditions as you do so.</li> <li>► Secure the vehicle against rolling away (▷ page 130).</li> <li>► Check the tires and, if necessary, follow the instructions for a flat tire (▷ page 228).</li> <li>► Check the tire pressures and, if necessary, correct the tire pressure.</li> <li>► Restart the tire pressure loss warning system when the tire pressure is correct (▷ page 248).</li> </ul>
<p>Check Tires</p>	<p>The tire pressure in one or more tires has dropped significantly. The wheel position is displayed in the multifunction display. A warning tone also sounds.</p> <p> <b>WARNING</b></p> <p>With tire pressures which are too low, there is a risk of the following hazards:</p> <ul style="list-style-type: none"> <li>• they may burst, especially as the load and vehicle speed increase.</li> <li>• they may wear excessively and/or unevenly, which may greatly impair tire traction.</li> <li>• the driving characteristics, as well as steering and braking, may be greatly impaired.</li> </ul> <p>There is a risk of an accident.</p> <ul style="list-style-type: none"> <li>► Stop the vehicle without making any sudden steering or braking maneuvers. Pay attention to the traffic conditions as you do so.</li> <li>► Secure the vehicle against rolling away (▷ page 130).</li> </ul>

Display messages	Possible causes/consequences and ► Solutions
	<ul style="list-style-type: none"> <li>▶ Check the tires and, if necessary, follow the instructions for a flat tire (▷ page 228).</li> <li>▶ Check the tire pressure (▷ page 249).</li> <li>▶ If necessary, correct the tire pressure.</li> </ul>
<p>Warning Tire Malfunction</p>	<p>The tire pressure in one or more tires has dropped suddenly. The wheel position is shown in the multifunction display.</p> <p> <b>WARNING</b></p> <p>If you drive with a flat tire, there is a risk of the following hazards:</p> <ul style="list-style-type: none"> <li>• a flat tire affects the ability to steer or brake the vehicle.</li> <li>• you could lose control of the vehicle.</li> <li>• continued driving with a flat tire will cause excessive heat build-up and possibly a fire.</li> </ul> <p>There is a risk of an accident.</p> <ul style="list-style-type: none"> <li>▶ Stop the vehicle without making any sudden steering or braking maneuvers. Pay attention to the traffic conditions as you do so.</li> <li>▶ Secure the vehicle against rolling away (▷ page 130).</li> <li>▶ Check the tires and, if necessary, follow the instructions for a flat tire (▷ page 228).</li> </ul>

Vehicle	
Display messages	Possible causes/consequences and ► Solutions
	<p>The hood is open. A warning tone also sounds.</p> <p> <b>WARNING</b></p> <p>The open hood may block your view when the vehicle is in motion. There is a risk of an accident.</p> <ul style="list-style-type: none"> <li>▶ Pull over and stop the vehicle safely as soon as possible, paying attention to road and traffic conditions.</li> <li>▶ Secure the vehicle against rolling away (▷ page 130).</li> <li>▶ Close the hood.</li> </ul>
 <p>Rear Left Backrest Not Latched or Rear Right Backrest Not Latched</p>	<p>The backrest in the rear is not engaged on the left-hand and/or right-hand side. A warning tone also sounds.</p> <ul style="list-style-type: none"> <li>▶ Push the backrest back until it engages.</li> </ul>

Display messages	Possible causes/consequences and ► Solutions
 <p>Front Left Backrest Not Latched or Front Right Backrest Not Latched</p>	<p>The driver's or front passenger's seat backrest is not engaged. A warning tone also sounds.</p> <ul style="list-style-type: none"> <li>► Push the backrest back until it engages.</li> </ul>
 <p>Power Steering Malfunction See Operator's Manual</p>	<p>The power steering is malfunctioning. A warning tone also sounds.</p> <p> <b>WARNING</b></p> <p>You will need to use more force to steer. There is a risk of an accident.</p> <ul style="list-style-type: none"> <li>► Check whether you are able to apply the extra force required.</li> <li>► <b>If you are able to steer safely:</b> carefully drive on to a qualified specialist workshop.</li> <li>► <b>If you are unable to steer safely:</b> do not drive on. Contact the nearest qualified specialist workshop.</li> </ul>

## Indicator and warning lamps in the instrument cluster



### General notes

This section describes indicator and warning lamps in the instrument cluster relevant to safety and solutions. A description of other indicator and warning lamps in the instrument cluster and their solutions can be found in the Digital Operator's Manual.











## Safety



## Seat belts









Problem	Possible causes/consequences and ► Solutions
 <p>After starting the engine, the red seat belt warning lamp lights up. In addition, a warning tone sounds for up to six seconds.</p>	<p>The driver's seat belt is not fastened.</p> <ul style="list-style-type: none"> <li>► Fasten your seat belt (▷ page 62). The warning tone ceases.</li> </ul>
 <p>The red seat belt warning lamp lights up after the engine starts, as soon as the driver's or the front-passenger door is closed.</p>	<p>The driver or front passenger has not fastened their seat belt.</p> <ul style="list-style-type: none"> <li>► Fasten your seat belt (▷ page 62). The warning lamp goes out.</li> </ul> <p>There are objects on the front-passenger seat.</p> <ul style="list-style-type: none"> <li>► Remove the objects from the front-passenger seat and stow them in a secure place. The warning lamp goes out.</li> </ul>
 <p>The red seat belt warning lamp flashes and an intermittent audible warning sounds.</p>	<p>The driver or front passenger has not fastened their seat belt. You are driving faster than 15 mph (25 km/h) or have briefly driven faster than 15 mph (25 km/h).</p> <ul style="list-style-type: none"> <li>► Fasten your seat belt (▷ page 62). The warning lamp goes out and the intermittent warning tone ceases.</li> </ul> <p>There are objects on the front-passenger seat. You are driving faster than 15 mph (25 km/h) or have briefly driven faster than 15 mph (25 km/h).</p> <ul style="list-style-type: none"> <li>► Remove the objects from the front-passenger seat and stow them in a secure place. The warning lamp goes out and the intermittent warning tone ceases.</li> </ul>





## Safety systems



Problem	Possible causes/consequences and ► Solutions
<p> (USA only)   (Canada only)</p> <p>The red brake system warning lamp comes on while the engine is running. A warning tone also sounds.</p>	<p> <b>WARNING</b></p> <p>The brake boosting effect is malfunctioning and the braking characteristics may be affected.  There is a risk of an accident.</p> <ul style="list-style-type: none"> <li>► Pull over and stop the vehicle safely as soon as possible, paying attention to road and traffic conditions. Do not continue driving under any circumstances.</li> <li>► Secure the vehicle against rolling away (▷ page 130).</li> <li>► Consult a qualified specialist workshop.</li> <li>► Observe the additional display messages in the multifunction display.</li> </ul>
<p> (USA only)   (Canada only)</p> <p>The red brake system warning lamp comes on while the engine is running. A warning tone also sounds.</p>	<p>There is not enough brake fluid in the brake fluid reservoir.</p> <p> <b>WARNING</b></p> <p>The braking effect may be impaired.  There is a risk of an accident.</p> <ul style="list-style-type: none"> <li>► Pull over and stop the vehicle safely as soon as possible, paying attention to road and traffic conditions. Do not continue driving under any circumstances.</li> <li>► Secure the vehicle against rolling away (▷ page 130).</li> <li>► Do not add brake fluid. Adding more will not remedy the malfunction.</li> <li>► Consult a qualified specialist workshop.</li> <li>► Observe the additional display messages in the multifunction display.</li> </ul>



Problem	Possible causes/consequences and ► Solutions
 <p>The yellow ABS warning lamp is lit while the engine is running.</p>	<p>ABS (Anti-lock Braking System) is deactivated due to a malfunction. BAS (Brake Assist), BAS PLUS, ESP® (Electronic Stability Program), PRE-SAFE®, PRE-SAFE® Brake, the HOLD function and hill start assist are therefore also deactivated, for example.</p> <p>ATTENTION ASSIST is deactivated.</p> <p> <b>WARNING</b></p> <p>The brake system continues to function normally, but without the functions listed above. The wheels could therefore lock if you brake hard, for example.</p> <p>The steerability and braking characteristics may be severely affected. The braking distance in an emergency braking situation can increase.</p> <p>If ESP® is not operational, ESP® is unable to stabilize the vehicle. There is an increased risk of skidding and an accident.</p> <ul style="list-style-type: none"> <li>► Observe the additional display messages in the multifunction display.</li> <li>► Drive on carefully.</li> <li>► Visit a qualified specialist workshop.</li> </ul> <p>If the ABS control unit is faulty, there is also a possibility that other systems, such as the navigation system or the automatic transmission, will not be available.</p>

Problem	Possible causes/consequences and ► Solutions
 <p>The yellow ABS warning lamp is lit while the engine is running.</p>	<p>ABS is temporarily unavailable. BAS, BAS PLUS, ESP<sup>®</sup>, EBD (electronic brake force distribution), PRE-SAFE<sup>®</sup>, PRE-SAFE<sup>®</sup> Brake, the HOLD function, hill start assist are therefore also deactivated, for example.</p> <p>Possible causes are:</p> <ul style="list-style-type: none"> <li>• self-diagnosis is not yet complete.</li> <li>• the on-board voltage may be insufficient.</li> </ul> <p>ATTENTION ASSIST is deactivated.</p> <p> <b>WARNING</b></p> <p>The brake system continues to function normally, but without the functions listed above. The front and rear wheels could therefore lock if you brake hard, for example.</p> <p>The steerability and braking characteristics may be severely affected. The braking distance in an emergency braking situation can increase.</p> <p>If ESP<sup>®</sup> is not operational, ESP<sup>®</sup> is unable to stabilize the vehicle. There is a risk of an accident.</p> <p>► Carefully drive a suitable distance, making slight steering movements at a speed above 12 mph (20 km/h). The functions mentioned above are available again when the warning lamp goes out.</p> <p>If the warning lamp is still on:</p> <ul style="list-style-type: none"> <li>► Observe the additional display messages in the multifunction display.</li> <li>► Drive on carefully.</li> <li>► Visit a qualified specialist workshop.</li> </ul>

Problem	Possible causes/consequences and ► Solutions
 <p>The yellow ABS warning lamp is lit while the engine is running. A warning tone also sounds.</p>	<p>EBD is not available due to a malfunction. Therefore, ABS, BAS, BAS PLUS, ESP<sup>®</sup>, PRE-SAFE<sup>®</sup>, PRE-SAFE<sup>®</sup> Brake, the HOLD function and hill start assist are also unavailable, for example. ATTENTION ASSIST is deactivated.</p> <p> <b>WARNING</b></p> <p>The brake system continues to function normally, but without the functions listed above. The front and rear wheels could therefore lock if you brake hard, for example.</p> <p>The steerability and braking characteristics may be severely affected. The braking distance in an emergency braking situation can increase.</p> <p>If ESP<sup>®</sup> is not operational, ESP<sup>®</sup> is unable to stabilize the vehicle. There is an increased risk of skidding and an accident.</p> <ul style="list-style-type: none"> <li>► Observe the additional display messages in the multifunction display.</li> <li>► Drive on carefully.</li> <li>► Visit a qualified specialist workshop.</li> </ul>
<p> (USA only)</p> <p> (Canada only)</p> <p>  </p> <p>The red brake warning lamp, the yellow ESP<sup>®</sup> and ESP<sup>®</sup> OFF warning lamps and the yellow ABS warning lamp are lit while the engine is running.</p>	<p>ABS and ESP<sup>®</sup> are not available due to a malfunction. Therefore, BAS, BAS PLUS, EBD, PRE-SAFE<sup>®</sup>, PRE-SAFE<sup>®</sup> Brake, the HOLD function and hill start assist, for example, are not available either. ATTENTION ASSIST is deactivated.</p> <p> <b>WARNING</b></p> <p>The brake system continues to function normally, but without the functions listed above. The front and rear wheels could therefore lock if you brake hard, for example.</p> <p>The steerability and braking characteristics may be severely affected. The braking distance in an emergency braking situation can increase.</p> <p>If ESP<sup>®</sup> is not operational, ESP<sup>®</sup> is unable to stabilize the vehicle. There is an increased risk of skidding and an accident.</p> <ul style="list-style-type: none"> <li>► Observe the additional display messages in the multifunction display.</li> <li>► Drive on carefully.</li> <li>► Visit a qualified specialist workshop.</li> </ul>



Problem	Possible causes/consequences and ► Solutions
 <p>The yellow ESP<sup>®</sup> warning lamp flashes while the vehicle is in motion.</p>	<p>ESP<sup>®</sup> or traction control has intervened because there is a risk of skidding or at least one wheel has started to spin. Cruise control or DISTRONIC PLUS is deactivated.</p> <ul style="list-style-type: none"> <li>► When pulling away, only depress the accelerator pedal as far as necessary.</li> <li>► Ease off the accelerator pedal while the vehicle is in motion.</li> <li>► Adapt your driving style to suit the road and weather conditions.</li> <li>► Do not deactivate ESP<sup>®</sup>.</li> </ul> <p>For exceptions, see: (▷ page 75).</p>
 <p>The yellow ESP<sup>®</sup> OFF warning lamp is lit while the engine is running.</p>	<p>ESP<sup>®</sup> is deactivated.</p> <p> <b>WARNING</b></p> <p>If ESP<sup>®</sup> is switched off, ESP<sup>®</sup> is unable to stabilize the vehicle. There is an increased risk of skidding and an accident.</p> <ul style="list-style-type: none"> <li>► Reactivate ESP<sup>®</sup>.</li> </ul> <p>For exceptions, see: (▷ page 75).</p> <ul style="list-style-type: none"> <li>► Adapt your driving style to suit the road and weather conditions.</li> </ul> <p>If ESP<sup>®</sup> cannot be activated:</p> <ul style="list-style-type: none"> <li>► Drive on carefully.</li> <li>► Have ESP<sup>®</sup> checked at a qualified specialist workshop.</li> </ul>
 <p>AMG vehicles only: The yellow SPORT handling mode warning lamp is lit while the engine is running.</p>	<p>SPORT handling mode is activated.</p> <p> <b>WARNING</b></p> <p>When SPORT handling mode is switched on, ESP<sup>®</sup> is unable to stabilize the vehicle. There is an increased risk of skidding and an accident.</p> <ul style="list-style-type: none"> <li>► Only switch to SPORT handling mode in accordance with the conditions described in the "Activating/deactivating SPORT handling mode" section (▷ page 76).</li> </ul>

Problem	Possible causes/consequences and ► Solutions
 <p>The yellow ESP<sup>®</sup> and ESP<sup>®</sup> OFF warning lamps are lit while the engine is running.</p>	<p>ESP<sup>®</sup>, BAS, BAS PLUS, PRE-SAFE<sup>®</sup>, PRE-SAFE<sup>®</sup> Brake, the HOLD function and hill start assist are not available due to a malfunction. ATTENTION ASSIST is deactivated.</p> <p> <b>WARNING</b></p> <p>The brake system continues to function normally, but without the functions listed above.</p> <p>The braking distance in an emergency braking situation can thus increase.</p> <p>If ESP<sup>®</sup> is not operational, ESP<sup>®</sup> is unable to stabilize the vehicle. There is an increased risk of skidding and an accident.</p> <ul style="list-style-type: none"><li>► Observe the additional display messages in the multifunction display.</li><li>► Drive on carefully.</li><li>► Visit a qualified specialist workshop.</li></ul>



Problem	Possible causes/consequences and ► Solutions
 <p>The yellow ESP<sup>®</sup> and ESP<sup>®</sup> OFF warning lamps are lit while the engine is running.</p>	<p>ESP<sup>®</sup>, BAS, PRE-SAFE<sup>®</sup>, the HOLD function and hill start assist are temporarily unavailable.            BAS PLUS and PRE-SAFE<sup>®</sup> Brake may also have failed.            ATTENTION ASSIST is deactivated.            Self-diagnosis is not yet complete.</p> <p><b>⚠ WARNING</b></p> <p>The brake system continues to function normally, but without the functions listed above.            The braking distance in an emergency braking situation can thus increase.            If ESP<sup>®</sup> is not operational, ESP<sup>®</sup> is unable to stabilize the vehicle. There is an increased risk of skidding and an accident.</p> <p>► Carefully drive a suitable distance, making slight steering movements at a speed above 12 mph (20 km/h).            The functions mentioned above are available again when the warning lamp goes out.</p> <p>If the warning lamp is still on:</p> <ul style="list-style-type: none"> <li>► Observe the additional display messages in the multifunction display.</li> <li>► Drive on carefully.</li> <li>► Visit a qualified specialist workshop.</li> </ul>
 <p>The red SRS warning lamp is lit while the engine is running.</p>	<p>There is a malfunction in the SRS (Supplemental Restraint System).</p> <p><b>⚠ WARNING</b></p> <p>The air bags or Emergency Tensioning Devices may either be triggered unintentionally or, in the event of an accident, may not be triggered.            There is an increased risk of injury.</p> <ul style="list-style-type: none"> <li>► Observe the additional display messages in the multifunction display.</li> <li>► Drive on carefully.</li> <li>► Have SRS checked at a qualified specialist workshop immediately.</li> </ul> <p>For further information about SRS, see (► page 47).</p>







## Engine

Problem	Possible causes/consequences and ► Solutions
 <p>The red coolant warning lamp comes on while the engine is running. A warning tone also sounds.</p>	<p>The coolant temperature has exceeded 248 °F (120 °C). The airflow to the engine radiator may be blocked or the coolant level may be too low.</p> <p> <b>WARNING</b></p> <p>The engine is not being cooled sufficiently and may be damaged. Do not drive when your engine is overheated. This can cause some fluids which may have leaked into the engine compartment to catch fire.</p> <p>Steam from the overheated engine can also cause serious burns which can occur just by opening the hood.</p> <p>There is a risk of injury.</p> <ul style="list-style-type: none"> <li>► Observe the additional display messages in the multifunction display.</li> <li>► Pull over and stop the vehicle safely and switch off the engine, paying attention to road and traffic conditions.</li> <li>► Secure the vehicle against rolling away (► page 130).</li> <li>► Leave the vehicle and keep a safe distance from the vehicle until the engine has cooled down.</li> <li>► Check the coolant level and add coolant, observing the warning notes (► page 223).</li> <li>► If you need to add coolant more often than usual, have the engine coolant system checked.</li> <li>► Make sure that the air supply to the engine radiator is not blocked, e.g. by snow, slush or ice.</li> <li>► At coolant temperatures under 248 °F (120 °C), drive to the next qualified specialist workshop.</li> <li>► Avoid subjecting the engine to heavy loads, e.g. driving in mountainous terrain, and stop-and-go traffic.</li> </ul>

## Driving systems

Problem	Possible causes/consequences and ► Solutions
 <p>The red distance warning lamp lights up while the vehicle is in motion.</p>	<p>The distance to the vehicle in front is too small for the speed selected.</p> <ul style="list-style-type: none"> <li>► Increase the distance.</li> </ul>
 <p>The red distance warning lamp lights up while the vehicle is in motion. A warning tone also sounds.</p>	<p>You are approaching a vehicle or a stationary obstacle in your line of travel at too high a speed.</p> <ul style="list-style-type: none"> <li>► Be prepared to brake immediately.</li> <li>► Pay careful attention to the traffic situation. You may have to brake or take evasive action.</li> </ul> <p>Further information on PRE-SAFE® Brake (&gt; page 78).</p>

Tires	
Problem	Possible causes/consequences and ► Solutions
 The yellow tire pressure monitor warning lamp (pressure loss/malfunction) is lit.	<p>The tire pressure monitor has detected a loss of pressure in at least one of the tires.</p> <p> <b>WARNING</b></p> <p>With tire pressures which are too low, there is a risk of the following hazards:</p> <ul style="list-style-type: none"> <li>• they may burst, especially as the load and vehicle speed increase.</li> <li>• they may wear excessively and/or unevenly, which may greatly impair tire traction.</li> <li>• the driving characteristics, as well as steering and braking, may be greatly impaired.</li> </ul> <p>There is a risk of an accident.</p> <ul style="list-style-type: none"> <li>► Stop the vehicle without making any sudden steering or braking maneuvers. Pay attention to the traffic conditions as you do so.</li> <li>► Secure the vehicle against rolling away (▷ page 130).</li> <li>► Observe the additional display messages in the multifunction display.</li> <li>► Check the tires and, if necessary, follow the instructions for a flat tire (▷ page 228).</li> <li>► Check the tire pressure (▷ page 249).</li> <li>► If necessary, correct the tire pressure.</li> </ul>
 The yellow tire pressure monitor warning lamp (pressure loss/malfunction) flashes for approximately one minute and then remains lit.	<p>The tire pressure monitor is faulty.</p> <p> <b>WARNING</b></p> <p>The system is possibly unable to recognize or register low tire pressure.</p> <p>There is a risk of an accident.</p> <ul style="list-style-type: none"> <li>► Observe the additional display messages in the multifunction display.</li> <li>► Visit a qualified specialist workshop.</li> </ul>



Useful information .....	188
General notes .....	188
Important safety notes .....	188
Declarations of conformity .....	189
Information on copyright .....	189
Function restrictions .....	190
COMAND operating system .....	190
Online and Internet functions .....	198

### Useful information

- i** These operating instructions describe all the standard and optional equipment of your COMAND system, as available at the time of going to print. Country-specific differences are possible. Please note that your COMAND system may not be equipped with all the features described. This also applies to safety-related systems and functions.
- i** Read the information on qualified specialist workshops: (> page 32).

### General notes

The COMAND section in these operating instructions describes the basic principles for operating your COMAND and the online and Internet functions. More information can be found in the Digital Operator's Manual.

The COMAND section in these operating instructions describes the basic principles for operating your COMAND. More information can be found in the Digital Operator's Manual.

### Important safety notes

#### WARNING

Modifications to electronic components, their software as well as wiring can impair their function and/or the function of other networked components. In particular, systems relevant to safety could also be affected. As a result, these may no longer function as intended and/or jeopardize the operating safety of the vehicle. There is an increased risk of an accident and injury.

Never tamper with the wiring as well as electronic components or their software. You should have all work to electrical and electronic equipment carried out at a qualified specialist workshop.

If you make any changes to the vehicle electronics, the general operating permit is rendered invalid.

#### WARNING

If you operate information systems and communication equipment integrated in the vehicle while driving, you will be distracted from traffic conditions. You could also lose control of the vehicle. There is a risk of an accident.

Only operate the equipment when the traffic situation permits. If you are not sure that this is possible, park the vehicle paying attention to traffic conditions and operate the equipment when the vehicle is stationary.

You must observe the legal requirements for the country in which you are currently driving when operating COMAND.

COMAND calculates the route to the destination without taking account of the following, for example:

- traffic lights
- stop and give way signs
- merging lanes
- parking or stopping in a no parking/no stopping zone
- other road and traffic rules and regulations
- narrow bridges

COMAND can give incorrect navigation commands if the actual street/traffic situation does not correspond with the digital map's data. Digital maps do not cover all areas nor all routes in an area. For example, a route may have been diverted or the direction of a one-way street may have changed.

For this reason, you must always observe road and traffic rules and regulations during your journey. Road and traffic rules and regulations always have priority over the system's driving recommendations.

Navigation announcements are intended to direct you while driving without diverting your attention from the road and driving.

Please always use this feature instead of consulting the map display for directions. Looking at the icons or map display can distract you from traffic conditions and driving, and increase the risk of an accident. Bear in mind that at a speed of only 30 mph (approximately 50 km/h) your vehicle covers a distance of 44 feet (approximately 14 m) per second.

This equipment complies with FCC radiation exposure limits set forth for uncontrolled equipment and meets the FCC radio frequency (RF) Exposure Guidelines in Supplement C to OET65.

This equipment has very low levels of RF energy that is deemed to comply without maximum permissive exposure evaluation (MPE). But it is desirable that it should be installed and operated with at least 8 inches (20 cm) and more between the radiator and a person's body (excluding extremities: hands, wrists, feet and legs.)

### Declarations of conformity

#### Vehicle components which receive and/or transmit radio waves

**i USA only:** The wireless devices of this vehicle comply with Part 15 of the FCC Rules. Operation is subject to the following two conditions:

- 1) These devices may not cause interference, and
- 2) These devices must accept any interference, including interference that may cause undesired operation of the device.

Changes or modifications not expressly approved by the party responsible for compliance could void the user's authority to operate the equipment.

**i Canada only:** The wireless devices of this vehicle comply with Industry Canada license-exempt RSS standard(s). Operation is subject to the following two conditions:

- 1) These devices may not cause interference, and
- 2) These devices must accept any interference, including interference that may cause undesired operation of the device.

### Information on copyright

#### General information

Information on licenses for free and Open Source software used in your vehicle and in the electronic components can be found on this website: <http://www.mercedes-benz.com/opensource>.

#### Registered trademarks

Registered trademarks:

- Bluetooth® is a registered trademark of Bluetooth® SIG Inc.
- DTS is a registered trademark of DTS, Inc.
- Dolby and MLP are registered trademarks of DOLBY Laboratories.
- BabySmart™, ESP® and PRE-SAFE® are registered trademarks of Daimler AG.
- HomeLink® is a registered trademark of Prince.
- iPod® and iTunes® are registered trademarks of Apple Inc.
- Logic7® is a registered trademark of Harman International Industries.
- Microsoft® and Windows media® are registered trademarks of Microsoft Corporation.
- SIRIUS is a registered trademark of Sirius XM Radio Inc.
- HD Radio is a registered trademark of iBiquity Digital Corporation.

- Gracenote® is a registered trademark of Gracenote, Inc.
- ZAGATSurvey® and related brands are registered trademarks of ZagatSurvey, LLC.

### Function restrictions

For safety reasons, some COMAND functions are restricted or unavailable while the vehicle is in motion. You will notice this, for example because either you will not be able to select certain menu items or COMAND will display a message to this effect.

- the system settings
- the online and Internet functions
- the Digital Operator's Manual

You can call up the main functions:

- using the corresponding function buttons
- using the main function bar in the COMAND display
- using the remote control

## COMAND operating system

### Overview



- ① COMAND display (▷ page 191)
- ② COMAND control panel with a single DVD drive or DVD changer
- ③ COMAND controller (▷ page 196)

You can use COMAND to operate the following main functions:

- the navigation system
- the audio function
- the telephone function
- the video function



## COMAND display

## Display overview



Example display for radio

①	Status bar	Shows the time and the current settings for telephone operation.
②	Calls up the audio menu	Highlights the active Audio main function. The triangle indicates that this main function has a selectable submenu.
③	Main function bar	You can call up the desired main function from the main function bar. When the main function is activated, it is identifiable by the white lettering.
④	Display/selection window	Shows the content of the active Audio main function in radio mode.
⑤	Radio menu bar	Shows the other functions of the active Audio main function in radio mode.

## Menu overview

Navi	Audio	Telephone	Video	System	Symbol 
Route settings	FM/AM radio (using HD Radio™)	Telephone	Video DVD	Calls up the system menu	Calls up the Digital Operator's Manual
Map settings	Satellite radio	Address book	Aux		Calls up COMAND and Internet
Personal points of interest	Disc				Calls up the weather service SIRIUS Weather
Messages (street name announcements, acoustic information during calls, audio fadeout, reserve fuel level)	Memory Card				Calls up the Mercedes-Benz Mobile website
<input checked="" type="checkbox"/> Activates/deactivates alternative routes	MUSIC REGISTER				
Avoids an area	USB storage device				
SIRIUS service	Bluetooth Audio				
Map version	Media Interface				
	Aux				

## System menu overview

System	Time	SplitView	Consumption	Seat	Display off
Display settings	<input checked="" type="checkbox"/> Switches the automatic time settings on/off	Operates COMAND functions from the passenger side	Calls up the fuel consumption display	Changes the driver/ front-passenger seat settings	Switches off the display
Text reader speed	Sets the time zone				
Voice-operated control settings	Switches to summer time				
Rear view camera	Manual time setting				
Language	Sets the time/date format				
Favorites button					
Activates/ deactivates Bluetooth®					
Automatic volume adjustment					
Imports/exports data					
Resets COMAND					
 Delete your personal data using this function, for example before selling your vehicle.					

**If equipped with the rear view camera:** when the function is activated and COMAND is switched on, the image from the rear view camera is automatically shown in the COMAND display when reverse gear is engaged.

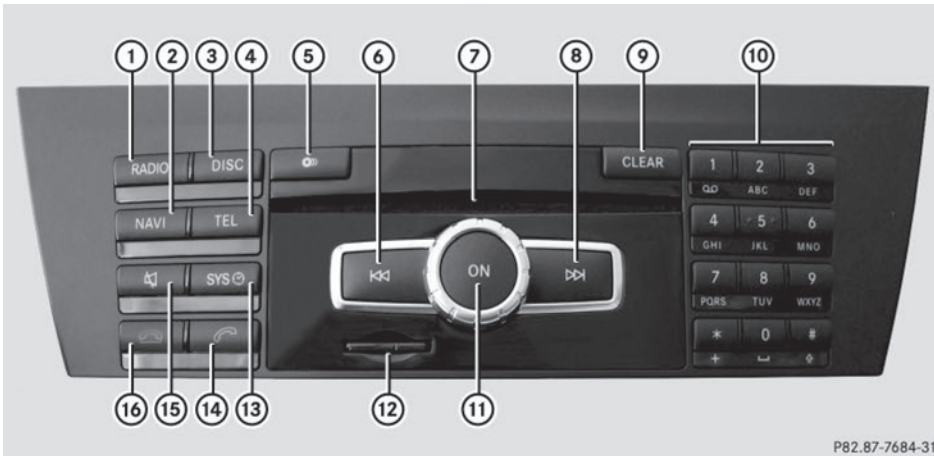

**i** If the 360° Camera menu item is displayed, **Display Off** can be called up under System.

COMAND control panel



P82.87-7684-31

	Function	Page
①	Switches to radio mode Switches wavebands Switches to satellite radio	
②	Switches to navigation mode Shows the menu system	
③	Press <b>Disc</b> repeatedly <ul style="list-style-type: none"> <li>• Switches to the audio CD, audio DVD and MP3 mode</li> <li>• Switches to memory card mode</li> <li>• Switches to MUSIC REGISTER</li> <li>• Switches to USB storage device mode</li> <li>• Switches to Media Interface or audio AUX mode</li> <li>• Switches to Bluetooth® audio mode</li> </ul>	
④	Calls up the telephone basic menu: <ul style="list-style-type: none"> <li>• Telephony via the Bluetooth® interface</li> </ul>	

	Function	Page
⑤	Load/eject button  Single DVD drive  DVD changer	
⑥	Selects stations via the station search function Rewinds Selects the previous track	
⑦	Disc slot <ul style="list-style-type: none"> <li>• Loads CDs/DVDs</li> <li>• Ejects CDs/DVDs</li> <li>• Updates the digital map</li> </ul>	
⑧	Selects stations via the station search function Fast forward Selects the next track	
⑨	Clear button <ul style="list-style-type: none"> <li>• Deletes characters</li> <li>• Deletes an entry</li> </ul>	

	Function	Page
⑩	Number pad <ul style="list-style-type: none"> <li>• Selects stations via the station presets</li> <li>• Stores stations manually</li> <li>• Mobile phone authorization</li> <li>• Telephone number entry</li> <li>• Sends DTMF tones</li> <li>• Character entry</li> <li>• Selects a location for the weather forecast from the memory</li> </ul> # Displays the current track being played * Selects stations by entering the frequency manually * Selects a track	
⑪	Switches COMAND on/off Adjusts the volume	

	Function	Page
⑫	SD memory card slot	
⑬	Calls up the system menu	
⑭	Accepts a call Dials a number Redials Accepts a waiting call	
⑮	Switches the sound on or off Switches the hands-free microphone on/off Cancels the text message read-aloud function Switches off navigation announcements	
⑯	Rejects a call Ends an active call Rejects a waiting call	

## COMAND controller

### Overview



#### ① COMAND controller

You can use the COMAND controller to select the menu items in the COMAND display.

You can:



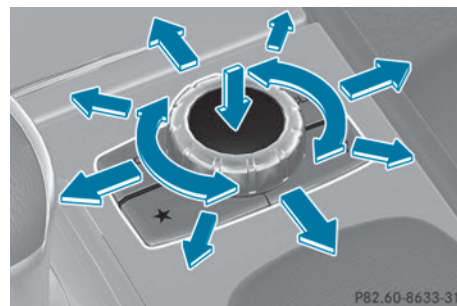

- call up menus or lists
- scroll within menus or lists and
- exit menus or lists

### Operation







Example: operating the COMAND controller

The COMAND controller can be:

- pressed briefly or pressed and held 
- turned clockwise or counter-clockwise 
- slid left or right 
- slid forwards or backwards 
- slid diagonally 

### Example of operation

In the instructions, operating sequences are described as follows:

- ▶ Press the **RADIO** button.  
Radio mode is activated.
- ▶ Select **Radio** by sliding  and turning  the COMAND controller and press  to confirm.
- ▶ Confirm **Station List** by pressing .  
The station list appears.

### Buttons on the COMAND controller

#### Overview

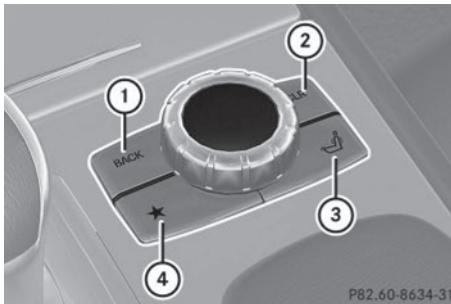

- ① Back button (▷ page 197)
- ② Clear button (▷ page 197)
- ③ Seat function button
- ④ Favorites button

**i** If your vehicle is not equipped with the seat function button, it features two favorites buttons.

**i** For AMG vehicles: the COMAND Controller is configured with buttons ① and ②.

### Back button

You can use the **BACK** button to exit a menu or to call up the basic display of the current operating mode.

- ▶ **To exit the menu:** briefly press the **BACK** back button.  
COMAND changes to the next higher menu level in the current operating mode.
- ▶ **To call up the basic display:** press and hold the **BACK** back button.  
COMAND changes to the basic display of the current operating mode.

### Clear button

- ▶ **To delete individual characters:** briefly press the **CLR** clear button.
- ▶ **To delete an entire entry:** press and hold the **CLR** clear button.

### Seat function button

You can use the  button to call up the following seat functions:

- Multicontour seat (with 4-way lumbar support)
- Active multicontour seat (dynamic seat and massage function)
- Balance (seat heating distribution)

### Favorites button

You can assign predefined functions to the  favorites button and call them up by pressing the button.

## Online and Internet functions

### Information in the Digital Operator's Manual

In the Digital Operator's Manual you will find information on the following topics:

- Online and Internet functions
- Google™ local search
- Destination/route download
- Weather display
- Internet

### General notes

#### Conditions for access

To use COMAND Mercedes-Benz Apps and Internet access, the following conditions must be fulfilled:

- mbrace is activated and operational
- mbrace is activated for COMAND Mercedes-Benz Apps and Internet access

**Priority of connections:** an emergency call has the highest priority. When a service call, e.g. a breakdown service call or the MB Info Call, is active, an emergency call can still be initiated.

A service call, on the other hand, has priority over a current Internet connection. Therefore, you cannot establish an Internet connection during a service call.

- i** The availability of individual COMAND Mercedes-Benz Apps may vary depending on the country.
- i** The terms of use are shown when COMAND is used for the first time and then once a year thereafter. Only read and accept the terms of use when the vehicle is stationary.
- i** Internet pages cannot be shown on the driver's side while the vehicle is in motion.

## Establishing/ending the connection

### Establishing the connection



Preconditions for establishing a connection can be found under "General notes" (▷ page 198).

- ▶ **Option 1:** select the icon in the main function bar by turning the COMAND controller and press to confirm. The carousel view appears.
- ▶ Turn or slide the COMAND controller until the **Mercedes-Benz Apps** panel or a favorite is brought to the front, if these have been previously created.
- ▶ **Option 2:** enter a web address (▷ page 200).



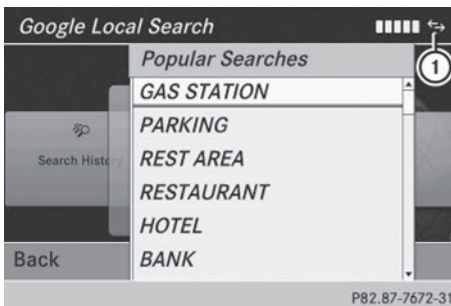
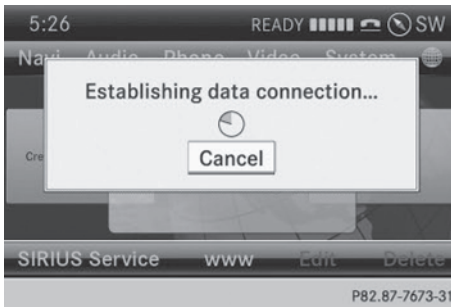

▶ For both options, press the COMAND controller.  
The Internet connection is established. An active Internet connection is identified with symbol ①. The example shows the menu in the Google™ Local Search function.

▶ **To cancel the connection:** while the connection is being established, confirm **Cancel** by pressing .

or

▶ Press the button on COMAND or on the multifunction steering wheel.

### Ending the connection

You cannot end the connection yourself. The Internet connection is automatically terminated if the system does not recognize any user input within a five-minute time period.

The button is inoperative.

## Internet radio

### General notes

A good Internet connection is required to transmit audio data efficiently. To ensure the best-possible reception, your mobile phone should be connected to the vehicle's exterior antenna via the phone bracket (optional).

Bear in mind that a relatively large volume of data can be transmitted when using the Internet radio. An average 128 kbit per second data transfer rate can transfer 56 MB of data in one hour.

The data transfer rate of a station is displayed while receiving data.

### Calling up the Internet radio



▶ Select the icon in the main function bar by sliding and turning the COMAND controller and press to confirm.

The carousel view appears.



▶ Bring the **Internet Radio** panel to the front by turning the COMAND controller and press to confirm. The Internet radio menu appears.

### Searching for stations

- ▶ Select **Search** in the Internet radio menu. A list with search criteria appears.
- ▶ Select criterion and press to confirm.



- i** For example as a search criterion, you can set an Internet radio station that is located close to your navigation destination.

### Connecting to a station



- ▶ Search for a station (> page 199).
- ▶ Select  (play) in the Internet radio menu and press  to confirm. The call is placed.

If the data stream is interrupted, an automatic attempt is made to re-establish the connection.

Manually re-establishing a connection

- ▶ Select  (play) again in the Internet radio menu and press  to confirm.

Ending data transfer:

- ▶ Select  (stop) in the Internet radio menu and press  to confirm.

or

- ▶ Change to another audio source, for example **Disc**.

If you change to a main function that is not an audio source, e.g. navigation, the data connection remains on. You can continue listening to the set station.

## Internet



### Display restriction

Internet pages cannot be shown while the vehicle is in motion.

### Calling up a website

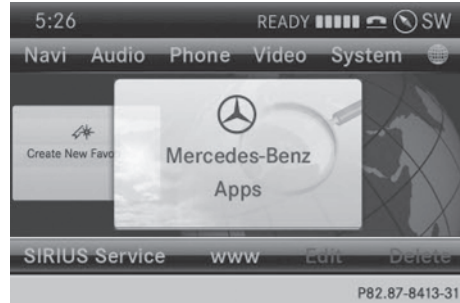
#### Calling up the carousel view





- ▶ Select the  symbol in the main function bar by turning  the COMAND controller and press  to confirm. The carousel view appears.

You can now enter a web address.





#### Entering a web address



You can enter the web address using either the character bar or the number keypad.

- ▶ Select **www** by sliding  and turning  the COMAND controller and press  to confirm. An input menu appears.
- ▶ **To enter using the character bar:** enter the web address in the input line. As soon as the first letter has been entered in the input line, a list appears below it. The list shows web addresses which begin with the letters you have entered and web addresses which have already been called up.







The list is empty the first time you call it up.

- ▶ After entering the web address, select the  symbol by sliding  and turning  the COMAND controller and press  to confirm.

The website is called up.

## Navigating the website

### Overview

Action	Result
▶ Turn  the controller.	Navigates from one item that can be selected (e.g. link, text field or selection list) to the next and highlights the respective element on the website.
Sliding the controller: ▶ Left or right  ▶ Up or down  ▶ Diagonally 	Moves the pointer on the page.
▶ Press  the controller.	Calls up the menu or opens the selected item.
▶ Press  .	Calls up the previous page.
▶ Press  .	Closes the Internet browser. If several windows are open, the current window is closed.



Useful information .....	204
Stowage areas .....	204
Features .....	208

### Useful information

- i** This Operator's Manual describes all models and all standard and optional equipment of your vehicle available at the time of publication of the Operator's Manual. Country-specific differences are possible. Please note that your vehicle may not be equipped with all features described. This also applies to safety-related systems and functions.
- i** Read the information on qualified specialist workshops: (▷ page 32).

### Stowage areas

#### Loading guidelines

##### WARNING

If objects, luggage or loads are not secured or not secured sufficiently, they could slip, tip over or be flung around and thereby hit vehicle occupants. There is a risk of injury, particularly in the event of sudden braking or a sudden change in direction.

Always store objects so that they cannot be flung around. Secure objects, luggage or loads against slipping or tipping before the journey.

##### WARNING

Combustion engines emit poisonous exhaust gases such as carbon monoxide. Exhaust gases can enter the vehicle interior if the trunk lid is open when the engine is running, especially if the vehicle is in motion. There is a risk of poisoning.

Always switch off the engine before opening the trunk lid. Never drive with the trunk lid open.

The handling characteristics of a laden vehicle are dependent on the distribution of the load within the vehicle. For this reason, you should observe the following notes when transporting a load:

- Never exceed the maximum permissible gross vehicle weight or the gross axle weight rating of the vehicle (including occupants). The values are specified on the vehicle identification plate on the B-pillar of the driver's door.
- The trunk is the preferred place to carry objects.
- Position heavy loads as far forwards as possible and as low down in the trunk as possible.
- The load must not protrude above the upper edge of the seat backrests.
- Always place the load against the rear or front seat backrests. Make sure that the seat backrests are securely locked into place.
- Always place the load behind unoccupied seats if possible.
- Use the cargo tie down rings and the parcel nets to transport loads and luggage.
- Use cargo tie-down rings and fastening materials appropriate for the weight and size of the load.
- Secure the load with sufficiently strong and wear-resistant tie-downs. pad sharp edges for protection.

### Stowage space

#### Important safety notes

##### WARNING

If you do not correctly store objects in the vehicle interior, they can slip or be flung around, thus striking vehicle occupants. There is a risk of injury, especially when braking or abruptly changing directions.

- Always store objects so that they cannot be flung around in these or in similar situations.
- Always make sure that objects do not protrude from stowage compartments, parcel nets or stowage nets.
- Close lockable stowage compartments while driving.
- Stow and secure objects that are heavy, hard, pointy, sharp-edged, fragile or too large in the trunk.

Observe the loading guidelines (▷ page 204).

### Information in the Digital Operator's Manual

In the Digital Operator's Manual you will find information on the following topics:

- Glove box
- Eyeglasses compartment
- Stowage compartments in the center console
- Stowage compartment under the armrest
- Stowage compartment under the front seats
- Stowage compartment in the rear seat armrest

### Stowage nets

Stowage nets are located in the front-passenger footwell and on the right-hand side of the trunk.

Observe the loading guidelines (▷ page 204) and the safety notes regarding stowage spaces (▷ page 204).

### Rear bench seat through-loading feature

#### Important safety notes

#### WARNING

If the rear bench seat/rear seat and seat backrest are not engaged they could fold forwards, e.g. when braking suddenly or in the event of an accident.

- The vehicle occupant would thereby be pushed into the seat belt by the rear bench seat/rear seat or by the seat backrest. The seat belt can no longer offer the intended level of protection and could even cause injuries.
- Objects or loads in the trunk cannot be restrained by the seat backrest.

There is an increased risk of injury.

Before every trip, make sure that the seat backrests and the rear bench seat/rear seat are engaged.

Observe the loading guidelines (▷ page 204). The left-hand and right-hand rear seat backrests can be folded down separately to increase the trunk capacity.

#### Folding the seat backrest forward

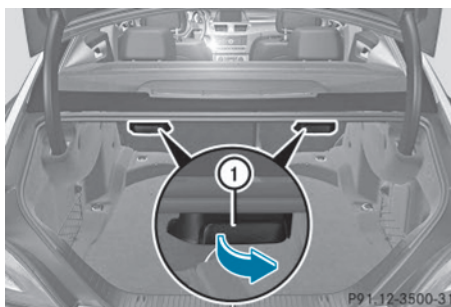

- i** Vehicles with memory function: when you fold one or both parts of the rear seat backrest forwards, the respective front seat moves forward slightly, when necessary, in order to avoid contact.

- ▶ Vehicles without memory function: if necessary, move the driver's or front-passenger seat forwards.
- ▶ Open the trunk.
- ▶ Pull right-hand or left-hand rear seat backrest release handle ①. The corresponding rear seat backrest is released.

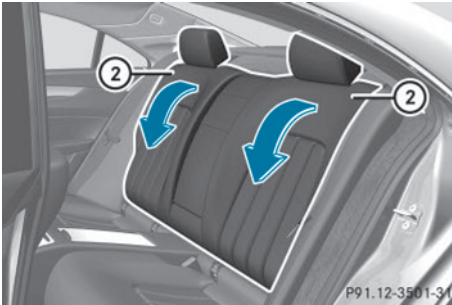

- ▶ Fold rear seat backrest ② forwards.
- ▶ Move the driver's or front-passenger seat back if necessary.

### Folding the seat backrest back

- ! Make sure that the seat belt does not become trapped when folding the rear seat backrest back. Otherwise, it could be damaged.

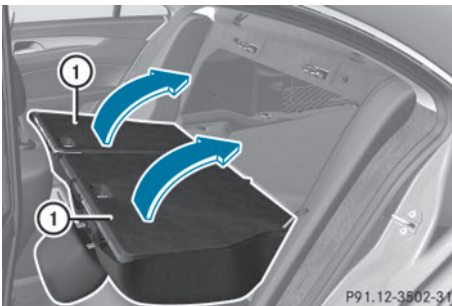

- ▶ Move the driver's or front-passenger seat forward if necessary.
- ▶ Fold rear seat backrest ① back until it engages. If the rear seat backrest is not engaged and locked, this will be shown in the

multifunction display in the instrument cluster. A warning tone also sounds.

- ▶ Move the driver's or front-passenger seat back if necessary.

- i You should always engage the rear seat backrests if you do not need the through-loading feature. This will prevent unauthorized access to the trunk from the vehicle interior.

## Securing cargo

### Cargo tie-down rings

#### General notes

Observe the following notes on securing loads:

- Observe the loading guidelines (▷ page 204).
- Secure the load using the cargo tie-down rings.
- Distribute the load on the cargo tie-down rings evenly.
- Do not use elastic straps or nets to secure a load, as these are only intended as an anti-slip protection for light loads.
- Do not route tie-downs across sharp edges or corners.
- Pad sharp edges for protection.

### Trunk

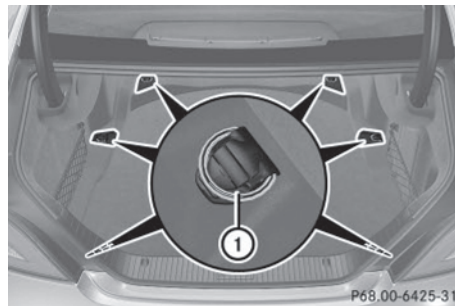

Cargo tie down rings ①.



### Bag hook

**⚠ WARNING**

The bag hooks cannot restrain heavy objects or items of luggage. Objects or items of luggage could be flung around and thereby hit vehicle occupants when braking or abruptly changing directions. There is a risk of injury. Only hang light objects on the bag hooks. Never hang hard, sharp-edged or fragile objects on the bag hooks.

**!** The bag hook can bear a maximum load of 6.6lbs (3kg) and should not be used to secure a load.

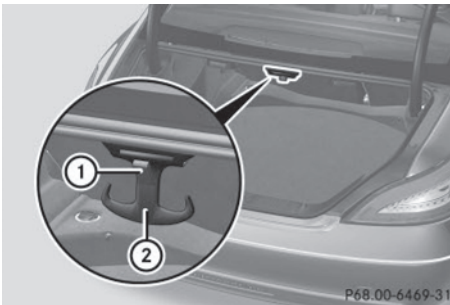

▶ Pull bag hook ② down by tab ①.

### Stowage well under the trunk floor

**!** Unhook the handle before again before closing the trunk lid and clip it in securely to prevent the handle flap from protruding. Otherwise, you could damage the handle.



The TIREFIT kit, the vehicle tool kit, etc. are located in the stowage compartment.

▶ **To open:** pull handle ① up.

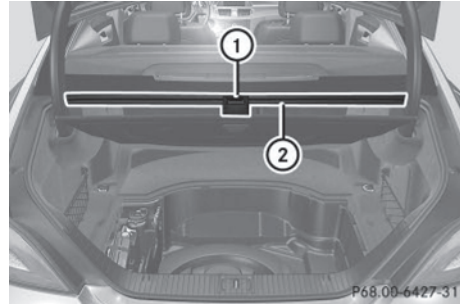

▶ Hook handle ① into rain trough ②.

### Roof carrier

#### Important safety notes

**⚠ WARNING**

When you load the roof, the center of gravity of the vehicle rises and the driving characteristics change. If you exceed the maximum roof load, the driving characteristics, as well as steering and braking, will be greatly impaired. There is a risk of an accident.

Never exceed the maximum roof load and adjust your driving style.

**!** Mercedes-Benz recommends that you only use roof carriers that have been tested and approved for Mercedes-Benz vehicles. This helps to prevent damage to the vehicle.

Position the load on the roof carrier in such a way that the vehicle will not sustain damage even when it is in motion.

Ensure that, depending on the vehicle's equipment, you can raise the sliding sunroof fully and open the trunk lid fully when the roof carrier is installed.

**!** To avoid damaging or scratching the covers, do not use metallic or hard objects to open them.

The maximum roof load is 220 lbs(100 kg). An incorrectly secured roof carrier or roof load may become detached from the vehicle. You must therefore ensure that you observe the roof carrier manufacturer's installation instructions.

## Stowage and features

### Attaching the roof carrier

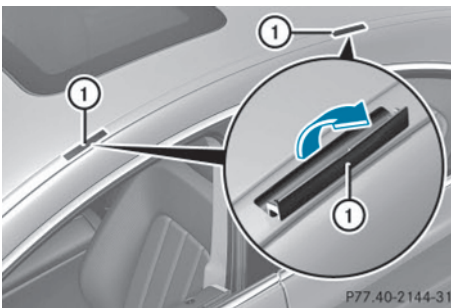

- ▶ Open covers ① carefully in the direction of the arrow.
- ▶ Only secure the roof carrier to the anchorage points under covers ①.
- ▶ Observe the manufacturer's installation instructions.

### Features

#### Information in the Digital Operator's Manual

In the Digital Operator's Manual you will find information on the following topics:

- Cup holders
- Bottle holder
- Rear window roller sunblind
- Ashtray
- Cigarette lighter
- 12 V sockets

### Sun visors

#### Overview

#### **⚠ WARNING**

If the mirror cover of the vanity mirror is folded up when the vehicle is in motion, you could be blinded by incident light. There is a risk of an accident.

Always keep the mirror cover folded down while driving.

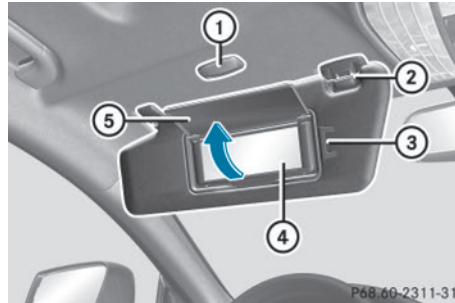

- ① Mirror light
- ② Bracket
- ③ Retaining clip, e.g. for a car park ticket
- ④ Vanity mirror
- ⑤ Mirror cover

#### Information in the Digital Operator's Manual

In the Digital Operator's Manual you will find information on the following topics:

- Vanity mirror in the sun visor
- Glare from the side

### mbrace

#### Information in the Digital Operator's Manual

In the Digital Operator's Manual you will find information on the following topics:

- Downloading destinations in COMAND
- Search and Send

- Vehicle remote opening
- Vehicle remote closing
- Stolen vehicle recovery service
- Vehicle remote malfunction diagnosis
- Downloading routes
- Speed alert
- Geo fencing
- Triggering the vehicle alarm

### General notes

You must have a license agreement to activate the mbrace service. Make sure that your system is activated and operational. To log in, press the  MB Info call button. If any of the steps mentioned are not carried out, the system may not be activated.

If you have questions about the activation, contact one of the following telephone hotlines:

- **USA:** Mercedes-Benz Customer Assistance Center at  
1-800-FOR-MERcedes (1-800-367-6372)  
or 1-866-990-9007
- **Canada:** Customer Service at  
1-888-923-8367

Shortly after successfully registering with the service, a user ID and password will be sent to you by post.

USA only: you can use this password to log onto the mbrace area under "Owners Online" at <http://www.mbusa.com>.



The system is available if:

- it has been activated and is operational
- the corresponding mobile phone network is available for transmitting data to the Customer Center
- a service subscription is available
- the starter battery is sufficiently charged

-  Determining the location of the vehicle on a map is only possible if:
  - GPS reception is available.
  - the vehicle position can be forwarded to the Customer Assistance Center.

### The mbrace system

To adjust the volume during a call, proceed as follows:

- ▶ Press the  or  button on the multifunction steering wheel.

or

- ▶ Use the volume controller of the audio system/COMAND.

The system offers various services, e.g.:



- Automatic and manual emergency call
- Roadside Assistance call
- MB Info call



USA only: you can find information and a description of all available features under "Owners Online" at <http://www.mbusa.com>.

### System self-test

After you have switched on the ignition, the system carries out a self-diagnosis.

A malfunction in the system has been detected if one of the following occurs:

- The indicator lamp in the SOS button does not come on during the system self-test.
- The indicator lamp in the  Roadside Assistance button does not light up during self-diagnosis of the system.
- The indicator lamp in the  MB Info call button does not light up during self-diagnosis of the system.

- The indicator lamp in one or more of the following buttons continues to light up red after the system self-diagnosis:
  - SOS button
  -  Roadside Assistance call button
  -  MB Info call button
- After the system self-diagnosis, the **Inoperative** or **Service Not Activated** message appears in the multifunction display.

If a malfunction is indicated as outlined above, the system may not operate as expected. In the event of an emergency, help will have to be summoned by other means.

Have the system checked at the nearest authorized Mercedes-Benz Center or contact the following service hotlines:

- **USA:** Mercedes-Benz Customer Assistance Center at 1-800-FOR-MERCEdes (1-800-367-6372) or 1-866-990-9007
- **Canada:** Customer Service at 1-888-923-8367

## Emergency call

### Important safety notes

#### WARNING

It can be dangerous to remain in the vehicle, even if you have pressed the SOS button in an emergency if:

- you see smoke inside or outside of the vehicle, e.g. if there is a fire after an accident
- the vehicle is on a dangerous section of road
- the vehicle is not visible or cannot easily be seen by other road users, particularly when dark or in poor visibility conditions

There is a risk of an accident and injury.

Leave the vehicle immediately in this or similar situations as soon as it is safe to do so. Move to a safe location along with other vehicle occupants. In such situations, secure

the vehicle in accordance with national regulations, e.g. with a warning triangle.

You must have a license agreement to activate the mbrace service. Make sure that your system is activated and operational. To register, press the  MB Info call button. If any of the steps mentioned are not carried out, the system may not be activated.

If you have questions about the activation, contact one of the following telephone hotlines:

- **USA:** Mercedes-Benz Customer Assistance Center at 1-800-FOR-MERCEdes (1-800-367-6372) or 1-866-990-9007
- **Canada:** Customer Service at 1-888-923-8367

### General notes

An emergency call is dialed automatically if an air bag or Emergency Tensioning Device is triggered.

-  You cannot end an automatically triggered emergency call yourself.

An emergency call can also be initiated manually.

As soon as the emergency call has been initiated, the indicator lamp in the SOS button flashes. The multifunction display shows the **Connecting Call** message.

The audio output is muted.

Once the connection has been made, the **Call Connected** message appears in the multifunction display.

All important information on the emergency is transmitted, for example:

- Current location of the vehicle (as determined by the GPS system)
- Vehicle identification number
- Information on the severity of the accident

Shortly after the emergency call has been initiated, a voice connection is automatically established between the Customer Assistance Center and the vehicle occupants.

- If the vehicle occupants respond, the Mercedes-Benz Customer Assistance Center attempts to get more information on the emergency.
- If there is no response from the vehicle occupants, an ambulance is immediately sent to the vehicle.

If no voice connection can be established to the Mercedes-Benz Customer Assistance Center, the system has been unable to initiate an emergency call.

This can occur, for example, if the relevant mobile phone network is not available. The indicator lamp in the SOS button flashes continuously.

The **Call Failed** message appears in the multifunction display and must be confirmed. In this case, summon assistance by other means.

### Making an emergency call

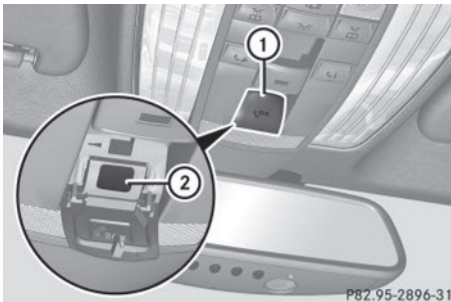

- ▶ **To initiate an emergency call manually:** press cover ① briefly to open.
  - ▶ Press SOS button ② briefly. The indicator lamp in SOS button ② flashes until the emergency call is concluded.
  - ▶ Wait for a voice connection to the Mercedes-Benz Customer Assistance Center.
  - ▶ After the emergency call, close cover ①.
- i** If the mobile phone network is unavailable, mbrace will not be able to make the emergency call. If you leave the

vehicle immediately after pressing the SOS button, you will not know whether mbrace placed the emergency call. In this case, always summon assistance by other means.

### Roadside Assistance button

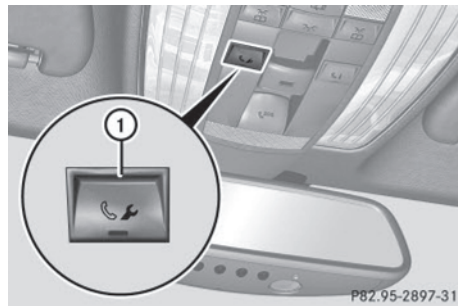

- ▶ Press Roadside Assistance button ①. This initiates a call to the Mercedes-Benz Customer Assistance Center. The indicator lamp in Roadside Assistance button ① flashes while the call is active. The multifunction display shows the **Connecting Call** message. The audio output is muted.

If a connection can be made, the **Call Connected** message appears in the multifunction display.

If a mobile phone network and GPS reception are available, the system transfers data to the Mercedes-Benz Customer Assistance Center, for example:

- Current location of the vehicle
- Vehicle identification number

- i** The COMAND display indicates that a call is active. During the call, you can change to the navigation menu by pressing the NAVI button on COMAND, for example. Voice output is not available.

A voice connection is established between the Mercedes-Benz Customer Assistance Center and the vehicle occupants.

From the vehicle remote malfunction diagnosis, the Mercedes-Benz Customer Assistance Center can ascertain the nature of the problem. Information on the vehicle remote malfunction diagnosis can be found in the Digital Operator's Manual.

The Mercedes-Benz Customer Assistance Center either sends a qualified Mercedes-Benz technician or makes arrangements for your vehicle to be transported to the nearest authorized Mercedes-Benz Center.

You may be charged for services such as repair work and/or towing.

Further details are available in your mbrace manual.

**i** The system has not been able to initiate a roadside assistance call, if:

- the indicator lamp for Roadside Assistance call button ① is flashing continuously.
- no voice connection to the Mercedes-Benz Customer Assistance Center was established.

This can occur if the relevant mobile phone network is not available, for example.

The **Call Failed** message appears in the multifunction display.

► **To end a call:** press the  button on the multifunction steering wheel.

or

► Press the corresponding button for ending a phone call on COMAND.

## MB Info call button

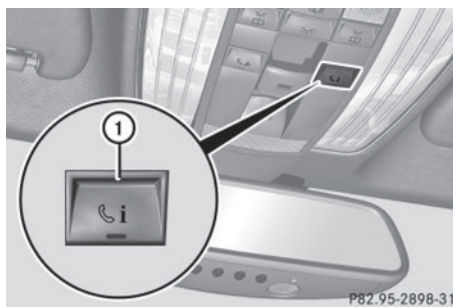

► Press MB Info call button ①.

This initiates a call to the Mercedes-Benz Customer Assistance Center.

The indicator lamp in MB Info call button ① flashes while the connection is being made. The multifunction display shows the **Connecting Call** message. The audio system is muted.

If a connection can be made, the **Call Connected** message appears in the multifunction display.

If a mobile phone network and GPS reception are available, the system transfers data to the Mercedes-Benz Customer Assistance Center, for example:

- Current location of the vehicle
- Vehicle identification number

**i** The COMAND display indicates that a call is active. During the call, you can change to the navigation menu by pressing the NAVI button on COMAND, for example.

Voice output is not available.

A voice connection is established between the Mercedes-Benz Customer Assistance Center and the vehicle occupants.

You receive information about operating your vehicle, about the nearest authorized Mercedes-Benz Center and about other products and services from Mercedes-Benz. USA only: you can find further information on the mbrace system under "Owners Online" at <http://www.mbusa.com>.

**i** The system has not been able to initiate an MB Info call, if:

- the indicator lamp in MB Info call button  is flashing continuously.
- no voice connection to the Mercedes-Benz Customer Assistance Center was established.

This can occur if the relevant mobile phone network is not available, for example.

The **Call Failed** message appears in the multifunction display.

▶ **To end a call:** press the  button on the multifunction steering wheel.

or

▶ Press the corresponding button for ending a phone call on COMAND.

### Call priority

When service calls are active, e.g. Roadside Assistance or MB Info calls, an emergency call can still be initiated. In this case, an emergency call will take priority and override all other active calls.

The indicator lamp of the respective button flashes until the call is ended.

An emergency call can only be terminated by the Mercedes-Benz Customer Assistance Center.

All other calls can be ended by pressing:

- the  button on the multifunction steering wheel
- or the corresponding COMAND button for ending a telephone call

**i** When a call is initiated, the audio system is muted. The mobile phone is no longer connected to COMAND. However, if you want to use your mobile phone, do so only when the vehicle is stationary and in a safe location.

### Garage door opener

#### General notes

The HomeLink® garage door opener integrated in the rear-view mirror allows you to operate up to three different door and gate systems.

Use the integrated garage door opener only on garage doors that:

- have safety stop and reverse features and
- meet current U.S. federal safety standards

Once programmed, the integrated garage door opener in the rear-view mirror will assume the function of the garage door system's remote control. Please also read the operating instructions for the garage door system.

When programming a garage door opener, park the vehicle outside the garage. Do not run the engine while programming.

Certain garage door drives are incompatible with the integrated garage door opener. If you have difficulty programming the integrated garage door opener, contact an authorized Mercedes-Benz Center.

Alternatively, you can call the following telephone assistance services:

- **USA:** Mercedes-Benz Customer Assistance Center at 1-800-FOR-MERcedes
- **Canada:** Customer Service at 1-800-387-0100
- HomeLink® hotline 1-800-355-3515 (free of charge)

More information on HomeLink® and/or compatible products is also available online at <http://www.homelink.com>.

Notes on the declaration of conformity (> page 31).

USA: FCC ID: CB2HMIHL4

Canada: IC: 279B-HMIHL4

### Important safety notes

#### WARNING

When you operate or program the garage door with the integrated garage door opener, persons in the range of movement of the garage door can become trapped or struck by the garage door. There is a risk of injury.

When using the integrated garage door opener, always make sure that nobody is within the range of movement of the garage door.

#### WARNING

Combustion engines emit poisonous exhaust gases such as carbon monoxide. Inhaling these exhaust gases leads to poisoning. There is a risk of fatal injury. Therefore never leave the engine running in enclosed spaces without sufficient ventilation.

### Programming

#### Programming buttons

Pay attention to the "Important safety notes" (▷ page 214).

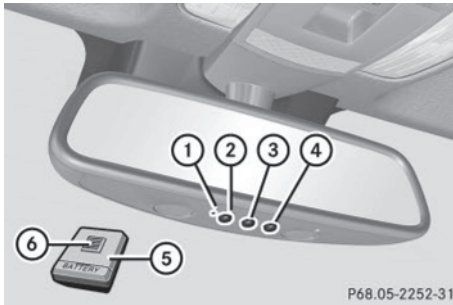

Integrated garage door opener in the rear-view mirror

Garage door remote control ⑤ is not included with the integrated garage door opener.

- ▶ Turn the SmartKey to position 2 in the ignition lock (▷ page 121).
- ▶ Select one of buttons ② to ④ to use to control the garage door drive.

- ▶ **To start programming mode:** press and hold one of buttons ② to ④ of the integrated garage door opener.

The garage door opener is now in programming mode. After a short time, indicator lamp ① lights up yellow.

- ▶ Release button ②, ③ or ④. Indicator lamp ① flashes yellow.

- i** Indicator lamp ① lights up yellow as soon as button ②, ③ or ④ is programmed for the first time. If the selected button has already been programmed, indicator lamp ① will only light up yellow after ten seconds have elapsed.

- ▶ **To program the remote control:** point garage door remote control ⑤ towards buttons ② to ④ on the rear-view mirror at a distance of 2 to 8 inches (5 to 20 cm).

- ▶ Press and hold button ⑥ on remote control ⑤ until indicator lamp ① lights up green. When indicator lamp ① lights up green: programming is finished.

When indicator lamp ① flashes green: programming was successful. The next step is to synchronize the rolling code.

- ▶ Release button ⑥ on remote control ⑤ for the garage door drive system. If indicator lamp ① lights up red: repeat the programming procedure for the corresponding button on the rear-view mirror. When doing so, vary the distance between remote control ⑤ and the rear-view mirror.

- i** The required distance between remote control ⑤ and the integrated garage door opener depends on the garage door drive system. Several attempts might be necessary. You should test every position for at least 25 seconds before trying another position.

#### Synchronizing the rolling code

Pay attention to the "Important safety notes" (▷ page 214).



If the garage door system uses a rolling code, you will also have to synchronize the garage door system with the integrated garage door opener in the rear-view mirror. To do this you will need to use the programming button on the door drive control panel. The programming button may be placed at different locations depending on the manufacturer. It is usually located on the door drive unit on the garage ceiling.

Familiarize yourself with the garage door drive operating instructions, e.g. under "Programming of additional remote controls", before carrying out the following steps.

Your vehicle must be within reach of the garage door or exterior gate drive. Make sure that neither your vehicle nor any persons/objects are present within the sweep of the door or gate.

- ▶ Turn the SmartKey to position **2** in the ignition lock (▷ page 121).
- ▶ Get out of the vehicle.
- ▶ Press the programming button on the door drive unit.
- i** Usually, you now have 30 seconds to initiate the next step.
- ▶ Get into the vehicle.
- ▶ Press previously programmed button **②**, **③** or **④** of the integrated garage door opener until the door closes.  
The rolling code synchronization is then complete.

### Notes on programming the remote control

Canadian radio frequency laws require a "break" (or interruption) of the transmission signals after broadcasting for a few seconds. Therefore, these signals may not last long enough for the integrated garage door opener. The signal is not recognized during programming. Comparable with Canadian law, some U.S. garage door openers also feature a "break".

Proceed as follows:

- if you live in Canada
- if you have difficulties programming the garage door opener (regardless of where you live) when using the programming steps
- ▶ Press and hold one of buttons **②** to **④** on the integrated garage door opener.  
After a short time, indicator lamp **①** lights up yellow.
- ▶ Release the button.  
Indicator lamp **①** flashes yellow.
- ▶ Press button **⑥** of garage door remote control **⑤** for two seconds, then release it for two seconds.
- ▶ Press button **⑥** again for two seconds.
- ▶ Repeat this sequence on button **⑥** of remote control **⑤** until indicator lamp **①** lights up green.  
When indicator lamp **①** lights up green: programming is finished.  
When indicator lamp **①** flashes green: programming was successful. The next step is to synchronize the rolling code.
- ▶ Release button **⑥** of remote control **⑤** of the garage door drive.  
If indicator lamp **①** blinks red: repeat the programming process for the corresponding button on the rear-view mirror. When doing so, vary the distance between remote control **⑤** and the rear-view mirror.
- i** The required distance between remote control **⑤** and the integrated garage door opener depends on the garage door drive system. Several attempts might be necessary. You should test every position for at least 25 seconds before trying another position.

### Problems when programming

If you are experiencing problems programming the integrated garage door opener on the rear-view mirror, take note of the following instructions:

- Check the transmitter frequency used by garage door drive remote control ⑤ and whether it is supported. The transmitter frequency can usually be found on the back of the garage door drive remote control. The integrated garage door opener is compatible with devices that have units which operate in the frequency range of 280 to 433 MHz.
- Replace the batteries in garage door remote control ⑤. This increases the likelihood that garage door remote control ⑤ will transmit a strong and precise signal to the integrated garage door opener in the rear-view mirror.
- When programming, hold remote control ⑤ at varying distances and angles from the button that you are programming. Try various angles at a distance between 2 and 12 inches (5 to 30 cm) or at the same angle but at varying distances.
- If another remote control for the same garage door drive is available, repeat the same programming steps with this remote control. Before performing these steps, make sure that new batteries have been installed in garage door drive remote control ⑤.
- Note that some remote controls only transmit for a limited amount of time (the indicator lamp on the remote control goes out). Press button ⑥ on remote control ⑤ again before transmission ends.
- Align the antenna cable of the garage door opener unit. This can improve signal reception/transmission.

### Opening/closing the garage door

After it has been programmed, the integrated garage door opener performs the function of the garage door system remote control. Please also read the operating instructions for the garage door system.

- ▶ Turn the SmartKey to position **2** in the ignition lock (▷ page 121).
  - ▶ Press button ②, ③ or ④ which you have programmed to operate the garage door.
    - Garage door system with a fixed code: indicator lamp ① lights up green.
    - Garage door system with a rolling code: indicator lamp ① flashes green.
- i** The transmitter will transmit a signal as long as the button is pressed. The transmission is halted after a maximum of ten seconds and indicator lamp ① lights up yellow. Press button ②, ③ or ④ again if necessary.

### Clearing the memory

Make sure that you clear the memory of the integrated garage door opener before selling the vehicle.

- ▶ Turn the SmartKey to position **2** in the ignition lock (▷ page 121).
- ▶ Press and hold buttons ② and ④. The indicator lamp initially lights up yellow and then green.
- ▶ Release buttons ② and ④. The memory of the integrated garage door opener in the rear-view mirror is cleared.

### Floormats

#### WARNING

Objects in the driver's footwell can restrict the pedal travel or obstruct a depressed pedal. The operating and road safety of the vehicle is jeopardized. There is a risk of an accident. Make sure that all objects in the vehicle are stowed correctly, and that they cannot enter

the driver's footwell. Install the floormats securely and as specified in order to ensure sufficient clearance for the pedals. Do not use loose floormats and do not place floormats on top of one another.

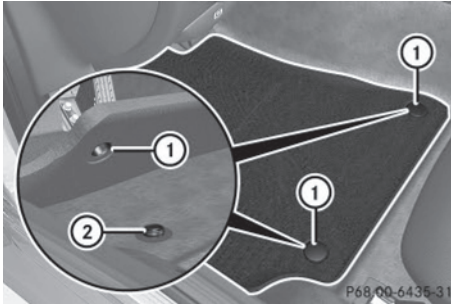

- ▶ Slide the seat backwards.
- ▶ **To install:** place the floormat in the footwell.
- ▶ Press studs ① onto retainers ②.
- ▶ **To remove:** pull the floormat off retainers ②.
- ▶ Remove the floormat.



Useful information .....	220
Engine compartment .....	220
Maintenance .....	224
Care .....	224

### Useful information

- i** This Operator's Manual describes all models and all standard and optional equipment of your vehicle available at the time of publication of the Operator's Manual. Country-specific differences are possible. Please note that your vehicle may not be equipped with all features described. This also applies to safety-related systems and functions.
- i** Read the information on qualified specialist workshops: (▷ page 32).

### Engine compartment

#### Hood

#### Important safety notes

##### WARNING

If the hood is unlatched, it may open up when the vehicle is in motion and block your view. There is a risk of an accident.  
Never unlatch the hood while driving.

##### WARNING

When opening and closing the hood, it may suddenly fall into the closed position. There is a risk of injury to persons within range of movement of the hood.  
Open and close the hood only when no one is within its range of movement.

##### WARNING

Opening the hood when the engine is overheated or when there is a fire in the engine compartment could expose you to hot gases or other service products. There is a risk of injury.

Let an overheated engine cool down before opening the hood. If there is a fire in the engine compartment, keep the hood closed and contact the fire department.

##### WARNING

The engine compartment contains moving components. Certain components, such as the radiator fan, may continue to run or start again suddenly when the ignition is off. There is a risk of injury.

If you need to do any work inside the engine compartment:

- switch off the ignition
- never reach into the area where there is a risk of danger from moving components, such as the fan rotation area
- remove jewellery and watches
- keep items of clothing and hair, for example, away from moving parts

##### WARNING

The ignition system and the fuel injection system work under high voltage. If you touch components which are under voltage, you could get an electric shock. There is a risk of injury.

Never touch components of the ignition system or fuel injection system when the ignition is switched on.

#### Opening the hood

##### WARNING

Certain components in the engine compartment, such as the engine, radiator and parts of the exhaust system, can become very hot. Working in the engine compartment poses a risk of injury.

Where possible, let the engine cool down and touch only the components described in the following.

##### WARNING

When the hood is open and the windshield wipers are set in motion, you can be injured by the wiper linkage. There is a risk of injury.  
Always switch off the windshield wipers and the ignition before opening the hood.

- ⚠ Make sure that the windshield wipers are not folded away from the windshield. You could otherwise damage the windshield wipers or the hood.

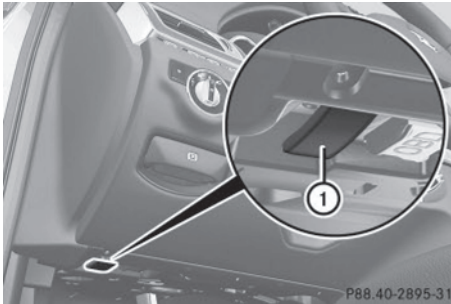

- ▶ Make sure that the windshield wipers are turned off.
- ▶ Pull release lever ① on the hood. The hood is released.

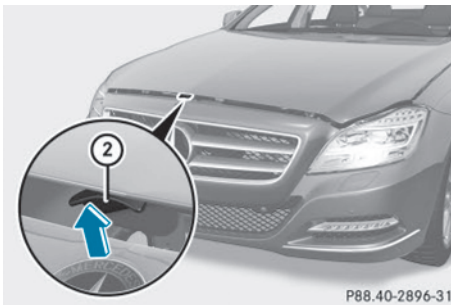

- ▶ Reach into the gap, pull hood catch handle ② up and lift the hood. If you lift the hood by approximately 15 in (40 cm), the hood is opened and held open automatically by the gas-filled strut.

### Closing the hood

- ▶ Lower the hood and let it fall from a height of approximately 8 inches (20 cm).
- ▶ Check that the hood has engaged properly. If the hood can be raised slightly, it is not properly engaged. Open it again and close it with a little more force.

### Engine oil

#### General notes

Depending on your driving style, the vehicle consumes up to 0.9 US qt (0.8 liters) of oil per 600 miles (1,000 km). The oil consumption may be higher than this when the vehicle is new or if you frequently drive at high engine speeds.

Depending on the engine, the oil dipstick may be in a different location.

When checking the oil level:

- park the vehicle on a level surface.
- the engine should be switched off for approximately five minutes if the engine is at normal operating temperature.
- if the engine is not at normal operating temperature, e.g. if the engine was only started briefly, wait about 30 minutes before carrying out the measurement.

#### Checking the oil level using the oil dipstick

##### ⚠ WARNING

Certain components in the engine compartment, such as the engine, radiator and parts of the exhaust system, can become very hot. Working in the engine compartment poses a risk of injury.

Where possible, let the engine cool down and touch only the components described in the following.

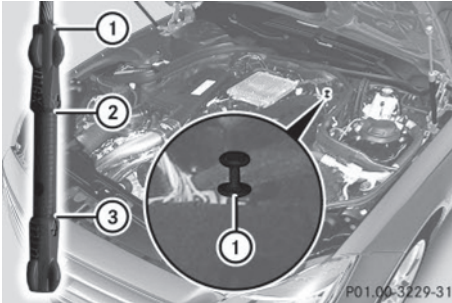

- ▶ Pull oil dipstick ① out of the dipstick guide tube.
- ▶ Wipe off oil dipstick ①.
- ▶ Slowly slide oil dipstick ① into the guide tube to the stop, and take it out again. If the level is between MIN mark ③ and MAX mark ②, the oil level is correct.
- ▶ If the oil level has dropped to MIN mark ③ or below, add 1.1 US qt (1.0 liter) engine oil.

### Adding engine oil

#### WARNING

Certain components in the engine compartment, such as the engine, radiator and parts of the exhaust system, can become very hot. Working in the engine compartment poses a risk of injury.

Where possible, let the engine cool down and touch only the components described in the following.

#### WARNING

If engine oil comes into contact with hot components in the engine compartment, it may ignite. There is a risk of fire and injury. Make sure that engine oil is not spilled next to the filler neck. Let the engine cool down and thoroughly clean the engine oil off the components before starting the engine.

#### Environmental note

When adding oil, take care not to spill any. If oil enters the soil or waterways, it is harmful to the environment.

- ❗ Only use engine oils and oil filters that have been approved for vehicles with a service system. You can obtain a list of the engine oils and oil filters tested and approved in accordance with the Mercedes-Benz Specifications for Service Products at any Mercedes-Benz Service center.

Damage to the engine or exhaust system is caused by the following:

- using engine oils and oil filters that have not been specifically approved for the service system
- replacing engine oil and oil filters after the interval for replacement specified by the service system has been exceeded
- using engine oil additives.

- ❗ Do not add too much oil. adding too much engine oil can result in damage to the engine or to the catalytic converter. Have excess engine oil siphoned off.



Example: engine oil cap

- ▶ Turn cap ① counter-clockwise and remove it.
- ▶ Add engine oil.  
If the oil level is at or below the MIN mark on the oil dipstick, add 1.1 US qt (1.0 l) of engine oil.



- ▶ Replace cap ① on the filler neck and turn clockwise.  
Ensure that the cap locks into place securely.
- ▶ Check the oil level again with the oil dipstick (▷ page 221).

Further information on engine oil (▷ page 282).

### Additional service products

#### Checking coolant level

##### WARNING

Certain components in the engine compartment, such as the engine, radiator and parts of the exhaust system, can become very hot. Working in the engine compartment poses a risk of injury.

Where possible, let the engine cool down and touch only the components described in the following.

##### WARNING

The engine cooling system is pressurized, particularly when the engine is warm. When opening the cap, you could be scalded by hot coolant spraying out. There is a risk of injury. Let the engine cool down before opening the cap. Wear eye and hand protection when opening the cap. Open the cap slowly half a turn to allow pressure to escape.

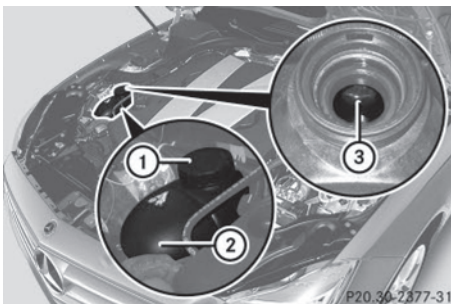

- ▶ Park the vehicle on a level surface.

Only check the coolant level when the vehicle is on a level surface and the engine has cooled down.

- ▶ Turn the SmartKey to position **2** in the ignition lock (▷ page 121).  
On vehicles with KEYLESS-GO, press the Start/Stop button twice (▷ page 121).
- ▶ Check the coolant temperature display in the instrument cluster.  
The coolant temperature must be below 158 °F (70 °C).
- ▶ Turn the SmartKey to position **0** (▷ page 121) in the ignition lock.
- ▶ Slowly turn cap ① half a turn counter-clockwise to allow excess pressure to escape.
- ▶ Turn cap ① further counter-clockwise and remove it.  
If the coolant is at the level of marker bar ③ in the filler neck when cold, there is enough coolant in coolant expansion tank ②.
- ▶ If the coolant level is approximately 0.6 in (1.5 cm) above marker bar ③ in the filler neck when warm, there is enough coolant in expansion tank ②.
- ▶ If necessary, add coolant that has been tested and approved by Mercedes-Benz.
- ▶ Replace cap ① and turn it clockwise as far as it will go.

For further information on coolant, see (▷ page 282).

#### Adding washer fluid to the windshield washer system/headlamp cleaning system

##### WARNING

Certain components in the engine compartment, such as the engine, radiator and parts of the exhaust system, can become very hot. Working in the engine compartment poses a risk of injury.

Where possible, let the engine cool down and touch only the components described in the following.

### **WARNING**

Windshield washer concentrate is highly flammable. If it comes into contact with hot engine components or the exhaust system it could ignite. There is a risk of fire and injury. Make sure that no windshield washer concentrate is spilled next to the filler neck.

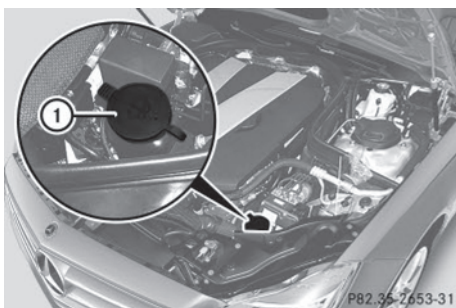

## Maintenance and care

- ▶ **To open:** pull cap ① upwards by the tab.
- ▶ Add the premixed washer fluid.
- ▶ **To close:** press cap ① onto the filler neck until it engages.

The washer fluid reservoir is used for both the windshield washer system and the headlamp cleaning system.

If the washer fluid level drops below the recommended minimum of 1 liter, a message appears in the multifunction display prompting you to add washer fluid.

Further information on windshield washer fluid/antifreeze (> page 283).

## Maintenance

### ASSYST PLUS

The Digital Operator's Manual contains more information on the ASSYST PLUS service interval display.

## Care

### General notes

#### **Environmental note**

Dispose of empty packaging and cleaning cloths in an environmentally responsible manner.

- ❗ For cleaning your vehicle, do not use any of the following:

- dry, rough or hard cloths
- abrasive cleaning agents
- solvents
- cleaning agents containing solvents

Do not scrub.

Do not touch the surfaces or protective films with hard objects, e.g. a ring or ice scraper. You could otherwise scratch or damage the surfaces and protective film.

- ❗ Do not park the vehicle for an extended period straight after cleaning it, particularly after having cleaned the wheels with wheel cleaner. Wheel cleaners could cause increased corrosion of the brake discs and brake pads/linings. For this reason, you should drive for a few minutes after cleaning. Braking heats the brake discs and the brake pads/linings, thus drying them. The vehicle can then be parked.

Regular care of your vehicle is a condition for retaining the quality in the long term.

Use care products and cleaning agents recommended and approved by Mercedes-Benz.

## Exterior care

### Automatic car wash

#### **WARNING**

Braking efficiency is reduced after washing the vehicle. There is a risk of an accident.

After the vehicle has been washed, brake carefully while paying attention to the traffic conditions until full braking power is restored.

**!** If DISTRONIC PLUS or the HOLD function is activated, the vehicle brakes automatically in certain situations. To prevent damage to the vehicle, deactivate DISTRONIC PLUS and the HOLD function in the following or other similar situations:

- when towing the vehicle
- in the car wash

**!** Never clean your vehicle in a Touchless Automatic Car Wash as these use special cleaning agents. These cleaning agents can damage the paintwork or plastic parts.

**!** Make sure that:

- the side windows and the sliding sunroof are fully closed.
- the ventilation/heating is switched off (the OFF button has been pressed).
- the windshield wiper switch is in position **0**.

Otherwise, the vehicle might be damaged.

**!** In car washes with a towing mechanism, make sure that the automatic transmission is in transmission position **N**, otherwise the vehicle could be damaged.

- Vehicles with a SmartKey:

Do not remove the SmartKey from the ignition lock. Do not open the driver's door or front-passenger door when the engine is switched off. Otherwise, the automatic transmission selects park position **P** automatically and locks the wheels. You can prevent this by shifting the automatic transmission to **N** beforehand.

- Vehicles with KEYLESS-GO:

Do not open the driver's door or front-passenger door when the engine is switched off. Otherwise, the automatic transmission selects park position **P** automatically and locks the wheels.

Observe the following to make sure that the automatic transmission stays in position **N**:

- ▶ Make sure the vehicle is stationary and the ignition is switched off.
- ▶ Turn the SmartKey to position **2** in the ignition lock (▷ page 121). Use the SmartKey instead of the Start/ Stop button on vehicles with KEYLESS-GO.
- ▶ Depress and hold the brake pedal.
- ▶ Shift the automatic transmission to position **N**.
- ▶ Release the brake pedal.
- ▶ Release the electric parking brake.
- ▶ Switch off the ignition and leave the SmartKey in the ignition lock.

You can wash the vehicle in an automatic car wash from the very start.

If the vehicle is very dirty, pre-wash it before cleaning it in an automatic car wash.

After using an automatic car wash, wipe off wax from the windshield and the wiper blades. This will prevent smears and reduce wiping noises caused by residue on the windshield.

### Information in the Digital Operator's Manual

In the Digital Operator's Manual you will find information on the following topics:

- Washing by hand
- Power washers
- Cleaning the paintwork
- Matte finish care
- Cleaning the wheels
- Cleaning the windows
- Cleaning wiper blades
- Cleaning the exterior lighting
- Cleaning the mirror turn signals
- Cleaning the sensors
- Cleaning the rear view camera
- Cleaning the exhaust pipes

**Interior care**

In the Digital Operator's Manual you will find information on the following topics:

- Cleaning the display
- Cleaning Night View Assist Plus
- Cleaning the plastic trim
- Cleaning the steering wheel and gear or selector lever
- Cleaning genuine wood and trim strips
- Cleaning the seat covers
- Cleaning the seat belts
- Cleaning the headliner and carpets

Useful information .....	228
Where will I find...? .....	228
Flat tire .....	228
Battery (vehicle) .....	230
Jump-starting .....	234
Towing and tow-starting .....	236
Fuses .....	239

### Useful information

**i** This Operator's Manual describes all models and all standard and optional equipment of your vehicle available at the time of publication of the Operator's Manual. Country-specific differences are possible. Please note that your vehicle may not be equipped with all features described. This also applies to safety-related systems and functions.

**i** Read the information on qualified specialist workshops: (▷ page 32).

### Where will I find...?

#### Vehicle tool kit

#### General notes

The vehicle tool kit can be found in the stowage well under the trunk floor (▷ page 207).

#### Vehicles with a "Minispare" emergency spare wheel

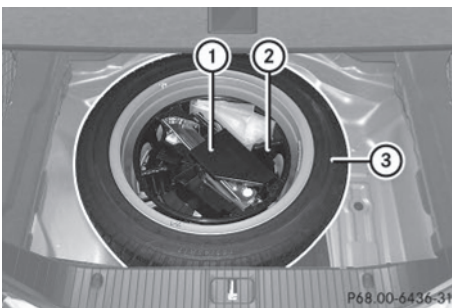

- ① Vehicle tool kit tray
  - ② Stowage well
  - ③ "Minispare" emergency spare wheel
- ▶ Open the trunk lid.
  - ▶ Lift the trunk floor upwards (▷ page 207).

The vehicle tool kit contains:

- Folding wheel chock
- Fuse allocation chart

- Jack
- Alignment bolt
- One pair of gloves
- Lug wrench
- Towing eye

#### Vehicles with a collapsible spare wheel (AMG vehicles)

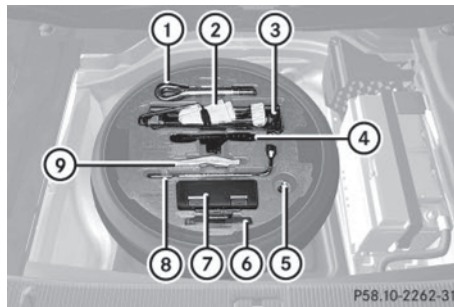

- ① Towing eye
  - ② One pair of gloves
  - ③ Jack
  - ④ Folding wheel chock
  - ⑤ Alignment bolt
  - ⑥ Sheet for faulty wheel
  - ⑦ Tire inflation compressor
  - ⑧ Lug wrench
  - ⑨ Fuse allocation chart
- ▶ Open the trunk lid.
  - ▶ Lift the trunk floor upwards (▷ page 207).

### Flat tire

#### Preparing the vehicle

Your vehicle may be equipped with:

- MOExtended tires (tires with run-flat properties)

Vehicle preparation is not necessary on vehicles with MOExtended tires.

- an emergency spare wheel

Information on changing/mounting a wheel (▷ page 264).

- ▶ Stop the vehicle on solid, non-slippery and level ground, as far away as possible from traffic.
- ▶ Switch on the hazard warning lamps.
- ▶ Secure the vehicle against rolling away (▷ page 130).
- ▶ If possible, bring the front wheels into the straight-ahead position.
- ▶ Vehicles with AIRMATIC: make sure that "normal" level is selected (▷ page 140).
- ▶ Switch off the engine.
- ▶ **Vehicles without KEYLESS-GO:** remove the SmartKey from the ignition lock.
- ▶ **Vehicles with KEYLESS-GO:** open the driver's door.  
The on-board electronics now have status **0**. This is the same as the SmartKey having been removed.
- ▶ **Vehicles with KEYLESS-GO:** remove the Start/Stop button from the ignition lock (▷ page 121).
- ▶ All occupants must get out of the vehicle. Make sure that they are not endangered as they do so.
- ▶ Make sure that no one is near the danger area while a wheel is being changed. Anyone who is not directly assisting in the wheel change should, for example, stand behind the barrier.
- ▶ Get out of the vehicle. Pay attention to traffic conditions when doing so.
- ▶ Close the driver's door.

### MOExtended tires (tires with run-flat properties)

#### General notes

With MOExtended tires (tires with run flat characteristics), you can continue to drive your vehicle even if there is a total loss of pressure in one or more tires. The affected tire must not show any clearly visible damage. You can recognize MOExtended tires by the MOExtended marking which appears on the

sidewall of the tire. You will find this marking next to the tire size designation, the load-bearing capacity and the speed index (▷ page 258).

MOExtended tires may only be used in conjunction with an active tire pressure loss warning system or with an active tire pressure monitor.

#### If the pressure loss warning message appears in the multifunction display:

- Observe the instructions in the display messages (▷ page 163).
- Check the tire for damage.
- If driving on, observe the following notes.

The maximum driving distance is approximately 50 miles (80 km) when the vehicle is partially laden and approximately 18 miles (30 km) when the vehicle is fully laden.

In addition to the vehicle load, the driving distance possible depends upon:

- speed
- road condition
- outside temperature

The driving distance possible in run-flat mode may be reduced by extreme driving conditions/maneuvers, or it can be increased through a moderate style of driving.

The maximum permissible distance which can be driven in run-flat mode is counted from the moment the tire pressure loss warning appears in the multifunction display.

You must not exceed a maximum speed of 50 mph (80 km/h).

**i** When replacing one or all tires, make sure that you use only tires:

- of the size specified for the vehicle and
- marked "MOExtended"

If a tire has gone flat and cannot be replaced with a MOExtended tire, a standard tire may be used as a temporary measure. Make sure that you use the proper size and type (summer or winter tire).

**Important safety notes****⚠ WARNING**

When driving in emergency mode, the driving characteristics deteriorate, e.g. when cornering, accelerating quickly and when braking. There is a risk of an accident.

Do not exceed the stated maximum speed. Avoid abrupt steering and driving maneuvers, and driving over obstacles (curbs, potholes, off-road). This applies in particular to a laden vehicle.

Stop driving in emergency mode if:

- you hear banging noises.
- the vehicle starts to shake.
- you see smoke and smell rubber.
- ESP® is intervening constantly.
- there are tears in the sidewalls of the tire.

After driving in emergency mode, have the wheel rims checked at a qualified specialist workshop with regard to their further use. The defective tire must be replaced in every case.

**Battery (vehicle)****Important safety notes**

Special tools and expert knowledge are required when working on the battery, e.g. removal and installing. You should therefore have all work involving the battery carried out at a qualified specialist workshop.

**⚠ WARNING**

Work carried out incorrectly on the battery can lead, for example, to a short circuit and thus damage the vehicle electronics. This can lead to function restrictions applying to safety-relevant systems, e.g. the lighting system, ABS (anti-lock braking system) or ESP® (Electronic Stability Program). The operating safety of your vehicle may be restricted. You could lose control of the vehicle, for example:

- braking
- in the event of abrupt steering maneuver and/or when the vehicle's speed is not adapted to the road conditions

There is a risk of an accident.

In the event of a short circuit or a similar incident, contact a qualified specialist workshop immediately. Do not drive any further. You should have all work involving the battery carried out at a qualified specialist workshop.

For further information about ABS and ESP®, see (▷ page 72) and (▷ page 74).

**⚠ WARNING**

Electrostatic build-up can lead to the creation of sparks, which could ignite the highly explosive gases of a battery. There is a risk of an explosion.

Before handling the battery, touch the vehicle body to remove any existing electrostatic build-up.

The highly flammable gas mixture forms when charging the battery as well as when jump-starting.

Always make sure that neither you nor the battery is electrostatically charged. A build-up of electrostatic charge can be caused, for example:

- by wearing clothing made from synthetic fibers
- due to friction between clothing and seats



- if you push or pull the battery across the carpet or other synthetic materials
- if you wipe the battery with a cloth

 **WARNING**

During the charging process, a battery produces hydrogen gas. If a short circuit occurs or sparks are created, the hydrogen gas can ignite. There is a risk of an explosion.

- Make sure that the positive terminal of a connected battery does not come into contact with vehicle parts.
- Never place metal objects or tools on a battery.
- It is important that you observe the described order of the battery terminals when connecting and disconnecting a battery.
- When jump-starting, make sure that the battery poles with identical polarity are connected.
- It is particularly important to observe the described order when connecting and disconnecting the jumper cables.
- Never connect or disconnect the battery terminals while the engine is running.

 **WARNING**

Battery acid is caustic. There is a risk of injury. Avoid contact with the skin, eyes or clothing. Do not inhale any battery gases. Do not lean over the battery. Keep children away from batteries. Wash battery acid immediately with water and seek medical attention.

 **Environmental note**



Batteries contain dangerous substances. It is against the law to dispose of them with the household rubbish. They must be collected separately and recycled to protect the environment.



Dispose of batteries in an environmentally friendly manner. Take discharged

batteries to a qualified specialist workshop or a special collection point for used batteries.

 Have the battery checked regularly at a qualified specialist workshop.

Observe the service intervals in the Maintenance Booklet or contact a qualified specialist workshop for more information.

 You should have all work involving the battery carried out at a qualified specialist workshop. In the exceptional case that it is necessary for you to disconnect the battery yourself, make sure that:

- you switch off the engine and remove the SmartKey. On vehicles with KEYLESS-GO, ensure that the ignition is switched off. Check that all the indicator lamps in the instrument cluster are off. Otherwise, electronic components, such as the alternator, may be damaged.
- you first remove the negative terminal clamp and then the positive terminal clamp. Never swap the terminal clamps. Otherwise, the vehicle's electronic system may be damaged.
- the transmission is locked in position **P** after disconnecting the battery. The vehicle is secured against rolling away. You can then no longer move the vehicle.

The battery and the cover of the positive terminal clamp must be installed securely during operation.

Comply with safety precautions and take protective measures when handling batteries.



Risk of explosion.



Fire, open flames and smoking are prohibited when handling the battery. Avoid creating sparks.



Battery acid is caustic. Avoid contact with skin, eyes or clothing.

Wear suitable protective clothing, especially gloves, apron and faceguard.

Rinse any acid spills immediately with clear water. Contact a physician if necessary.

Wear eye protection.



Keep children away.



Observe this Operator's Manual.

## Breakdown assistance

For safety reasons, Mercedes-Benz recommends that you only use batteries which have been tested and approved for your vehicle by Mercedes-Benz. These batteries provide increased impact protection to prevent vehicle occupants from suffering acid burns should the battery be damaged in the event of an accident.

In order for the battery to achieve the maximum possible service life, it must always be sufficiently charged.

The vehicle battery, like other batteries, can discharge over time if you do not use the vehicle. In this case, have the battery disconnected at a qualified specialist workshop. You can also charge the battery with a charger recommended by Mercedes-Benz. Contact a qualified specialist workshop for further information.

Have the battery condition of charge checked more frequently if you use the vehicle mainly for short trips or if you leave it standing idle for a lengthy period. Consult a qualified specialist workshop if you wish to leave your vehicle parked for a long period of time.

- Remove the SmartKey if you park the vehicle and do not require any electrical

consumers. The vehicle will then use very little energy, thus conserving battery power.

- If the power supply has been interrupted, e.g. if you reconnect the battery, you will have to:

- set the clock. Information on setting the clock can be found in the Digital Operator's Manual.

On vehicles with COMAND and a navigation system, the clock is set automatically.

- reset the function for folding the exterior mirrors in/out automatically, by folding the mirrors out once (> page 103).

## Charging the battery

### WARNING

During charging and jump-starting, explosive gases can escape from the battery. There is a risk of an explosion.

Particularly avoid fire, open flames, creating sparks and smoking. Ensure there is sufficient ventilation while charging and jump-starting. Do not lean over a battery.

### WARNING

Battery acid is caustic. There is a risk of injury. Avoid contact with the skin, eyes or clothing. Do not inhale any battery gases. Do not lean over the battery. Keep children away from batteries. Wash battery acid immediately with water and seek medical attention.

### WARNING

A discharged battery can freeze at temperatures below freezing point. When jump-starting the vehicle or charging the battery, gases can escape from the battery. There is a risk of an explosion.

Allow the frozen battery to thaw out before charging it or jump-starting.

**!** Only use battery chargers with a maximum charging voltage of 14.8 V.

**!** Only charge the battery using the jump-starting connection point.

The jump-starting connection point is in the engine compartment (▷ page 234).

- ▶ Open the hood.
- ▶ Connect the battery charger to the positive terminal and ground point in the same order as when connecting the donor battery in the jump-starting procedure (▷ page 234).

If, at low temperatures, the indicator lamps/warning lamps in the instrument cluster do not light up, it is highly likely that the discharged battery has frozen. In this case, you may neither charge the battery nor jump-start the vehicle. The service life of a thawed-out battery may be shorter. The starting characteristics may be impaired, especially at low temperatures. Have the thawed-out battery checked at a qualified specialist workshop.

Never charge a battery still installed in the vehicle unless a battery charger unit approved by Mercedes-Benz is being used. A battery charger unit specially adapted for Mercedes-Benz vehicles and tested and approved by Mercedes-Benz is available as an accessory. It permits the charging of the battery in its installed position. Contact an authorized Mercedes-Benz Center for further information and availability. Read the battery charger's operating instructions before charging the battery.

## Jump-starting

For the jump-starting procedure, use only the jump-starting connection point, consisting of a positive terminal and a ground point, in the engine compartment.

### WARNING

Battery acid is caustic. There is a risk of injury.

Avoid contact with the skin, eyes or clothing. Do not inhale any battery gases. Do not lean over the battery. Keep children away from batteries. Wash battery acid immediately with water and seek medical attention.

### WARNING

During charging and jump-starting, explosive gases can escape from the battery. There is a risk of an explosion.

Particularly avoid fire, open flames, creating sparks and smoking. Ensure there is sufficient ventilation while charging and jump-starting. Do not lean over a battery.

### WARNING

During the charging process, a battery produces hydrogen gas. If a short circuit occurs or sparks are created, the hydrogen gas can ignite. There is a risk of an explosion.

- Make sure that the positive terminal of a connected battery does not come into contact with vehicle parts.
- Never place metal objects or tools on a battery.
- It is important that you observe the described order of the battery terminals when connecting and disconnecting a battery.
- When jump-starting, make sure that the battery poles with identical polarity are connected.
- It is particularly important to observe the described order when connecting and disconnecting the jumper cables.
- Never connect or disconnect the battery terminals while the engine is running.

### WARNING

A discharged battery can freeze at temperatures below freezing point. When jump-starting the vehicle or charging the battery, gases can escape from the battery. There is a risk of an explosion.

Allow the frozen battery to thaw out before charging it or jump-starting.

**!** Avoid repeated and lengthy starting attempts. Otherwise, the catalytic converter could be damaged by the non-combusted fuel.

Do not start the vehicle using a rapid charging device. If your vehicle's battery is discharged, the engine can be jump-started from another vehicle or from a second battery using jumper cables. Observe the following points:

- The battery is not accessible in all vehicles. If the other vehicle's battery is not accessible, jump-start the vehicle using a second battery or a jump-starting device.
- You may only jump-start the vehicle when the engine and exhaust system are cold.
- Do not start the engine if the battery is frozen. Let the battery thaw first.

- Only jump-start from batteries with a 12 V voltage rating.
- Only use jumper cables which have a sufficient cross-section and insulated terminal clamps.
- If the battery is fully discharged, leave the battery that is being used to jump-start connected for a few minutes before attempting to start. This charges the battery slightly.
- Make sure that the two vehicles do not touch.

Make sure that:

- the jumper cables are not damaged.
  - when the jumper cables are connected to the battery, uninsulated sections of the terminal clamp do not come into contact with other metal sections.
  - the jumper cables cannot come into contact with parts which can move when the engine is running, such as the V-belt pulley or the fan.
- ▶ Apply the parking brake firmly.
- ▶ Shift the transmission to position **P**.
- ▶ Switch off all electrical consumers, e.g. rear window defroster, lighting, etc.
- ▶ Open the hood.

Position number ⑥ identifies the charged battery of the other vehicle or an equivalent jump-starting device.

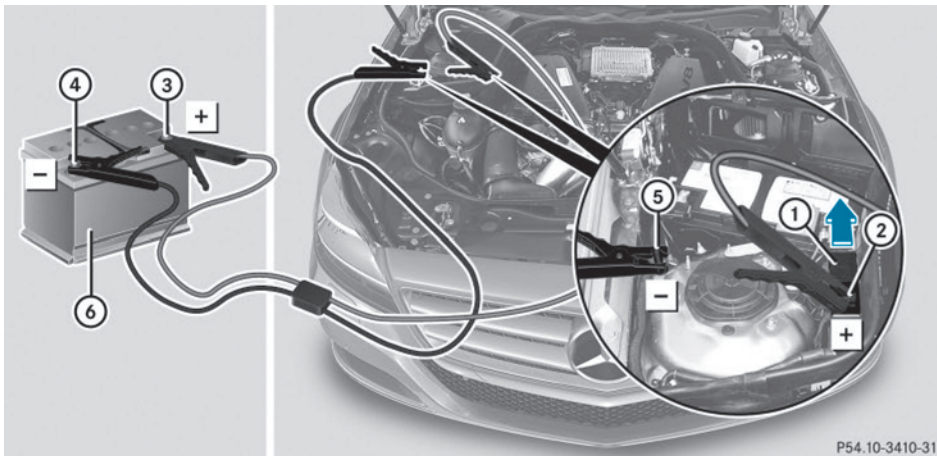

- ▶ Slide cover ① of positive terminal ② in the direction of the arrow.
- ▶ Connect positive terminal ② on your vehicle to positive terminal ③ of donor battery ⑥ using the jumper cable, always begin with positive terminal ② on your own vehicle first.
- ▶ Start the engine of the donor vehicle and run it at idling speed.
- ▶ Connect negative terminal ④ of donor battery ⑥ to ground point ⑤ of your vehicle using the jumper cable, connecting the jumper cable to battery of other vehicle ⑥ first.
- ▶ Start the engine.
- ▶ Before disconnecting the jumper cables, let the engine run for several minutes.

- ▶ First, remove the jumper cables from earth point ⑤ and negative terminal ④, then from positive clamp ② and positive terminal ③. Begin each time at the contacts on your own vehicle first.
  - ▶ Close cover ① of positive clamp ② after removing the jumper cables.
  - ▶ Have the battery checked at a qualified specialist workshop.
- i** Jump-starting is not considered to be a normal operating condition.
  - i** Jumper cables and further information regarding jump-starting can be obtained at any qualified specialist workshop.

### Towing and tow-starting

#### Important safety notes

##### WARNING

Functions relevant to safety are restricted or no longer available if:

- the engine is not running.
- the brake system or the power steering is malfunctioning.
- there is a malfunction in the voltage supply or the vehicle's electrical system.

If your vehicle is being towed, much more force may be necessary to steer or brake. There is a risk of an accident.

In such cases, use a tow bar. Before towing, make sure that the steering moves freely.

##### WARNING

If the weight of the vehicle to be towed or tow-started is greater than the permissible gross weight of your vehicle:

- the towing eye could detach itself
- the vehicle/trailer combination could rollover.

There is a risk of an accident.

When towing or tow-starting another vehicle, its weight should not be greater than the permissible gross weight of your vehicle.

- i** Information on your vehicle's gross vehicle weight rating can be found on the vehicle identification plate (▷ page 280).

**!** If DISTRONIC PLUS or the HOLD function is activated, the vehicle brakes automatically in certain situations. To prevent damage to the vehicle, deactivate DISTRONIC PLUS and the HOLD function in the following or other similar situations:

- when towing the vehicle
- in the car wash

**!** Only secure the tow rope or tow bar at the towing eyes. Otherwise, the vehicle could be damaged.

**!** Do not use the towing eye for recovery, this could damage the vehicle. If in doubt, recover the vehicle with a crane.

**!** When towing, pull away slowly and smoothly. If the tractive power is too high, the vehicles could be damaged.

**!** Do not tow with sling-type equipment. This could damage the vehicle.

**!** When towing vehicles with KEYLESS-GO, use the key instead of the Start/Stop button. Otherwise, the automatic transmission may shift to position **P** when the driver's or front-passenger door are opened, which could lead to damage to the transmission.

**!** The vehicle can be towed a maximum of 30 miles (50km). The towing speed of 30 mph (50 km/h) must not be exceeded. If the vehicle has to be towed more than 30 miles (50km), the entire vehicle must be raised and transported.

**!** If you tow or tow-start another vehicle, its weight must not exceed the maximum permissible gross vehicle weight of your vehicle.

It is better to have the vehicle transported than to have it towed.

If the vehicle has suffered transmission damage, have it transported on a transporter or trailer.

The automatic transmission must be in position **N** when the vehicle is being towed. The battery must be connected and charged. Otherwise, you:

- cannot turn the SmartKey to position **2** in the ignition lock
- cannot shift the automatic transmission to position **N**

**i** Disarm the automatic locking feature before the vehicle is towed (> page 90). You could otherwise be locked out when pushing or towing the vehicle.

### Installing/removing the towing eye

#### Installing the towing eye

#### **⚠** WARNING

The exhaust tail pipe may be very hot. There is a risk of burns when removing the rear cover.

Do not touch the exhaust pipe. Take particular care when removing the rear cover.

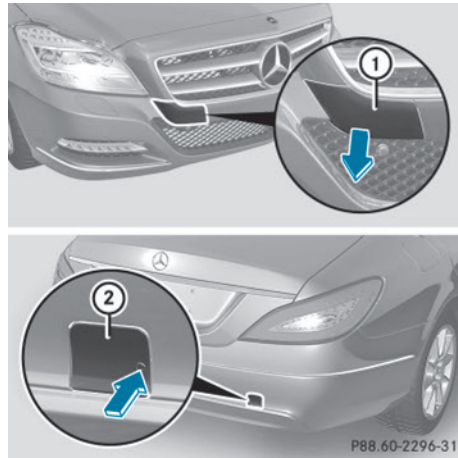

Example: towing eye covers

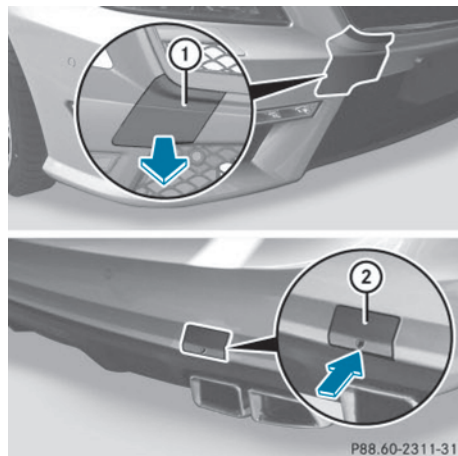

Towing eye covers (AMG vehicles)

The mountings for the removable towing eyes are located in the bumpers. They are at the front and at the rear, behind the covers.

- ▶ Remove the towing eye from the vehicle tool kit (> page 228).
- ▶ Pull cover ① out of the bumper in the direction of the arrow by inserting your fingers into the recess.
- ▶ Press the mark on cover ② inwards in the direction of the arrow.

- ▶ Take cover ② off the opening.
- ▶ Screw in and tighten the towing eye clockwise to the stop.

### Removing the towing eye

- ▶ Unscrew and remove the towing eye.
- ▶ Position the top of cover ① in the bumper and press it in at the bottom until it engages.
- ▶ Attach cover ② to the bumper and press until it engages.
- ▶ Place the towing eye in the vehicle tool kit.

### Towing the vehicle with the rear axle raised

- ❗ The ignition must be switched off if you are towing the vehicle with the rear axle raised. Intervention by ESP® could otherwise damage the brake system.

#### Only possible for vehicles without 4MATIC.

- ▶ Switch on the hazard warning lamps; see the Digital Operator's Manual.
- ▶ Turn the SmartKey to position **0** in the ignition lock and remove the SmartKey from the ignition lock.
- ▶ When leaving the vehicle, take the SmartKey or the KEYLESS-GO key with you.

When towing your vehicle with the rear axle raised, it is important that you observe the safety instructions (▷ page 236).

### Towing a vehicle with both axles on the ground

It is important that you observe the safety instructions when towing away your vehicle (▷ page 236).

The automatic transmission automatically shifts to position **P** when you open the driver's or front-passenger door or when you remove the SmartKey from the ignition lock. In order to ensure that the automatic transmission stays in position **N** when towing the vehicle, you must observe the following points:

- ▶ Make sure that the vehicle is stationary and the SmartKey in the ignition lock is in position **0**.
- ▶ Turn the SmartKey to position **2** in the ignition lock.

On vehicles with KEYLESS-GO, use the SmartKey instead of the Start/Stop button (▷ page 121).

- ▶ Depress and hold the brake pedal.
- ▶ Shift the automatic transmission to position **N**.
- ▶ Release the brake pedal.
- ▶ Release the parking brake.
- ▶ Switch on the hazard warning lamps; see the Digital Operator's Manual.
- ▶ Leave the SmartKey in position **2** in the ignition lock.
- ℹ When towing with the hazard warning lamps switched on, use the combination switch as usual to signal a change of direction. In this case, only the turn signals for the desired direction flash. After resetting the combination switch, the hazard warning lamps start flashing again.

### Transporting the vehicle

- ❗ You may only secure the vehicle by the wheels, not by parts of the vehicle such as axle or steering components. Otherwise, the vehicle could be damaged.

The towing eye can be used to pull the vehicle onto a trailer or transporter for transporting purposes.



- ▶ Turn the SmartKey to position **2** in the ignition lock.
- ▶ Shift the automatic transmission to position **N**.

#### As soon as the vehicle has been loaded:

- ▶ Prevent the vehicle from rolling away by applying the parking brake.
- ▶ Shift the automatic transmission to position **P**.
- ▶ Turn the SmartKey to position **0** in the ignition lock and remove the SmartKey from the ignition lock.
- ▶ Secure the vehicle.

#### Notes on 4MATIC vehicles

**!** Vehicles with 4MATIC must not be towed with either the front or the rear axle raised, as doing so will damage the transmission.

If the vehicle has transmission damage or damage to the front or rear axle, have it transported on a transporter or trailer.

#### In the event of damage to the electrical system

If the battery is defective, the automatic transmission will be locked in position **P**. To shift the automatic transmission to position **N**, you must provide power to the vehicle's electrical system in the same way as when jump-starting (▷ page 234).

Have the vehicle transported on a transporter or trailer.

#### Tow-starting (emergency engine starting)

**!** Vehicles with automatic transmission must not be started by tow-starting. This could otherwise damage the transmission.

You can find information on "Jump-starting" under (▷ page 234).

## Fuses

### Important safety notes

#### WARNING

If you manipulate or bridge a faulty fuse or if you replace it with a fuse with a higher amperage, the electric cables could be overloaded. This could result in a fire. There is a risk of an accident and injury.

Always replace faulty fuses with the specified new fuses having the correct amperage.

**!** Only use fuses that have been approved for Mercedes-Benz vehicles and which have the correct fuse rating for the system concerned. Otherwise, components or systems could be damaged.

The fuses in your vehicle serve to close down faulty circuits. If a fuse blows, all the components on the circuit and their functions stop operating.

Blown fuses must be replaced with fuses of the same rating, which you can recognize by the color and value. The fuse ratings are listed in the fuse allocation chart.

If a newly inserted fuse also blows, have the cause traced and rectified at a qualified specialist workshop, e.g. an authorized Mercedes-Benz Center.

### Before changing a fuse

Observe the important safety notes (▷ page 239)

- ▶ Secure the vehicle against rolling away (▷ page 130).
  - ▶ Switch off all electrical consumers.
  - ▶ Turn the SmartKey to position **0** in the ignition lock and remove it (▷ page 121).
- or
- ▶ On vehicles with KEYLESS-GO, make sure the ignition is switched off (▷ page 121).

All indicator lamps in the instrument cluster must be off.

The fuses are located in various fuse boxes:

- Fuse box in the engine compartment on the left-hand side of the vehicle, when viewed in the direction of travel
- fuse box located in the trunk on the right-hand side when viewed in the direction of travel

the fuse allocation chart is located in the vehicle tool kit in the stowage compartment under the trunk floor (▷ page 228).

### Fuse box in the engine compartment

Observe the important safety notes (▷ page 239)

#### WARNING

When the hood is open and the windshield wipers are set in motion, you can be injured by the wiper linkage. There is a risk of injury. Always switch off the windshield wipers and the ignition before opening the hood.

- ❗ Make sure that no moisture can enter the fuse box when the cover is open.
- ❗ When closing the cover, make sure that it is lying correctly on the fuse box. Moisture seeping in or dirt could otherwise impair the operation of the fuses.
- ▶ Make sure that the windshield wipers are turned off.
- ▶ Open the hood.

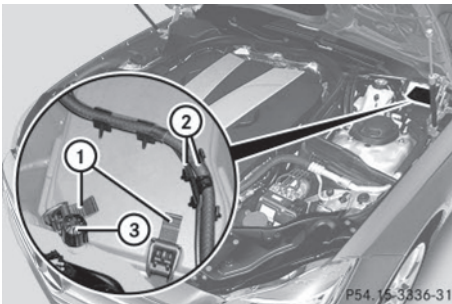

- ▶ Use a dry cloth to remove any moisture from the fuse box.
- ▶ **To open:** remove lines ② from the guides.
- ▶ Move lines ② aside. Route the lines behind connection ③ to do this.
- ▶ Open clamp ①.
- ▶ Remove the fuse box cover forwards.
- ▶ **To close:** check whether the rubber seal is lying correctly in the cover.
- ▶ Insert the cover at the rear of the fuse box into the retainer.
- ▶ Fold down cover and close clamps ①.
- ▶ Secure lines ② in the guides.
- ▶ Close the hood.

### Fuse box in the trunk

Observe the important safety notes (▷ page 239)

- ❗ Make sure that no moisture can enter the fuse box when the cover is open.
- ❗ When closing the cover, make sure that it is lying correctly on the fuse box. Moisture seeping in or dirt could otherwise impair the operation of the fuses.
- ▶ Open the trunk lid.

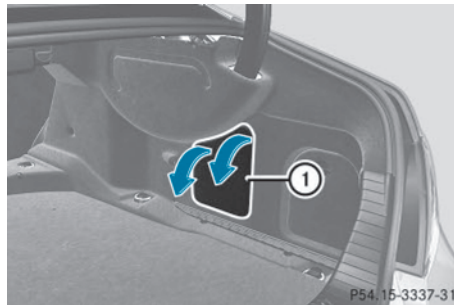

- ▶ **To open:** release cover ① at the top right and left-hand sides with a flat object.
- ▶ Open cover ① downwards in the direction of the arrow.

Useful information .....	242
Important safety notes .....	242
Operation .....	242
Winter operation .....	244
Tire pressure .....	244
Loading the vehicle .....	252
All about wheels and tires .....	256
Changing a wheel .....	264
Wheel and tire combinations .....	269
Emergency spare wheel .....	274

### Useful information

- i** This Operator's Manual describes all models and all standard and optional equipment of your vehicle available at the time of publication of the Operator's Manual. Country-specific differences are possible. Please note that your vehicle may not be equipped with all features described. This also applies to safety-related systems and functions.
- i** Read the information on qualified specialist workshops: (> page 32).

### Important safety notes

#### WARNING

If wheels and tires of the wrong size are used, the wheel brakes or suspension components may be damaged. There is a risk of an accident.

Always replace wheels and tires with those that fulfill the specifications of the original part.

When replacing wheels, make sure to use the correct:

- designation
- model

When replacing tires, make sure to use the correct:

- designation
- manufacturer
- model

#### WARNING

A flat tire severely impairs the driving, steering and braking characteristics of the vehicle. There is a risk of accident.

Tires without run-flat characteristics:

- do not drive with a flat tire.
- immediately replace the flat tire with your emergency spare wheel or spare wheel, or consult a qualified specialist workshop.

Tires with run-flat characteristics:

- pay attention to the information and warning notices on MOExtended tires (tires with run-flat characteristics).

Accessories that are not approved for your vehicle by Mercedes-Benz or are not being used correctly can impair the operating safety.

Before purchasing and using non-approved accessories, visit a qualified specialist workshop and ask about:

- suitability
- legal stipulations
- factory recommendations

Information on the dimensions and types of wheels and tires for your vehicle can be found in the "Wheel/tire combinations" section (> page 269).

Information on air pressure for the tires on your vehicle can be found:

- on the vehicle's Tire and Loading Information placard on the B-pillar
- on the tire pressure label on the fuel filler flap
- in the "Tire pressure" section

## Operation

### Information on driving

If the vehicle is heavily loaded, check the tire pressures and correct them if necessary.

While driving, pay attention to vibrations, noises and unusual handling characteristics, e.g. pulling to one side. This may indicate that the wheels or tires are damaged. If you suspect that a tire is defective, reduce your speed immediately. Stop the vehicle as soon as possible to check the wheels and tires for damage. Hidden tire damage could also be causing the unusual handling characteristics. If you find no signs of damage, have the tires and wheels checked at a qualified specialist workshop.

When parking your vehicle, make sure that the tires do not get deformed by the curb or other obstacles. If it is necessary to drive over curbs, speed humps or similar elevations, try to do so slowly and at an obtuse angle. Otherwise, the tires, particularly the sidewalls, may be damaged.

### Regular checking of wheels and tires

#### WARNING

Damaged tires can cause tire inflation pressure loss. As a result, you could lose control of your vehicle. There is a risk of accident.

Check the tires regularly for signs of damage and replace any damaged tires immediately.

Regularly check the wheels and tires of your vehicle for damage at least once a month, as well as after driving off-road or on rough roads. Damaged wheels can cause a loss of tire pressure. Pay particular attention to damage such as:

- cuts in the tires
- punctures
- tears in the tires
- bulges on tires
- deformation or severe corrosion on wheels

Regularly check the tire tread depth and the condition of the tread across the whole width of the tire (▷ page 243). If necessary, turn the front wheels to full lock in order to inspect the inner side of the tire surface.

All wheels must have a valve cap to protect the valve against dirt and moisture. Do not mount anything onto the valve other than the standard valve cap or other valve caps approved by Mercedes-Benz for your vehicle. Do not use any other valve caps or systems, e.g. tire pressure monitoring systems.

Regularly check the pressure of all the tires particularly prior to long trips. Adjust the tire pressure as necessary (▷ page 244).

Observe the notes on the emergency spare wheel (▷ page 274).

The service life of tires depends, among other things, on the following factors:

- driving style
- tire pressure
- distance covered

### Important safety notes on the tire tread

#### WARNING

Insufficient tire tread will reduce tire traction. The tire is no longer able to dissipate water. This means that on wet road surfaces, the risk of hydroplaning increases, in particular where speed is not adapted to suit the driving conditions. There is a risk of accident.

If the tire pressure is too high or too low, tires may exhibit different levels of wear at different locations on the tire tread. Thus, you should regularly check the tread depth and the condition of the tread across the entire width of all tires.

Minimum tire tread depth for:

- Summer tires:  $\frac{1}{8}$  in (3 mm)
- M+S tires:  $\frac{1}{8}$  in (4 mm)

For safety reasons, replace the tires before the legally prescribed limit for the minimum tire tread depth is reached.

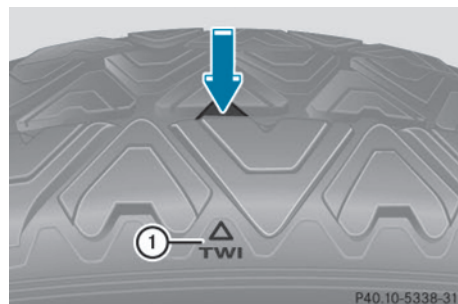

Bar indicator ① for tread wear is integrated into the tire tread.

Treadwear indicators (TWI) are required by law. Six indicators are positioned on the tire tread. They are visible once a tread depth of approximately  $\frac{1}{16}$  in (1.6 mm) has been reached. If this is the case, the tire is so worn that it must be replaced.

### Selecting, mounting and replacing tires

- Only mount tires and wheels of the same type and make.  
Exception: it is permissible to install a different type or make in the event of a flat tire. Observe the "MOExtended tires (tires with run-flat characteristics)" section (▷ page 229).
- Only mount tires of the correct size onto the wheels.
- Break in new tires at moderate speeds for the first 60 miles (100 km). They only reach their full performance after this distance.
- Do not drive with tires which have too little tread depth, as this significantly reduces the traction on wet roads (hydroplaning).
- Replace the tires after six years at the latest, regardless of wear.

Observe the notes on the emergency spare wheel (▷ page 274).

### MOExtended tires (tires with run-flat properties)

With MOExtended tires (tires with run flat characteristics), you can continue to drive your vehicle even if there is a total loss of pressure in one or more tires.

MOExtended tires may only be used in conjunction with an active tire pressure loss warning system or with an active tire pressure monitor and on wheels specifically tested by Mercedes-Benz.

Notes on driving with MOExtended tires with a flat tire (▷ page 229).

- Vehicles equipped with MOExtended tires are not equipped with a TIREFIT kit at the factory. It is therefore recommended that you additionally equip your vehicle with a TIREFIT kit if you mount tires that do not feature run-flat properties, e.g. winter tires. A TIREFIT kit can be obtained from a qualified specialist workshop.

### Winter operation

#### Information in the Digital Operator's Manual

You can find information about this in the Digital Operator's Manual.

### Tire pressure

#### Tire pressure specifications

#### Important safety notes

#### WARNING

Tires with tire pressures that are too low or too high are associated with the following hazards:

- they can burst, in particular if the vehicle is heavily laden or when driven at high speeds.
- the tires can wear excessively and/or unevenly, which can severely impair tire traction.
- the driving, steering and braking characteristics may be severely impaired.

There is a risk of accident.

Follow recommended tire inflation pressures and check the pressure of all the tires including the spare wheel:

- monthly, at least
- if the load changes
- before beginning a long journey
- under different operating conditions, e.g. off-road driving

If necessary, correct the tire pressure.

**i** The specifications on the sample Tire and Loading Information placard and tire pressure tables are examples. Tire pressure specifications are vehicle-specific and may deviate from the data shown here. The tire pressure specifications that are valid for your vehicle can be found on the Tire and Loading Information placard and tire pressure table on the vehicle.

### General notes

The recommended tire pressures for the tires mounted at the factory can be found on the labels described here.

### Operation with the emergency spare wheel (▷ page 274).

Further information on tire pressures can be obtained at a qualified specialist workshop.

### Tire and Loading Information placard

**1** TIRE LOADING INFORMATION  
RENSEIGNEMENT SUR LES PNEUS ET LE CHARGEMENT

SEATING CAPACITY: 7 TOTAL 7 FRONT 2 MIDDLE 3 REAR 2  
NOMBRE DE PLACES: 7 TOTAL 7 AVANT 2 MILIEU 3 ARRIERE 2

The combined weight of occupants and cargo should never exceed XXX kg or XXX lbs. Le poids total des occupants et du chargement ne doit jamais dépasser XXX kg ou XXX lbs.

TIRE PNEU	SIZE DIMENSIONS	COLD TIRE PRESSURE PRESSION DES PNEUS A FROID
FRONT AVANT	255/40 ZR18 99Y XL	200 kPa, 29 PSI
REAR ARRIERE	285/35 ZR18 101Y XL	200 kPa, 29 PSI
SPARE DE SECOURS	175/55-18 95P	420 kPa, 60 PSI

SEE OWNER'S MANUAL FOR ADDITIONAL INFORMATION  
VOIR LE MANUEL DE L'USAGER POUR PLUS DE RENSEIGNEMENTS

P40.00-2205-31

#### ① Recommended tire pressures

The Tire and Loading Information placard is on the B-pillar on the driver's side (▷ page 252).

The Tire and Loading Information placard contains the recommended tire pressures for cold tires. The recommended tire pressures are valid for the maximum permissible load and up to the maximum permissible vehicle speed.

### Tire pressure table

The tire pressure table is on the inside of the fuel filler flap.

**COLD TIRE PRESSURE**

normal load

maximum load

Warm tires up to: + 4 psi

P40.00-2179-31

Example: tire pressure table for all tires permitted for this vehicle by the factory

The tire pressure table contains the recommended pressures for cold tires for various operating conditions, i.e. differing load and speed conditions.

**LUFTDRUCK PRESSURE PRESSION PRESSION**

für kalte Reifen for cold tires des pneus froids de Inflado

100 kPa = 1 bar

	175	185	195	205
195/55 R16	200 kPa	200 kPa	200 kPa	200 kPa
215/45 R17	200 kPa	200 kPa	200 kPa	200 kPa
215/40 R18	200 kPa	200 kPa	200 kPa	200 kPa

Warme Reifen: Warm tires up to: + 30 kPa / + 4 psi  
Pneus échauffés jusqu'à: Neumáticos calientes hasta:

P40.00-2183-31

Example: tire pressure table with tire dimensions

If a tire size precedes a tire pressure, the tire pressure information following is only valid for that tire size. The load conditions "partially laden" and "fully laden" are defined in the table for different numbers of occupants and amounts of luggage. The actual number of seats may differ.

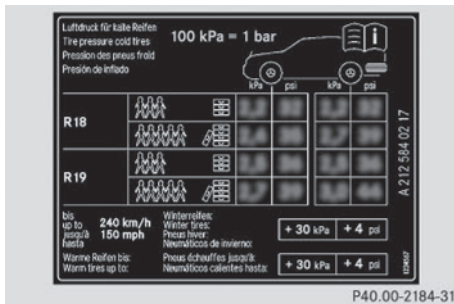

Some tire pressure tables show only the rim diameters instead of the full tire size, e.g.

**R18.** The rim diameter is part of the tire size and can be found on the tire sidewall (▷ page 258).

If the tire pressures have been set to the lower values for lighter loads and/or lower road speeds, the pressures should be reset to the higher values:

- if you want to drive with an increased load and/or
- if you want to drive at higher road speeds.

**i** The tire pressures for increased loads and/or higher road speeds, shown in the tire pressure table, may have a negative effect on driving comfort.

If the tire pressure is not set correctly, this can lead to an excessive build up of heat and a sudden loss of pressure.

For more information, contact a qualified specialist workshop.

### Important notes on tire pressure

#### **⚠ WARNING**

If the tire pressure drops repeatedly, the wheel, valve or tire may be damaged. Tire pressure that is too low may result in a tire blow-out. There is a risk of an accident.

- Check the tire for foreign objects.
- Check whether the wheel is losing air or the valve is leaking.

If you are unable to rectify the damage, contact a qualified specialist workshop.

#### **⚠ WARNING**

If you fit unsuitable accessories onto tire valves, the tire valves may be overloaded and malfunction, which can cause tire pressure loss. Due to their design, retrofitted tire pressure monitors keep the tire valve open. This can also result in tire pressure loss. There is a risk of an accident.

Only screw the standard valve cap or other valve caps approved by Mercedes-Benz for your vehicle onto the tire valve.

Use a suitable pressure gauge to check the tire pressure. The outer appearance of a tire does not permit any reliable conclusion about the tire pressure. On vehicles equipped with the electronic tire pressure monitoring system, the tire pressure can be checked using the on-board computer.

The tire temperature and pressure increase when the vehicle is in motion. This is dependent on the driving speed and the load. Therefore, you should only correct tire pressures when the tires are cold.

The tires are cold:

- if the vehicle has been parked without direct sunlight on the tires for at least three hours and
- if the vehicle has been driven for less than 1 mile (1.6 km).

The tire temperature changes depending on the outside temperature, the vehicle speed and the tire load. If the tire temperature changes by 18 °F (10 °C), the tire pressure changes by approximately 10 kPa (0.1 bar/ 1.5 psi). Take this into account when checking the pressure of warm tires. Only correct the tire pressure if it is too low for the current operating conditions. If you check the tire pressure when the tires are warm, the resulting value will be higher than if the tires were cold. This is normal. Do not reduce the tire pressure to the value specified for cold



tires. The tire pressure would otherwise be too low.

Observe the recommended tire pressures for cold tires:

- on the Tire and Loading Information placard on the B-pillar on the driver's side
- in the tire pressure table on the inside of the fuel filler flap
- on the yellow label on the emergency spare wheel (depending on the vehicle equipment)

### Underinflated or overinflated tires

#### Underinflation

##### WARNING

Tires with pressure that is too low can overheat and burst as a consequence. In addition, they also suffer from excessive and/or irregular wear, which can severely impair the braking properties and the driving characteristics. There is a risk of an accident. Avoid tire pressures that are too low in all the tires, including the spare wheel.

Underinflated tires may:

- overheat, leading to tire defects
- have an adverse effect on handling characteristics
- wear quickly and unevenly
- have an adverse effect on fuel consumption

#### Overinflation

##### WARNING

Tires with excessively high pressure can burst because they are damaged more easily by road debris, potholes etc. In addition, they also suffer from irregular wear, which can severely impair the braking properties and the driving characteristics. There is a risk of an accident.

Avoid tire pressures that are too high in all the tires, including the spare wheel.

Overinflated tires may:

- increase the braking distance
- have an adverse effect on handling characteristics
- wear quickly and unevenly
- have an adverse effect on ride comfort
- be more susceptible to damage

#### Maximum tire pressures



- ① Example: maximum permissible tire pressure

Never exceed the maximum permissible tire inflation pressure. Always observe the recommended tire pressure for your vehicle when adjusting the tire pressure (> page 244).

-  The actual values for tires are vehicle-specific and may deviate from the values in the illustration.

#### Checking the tire pressures

#### Important safety notes

Observe the notes on tire pressure (> page 244).

Information on air pressure for the tires on your vehicle can be found:

- on the vehicle's Tire and Loading Information placard on the B-pillar
- on the tire pressure label on the fuel filler flap
- in the "Tire pressure" section

### Checking tire pressures manually

To determine and set the correct tire pressure, proceed as follows:

- ▶ Remove the valve cap of the tire that is to be checked.
- ▶ Press the tire pressure gauge securely onto the valve.
- ▶ Read the tire pressure and compare it with the recommended value on the Tire and Loading Information placard (▷ page 244).
- ▶ If the tire pressure is too low, increase it to the recommended value.
- ▶ If the tire pressure is too high, release air by pressing down the metal pin in the valve. Use the tip of a pen, for example. Then, check the tire pressure again using the tire pressure gauge.
- ▶ Screw the valve cap onto the valve.
- ▶ Repeat these steps for the other tires.

### Tire pressure loss warning system (Canada only)

#### General notes

While the vehicle is in motion, the tire pressure loss warning system monitors the set tire pressure using the rotational speed of the wheels. This enables the system to detect significant pressure loss in a tire. If the speed of rotation of a wheel changes as a result of a loss of pressure, a corresponding warning message will appear in the multifunction display.

You can recognize the tire pressure loss warning by the **Run Flat Indicator Active Press 'OK' to Restart** message which appears in the **Service** menu of the multifunction display. Information on the message display can be found in the "Restarting the tire pressure loss warning system" section (▷ page 248).

### Important safety notes

The tire pressure warning system does not warn you of an incorrectly set tire pressure. Observe the notes on the recommended tire pressure (▷ page 244).

The tire pressure loss warning does not replace the need to regularly check the tire pressure. An even loss of pressure on several tires at the same time cannot be detected by the tire pressure loss warning system.

The tire pressure monitor is not able to warn you of a sudden loss of pressure, e.g. if the tire is penetrated by a foreign object. In the event of a sudden loss of pressure, bring the vehicle to a halt by braking carefully. Avoid abrupt steering maneuvers.

The function of the tire pressure loss warning system is limited or delayed if:

- snow chains are mounted on your vehicle's tires.
- road conditions are wintry.
- you are driving on sand or gravel.
- you adopt a very sporty driving style (cornering at high speeds or driving with high rates of acceleration).
- you are driving with a heavy load (in the vehicle or on the roof).

### Restarting the tire pressure loss warning system

Restart the tire pressure loss warning system if you have:

- changed the tire pressure
  - changed the wheels or tires
  - mounted new wheels or tires
- ▶ Before restarting, make sure that the tire pressures are set properly on all four tires for the respective operating conditions. The recommended tire pressure can be found on the Tire and Loading Information placard on the B-pillar on the driver's side. Additionally, a tire pressure table is attached to the fuel filler flap. The tire

pressure loss warning system can only give reliable warnings if you have set the correct tire pressure. If an incorrect tire pressure is set, these incorrect values will be monitored.

- ▶ Also observe the notes in the section on tire pressures (▷ page 244).
- ▶ Make sure that the SmartKey is in position **2** in the ignition lock (▷ page 121).
- ▶ Press the ◀ or ▶ button on the steering wheel to select the **Service** menu.
- ▶ Press the ▲ or ▼ button on the steering wheel to select the **Tire Pressure** menu.
- ▶ Press the OK button.  
The **Run Flat Indicator Active Press 'OK' to Restart** message appears in the multifunction display.

#### If you wish to confirm the restart:

- ▶ Press the OK button.  
The **Tire Pressure Now OK?** message appears in the multifunction display.
- ▶ Press the ▲ or ▼ button to select **Yes**.
- ▶ Press the OK button.  
The **Run Flat Indicator Restarted** message appears in the multifunction display.

After a teach-in period, the tire pressure loss warning system will monitor the set tire pressures of all four tires.

#### If you wish to cancel the restart:

- ▶ Press the ↩ button.  
or
- ▶ When the **Tire Pressure Now OK?** message appears, press the ▲ or ▼ button to select **Cancel**.
- ▶ Press the OK button.  
The tire pressure values stored at the last restart will continue to be monitored.

## Tire pressure monitor

### General notes

If a tire pressure monitor is installed, the vehicle's wheels have sensors that monitor the tire pressures in all four tires. The tire pressure monitor warns you if the pressure drops in one or more of the tires. The tire pressure monitor only functions if the correct sensors are installed on all wheels.

Information on tire pressures is displayed in the multifunction display. After a few minutes of driving, the current tire pressure of each tire is shown in the **Service** menu of the multifunction display.



Example: current tire pressure display

For information on the message display, refer to the "Checking the tire pressure electronically" section (▷ page 251).

### Important safety notes

#### ⚠ WARNING

Each tire, including the spare (if provided), should be checked at least once every two weeks when cold and inflated to the pressure recommended by the vehicle manufacturer on the Tire and Loading Information placard on the driver's door B-pillar or the tire pressure label on the inside of the fuel filler flap. If your vehicle has tires of a different size than the size indicated on the Tire and Loading Information placard or, if available, the tire pressure label, you should determine the proper tire pressure for those tires.

As an added safety feature, your vehicle has been equipped with a tire pressure monitoring system (TPMS) that illuminates a low tire pressure telltale when one or more of your

tires are significantly underinflated. Accordingly, when the low tire pressure telltale lights up, you should stop and check your tires as soon as possible, and inflate them to the proper pressure. Driving on a significantly underinflated tire causes the tire to overheat and can lead to tire failure.

Underinflation also reduces fuel efficiency and tire tread life, and may affect the vehicle's handling and stopping ability. Please note that the TPMS is not a substitute for proper tire maintenance, and it is the driver's responsibility to maintain correct tire pressure, even if underinflation has not reached the level to trigger illumination of the TPMS low tire pressure telltale.

Your vehicle has also been equipped with a TPMS malfunction indicator to indicate when the system is not operating properly. The TPMS malfunction indicator is combined with the low tire pressure telltale. When the system detects a malfunction, the warning lamp will flash for approximately a minute and then remain continuously illuminated. This sequence will be repeated every time the vehicle is started as long as the malfunction exists. When the malfunction indicator is illuminated, the system may not be able to detect or signal low tire pressure as intended. TPMS malfunctions may occur for a variety of reasons, including the installation of incompatible replacement or alternate tires or wheels on the vehicle that prevent the TPMS from functioning properly. Always check the TPMS malfunction telltale after replacing one or more tires or wheels on your vehicle to ensure that the replacement or alternate Tires and wheels allow the TPMS to continue to function properly.

It is the driver's responsibility to set the tire pressure to that recommended for cold tires which is suitable for the operating situation (> page 244). Note that the correct tire pressure for the current operating situation must first be taught-in to the tire pressure monitor. If there is a substantial loss of

pressure, the warning threshold for the warning message is aligned to the reference values taught-in. Restart the tire pressure monitor after adjusting the pressure of the cold tires (> page 251). The current pressures are saved as new reference values. As a result, a warning message will appear if the tire pressure drops significantly.

The tire pressure monitor does not warn you of an incorrectly set tire pressure. Observe the notes on the recommended tire pressure (> page 244).

The tire pressure monitor is not able to warn you of a sudden loss of pressure, e.g. if the tire is penetrated by a foreign object. In the event of a sudden loss of pressure, bring the vehicle to a halt by braking carefully. Avoid abrupt steering maneuvers.

The tire pressure monitor has a yellow warning lamp in the instrument cluster for indicating a pressure loss or malfunction. Whether the warning lamp flashes or lights up indicates whether a tire pressure is too low or the tire pressure monitor is malfunctioning:

- if the warning lamp is lit continuously, the tire pressure on one or more tires is significantly too low. The tire pressure monitor is not malfunctioning.
- if the warning lamp flashes for around a minute and then remains lit constantly, the tire pressure monitor is malfunctioning.

**i** In addition to the warning lamp, a message appears in the multifunction display.

Further information can be found on (> page 163).

If the tire pressure monitor is malfunctioning, it may take more than ten minutes for the tire pressure warning lamp to inform you of the malfunction by flashing for approximately one minute and then remaining lit. When the malfunction has been rectified, the tire pressure warning lamp goes out after a few minutes of driving.

The tire pressure values indicated by the on-board computer may differ from those measured at a gas station with a pressure gauge. The tire pressures shown by the on-board computer refer to those measured at sea level. At high altitudes, the tire pressure values indicated by a pressure gauge are higher than those shown by the on-board computer. In this case, do not reduce the tire pressures.

The operation of the tire pressure monitor can be affected by interference from radio transmitting equipment (e.g. radio headphones, two-way radios) that may be being operated in or near the vehicle.

### Checking the tire pressure electronically

- ▶ Make sure that the SmartKey is in position **2** in the ignition lock (▶ page 121).
- ▶ Press the ◀ or ▶ button on the steering wheel to select the **Service** menu.
- ▶ Press the ▲ or ▼ button to select **Tire Pressure**.
- ▶ Press the **OK** button.  
The current tire pressure of each tire is shown in the multifunction display.

If the vehicle has been parked for over 20 minutes, the **Tire pressures will be displayed after driving a few minutes** message appears.

After a teach-in process, the tire pressure monitor automatically detects new wheels or new sensors. As long as a clear allocation of the tire pressure value to the individual wheels is not possible, the **Tire Pressure Monitor Active** display message is shown instead of the tire pressure display. The tire pressures are already being monitored.

- ❗ If an emergency spare wheel is mounted, the system may continue to show the tire pressure of the wheel that has been removed for a few minutes. If this occurs, note that the value displayed for the

position where the spare wheel is mounted is not the same as the current tire pressure of the emergency spare wheel.

### Tire pressure monitor warning messages

If the tire pressure monitor detects a pressure loss in one or more tires, a warning message is shown in the multifunction display and the yellow tire pressure monitor warning lamp comes on.

- If the **Correct Tire Pressure** message appears in the multifunction display, the tire pressure in at least one tire is too low and must be corrected at the next opportunity.
- If the **Check Tires** message appears in the multifunction display, the tire pressure in one or more tires has dropped significantly and the tires must be checked.
- If the **Warning Tire Malfunction** message appears in the multifunction display, the tire pressure in one or more tires has dropped suddenly and the tires must be checked.







Observe the instructions and safety notes in the display messages in the "Tires" section (▶ page 163).

- ❗ If the wheel positions on the vehicle are rotated, the tire pressures may be displayed for the wrong positions for a short time. This is rectified after a few minutes of driving, and the tire pressures are displayed for the correct positions.

### Restarting the tire pressure monitor

When you restart the tire pressure monitor, all existing warning messages are deleted and the warning lamps go out. The monitor uses the currently set tire pressures as the reference values for monitoring. In most cases, the tire pressure monitor will automatically detect the new reference values after you have changed the tire pressure. However, you can also define

reference values manually as described here. The tire pressure monitor then monitors the new tire pressure values.

- ▶ Set the tire pressure to the value recommended for the corresponding driving situation on the Tire and Loading Information placard on the driver's side B-pillar (> page 244).  
Additional tire pressure values for different loads can also be found on the tire pressure table on the inside of the fuel filler flap (> page 244).
- ▶ Make sure that the tire pressure is correct on all four wheels.
- ▶ Make sure that the SmartKey is in position **2** in the ignition lock.
- ▶ Press the  or  button on the steering wheel to select the **Service** menu.
- ▶ Press the  or  button to select **Tire Pressure**.
- ▶ Press the  button.  
The multifunction display shows the current tire pressure for the individual tires or the **Tire pressures will be displayed after driving a few minutes** message.
- ▶ Press the  button.  
The **Use Current Pressures as New Reference Values** message appears in the multifunction display.

#### If you wish to confirm the restart:

- ▶ Press the  button.  
The **Tire Press. Monitor Restarted** message appears in the multifunction display.  
After driving for a few minutes, the system checks whether the current tire pressures are within the specified range. The new tire pressures are then accepted as reference values and monitored.

#### If you wish to cancel the restart:

- ▶ Press the  button.  
The tire pressure values stored at the last restart will continue to be monitored.

## Loading the vehicle

### Instruction labels for tires and loads

#### WARNING

Overloaded tires can overheat, causing a blowout. Overloaded tires can also impair the steering and driving characteristics and lead to brake failure. There is a risk of accident.

Observe the load rating of the tires. The load rating must be at least half of the GAWR of your vehicle. Never overload the tires by exceeding the maximum load.

Two instruction labels on your vehicle show the maximum possible load.

- (1) The Tire and Loading Information placard is on the B-pillar on the driver's side. The Tire and Loading Information placard shows the maximum permissible number of occupants and the maximum permissible vehicle load. It also contains details of the tire sizes and corresponding pressures for tires mounted at the factory.
- (2) The vehicle identification plate is on the B-pillar on the driver's side. The vehicle identification plate informs you of the gross vehicle weight rating. It is made up of the vehicle weight, all vehicle occupants, the fuel and the cargo. You can also find information about the maximum gross axle weight rating on the front and rear axle.  
The maximum gross axle weight rating is the maximum weight that can be carried by one axle (front or rear axle). Never exceed the maximum load or the maximum gross axle weight rating for the front or rear axle.

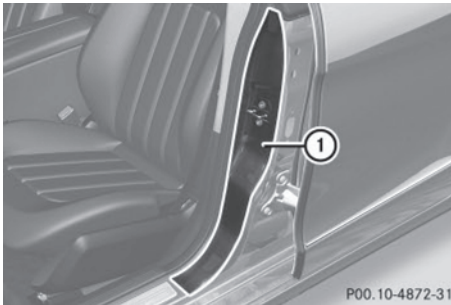

① B-pillar, driver's side

### Maximum permissible gross vehicle weight rating

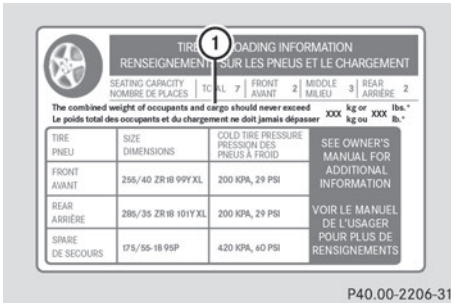

P40.00-2206-31

- Specification for maximum gross vehicle weight ① is listed in the Tire and Loading Information placard: "The combined weight of occupants and cargo should never exceed XXX kilograms or XXX lbs."

The gross weight of all vehicle occupants, load and luggage must not exceed the specified value.

- ① The specifications shown on the Tire and Loading Information placard in the illustration are examples. The maximum permissible gross vehicle weight rating is vehicle-specific and may differ from that in the illustration. You can find the valid maximum permissible gross vehicle weight rating for your vehicle on the Tire and Loading Information placard.

### Number of seats

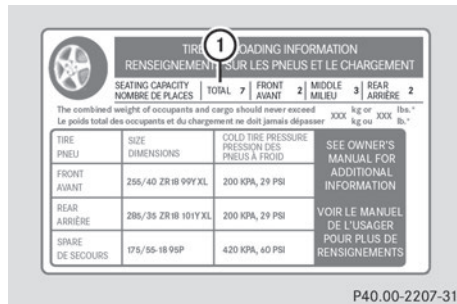

P40.00-2207-31

Maximum number of seats ① indicates the maximum number of occupants allowed to travel in the vehicle. This information can be found on the Tire and Loading Information placard.

- ① The specifications shown on the Tire and Loading Information placard in the illustration are examples. The number of seats is vehicle-specific and can differ from the details shown. The number of seats in your vehicle can be found on the Tire and Loading Information placard.

### Determining the correct load limit

#### Step-by-step instructions

The following steps have been developed as required of all manufacturers under Title 49, Code of U.S. Federal Regulations, Part 575 pursuant to the "National Traffic and Motor Vehicle Safety Act of 1966".

- **Step 1:** Locate the statement "The combined weight of occupants and cargo should never exceed XXX kg or XXX lbs." on your vehicle's Tire and Loading Information placard.
- **Step 2:** Determine the combined weight of the driver and passengers that will be riding in your vehicle.
- **Step 3:** Subtract the combined weight of the driver and passengers from XXX kilograms or XXX lbs.

- ▶ **Step 4:** The resulting figure equals the available amount of cargo and luggage load capacity. For example, if the "XXX" amount equals 1400 lbs and there will be five 150-lb passengers in your vehicle, the amount of available cargo and luggage load capacity is 650 lbs ( $1400 - 750 (5 \times 150) = 650$  lbs).
- ▶ **Step 5:** Determine the combined weight of luggage and cargo being loaded on the vehicle. That weight may not safely exceed the available cargo and luggage load capacity calculated in step 4.



**Example: steps 1 to 3**

The following table shows examples on how to calculate total and cargo load capacities with varying seating configurations and number and size of occupants. The following examples use a maximum load of 1500 lbs (680 kg). **This is for illustration purposes only.** Make sure you are using the actual load limit for your vehicle stated on your vehicle's Tire and Loading Information placard (▷ page 252).

The greater the combined weight of the occupants, the lower the maximum luggage load.

**Step 1**

	Example 1	Example 2	Example 3
<b>Combined maximum weight of occupants and cargo (data from the Tire and Loading Information placard)</b>	1500 lbs (680 kg)	1500 lbs (680 kg)	1500 lbs (680 kg)

**Step 2**

	Example 1	Example 2	Example 3
<b>Number of people in the vehicle (driver and occupants)</b>	5	3	1
<b>Distribution of the occupants</b>	Front: 2 Rear: 3	Front: 1 Rear: 2	Front: 1
<b>Weight of the occupants</b>	Occupant 1: 150 lbs (68 kg) Occupant 2: 180 lbs (82 kg) Occupant 3: 160 lbs (73 kg) Occupant 4: 140 lbs (63 kg) Occupant 5: 120 lbs (54 kg)	Occupant 1: 200 lbs (91 kg) Occupant 2: 190 lbs (86 kg) Occupant 3: 150 lbs (68 kg)	Occupant 1: 150 lbs (68 kg)
<b>Gross weight of all occupants</b>	750 lbs (340 kg)	540 lbs (245 kg)	150 lbs (68 kg)

## Step 3

	Example 1	Example 2	Example 3
<b>Permissible load (maximum gross vehicle weight rating from the Tire and Loading Information placard minus the gross weight of all occupants)</b>	1500 lbs (680 kg) -750 lbs (340 kg) = 750 lbs (340 kg)	1500 lbs (680 kg) -540 lbs (245 kg) =960 lbs (435 kg)	1500 lbs (680 kg) -150 lbs (68 kg) = 1350 lbs (612 kg)

## Vehicle identification plate

Even if you have calculated the total cargo carefully, you should still make sure that the gross vehicle weight rating and the gross axle weight rating are not exceeded. Details can be found on the vehicle identification plate on the B-pillar on the driver's side of the vehicle (▷ page 252).

**Permissible gross vehicle weight:** the gross weight of the vehicle, all passengers, load and trailer load/noseweight (if applicable) must not exceed the permissible gross vehicle weight.

**Gross axle weight rating:** the maximum permissible weight that can be carried by one axle (front or rear axle).

To ensure that your vehicle does not exceed the maximum permissible values (gross vehicle weight and maximum gross axle weight rating), have your loaded vehicle (including driver, occupants, cargo, and full trailer load if applicable) weighed on a suitable vehicle weighbridge.

## All about wheels and tires

## Uniform Tire Quality Grading Standards

## Overview of Tire Quality Grading Standards

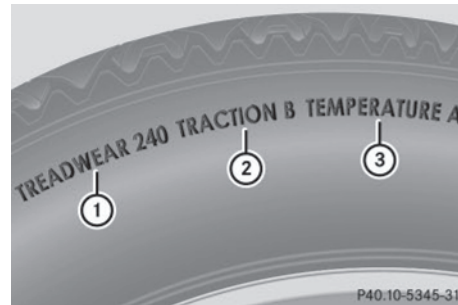

Uniform Tire Quality Grading Standards are U.S. government specifications. Their purpose is to provide drivers with uniform reliable information on tire performance data. Tire manufacturers have to grade tires using three performance factors: ① tread wear grade, ② traction grade and ③ temperature grade. These regulations do not apply to Canada. Nevertheless, all tires sold in North America are provided with the corresponding quality grading markings on the sidewall of the tire.

Where applicable, the tire grading information can be found on the tire sidewall between the tread shoulder and maximum tire width.

Example:

- **Treadwear grade:** 200
- **Traction grade:** AA
- **Temperature grade:** A

All passenger car tires must conform to the statutory safety requirements in addition to these grades.

- i** The actual values for tires are vehicle-specific and may deviate from the values in the illustration.

### Treadwear

The treadwear grade is a comparative rating based on the wear rate of the tire when tested under controlled conditions on a specified U.S. government course. For example, a tire graded 150 would wear one and one-half times as well on the government course as a tire graded 100.

The relative performance of tires depends upon the actual conditions of their use, however, and may depart significantly from the norm, due to variations in driving habits, service practices and differences in road characteristics and climate conditions.

### Traction

#### WARNING

The traction grade assigned to this tire is based on straight-ahead braking traction tests, and does not include acceleration, cornering, hydroplaning, or peak traction characteristics.

- !** Avoid wheelspin. This can lead to damage to the drive train.

The traction grades, from highest to lowest, are AA, A, B, and C. Those grades represent the tire's ability to stop on a wet surface as measured under controlled conditions on specified government test surfaces of asphalt and concrete. A tire marked C may have poor traction performance.

The safe speed on a wet, snow covered or icy road is always lower than on dry road surfaces.

You should pay special attention to road conditions when temperatures are around freezing point.

Mercedes-Benz recommends a minimum tread depth of  $\frac{1}{8}$  in (4 mm) on all four winter tires. Observe the legally required minimum tire tread depth ([▷](#) page 243). Winter tires can reduce the braking distance on snow-covered surfaces in comparison with summer tires. The braking distance is still much further than on surfaces that are not icy or covered with snow. Take appropriate care when driving. Further information on winter tires (M+S tires) can be found in the Digital Operator's Manual.

### Temperature

#### WARNING

The temperature grade for this tire is established for a tire that is properly inflated and not overloaded. Excessive speed, underinflation, or excessive loading, either separately or in combination, can cause excessive heat build-up and possible tire failure.

The temperature grades are A (the highest), B, and C. These represent the tire's resistance to the generation of heat and its ability to dissipate heat when tested under controlled conditions on a specified indoor laboratory test wheel. Sustained high temperature can cause the material of the tire to degenerate and reduce tire life, and excessive temperature can lead to sudden tire failure. The grade C corresponds to a level of performance which all passenger car tires must meet under the Federal Motor Vehicle Safety Standard No. 109. Grades B and A represent higher levels of performance on the laboratory test wheel than the minimum required by law.

## Tire labeling

### Overview

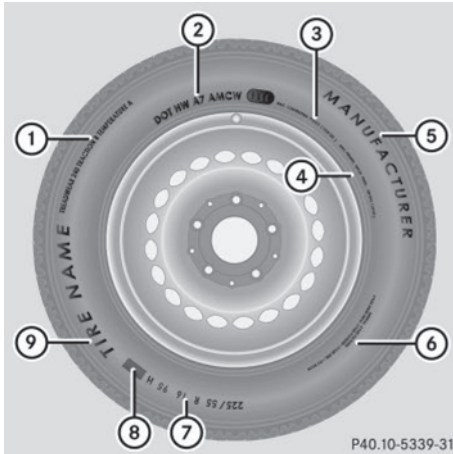

- ① Uniform Tire Quality Grading Standard (▷ page 262)
- ② DOT, Tire Identification Number (▷ page 261)
- ③ Maximum tire load (▷ page 260)
- ④ Maximum tire pressure (▷ page 247)
- ⑤ Manufacturer
- ⑥ Tire material (▷ page 261)
- ⑦ Tire size designation, load-bearing capacity and speed index (▷ page 258)
- ⑧ Load index (▷ page 260)
- ⑨ Tire name

The markings described above are on the tire in addition to the tire name (sales designation) and the manufacturer's name.

- ❗ Tire data is vehicle-specific and may deviate from the data in the example.

### Tire size designation, load-bearing capacity and speed rating

#### WARNING

Exceeding the stated tire load-bearing capacity and the approved maximum speed could lead to tire damage or the tire bursting. There is a risk of accident.

Therefore, only use tire types and sizes approved for your vehicle model. Observe the tire load rating and speed rating required for your vehicle.

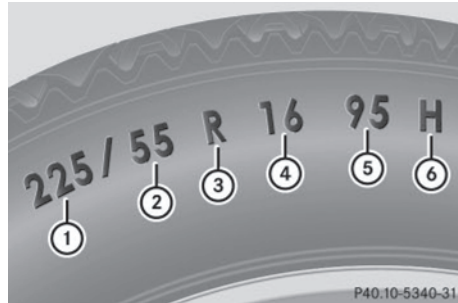

- ① Tire width
- ② Nominal aspect ratio in %
- ③ Tire code
- ④ Rim diameter
- ⑤ Load bearing index
- ⑥ Speed rating

**General:** depending on the manufacturer's standards, the size imprinted in the tire wall may not contain any letters or may contain one letter that precedes the size description.

If there is no letter preceding the size description (as shown above): these are passenger vehicle tires according to European manufacturing standards.

If "P" precedes the size description: these are passenger vehicle tires according to U.S. manufacturing standards.

If "LT" precedes the size description: these are light truck tires according to U.S. manufacturing standards.

If "T" precedes the size description: these are compact emergency spare wheels at high tire pressure, to be used only temporarily in an emergency.

**Tire width:** tire width ① shows the nominal tire width in millimeters.

**Aspect ratio:** aspect ratio ② is the size ratio between the tire height and tire width and is shown in percent. The aspect ratio is

calculated by dividing the tire width by the tire height.

**Tire code:** tire code ③ specifies the tire type. "R" represents radial tires; "D" represents diagonal tires; "B" represents diagonal radial tires.

Optionally, tires with a maximum speed of over 149 mph (240 km/h) may have "ZR" in the size description, depending on the manufacturer (e.g. 245/40 ZR 18).

**Rim diameter:** rim diameter ④ is the diameter of the bead seat, not the diameter of the rim flange. The rim diameter is specified in inches (in).

**Load-bearing index:** load-bearing index ⑤ is a numerical code that specifies the maximum load-bearing capacity of a tire.

Do not overload the tires by exceeding the specified load limit. The maximum permissible load can be found on the vehicle's Tire and Loading Information placard on the B-pillar on the driver's side (▷ page 252).

Example:

Load-bearing index 91 indicates a maximum load of 1356 lb (615 kg) that the tires can bear. For further information on the maximum tire load in kilograms and lbs, see (▷ page 260).

For further information on the load bearing index, see "Load index" (▷ page 260).

**Speed rating:** speed rating ⑥ specifies the approved maximum speed of the tire.

**i** Tire data is vehicle-specific and may deviate from the data in the example.

Regardless of the speed rating, always observe the speed limits. Drive carefully and adapt your driving style to the traffic conditions.

### Summer tires

Index	Speed rating
Q	up to 100 mph (160 km/h)
R	up to 106 mph (170 km/h)

Index	Speed rating
S	up to 112 mph (180 km/h)
T	up to 118 mph (190 km/h)
H	up to 130 mph (210 km/h)
V	up to 149 mph (240 km/h)
W	up to 168 mph (270 km/h)
Y	up to 186 mph (300 km/h)
ZR...Y	up to 186 mph (300 km/h)
ZR...(..Y)	over 186 mph (300 km/h)
ZR	over 149 mph (240 km/h)

- Optionally, tires with a maximum speed of over 149 mph (240 km/h) may have "ZR" in the size description, depending on the manufacturer (e.g. 245/40 ZR 18).

The service specification is made up of load-bearing index ⑤ and speed rating ⑥.

- If the size description of your tire includes "ZR" and there are no service specifications, ask the tire manufacturer in order to find out the maximum speed.

If a service specification is available, the maximum speed is limited according to the speed rating in the service specification. Example: 245/40 ZR 18 97 Y. In this example, "97 Y" is the service specification. The letter "Y" represents the speed rating. The maximum speed of the tire is limited to 186 mph (300 km/h).

- The size description for all tires with maximum speeds of over 186 mph (300 km/h) must include "ZR", **and** the service specification must be given in parentheses. Example: 275/40 ZR 18 (99 Y). Speed rating "(Y)" indicates that the maximum speed of the tire is over 186 mph (300 km/h). Ask the tire manufacturer about the maximum speed.

### All-weather tires and winter tires

Index	Speed rating
Q M+S <sup>1</sup>	up to 100 mph (160 km/h)
T M+S <sup>1</sup>	up to 118 mph (190 km/h)
H M+S <sup>1</sup>	up to 130 mph (210 km/h)
V M+S <sup>1</sup>	up to 149 mph (240 km/h)

**i** Not all tires with the M+S marking provide the driving characteristics of winter tires. In addition to the M+S marking, winter tires also have the  snowflake symbol on the tire wall. Tires with this marking fulfill the requirements of the Rubber Manufacturers Association (RMA) and the Rubber Association of Canada (RAC) regarding the tire traction on snow. They have been especially developed for driving on snow.

An electronic speed limiter prevents your vehicle from exceeding the following speeds:

- all vehicles (except AMG vehicles): 130 mph (210 km/h)
- AMG vehicles: 155 mph (250 km/h)
- AMG vehicles with Performance Package: 186 mph (300 km/h)

The speed rating of tires mounted at the factory may be higher than the maximum speed that the electronic speed limiter permits.

Make sure that your tires have the required speed rating, e.g. when buying new tires. The required speed rating for your vehicle can be found in the "Tires" section (▷ page 269).

Further information about reading tire data can be obtained from any qualified specialist workshop.

### Load index



In addition to the load bearing index, load index **1** may be imprinted after the letters that identify speed index **6** on the sidewall of the tire (▷ page 258).

- If no specification is given: no text (as in the example above), represents a standard load (SL) tire
- XL or Extra Load: represents a reinforced tire
- Light Load: represents a light load tire
- C, D, E: represents a load range that depends on the maximum load that the tire can carry at a certain pressure

**i** Tire data is vehicle-specific and may deviate from the data in the example.

### Maximum load rating

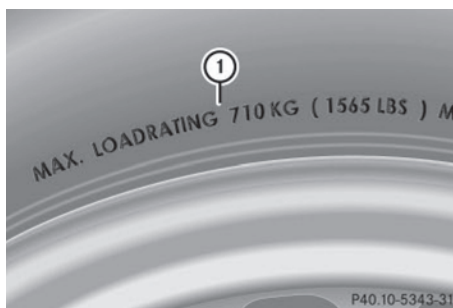

Maximum tire load **1** is the maximum permissible weight for which the tire is approved.

<sup>1</sup> Or M+S  for winter tires.

Do not overload the tires by exceeding the specified load limit. The maximum permissible load can be found on the vehicle's Tire and Loading Information placard on the B-pillar on the driver's side (▷ page 252).

- i** The actual values for tires are vehicle-specific and may deviate from the values in the illustration.

### DOT, Tire Identification Number (TIN)

U.S. tire regulations prescribe that every tire manufacturer or retreader must imprint a TIN in or on the sidewall of every tire produced.

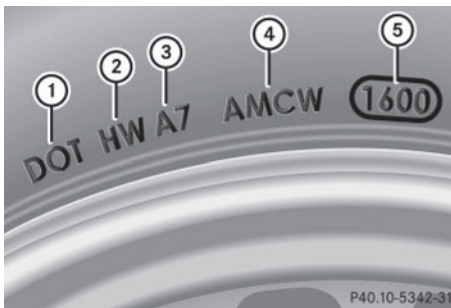

The TIN is a unique identification number. The TIN enables the tire manufacturers or retreaders to inform purchasers of recalls and other safety-relevant matters. It makes it possible for the purchaser to easily identify the affected tires.

The TIN is made up of manufacturer identification code (2), tire size (3), tire type code (4) and manufacturing date (5).

**DOT (Department of Transportation):** tire symbol (1) indicates that the tire complies with the requirements of the U.S. Department of Transportation.

**Manufacturer identification code:** manufacturer identification code (2) provides details on the tire manufacturer. New tires have a code with two symbols. Retreaded tires have a code with four symbols.

For further information about retreaded tires, see (▷ page 242).

**Tire size:** identifier (3) describes the tire size.

**Tire type code:** tire type code (4) can be used by the manufacturer as a code to describe specific characteristics of the tire.

**Date of manufacture:** date of manufacture (5) provides information about the age of a tire. The first and second positions represent the week of manufacture, starting with "01" for the first calendar week. Positions three and four represent the year of manufacture. For example, a tire that is marked with "3208", was manufactured in week 32 in 2008.

- i** Tire data is vehicle-specific and may deviate from the data in the example.

### Tire characteristics

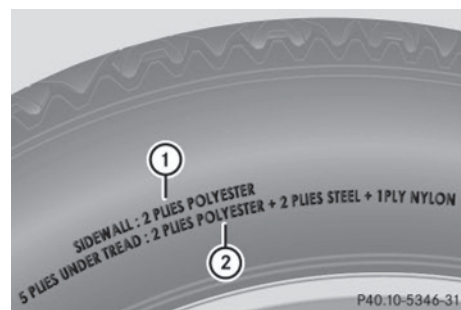

This information describes the type of tire cord and the number of layers in sidewall (1) and under tire tread (2).

- i** Tire data is vehicle-specific and may deviate from the data in the example.

### Definition of terms for tires and loading

#### Tire ply composition and material used

Describes the number of plies or the number of layers of rubber-coated fabric in the tire tread and sidewall. These are made of steel, nylon, polyester and other materials.

#### Bar

Metric unit for tire pressure.

14.5038 pounds per square inch (psi) and

100 kilopascals (kPa) are the equivalent of 1 bar.

### **DOT (Department of Transportation)**

DOT marked tires fulfill the requirements of the United States Department of Transportation.

### **Normal occupant weight**

The number of occupants for which the vehicle is designed multiplied by 68 kilograms (150 lb).

### **Uniform Tire Quality Grading Standards**

A uniform standard to grade the quality of tires with regards to tread quality, tire traction and temperature characteristics. Ratings are determined by tire manufacturers using U.S. government testing procedures. The ratings are molded into the sidewall of the tire.

### **Recommended tire pressure**

The recommended tire pressure applies to the tires mounted at the factory.

The Tire and Loading Information placard contains the recommended tire pressures for cold tires on a fully loaded vehicle and for the maximum permissible vehicle speed.

The tire pressure table contains the recommended pressures for cold tires for various operating conditions, i.e. differing load and speed conditions.

### **Increased vehicle weight due to optional equipment**

This is the combined weight of all standard and optional equipment available for the vehicle, regardless of whether it is actually installed on the vehicle or not.

### **Rim**

This is the part of the wheel on which the tire is mounted.

### **GAWR (Gross Axle Weight Rating)**

The GAWR is the maximum gross axle weight rating. The actual load on an axle must never exceed the gross axle weight rating. The gross axle weight rating can be found on the

vehicle identification plate on the B-pillar on the driver's side.

### **Speed rating**

The speed rating is part of the tire identification. It specifies the speed range for which the tire is approved.

### **GVW (Gross Vehicle Weight)**

The gross vehicle weight includes the weight of the vehicle including fuel, tools, the spare wheel, accessories installed, occupants, luggage and the drawbar noseweight, if applicable. The gross vehicle weight must not exceed the gross vehicle weight rating GVWR as specified on the vehicle identification plate on the B-pillar on the driver's side.

### **GVWR (Gross Vehicle Weight Rating)**

The GVWR is the maximum permissible gross weight of a fully loaded vehicle (the weight of the vehicle including all accessories, occupants, fuel, luggage and the drawbar noseweight, if applicable). The gross vehicle weight rating is specified on the vehicle identification plate on the B-pillar on the driver's side.

### **Maximum loaded vehicle weight**

The maximum weight is the sum of:

- the curb weight of the vehicle
- the weight of the accessories
- the load limit
- the weight of the factory installed optional equipment

### **Kilopascal (kPa)**

Metric unit for tire pressure. 6.9 kPa corresponds to 1 psi. Another unit for tire pressure is bar. There are 100 kilopascals (kPa) to 1 bar.

### **Load index**

In addition to the load-bearing index, the load index may also be imprinted on the sidewall of the tire. This specifies the load-bearing capacity more precisely.



**Curb weight**

The weight of a vehicle with standard equipment including the maximum capacity of fuel, oil and coolant. It also includes the air-conditioning system and optional equipment if these are installed in the vehicle, but does not include passengers or luggage.

**Maximum load rating**

The maximum tire load is the maximum permissible weight in kilograms or lbs for which a tire is approved.

**Maximum permissible tire pressure**

Maximum permissible tire pressure for one tire.

**Maximum load on one tire**

Maximum load on one tire. This is calculated by dividing the maximum axle load of one axle by two.

**PSI (pounds per square inch)**

A standard unit of measure for tire pressure.

**Aspect ratio**

Relationship between tire height and tire width in percent.

**Tire pressure**

This is pressure inside the tire applying an outward force to each square inch of the tire's surface. The tire pressure is specified in pounds per square inch (psi), in kilopascal (kPa) or in bar. The tire pressure should only be corrected when the tires are cold.

**Cold tire pressure**

The tires are cold:

- if the vehicle has been parked without direct sunlight on the tires for at least three hours and
- if the vehicle has been driven for less than 1 mile (1.6 km).

**Tread**

The part of the tire that comes into contact with the road.

**Bead**

The tire bead ensures that the tire sits securely on the wheel. There are several steel wires in the bead to prevent the tire from coming loose from the wheel rim.

**Sidewall**

The part of the tire between the tread and the bead.

**Weight of optional extras**

The combined weight of those optional extras that weigh more than the replaced standard parts and more than 2.3 kilograms (5 lbs). These optional extras, such as high-performance brakes, level control, a roof rack or a high-performance battery, are not included in the curb weight and the weight of the accessories.

**TIN (Tire Identification Number)**

This is a unique identifier which can be used by a tire manufacturer to identify tires, for example for a product recall, and thus identify the purchasers. The TIN is made up of the manufacturer's identity code, tire size, tire type code and the manufacturing date.

**Load bearing index**

The load bearing index (also load index) is a code that contains the maximum load bearing capacity of a tire.

**Traction**

Traction is the result of friction between the tires and the road surface.

**Treadwear indicators**

Narrow bars (tread wear bars) that are distributed over the tire tread. If the tire tread is level with the bars, the wear limit of  $\frac{1}{16}$  in (1.6 mm) has been reached.

**Occupant distribution**

The distribution of occupants in a vehicle at their designated seating positions.

**Total load limit**

Rated cargo and luggage load plus 68 kilograms (150 lb) multiplied by the number of seats in the vehicle.

**Changing a wheel****Flat tire**

The "Breakdown assistance" section (▷ page 228) contains information and notes on how to deal with a flat tire. Information on driving with MOExtended tires in the event of a flat tire can be found under "MOExtended tires (tires with run-flat characteristics)" (▷ page 229).

**Vehicle with emergency spare wheel:** in the event of a flat tire, the emergency spare wheel is mounted as described under "Mounting a wheel" (▷ page 265).

**Rotating the wheels** **WARNING**

Interchanging the front and rear wheels may severely impair the driving characteristics if the wheels or tires have different dimensions. The wheel brakes or suspension components may also be damaged. There is a risk of accident.

Rotate front and rear wheels only if the wheels and tires are of the same dimensions.

**!** On vehicles equipped with a tire pressure monitor, electronic components are located in the wheel.

Tire-mounting tools should not be used near the valve. This could damage the electronic components.

Only have tires changed at a qualified specialist workshop.

Always observe the instructions and safety notes in the "Mounting a wheel" section (▷ page 265).

The wear patterns on the front and rear tires differ, depending on the operating conditions. Rotate the wheels before a clear wear pattern has formed on the tires. Front tires typically wear more on the shoulders and the rear tires in the center.

If your vehicle's tire configuration allows, you can rotate the wheels according to the intervals in the tire manufacturer's warranty book in your vehicle documents. If no warranty book is available, the tires should be rotated every 3,000 to 6,000 miles (5,000 to 10,000 km), or earlier if tire wear requires. Do not change the direction of wheel rotation.

Clean the contact surfaces of the wheel and the brake disc thoroughly every time a wheel is rotated. Check the tire pressure and, if necessary, restart the tire pressure loss warning system or the tire pressure monitor.

**Direction of rotation**

Tires with a specified direction of rotation have additional benefits, e.g. if there is a risk of hydroplaning. You will only gain these benefits if the correct direction of rotation is maintained.

An arrow on the sidewall of the tire indicates its correct direction of rotation.

**Storing wheels**

Store wheels that are not being used in a cool, dry and preferably dark place. Protect the tires from oil, grease, gasoline and diesel.

**Cleaning the wheels** **WARNING**

The water jet from a circular jet nozzle (dirt blasters) can cause invisible exterior damage to the tires or chassis components.

Components damaged in this way may fail unexpectedly. There is a risk of an accident.

Do not use power washers with circular jet nozzles to clean the vehicle. Have damaged tires or chassis components replaced immediately.

### Mounting a wheel

#### Preparing the vehicle

- ▶ Stop the vehicle on solid, non-slippery and level ground.
- ▶ Apply the parking brake.
- ▶ Bring the front wheels into the straight-ahead position.
- ▶ Shift the transmission to position **P**.
- ▶ Vehicles with AIRMATIC: make sure that "normal" level is selected (▷ page 140).
- ▶ Switch off the engine.
- ▶ **Vehicles without KEYLESS-GO:** remove the SmartKey from the ignition lock.
- ▶ **Vehicles with KEYLESS-GO:** open the driver's door.  
The on-board electronics now have status **0**. This is the same as the SmartKey having been removed.
- ▶ **Vehicles with KEYLESS-GO:** remove the Start/Stop button from the ignition lock (▷ page 121).
- ▶ If included in the vehicle equipment, remove the tire-change tool kit from the vehicle (▷ page 228).
- ▶ Secure the vehicle to prevent it from rolling away.

#### Securing the vehicle to prevent it from rolling away

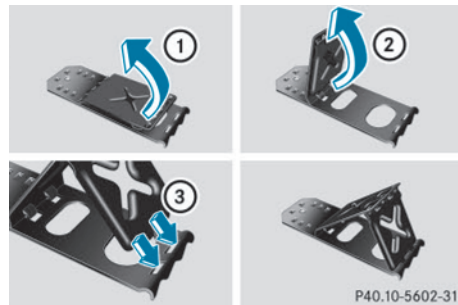

If your vehicle is equipped with a wheel chock, it can be found in the tire-change tool kit (▷ page 228).

The folding wheel chock is an additional safety measure to prevent the vehicle from rolling away, for example when changing a wheel.

- ▶ Fold both plates upwards ①.
- ▶ Fold out lower plate ②.
- ▶ Guide the lugs on the lower plate fully into the openings in base plate ③.



Securing the vehicle on level ground

- ▶ **On level ground:** place chocks or other suitable items under the front and rear of the wheel that is diagonally opposite the wheel you wish to change.

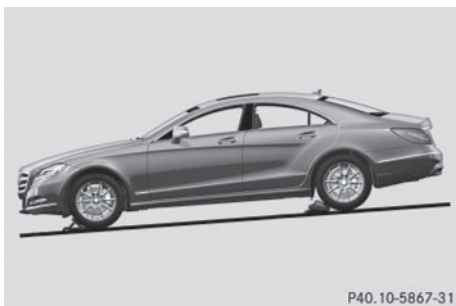

P40.10-5867-31

Securing the vehicle on slight downhill gradients

- **On light downhill gradients:** place chocks or other suitable items in front of the wheels of the front and rear axle.

### Raising the vehicle

#### **WARNING**

If you do not position the jack correctly at the appropriate jacking point of the vehicle, the jack could tip over with the vehicle raised. There is a risk of injury.

Only position the jack at the appropriate jacking point of the vehicle. The base of the jack must be positioned vertically, directly under the jacking point of the vehicle.

- ❗ The jack is designed exclusively for jacking up the vehicle at the jacking points. Otherwise, your vehicle could be damaged.

Observe the following when raising the vehicle:

- to raise the vehicle, only use the vehicle-specific jack that has been tested and approved by Mercedes-Benz. If used incorrectly, the jack could tip over with the vehicle raised.
- the jack is designed only to raise and hold the vehicle for a short time while a wheel is being changed. It is not suited for performing maintenance work under the vehicle.
- avoid changing the wheel on uphill and downhill slopes.

- before raising the vehicle, secure it from rolling away by applying the parking brake and inserting wheel chocks. Never disengage the parking brake while the vehicle is raised.
- the jack must be placed on a firm, flat and non-slip surface. On a loose surface, a large, load-bearing underlay must be used. On a slippery surface, a non-slip underlay must be used, e.g. rubber mats.
- do not use wooden blocks or similar objects as a jack underlay. Otherwise, the jack will not be able to achieve its load-bearing capacity due to the restricted height.
- make sure that the distance between the underside of the tires and the ground does not exceed 1.2 in (3 cm).
- never place your hands and feet under the raised vehicle.
- never lie under the raised vehicle.
- never start the engine when the vehicle is raised.
- never open or close a door or the trunk lid when the vehicle is raised.
- make sure that no persons are present in the vehicle when the vehicle is raised.

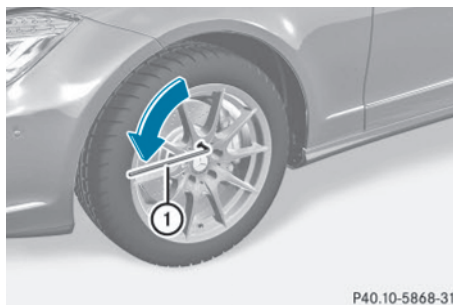

P40.10-5868-31

- Using lug wrench ①, loosen the bolts on the wheel you wish to change by about one full turn. Do not unscrew the bolts completely.

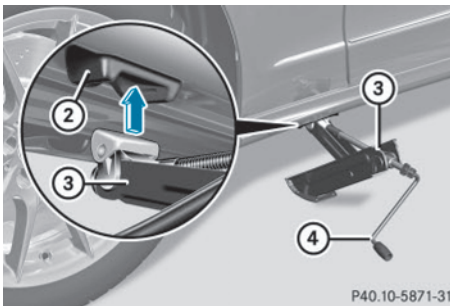
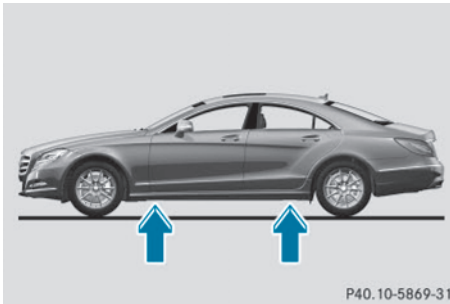

- ▶ Position jack (3) at jacking point (2).

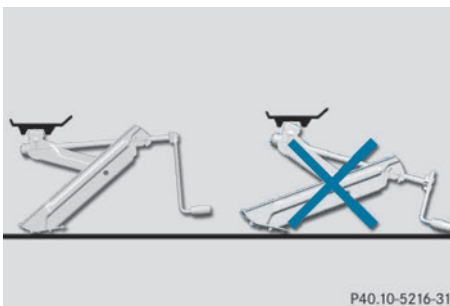

Example

- ▶ Make sure the foot of the jack is directly beneath the jacking point.
- ▶ Turn crank (4) clockwise until jack (3) sits completely on jacking point (2) and the base of the jack lies evenly on the ground.
- ▶ Turn crank (4) until the tire is raised a maximum of 1.2 in (3 cm) off the ground.

Removing a wheel

**!** **AMG vehicles:** during removal and repositioning of the wheel, the wheel rim can strike the ceramic-brake disc and damage it. Therefore, take precautions and get a second person to assist you. Alternatively, you can use a second alignment bolt.

**!** Do not place wheel bolts in sand or on a dirty surface. The bolt and wheel hub threads could otherwise be damaged when you screw them in.

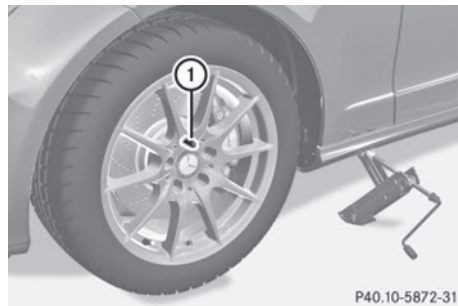

- ▶ Unscrew the uppermost wheel bolt completely.
- ▶ Screw alignment bolt (1) into the thread instead of the wheel bolt.
- ▶ Unscrew the remaining wheel bolts fully.
- ▶ Remove the wheel.

Mounting a new wheel

**!** **WARNING**

Oiled or greased wheel bolts or damaged wheel bolts/hub threads can cause the wheel bolts to come loose. As a result, you could lose a wheel while driving. There is a risk of accident.

Never oil or grease wheel bolts. In the event of damage to the threads, contact a qualified specialist workshop immediately. Have the damaged wheel bolts or hub threads replaced/renewed. Do not continue driving.

**⚠ WARNING**

If you tighten the wheel bolts or wheel nuts when the vehicle is raised, the jack could tip over. There is a risk of injury.

Only tighten the wheel bolts or wheel nuts when the vehicle is on the ground.

Always pay attention to the instructions and safety notes in the "Changing a wheel" section (▷ page 264).

Only use wheel bolts that have been designed for the wheel and the vehicle. For safety reasons, Mercedes-Benz recommends that you only use wheel bolts which have been approved for Mercedes-Benz vehicles and the respective wheel.

**! AMG vehicle with ceramic brake**

**discs:** during removal and repositioning of the wheel, the wheel rim can strike the ceramic-brake disc and damage it.

Therefore, take precautions and have a second person assist you. Alternatively, you can use a second alignment bolt.

**!** To prevent damage to the paintwork, hold the wheel securely against the wheel hub while screwing in the first wheel bolt.

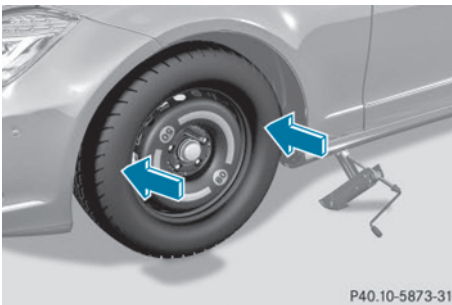

Positioning a wheel (example: vehicle with an emergency spare wheel)

- ▶ Clean the wheel and wheel hub contact surfaces.
- ▶ Slide the wheel to be mounted onto the alignment bolt and push it on.
- ▶ Tighten the wheel bolts until they are finger-tight.

- ▶ Unscrew the alignment bolt.
- ▶ Tighten the last wheel bolt until it is finger-tight.
- ▶ **Vehicles with a collapsible spare wheel:** inflate the collapsible spare wheel (▷ page 276).  
Only then lower the vehicle.

**Lowering the vehicle****⚠ WARNING**

The wheels could work loose if the wheel nuts and bolts are not tightened to the specified tightening torque. There is a risk of accident. Have the tightening torque immediately checked at a qualified specialist workshop after a wheel is changed.

**! Vehicles with a collapsible spare**

**wheel:** before lowering the vehicle, inflate the collapsible spare wheel with the tire inflation compressor. The wheel rim could otherwise be damaged.

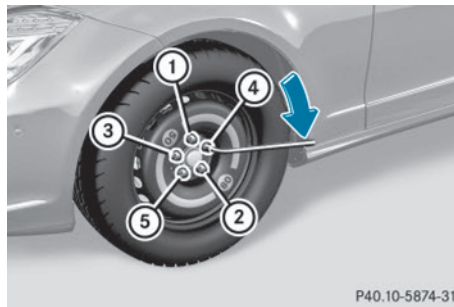

Tightening the wheel nuts (example: vehicle with an emergency spare wheel)

- ▶ Turn the crank of the jack counter-clockwise until the vehicle is once again standing firmly on the ground.
- ▶ Place the jack to one side.
- ▶ Tighten the wheel bolts evenly in a crosswise pattern in the sequence indicated (① to ⑤). The specified tightening torque is **96 lb-ft (130 Nm)**.
- ▶ Turn the jack back to its initial position.

- ▶ Stow the jack and the rest of the vehicle tools in the trunk again.
- ▶ Check the tire pressure of the newly mounted wheel and adjust it if necessary. Observe the recommended tire pressure (> page 244).

**i** Vehicles with tire pressure monitor: all wheels mounted must be equipped with functioning sensors.

## Wheel and tire combinations

### General notes

**!** For safety reasons, Mercedes-Benz recommends that you only use tires and wheels which have been approved by Mercedes-Benz specifically for your vehicle.

These tires have been specially adapted for use with the control systems, such as ABS or ESP®, and are marked as follows:

- MO = Mercedes-Benz Original
- MOE = Mercedes-Benz Original Extended (tires featuring run-flat characteristics)
- MO1 = Mercedes-Benz Original (only certain AMG tires)

Mercedes-Benz Original Extended tires may only be used on wheels that have been specifically approved by Mercedes-Benz.

Only use tires, wheels or accessories tested and approved by Mercedes-Benz. Certain characteristics, e.g. handling, vehicle noise emissions or fuel consumption, may otherwise be adversely affected. In addition, when driving with a load, tire dimension variations could cause the tires to come into contact with the bodywork and axle components. This could result in damage to the tires or the vehicle.

Mercedes-Benz accepts no liability for damage resulting from the use of tires, wheels or accessories other than those tested and approved.

Information on tires, wheels and approved combinations can be obtained from any qualified specialist workshop.

Overview of abbreviations used in the following tire tables:

- BA: both axles
- FA: front axle
- RA: rear axle

The recommended pressures for various operating conditions can be found:

- on the Tire and Loading Information placard with the recommended tire pressures on the B-pillar on the driver's side
- in the tire pressure table on the inside of the fuel filler flap

Observe the notes on recommended tire pressures under various operating conditions (> page 244).

Check tire pressures regularly, and only when the tires are cold. Comply with the maintenance recommendations of the tire manufacturer in the vehicle document wallet.

Notes on the vehicle equipment – always equip the vehicle with:

- tires of the same size on a given axle (left/right)
- the same type of tires at a given time (summer tires, winter tires, MOExtended tires)

Vehicles with MOExtended tires are not equipped with a TIREFIT kit at the factory. It is therefore recommended that you additionally equip your vehicle with a TIREFIT kit if you mount tires that do not feature run-flat properties, e.g. winter tires. A TIREFIT kit may be obtained from a qualified specialist workshop.

**i** Not all wheel and tire combinations are available at the factory for all countries.

**i** On the following pages, you can find information on approved wheel rims and tire sizes for equipping your vehicle with winter tires. Winter tires are not available

at the factory as standard equipment or optional extras.

If you would like to equip your vehicle with approved winter tires, you may also, in certain circumstances, require rims of the appropriate size. The sizes of the approved winter tires may deviate from that of the standard tires. This is dependent on the model and the equipment installed at the factory.

The tires and wheel rims, as well as further information, can be obtained at a qualified specialist workshop.



## Tires

## CLS 550

## Summer tires

## R18

Tires	Alloy wheels
FA: 255/40 R18 99 Y XL MOExtended <sup>2</sup> RA: 285/35 R18 97 Y MOExtended <sup>2,3</sup>	FA: 8.5 J x 18 H2 Wheel offset: 1.36 in (34.5 mm) RA: 9.5 J x 18 H2 Wheel offset: 1.89 in (48 mm)

## R19

Tires	Alloy wheels
FA: 255/35 R19 96 Y XL RA: 285/30 R19 98 Y XL <sup>3</sup>	FA: 8.5 J x 19 H2 Wheel offset: 1.36 in (34.5 mm) RA: 9.5 J x 19 H2 Wheel offset: 1.89 in (48 mm)



## All-weather tires

## R18

Tires	Alloy wheels
FA: 255/40 R18 99 H XL M+S RA: 285/35 R18 97 H M+S <sup>3</sup>	FA: 8.5 J x 18 H2 Wheel offset: 1.36 in (34.5 mm) RA: 9.5 J x 18 H2 Wheel offset: 1.89 in (48 mm)

## Winter tires

## R18

Tires	Alloy wheels
BA: 255/40 R18 99 V XL M+S 	BA: 8.5 J x 18 H2 Wheel offset: 1.36 in (34.5 mm)
BA: 255/40 R18 99 V XL M+S  MOExtended <sup>2</sup>	BA: 8.5 J x 18 H2 Wheel offset: 1.36 in (34.5 mm)

<sup>2</sup> MOExtended tires (tires featuring run-flat characteristics) only in combination with an active tire pressure loss warning system or tire pressure monitor.

<sup>3</sup> Use of snow chains is not permitted. Observe the notes under "Snow chains".

## CLS 550 4MATIC

### Summer tires

#### R18

Tires	Alloy wheels
FA: 255/40 R18 99 Y XL MOExtended <sup>2</sup> RA: 285/35 R18 97 Y MOExtended <sup>2, 3</sup>	FA: 8.5 J x 18 H2 Wheel offset: 1.36 in (34.5 mm) RA: 9.5 J x 18 H2 Wheel offset: 1.89 in (48 mm)

#### R19

Tires	Alloy wheels
FA: 255/35 R19 96 Y XL RA: 285/30 R19 98 Y XL <sup>3</sup>	FA: 8.5 J x 19 H2 Wheel offset: 1.36 in (34.5 mm) RA: 9.5 J x 19 H2 Wheel offset: 1.89 in (48 mm)



### All-weather tires

#### R18

Tires	Alloy wheels
FA: 255/40 R18 99 H XL M+S RA: 285/35 R18 97 H M+S <sup>3</sup>	FA: 8.5 J x 18 H2 Wheel offset: 1.36 in (34.5 mm) RA: 9.5 J x 18 H2 Wheel offset: 1.89 in (48 mm)

### Winter tires

#### R18

Tires	Alloy wheels
BA: 255/40 R18 99 V XL M+S 	BA: 8.5 J x 18 H2 Wheel offset: 1.36 in (34.5 mm)
BA: 255/40 R18 99 V XL M+S  MOExtended <sup>2</sup>	BA: 8.5 J x 18 H2 Wheel offset: 1.36 in (34.5 mm)





<sup>2</sup> MOExtended tires (tires featuring run-flat characteristics) only in combination with an active tire pressure loss warning system or tire pressure monitor.

<sup>3</sup> Use of snow chains is not permitted. Observe the notes under "Snow chains".

**CLS 63 AMG 4MATIC****Summer tires****R19**

Tires	Alloy wheels
FA: 255/35 ZR19 (96 Y) XL RA: 285/30 ZR19 (98 Y) XL <sup>3</sup>	FA: 9.0 J x 19 H2 Wheel offset: 1.46 in (37 mm) RA: 10.0 J x 19 H2 Wheel offset: 1.85 in (47 mm)

**Winter tires****R19**

Tires	Alloy wheels
FA: 255/35 R19 96 V XL M+S  RA: 255/35 R19 96 V XL M+S 	FA: 9.0 J x 19 H2 Wheel offset: 1.46 in (37 mm) RA: 9.5 J x 19 H2 Wheel offset: 2.05 in (52 mm)
FA: 255/35 R19 96 V XL M+S  RA: 285/30 R19 98 V XL M+S  <sup>3</sup>	FA: 9.0 J x 19 H2 Wheel offset: 1.46 in (37 mm) RA: 10.0 J x 19 H2 Wheel offset: 1.85 in (47 mm)

**CLS 63 AMG S-MODEL 4MATIC****Summer tires****R19**





Tires	Alloy wheels
FA: 255/35 ZR19 (96 Y) XL <sup>4</sup> RA: 285/30 ZR19 (98 Y) XL <sup>3,4</sup>	FA: 9.0 J x 19 H2 Wheel offset: 1.46 in (37 mm) RA: 10.0 J x 19 H2 Wheel offset: 1.85 in (47 mm)

<sup>3</sup> Use of snow chains is not permitted. Observe the notes under "Snow chains".

<sup>4</sup> Observe notes on "Large wheels" under "General notes" in "Wheel/tire combination".

## Winter tires

## R19

Tires	Alloy wheels
FA: 255/35 R19 96 V XL M+S  4 RA: 255/35 R19 96 V XL M+S  4, 5	FA: 9.0 J x 19 H2 Wheel offset: 1.46 in (37 mm) RA: 9.5 J x 19 H2 Wheel offset: 2.05 in (52 mm)
FA: 255/35 R19 96 V XL M+S  4 RA: 285/30 R19 98 V XL M+S  3, 4	FA: 9.0 J x 19 H2 Wheel offset: 1.46 in (37 mm) RA: 10.0 J x 19 H2 Wheel offset: 1.85 in (47 mm)

## Emergency spare wheel

## Important safety notes

 **WARNING**

The wheel or tire size as well as the tire type of the spare wheel or emergency spare wheel and the wheel to be replaced may differ. Mounting an emergency spare wheel may severely impair the driving characteristics. There is a risk of an accident.

To avoid hazardous situations:

- adapt your driving style accordingly and drive carefully.
- never mount more than one spare wheel or emergency spare wheel that differs in size.
- only use a spare wheel or emergency spare wheel of a different size briefly.
- do not switch ESP® off.
- have a spare wheel or emergency spare wheel of a different size replaced at the nearest qualified specialist workshop. Observe that the wheel and tire dimensions as well as the tire type must be correct.

When using an emergency spare wheel or spare wheel of a different size, you must not

exceed the maximum speed of 50 mph (80 km/h).

Snow chains must not be mounted on emergency spare wheels.

## General notes

You should regularly check the pressure of the emergency spare wheel, particularly prior to long trips, and correct the pressure as necessary (▷ page 244). The value on the wheel is valid. In addition, the emergency spare wheel tire pressure can be found under "Technical data" (▷ page 277).

An emergency spare wheel may also be mounted against the direction of rotation. Observe the time restriction on use as well as the speed limitation specified on the emergency spare wheel.

Replace the tires after six years at the latest, regardless of wear. This also applies to the emergency spare wheel.

**i** When you are driving with the collapsible spare wheel mounted, the tire pressure loss warning system or the tire pressure monitor cannot function reliably. Only restart the tire pressure loss warning

4 Observe notes on "Large wheels" under "General notes" in "Wheel/tire combination".

5 Only fine-link snow chains are permitted.

3 Use of snow chains is not permitted. Observe the notes under "Snow chains".

system/the tire pressure monitor when the damaged wheel has been replaced with a new wheel.

**Vehicles with tire pressure monitor:** after mounting an emergency spare wheel, the system may still display the tire pressure of the removed wheel for a few minutes. The value displayed for the mounted emergency spare wheel is not the same as the current tire pressure of the emergency spare wheel.

### "Minispare" emergency spare wheel/ collapsible spare wheel

#### Removing the "Minispare" emergency spare wheel

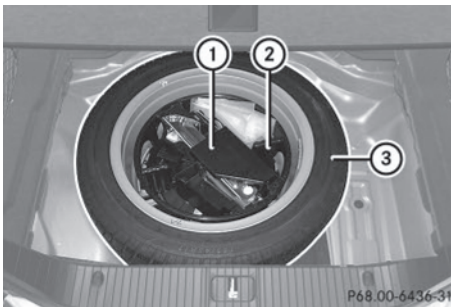

The emergency spare wheel can be found in the stowage well under the trunk floor.

- ▶ Lift the trunk floor upwards (> page 207).
- ▶ Turn stowage tray ② counter-clockwise and remove together with vehicle tool kit tray ①.
- ▶ Remove "Minispare" emergency spare wheel ③.

#### Removing the collapsible spare wheel (AMG vehicles)

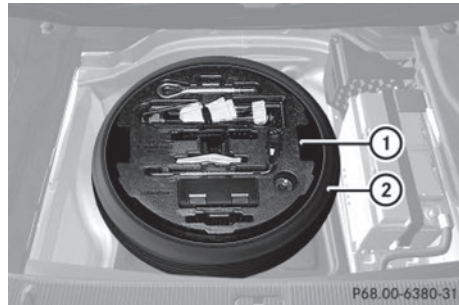

The emergency spare wheel can be found in the stowage well under the trunk floor.

- ▶ Lift the trunk floor upwards (> page 207).
- ▶ Reach into cutout ① in the tool holder and lift it up.
- ▶ Remove collapsible spare wheel ②.

Always observe the instructions and safety notes in the "Mounting a wheel" section (> page 265).

#### Stowing a used collapsible spare wheel

- ❗ Only place the collapsible spare wheel in the vehicle when it is dry. Otherwise, moisture may get into the vehicle.

Take the following steps to stow a used collapsible spare wheel. It will not otherwise install into the spare wheel well. Mercedes-Benz recommends that you have this work performed at a qualified specialist workshop, e.g. at an authorized Mercedes-Benz Center.

- ▶ Unscrew the valve cap from the valve.
- ▶ Use the back of the valve cap to unscrew the valve insert from the valve and release the air.

**i** Fully deflating the tires can take a few minutes.

- ▶ Screw the valve insert back into the valve.
- ▶ Screw the valve cap back on.

- ▶ Remove the protective sheet from the vehicle tool kit and pull it over the collapsible spare wheel.
- ▶ Stow the collapsible spare wheel in the emergency spare wheel well under the trunk.

### Inflating the collapsible spare wheel

- ! Inflate the collapsible spare wheel using the tire inflation compressor before lowering the vehicle. The wheel rim could otherwise be damaged.
- ! Do not operate the tire inflation compressor for longer than eight minutes at a time without a break. It may otherwise overheat.  
The tire inflation compressor can be operated again once it has cooled down.

## Wheels and tires

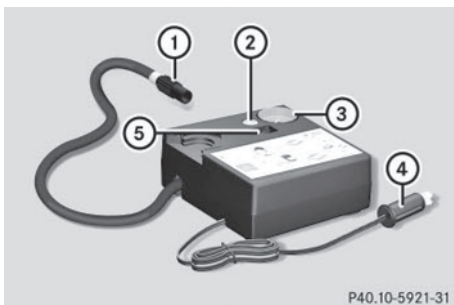

- ▶ Insert connector ④ into the cigarette lighter socket (▷ page 208) or into a 12 V socket (▷ page 208) in your vehicle.
  - ▶ Turn the SmartKey to position **1** in the ignition lock (▷ page 121).
  - ▶ Press on/off switch ⑤ on the tire inflation compressor to **I**.  
The tire inflation compressor is switched on. The tire is inflated. The tire pressure is shown on pressure gauge ③.
  - ▶ Inflate the tire to the specified tire pressure.  
The specified tire pressure is printed on the yellow label of the emergency spare wheel.
  - ▶ When the specified tire pressure has been reached, press on/off switch ⑤ on the electric air pump to **0**.  
The tire inflation compressor is switched off.
  - ▶ Turn the SmartKey to position **0** in the ignition lock.
  - ▶ If the tire pressure is higher than the specified pressure, press pressure release button ② until the correct tire pressure has been reached.
  - ▶ Unscrew union nut ① on the air hose from the valve.
  - ▶ Screw the valve cap onto the collapsible spare wheel valve again.
  - ▶ Stow plug ④ and the air hose in the lower section of the blower housing.
  - ▶ Stow the tire inflation compressor in the vehicle.
- ▶ Mount the collapsible spare wheel as described (▷ page 264).  
The collapsible spare wheel must be mounted before it is inflated.
  - ▶ Pull connector ④ and the air hose out of the housing.
  - ▶ Remove the cap from the valve on the collapsible spare wheel.
  - ▶ Screw union nut ① on the air hose onto the valve.
  - ▶ Make sure on/off switch ⑤ of the tire inflation compressor is set to **0**.

**Technical data****All vehicles (except AMG vehicles)****"Minispare" emergency spare wheel**

<b>Tires</b>	<b>Alloy wheels</b>
T 155/70 R17 110 M <sup>6,7</sup> Tire pressure: 420 kPa (4.2 bar/61 psi)	4.0 B x 17 H2 <sup>6,7</sup> Wheel offset: 1.34 in (34 mm)
T 155/60 R18 107 M Tire pressure: 420 kPa (4.2 bar/61 psi)	4.5 B x 18 H2 Wheel offset: 1.42 in (36 mm)

**AMG vehicles****Collapsible spare wheel**

<b>Tires</b>	<b>Alloy wheels</b>
175/50 - 19 97 P Tire pressure: 350 kPa (3.5 bar/51 psi)	6.5 B x 19 H2 Wheel offset: 0.55 in (14 mm)

<sup>6</sup> Not in conjunction with Sports package code 950.

<sup>7</sup> Not for CLS 550 and CLS 550 4MATIC.





<b>Useful information .....</b>	<b>280</b>
<b>Information regarding technical data .....</b>	<b>280</b>
<b>Warranty .....</b>	<b>280</b>
<b>Identification plates .....</b>	<b>280</b>
<b>Service products and filling capacities .....</b>	<b>280</b>
<b>Vehicle data .....</b>	<b>285</b>

### Useful information

- i** This Operator's Manual describes all models and all standard and optional equipment of your vehicle available at the time of publication of the Operator's Manual. Country-specific differences are possible. Please note that your vehicle may not be equipped with all features described. This also applies to safety-related systems and functions.
- i** Read the information on qualified specialist workshops: (> page 32).

### Information regarding technical data

#### General information

- i** The data stated here specifically refers to a vehicle with standard equipment. Consult an authorized Mercedes-Benz Center for the data for all vehicle variants and trim levels.

## Technical data

### Warranty

Your vehicle is covered under the terms of the warranties printed in the Service and Warranty Information booklet.

Your authorized Mercedes-Benz Center will replace and repair all factory-installed parts in accordance with the following warranty terms and conditions:

- New Vehicle Limited Warranty
- Emission Systems Warranty
- Emission Performance Warranty
- California, Connecticut, Maine, Massachusetts, New York, Pennsylvania, Rhode Island and Vermont Emission Control System Warranty
- State warranty enforcement laws (Lemon Laws)

Replacement parts and accessories are covered by the Mercedes-Benz Parts and

Accessories warranties. These are available at any authorized Mercedes-Benz Center.

- i** If you lose the Service and Warranty Information booklet, contact an authorized Mercedes-Benz Center to arrange a replacement. It will be mailed to you.

### Identification plates

#### Vehicle identification plate with vehicle identification number (VIN)

In the Digital Operator's Manual you will find information on the following topics:

- Vehicle identification plate
- VIN
- Engine number

#### VIN

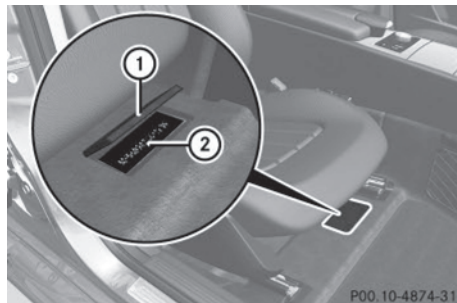

- ▶ Slide the right-hand front seat to its rearmost position.
- ▶ Fold floor covering ① upwards. You will see VIN ②.

### Service products and filling capacities

#### Important safety notes

#### **⚠ WARNING**

Service products may be poisonous and hazardous to health. There is a risk of injury.

Comply with instructions on the use, storage and disposal of service products on the labels of the respective original containers. Always store service products sealed in their original containers. Always keep service products out of the reach of children.

 **Environmental note**

Dispose of service products in an environmentally responsible manner.

Service products include the following:

- Fuels
- Lubricants (e.g. engine oil, transmission oil)
- Coolant
- Brake fluid
- Windshield washer fluid
- Climate control system refrigerant

Comply with all valid regulations with respect to handling, storing, and disposing of service fluids.

Components and service products must be matched. You should therefore only use products that have been tested and approved by Mercedes-Benz.

Information on tested and approved products can be obtained at an authorized Mercedes-Benz Center or on the Internet at <http://bevo.mercedes-benz.com>.

You can recognize service products approved by Mercedes-Benz by the following inscription on the containers:

- MB-Freigabe (e.g. MB-Freigabe 229.51)
- MB Approval (e.g. MB Approval 229.51)

Other designations or recommendations indicate a level of quality or a specification in accordance with an MB Sheet number (e.g. MB 229.5). They have not necessarily been approved by Mercedes-Benz.

## Fuel

### Important safety notes

 **WARNING**

Fuel is highly flammable. If you handle fuel incorrectly, there is a risk of fire and explosion.

You must avoid fire, open flames, creating sparks and smoking. Switch off the engine and, if applicable, the auxiliary heating before refueling.

 **WARNING**

Fuel is poisonous and hazardous to health. There is a risk of injury.

You must make sure that fuel does not come into contact with your skin, eyes or clothing and that it is not swallowed. Do not inhale fuel vapors. Keep fuel away from children.

If you or others come into contact with fuel, observe the following:

- Wash away fuel from skin immediately using soap and water.
- If fuel comes into contact with your eyes, immediately rinse them thoroughly with clean water. Seek medical assistance without delay.
- If fuel is swallowed, seek medical assistance without delay. Do not induce vomiting.
- Immediately change out of clothing which has come into contact with fuel.

### Tank capacity

Model	Total capacity
All models	21.1 US gal (80.0 l)

Model	Of which reserve
AMG vehicles	Approx. 3.7 US gal (14.0 l)
All other models	Approx. 2.4 US gal (9.0 l)

### Engine oil

#### Filling capacities

The following values refer to an oil change including the oil filter.

Model	Capacity
All models (except for AMG vehicles)	8.5 US qt (8.0 l)
All models (AMG vehicles)	9.0 US qt (8.5 l)

### Brake fluid

#### WARNING

The brake fluid constantly absorbs moisture from the air. This lowers the boiling point of the brake fluid. If the boiling point of the brake fluid is too low, vapor pockets may form in the brake system when the brakes are applied hard. This would impair braking efficiency. There is a risk of an accident.

You should have the brake fluid renewed at the specified intervals.

Comply with the important safety notes for service products when handling brake fluid (▷ page 280).

The brake fluid change intervals can be found in the Maintenance Booklet.

Only use brake fluid approved by Mercedes-Benz according to MB Approval 331.0.

Information about approved brake fluid can be obtained at any qualified specialist workshop or on the Internet at <http://bevo.mercedes-benz.com>.

-  Have the brake fluid regularly replaced at a qualified specialist workshop and the replacement confirmed in the Maintenance Booklet.

### Coolant

#### Important safety notes

#### WARNING

If antifreeze comes into contact with hot components in the engine compartment, it may ignite. There is a risk of fire and injury.

Let the engine cool down before you add antifreeze. Make sure that antifreeze is not spilled next to the filler neck. Thoroughly clean the antifreeze from components before starting the engine.

-  Only add coolant that has been premixed with the desired antifreeze protection. You could otherwise damage the engine.

Further information on coolants can be found in the Mercedes-Benz Specifications for Service Products, MB Specifications for Service Products 310.1, e.g. on the Internet at

<http://bevo.mercedes-benz.com>. Or contact a qualified specialist workshop.

-  Always use a suitable coolant mixture, even in countries where high temperatures prevail.

Otherwise, the engine cooling system is not sufficiently protected from corrosion and overheating.

-  Have the coolant regularly replaced at a qualified specialist workshop and the replacement confirmed in the Maintenance Booklet.

Comply with the important safety precautions for service products when handling coolant (▷ page 280).

The coolant is a mixture of water and antifreeze/corrosion inhibitor. It performs the following tasks:

- corrosion protection
- antifreeze protection
- raising the boiling point

If the coolant has antifreeze protection down to -35 °F (-37 °C), the boiling point of the coolant during operation is approximately 266 °F (130 °C).

The antifreeze/corrosion inhibitor concentration in the engine cooling system should:

- be at least 50%. This will protect the engine cooling system against freezing down to approximately -35 °F (-37 °C).
- not exceed 55% (antifreeze protection down to -49 °F [-45 °C]). Otherwise, heat will not be dissipated as effectively.

Mercedes-Benz recommends an antifreeze/corrosion inhibitor concentrate in accordance with MB Specifications for Service Products 310.1.

- i** When the vehicle is first delivered, it is filled with a coolant mixture that ensures adequate antifreeze and corrosion protection.
- i** The coolant is checked with every maintenance interval at a qualified specialist workshop.

### Filling capacities

Model	Capacity
<b>E 63 AMG 4MATIC</b>	Approx. 11.4 US qt (10.8 l)
<b>E 63 AMG S-MODEL 4MATIC</b>	Approx. 11.5 US qt (10.9 l)
<b>All other models</b>	Approx. 13.0 US qt (12.3 l)

- i** Use MB 325.0 or MB 326.0 corrosion inhibitor/antifreeze.

### Windshield washer system and headlamp cleaning system

#### Important safety notes

##### WARNING

Windshield washer concentrate is highly flammable. If it comes into contact with hot engine components or the exhaust system it could ignite. There is a risk of fire and injury. Make sure that no windshield washer concentrate is spilled next to the filler neck.

- !** Only use washer fluid that is suitable for plastic lamp lenses, e.g. MB SummerFit or MB WinterFit. Unsuitable washer fluid could damage the plastic lenses of the headlamps.
- !** Do not add distilled or de-ionized water to the washer fluid container. Otherwise, the level sensor may be damaged.
- !** Only MB SummerFit and MB WinterFit washer fluid should be mixed together. The spray nozzles may otherwise become blocked.

Comply with the important safety notes for service products when handling washer fluid (▷ page 280).

At temperatures above freezing:

- ▶ Fill the washer fluid reservoir with a mixture of water and windshield washer fluid, e.g. MB SummerFit.

Add 1 part MB SummerFit to 100 parts water.

At temperatures below freezing:

- Fill the washer fluid reservoir with a mixture of water and washer fluid, e.g. MB WinterFit.

Adapt the mixing ratio to the outside temperature.

- Down to 14 °F (-10 °C): mix 1 part MB WinterFit to 2 parts water.
- Down to -4 °F (-20 °C): mix 1 part MB WinterFit to 1 part water.
- Down to -20.2 °F (-29 °C): mix 2 parts MB WinterFit to 1 part water.

- ❗ Add windshield washer fluid, e.g. MB SummerFit or MB WinterFit, to the washer fluid all year round.

### Climate control system refrigerant

#### Important safety notes

The climate control system of your vehicle is filled with refrigerant R-134a.

The instruction label regarding the refrigerant type used can be found on the radiator cross member.

- ❗ Only the refrigerant R-134a and the PAG oil approved by Mercedes-Benz may be used. The approved PAG oil may not be mixed with any other PAG oil that is not approved for R-134a refrigerant. Otherwise, the climate control system may be damaged.

Service work, such as adding refrigerant or replacing components, may only be carried out by a qualified specialist workshop. All applicable regulations must be adhered to, SAE standard J639 included.

Always have work on the climate control system carried out at a qualified specialist workshop.

#### Refrigerant instruction label



Example: refrigerant instruction label

- ① Warning symbol
- ② Refrigerant filling capacity
- ③ Applicable SAE standards
- ④ PAG oil part number
- ⑤ Type of refrigerant

Warning symbols ① indicate:

- possible dangers
- having service work carried out at a qualified specialist workshop

#### Filling capacities

Missing values were not available at time of going to print.

AMG vehicles	Capacity
Refrigerant	22.6 ± 0.4 oz (640 ± 10 g)
PAG oil	

All other models	Capacity
Refrigerant	20.8 ± 0.4 oz (590 ± 10 g)
PAG oil	4.2 oz (120 g)

**Vehicle data**

**General notes**

Please note that for the specified vehicle data:

- the heights specified may vary as a result of:
  - tires
  - load
  - condition of the suspension
  - optional equipment
- optional equipment reduces the maximum payload.

**Dimensions and weights**

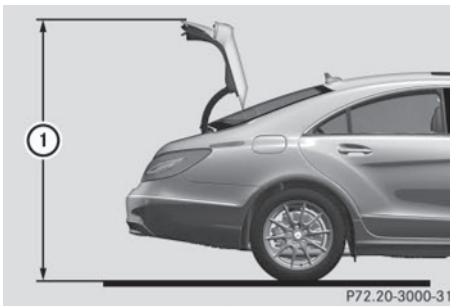

CLS Coupe

Model	① Opening height
CLS 63 AMG 4MATIC	70.6 in (1792 mm)
CLS 63 AMG S-MODEL 4MATIC	
All other models	70.3 in (1786 mm)

**CLS Coupe**

Missing values were not available at time of going to print.

**AMG vehicles**

Vehicle length	196.7 in (4956 mm)
Vehicle width including exterior mirrors	81.5 in (2071 mm)
Vehicle height	55.7 in (1416 mm)
Wheelbase	113.1 in (2874 mm)
Turning radius	38.6 ft (11.75 m)
Maximum roof load	220 lb (100 kg)
Maximum trunk load	

**All other models**

Vehicle length	195.1 in (4956 mm)
Vehicle width including exterior mirrors	81.7 in (2075 mm)
Vehicle height	55.8 in (1418 mm)
Wheelbase	113.1 in (2874 mm)
Turning radius	37.0 ft (11.27 m)
Maximum roof load	220 lb (100 kg)
Maximum trunk load	220 lb (100 kg)









## **Publication details**

### **Internet**

Further information about Mercedes-Benz vehicles and about Daimler AG can be found on the following websites:

<http://www.mbusa.com> (USA only)

<http://www.mercedes-benz.ca> (Canada only)

### **Editorial office**

©Daimler AG: Not to be reprinted, translated or otherwise reproduced, in whole or in part, without written permission from Daimler AG.

### **Vehicle manufacturer**

Daimler AG  
Mercedesstraße 137  
70327 Stuttgart  
Germany



2185842200

Order no. 6515 1513 13 Part no. 218 584 22 00 Edition B 2014