



SLS AMG

Black Series

Operator's Manual



Mercedes-Benz

Symbols

Registered trademarks:

- Bluetooth® is a registered trademark of Bluetooth SIG Inc.
- DTS is a registered trademark of DTS, Inc.
- Dolby and MLP are registered trademarks of DOLBY Laboratories.
- BabySmart™, ESP® and PRE-SAFE® are registered trademarks of Daimler AG.
- HomeLink® is a registered trademark of Johnson Controls.
- iPod® and iTunes® are registered trademarks of Apple Inc.
- Logic7® is a registered trademark of Harman International Industries.
- Microsoft® and Windows media® are registered trademarks of Microsoft Corporation.
- SIRIUS is a registered trademark of Sirius XM Radio Inc.
- HD Radio is a registered trademark of iBiquity Digital Corporation.
- Gracenote® is a registered trademark of Gracenote, Inc.
- ZAGATSurvey® and related brands are registered trademarks of ZagatSurvey, LLC.

In this Operator's Manual you will find the following symbols:

WARNING

Warning notes make you aware dangers which could pose a threat to your health or life, or to the health and life of others.

Environmental note

Environmental notes provide you with information on environmentally aware actions or disposal.

- ! Notes on material damage alert you to dangers that could lead to damage to your vehicle.

- i Practical tips or further information that could be helpful to you.

▶ This symbol indicates an instruction that must be followed.

▶ Several of these symbols in succession indicate an instruction with several steps.

(▷ page) This symbol tells you where you can find more information about a topic.

▷▷ This symbol indicates a warning or an instruction that is continued on the next page.

Display This font indicates a display in the multifunction display/COMAND display.

Parts of the software in the vehicle are protected by copyright © 2005 The FreeType Project <http://www.freetype.org>. All rights reserved.

Welcome to the world of Mercedes-Benz

We urge you to read this Operator's Manual carefully and familiarize yourself with the vehicle before driving. For your own safety and a longer vehicle life, follow the instructions and warning notices in this manual. Ignoring them could result in damage to the vehicle or personal injury to you or others.

Vehicle damage caused by failure to follow instructions is not covered by the Mercedes-Benz Limited Warranty.

The equipment or product designation of your vehicle may vary depending on:

- Model
- Order
- Country specification
- Availability

Mercedes-Benz therefore reserves the right to introduce changes in the following areas:

- Design
- Equipment
- Technical features

The equipment in your vehicle may therefore differ from that shown in the descriptions and illustrations.

The following are integral components of the vehicle:

- Operator's Manual
- Maintenance Booklet
- Equipment-dependent supplements

Keep printed copies of the documents in the vehicle at all times. If you sell the vehicle, always pass the documents on to the new owner.

The technical documentation team at Daimler AG wishes you safe and pleasant motoring.

Mercedes-Benz USA, LLC
Mercedes-Benz Canada, Inc.
A Daimler Company

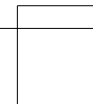
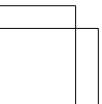
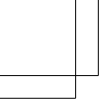

Index 4

Introduction 17

At a glance 25

Safety 35

Opening and closing 61

Seats, steering wheel and mirrors 77

Lights and windshield wipers 89

Climate control 99

Driving and parking 109

On-board computer and displays 137

Stowage and features 185

Maintenance and care 201

Breakdown assistance 215

Wheels and tires 231

Technical data 261

1, 2, 3 ...

12 V socket

see Sockets

4ETS (Electronic Traction System) 55**A****ABS (Anti-lock Braking System)**

Display message 153

Function/notes 54

Warning lamp 178

Activating/deactivating cooling**with air dehumidification 102****ADAPTIVE BRAKE 57****Additional speedometer 146****Additives (engine oil) 266****Adjusting lumbar support 80****Air bags**

Display message 159

Front air bag (driver, front

passenger) 40

Head bag 42

Important safety notes 38

Knee bag 41

PASSENGER AIR BAG OFF

indicator lamp 42

Safety guidelines 37

Side impact air bag 41

Air-conditioning system

see Climate control

Air filter (display message) 168**Air vents**

Important safety notes 107

Setting 107

Setting the center air vents 108

Setting the side air vents 108

Alarm system

see ATA (Anti-Theft Alarm system)

AMG

Adaptive sport suspension system 133

Button for AMG menu 121

E-SELECT lever 113

Menu (on-board computer) 148

SETUP 121

SPEEDSHIFT DCT 7-gear sport

transmission 113

Anti-lock braking system

see ABS (Anti-lock Braking System)

Anti-theft alarm system

see ATA (Anti-Theft Alarm system)

Ashtray 188**ASSYST PLUS service interval****display**

Hiding service messages 206

Service messages 206

ATA (Anti-Theft Alarm system)

Activating/deactivating 58

Function 58

Switching off the alarm 58

Audio menu (on-board computer) 142**Audio system**

see separate operating instructions

Authorized Centers

see Qualified specialist workshop

Authorized Mercedes-Benz Center

see Qualified specialist workshop

Authorized workshops

see Qualified specialist workshop

AUTO lights

Display message 162

Automatic headlamp mode 90**Automatic transmission**

Overview 113

B**BAS (Brake Assist System) 55****Battery**

Display message 172

Battery (SmartKey)

Checking 65

Important safety notes 64

Replacing 65

Battery (vehicle)

Charging 223

Display message 166

Important safety notes 220

Jump starting 224

Blind Spot Assist

Activating/deactivating 145

Display message 169

Notes/function 134

Brake Assist

see BAS (Brake Assist System)

- Brake fluid**
 - Display message 157
 - Notes 267
 - Brake lamps (display message)** 162
 - Brakes**
 - ABS 54
 - BAS 55
 - Brake fluid (notes) 267
 - Display message 153
 - Display messages 153
 - High-performance brake system 129
 - Important safety notes 128
 - Maintenance 129
 - Riding tips 128
 - Warning lamp 176, 178
 - Breakdown**
 - see Flat tire
 - see Towing away/tow-starting
 - Bulbs**
 - see Replacing bulbs
- C**
- California**
 - Important notice for retail customers and lessees 19
 - Calling up a malfunction**
 - see Display messages
 - Capacities**
 - see Technical data
 - Car**
 - see Vehicle
 - Care**
 - Car wash 207
 - Display 212
 - Exhaust pipe 211
 - Exterior lights 211
 - Gear or selector lever 212
 - Matte finish 210
 - Notes 207
 - Paint 209
 - Plastic trim 212
 - Power washer 209
 - Seat belt 213
 - Seat cover 213
 - Steering wheel 212
 - Trim pieces 212
 - Washing by hand 208
 - Wheels 209
 - Windows 210
 - Wiper blades 211
 - Wooden trim 212
 - Car wash (care)** 207
 - CD player/CD changer (on-board computer)** 143
 - Center console**
 - Lower section 31
 - Upper section 30
 - Central locking**
 - Locking/unlocking (SmartKey) 62
 - Changing bulbs**
 - License plate lighting 95
 - Charge maintenance socket** 199
 - Children**
 - In the vehicle 51
 - Restraint systems 51
 - Child seat**
 - Special seat belt retractor 53
 - Top Tether 53
 - Cigarette lighter** 189
 - Climate control**
 - Automatic climate control (dual-zone) 101
 - Controlling automatically 104
 - Cooling with air dehumidification . . 102
 - Defrosting the windows 106
 - Defrosting the windshield 105
 - Important safety notes 100
 - Indicator lamp 104
 - Maximum cooling 105
 - Notes on using automatic climate control 102
 - Overview of systems 100
 - Problems with cooling with air dehumidification 104
 - Problem with the rear window defroster 107
 - Refrigerant 266
 - Refrigerant filling capacity 267
 - Setting the air distribution 104
 - Setting the airflow 105
 - Setting the air vents 107
 - Setting the temperature 104
 - Switching air-recirculation mode on/off 107
 - Switching on/off 102

- Switching the MONO function on/off 105
 - Switching the rear window defroster on/off 106
 - Cockpit**
 - Overview 26
 - see Instrument cluster
 - COMAND**
 - see separate operating instructions
 - Combination switch** 92
 - Consumption statistics (on-board computer)** 141
 - Convenience closing feature** 74
 - Convenience opening feature** 74
 - Coolant**
 - Display message 165
 - Coolant (engine)**
 - Checking the level 204
 - Important safety notes 267
 - Temperature (on-board computer) . 148
 - Cooling**
 - see Climate control
 - Copyright** 23
 - Crash-responsive emergency lighting** 94
 - Cruise control**
 - Cruise control lever 131
 - Deactivating 133
 - Display message 168
 - Driving system 131
 - Function/notes 131
 - Important safety notes 131
 - LIM indicator lamp 131
 - Setting a speed 132
 - Storing and maintaining current speed 132
 - Cup holder**
 - Center console 188
 - Important safety notes 188
 - Curb weight**
 - see Technical data
 - Customer Assistance Center (CAC)** ... 22
 - Customer Relations Department** 22
- D**
- Dashboard**
 - see Cockpit
 - see Instrument cluster
 - Data**
 - see Technical data
 - Daytime running lamps**
 - Display message 163
 - Switching on/off (on-board computer) 146
 - Switching on/off (switch) 90
 - Dealerships**
 - see Qualified specialist workshop
 - Declarations of conformity** 21
 - Delayed switch-off**
 - Exterior lighting (on-board computer) 147
 - Interior lighting 147
 - Diagnostics connection** 21
 - Digital speedometer** 140
 - Display (cleaning instructions)** 212
 - Display messages**
 - ASSYST PLUS service interval display 206
 - Calling up (on-board computer) 152
 - Driving systems 168
 - Engine 165
 - General notes 151
 - Hiding (on-board computer) 152
 - Lights 161
 - Safety systems 158
 - Service interval display 206
 - SmartKey 172
 - Tires 170
 - Vehicle 172
 - Distance recorder** 140
 - see Odometer
 - see Trip odometer
 - Door control panel**
 - Overview 33
 - Doors**
 - Automatic locking (switch) 69
 - Central locking/unlocking (SmartKey) 62
 - Display message 172, 173
 - Emergency locking 70
 - Emergency unlocking 69

- Important safety notes 68
 - Opening (from inside) 69
 - Drinking and driving** 128
 - Drinks holder**
 - see Cup holder
 - Drive program**
 - Automatic 118
 - Manual 120
 - SETUP (on-board computer) 148
 - Drive program display** 114
 - Driver's door**
 - see Doors
 - Driving abroad**
 - Mercedes-Benz Service 207
 - Symmetrical low beam 90
 - Driving lamps**
 - see Daytime running lamps
 - Driving on flooded roads** 130
 - Driving safety systems**
 - ABS (Anti-lock Braking System) 54
 - ADAPTIVE BRAKE 57
 - BAS (Brake Assist System) 55
 - Electronic brake force distribution ... 57
 - ESP® (Electronic Stability Program) . 56
 - ETS (Electronic Traction System) 55
 - Important safety information 54
 - Overview 54
 - Driving systems**
 - AMG adaptive sport suspension system 133
 - Blind Spot Assist 134
 - Cruise control 131
 - Display message 168
 - Driving tips**
 - AMG ceramic high-performance compound brake system 129
 - Brakes 128
 - Break-in period 110
 - Drinking and driving 128
 - Driving abroad 90
 - Driving in winter 130
 - Driving on wet roads 130
 - Exhaust check 128
 - Fuel 127
 - General 127
 - Hydroplaning 130
 - Icy road surfaces 130
 - Limited braking efficiency on salted roads 129
 - Snow chains 235
 - Symmetrical low beam 90
 - Wet road surface 128
 - DVD audio (on-board computer)** 143
 - DVD video (on-board computer)** 143
- ## E
- EASY-ENTRY feature**
 - Activating/deactivating 147
 - Function/notes 83
 - EASY-EXIT feature**
 - Crash-responsive 84
 - Function/notes 83
 - Switching on/off 147
 - EBD (electronic brake force distribution)**
 - Display message 154
 - Function/notes 57
 - Electronic Stability Program**
 - see ESP® (Electronic Stability Program)
 - Electronic traction control system**
 - see ETS 55
 - Emergency release**
 - Driver's door 69
 - Trunk 72
 - Vehicle 69
 - Emergency Tensioning Devices**
 - Function 50
 - Safety guidelines 37
 - Emissions control**
 - Service and warranty information 18
 - Engine**
 - Display message 165
 - Engine number 263
 - Starting 112
 - Starting the engine with the SmartKey 112
 - Starting with the KEYLESS-GO start function 112
 - Switching off 125
 - Engine diagnostics warning lamp** 181
 - Engine oil**
 - Adding 204
 - Additives 266
 - Checking the oil level 203

- Checking the oil level using the dipstick 203
 - Display message 166, 167
 - Filling capacity 266
 - Notes about oil grades 265
 - Notes on oil level/consumption 203
 - Temperature (on-board computer) . 148
 - Temperature gauge 138
 - Viscosity 266
 - E-SELECT lever** 113
 - ESP® (Electronic Stability Program)**
 - Deactivating/activating 56
 - Display message 158
 - Function/notes 56
 - Important safety information 55
 - Warning lamp 179
 - Exhaust check** 128
 - Exhaust pipe (cleaning instructions)** 211
 - Exterior lighting**
 - Setting options 90
 - see Lights
 - Exterior mirrors**
 - Adjusting 84
 - Dipping (automatic) 85
 - Folding in/out (automatically) 85
 - Folding in/out (electrically) 85
 - Folding in when locking (on-board computer) 148
 - Out of position (troubleshooting) 85
 - Setting 85
 - Storing settings (memory function) .. 86
 - Storing the parking position 86
- F**
- Filler cap**
 - see Fuel filler flap
 - First-aid kit** 216
 - Flat tire**
 - Preparing the vehicle 217
 - Raising the vehicle 254
 - TIREFIT kit 217
 - Floormats** 199
 - Fuel**
 - Additives 265
 - Consumption statistics 141
 - Displaying the range 141
 - Driving tips 127
 - E10 264
 - Fuel gauge 27
 - Grade (gasoline) 264
 - Important safety notes 264
 - Problem (malfunction) 124
 - Refueling 121
 - Tank content/reserve fuel 264
 - Fuel filler flap, opening/closing** 122
 - Fuel level**
 - Calling up the range (on-board computer) 141
 - Fuel tank**
 - Capacity 264
 - Problem (malfunction) 124
 - Fuse box**
 - Front-passenger footwell 229
 - Rear compartment 229
 - Fuses**
 - Allocation chart 229
 - Before changing 229
 - Important safety notes 228
- G**
- Garage door opener**
 - Clearing the memory 199
 - Important safety notes 196
 - Opening/closing the garage door .. 198
 - Programming (button in the rear-view mirror) 197
 - Gasoline** 264
 - Gear indicator** 114
 - Gear or selector lever (cleaning guidelines)** 212
 - Genuine parts** 17
 - Glove box** 186
- H**
- Hazard warning lamps** 92
 - Head bags** 42
 - Headlamp cleaning system**
 - Notes 268
 - Headlamps**
 - Adding fluid to cleaning system 205
 - Cleaning system (capacity) 268
 - Cleaning system (function) 93

Cleaning system (notes)	268
Fogging up	93
see Automatic headlamp mode	
Heating	
see Climate control	
High-beam headlamps	
Switching on/off	92
High-beam headlamps (display message)	163
Hill start assist	113
Hood	
Closing	203
Display message	172
Important safety notes	202
Opening	202
Hydroplaning	130
I	
Ignition lock	111
see Key positions	
Immobilizer	58
Indicator lamps	
see Warning and indicator lamps	
Instrument cluster	
Overview	27
Settings	145
Warning and indicator lamps	28
Instrument cluster lighting	146
Interior lighting	
Automatic control	93
Delayed switch-off (on-board computer)	147
Emergency lighting	94
Manual control	94
Overview	93
Reading lamp	93
J	
Jack	
Storage location	216
Using	254
Jump starting (engine)	224

K**KEYLESS-GO start function**

Display message	172
Start/Stop button	111
Starting the engine	112

Key positions

SmartKey	111
----------------	-----

Kickdown

Driving tips	116
--------------------	-----

Knee bag

.....	41
-------	----

L**Lamps**

 see Warning and indicator lamps

Lap time (RACETIMER)

.....	149
-------	-----

License plate lamp

Changing bulbs	95
----------------------	----

License plate lamp (display message)

.....	163
-------	-----

Lighting

Light switch	90
--------------------	----

Lights

Activating/deactivating the interior lighting delayed switch-off .	147
Automatic headlamp mode	90
Display message	161
Driving abroad	90
Hazard warning lamps	92
High beam flasher	92
High-beam headlamps	92
Low-beam headlamps	91
Parking lamps	91
Standing lamps	91
Switching the daytime running lamps on/off (on-board computer)	146
Switching the daytime running lamps on/off (switch)	90
Switching the exterior lighting delayed switch-off on/off (on-board computer)	147
Switching the surround lighting on/off (on-board computer)	147
Turn signals	92
see Replacing bulbs	

LIM indicator lamp

Cruise control	131
----------------------	-----

- Locking**
see Central locking
- Locking (doors)**
Automatic 69
Emergency locking 70
From inside (central locking button) 69
- Locking centrally**
see Central locking
- Low-beam headlamps**
Display message 162
Setting for driving abroad (symmetrical) 90
Switching on/off 91
- M**
- M+S tires** 234
- Malfunction message**
see Display messages
- Manual drive program** 120
- Matte finish (cleaning instructions)** 210
- mbrace**
Call priority 194
Display message 161
Downloading destinations (COMAND) 194
Emergency call 191
General notes 190
Locating a stolen vehicle 195
MB info call button 193
Remote vehicle locking 195
Roadside Assistance button 193
Search & Send 195
Self-test 191
System 190
- Mechanical key**
Function/notes 64
Locking vehicle 70
Unlocking the driver's door 69
- Memory card (audio)** 143
- Memory function** 86
- Message memory (on-board computer)** 152
- Messages**
see Display messages
- Mirrors**
see Exterior mirrors
see Rear-view mirror
see Vanity mirror
- Mobile phone**
Menu (on-board computer) 143
- Modifying the programming (SmartKey)** 63
- MP3**
Operation 143
see separate operating instructions
- Multifunction display**
Function/notes 140
Permanent display 146
- Multifunction steering wheel**
Operating the on-board computer . 139
Overview 29
- N**
- Navigation**
Menu (on-board computer) 141
On-board computer 141
see separate operating instructions
- Notes on breaking-in a new vehicle** 110
- O**
- Occupant Classification System (OCS)**
Faults 46
Operation 42
System self-test 45
- Occupant safety**
Children in the vehicle 51
Important safety notes 36
- OCS**
Faults 46
Operation 42
System self-test 45
- Odometer** 140
- On-board computer**
AMG menu 148
Audio menu 142
Convenience submenu 147
Displaying a service message 206
Display messages 151
Factory settings 148

- Important safety notes 138
 - Instrument cluster submenu 145
 - Lighting submenu 146
 - Menu overview 140
 - Message memory 152
 - Navigation menu 141
 - Operation 139
 - RACETIMER 149
 - Service menu 145
 - Settings menu 145
 - Standard display 140
 - Telephone menu 143
 - Trip menu 140
 - Vehicle submenu 147
 - Video DVD operation 143
 - Opening and closing** 68
 - Operating safety**
 - Declaration of conformity 21
 - Important safety notes 20
 - Operating system**
 - see On-board computer
 - Operator's Manual**
 - Vehicle equipment 18
 - Outside temperature display** 138
 - Overhead control panel** 32
- P**
- Paint code number** 262
 - Paintwork (cleaning instructions)** ... 209
 - Panic alarm** 36
 - Parcel net** 187
 - Parking** 124
 - Important safety notes 124
 - Position of exterior mirror, front-passenger side 86
 - Parking aid**
 - see Exterior mirrors
 - Parking brake**
 - Display message 154
 - Electric parking brake 126
 - Parking lamps**
 - Switching on/off 91
 - PASSENGER AIR BAG OFF indicator lamp** 42
 - Plastic trim (cleaning instructions)** . 212
 - Power washers** 209
 - Power windows**
 - see Side windows
 - Program selector** 116
 - Protection of the environment**
 - General notes 17
 - Pulling away** 112
- Q**
- Qualified specialist workshop** 21
- R**
- RACE START** 117
 - RACETIMER (on-board computer)** 149
 - Radio**
 - Selecting a station 142
 - see separate operating instructions
 - Radio-wave reception/transmission in the vehicle**
 - Declaration of conformity 21
 - Reading lamp** 93
 - Rear spoiler**
 - Permanently mounted 196
 - Rear-view mirror**
 - Anti-glare (manual) 84
 - Dipping (automatic) 85
 - Rear window defroster**
 - Problem (malfunction) 107
 - Switching on/off 106
 - Refrigerant (air-conditioning system)**
 - Important safety notes 266
 - Refueling**
 - Fuel gauge 27
 - Important safety notes 121
 - Refueling process 122
 - see Fuel
 - Remote control**
 - Garage door opener 196
 - Programming (garage door opener) 197
 - Replacing bulbs**
 - Important safety notes 94
 - Reporting safety defects** 22
 - Reserve (fuel tank)**
 - see Fuel

- Reserve fuel**
 - Display message 167
 - Warning lamp 182
 - see Fuel
 - Restraint system**
 - see SRS (Supplemental Restraint System)
 - Reversing lamps (display message)** 163
 - Roadside Assistance (breakdown)** 19
 - Route**
 - see Route guidance (navigation)
 - Route guidance (navigation)** 141
- S**
- Safety**
 - Children in the vehicle 51
 - Child restraint systems 51
 - Occupant Classification System (OCS) 42
 - Safety system**
 - see Driving safety systems
 - Seat belts**
 - Belt force limiters 50
 - Cleaning 213
 - Correct usage 48
 - Emergency Tensioning Devices 50
 - Fastening 49
 - Important safety guidelines 47
 - Releasing 49
 - Safety guidelines 37
 - Special seat belt retractor 53
 - Warning lamp 177
 - Warning lamp (function) 49
 - Seats**
 - Adjusting (electrically) 80
 - Adjusting (manually) 80
 - Adjusting lumbar support 80
 - Cleaning the cover 213
 - Correct driver's seat position 78
 - Important safety notes 79
 - Seat heating problem 81
 - Storing settings (memory function) .. 86
 - Switching seat heating on/off 81
 - Selector lever**
 - Positions 113
 - Service interval display**
 - Displaying service messages 206
 - Hiding service messages 206
 - Notes 206
 - Service messages 206
 - Service menu (on-board computer)** . 145
 - Service products**
 - Brake fluid 267
 - Coolant (engine) 267
 - Engine oil 265
 - Fuel 264
 - Important safety notes 263
 - Notes 263
 - Refrigerant (air-conditioning system) 266
 - Washer fluid 268
 - Settings**
 - Factory (on-board computer) 148
 - On-board computer 145
 - Setting the air distribution** 104
 - Setting the airflow** 105
 - SETUP (on-board computer)** 148
 - Side impact air bag** 41
 - Side marker lamp (display message)** 164
 - Side windows**
 - Cleaning 210
 - Convenience closing feature 74
 - Convenience opening feature 74
 - Important safety information 73
 - Opening/closing 74
 - Problem (malfunction) 76
 - SmartKey** 68
 - Changing the battery 65
 - Changing the programming 63
 - Checking the battery 65
 - Convenience closing feature 74
 - Convenience opening feature 74
 - Display message 172
 - Door central locking/unlocking 62
 - Loss 66
 - Mechanical key 64
 - Positions (ignition lock) 111
 - Problem (malfunction) 66
 - Starting the engine 112
 - Unlocking/locking vehicle 68
 - SmartKey positions**
 - KEYLESS-GO start function 111

- Snow chains** 235
 - Socket**
 - Glove box 190
 - Sockets**
 - Center console 190
 - Points to observe before use 189
 - Specialist workshop** 21
 - Speed, controlling**
 - see Cruise control
 - Speedometer**
 - Activating/deactivating the additional speedometer 146
 - Digital 140
 - In the Instrument cluster 27
 - Selecting the unit of measurement see Instrument cluster
 - SPORT handling mode**
 - Warning lamp 179
 - SRS**
 - see SRS (Supplemental Restraint System)
 - SRS (Supplemental Restraint System)**
 - Display message 161
 - Introduction 37
 - Warning lamp 180
 - Warning lamp (function) 37
 - Standing lamps**
 - Display message 164
 - Switching on/off 91
 - Starting (engine)** 112
 - Steering wheel**
 - Adjusting (electrically) 82, 83
 - Adjusting (manually) 82
 - Button overview 29
 - Buttons (on-board computer) 139
 - Cleaning 212
 - Important safety notes 82
 - Paddle shifters 117
 - Storing settings (memory function) .. 86
 - Stopwatch (RACETIMER)** 149
 - Stowage areas** 186
 - Stowage compartments**
 - Armrest (under) 187
 - Center console 187
 - Cup holders 188
 - Glove box 186
 - Important safety information 186
 - Parcel net 187
 - Rear wall 187
 - Stowage space**
 - Center console (rear) 187
 - Summer opening**
 - see Convenience opening feature
 - Summer tires** 234
 - Sun visor** 188
 - Surround lighting (on-board computer)** 147
 - Suspension tuning**
 - AMG adaptive sport suspension system 133
 - Switching air-recirculation mode on/off** 107
 - Switching off the alarm (ATA)** 58
- ## T
- Tachometer** 138
 - Tail lamps**
 - Display message 163
 - Tail lamps (Display message)** 163
 - Tank content**
 - Fuel gauge 27
 - Technical data**
 - Notes 262
 - Tires/wheels 257
 - TELEAID**
 - Call priority 194
 - Display message 161
 - Downloading destinations (COMAND) 194
 - Emergency call 191
 - Locating a stolen vehicle 195
 - MB info call button 193
 - Remote vehicle locking 195
 - Roadside Assistance button 193
 - Search & Send 195
 - Self-test 191
 - System 190
 - Tele Aid**
 - General notes 190
 - Telephone**
 - Accepting a call 144
 - Menu (on-board computer) 143
 - Number from the phone book 144

- Redialing 145
- Rejecting/ending a call 144
- Temperature**
- Coolant (on-board computer) 148
- Engine oil 138
- Engine oil (on-board computer) 148
- Outside temperature 138
- Theft deterrent systems**
- ATA (Anti-Theft Alarm system) 58
- Immobilizer 58
- Tow-away alarm 59
- Time**
- see separate operating instructions
- Timing (RACETIMER)** 149
- TIREFIT kit** 217
- Tire pressure**
- Calling up (on-board computer) 238
- Checking manually 238
- Display message 170
- Maximum 238
- Notes 237
- Not reached (TIREFIT) 219
- Reached (TIREFIT) 219
- Recommended 235
- Tire pressure monitoring system**
- Checking the tire pressure
- electronically 240
- Function/notes 238
- Restarting 241
- Warning lamp 183
- Warning message 241
- Tires**
- Aspect ratio (definition) 251
- Average weight of the vehicle occupants (definition) 250
- Bar (definition) 250
- Characteristics 250
- Checking 233
- Definition of terms 250
- Direction of rotation 253
- Display message 170
- Distribution of the vehicle occupants (definition) 252
- DOT, Tire Identification Number (TIN) 249
- DOT (Department of Transportation) (definition) 250
- GAWR (Gross Axle Weight Rating) (definition) 250
- GVW (Gross Vehicle Weight) (definition) 251
- GVWR (Gross Vehicle Weight Rating) (definition) 251
- Important safety notes 232
- Increased vehicle weight due to optional equipment (definition) 250
- Kilopascal (kPa) (definition) 251
- Labeling (overview) 246
- Load bearing index (definition) 252
- Load index 249
- Load index (definition) 251
- Maximum loaded vehicle weight (definition) 251
- Maximum load on a tire (definition) 251
- Maximum permissible tire pressure (definition) 251
- Maximum tire load 249
- Maximum tire load (definition) 251
- Optional equipment weight (definition) 252
- PSI (pounds per square inch) (definition) 251
- Replacing 252
- Service life 234
- Sidewall (definition) 252
- Speed rating (definition) 251
- Storing 253
- Structure and characteristics (definition) 250
- Technical data 259
- Temperature 246
- TIN (Tire Identification Number) (definition) 252
- Tire bead (definition) 252
- Tire pressure (definition) 251
- Tire pressures (recommended) 250
- Tire size (data) 257
- Tire size designation, load-bearing capacity, speed rating 246
- Tire tread 233
- Tire tread (definition) 252
- Total load limit (definition) 252
- Traction 245
- Traction (definition) 252
- Tread wear 245

- Uniform Tire Quality Grading Standards 245
 - Uniform Tire Quality Grading Standards (definition) 250
 - Unladen weight (definition) 251
 - Wear indicator (definition) 252
 - Wheel rim (definition) 250
 - see Flat tire
 - Top Tether** 53
 - Tow-away alarm** 59
 - Towing**
 - Important safety guidelines 226
 - Installing the towing eye 227
 - Removing the towing eye 227
 - With the rear axle raised 227
 - Towing away**
 - With both axles on the ground 228
 - Transmission**
 - Driving tips 116
 - Selector lever 113
 - Transmission position display** 114
 - Transmission positions** 115
 - Transporting the vehicle** 228
 - Trim pieces (cleaning instructions)** 212
 - Trip computer (on-board computer)** 141
 - Trip odometer**
 - Calling up 140
 - Trunk**
 - Emergency release 72
 - Important safety guidelines 70
 - Locking separately 72
 - Opening (automatically from inside) 72
 - Trunk lid**
 - Display message 172
 - Opening/closing 70, 71
 - Opening dimensions 268
 - Trunk load (maximum)** 268
 - see Technical data
 - Turn signal (display message)** 162
 - Turn signals**
 - Switching on/off 92
 - Type identification plate**
 - see Vehicle identification plate
- U**
- Unlocking**
 - Emergency unlocking 69
 - From inside the vehicle (central unlocking button) 69
 - Upshift indicator** 120
- V**
- Vanity mirror (in the sun visor)** 188
 - Vehicle**
 - Correct use 22
 - Data acquisition 23
 - Display message 172
 - Equipment 18
 - Individual settings 145
 - Limited Warranty 22
 - Loading 242
 - Locking (in an emergency) 70
 - Locking (SmartKey) 62
 - Lowering 257
 - Maintenance 19
 - Parking for a long period 127
 - Pulling away 112
 - Raising 254
 - Reporting problems 22
 - Towing away 226
 - Transporting 228
 - Unlocking (in an emergency) 69
 - Unlocking (SmartKey) 62, 68
 - Vehicle data 268
 - Vehicle data** 268
 - see Technical data
 - Vehicle dimensions** 268
 - see Technical data
 - Vehicle emergency locking** 70
 - Vehicle identification number**
 - see VIN
 - Vehicle identification plate** 262
 - Vehicle tool kit** 216
 - Vehicle weights**
 - see Technical data
 - Video (DVD)** 143
 - VIN** 262

W**Warning and indicator lamps**

ABS	178
Brakes	176, 178
Check Engine	181
Cruise control	131
ESP®	179
Fuel tank	182
Overview	28
PASSENGER AIR BAG OFF indicator lamp	42
Reserve fuel	182
Seat belt	177
SPORT handling mode	179
SRS	180
Tire pressure monitor	183

Warranty	262
-----------------------	-----

Washer fluid

see Windshield washer system

Washer fluid (display message)	172
---	-----

Weight

see Technical data

Wheel bolt tightening torque	257
---	-----

Wheel chock	253
--------------------------	-----

Wheels

Checking	233
Cleaning	209
Important safety notes	232
Interchanging/changing	252
Mounting a new wheel	256
Mounting a wheel	253
Removing a wheel	255
Storing	253
Tightening torque	257
Wheel size/tire size	257

Windows

see Side windows

Windshield washer system	205
---------------------------------------	-----

Filling capacity	268
------------------------	-----

Notes	268
-------------	-----

Windshield wipers

Problem (malfunction)	97
Replacing the wiper blades	96
Switching on/off	95

Winter driving

Important safety notes	234
Slippery road surfaces	130
Snow chains	235

Winter tires

M+S tires	234
-----------------	-----

Wiper blades

Cleaning	211
Important safety notes	96
Replacing	96

Wooden trim (cleaning instructions)	212
--	-----

Workshops

see Qualified specialist workshop

Protection of the environment

General notes

Environmental note

Daimler's declared policy is one of comprehensive environmental protection.

The objectives are for the natural resources that form the basis of our existence on this planet to be used sparingly and in a manner that takes the requirements of both nature and humanity into account.

You too can help to protect the environment by operating your vehicle in an environmentally responsible manner.

Fuel consumption and the rate of engine, transmission, brake and tire wear are affected by these factors:

- operating conditions of your vehicle
- your personal driving style

You can influence both factors. You should bear the following in mind:

Operating conditions:

- avoid short trips as these increase fuel consumption.
- always make sure that the tire pressures are correct.
- do not carry any unnecessary weight.
- remove roof racks once you no longer need them.
- a regularly serviced vehicle will contribute to environmental protection. You should therefore adhere to the service intervals.
- always have service work carried out at a qualified specialist workshop.

Personal driving style:

- do not depress the accelerator pedal when starting the engine.
- do not warm up the engine when the vehicle is stationary.
- drive carefully and maintain a safe distance from the vehicle in front.
- avoid frequent, sudden acceleration and braking.

- change gear in good time and use each gear only up to $\frac{2}{3}$ of its maximum engine speed.
- switch off the engine in stationary traffic.
- keep an eye on the vehicle's fuel consumption.

Environmental concerns and recommendations

Wherever the operating instructions require you to dispose of materials, first try to regenerate or re-use them. Observe the relevant environmental rules and regulations when disposing of materials. In this way you will help to protect the environment.

Genuine Mercedes-Benz parts

Environmental note

Daimler AG also supplies reconditioned major assemblies and parts which are of the same quality as new parts. They are covered by the same Limited Warranty entitlements as new parts.

! Air bags and Emergency Tensioning Devices, as well as control units and sensors for these restraint systems, may be installed in the following areas of your vehicle:

- doors
- door pillars
- door sills
- seats
- cockpit
- instrument cluster
- center console

Do not install accessories such as audio systems in these areas. Do not carry out repairs or welding. You could impair the operating efficiency of the restraint systems.

Have aftermarket accessories installed at a qualified specialist workshop.

You could jeopardize the operating safety of your vehicle if you use parts, tires and wheels as well as accessories relevant to safety which have not been approved by Mercedes. This could lead to malfunctions in safety-relevant systems, e.g. the brake system. Use only genuine Mercedes-Benz parts or parts of equal quality. Only use tires, wheels and accessories that have been specifically approved for your vehicle.

Genuine Mercedes-Benz parts are subject to strict quality control. Every part has been specifically developed, manufactured or selected for and adapted to Mercedes-Benz vehicles. Only genuine Mercedes-Benz parts should therefore be used.

More than 300,000 different genuine Mercedes-Benz parts are available for Mercedes-Benz models.

All authorized Mercedes-Benz Centers maintain a supply of genuine Mercedes-Benz parts for necessary service and repair work. In addition, strategically located parts delivery centers provide quick and reliable parts service.

Always specify the vehicle identification number (VIN) (▷ page 262) when ordering genuine Mercedes-Benz parts.

Operator's Manual

Vehicle equipment

This Operator's Manual describes all models and all standard and optional equipment of your vehicle available at the time of going to print. Country-specific differences are possible. Bear in mind that your vehicle may not feature all functions described here. This also applies to safety-relevant systems and functions. The equipment in your vehicle may therefore differ from that shown in the descriptions and illustrations.

The original purchase agreement lists all systems installed in your vehicle.

Should you have any questions concerning equipment and operation, please consult an authorized Mercedes-Benz Center.

The Operator's Manual and Maintenance Booklet are important documents and should be kept in the vehicle.

Service and vehicle operation

Service and literature

Your vehicle is covered under the terms of the warranties printed in the Service and Warranty Information booklet. Your authorized Mercedes-Benz Center will exchange or repair any defective parts originally installed in the vehicle in accordance with the terms of the following warranties:

- New Vehicle Limited Warranty
- Emission Systems Warranty
- Emission Performance Warranty
- California, Connecticut, Maine, Massachusetts, New York, Pennsylvania, Rhode Island and Vermont Emission Control Systems Warranty
- State warranty enforcement laws (lemon laws)

Information for customers in California

Under California law you may be entitled to a replacement of your vehicle or a refund of the purchase price or lease price, if after a reasonable number of repair attempts Mercedes-Benz USA, LLC and/or its authorized repair or service facilities fail to fix one or more substantial defects or malfunctions in the vehicle that are covered by its express warranty. During the period of 18 months from original delivery of the vehicle or the accumulation of 18,000 miles (approximately 29,000 km) on the odometer of the vehicle, whichever occurs first, a reasonable number of repair attempts is presumed for a retail buyer or lessee if one or more of the following occurs:

- (1) the same substantial defect or malfunction results in a condition that is likely to cause death or serious bodily injury if the vehicle is driven, that defect or malfunction has been subject to repair two or more times, and you have directly notified Mercedes-Benz USA, LLC in writing of the need for its repair,
- (2) the same substantial defect or malfunction of a less serious nature than category (1) has been subject to repair four or more times and you have directly notified us in writing of the need for its repair, or
- (3) the vehicle is out of service by reason of repair of the same or different substantial defects or malfunctions for a cumulative total of more than 30 calendar days.

Please send your written notice to:
Mercedes-Benz USA, LLC
Customer Assistance Center
One Mercedes Drive
Montvale, NJ 07645-0350

Maintenance

The Service and Warranty Booklet describes all the necessary maintenance work which should be done at regular intervals.

Always have the Service and Warranty Booklet with you when you bring the vehicle to an authorized Mercedes-Benz Center. The service advisor will record every service for you in the Service and Warranty Booklet.

Roadside Assistance

The Mercedes-Benz Roadside Assistance Program offers technical help in the event of a breakdown. Calls to the toll-free Roadside Assistance Hotline are answered by our agents 24 hours a day, 365 days a year.

1-800-FOR-MERCEdes(1-800-367-6372) (USA)

1-800-387-0100 (Canada)

For additional information, refer to the Mercedes-Benz Roadside Assistance Program brochure (USA) or the "Roadside Assistance" section in the Service and Warranty booklet (Canada). You will find both in your vehicle literature portfolio.

Change of address or change of ownership

In the event of a change of address, please send us the "Notification of Address Change" in the Service and Guarantee booklet or simply call the Mercedes-Benz Customer Assistance Center (USA) at the hotline number

1-800-FOR-MERCEdes(1-800-367-6372) or Customer Service Center (Canada) at 1-800-387-0100. This will assist us in contacting you in a timely manner should the need arise.

If you sell your Mercedes, please leave the entire literature in the vehicle so that it is available to the next owner.

If you have purchased a used car, please send us the "Notification of Used Car Purchase" in the Service and Guarantee booklet or simply call the Mercedes-Benz Customer Assistance Center (USA) at the hotline number 1-800-FOR-MERCEdes(1-800-367-6372) or Customer Service (Canada) at 1-800-387-0100.

Vehicle operation outside the USA and Canada

If you plan to operate your vehicle in foreign countries, please be aware that:

- service facilities or replacement parts may not be readily available.
- unleaded fuel for vehicles with a catalytic converter may not be available. Leaded fuel may cause damage to the catalytic converter.
- the fuel may have a considerably lower octane rating. Unsuitable fuel can cause engine damage.

Some Mercedes-Benz models are available for delivery in Europe through our European Delivery Program. For details, consult an authorized Mercedes-Benz Center or write to one of the following addresses.

In the USA

Mercedes-Benz USA, LLC
European Delivery Department
One Mercedes Drive
Montvale, NJ 07645-0350

In Canada

Mercedes-Benz Canada, Inc.
European Delivery Department
98 Vanderhoof Avenue
Toronto, Ontario M4G 4C9

Operating safety

Important safety notes

WARNING

If you do not have the prescribed service/ maintenance work or any required repairs carried out, this can result in malfunctions or system failures. There is a risk of an accident.

Always have the prescribed service/ maintenance work as well as any required repairs carried out at a qualified specialist workshop.

WARNING

If you switch off the ignition while driving, safety-relevant functions are only available with limitations, or not at all. This could affect, for example, the power steering and the brake boosting effect. You will require considerably more effort to steer and brake. There is a risk of an accident.

Do not switch off the ignition while driving.

WARNING

Modifications to electronic components, their software as well as wiring can impair their function and/or the function of other networked components. In particular, systems relevant to safety could also be affected. As a result, these may no longer function as intended and/or jeopardize the operating safety of the vehicle. There is an increased risk of an accident and injury.

Never tamper with the wiring as well as electronic components or their software. You should have all work to electrical and electronic equipment carried out at a qualified specialist workshop.

 There is a risk of damage to the vehicle if:

- the vehicle becomes stuck, e.g. on a high curb or an unpaved road
- you drive too fast over an obstacle, e.g. a curb or a hole in the road
- a heavy object strikes the undercarriage or parts of the chassis

In situations like this, the body, the undercarriage, chassis parts, wheels or tires could be damaged without the damage being visible. Components damaged in this way can unexpectedly fail or, in the case of an accident, no longer withstand the strain they are designed to. If the underbody paneling is damaged, combustible materials such as leaves, grass or twigs can gather between the underbody and the underbody paneling. If these materials come in contact with hot parts of the exhaust system for an extended period, they can catch fire.

In such cases, have the vehicle checked and repaired immediately at a qualified specialist workshop. If on continuing your journey you notice that driving safety is impaired, pull over and stop the vehicle immediately, paying attention to road and traffic conditions. In such cases, visit a qualified specialist workshop.

Declarations of conformity

Vehicle components which receive and/or transmit radio waves

USA: "The wireless devices of this vehicle comply with Part 15 of the FCC Rules. Operation is subject to the following two conditions: 1) These devices may not cause harmful interference, and 2) These devices must accept any interference received, including interference that may cause undesired operation. Changes or modifications not expressly approved by the party responsible for compliance could void the user's authority to operate the equipment."

Canada: "The wireless devices of this vehicle comply with Industry Canada license-exempt RSS standard(s). Operation is subject to the following two conditions: (1) These devices may not cause interference, and (2) These devices must accept any interference,

including interference that may cause undesired operation of the device."

Diagnostics connection

The diagnostics connection is only intended for the connection of diagnostic equipment at a qualified specialist workshop.

WARNING

If you connect equipment to the diagnostics connection in the vehicle, it may affect the operation of the vehicle systems. As a result, the operating safety of the vehicle could be affected. There is a risk of an accident.

Do not connect any equipment to a diagnostics connection in the vehicle.

WARNING

Objects in the driver's footwell can restrict the pedal travel or obstruct a depressed pedal. The operating and road safety of the vehicle is jeopardized. There is a risk of an accident. Make sure that all objects in the vehicle are stowed correctly, and that they cannot enter the driver's footwell. Install the floormats securely and as specified in order to ensure sufficient clearance for the pedals. Do not use loose floormats and do not place floormats on top of one another.

 If the engine is switched off and equipment on the diagnostics connection is used, the starter battery may discharge.

Connecting equipment to the diagnostics connection can lead to emissions monitoring information being reset, for example. This may lead to the vehicle failing to meet the requirements of the next emissions test during the main inspection.

Qualified specialist workshop

An authorized Mercedes-Benz Center is a qualified specialist workshop. It has the necessary specialist knowledge, tools and

qualifications to correctly carry out the work required on your vehicle. This is especially the case for work relevant to safety.

Observe the notes in the Maintenance Booklet.

Always have the following work carried out at an authorized Mercedes-Benz Center:

- work relevant to safety
- service and maintenance work
- repair work
- alterations, installation work and modifications
- work on electronic components

Correct use

If you remove any warning stickers, you or others could fail to recognize certain dangers. Leave warning stickers in position.

Observe the following information when driving your vehicle:

- the safety notes in this manual
- the Technical Data section in this manual
- traffic rules and regulations
- laws and safety standards pertaining to motor vehicles

Problems with your vehicle

If you should experience a problem with your vehicle, particularly one that you believe may affect its safe operation, we urge you to contact an authorized Mercedes-Benz Center immediately to have the problem diagnosed and rectified. If the problem is not resolved to your satisfaction, please discuss the problem again with a Mercedes-Benz Center or contact us at one of the following addresses.

In the USA

Customer Assistance Center
Mercedes-Benz USA, LLC
One Mercedes Drive
Montvale, NJ 07645-0350

In Canada

Customer Relations Department
Mercedes-Benz Canada, Inc.
98 Vanderhoof Avenue
Toronto, Ontario M4G 4C9

Reporting safety defects

USA only:

The following text is published as required of manufacturers under Title 49, Code of U.S. Federal Regulations, Part 575 pursuant to the "National Traffic and Motor Vehicle Safety Act of 1966".

If you believe that your vehicle has a defect which could cause a crash or could cause injury or death, you should immediately inform the National Highway Traffic Safety Administration (NHTSA) in addition to notifying Mercedes-Benz USA, LLC.

If NHTSA receives similar complaints, it may open an investigation, and if it finds that a safety defect exists in a group of vehicles, it may order a recall and remedy campaign. However, NHTSA cannot become involved in individual problems between you, your dealer, or Mercedes-Benz USA, LLC.

To contact NHTSA, you may call the Vehicle Safety Hotline toll-free at 1-888-327-4236 (TTY: 1-800-424-9153); go to <http://www.safercar.gov>; or write to: Administrator, NHTSA, 400 Seventh Street, SW., Washington, DC 20590.

You can also obtain other information about motor vehicle safety from

<http://www.safercar.gov>

Limited Warranty

I Follow the instructions in this manual about the proper operation of your vehicle as well as about possible vehicle damage. Damage to your vehicle that arises from culpable contraventions against these instructions is not covered either by the

Mercedes-Benz Limited Warranty or by the New or Used-Vehicle Warranty.

Data stored in the vehicle

Information about electronic data acquisition in the vehicle

(Including notice pursuant to California Code § 9951)

Please note that your vehicle is equipped with devices that can record vehicle systems data. If your vehicle is equipped with mbrace (Canada: TELE AID), data is transmitted in the event of an accident.

This information helps, for example, to test vehicle systems after an accident and to continually improve vehicle safety. Daimler AG can access these data and submit them:

- for safety research or vehicle diagnosis purposes
- with the consent of the vehicle owner
- on the instruction of prosecuting authorities
- for use in arbitration of disputes that involve Daimler AG, its subsidiaries or its sales and service organizations
- as otherwise required or permitted by law

This vehicle is equipped with an event data recorder (EDR). The main purpose of an EDR is to record data that will assist in understanding how a vehicle's systems performed in certain crash or near crash-like situations, such as during air bag deployment or when hitting a road obstacle. The EDR is designed to record data related to vehicle dynamics and safety systems for a short period of time, typically 30 seconds or less. The EDR in this vehicle is designed to record such data as:

- how various systems in your vehicle are operating
- whether or not the driver and passenger seat belts are fastened

- how far (if at all) the driver is depressing the accelerator and/or brake pedal and
- how fast the vehicle is traveling

This data can help provide a better understanding of the circumstances in which crashes and injuries occur. NOTE: EDR data is recorded by your vehicle only if a non-trivial crash situation occurs; no data is recorded by the EDR under normal driving conditions and no personal data (e.g., name, gender, age, and crash location) are recorded. However, other parties, such as law enforcement, can combine the EDR data with the type of personal identification data routinely acquired during a crash investigation.

To read data recorded by an EDR, special equipment is required, and access to the vehicle or the EDR is needed. In addition to the vehicle manufacturer, other parties, such as law enforcement, who have the special equipment, can read the information if they have access to the vehicle or the EDR.

Information on copyright

General information

Information on license for free and open-source software used in your vehicle and its electronic components is available on the following website:

<http://www.mercedes-benz.com/opensource>

Dashboard	26
Instrument cluster	27
Multifunction steering wheel	29
Center console	30
Overhead control panel	32
Door control panel	33

Dashboard

At a glance

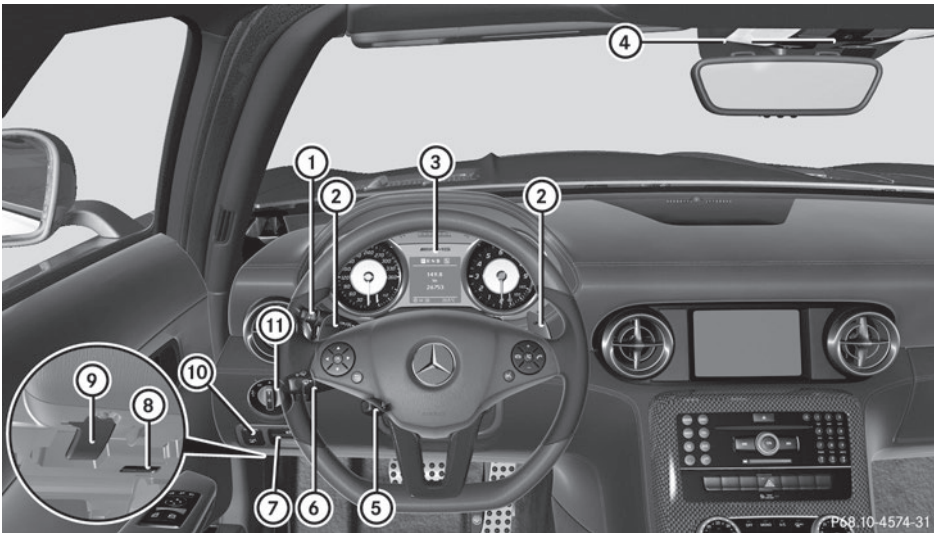

	Function	Page
①	Cruise control lever	131
②	Steering wheel paddle shifters	117
③	Instrument cluster	27
④	Overhead control panel	32
⑤	Adjusts the steering wheel	82
⑥	Combination switch	92

	Function	Page
⑦	Unlocks the trunk	72
⑧	Diagnostics connection	21
⑨	Opens the hood	202
⑩	Electric parking brake	126
⑪	Light switch	90

Instrument cluster

Overview

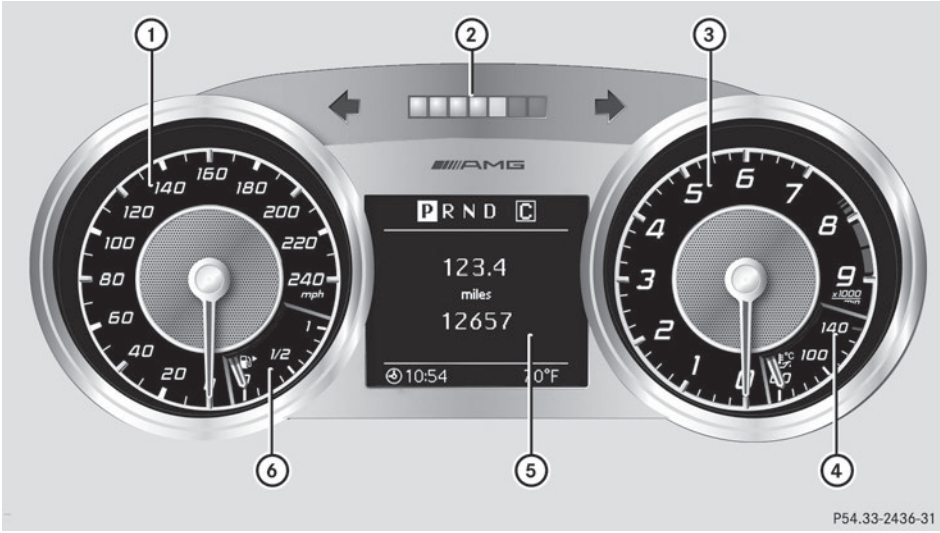

P54.33-2436-31

At a glance

	Function	Page
①	Speedometer	
②	Upshift indicator	120
③	Tachometer	138
④	Engine oil temperature display	138

	Function	Page
⑤	Multifunction display	140
⑥	Fuel gauge	

Warning and indicator lamps

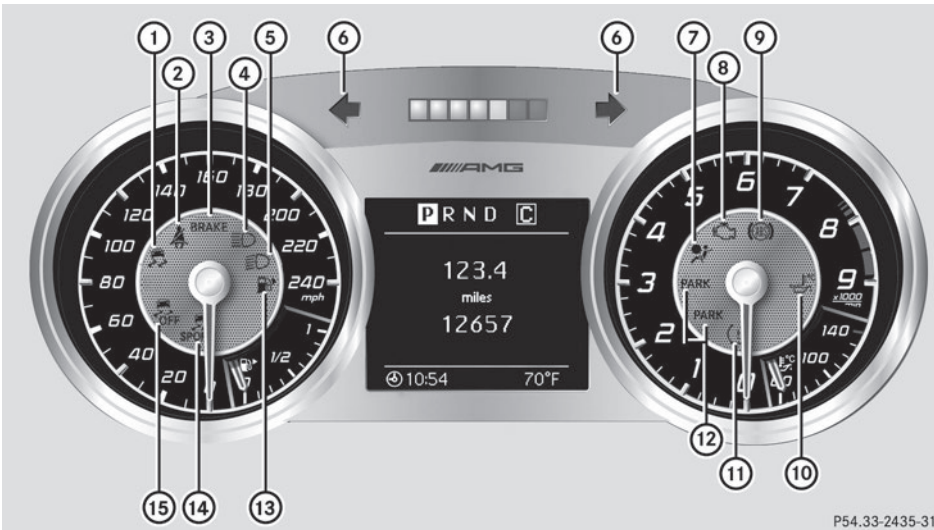

P54.33-2435-31

	Function	Page
①	ESP®	179
②	Seat belts	177
③	Brakes (USA only) ① Brakes (Canada only)	
④	High-beam headlamps	92
⑤	Low-beam headlamps	91
⑥	Turn signal	92
⑦	SRS	180
⑧	Check Engine	
⑨	ABS	178

	Function	Page
⑩	Engine oil temperature	138
⑪	Tire pressure	183
⑫	Electric parking brake (USA only) ⑥ Electric parking brake (Canada only)	
⑬	Reserve fuel	182
⑭	SPORT handling mode	56
⑮	ESP® OFF	55

Multifunction steering wheel

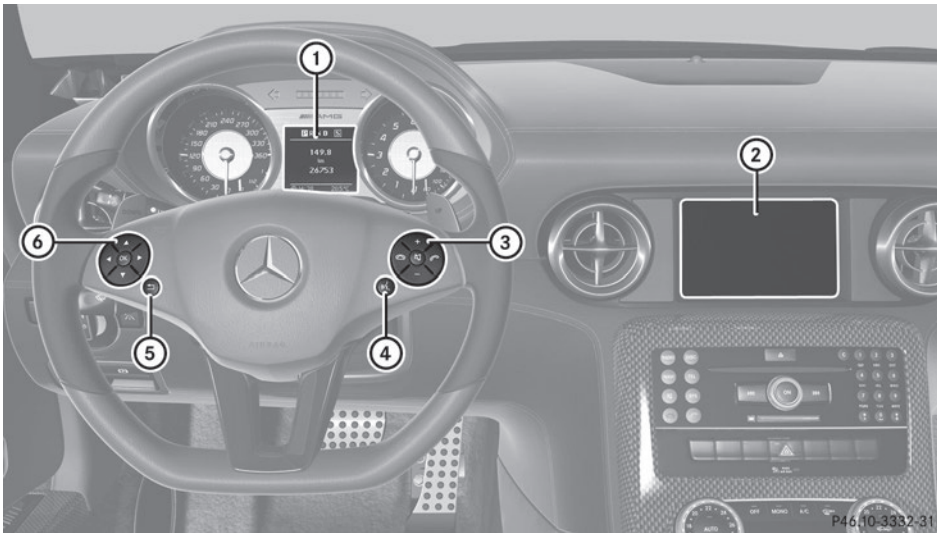

At a glance

	Function	Page
①	Multifunction display	140
②	COMAND with display; see the separate operating instructions	
③	Makes/accepts or rejects/ends a call Increases/reduces the volume Mute	144
④	Switches on the Voice Control System; see the separate operating instructions	

	Function	Page
⑤	Back or deactivates the Voice Control System	
⑥	Selects a menu Selects a submenu or scrolls through lists Confirms selections and hides display messages	139

Center console

Upper section

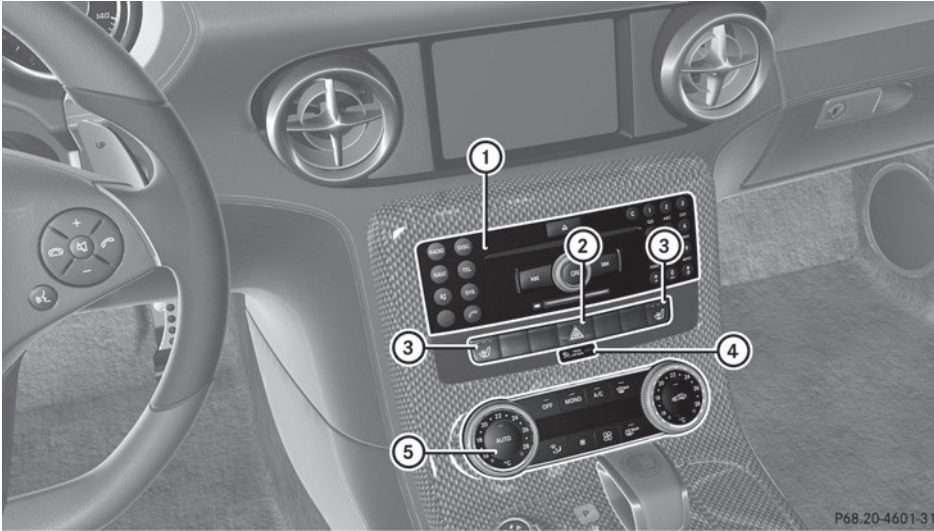

	Function	Page
①	Controls COMAND, see the separate operating instructions	
②	Hazard warning lamps	92
③	Seat heating	81

	Function	Page
④	 PASSENGER AIR BAG OFF indicator lamp	42
⑤	Operates dual-zone automatic climate control	101

Lower section

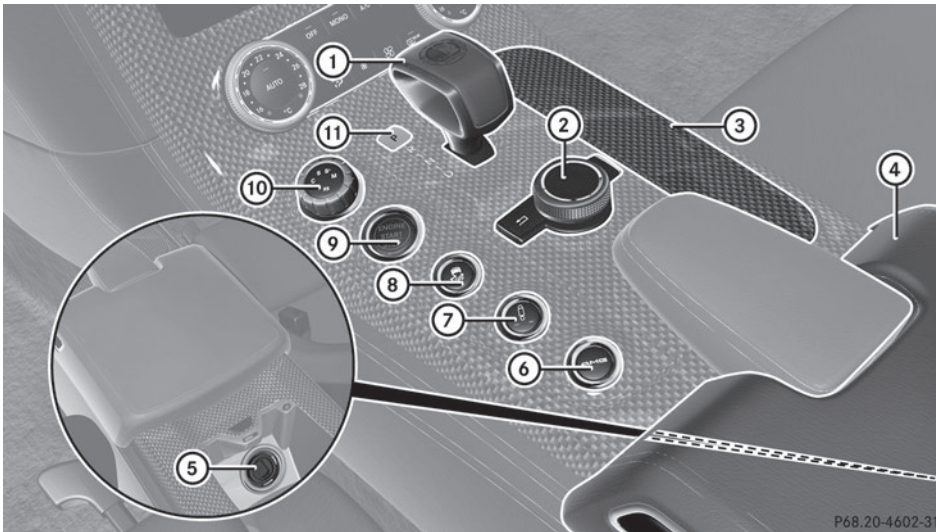

P68.20-4602-31

At a glance





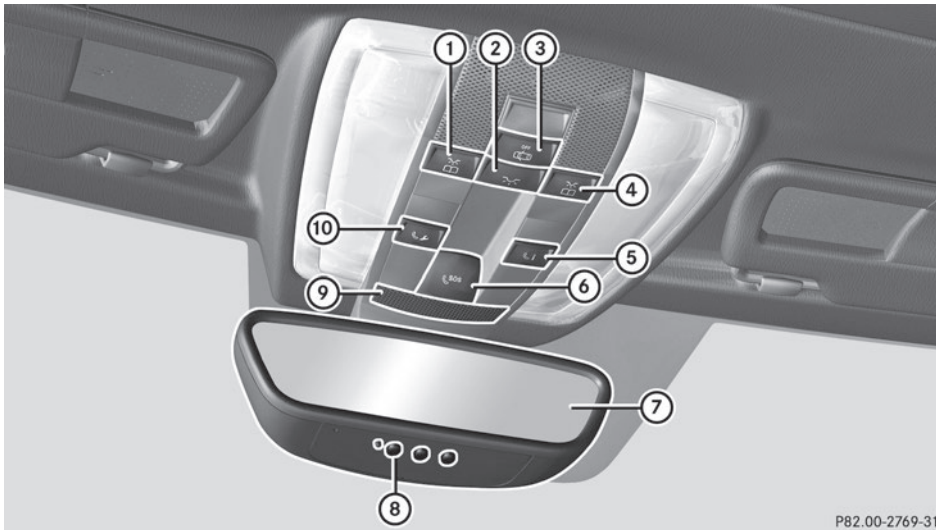

	Function	Page		Function	Page
①	AMG E-SELECT selector lever	113	⑥	Calls up/stores AMG menu (SETUP)	121
②	COMAND controller		⑦	Adjusts AMG adaptive sport suspension system	133
③	Stowage compartment	187	⑧	Activates/deactivates ESP®	56
	12 V socket	189		Activates/deactivates SPORT handling mode	56
	Ashtray	188	⑨	Start/Stop button	111
	Cigarette lighter	189	⑩	Selects the drive program	118
④	Stowage compartment with cup holder	187	⑪	Parking lock button P	113
⑤	Ignition lock (behind the stowage compartment/telephone compartment)	111			

Overhead control panel

At a glance



P82.00-2769-31





	Function	Page
①	 Switches the left-hand reading lamp on/off	93
②	 Switches the interior lighting on/off	94
③	 Switches the automatic interior lighting control on/off	93
④	 Switches the right-hand reading lamp on/off	93
⑤	 MB Info call button (mbrace system)	193
⑥	 SOS button (mbrace system)	191

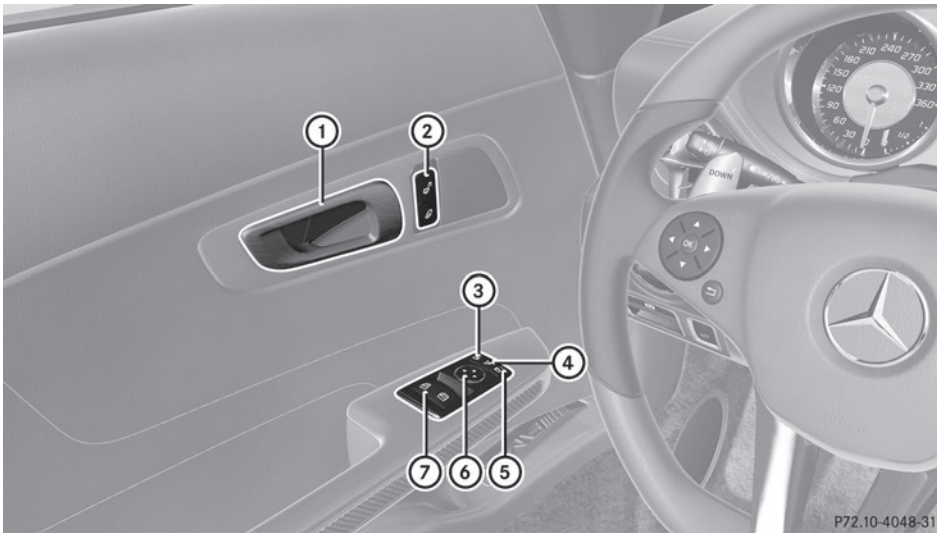

	Function	Page
⑦	Rear-view mirror	84
⑧	Transmitter buttons for the garage door opener	197
⑨	Microphone for mbrace (emergency call system) telephone and the Voice Control System	
⑩	 Roadside Assistance call button (mbrace system)	193

Door control panel



At a glance

	Function	Page
①	Opens the door	69
②	  Locks/unlocks the vehicle	69
③	 Selects the left exterior mirror	84
④	 Folds the exterior mirrors in/out electrically	85

	Function	Page
⑤	 Selects the right exterior mirror	84
⑥	 Adjusts the exterior mirrors	84
⑦	 Opens/closes the side windows	74

P72.10-4048-31

Useful information 36
Panic alarm 36
Occupant safety 36
Child restraint systems 51
Driving safety systems 54
Theft deterrent locking system 58



Useful information

- i** This Operator's Manual describes all models and all standard and optional equipment of your vehicle available at the time of publication of the Operator's Manual. Country-specific differences are possible. Please note that your vehicle may not be equipped with all features described. This also applies to safety-related systems and functions.
- i** Please read the information on qualified specialist workshops (▷ page 21).

Panic alarm



- ▶ **To activate:** press **PANIC** button ① for approximately one second.
An alarm sounds and the exterior lighting flashes.
 - ▶ **To deactivate:** press **PANIC** button ① again.
- or
- ▶ Insert the SmartKey into the ignition lock.
- or
- ▶ Press the Start/Stop button.
The SmartKey must be in the vehicle.

Occupant safety

Important safety notes

⚠ WARNING

Modifications to or work improperly conducted on restraint system components or their wiring, as well as tampering with interconnected electronic systems, can lead to the restraint systems no longer functioning as intended.

Air bags or Emergency Tensioning Devices (ETDs), for example, could deploy inadvertently or fail to deploy in accidents although the deceleration threshold for air bag deployment is exceeded. Therefore, never modify the restraint systems. Do not tamper with electronic components or their software.

In this section, you will learn the most important facts about the restraint system components of the vehicle.

The restraint system consists of:

- Seat belts
- Child restraint systems

Additional protection is provided by:

- SRS (Supplemental Restraint System)
- Air bag system components with:
 - PASSENGER AIR BAG OFF indicator lamp
 - Front-passenger seat with Occupant Classification System (OCS)

Although the systems are independent, their protective functions work in conjunction with each other. Not all air bags are always deployed in an accident.

- i** For information on infants and children traveling with you in the vehicle restraint systems for infants and children, see "Children in the vehicle" (▷ page 51).

SRS (Supplemental Restraint System)

Introduction

SRS reduces the risk of occupants coming into contact with the vehicle's interior in the event of an accident. It can also reduce the effect of the forces to which occupants are subjected during an accident.

SRS consists of:

-  SRS warning lamp
- air bags
- air bag control unit (with crash sensors)
- Emergency Tensioning Devices
- seat belt force limiters

SRS warning lamp

WARNING

If SRS is malfunctioning, child restraint system components may be triggered unintentionally or might not be triggered at all in the event of an accident with a high rate of vehicle deceleration. There is an increased risk of injury, possibly even fatal.



Have SRS checked and repaired immediately at a qualified specialist workshop.

SRS functions are checked regularly when you switch on the ignition and when the engine is running. Therefore, malfunctions can be detected in good time.

The  SRS warning lamp in the instrument cluster lights up when the ignition is switched on. It goes out no later than a few seconds after the engine is started.

The SRS components are in operational readiness when the  SRS indicator lamp goes out while the engine is running.

There is a malfunction if:

- the  SRS warning lamp does not light up when the ignition is switched on
- the engine is running and the  SRS warning lamp does not go out after a few seconds
- the engine is running and the  SRS warning lamp lights up again

Safety guidelines for seat belts, Emergency Tensioning Devices (ETDs) and air bags

WARNING

- Damaged seat belts or seat belts that have been subjected to stress in an accident must be replaced. Their anchoring points must also be checked. Only use seat belts installed or supplied by an authorized Mercedes-Benz Center.
- Air bags and pyrotechnic Emergency Tensioning Devices (ETDs) contain perchlorate material, which may require special handling and regard for the environment. Check your national disposal guidelines. California residents, see www.dtsc.ca.gov/HazardousWaste/Perchlorate/index.cfm.
- Air bags and ETDs are designed to function on a one-time-only basis. An air bag or ETD that has deployed must be replaced.
- Do not pass seat belts over sharp edges. They could tear.
- Do not make any modification that could change the effectiveness of the seat belts.
- Do not bleach or dye seat belts as this may severely weaken them. In a crash they may not be able to provide adequate protection.
- No modifications of any kind may be made to any components or wiring of the SRS.
- Do not change or remove any component or part of the SRS.
- Do not install additional trim material, seat covers, badges, etc. over the steering wheel hub, front-passenger front air bag

cover, outer sides of the seat backrests, door trim panels, or door frame trims.

- Do not install additional electrical/ electronic equipment on or near SRS components and wiring.
- Keep area between air bags and occupants free of objects (e.g. packages, purses, umbrellas, etc.).
- Air bag system components will be hot after an air bag has inflated. Do not touch them.
- Never place your feet on the instrument panel, dashboard, or on the seat. Always keep both feet on the floor in front of the seat.
- Improper repair work on the SRS creates a risk of rendering the SRS inoperative or causing unintended air bag deployment. Work on the SRS must therefore only be performed by qualified technicians. Contact an authorized Mercedes-Benz Center.
- For your protection and the protection of others, when scrapping the air bag unit or ETD, our safety instructions must be followed. These instructions are available from any authorized Mercedes-Benz Center.
- Given the considerable deployment speed, required inflation volume, and the material of the air bags, there is the possibility of abrasions or other, potentially more serious injuries resulting from air bag deployment.

If you sell your vehicle, Mercedes-Benz strongly recommends that you inform the subsequent owner that the vehicle is equipped with SRS. Also, refer them to the applicable section in the Operator's Manual.

Air bags

Important safety notes

WARNING

Air bag functionality can only be assured if the following parts are not covered and no badges or stickers are attached to them:

- padded steering wheel boss
- knee bag cover underneath the steering column and underneath the glove box
- front-passenger front air bag cover
- outer side of seat bolsters
- upper door panel in the area of the side windows

WARNING

Air bags are designed to reduce the potential of injury and fatality rates in certain situations:

- frontal impacts (driver's and front-passenger front air bags and knee bags)
- side impacts (head bags and side impact air bags)

However, no system available today can completely eliminate injuries and fatalities.

When the air bags are deployed, a small amount of powder temporarily comes out of the air bags. This powder generally does not constitute a health hazard and does not indicate that there is a fire in the vehicle. In order to prevent potential breathing difficulties, you should leave the vehicle as soon as it is safe to do so. If you have any breathing difficulty but cannot get out of the vehicle, then get fresh air by opening a side window or door.

WARNING

In order to reduce the potential danger of injuries caused during the deployment of the front air bags, the driver and front passenger must always be correctly seated and wear their seat belts.

For maximum protection in the event of a collision, you must always be in the normal seat position with your back against the backrest. Fasten your seat belt and make sure that it is correctly positioned on your body.

As the air bag inflates with considerable speed and force, a proper seating position and correct positioning of the hands on the steering wheel will help to keep you at a safe distance from the air bag. Occupants who are not wearing their seat belt, are not seated properly or are too close to the air bag can be seriously injured or killed by an air bag as it inflates with great force instantaneously:

- sit with the seat belt fastened correctly and in a position that is as upright as possible with your back against the backrest.
- move the driver's seat as far back as possible, still permitting proper operation of vehicle controls. The distance from the center of the driver's chest to the center of the air bag cover on the steering wheel must be at least 10 inches (25 cm) or more. You should be able to accomplish this by adjusting the seat and steering wheel. If you have any difficulties, please contact an authorized Mercedes-Benz Center.
- do not lean your head or chest close to the steering wheel or dashboard.
- only hold the steering wheel on the outside. Placing hands and arms inside the rim can increase the risk and potential severity of hand/arm injury when the driver front air bag inflates.
- adjust the front-passenger seat as far back as possible from the dashboard when the seat is occupied.
- Occupants, especially children, should never place their bodies or lean their heads in the area of the door or the seat where the head bag or side impact air bag inflates. This could result in serious injuries or death should the head bag or side impact air bag be deployed. Always sit as upright as possible, wear the seat belt properly and use an appropriately sized infant restraint,

toddler restraint, or booster seat recommended for the size and weight of the child.

Failure to follow these instructions can result in severe injuries to you or other occupants.

If you sell your vehicle, it is important that you make the buyer aware of this safety information. Be sure to give the buyer this Operator's Manual.

WARNING

There is a possibility of a head bag- or side impact air bag-related injury if occupants, especially children, are not properly seated or restrained when next to a head bag or side impact air bag that needs to deploy rapidly in a side impact in order to do its job.

To help avoid the possibility of injury, please follow these guidelines:

- (1) Occupants, especially children, should never place their bodies or lean their heads in the area of the door or the seat where the head bag or side impact air bag inflates. This could result in serious injuries or death should the head bag or side impact air bag be deployed.
- (2) Always sit as upright as possible, and use the seat belts properly. Make sure that children 12 years old and under use an appropriately infant restraint, toddler restraint or booster seat recommended for the size and weight of the child.
- (3) Always wear seat belts properly.

If you believe that, even with the use of these guidelines, it would be safer for your passenger seat occupants to have the passenger side head bag or side impact air bag deactivated, then deactivation can be carried out upon your written request at an authorized Mercedes-Benz Center at an additional cost.

Please contact an authorized Mercedes-Benz Center or call the Customer Assistance

Center (in the USA) at 1-800-FOR-MERCEdes (1-800-367-6372), or Customer Service (in Canada) at 1-800-387-0100 for details.

The air bags are only deployed if the air bag control unit detects the need for deployment. Only in the event of such a situation, will the air bags provide their supplemental protection.

The driver and passenger should always wear their seat belts. Otherwise it is not possible for the air bags to provide their supplemental protection.

In case of other types of impacts and impacts below air bag deployment thresholds, air bags will not deploy. The driver and passenger will then be protected to the extent possible by a properly fastened seat belt. A properly fastened seat belt is also needed to provide the best possible protection in a rollover.

Air bags provide additional protection; they are not, however, a substitute for seat belts. All vehicle occupants must fasten their seat belts regardless of whether your vehicle is equipped with air bags or not.

It is important for your safety and that of your passenger to have deployed air bags replaced and to have any malfunctioning air bags repaired. This will help to make sure the air bags continue to provide supplemental crash protection for occupants.

Front air bags

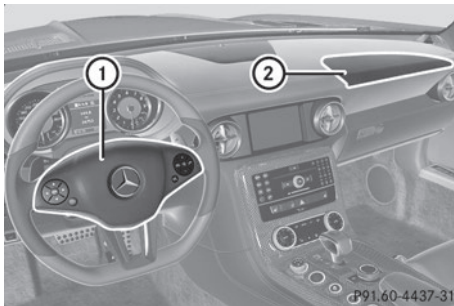

Driver's air bag ① deploys in front of the steering wheel; front-passenger front air

bag ② deploys in front of and above the glove box.

The front air bags increase protection for the driver's and front-passenger's head and chest.

They are deployed:

- in the event of certain frontal impacts
- if the system determines that air bag deployment can offer additional protection to that provided by the seat belt
- depending on whether the seat belt is being used
- independently of other air bags in the vehicle

If the vehicle rolls over, the front air bags are generally not deployed. If the system detects high vehicle deceleration in a longitudinal direction, the front air bags are deployed.

Your vehicle has adaptive, two-stage front air bags. In the event of a collision, the air bag control unit evaluates the vehicle deceleration. When the first deployment threshold is reached, the front air bag is filled with enough propellant gas to reduce the risk of injuries. The front air bag is fully deployed if a second deployment threshold is exceeded within a few milliseconds.

The deployment of the front-passenger front air bag is also influenced by the weight category of the front passenger, which is determined by the Occupant Classification System (OCS) (▷ page 42).

The front air bags are not deployed in situations where a low impact severity is predicted. You will then be protected by the fastened seat belt.

The front-passenger front air bag will only be deployed if:

- the Occupant Classification System (OCS) has detected that the front-passenger seat is occupied
- the  indicator lamp on the center console is not lit
- the air bag control unit predicts a high-impact severity

Driver's/front-passenger knee bag

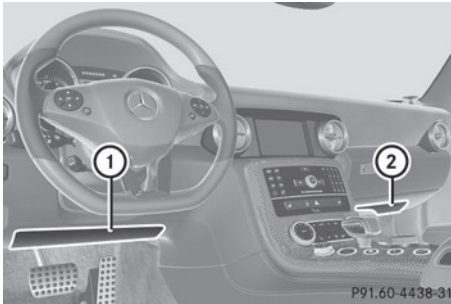

Driver's knee bag ① deploys underneath the steering column and front-passenger knee bag ② underneath the glove box. They deploy together with the front air bags. They are designed to operate together with the front air bags in frontal impacts if certain thresholds are exceeded. The knee bags operate at best in conjunction with correctly positioned and fastened seat belts.

The driver and front-passenger knee bags enhance the level of protection against:

- knee injuries
- thigh injuries
- lower leg injuries

Side impact air bags

WARNING

The pressure sensors for side impact air bag control are located in the doors. Do not modify any components of the doors or door trim panels including, for example, the addition of door speakers.

Improper repair work on the doors or the modification or addition of components to the doors create a risk of rendering the side impact air bags inoperative or causing unintended air bag deployment. Work on the doors must therefore only be performed by qualified technicians. Contact an authorized Mercedes-Benz Center.

WARNING

Only use seat covers which have been tested and approved by Mercedes-Benz for your vehicle model. Using other seat covers may interfere with or prevent the deployment of the side impact air bags. Contact an authorized Mercedes-Benz Center for availability.

When deployed, the side impact air bags offer additional protection for the thorax of the vehicle occupants on the side of the vehicle on which the impact occurs. However, they do not protect the:

- head
- neck
- arms



Side impact air bags ① deploy next to the outer seat cushions.

The side impact air bags are deployed:

- on the side on which an impact occurs
- at the start of an accident with a high rate of lateral vehicle deceleration or acceleration, e.g. in a side impact
- independently of the use of the seat belt
- independently of the front air bags
- independently of the ETDs

If the vehicle rolls over, the side impact air bags are generally not deployed. They are deployed if the system detects high vehicle deceleration or acceleration in a lateral direction and determines that side impact air bag deployment can offer additional protection to that provided by the seat belt.

Side impact air bags will not deploy in side impacts which do not exceed the system's preset deployment thresholds for lateral acceleration/deceleration. You will then be protected by the fastened seat belt.

If the OCS detects that the front-passenger seat is not occupied and the front-passenger seat belt is not fastened (the belt tongue is not engaged in the seat belt buckle), the side impact air bag on the front-passenger side will not deploy. The side impact air bag on the front-passenger side will deploy if the front-passenger seat belt is fastened, regardless of whether the front-passenger seat is occupied or not.

Head bags

The head bags enhance the level of protection for the head (but not chest or arms) of the vehicle occupants on the side of the vehicle on which the impact occurs.

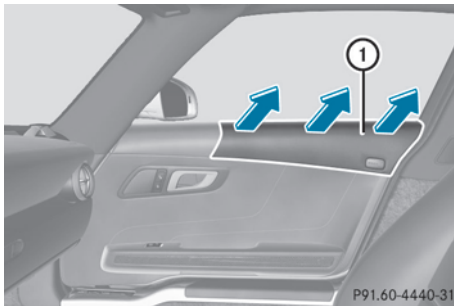

Headbags ① deploy in the side window area. They are deployed:

- on the side on which an impact occurs
- at the start of an accident with a high rate of lateral vehicle deceleration or acceleration, e.g. in a side impact
- if the system determines that the vehicle occupants are offered additional protection to that provided by the seat belt
- independently of the use of the seat belt
- independently of the ETDs
- on the driver's side and passenger side, in the event of a vehicle rollover and if the



system determines that air bag deployment can offer the vehicle occupants additional protection to that provided by the seat belt

- independently of the front air bags
- Head bags ① will not deploy in side impacts which do not exceed the system's preset deployment thresholds for lateral acceleration/deceleration. You will then be protected by the fastened seat belt.

If the OCS has classified the front-passenger seat as unoccupied and the front-passenger seat belt is not fastened, the head bag on the passenger side will not deploy. The head bag on the front-passenger side will deploy if the front-passenger seat belt is fastened, regardless of whether the front-passenger seat is occupied or not.

Occupant Classification System (OCS)

How the Occupant Classification System works

The Occupant Classification System (OCS) categorizes the occupant on the front-passenger seat using a weight sensor. The front-passenger front air bag and the front-passenger knee bag are deactivated automatically for certain weight categories. The  indicator lamp shows you the current status. If the  indicator lamp lights up, the front-passenger front air bag and the front-passenger knee bag are disabled.

The system does not deactivate:

- the front-passenger side impact air bag
- the front-passenger head bag
- the Emergency Tensioning Devices

To be classified correctly, the front passenger must sit:



- with the seat belt fastened correctly
- in a position that is as upright as possible with their back against the seat backrest
- with their feet on the floor

If the front-passenger's weight is transferred to another object in the vehicle (e.g. by leaning on armrests), OCS may not be able to approximate the occupant's weight category. In order to determine whether or not the front passenger has been detected, both the driver and the front passenger should observe the  indicator lamp.

If the front-passenger seat, the seat cover or the seat cushion are damaged, have the necessary repair work carried out at an authorized Mercedes-Benz Center.

For safety reasons, Mercedes-Benz recommends that you only use seat accessories that have been approved by Mercedes-Benz.



WARNING

If the  indicator lamp lights up when the front-passenger seat is occupied by an adult or a larger person, ask the passenger to reposition themselves on the seat so that the  indicator lamp goes out.

In the event of a collision, the air bag control unit will not allow front-passenger front air bag and front-passenger knee bag deployment when the OCS has classified the front-passenger occupant as weighing as much as or less than a typical 12-month-old child in a standard child restraint or if the front-passenger seat is classified as being unoccupied.

If OCS has detected that the front passenger weighs the same as or less than a typical 12-month-old child in a standard child restraint system, the  indicator lamp lights up when the engine is started and remains lit. This indicates that the front-passenger front air bag is deactivated.

If OCS determines that the front-passenger seat is unoccupied, the  indicator lamp lights up once the engine has been started and remains lit. This shows that the front-passenger front air bag and front-passenger knee bag are deactivated.

If OCS determines that the front passenger weighs more than a typical 12 month old child in a standard child restraint system and classifies this as a small person (e.g. a teenager or small adult), the  indicator lamp lights up for approximately 6 seconds when the engine is started. Depending on occupant weight sensor readings from the seat, it will then remain illuminated or go out. If the  indicator lamp is illuminated, the front-passenger front air bag is deactivated. With the  indicator lamp out, the front-passenger front air bag and front-passenger knee bag are deactivated.

If OCS has determined that the front passenger is an adult or medium sized person, the  indicator lamp lights up for approximately 6 seconds when the engine is started and then goes out. This shows that the front-passenger front air bag and front-passenger knee bag are activated.

If the  indicator lamp is illuminated, the front-passenger front air bag and the front-passenger knee bag are deactivated and are not deployed.

If the  indicator lamp does not light up, the front-passenger air bag is enabled and will be deployed:

- in the event of certain frontal impacts
- if the impact exceeds a preset deployment threshold
- independently of the other air bags

If the front-passenger air bag is deployed, the rate of inflation is influenced by:

- the rate of vehicle deceleration as assessed by the air bag control unit
- the front passenger's weight category as determined by the OCS

For further information, see "Air bag display messages" (▷ page 159).

WARNING





Children 12 years old and under must be seated and properly secured in an appropriate

infant restraint, toddler restraint, or booster seat recommended for the size and weight of the child.

The infant or child restraint must be properly secured with the vehicle's seat belt fully in accordance with the child seat manufacturer's instructions.

Occupants, especially children, should always sit as upright as possible, wear the seat belt properly and use an appropriately sized infant restraint, toddler restraint, or booster seat recommended for the size and weight of the child.

Children can be killed or seriously injured by an inflating air bag. Note the following important information:

- Your vehicle is equipped with air bag technology designed to deactivate the front-passenger front air bag in your vehicle when the system senses the weight of a typical 12-month-old child or less along with the weight of a standard appropriate child restraint on the front-passenger seat.
- A child in a rear-facing child restraint on the front-passenger seat will be seriously injured or even killed if the front-passenger front air bag inflates in a collision which could occur under some circumstances, even with the air bag technology installed in your vehicle.
- If you install a rear-facing child restraint on the front-passenger seat, make sure the  indicator lamp is illuminated, indicating that the front-passenger front air bag is deactivated. Should the  indicator lamp not illuminate or go out while the restraint is installed, please check installation. Periodically check the  indicator lamp while driving to make sure the  indicator lamp is illuminated. If the  indicator lamp goes out or remains out, do not transport a child on the front-passenger seat until the system has been repaired.

A child in a rear-facing child restraint on the front-passenger seat will be seriously injured or even killed if the front-passenger front air bag inflates.

- If you place a child in a forward-facing child restraint on the front-passenger seat:
 - move the seat as far back as possible
 - use the proper child restraint recommended for the age, size and weight of the child
 - secure child restraint with the vehicle's seat belt according to the child seat manufacturer's instructions
- For children larger than a typical 12-month-old child, the front-passenger front air bag may or may not be activated.

If the driver's air bag deploys, this does not mean that the front-passenger front air bag will also deploy.

The OCS may have detected that the seat:

- is empty or occupied by a person with a weight of up to or less than that of a typical 12-month-old child seated in a standard child restraint.
- is occupied by a small individual, such as a young teenager or a small adult.
- is occupied by a child in a child restraint system whose weight is greater than that of a typical 12-month-old child.

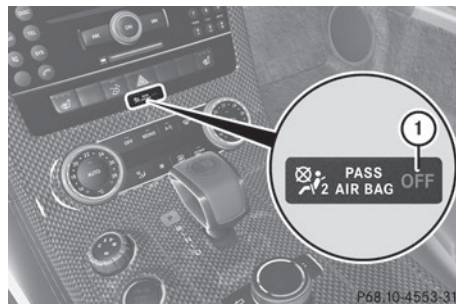

These are examples of when the OCS deactivates the front-passenger front air bag and front-passenger knee bag. Deactivation takes place although the collision fulfills the criteria for deploying the driver's air bag.



If the SmartKey has been removed from the ignition lock or the Start/Stop button has been set to position **0**, the

 indicator lamp **1** does not light up.

WARNING

If the red  SRS warning lamp in the instrument cluster and the  indicator lamp light up simultaneously, the OCS is malfunctioning. The front passenger front air bag will be deactivated in this case. Have the system checked by qualified technicians as soon as possible. Contact an authorized Mercedes-Benz Center.

Only have the seat repaired or replaced at an authorized Mercedes-Benz Center.

In order to ensure proper operation of the air bag system and OCS:

- Sit with the seat belt properly fastened in a position that is as upright as possible with your back against the seat backrest.
- When seated, a passenger should not position him/herself in such a way as to cause the passenger's weight to be lifted from the seat cushion as this may result in the OCS being unable to correctly approximate the passenger's weight category.
- Read and observe all warnings in this chapter.

System self-test

The  indicator lamp illuminates when you:

- turn the SmartKey to position **1** or **2** in the ignition lock
- press the Start/Stop button once or twice

If an adult occupant is properly sitting on the passenger seat and the OCS classifies the occupant as an adult, the  indicator lamp illuminates and goes out again after approximately 6 seconds.

If the seat is not occupied and the OCS classifies the front passenger seat as being

unoccupied, the  indicator lamp will illuminate and not go out.

WARNING

If the  indicator lamp does not illuminate, the system is not functioning. You must contact an authorized Mercedes-Benz Center before seating any child on the passenger seat.

For more information, see "Problems with the Occupant Classification System" ([▷ page 46](#)).

WARNING

Never place anything between seat cushion and child seat (e.g. a pillow), since it reduces the effectiveness of the OCS. The underside and rear side child restraint system must be placed entirely on the seat cushion and the backrest of the front-passenger seat backrest.

If necessary, adjust the tilt of the passenger seat backrest.

An incorrectly mounted child seat could cause injuries to the child in case of an accident, instead of increasing protection for the child.



Follow the manufacturer's instructions for installation of child restraint systems.

Problems with the Occupant Classification System

Problem	Possible causes/consequences and ► Solutions
<p>The  indicator lamp illuminates and remains illuminated. The person on the front-passenger seat:</p> <ul style="list-style-type: none"> • has the weight of a typical adult • has been determined by the system not to be a child. 	<p>The OCS is malfunctioning.</p> <ul style="list-style-type: none"> ► Have the OCS checked as soon as possible at an authorized Mercedes-Benz Center. ► Observe the additional display messages in the multifunction display (► page 159).

WARNING

If the  indicator lamp illuminates and remains illuminated when the weight of a typical adult or someone larger than a small individual has been detected on the passenger seat, do not allow any occupant to use the passenger seat until the system has been repaired.

Problem	Possible causes/consequences and ► Solutions
<p>The  indicator lamp does not illuminate and/or does not remain illuminated. The front-passenger seat is:</p> <ul style="list-style-type: none"> • unoccupied • occupied with a weight up to or less than a typical 12-month-old child in a standard child restraint system 	<p>The OCS is malfunctioning.</p> <ul style="list-style-type: none"> ► Make sure there is nothing between the seat cushion and the child seat. ► Check the installation of the child restraint system. ► Make sure that no objects are applying additional weight onto the seat. ► If the  indicator lamp does not illuminate, have the OCS checked as soon as possible at an authorized Mercedes-Benz Center. Do not transport a child on the front-passenger seat as long as the OCS is not functioning. ► Observe the additional display messages in the multifunction display (► page 159).

WARNING

If the  indicator lamp does not illuminate or remains out with the weight of a typical 12-month-old child in a standard child restraint or less, or is unoccupied, on the front-passenger seat, do not transport a child on the front-passenger seat until the system has been repaired.

Exiting in an emergency

If the vehicle is lying on its roof after an accident, the hinge fasteners of the gullwing doors are released pyrotechnically. You will hear a bang if this is the case. After the fasteners have been released, the doors are forced outwards. Simultaneously, the door locks are unlocked. The  SRS warning lamp lights up.

- i** The hinge fasteners are only released when the control unit recognizes that certain conditions have been fulfilled, e.g. when the vehicle is in a stabilized position on its roof.

The doors can then be moved from the inside/outside by pulling the door handle.

Seat belts

Important safety notes

The use of infant or child restraints is required by law in all 50 states, the District of Columbia, the U.S. territories and all Canadian provinces.

Even where this is not the case, all vehicle occupants should have their seat belts fastened when the vehicle is in motion.

- i** See "Children in the vehicle" ([▷ page 51](#)) for further information on infants and children traveling in the vehicle as well as on child restraint systems.

WARNING

Always fasten your seat belt before driving off. Always make sure your passenger is properly restrained. You and your passenger should always wear seat belts.

Failure to wear and properly fasten and position your seat belt considerably increases your risk of injuries and their likely severity in an accident.

If you are ever in an accident, your injuries could be considerably more severe if you have not fastened your seat belt correctly. If you do

not fasten your seat belt, you are much more likely to collide with parts of the vehicle interior or be ejected from it. This may result in serious or fatal injury.

In the same crash, the possibility of serious or fatal injury is considerably reduced if you wear your seat belt properly. The air bags can only offer the intended protection if the occupants are wearing their seat belts properly.

WARNING

Never ride in a moving vehicle with the seat backrest in an excessively reclined position as this can be dangerous. You could slide under the seat belt in a collision. If you slide under it, the seat belt would apply force at the abdomen or neck. That could cause serious or even fatal injuries. The seat backrest and seat belt provide the best restraint when the wearer is in a position that is as upright as possible and the seat belt is properly positioned on the body.

WARNING

Never let more people ride in the vehicle than there are seat belts available. Make sure everyone riding in the vehicle is correctly restrained with a separate seat belt. Never use a seat belt for more than one person at a time.

WARNING

Damaged seat belts or seat belts that have been subjected to stress in an accident must be replaced and their anchoring points must also be checked.

Only use seat belts which have been approved by Mercedes-Benz.

Do not make any modifications to the seat belts. This can lead to unintended activation of the ETDs or to their failure to activate when necessary.

Do not bleach or dye seat belts as this may severely weaken them. In a crash they may not be able to provide adequate protection.

Have all work carried out only by qualified technicians. Contact an authorized Mercedes-Benz Center.

Correct use of the seat belts

WARNING

USE SEAT BELTS PROPERLY

- Seat belts can only work when used properly. Never wear seat belts in any other way than as described in this section, as that could result in serious injuries in the event of an accident.
- Each occupant should wear their seat belt at all times, because seat belts help reduce the likelihood of and potential severity of injuries in accidents, including rollovers. The integrated restraint system includes SRS (driver front air bag, knee bags, front-passenger front air bag, side impact air bags, head air bags), Emergency Tensioning Devices (ETDs) and seat belt force limiters. The system is designed to enhance the protection offered to properly belted occupants in certain frontal (front air bags, knee bags and ETDs) and side (side impact air bags, head air bags and ETDs) impacts which exceed preset deployment thresholds.
- Never wear the shoulder belt under your arm, across your neck or off your shoulder. In a frontal crash, your body would move too far forward. That would increase the chance of head and neck injuries. The seat belt would also apply too much force to the ribs or abdomen, which could severely injure internal organs such as your liver or spleen.

Adjust the seat belt so that the shoulder section is located as close as possible to the middle of the shoulder (it should not touch the neck).

- Position the lap belt as low as possible on your hips and not across the abdomen. If the lap belt is positioned across your

abdomen, it could cause serious injuries in a crash.

- Never wear seat belts over rigid or breakable objects in or on your clothing, such as eyeglasses, pens, keys etc., as these might cause injuries.
- Make sure the seat belt is always fitted snugly. Take special care of this when wearing loose clothing.
- Never use a seat belt for more than one person at a time. Do not fasten a seat belt around a person and another person or other objects at the same time.
- Seat belts should not be worn twisted. In a crash, you would not have the full width of the seat belt to distribute impact forces. The twisted seat belt against your body could cause injuries.
- Pregnant women should also always use a lap-shoulder belt. The lap belt portion should be positioned as low as possible on the hips to avoid any possible pressure on the abdomen.
- Place the seat backrest in a position that is as upright as possible.
- Check your seat belt during travel to make sure it is properly positioned.
- Never place your feet on the instrument panel, dashboard, or on the seat. Always keep both feet on the floor in front of the seat.
- When using a seat belt to secure infant restraints, toddler restraints, or children in booster seats, always follow the child seat manufacturer's instructions.

WARNING

Do not pass seat belts over sharp edges. They could tear.

Do not allow the seat belt to get caught in the door or in the seat adjustment mechanism. This could damage the seat belt.

Never attempt to make modifications to seat belts. This could impair the effectiveness of the seat belts.

Fastening seat belts

WARNING

Children 12 years old and under must be seated and properly secured in an appropriately sized infant restraint, child restraint system, or booster seat recommended for the size and weight of the child. For additional information, see the "Children in the vehicle" section.

A child's risk of serious or fatal injuries is significantly increased if the child restraints are not properly secured in the vehicle and/or the child is not properly secured in the child restraint.

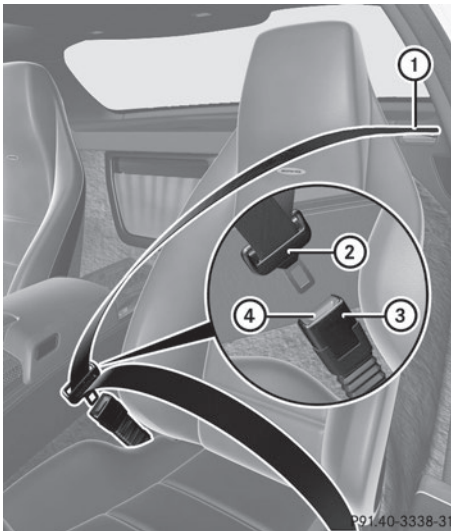

- ▶ Adjust the seat and move the backrest to an almost vertical position (▷ page 79).
- ▶ Pull the seat belt smoothly from belt sash guide ①.
- ▶ Without twisting it, guide the shoulder section of the seat belt across the middle of your shoulder and the lap section across your hips.
- ▶ Engage belt tongue ② in buckle ③.
- ▶ If necessary, pull upwards on the shoulder section of the seat belt to tighten the belt across your body.

The seat belt on the front-passenger side is equipped with a special seat belt retractor to secure child restraint systems properly on the front-passenger seat. For further information on special seat belt retractors, see (▷ page 53).

For more information about releasing the seat belt with release button ④, see "Releasing seat belts" (▷ page 49).

Releasing seat belts

- ▶ Press release button ④ (▷ page 49) and guide belt tongue ② (▷ page 49) back towards belt sash guide ① (▷ page 49).



! Make sure that the seat belt is fully rolled up. Otherwise, the seat belt or belt tongue will be trapped in the door or in the seat mechanism. This could damage the door, the door trim panel and the seat belt. Damaged seat belts can no longer fulfill their protective function and must be replaced. Consult an authorized Mercedes-Benz Center.

Belt warning for the driver and front passenger

Regardless of whether the driver's and front-passenger seat belts have already been fastened, the  seat belt warning lamp lights up for six seconds each time the engine is started. It then goes out once the driver and the front passenger have fastened their seat belts.

If the driver's seat belt is not fastened when the engine is started, an additional warning tone will sound. The warning tone switches off after approximately six seconds or once the driver's seat belt is fastened.

If after six seconds the driver or front passenger have not fastened their seat belts and the doors are closed:

- the  seat belt warning lamp remains lit as long as either the driver's or front-passenger's seat belt is not fastened
- and if the vehicle speed exceeds 15 mph (25 km/h) once, the  seat belt warning lamp lights up. Additionally, a warning tone sounds with increasing intensity for a maximum of 60 seconds or until the driver's and front passenger's seat belts are fastened.

If the driver or front-passenger seat belt is unfastened while the vehicle is in motion, the  seat belt warning lamp lights up and a warning tone sounds again.

The warning tone ceases even if the driver or front-passenger seat belt has still not been fastened after 60 seconds. The  seat belt warning lamp stops flashing but remains lit.

After the vehicle comes to a standstill, the warning tone is reactivated and the  seat belt warning lamp flashes again if the vehicle speed exceeds 15 mph (25 km/h).

The  seat belt warning lamp only goes out if:

- both the driver and the front passenger have fastened their seat belts.
- or
- the vehicle is stationary and a door is open.

i For more information on the  seat belt warning lamp, see "Warning and indicator lamps in the instrument cluster, seat belt" (▷ page 177).

Emergency Tensioning Devices, seat belt force limiters

The seat belts are equipped with ETDs and seat belt force limiters.

! If the co-driver's seat is unoccupied, do not insert the belt tongue into the buckle of the co-driver's seat. This may otherwise lead to the triggering of the Emergency

Tensioning Device in the event of an accident, which will then need to be replaced.

The ETDs tighten the seat belts in an accident, pulling them close against the body.

The ETDs do not correct incorrect seat positions or incorrectly fastened seat belts.

The ETDs do not pull vehicle occupants back towards the backrest.

Seat belt force limiters, when activated, are employed to help reduce the peak force exerted by the seat belts on occupants during a crash.

The seat belt force limiters are synchronized with the front air bags, which take on a part of the deceleration force. Thus, the force exerted on the occupant is distributed over a greater area.

When the ignition is switched on, the ETDs cannot be triggered unless:

- the restraint systems are operational; see "SRS warning lamp" (▷ page 37)
- the belt tongue is engaged in the buckle on each of the three-point seat belts
- the front-passenger seat is occupied and the belt tongue is engaged in the buckle on the front-passenger side

The ETDs are triggered depending on the type and severity of an accident:

- in the event of a head-on or rear-end collision, if the vehicle decelerates or accelerates rapidly in a longitudinal direction during the initial stages of the impact
- in the event of a side impact, if the vehicle is subjected to high lateral acceleration/ deceleration
- in certain situations, if the vehicle rolls over and the system determines that it can provide additional protection

If the Emergency Tensioning Devices (ETDs) are triggered, you will hear a bang, and a small amount of smoke may also be released. Only in rare cases will the bang affect your hearing. The smoke that is released generally does not

constitute a health hazard. The  SRS warning lamp lights up.

WARNING

Pyrotechnic ETDs that were activated must be replaced.

For your safety, when disposing of the pyrotechnic ETDs always follow our safety instructions. These are available at any authorized Mercedes-Benz Center.

Child restraint systems

Children in the vehicle

Important safety notes

WARNING

Children 12 years old and under must be seated and properly secured in an appropriate infant restraint, toddler restraint, or booster seat recommended for the size and weight of the child.





The infant or child restraint must be properly secured with the vehicle's seat belt fully in accordance with the child seat manufacturer's instructions.

Occupants, especially children, should always sit as upright as possible, wear the seat belt properly and use an appropriately sized infant restraint, toddler restraint, or booster seat recommended for the size and weight of the child.

Children can be killed or seriously injured by an inflating air bag. Note the following important information:

- Your vehicle is equipped with air bag technology designed to deactivate the front-passenger front air bag in your vehicle when the system senses the weight of a typical 12-month-old child or less along with the weight of a standard appropriate child restraint on the front-passenger seat.
- A child in a rear-facing child restraint on the front-passenger seat will be seriously injured or even killed if the front-passenger

front air bag inflates in a collision which could occur under some circumstances, even with the air bag technology installed in your vehicle.

- If you install a rear-facing child restraint on the front-passenger seat, make sure the  indicator lamp is illuminated, indicating that the front-passenger front air bag is deactivated. Should the  indicator lamp not illuminate or go out while the restraint is installed, please check installation. Periodically check the  indicator lamp while driving to make sure the  indicator lamp is illuminated. If the  indicator lamp goes out or remains out, do not transport a child on the front-passenger seat until the system has been repaired.

A child in a rear-facing child restraint on the front-passenger seat will be seriously injured or even killed if the front-passenger front air bag inflates.

- If you place a child in a forward-facing child restraint on the front-passenger seat:
 - move the seat as far back as possible
 - use the proper child restraint recommended for the age, size and weight of the child
 - secure child restraint with the vehicle's seat belt according to the child seat manufacturer's instructions
- For children larger than a typical 12-month-old child, the front-passenger front air bag may or may not be activated.

WARNING

Infants and small children should never share a seat belt with another occupant. In the event of an accident, they could be crushed between the occupant and seat belt.

A child's risk of serious or fatal injuries is significantly increased if the child restraints are not properly secured in the vehicle and/or the child is not properly secured in the child restraint.

Children that are too large for a child restraint must travel in seats using normal seat belts. Position the shoulder belt across the chest and shoulder, not the face or neck. A booster seat may be necessary to achieve proper seat belt positioning for children over 41 lbs (18 kg) until they reach a height where a lap/shoulder belt fits properly without a booster seat.

When the child restraint is not in use, remove it from the vehicle or secure it with the seat belt to prevent the child restraint from becoming a projectile in the event of an accident.

WARNING

When leaving the vehicle, always remove the SmartKey from the ignition lock. Always take the SmartKey with you and lock the vehicle. Do not leave children unattended in the vehicle, even if they are secured in a child restraint system, or with access to an unlocked vehicle. A child's unsupervised access to a vehicle could result in an accident and/or serious personal injury. The children could:

- injure themselves on parts of the vehicle
- be seriously or fatally injured through excessive exposure to extreme heat or cold
- injure themselves or cause an accident with vehicle equipment that can be operated even if the SmartKey is removed from the ignition lock or removed from the vehicle, such as seat adjustment, steering wheel adjustment, or the memory function

If children open a door, they could injure other persons or get out of the vehicle and injure themselves or be injured by following traffic.

Do not expose the child restraint system to direct sunlight. The child restraint system's metal parts, for example, could become very hot, and the child could be burned on these parts.

WARNING

Do not carry heavy or hard objects in the passenger compartment unless they are firmly secured in place.

Unsecured or improperly positioned cargo increases a child's risk of injury in the event of:

- strong braking maneuvers
- sudden changes of direction
- an accident

If an infant or child is traveling in the vehicle:

- ▶ Secure the child with a child or infant seat restraint system appropriate to the age and weight of the child.
- ▶ Make sure that the infant or child is properly secured at all times while the vehicle is in motion.

Mercedes-Benz recommends that you always properly secure all infants and children with a child or infant seat restraint system for the trip.

The use of seat belts and infant and child restraint systems is required by law in:

- all 50 states
- the U.S. territories
- the District of Columbia
- all Canadian provinces

Infants and children must always be seated in an appropriate infant or child restraint system recommended for the size and weight of the child. The infant or child restraint system must be properly secured with a three-point seat belt in accordance with the manufacturer's instructions.

All infant or child restraint systems must meet the following standards:

- U.S. Federal Motor Vehicle Safety Standards 213 and 225
- Canadian Motor Vehicle Safety Standards 213 and 210.2

Confirmation that the child restraint system corresponds to the standards can be found on an instruction label on the child restraint

system. This confirmation can also be found in the installation instructions that are included with the child restraint system. Always read and follow the manufacturer's instructions when using an infant or child restraint system or booster seat. Observe the warning labels in the vehicle interior or on the infant or child restraint.

Special seat belt retractor

WARNING

If you release the seat belt when driving, the special seat belt retractor is deactivated.

The released seat belt cannot be engaged again while driving, because the inertia reel pulls in the seat belt a small distance. The child restraint system is no longer properly secured. There is an increased risk of serious injury or even fatal injury.

Always keep the seat belt of the activated special seat belt retractor engaged when driving.

The seat belt on the front-passenger side is equipped with a special seat belt retractor. When enabled, the special seat belt retractor ensures that the seat belt does not slacken once the child seat is secured.

Installing a child restraint system:

- ▶ Always comply with the manufacturer's installation instructions.
- ▶ Pull the seat belt smoothly from the seat belt retractor.
- ▶ Engage the seat belt tongue in the belt buckle.

Activating the special seat belt retractor:

- ▶ Pull the seat belt out fully and let the seat belt retractor retract it again. While the seat belt is retracting, you should hear a ratcheting sound. The special seat belt retractor is activated.
- ▶ Push down on the child restraint system to take up any slack.

Removing a child restraint system/
deactivating the special seat belt retractor:

- ▶ Always comply with the manufacturer's installation instructions.
- ▶ Press the seat belt release button and guide the belt tongue to the belt outlet. The special seat belt retractor is deactivated.

Installing child restraint systems

Observe the "Important safety notes" section (▷ page 51).

The Top Tether anchorage is installed behind the front-passenger seat.

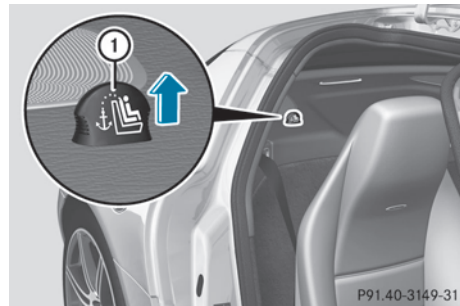

- ▶ Slide the front-passenger seat forward.
- ▶ Remove cover (1) from the Top Tether anchorage in the direction of the arrow.

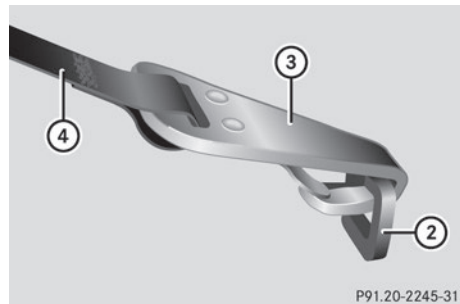

- ▶ Position Top Tether belt (4). Comply with the manufacturer's installation instructions when doing so.
- ▶ Hook Top Tether hook (3) into Top Tether anchorage (2).

Ensure that:

- Top Tether hook (3) is hooked into Top Tether anchorage (2) as shown.
- Top Tether belt (4) is not twisted.

When Top Tether hook (3) is connected, the child restraint system can be secured.

- ▶ Install the child restraint system.
- ▶ Tension Top Tether belt (4). Comply with the manufacturer's installation instructions when doing so.

The child restraint system with Top Tether belt (4) has been removed:

- ▶ Slide cover (1) onto Top Tether anchorage (2).

Driving safety systems

Overview of driving safety systems

In this section, you will find information about the following driving safety systems:

- ABS (Anti-lock Braking System)
- BAS (Brake Assist System)
- ESP® (Electronic Stability Program)
- EBD (Electronic Brake force Distribution)
- ADAPTIVE BRAKE

Important safety notes

If you fail to adapt your driving style or become distracted, the driving safety systems can neither reduce the risk of accident nor override the laws of physics. Driving safety systems are merely aids designed to assist driving. You are responsible for the distance to the vehicle in front, for vehicle speed and for braking in good time. Always adapt your driving style to suit the prevailing road and weather conditions and maintain a safe distance from the vehicle in front. Drive carefully.

The driving safety systems described only work as effectively as possible when there is

adequate contact between the tires and the road surface. Please pay special attention to the notes on tires, recommended minimum tire tread depths, etc. (▷ page 232).

- ❗ In wintry driving conditions, always use winter tires (M+S tires) and if necessary, snow chains. Only in this way will the driving safety systems described in this section work as effectively as possible.

ABS (Anti-lock Braking System)

Important safety notes

- ❗ Observe the "Important safety notes" section (▷ page 54).

ABS regulates brake pressure in such a way that the wheels do not lock when you brake. This allows you to continue steering the vehicle when braking.

WARNING

If ABS is faulty, the wheels could lock when braking. The steerability and braking characteristics may be severely impaired. Additionally, further driving safety systems are deactivated. There is an increased danger of skidding and accidents.

Drive on carefully. Have ABS checked immediately at a qualified specialist workshop.

When ABS is malfunctioning, other systems, including driving safety systems, will also become inoperative. Observe the information on the ABS warning lamp (▷ page 178) and display messages which may be shown in the instrument cluster (▷ page 153).

ABS works from a speed of about 5 mph (8 km/h) upwards, regardless of road-surface conditions. ABS works on slippery surfaces, even if you only brake gently.

The  warning lamp in the instrument cluster lights up when the ignition is switched on. It goes out when the engine is running.

Braking

- ▶ **If ABS intervenes:** continue to depress the brake pedal vigorously until the braking situation is over.
- ▶ **To make a full brake application:** depress the brake pedal with full force.

If ABS intervenes when braking, you will feel a pulsing in the brake pedal.

The pulsating brake pedal can be an indication of hazardous road conditions, and functions as a reminder to take extra care while driving.

BAS (Brake Assist System)

- ❗ Observe the "Important safety notes" section (▷ page 54).

BAS operates in emergency braking situations. If you depress the brake pedal quickly, BAS automatically boosts the braking force, thus shortening the stopping distance.

WARNING

If BAS is malfunctioning, the braking distance in an emergency braking situation is increased. There is a risk of an accident.

In an emergency braking situation, depress the brake pedal with full force. ABS prevents the wheels from locking.

The brakes will function as usual once you release the brake pedal. BAS is deactivated.

ESP® (Electronic Stability Program)

General notes

- ❗ Observe the "Important safety notes" section (▷ page 54).

ESP® monitors driving stability and traction, i.e. power transmission between the tires and the road surface.

If ESP® detects that the vehicle is deviating from the direction desired by the driver, one or more wheels are braked to stabilize the

vehicle. The engine output is also modified to keep the vehicle on the desired course within physical limits. ESP® assists the driver when pulling away on wet or slippery roads. ESP® can also stabilize the vehicle during braking.

ETS (Electronic Traction System)

- ❗ Observe the "Important safety notes" section (▷ page 54).

Traction control is part of ESP®.

Traction control brakes the drive wheels individually if they spin. This enables you to pull away and accelerate on slippery surfaces, for example if the road surface is slippery on one side.

Traction control remains active, even if you deactivate ESP®.

Important safety notes

WARNING

If ESP® is malfunctioning, ESP® is unable to stabilize the vehicle. Additionally, further driving safety systems are deactivated. This increases the risk of skidding and an accident.



Drive on carefully. Have ESP® checked at a qualified specialist workshop.

- ❗ Switch the ignition off when:

- the electric parking brake is being tested using a brake dynamometer.
- the vehicle is being towed with the rear axle raised.

Application of the brakes by ESP® may otherwise destroy the brake system.

When SPORT handling mode is activated, the  warning lamp lights up in the instrument panel.

When ESP® is deactivated, the  and  warning lamps light up in the instrument panel.

Observe the information on warning lamps (▷ page 179) and display messages which

may be shown in the instrument cluster (▷ page 158).

- i** Only use wheels with the recommended tire sizes. Only then will ESP® function properly.

Characteristics of ESP®

ESP® is activated automatically when the engine is started.

If ESP® intervenes, the  ESP® warning lamp flashes in the instrument cluster.

If ESP® intervenes:

- ▶ Do not deactivate ESP® under any circumstances.
- ▶ Only depress the accelerator pedal as far as necessary when pulling away.
- ▶ Adapt your driving style to suit the prevailing road and weather conditions.

Deactivating/activating ESP®

Important safety notes

- i** Observe the "Important safety notes" section (▷ page 54).

You can select between the following states of ESP®:

- ESP® is activated.
- SPORT handling mode is activated.
- ESP® is deactivated.

WARNING

When SPORT handling mode is activated, there is a greater risk of skidding and accidents.

Only activate SPORT handling mode in the situations described in the following.

WARNING

If you deactivate ESP®, ESP® no longer stabilizes the vehicle. There is an increased risk of skidding and an accident.

Only deactivate ESP® in the situations described in the following.

In the following situations, it may be better to activate SPORT handling mode or deactivate ESP®:

- when using snow chains
- in deep snow
- on sand or gravel
- when driving on designated roads when the vehicle's own oversteering and understeering characteristics are desired

Driving in SPORT handling mode or without ESP® requires an extremely qualified and experienced driver.

- i** Activate ESP® as soon as the situations described above no longer apply. ESP® will otherwise not be able to stabilize the vehicle if the vehicle starts to skid or a wheel starts to spin.

! Avoid spinning the driven wheels for an extended period with ESP® deactivated. You could otherwise damage the drivetrain.

Deactivating/activating ESP®

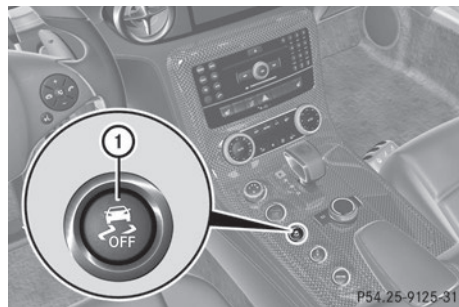



- ▶ **To activate SPORT handling mode:** briefly press button ①.

The  handling mode warning lamp in the instrument cluster lights up. The **SPORT handling mode** message appears in the multifunction display.



- ▶ **To deactivate SPORT handling mode:** briefly press button ①.

The  handling mode warning lamp in the instrument cluster goes out. ESP® is activated.

► **To deactivate ESP®:** press button .

The  ESP® OFF warning lamp in the instrument cluster lights up. The  OFF message appears in the multifunction display.

► **To activate ESP®:** when SPORT handling mode is activated or ESP® is deactivated, press button .

The  ESP® OFF warning lamp in the instrument cluster goes out. The  ON message appears in the multifunction display.

Characteristics of activated SPORT handling mode

SPORT handling mode raises the intervention threshold for stabilizing the vehicle. This allows for a sportier driving style on designated race circuits and may in certain situations improve the traction in comparison with ESP®.

If SPORT handling mode is activated and one or more wheels start to spin, the  warning lamp in the instrument cluster flashes. ESP® only stabilizes the vehicle to a limited degree.

When SPORT handling mode is activated:

- ESP® only improves driving stability to a limited degree.
- traction control is still activated.
- ESP® still provides support when you brake firmly.
- engine torque is only restricted to a limited degree, and the drive wheels are able to spin. The spinning wheels produce a cutting effect for better traction.

Characteristics when ESP® is deactivated

If ESP® is deactivated and one or more wheels start to spin, the  warning lamp in the instrument cluster does not flash. In such situations, ESP® will not stabilize the vehicle.

If you deactivate ESP®:

- ESP® no longer improves driving stability.
- engine torque is no longer limited and the drive wheels are able to spin. The spinning of the wheels results in a cutting action for better traction.
- traction control is still activated.
- ESP® still provides support when you brake firmly.

EBD (electronic brake force distribution)

-  Observe the "Important safety notes" section (▷ page 54).

EBD monitors and controls the brake pressure on the rear wheels to improve driving stability while braking.

WARNING

If EBD has malfunctioned, the rear wheels can still lock, e.g. under full braking. This increases the risk of skidding and an accident.

You should therefore adapt your driving style to the different handling characteristics. Have the brake system checked at a qualified specialist workshop.

Observe information regarding indicator and warning lamps (▷ page 178) as well as display messages (▷ page 154).

ADAPTIVE BRAKE

-  Observe the "Important safety notes" section (▷ page 54).

ADAPTIVE BRAKE enhances braking safety and offers increased braking comfort. In addition to the braking function, ADAPTIVE BRAKE also features the hill start assist function (▷ page 113).

Theft deterrent locking system

Immobilizer

The immobilizer prevents your vehicle from being started without the correct SmartKey.

When leaving the vehicle, always take the SmartKey with you and lock the vehicle. Anyone can start the vehicle if a valid SmartKey has been left inside the vehicle.

- ▶ **To activate:** while the engine is running, turn the Start/Stop button to key position **0** (▷ page 111). The engine stops.

or

- ▶ Remove the SmartKey from the ignition lock.
- ▶ **To deactivate:** turn the Start/Stop button to key position **2** (▷ page 111) without depressing the brake pedal.

i The immobilizer is always deactivated when you start the engine.

In the event that the engine cannot be started when the starter battery is fully charged, the immobilizer may be faulty. Contact an authorized Mercedes-Benz Center or call 1-800-FOR-MERCEdes (in the USA) or 1-800-387-0100 (in Canada).

ATA (anti-theft alarm system)

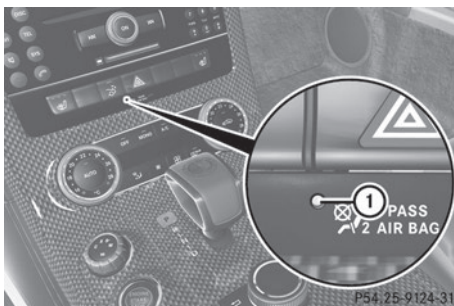

P54_25-9124-31

- ▶ **To arm:** lock the vehicle with the SmartKey. Indicator lamp **1** flashes. The alarm system is armed after approximately 15 seconds.

- ▶ **To disarm:** unlock the vehicle with the SmartKey.



A visual and audible alarm is triggered if the alarm system is armed and you open:

- a door
- the trunk lid
- the hood
- the vehicle with the mechanical key

The alarm is not switched off, even if you close the open door that triggered it, for example.

- ▶ **To stop the alarm:** press the Start/Stop button in the center console. The SmartKey must be inside the vehicle.

or

- ▶ Press the  or  button on the SmartKey.

or

- ▶ Insert the SmartKey into the ignition lock. The alarm is switched off.

i If the alarm stays on for more than 30 seconds, the mbrace emergency call system (USA only) or Tele Aid system (Canada only) initiates a call to the Customer Assistance Center automatically. The mbrace emergency call system initiates the call if:

- you have subscribed to the Tele Aid service.
- the Tele Aid service has been activated properly.
- the required mobile phone, power supply and GPS are available.

Tow-away alarm

Function

An audible and visual alarm is triggered if your vehicle's angle of inclination is altered while the tow-away alarm is armed. This can occur if the vehicle is jacked up on one side, for example.

Arming

- ▶ Make sure that:
 - the doors are closed.
 - the trunk lid is closed.
 Only then is the tow-away alarm armed.
- ▶ Lock the vehicle with the SmartKey.
 - The tow-away alarm is armed after approximately 30 seconds.

Deactivating

- ▶ Unlock the vehicle with the SmartKey.
 - The tow-away alarm is deactivated automatically.

Disarming

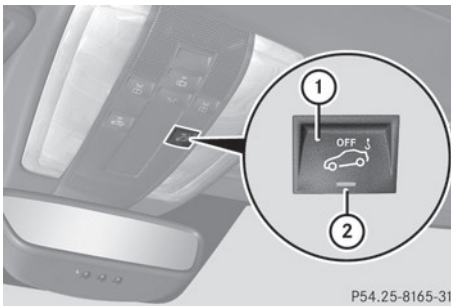

- ▶ Select key position **0** with the Start/Stop button.
- or
- ▶ Remove the SmartKey from the ignition lock.
- ▶ Press button ①.
 - Indicator lamp ② lights up briefly.
- ▶ Lock the vehicle with the SmartKey.
 - The tow-away alarm is disarmed.

The tow-away alarm remains deactivated until the vehicle is unlocked and locked again.

To prevent a false alarm, disarm the tow-away alarm manually if your vehicle:

- is being transported
- is being loaded onto a ferry or car transporter, for example
- is parked on a movable surface, e.g. in a split-level garage

Useful information	62
SmartKey	62
Doors	68
Trunk	70
Side windows	73

Useful information

- i** This Operator's Manual describes all models and all standard and optional equipment of your vehicle available at the time of publication of the Operator's Manual. Country-specific differences are possible. Please note that your vehicle may not be equipped with all features described. This also applies to safety-related systems and functions.
- i** Please read the information on qualified specialist workshops (▷ page 21).

SmartKey

Key function

General notes

- i** USA only:
This device complies with Part 15 of the FCC Rules. Operation is subject to the following two conditions:
 1. This device may not cause harmful interference, and
 2. this device must accept any interference received, including interference that may cause undesired operation of the device.
 Any unauthorized modification to this device could void the user's authority to operate the equipment.
The Product label with FCC ID and IC certification number can be found in the battery case of the SmartKey.
- i** Canada only:
This device complies with RSS-210 of Industry Canada. Operation is subject to the following two conditions:
 1. This device may not cause harmful interference, and
 2. this device must accept any interference received, including interference that may cause undesired operation of the device.

Any unauthorized modification to this device could void the user's authority to operate the equipment.

The Product label with FCC ID and IC certification number can be found in the battery case of the SmartKey.

Locking/unlocking centrally

The SmartKey centrally locks/unlocks:

- the doors
- the trunk lid
- the fuel filler flap

WARNING

If children are left unsupervised in the vehicle, they could:

- open the doors, thus endangering other people or road users.
- get out and disrupt traffic.
- operate the vehicle's equipment.

Additionally, children could set the vehicle in motion if, for example, they:

- release the parking brake.
- shifting the automatic transmission out of park position **P**
- Start the engine.

There is a risk of an accident and injury.

When leaving the vehicle, always take the SmartKey with you and lock the vehicle. Never leave children or animals unattended in the vehicle. Always keep the SmartKey out of reach of children.

WARNING

When leaving the vehicle, always remove the SmartKey from the ignition lock. Always take the SmartKey with you and lock the vehicle. Do not leave children unsupervised in the vehicle, even if they are secured in a child restraint system, and do not give them access to an unlocked vehicle. A child's unsupervised access to a vehicle could result in an accident and/or serious personal injury. They could:

- injure themselves on vehicle parts
- be seriously or fatally injured by extreme heat or cold
- injure themselves or have an accident with vehicle equipment that may still be in operation even after the SmartKey has been removed from the ignition, such as the seat adjustment, steering wheel adjustment or memory function.

If children open a door, they could cause severe or even fatal injury to other persons; if they get out of the vehicle, they could injure themselves when doing so or be seriously or even fatally injured by any passing traffic.

Do not expose the child restraint system to direct sunlight. The child restraint system's metal parts, for example, could become very hot, and a child could be burned on these parts.



WARNING

If you attach heavy or large objects to the SmartKey, the SmartKey could be unintentionally turned in the ignition lock. This could cause the engine to be switched off. There is a risk of an accident.

Do not attach any heavy or large objects to the SmartKey. Remove any bulky key rings before inserting the SmartKey into the ignition lock.

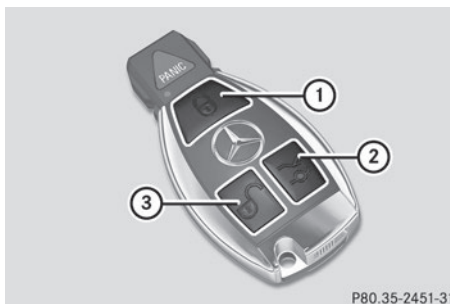
- ❗ **Keep the SmartKey away from strong magnetic fields.** Otherwise, the remote control function could be affected. Strong magnetic fields can occur in the vicinity of powerful electrical installations.



- ①  To lock the vehicle
- ②  To unlock the trunk lid
- ③  To unlock the vehicle

The turn signals flash once when unlocking and three times when locking.

When it is dark, the surround lighting also comes on if it is activated in the on-board computer (▷ page 147).

- ▶ **To unlock centrally:** press the  button.



If you do not open the vehicle within approximately 40 seconds of unlocking:

- the vehicle is locked again.
- the anti-theft alarm system is armed again.



- ▶ **To lock centrally:** press the  button.

Changing the settings of the locking system



You can change the setting of the locking system in such a way that only the driver's door and the fuel filler flap are unlocked. This is useful if you frequently travel on your own.

- ▶ **To change the setting:** press and hold down the  and  buttons simultaneously for approximately six seconds until the battery check lamp (▷ page 65) flashes twice .

The SmartKey now functions as follows:

- ▶ **To unlock the driver's door:** press the  button once.
- ▶ **To unlock centrally:** press the  button twice.
- ▶ **To lock centrally:** press the  button.

Restoring the factory settings

- ▶ Press the  and  buttons simultaneously for approximately six seconds until the battery check lamp flashes twice.



Mechanical key

General notes

If the vehicle can no longer be locked or unlocked with the SmartKey, use the mechanical key.

If you use the mechanical key to unlock and open the driver's door, the anti-theft alarm system will be triggered (▷ page 58).

There are several ways to turn off the alarm:

- ▶ Press the  or  button on the SmartKey.
- or
- ▶ Insert the SmartKey into the ignition lock.
 - ▶ **To unlock the fuel filler flap:** insert the SmartKey into the ignition lock.
 - ▶ **To unlock the charge socket flap:** insert the SmartKey into the ignition lock.

Removing the mechanical key

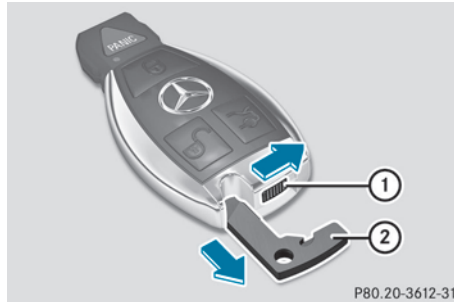

P80.20-3612-31

- ▶ Push release catch ① in the direction of the arrow and at the same time remove mechanical key ② from the SmartKey.

SmartKey battery

Important safety notes

WARNING

Batteries contain toxic and corrosive substances. If batteries are swallowed, it can result in severe health problems. There is a risk of fatal injury.

Keep batteries out of the reach of children. If a battery is swallowed, seek medical attention immediately.

Environmental note



Batteries contain dangerous substances. It is against the law to dispose of them with the household rubbish. They must be collected separately and recycled to protect the environment.



Dispose of batteries in an environmentally friendly manner. Take discharged batteries to a qualified specialist workshop or a special collection point for used batteries.



The SmartKey batteries contain perchlorate material, which may require special handling and regard for the environment. National guidelines must be observed during disposal. In California, see www.dtsc.ca.gov/HazardousWaste/Perchlorate/index.cfm.

Mercedes-Benz recommends that you have the batteries replaced at a qualified specialist workshop.

Checking the battery





P80.35-2449-31

- ▶ Press the  or  button. The SmartKey battery is working properly if battery check lamp ① lights up briefly.

If battery check lamp ① does not light up briefly during the test, the SmartKey battery is discharged.

- ▶ Change the battery (▶ page 65).

- i** If the SmartKey battery is checked within the signal reception range of the vehicle, pressing the  or  button:
 - locks or
 - unlocks the vehicle
- i** You can get a battery at any qualified specialist workshop.

Replacing the battery

- ▶ Take the mechanical key out of the SmartKey (▶ page 64).

You require a CR 2025 3 V cell battery.

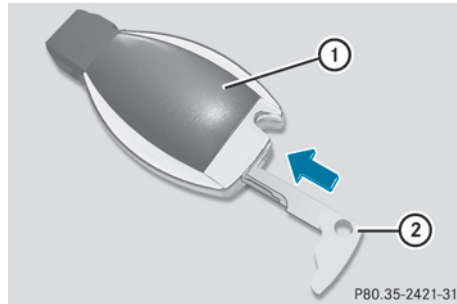

P80.35-2421-31

- ▶ Press mechanical key ② into the opening in the SmartKey in the direction of the arrow until battery tray cover ① opens. Do not hold the cover closed while doing so.

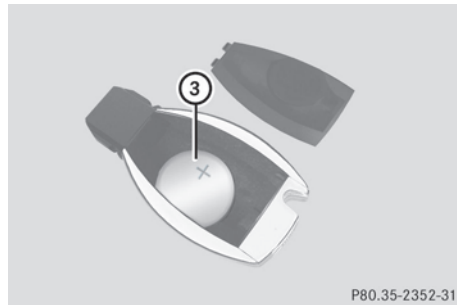

P80.35-2352-31

- ▶ Remove the cover of the battery tray.
- ▶ Repeatedly tap the SmartKey against your palm until battery ③ falls out.
- ▶ Insert the new battery with the positive terminal facing upwards. Use a lint-free cloth to do so.
- ▶ Insert the front tabs of the battery tray's cover first, and then press to close it.
- ▶ Check the function of all SmartKey buttons on the vehicle.

Problems with the SmartKey

Problem	Possible causes/consequences and ► Solutions
You cannot lock or unlock the vehicle using the SmartKey.	<p>The SmartKey battery is discharged or nearly discharged.</p> <ul style="list-style-type: none"> ► Point the tip of the SmartKey at the driver's door handle from close range. Try to unlock or lock the vehicle again. <p>If this does not work:</p> <ul style="list-style-type: none"> ► Unlock the vehicle using the mechanical key (▷ page 64). ► Check the SmartKey battery and replace it if necessary (▷ page 65).
	<p>The SmartKey is faulty.</p> <ul style="list-style-type: none"> ► Lock or unlock the vehicle using the mechanical key (▷ page 64). ► Have the SmartKey checked at a qualified specialist workshop.
You have lost a SmartKey.	<ul style="list-style-type: none"> ► Have the SmartKey canceled at an authorized Mercedes-Benz Center. ► Report the loss immediately to the vehicle insurers. ► If necessary, have the locks changed as well.
You have lost the mechanical key.	<ul style="list-style-type: none"> ► Report the loss immediately to the vehicle insurers. ► If necessary, have the locks changed as well.
The engine cannot be started using KEYLESS-GO. The SmartKey is in the vehicle.	<p>A door is open. Therefore, the SmartKey cannot be detected as easily.</p> <ul style="list-style-type: none"> ► Close the door and try to start the vehicle again.
	<p>There is interference from a powerful source of radio waves.</p> <ul style="list-style-type: none"> ► Start your vehicle with the SmartKey in the ignition lock.

Problem	Possible causes/consequences and ► Solutions
<p>The engine cannot be started using the SmartKey.</p>	<p>The on-board voltage is too low.</p> <ul style="list-style-type: none"> ► Switch off non-essential consumers, e.g. seat heating or interior lighting, and try to start the engine again. ► Remove the SmartKey and reinsert it into the ignition lock. ► Start the engine within 30 seconds of inserting the SmartKey into the ignition lock. ► Repeat if necessary. <p>If this does not work:</p> <ul style="list-style-type: none"> ► Check the starter battery and charge it if necessary (▷ page 220). <p>or</p> <ul style="list-style-type: none"> ► Jump-start the vehicle (▷ page 224). <p>or</p> <ul style="list-style-type: none"> ► Consult a qualified specialist workshop.
<p>The SmartKey cannot be turned in the ignition lock.</p>	<p>The SmartKey has been in position 0 for a considerable time.</p> <ul style="list-style-type: none"> ► Remove the SmartKey and reinsert it into the ignition lock. ► Check the starter battery and charge it if necessary (▷ page 220). ► Start the engine. <p>The on-board voltage is too low.</p> <ul style="list-style-type: none"> ► Switch off non-essential consumers, e.g. seat heating or interior lighting, and try to turn the SmartKey again. <p>If this does not work:</p> <ul style="list-style-type: none"> ► Check the starter battery and charge it if necessary (▷ page 220). <p>or</p> <ul style="list-style-type: none"> ► Jump-start the vehicle (▷ page 224). <p>or</p> <ul style="list-style-type: none"> ► Consult a qualified specialist workshop.

Doors

Important safety notes

WARNING

If children are left unsupervised in the vehicle, they could:

- open the doors, thus endangering other people or road users.
- get out and disrupt traffic.
- operate the vehicle's equipment.

Additionally, children could set the vehicle in motion if, for example, they:

- release the parking brake.
- shifting the automatic transmission out of park position **P**
- Start the engine.

There is a risk of an accident and injury.

When leaving the vehicle, always take the SmartKey with you and lock the vehicle. Never leave children or animals unattended in the vehicle. Always keep the SmartKey out of reach of children.

WARNING

When leaving the vehicle, always remove the SmartKey from the ignition lock. Always take the SmartKey with you and lock the vehicle. Do not leave children unsupervised in the vehicle, even if they are secured in a child restraint system, and do not give them access to an unlocked vehicle. A child's unsupervised access to a vehicle could result in an accident and/or serious personal injury. They could:

- injure themselves on vehicle parts
- be seriously or fatally injured by extreme heat or cold
- injure themselves or have an accident with vehicle equipment that may still be in operation even after the SmartKey has been removed from the ignition, such as the seat adjustment, steering wheel adjustment or memory function.

If children open a door, they could cause severe or even fatal injury to other persons; if

they get out of the vehicle, they could injure themselves when doing so or be seriously or even fatally injured by any passing traffic.

Do not expose the child restraint system to direct sunlight. The child restraint system's metal parts, for example, could become very hot, and a child could be burned on these parts.

WARNING

If objects, luggage or loads are not secured or not secured sufficiently, they could slip, tip over or be flung around and thereby hit vehicle occupants. There is a risk of injury, particularly in the event of sudden braking or a sudden change in direction.

Always store objects so that they cannot be flung around. Secure objects, luggage or loads against slipping or tipping before the journey.

Unlocking and opening the doors from the outside

- ❗ The doors swing upwards and out when opened. Therefore, make sure that there is sufficient clearance above the vehicle.

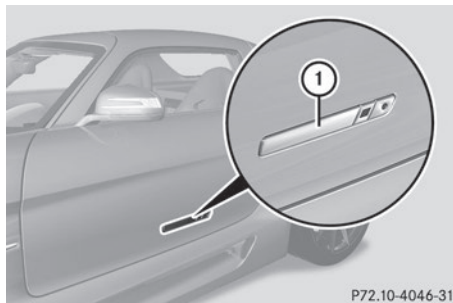

P72.10-4046-31

- ▶ **To open the door:** point the SmartKey towards door handle ①.
- ▶ Press the  button on the SmartKey. Door handle ① moves out.
- ▶ Lift the door by door handle ① and swing it up as far as it will go.

- ▶ **To close the door:** pull the door downwards by the outer edge or the interior door handle. Swing the door down gently and allow it to engage in the lower position.
- ▶ Lock the vehicle with the SmartKey if necessary (▷ page 62).

Unlocking and opening doors from the inside

You can only open a door from the inside if it is unlocked.

The vehicle locks the doors automatically if you drive faster than 9 mph (15 km/h).

The doors are automatically unlocked after a journey if you switch off the engine.

! The doors swing upwards and out when opened. Therefore, make sure that there is sufficient clearance above the vehicle.

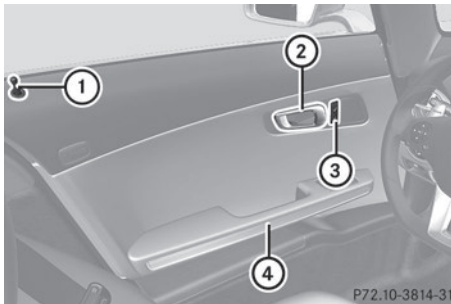

- ▶ **To unlock the door manually:** press the  button of central locking (3).
- or
- ▶ Pull locking knob (1) upwards.
- ▶ **To open the door:** pull handle (2).
- ▶ Swing the door upwards as far as it will go.
- ▶ **To close the door:** pull the door down by handle (4).
- ▶ Allow the door to engage in the lower position.

- ▶ **To lock the door manually:** press the  button of central locking (3).
- or
- ▶ Push locking knob (1) downwards.

Centrally locking and unlocking the vehicle from the inside

You can centrally lock or unlock the vehicle from the inside. This feature may be useful if, for example, you wish to unlock the front-passenger door from the inside or lock the vehicle before you pull away.

The central locking/unlocking button does not lock or unlock the fuel filler flap.

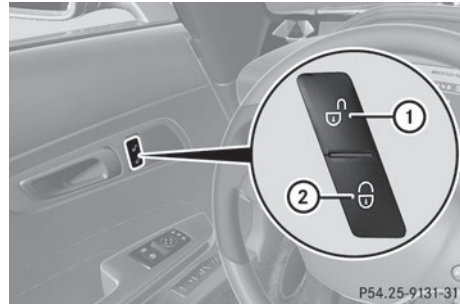

- ▶ **To lock:** press button (2).
If both doors are closed, the vehicle locks.
- ▶ **To unlock:** press button (1).

Automatic locking feature

You can only open a door from the inside if it is unlocked.

The vehicle locks the doors automatically if you drive faster than 9 mph (15 km/h).

The doors are automatically unlocked after a journey if you switch off the engine.

Unlocking the driver's door (mechanical key)

If the vehicle can no longer be unlocked with the SmartKey, use the mechanical key.

If you use the mechanical key to unlock and open the driver's door, the anti-theft alarm system will be triggered (▷ page 58).

- ▶ Take the mechanical key out of the SmartKey (▷ page 64).
- ▶ Insert the mechanical key into the lock of the driver's door as far as it will go.

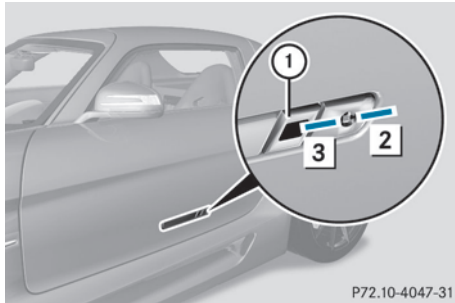

- ▶ **To unlock:** insert the mechanical key into the lock of the driver's door as far as it will go.
- ▶ Turn the mechanical key clockwise to position **2**.
The door is unlocked.
- ▶ Turn the mechanical key back and remove it.
- ▶ **To open the door:** press button ①.
The handle moves out slightly from the door.
- ▶ Pull the handle out as far as it will go.
- ▶ Swing the door upwards by the handle.

Locking the vehicle (mechanical key)

If the vehicle can no longer be locked with the SmartKey, use the mechanical key.

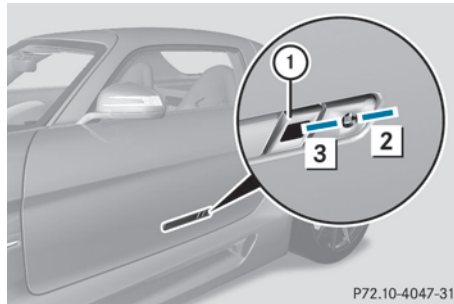

- ① Button for extending the handle
- ▶ **To lock:** lock the front-passenger door manually from the inside (▷ page 69).
- ▶ Leave the vehicle and close the driver's door.
- ▶ Insert the mechanical key into the lock of the driver's door as far as it will go.
- ▶ Turn the mechanical key counter-clockwise to position **3**.
The door is locked.
- ▶ Turn the mechanical key back and remove it.
- ▶ Check that both doors are locked.
- ⓘ If you lock the vehicle as described above, the fuel filler flap is not locked. The anti-theft alarm system is not armed.

Trunk

Important safety notes

⚠ WARNING

Combustion engines emit poisonous exhaust gases such as carbon monoxide. Exhaust gases can enter the vehicle interior if the trunk lid is open when the engine is running, especially if the vehicle is in motion. There is a risk of poisoning.

Always switch off the engine before opening the trunk lid. Never drive with the trunk lid open.

WARNING

When leaving the vehicle, always remove the SmartKey from the ignition lock. Always take the SmartKey with you and lock the vehicle. Do not leave children unsupervised in the vehicle, even if they are secured in a child restraint system, and do not give them access to an unlocked vehicle. A child's unsupervised access to a vehicle could result in an accident and/or serious personal injury. They could:

- injure themselves on vehicle parts
- be seriously or fatally injured by extreme heat or cold
- injure themselves or have an accident with vehicle equipment that may still be in operation even after the SmartKey has been removed from the ignition, such as the seat adjustment, steering wheel adjustment or memory function.

If children open a door, they could cause severe or even fatal injury to other persons; if they get out of the vehicle, they could injure themselves when doing so or be seriously or even fatally injured by any passing traffic.

Do not expose the child restraint system to direct sunlight. The child restraint system's metal parts, for example, could become very hot, and a child could be burned on these parts.

WARNING

Do not carry heavy or hard objects in the passenger compartment or trunk unless they are firmly secured in place.

Unsecured or improperly positioned cargo increases a child's risk of injury in the event of

- strong braking maneuvers
- sudden changes of direction
- an accident

- ❗ The temperature in the trunk may be high. For this reason, do not store any temperature-sensitive objects in the trunk.

- ❗ The trunk lid swings upwards when opened. Therefore, make sure that there is sufficient clearance above the trunk lid.

To fully open the trunk lid, a minimum height of 5.5 ft (1.68 m) from the ground is necessary.

The trunk lid can be:

- opened automatically from outside
- opened automatically from inside
- locked separately
- unlocked with the mechanical key
- opened with the emergency release button

Opening/closing the trunk

Opening/closing from outside

Opening

- ▶ Press the  button on the SmartKey. The trunk lid opens slightly.



- ▶ Reach into the gap and pull up the trunk lid.

Closing

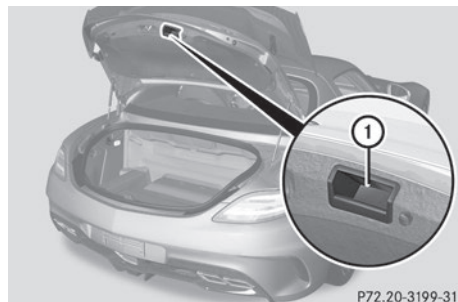

- ▶ Push the trunk lid down until it engages. Use handle ① to pull down the trunk lid if necessary.
- ▶ If necessary, lock the vehicle with the  button on the SmartKey.

Opening the trunk from inside the vehicle

You can open the tailgate from the driver's seat when the vehicle is stationary.



- ▶ Press trunk lid remote control button ①. The trunk lid opens slightly.

Locking the trunk separately

You can lock the trunk separately. If you then unlock the vehicle centrally, the trunk remains locked and cannot be opened.

- ▶ Close the trunk lid.
- ▶ Take the mechanical key out of the SmartKey (> page 64).

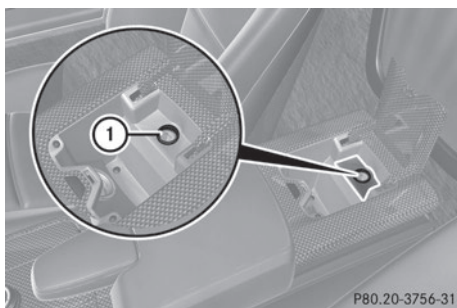

- ▶ Insert the mechanical key fully into trunk lid lock ① in the rear compartment of the center console.
- ▶ Turn the mechanical key clockwise as far as possible.
- ▶ Remove the mechanical key.
- ▶ Check that the trunk remains locked when you press on the trunk lid remote control button.

Unlocking the trunk (mechanical key)

If the trunk can no longer be unlocked with the SmartKey:

- ▶ Take the mechanical key out of the SmartKey (> page 64).

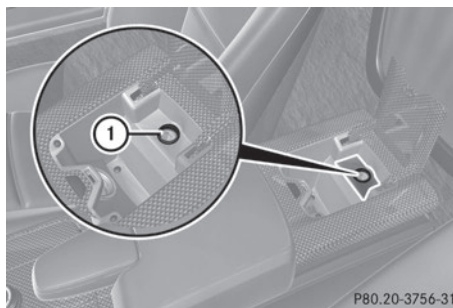

- ▶ Insert the mechanical key fully into trunk lid lock ① in the center console in the vehicle interior.
- ▶ Turn the mechanical key counter-clockwise as far as possible. The trunk lid opens slightly.

Trunk emergency release

You can open the trunk lid from inside the vehicle with the emergency release button.

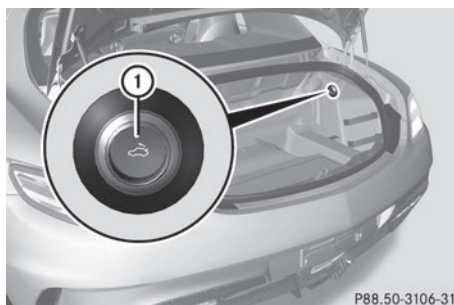

P88.50-3106-31

- ▶ Press emergency release button ① briefly. The trunk lid unlocks and opens slightly.
- ▶ Push the trunk lid upwards to open it completely.

The trunk lid can be unlocked with the trunk lid emergency release when the vehicle is stationary or while driving.

Trunk lid emergency release light:

- emergency release button ① flashes for 30 minutes after opening the trunk lid.
- emergency release button ① flashes for 60 minutes after closing the trunk lid.

The trunk lid emergency release does not unlock the trunk lid if the battery is disconnected or discharged.

If the vehicle was locked centrally, opening the trunk lid with the trunk lid emergency release triggers the anti-theft alarm system.

Side windows

Important safety notes

WARNING

While opening the side windows, body parts could become trapped between the side window and the door frame as the side window moves. There is a risk of injury.

Make sure that nobody touches the side window during the opening procedure. If somebody becomes trapped, release the switch or pull the switch to close the side window again.

WARNING

While opening the side windows, body parts in the closing area could become trapped. There is a risk of injury.

Make sure that no body parts are in close proximity during the closing procedure. If somebody becomes trapped, release the switch or press the switch to open the side window again.

WARNING

If children operate the side windows they could become trapped, particularly if they are left unsupervised. There is a risk of injury.

When leaving the vehicle, always take the SmartKey with you and lock the vehicle. Never leave children unsupervised in the vehicle.

The side windows are equipped with an automatic reversing feature. If an object blocks or restricts a side window during the closing process, the side window opens again automatically.

WARNING

The reversing feature does not react:

- to soft, light and thin objects, e.g. small fingers
- over the last 4 mm of the closing movement
- during resetting
- when closing the side window again manually immediately after automatic reversing

This means that the reversing feature cannot prevent someone being trapped in these situations. There is a risk of injury.

Make sure that no body parts are in close proximity during the closing procedure. If someone becomes trapped, press the switch to open the side window again.

Observe the important safety notes in the "Children in the vehicle" section (▷ page 51).

Opening and closing the side windows



- ① Left side window
- ② Right side window

The switches for both side windows are located on the driver's door. There is also a switch for the front-passenger side window on the front-passenger door.

The switches on the driver's door take precedence.

- ▶ Select key position **2** with the Start/Stop button (▶ page 111).
- ▶ **To open:** press corresponding switch ① or ②.
- ▶ **To close:** pull corresponding switch ① or ②.

i If you press the switch beyond the point of resistance, an automatic opening/closing process is started in the corresponding direction. You can stop automatic operation by operating the switch again.

i You can continue to operate the side windows after you switch off the engine. This function is available for up to five minutes or until the driver's or front-passenger door is opened.

Convenience opening

WARNING

While opening the side windows, body parts could become trapped between the side

window and the door frame as the side window moves. There is a risk of injury.

Make sure that nobody touches the side window during the opening procedure. If somebody becomes trapped, release the switch or pull the switch to close the side window again.

You can ventilate the vehicle before you start driving. To do so, open the side windows using the SmartKey.

- i** The SmartKey must be close to the driver's door handle.
- ▶ Point the tip of the SmartKey at the driver's door handle.
- ▶ Unlock the vehicle by pressing the button.
- ▶ Press and hold the button until the side windows are in the desired position.
- ▶ **To interrupt convenience opening:** release the button.

Convenience closing feature

WARNING

While opening the side windows, body parts in the closing area could become trapped. There is a risk of injury.

Make sure that no body parts are in close proximity during the closing procedure. If somebody becomes trapped, release the switch or press the switch to open the side window again.

When you lock the vehicle, you can simultaneously close both side windows from outside.

- i** The SmartKey must be close to the driver's door handle.
- ▶ Point the tip of the SmartKey at the driver's door handle.
- ▶ Lock the vehicle with the button.

- ▶ Press and hold the  button until the side windows are fully closed.
- ▶ Make sure that all the side windows are closed.

Problems with the side windows

WARNING

If you close a side window again immediately after it has been blocked or reset, the side window closes with increased or maximum force. The reversing feature is then not active. Parts of the body could be trapped in the closing area in the process. This poses an increased risk of injury or even fatal injury.

Make sure that no parts of the body are in the closing area. To stop the closing process, release the switch or push the switch again to reopen the side window.

Problem	Possible causes/consequences and ► Solutions
A side window will not close.	<p>Objects prevent it from closing.</p> <ul style="list-style-type: none"> ► Remove the objects. ► Close the side window.
A side window will not close.	<p>You cannot see the cause.</p> <p>If a side window is obstructed during closing and reopens again slightly:</p> <ul style="list-style-type: none"> ► Immediately after the window blocks, pull the corresponding switch again until the side window has closed. The side window is closed with increased force. <p>If a side window is obstructed again during closing and reopens again slightly:</p> <ul style="list-style-type: none"> ► Immediately after the window blocks, pull the corresponding switch again until the side window has closed. The side window is closed without the anti-entrapment feature.

Useful information	78
Correct driver's seat position	78
Seats	79
Steering wheel	82
Mirrors	84
Memory function	86

Useful information

- i** This Operator's Manual describes all models and all standard and optional equipment of your vehicle available at the time of publication of the Operator's Manual. Country-specific differences are possible. Please note that your vehicle may not be equipped with all features described. This also applies to safety-related systems and functions.
- i** Please read the information on qualified specialist workshops (▷ page 21).

Correct driver's seat position



Observe the safety guidelines on seat adjustment (▷ page 79).

- ▶ Make sure that seat ③ is adjusted properly.
 - Manual seat adjustment (▷ page 80)
 - Electrical seat adjustment (▷ page 80)
 - Manual seat adjustment (▷ page 80)
 - Electrical seat adjustment (▷ page 80)

When adjusting the seat, make sure that:

- you are as far away from the driver's air bag as possible.
- you are sitting in a normal upright position.
- you can fasten the seat belt properly.
- you have moved the backrest to an almost vertical position.
- you have set the seat cushion angle so that your thighs are gently supported.
- you can depress the pedals properly.

Observe the safety guidelines on steering wheel adjustment (▷ page 82).

- ▶ Make sure that steering wheel ① is adjusted properly.

Adjusting the steering wheel manually (▷ page 82)

Adjusting the steering wheel electrically (▷ page 82)

When adjusting the steering wheel, make sure that:

- you can hold the steering wheel with your arms slightly bent.
- you can move your legs freely.
- you can see all the displays in the instrument cluster clearly.

Observe the safety guidelines for seat belts (▷ page 47).

- ▶ Check whether you have fastened seat belt ② properly (▷ page 49).

The seat belt should:

- fit snugly across your body
 - be routed across the middle of your shoulder
 - be routed in your pelvic area across the hip joints
- ▶ Before starting off, adjust the rear-view mirror and the exterior mirrors

(▷ page 84) in such a way that you have a good view of road and traffic conditions.

- ▶ **Vehicles with a memory function:** save the seat, steering wheel and exterior mirror settings (▷ page 86).

Seats

Important safety notes

WARNING

Children could become trapped if they adjust the seats, particularly when unattended. There is a risk of injury.

When leaving the vehicle, always take the SmartKey with you and lock the vehicle. Never leave children unsupervised in the vehicle.

WARNING

You could lose control of your vehicle if you do the following while driving:

- adjust the driver's seat, head restraint, steering wheel or mirrors
- fasten the seat belt

There is a risk of an accident.

Adjust the driver's seat, head restraint, steering wheel and mirror and fasten your seat belt before starting the engine.

WARNING

If you adjust the seat height carelessly, you or other vehicle occupants could be trapped and thereby injured. Children in particular could accidentally press the electrical seat adjustment buttons and become trapped. There is a risk of injury.

While moving the seats, make sure that your hands or other body parts do not get under the lever assembly of the seat adjustment system.

WARNING

When you adjust a seat, you or other vehicle occupants could become trapped, e.g. on the seat guide rail. There is a risk of injury.

Make sure when adjusting a seat that no one has any body parts in the sweep of the seat.

WARNING

The seat belt does not offer the intended level of protection if you have not moved the backrest to an almost vertical position. When braking or in the event of an accident, you could slide underneath the seat belt and sustain abdomen or neck injuries, for example. This poses an increased risk of injury or even fatal injury.

Adjust the seat properly before beginning your journey. Always ensure that the backrest is in an almost vertical position and that the shoulder section of your seat belt is routed across the center of your shoulder.

WARNING

If head restraints are not installed and adjusted correctly, they cannot provide protection as intended. There is an increased risk of injury in the head and neck area, e.g. in the event of an accident or when braking.

Always drive with the head restraints installed. Before driving off, make sure for every vehicle occupant that the center of the head restraint supports the back of the head at about eye level.

WARNING

The seat belt does not offer the intended level of protection if you have not moved the backrest to an almost vertical position. When braking or in the event of an accident, you could slide underneath the seat belt and sustain abdomen or neck injuries, for example. This poses an increased risk of injury or even fatal injury.

Adjust the seat properly before beginning your journey. Always ensure that the backrest is in an almost vertical position and that the shoulder section of your seat belt is routed across the center of your shoulder.

! To avoid damage to the seats and the seat heating, observe the following information:

- do not spill any liquids on the seats. If liquid is spilled on the seats, dry them as soon as possible.
- if the seat covers are damp or wet, do not switch on the seat heating. The seat heating should also not be used to dry the seats.
- clean the seat covers as recommended; see the "Interior care" section.
- do not transport heavy loads on the seats. Do not place sharp objects on the seat cushions, e.g. knives, nails or tools. The seats should only be occupied by passengers, if possible.
- when the seat heating is in operation, do not cover the seats with insulating materials, e.g. blankets, coats, bags, seat covers, child seats or booster seats.

! Make sure that there are no objects in the footwell or behind the seats when resetting the seats. There is a risk that the seats and/or the objects could be damaged.

Adjusting the seats manually

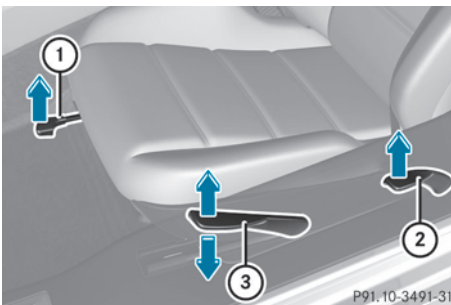

Seat fore-and-aft adjustment

- ▶ Lift handle ① and slide the seat forwards or backwards.
- ▶ Release lever ① again. Make sure that you hear the seat engage in position.

Backrest angle

- ▶ Relieve the pressure on the backrest.
- ▶ Pull lever ② up and adjust the backrest to the desired angle.
- ▶ Release lever ② again. The seat backrest must audibly engage.

Seat height

- ▶ Pull up or push down lever ③ repeatedly until the seat has reached the desired height.

Seat adjustment

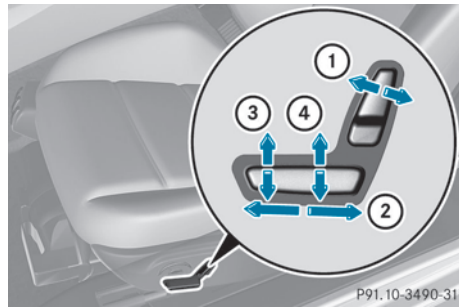

- ① Backrest angle
- ② Seat fore-and-aft adjustment
- ③ Seat cushion angle
- ④ Seat height

i You can store the seat settings using the memory function (▷ page 86).

Adjusting the lumbar support

You can adjust the contour of the seat so as to provide optimum support for your back.

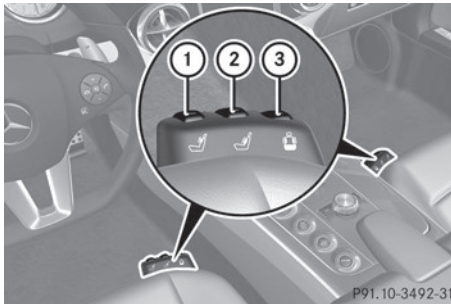

P91.10-3492-31

- ① To adjust the upper back support
 - ② To adjust the contour of the backrest in the lumbar region
 - ③ To adjust the lateral structure and support of the seat
- ▶ Select key position **2** with the Start/Stop button.
- i** If, after a certain amount of time, the seat no longer has the desired contour, repeat the adjustment.

Switching the seat heating on/off

Activating/deactivating

WARNING

Repeatedly switching on the seat heating can cause the seat cushion and backrest pads to become very hot. The health of persons with limited temperature sensitivity or a limited ability to react to excessively high temperatures may be affected or they may even suffer burn-like injuries. There is a risk of injury.

Therefore, do not switch the seat heating on repeatedly.

The three red indicator lamps in the button indicate the heating level you have selected.

- i** If the battery voltage is too low, the seat heating may switch off.



P91.30-2535-31

The system automatically switches down from level **3** to level **2** after approximately five minutes.

The system automatically switches down from level **2** to level **1** after approximately ten minutes.

The system automatically switches off approximately 20 minutes after it is set to level **1**.

- ▶ Select key position **2** with the Start/Stop button.
- ▶ **To switch on:** press button ① repeatedly until the desired heating level is set.
- ▶ **To switch off:** press button ① repeatedly until all the indicator lamps go out.

Problems with the seat heating

The seat heating has switched off prematurely or cannot be switched on. The vehicle's electrical system voltage is too low because too many electrical consumers are switched on.

- ▶ Switch off electrical consumers that you do not need, such as the rear window defroster or interior lighting. Once the battery is sufficiently charged, the seat heating will switch back on automatically.

Steering wheel

Important safety notes

WARNING

You could lose control of your vehicle if you do the following while driving:

- adjust the driver's seat, head restraint, steering wheel or mirrors
- fasten the seat belt

There is a risk of an accident.

Adjust the driver's seat, head restraint, steering wheel and mirror and fasten your seat belt before starting the engine.

WARNING

Children could injure themselves if they adjust the steering wheel. There is a risk of injury.

When leaving the vehicle, always take the SmartKey with you and lock the vehicle. Never leave children unsupervised in the vehicle.

WARNING

If the steering wheel is unlocked while the vehicle is in motion, it could change position unexpectedly. This could cause you to lose control of the vehicle. There is a risk of an accident.

Before starting off, make sure the steering wheel is locked. Never unlock the steering wheel while the vehicle is in motion.

Adjusting the steering wheel

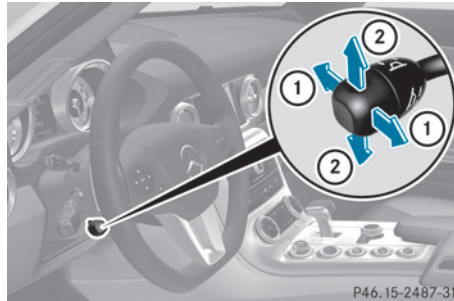

- ① To adjust the steering wheel position (fore-and-aft adjustment)
- ② To adjust the steering wheel height

Further related subjects:

- EASY-ENTRY/EXIT feature (> page 83)
- Storing settings (> page 86)

Adjusting the steering wheel manually

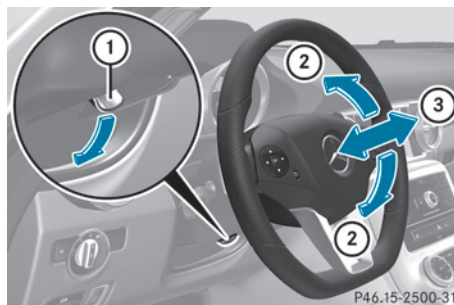

- ▶ Push release lever ① down completely. The steering column is unlocked.
- ▶ Adjust the steering wheel to the desired position.
- ▶ Push release lever ① up completely. The steering column is locked.
- ▶ Check if the steering column is locked. When doing so, try to push the steering wheel up or down or try to move it in the fore-and-aft direction.

Adjusting the steering wheel electrically

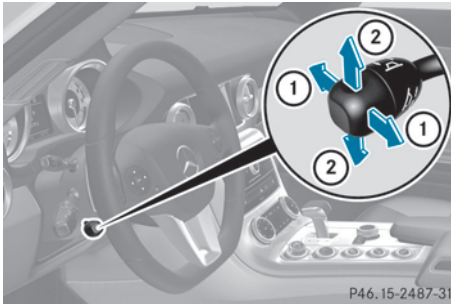

- ① To adjust the steering wheel position (fore-and-aft adjustment)
- ② To adjust the steering wheel height

i Further related subjects:

- EASY-ENTRY/EXIT feature (▷ page 83)
- Storing settings (▷ page 86)

EASY-ENTRY/EXIT feature

Important safety notes

The EASY-ENTRY/EXIT feature makes getting in and out of your vehicle easier.

⚠ WARNING

When the EASY-ENTRY/EXIT feature adjusts the steering wheel, you and other vehicle occupants – particularly children – could become trapped. There is a risk of injury.

While the EASY-ENTRY/EXIT feature is making adjustments, make sure that no one has any body parts in the sweep of the steering wheel.

If somebody becomes trapped:

- press one of the memory function position buttons, or
- move the switch for steering wheel adjustment in the opposite direction to that in which the steering wheel is moving.

The adjustment process is stopped.

⚠ WARNING

If children activate the EASY-ENTRY/EXIT feature, they can become trapped, particularly when unattended. There is a risk of injury.

When leaving the vehicle, always take the SmartKey with you and lock the vehicle. Never leave children unsupervised in the vehicle.

⚠ WARNING

If you drive off while the EASY-ENTRY/EXIT feature is making adjustments, you could lose control of the vehicle. There is a risk of an accident.

Always wait until the adjustment process is complete before driving off.

Position of the steering wheel when the EASY-ENTRY/EXIT feature is active

The steering wheel swings upwards when you:

- remove the SmartKey from the ignition lock
- open the driver's door with the KEYLESS-GO start function in position **1**
- open the driver's door and the SmartKey is in position **0** or **1** in the ignition lock

- i** The steering wheel only moves upwards if it has not already reached the upper end stop.

Position of the steering wheel for driving

The steering wheel is moved to the last selected position when you:

- close the driver's door and
- press the Start/Stop button once

When you close the driver's door with the ignition switched on, the steering wheel is also automatically moved to the previously set position.

The last position of the steering wheel is stored after each manual setting or when you

store the setting with the memory function (► page 86).

Crash-responsive EASY-EXIT feature

If the crash-responsive EASY-EXIT feature is triggered in an accident, the steering column will move upwards when the driver's door is opened. This occurs irrespective of the position of the SmartKey in the ignition lock. This makes it easier to exit the vehicle and rescue the occupants.

The crash-responsive EASY-EXIT feature is only operational if the EASY-EXIT/ENTRY feature is activated in the on-board computer.

Mirrors

Rear-view mirror

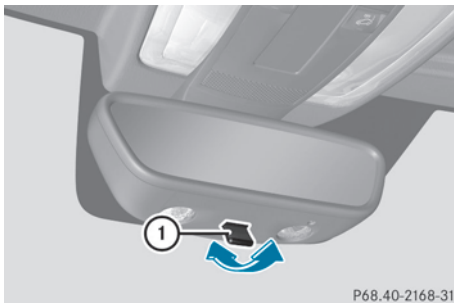

P68.40-2168-31

- **Anti-glare mode:** flick anti-glare switch ① forwards or back.

Exterior mirrors

Adjusting the exterior mirrors

WARNING

You could lose control of your vehicle if you do the following while driving:

- adjust the driver's seat, head restraint, steering wheel or mirrors
- fasten the seat belt

There is a risk of an accident.

Adjust the driver's seat, head restraint, steering wheel and mirror and fasten your seat belt before starting the engine.

WARNING

The exterior mirror on the front-passenger side reduces the size of the image. Visible objects are actually closer than they appear. This means that you could misjudge the distance from road users traveling behind, e.g. when changing lane. There is a risk of an accident.

For this reason, always make sure of the actual distance from the road users traveling behind by glancing over your shoulder.

The convex exterior mirrors provide a larger field of vision.

The exterior mirrors are heated automatically if the rear window defroster is switched on and the outside temperature is low. Mirror heating lasts up to 10 minutes.

-  You can also heat up the exterior mirrors manually by switching on the rear window defroster.

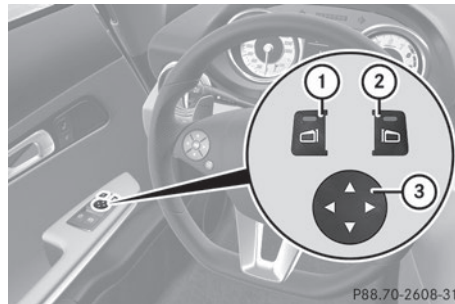

P88.70-2608-31

- Select key position **1** or **2** with the Start/Stop button.
- Press button ① for the left-hand exterior mirror or button ② for the right-hand exterior mirror. The indicator lamp in the corresponding button lights up in red. The indicator lamp goes out again after some time. You can adjust the selected

mirror using adjustment button ③ as long as the indicator lamp is lit.

- ▶ Press adjustment button ③ up, down, or to the left or right until you have adjusted the exterior mirror to the desired position. You should have a good overview of traffic conditions.

Folding the exterior mirrors in or out electrically

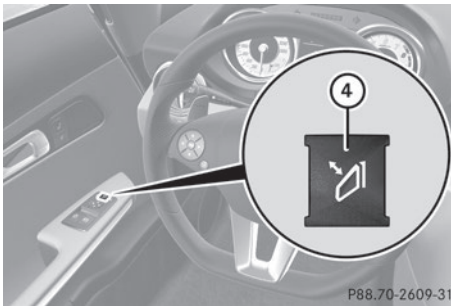

- ▶ Select key position 1 or 2 with the Start/Stop button.
 - ▶ Briefly press button ④.
Both exterior mirrors fold in or out.
- i** Make sure that the exterior mirrors are always folded out fully while the vehicle is in motion, as they may otherwise vibrate.
- i** If you are driving faster than 30 mph (47 km/h), you can no longer fold in the exterior mirrors.

Setting the exterior mirrors

If the battery has been disconnected or completely discharged, the exterior mirrors must be reset. The exterior mirrors will otherwise not fold in when you select the "Fold in mirrors when locking" function in the on-board computer (▷ page 148).

- ▶ Select key position 1 using the Start/Stop button.
- ▶ Briefly press button ④.

Folding the exterior mirrors in or out automatically

If the "Fold in mirrors when locking" function is activated in the on-board computer (▷ page 148):

- the exterior mirrors fold in automatically as soon as you lock the vehicle from the outside.
- the exterior mirrors fold out again automatically as soon as you unlock the vehicle and then open the driver's or front-passenger door.

- i** The mirrors do not fold out if they have been folded in manually.

Exterior mirror pushed out of position

If an exterior mirror has been pushed out of position, proceed as follows:

- ▶ **Vehicles without electrically folding exterior mirrors:** move the exterior mirror into the correct position manually.
- ▶ **Vehicles with electrically folding exterior mirrors:** press and hold mirror-folding button until you hear a click and then the mirrors engage in position (▷ page 85).
The mirror housing is engaged again and you can adjust the exterior mirrors as usual (▷ page 84).

Automatic anti-glare mirrors

The rear-view mirror and the exterior mirror on the driver's side automatically go into anti-glare mode if the following conditions are met simultaneously:

- the ignition is switched on and
- incident light from headlamps strikes the sensor in the rear-view mirror.

The mirrors do not go into anti-glare mode if reverse gear is engaged.

Parking position for the exterior mirror on the front-passenger side

Setting and storing the parking position

You can position the front-passenger side exterior mirror in such a way that you can see the rear wheel on that side as soon as you engage reverse gear. You can store this position.

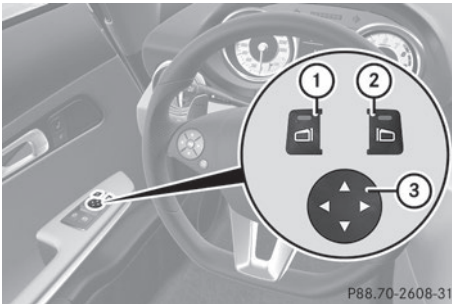

- ▶ Select key position **2** with the Start/Stop button.
 - ▶ Press button **②** for the exterior mirror on the front-passenger side.
 - ▶ Engage reverse gear.
The exterior mirror on the front-passenger side moves to the preset parking position.
 - ▶ Use adjustment button **③** to adjust the exterior mirror to a position that allows you to see the rear wheel and the curb.
The parking position is stored.
- i** If you shift the transmission to another position, the exterior mirror on the front-passenger side returns to the driving position.

Calling up a stored parking position setting

- ▶ Select key position **2** with the Start/Stop button.
- ▶ Adjust the exterior mirror on the front-passenger side with the corresponding button (▷ page 84).
- ▶ Engage reverse gear.
The exterior mirror on the front-passenger side moves to the stored parking position.

The exterior mirror on the front-passenger side moves back to its original position:

- as soon as you exceed a speed of 6 mph (10 km/h)
- about ten seconds after you have disengaged reverse gear
- if you press button **①** for the exterior mirror on the driver's side

Memory function

Storing settings

WARNING

If you use the memory function on the driver's side while driving, you could lose control of the vehicle as a result of the adjustments being made. There is a risk of an accident. Only use the memory function on the driver's side when the vehicle is stationary.

WARNING

When the memory function adjusts the seat or steering wheel, you and other vehicle occupants – particularly children – could become trapped. There is a risk of injury. While the memory function is making adjustments, make sure that no one has any body parts in the sweep of the seat or steering wheel. If somebody becomes trapped, immediately release the memory function position button. The adjustment process is stopped.

WARNING

Children could become trapped if they activate the memory function, particularly when unattended. There is a risk of injury. When leaving the vehicle, always take the SmartKey with you and lock the vehicle. Never leave children unsupervised in the vehicle.

With the memory function, you can store up to three different settings, e.g. for three different people.

The following settings are stored as a single memory preset:

- seat and backrest position
- driver's side: steering wheel position
- driver's side: position of the exterior mirrors on the driver's and front-passenger sides

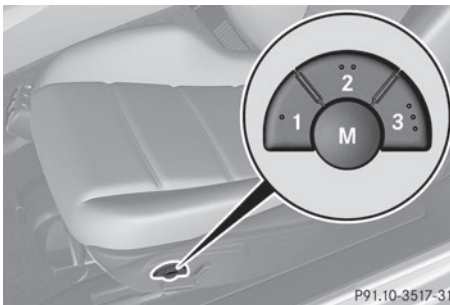

- ▶ Select key position **2** with the Start/Stop button.
- ▶ Adjust the seat (> page 80).
- ▶ On the driver's side, adjust the steering wheel (> page 82) and the exterior mirrors (> page 84).
- ▶ Press memory button **M** and one of the storage position buttons **1**, **2** or **3** within three seconds. The settings are stored in the selected preset position. A tone sounds when the settings have been completed.

Calling up a stored setting

- ▶ Press and hold the relevant storage position button **1**, **2** or **3**, until the seat, steering wheel and exterior mirrors are in the stored position.
- i** The setting procedure is interrupted as soon as you release the storage position button.

Useful information 90
Exterior lighting 90
Interior lighting 93
Replacing bulbs 94
Windshield wipers 95

Useful information

- i** This Operator's Manual describes all models and all standard and optional equipment of your vehicle available at the time of publication of the Operator's Manual. Country-specific differences are possible. Please note that your vehicle may not be equipped with all features described. This also applies to safety-related systems and functions.
- i** Please read the information on qualified specialist workshops (▷ page 21).

Exterior lighting

General notes

For reasons of safety, Mercedes-Benz recommends that you drive with the lights switched on even during the daytime. In some countries, operation of the headlamps varies due to legal requirements and self-imposed obligations.

Driving abroad

Converting to symmetrical low beam when driving abroad: switch the headlamps to symmetrical low beam in countries in which traffic drives on the opposite side of the road to the country where the vehicle is registered. This prevents glare to oncoming traffic. Symmetrical lights do not illuminate as large an area of the edge of the road.

Have the headlamps converted at a qualified specialist workshop, e.g. an authorized Mercedes-Benz Center, as close to the border as possible before driving in these countries.

Converting to asymmetrical low beam after returning: have the headlamps converted back to asymmetrical low beam at a qualified specialist workshop, e.g. an authorized Mercedes-Benz Center, as soon as possible after crossing the border again.

Setting the exterior lighting

Setting options

Exterior lighting can be set using:

- the light switch
- the combination switch (▷ page 92)
- the on-board computer (▷ page 146)

Light switch

Operation

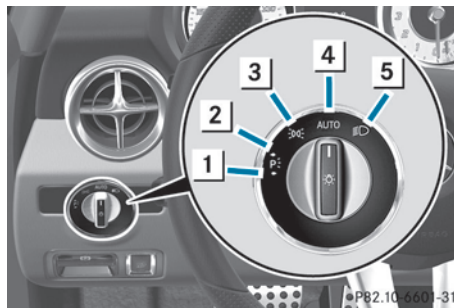

- 1** Left-hand standing lamps
- 2** Right-hand standing lamps
- 3** Parking lamps, license plate and instrument cluster lighting
- 4** **AUTO** Automatic headlamp mode, controlled by the light sensor
- 5** Low-beam/high-beam headlamps

If you hear a warning tone when you leave the vehicle, the lights may still be switched on.

- Turn the light switch to **AUTO**.

The exterior lighting (except the parking/standing lamps) switches off automatically if you:

- remove the SmartKey from the ignition lock
- open the driver's door with the SmartKey in position **0**.

Automatic headlamp mode

WARNING

When the light switch is set to **AUTO**, the low-beam headlamps may not be switched on automatically if there is fog, snow or other

causes of poor visibility due to the weather conditions such as spray. There is a risk of an accident.

In such situations, turn the light switch to



The automatic headlamp feature is only an aid. The driver is responsible for the vehicle's lighting at all times.



AUTO is the favored light switch setting. The light setting is automatically selected according to the brightness of the ambient light (exception: poor visibility due to weather conditions such as fog, snow or spray):

- SmartKey in position **1** in the ignition lock: the parking lamps are switched on or off automatically depending on the brightness of the ambient light.
- With the engine running: if you have activated the daytime running lamps function via the on-board computer, the daytime running lamps or the low-beam headlamps and parking lamps are switched on or off automatically depending on the brightness of the ambient light.

Only for Canada:



The daytime running lamps improve the visibility of your vehicle during the day. The daytime running lamps function is required by law in Canada. It cannot therefore be deactivated.

When the engine is running and the vehicle is stationary: if you move the selector lever from a drive position to **P**, the daytime running lamps/low-beam headlamps go out after three minutes.

When the engine is running, the vehicle is stationary and in bright ambient light: if you turn the light switch to , the daytime running lamps and parking lamps switch on. If the engine is running and you turn the light switch to , the manual settings take precedence over the daytime running lamps.

USA only:

The daytime running lamps improve the visibility of your vehicle during the day. To do this, the daytime running lamps function must be switched on using the on-board computer (> page 146).

If the engine is running and you turn the light switch to  or , the manual settings take precedence over the daytime running lamps.

i In the USA, the daytime running lamps are deactivated upon delivery from the factory.

► **To switch on automatic headlamp mode:** turn the light switch to **AUTO**.

Low-beam headlamps



Even if the light sensor does not detect that it is dark, the parking lamps and low-beam headlamps switch on when the ignition is switched on and the light switch is set to the  position. This is a particularly useful function in the event of rain and fog.

► **To switch on the low-beam headlamps:** turn the SmartKey in the ignition lock to position **2** or start the engine.

► Turn the light switch to .

The green  indicator lamp in the instrument cluster lights up.



Parking lamps

i If the battery has been excessively discharged, the parking lamps or standing lamps are automatically switched off to enable the next engine start. Always park your vehicle safely and sufficiently lit according to legal standards. Avoid the continuous use of the  parking lamps for several hours. If possible, switch on the  right or the  left standing lamp.

► **To switch on:** turn the light switch to .

Standing lamps

Switching on the standing lamps ensures the corresponding side of the vehicle is illuminated.

- ▶ **To switch on the standing lamps:** the SmartKey is not in the ignition lock or it is in position **0**.
- ▶ Turn the light switch to  (left-hand side of the vehicle) or  (right-hand side of the vehicle).

Combination switch

Turn signal

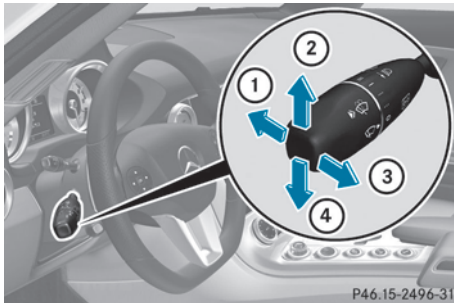

- ① High-beam headlamps
- ② Turn signal, right
- ③ High-beam flasher
- ④ Turn signal, left

- ▶ **To indicate briefly:** press the combination switch briefly to the pressure point in the direction of arrow ② or ④. The corresponding turn signal flashes three times.
- ▶ **To indicate:** press the combination switch beyond the pressure point in the direction of arrow ② or ④.

High-beam headlamps

- ▶ **To switch on the high-beam headlamps:** turn the SmartKey in the ignition lock to position **2** or start the engine.
- ▶ Turn the light switch to  or **AUTO**.

- ▶ Press the combination switch beyond the pressure point in the direction of arrow ①.

In the **AUTO** position, the high-beam headlamps are only switched on when it is dark and the engine is running.

The  indicator lamp in the instrument cluster lights up when the high-beam headlamps are switched on.

- ▶ **To switch off the high-beam headlamps:** move the combination switch back to its normal position. The  indicator lamp in the instrument cluster goes out.

High-beam flasher

- ▶ **To switch on:** turn the SmartKey in the ignition lock to position **1** or **2**, or start the engine.
- ▶ Pull the combination switch briefly in the direction of arrow ③.

Hazard warning lamps



The hazard warning lamps automatically switch on if:

- an air bag is deployed or
 - the vehicle decelerates rapidly from a speed of more than 45 mph (70 km/h) and comes to a standstill.
- ▶ **To switch on the hazard warning lamps:** press button ①. All turn signals flash. If you now switch on a turn signal using the combination switch,

only the turn signal lamp on the corresponding side of the vehicle will flash.

- ▶ **To switch off the hazard warning lamps:** press button ①.

The hazard warning lamps switch off automatically if the vehicle exceeds a speed of 6 mph (10 km/h) again after a full brake application.

- ❗ The hazard warning lamps still operate if the ignition is switched off.

Headlamp cleaning system

The headlamps are cleaned automatically if the "Wipe with washer fluid" function is operated five times (▷ page 95) while the lights are on and the engine is running. When you switch off the ignition, the automatic headlamp cleaning system is reset and counting is resumed from 0.

Headlamps fogged up on the inside

The headlamps may fog up on the inside if there is high atmospheric humidity.

- ▶ Drive with the headlamps switched on. The level of moisture diminishes, depending on the length of the journey and the weather conditions (humidity and temperature).

If the level of moisture does not diminish:



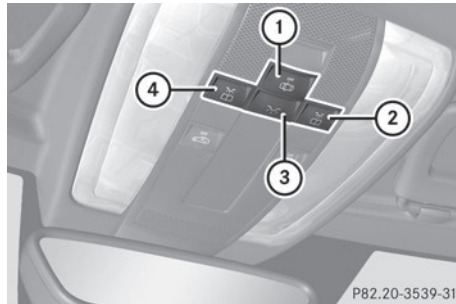

- ▶ Have the headlamps checked at a qualified specialist workshop.

Interior lighting

Overview of interior lighting



Overhead control panel

- ①  Switches the automatic interior lighting control on/off
- ②  Switches the right-hand reading lamp on/off
- ③  Switches the interior lighting on/off
- ④  Switches the left-hand reading lamp on/off

Interior lighting control

General notes

In order to prevent the vehicle's battery from discharging, the interior lighting functions are automatically deactivated after some time unless the SmartKey is in position **2** in the ignition lock.

Automatic interior lighting control

- ▶ **To activate/deactivate:** press the  button.



When the automatic interior lighting control is activated, the button is flush with the overhead control panel.

The interior lighting automatically switches on if you:

- unlock the vehicle
- open a door
- remove the SmartKey from the ignition lock

The interior light is activated for a short while when the SmartKey is removed from the ignition lock. You can activate this delayed switch-off using the on-board computer (▷ page 147).

Manual interior lighting control

- ▶ **To switch the interior lighting on/off:** press the  button.
- ▶ **To switch the reading lamps on/off:** press the  button.

Crash-responsive emergency lighting

The interior lighting is activated automatically if the vehicle is involved in an accident.

- ▶ **To switch off the crash-responsive emergency lighting:** press the hazard warning lamp button.
- or
- ▶ Lock and then unlock the vehicle using the key.

Replacing bulbs

Important safety notes

Xenon bulbs

DANGER

Xenon bulbs carry a high voltage. You can get an electric shock if you remove the cover of the Xenon bulb and touch the electrical contacts. There is a risk of fatal injury.

Never touch the parts or the electrical contacts of the Xenon bulb. Always have work on the Xenon bulbs carried out at a qualified specialist workshop.

Your vehicle is equipped with Xenon bulbs. You can recognize this by the following: the cone of light from the Xenon bulbs moves from the top to the bottom and back again when you start the engine. For this to be

observed, the lights must be switched on before starting the engine.

Bulbs and lamps are an important aspect of vehicle safety. You must therefore make sure that these function correctly at all times. Have the headlamp setting checked regularly.

Other bulbs

WARNING

Bulbs, lamps and connectors can get very hot when operating. If you change a bulb, you could burn yourself on these components. There is a risk of injury.

Allow these components to cool down before changing a bulb.

There are bulbs other than the Xenon bulbs that you cannot replace. Replace only the bulbs listed (▷ page 95). Have the bulbs that you cannot replace yourself changed at a qualified specialist workshop.

If you require assistance changing bulbs, consult a qualified specialist workshop.

Do not touch the glass tube of new bulbs with your bare hands. Even minor contamination can burn into the glass surface and reduce the service life of the bulbs. Always use a lint-free cloth or only touch the base of the bulb when installing.

Only use bulbs of the correct type.

If the new bulb still does not light up, consult a qualified specialist workshop.

Bulbs and lamps are an important aspect of vehicle safety. You must therefore make sure that these function correctly at all times. Have the headlamp setting checked regularly.

Changing the front bulbs

You cannot replace the bulbs at the front yourself. Contact a qualified specialist workshop which has the necessary specialist knowledge and tools to carry out the work required. Mercedes-Benz recommends that

you use an authorized Mercedes-Benz Center for this purpose.

Changing the rear bulbs

License plate lamp

The only rear bulbs you can change are the W 5 W license plate lamp bulbs.

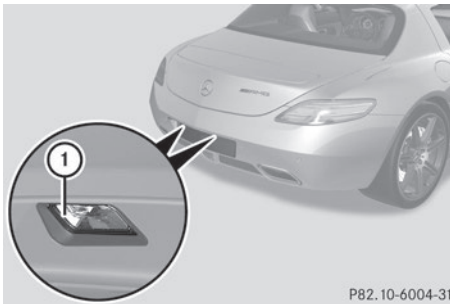

- ▶ Switch off the lights.
- ▶ Lever lamp housing ① out of the frame using a screwdriver.
- ▶ Unscrew the bulb holder from the lamp housing and pull out the bulb.
- ▶ Insert a new bulb into the bulb holder and screw the bulb holder into the lamp housing.
- ▶ Press the lamp housing back into the frame until it engages.

Windshield wipers

Switching the windshield wipers on/off

! Do not operate the windshield wipers when the windshield is dry, as this could damage the wiper blades. Moreover, dust that has collected on the windshield can scratch the glass if wiping takes place when the windshield is dry.

If it is necessary to switch on the windshield wipers in dry weather conditions, always

- ¹ Rain sensor set to low sensitivity.
- ² Rain sensor set to high sensitivity.

use washer fluid when operating the windshield wipers.

! If the windshield wipers leave smears on the windshield after the vehicle has been washed in an automatic car wash, wax or other residues may be the reason for this. Clean the windshield using washer fluid after washing the vehicle in an automatic car wash.

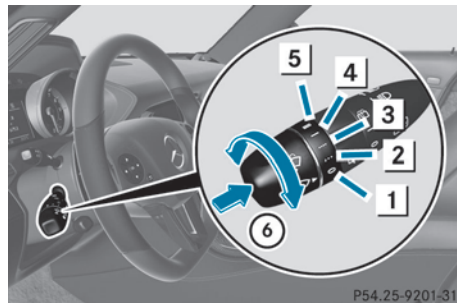

Combination switch



- 1 0 Windshield wiper off
- 2 ... Intermittent wipe, low¹
- 3 Intermittent wipe, high²
- 4 — Continuous wipe, slow
- 5 = Continuous wipe, fast
- 6 [Washer fluid symbol] Single wipe/ [Washer fluid symbol] To wipe the windshield using washer fluid

- ▶ Switch on the ignition.
- ▶ Turn the combination switch to the corresponding position.

! Intermittent wiping with rain sensor: due to optical influences and the windshield becoming dirty in dry weather conditions, the windshield wipers may be activated inadvertently. This could then damage the windshield wiper blades or scratch the windshield.

For this reason, you should always switch off the windshield wipers in dry weather.

In the ... or position, the appropriate wiping frequency is set automatically

according to the intensity of the rain. In the  position, the rain sensor is more sensitive than in the  position, causing the windshield wipers to wipe more frequently.

If the wiper blades are worn, the windshield will no longer be wiped properly. This could prevent you from observing the traffic conditions. Replace the wiper blades twice a year, ideally in spring and fall.

Replacing the wiper blades

Important safety notes

WARNING

If the windshield wipers begin to move while you are changing the wiper blades, you could be trapped by the wiper arm. There is a risk of injury.

Always switch off the windshield wipers and ignition before changing the wiper blades.

! To avoid damaging the wiper blades, make sure that you touch only the wiper arm of the wiper.

! Never open the hood if a windshield wiper arm has been folded away from the windshield.

Never fold a windshield wiper arm without a wiper blade back onto the windshield.

Hold the windshield wiper arm firmly when you change the wiper blade. If you release the windshield wiper arm without a wiper blade and it falls onto the windshield, the windshield may be damaged by the force of the impact.

Mercedes-Benz recommends that you have the wiper blades changed at a qualified specialist workshop.

Replacing the wiper blades

Removing the wiper blades

- ▶ Switch off the engine.
- ▶ Remove your foot from the brake pedal.
- ▶ Set the windshield wiper to the  position.
- ▶ Press the Start/Stop button repeatedly until the windshield wipers start.
- ▶ When the wiper arms have reached a vertical position, press the Start/Stop button.
- ▶ Fold the wiper arm away from the windshield until it engages.
- ▶ Set the wiper blade at right angles to the wiper arm.

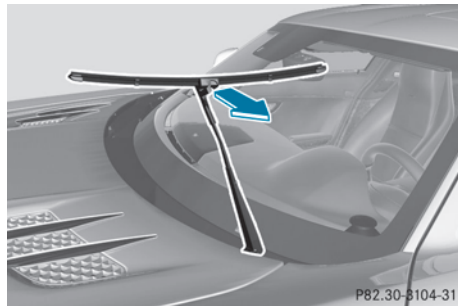

- ▶ Remove the wiper blade from the retainer on the wiper arm in the direction of the arrow.

Installing the wiper blades

- ▶ Slide the new wiper blade into the retainer on the wiper arm in the opposite direction to the arrow.
- ▶ Turn the wiper blade parallel to the wiper arm.
- ▶ Fold the wiper arm back onto the windshield.

Problems with the windshield wipers

Problem	Possible causes/consequences and ► Solutions
The windshield wipers are jammed.	<p>Leaves or snow, for example, may be obstructing the windshield wiper movement. The wiper motor has been deactivated.</p> <ul style="list-style-type: none"> ► Switch off the engine using the Start/Stop button and open the driver's door. ► Remove the cause of the obstruction. ► Switch the windshield wipers back on.
The windshield wipers fail completely.	<p>The windshield wiper drive is malfunctioning.</p> <ul style="list-style-type: none"> ► Select another wiper speed on the combination switch. ► Have the windshield wipers checked at a qualified specialist workshop.
The windshield washer fluid from the spray nozzles no longer hits the center of the windshield.	<p>The spray nozzles are misaligned.</p> <ul style="list-style-type: none"> ► Have the spray nozzles adjusted at a qualified specialist workshop.
The wiper arms are on the windshield.	<p>The wiper arms have been moved by an external force.</p> <ul style="list-style-type: none"> ► Select key position 2 (ignition) with the Start/Stop button. The wiper arms move back down automatically.

Useful information	100
Overview of climate control systems	100
Operating the climate control systems	102
Setting the air vents	107

Useful information

- i** This Operator's Manual describes all models and all standard and optional equipment of your vehicle available at the time of publication of the Operator's Manual. Country-specific differences are possible. Please note that your vehicle may not be equipped with all features described. This also applies to safety-related systems and functions.
- i** Please read the information on qualified specialist workshops (▷ page 21).

pollen. A clogged filter reduces the amount of air supplied to the vehicle interior. For this reason, you should always observe the interval for replacing the filter, which is specified in the Maintenance Booklet. As it depends on environmental conditions, e.g. heavy air pollution, the interval may be shorter than stated in the Maintenance Booklet.

Overview of climate control systems

Important safety notes

Observe the settings recommended on the following pages. The windows could otherwise fog up.

To prevent the windows from fogging up:

- switch off climate control only briefly
- switch on air-recirculation mode only briefly
- switch on the cooling with air dehumidification function
- switch on the defrost windshield function briefly, if required

The automatic climate control regulates the temperature and the humidity in the vehicle interior and filters undesirable substances out of the air.

Dual-zone automatic climate control is only operational when the engine is running. Optimum operation is only achieved with the side windows closed.

- i** When the weather is warm, ventilate the vehicle for a brief period. This will speed up the cooling process and the desired vehicle interior temperature will be reached more quickly.
- i** The integrated filter can filter out most particles of dust, and completely filters out

Control panel for 2-zone automatic climate control

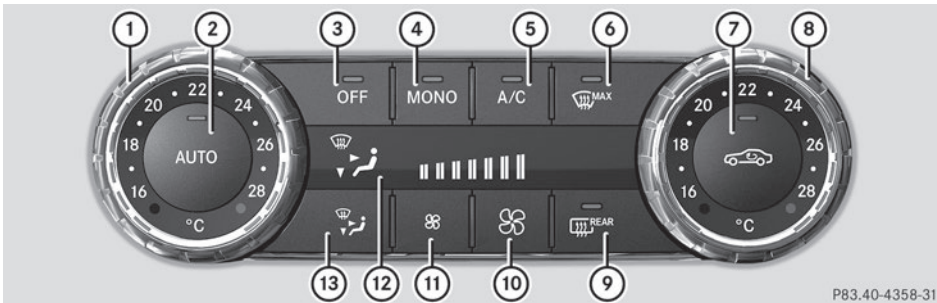

Canada only

- ① To set the temperature, left (▷ page 104)
- ② To set climate control to automatic (▷ page 104)
- ③ To switch climate control on/off (▷ page 102)
- ④ To switch the MONO function on/off
- ⑤ To switch cooling with air dehumidification on/off (▷ page 102)
- ⑥ To defrost the windshield (▷ page 105)
- ⑦ To activate/deactivate air-recirculation mode (▷ page 107)
- ⑧ To set the temperature, right (▷ page 104)
- ⑨ To switch the rear window defroster on/off (▷ page 106)
- ⑩ To increase the airflow (▷ page 105)
- ⑪ To reduce the airflow (▷ page 105)
- ⑫ Display
- ⑬ To set the air distribution (▷ page 104)

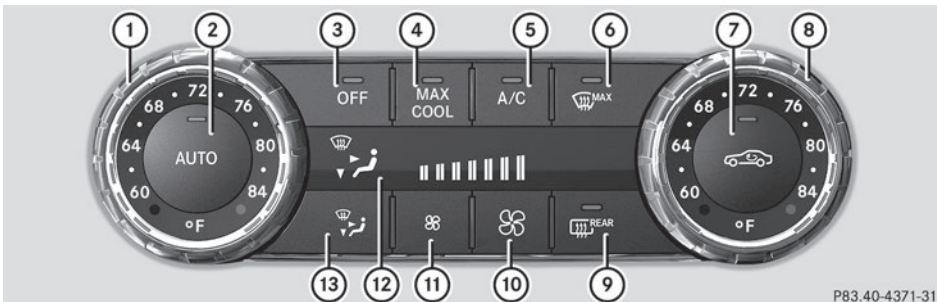

USA only

- ① To set the temperature, left
- ② To set climate control to automatic (▷ page 104)
- ③ To switch climate control on/off (▷ page 102)
- ④ To switch maximum cooling on/off (▷ page 105)
- ⑤ To switch cooling with air dehumidification on/off (▷ page 102)

- ⑥ To defrost the windshield (▷ page 105)
- ⑦ To activate/deactivate air-recirculation mode (▷ page 107)
- ⑧ To set the temperature, right (▷ page 104)
- ⑨ To switch the rear window defroster on/off (▷ page 106)
- ⑩ To increase the airflow (▷ page 105)
- ⑪ To reduce the airflow (▷ page 105)
- ⑫ Display
- ⑬ To set the air distribution (▷ page 104)

Notes on using dual-zone automatic climate control

The following contains instructions and recommendations to enable you to get the most out of your automatic climate control.

- Activate climate control using the **AUTO** and **A/C** buttons. The indicator lamps in the **AUTO** and **A/C** buttons light up.
- Set the temperature to 72 °F (22 °C).
- Only use the "Windshield defrosting" function briefly until the windshield is clear again.
- Only use air-recirculation mode briefly, e.g. if there are unpleasant outside odors or when in a tunnel. The windows could otherwise fog up, since no fresh air is drawn into the vehicle in air-recirculation mode.
- Use the MONO function if you want to adopt the temperature and air distribution settings from the driver's side for all climate control zones. The indicator lamp in the **MONO** button lights up.

Operating the climate control systems

Switching climate control on/off

General notes

When the climate control is switched off, the air supply and air circulation are also switched off. The windows could fog up. Therefore, switch off climate control only briefly

- i** Activate climate control primarily using the **AUTO** button (▷ page 104).

Activating/deactivating

- ▶ Select key position **2** with the Start/Stop button (▷ page 111).
- ▶ **To activate:** press the **AUTO** button. The indicator lamp in the **AUTO** button lights up. Airflow and air distribution are set to automatic mode.

or

- ▶ Press the **OFF** button. The indicator lamp in the **OFF** button goes out. The previously selected settings are restored.
- ▶ **To deactivate:** press the **OFF** button. The indicator lamp in the **OFF** button lights up.

Activating/deactivating cooling with air dehumidification

General notes





If you deactivate the "Cooling with air-dehumidification" function, the air inside the vehicle will not be cooled. The air inside the vehicle will also not be dehumidified. The windows can fog up more quickly. Therefore, deactivate the cooling with air-dehumidification function only briefly.

The "Cooling with air dehumidification" function is only available when the engine is running. The air inside the vehicle is cooled

and dehumidified according to the temperature selected.

Condensation may drip from the underside of the vehicle when it is in cooling mode. This is normal and not a sign that there is a malfunction.

Activating/deactivating

- ▶ **To activate:** press the  button.
The indicator lamp in the  button lights up.
- ▶ **To deactivate:** press the  button.
The indicator lamp in the  button goes out. The "Cooling with air dehumidification" function has a delayed switch-off feature.

Problems with the "Cooling with air dehumidification" function

Problem	Possible causes/consequences and ► Solutions
The indicator lamp in the  button flashes three times or remains off. The "Cooling with air dehumidification" function cannot be switched on.	Cooling with air dehumidification has been deactivated due to a malfunction. ► Visit a qualified specialist workshop.

Setting climate control to automatic

General notes





In automatic mode, the set temperature is controlled automatically. The system automatically regulates the temperature of the dispensed air, the airflow and the air distribution.

The automatic mode functions optimally when the "Cooling with air dehumidification" function is activated. If necessary, cooling with air dehumidification can be deactivated.

If you deactivate the "Cooling with air-dehumidification" function, the air inside the vehicle will not be cooled. The air inside the vehicle will also not be dehumidified. The windows can fog up more quickly. Therefore, deactivate the cooling with air-dehumidification function only briefly.

Activating/switching

- Select key position **2** with the Start/Stop button (► page 111).
- Set the desired temperature.

- **To activate:** press the  button.
The indicator lamp in the  button lights up. Automatic air distribution and airflow are activated.
- **To switch to manual mode:** press the  button.
The indicator lamp in the  button goes out. Automatic air distribution and airflow are deactivated.

Setting the temperature



Different temperatures can be set for the driver's and front-passenger sides.





- Select key position **2** with the Start/Stop button (► page 111).
- **To increase/reduce:** turn controls ① and ② clockwise or counter-clockwise (► page 101).

Only change the temperature setting in small increments. Start at 72 °F (22 °C).

Setting the air distribution

Air distribution settings



-  Directs air through the defroster vents
-  Directs air through the center and side air vents
-  Directs air through the footwell air vents

-  Directs air through the center, side and footwell vents
-  Directs the airflow to the entire vehicle interior
-  Directs air through the defroster, center and side air vents
-  Directs air through the defroster and footwell vents

Setting the air distribution

- ▶ Select key position **2** with the Start/Stop button (▷ page 111).
- ▶ Press the  button repeatedly until the desired symbol appears in the display. The indicator lamp in the **AUTO** button goes out. Automatic control is deactivated and the air distribution is controlled according to the selected setting.

Setting the airflow

- ▶ Select key position **2** with the Start/Stop button (▷ page 111).
- ▶ **To increase/reduce:** press the  or  button.

Switching the mono function on/off



The MONO function is only available in vehicles for Canada.



You can use the MONO function to adopt the temperature and air distribution settings on the driver's side for the front-passenger side.

- ▶ Press the **MONO** button.
The indicator lamp in the **MONO** button lights up or goes out.

Defrosting the windshield

- i** You should only select the "Windshield defrosting" function until the windshield is clear again.

- ▶ Select key position **2** with the Start/Stop button (▷ page 111).
- ▶ **To activate:** press the  button. The indicator lamp in the  button lights up. The system automatically switches to the following functions:
 - high airflow
 - high temperature
 - air distribution to the windshield and front side windows
 - air-recirculation mode off

- ▶ **To deactivate:** press the  button. The indicator lamp in the  button goes out. The previously selected settings are restored. Air-recirculation mode remains deactivated.

or

- ▶ Press the **AUTO** button. The indicator lamp in the  button goes out. Airflow and air distribution are set to automatic mode.

or

- ▶ Turn controls ① or ⑧ clockwise or counter-clockwise (▷ page 101).

or

- ▶ Press the  or  button.





Switching maximum cooling on/off

The MAX COOL function is only available in vehicles for the USA.

MAX COOL is only operational when the engine is running.



When you activate MAX COOL, climate control switches to the following functions:

- maximum cooling
- maximum airflow
- air-recirculation mode on



- ▶ **To activate:** press the  button.
The indicator lamp in the button lights up.
- ▶ **To deactivate:** press the  button again.
The indicator lamp in the button goes out.
The previously selected settings come into effect again.
- ❗ To deactivate MAX COOL press the , , or  button.

Defrosting the windows

Windows fogged up on the inside

- ▶ Activate the "Cooling with air dehumidification" function .
- ▶ Activate automatic mode .
- ▶ If the windows continue to fog up, activate the "Windshield defrosting" function .

Windows fogged up on the outside

- ▶ Activate the windshield wipers.
- ▶ Press the  button repeatedly until the  or  symbol appears in the display.
- ❗ You should only select this setting until the windshield is clear again.



Rear window defroster

General notes

The rear window defroster has a high current draw. You should therefore switch it off as soon as the rear window is clear. Otherwise, the rear window defroster switches off automatically after several minutes.

If the battery voltage is too low, the rear window defroster may switch off.

Activating/deactivating

- ▶ Select key position **2** with the Start/Stop button (▷ page 111).
- ▶ Press the  button.
The indicator lamp in the  button lights up or goes out.

Problems with the rear window defroster

Problem	Possible causes/consequences and ► Solutions
The rear window defroster has deactivated prematurely or cannot be activated.	<p>The on-board voltage is too low because too many electrical consumers are switched on.</p> <p>► Switch off any consumers that are not required, e.g. reading lamps, interior lighting or the seat heating.</p> <p>When the battery is sufficiently charged, the rear window defroster can be activated again.</p>





Activating/deactivating air-recirculation mode

General notes

You can deactivate the flow of fresh air if unpleasant odors are entering the vehicle from outside. The air already inside the vehicle will then be recirculated.

If you switch on air-recirculation mode, the windows can fog up more quickly, in particular at low temperatures. Only use air-recirculation mode briefly to prevent the windows from fogging up.

Activating/deactivating

- Select key position **2** with the Start/Stop button (► page 111).
- **To activate:** press the  button. The indicator lamp in the  button lights up.
- i** Air-recirculation mode is activated automatically at high outside temperatures. When air-recirculation mode is activated automatically, the indicator lamp in the  button is not lit. Outside air is added after about 30 minutes.
- **To deactivate:** press the  button. The indicator lamp in the  button goes out.

i Air-recirculation mode deactivates automatically:

- after approximately five minutes at outside temperatures below approximately 41 °F (5 °C)
- after approximately five minutes if cooling with air dehumidification is deactivated
- after approximately 30 minutes at outside temperatures above approximately 41 °F (5 °C) if the "Cooling with air dehumidification" function is activated

Setting the air vents

Important safety notes

WARNING

Very hot or very cold air can flow from the air vents. This could result in burns or frostbite in the immediate vicinity of the air vents. There is a risk of injury.

Make sure that all vehicle occupants always maintain a sufficient distance to the air outlets. If necessary, redirect the airflow to another area of the vehicle interior.

In order to ensure the direct flow of fresh air through the air vents into the vehicle interior, please observe the following notes:

- keep the air inlet on the right-hand side of the hood free of blockages, such as ice, snow or leaves.
 - never cover the air vents or air intake grilles in the vehicle interior.
- i** For virtually draft-free ventilation, adjust the sliders of the air vents to the center position.

Setting the center air vents

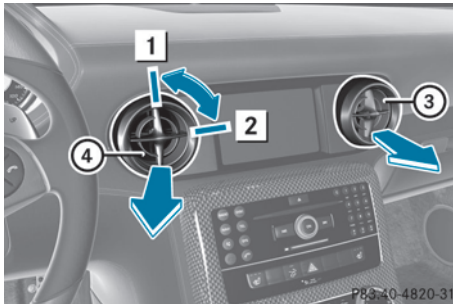

- 1 To open the center air vent
- 2 To close the center air vent
- 3 Center air vent, right
- 4 Center air vent, left

- **To open the center air vent:** turn the adjuster in center air vent 3 or 4 in the direction of the arrow to position 1.
- **To close the center air vent:** turn the adjuster in center air vent 3 or 4 in the direction of the arrow to position 2.

Setting the side air vents

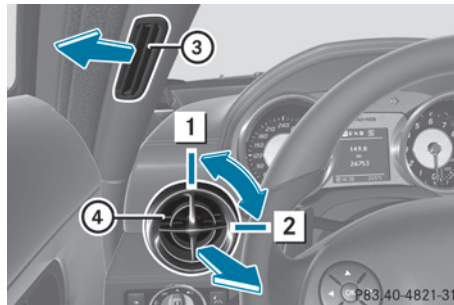

- 1 To open the side air vent
- 2 To close the side air vent
- 3 Side window defroster vent
- 4 Side air vent

- **To open the side air vent:** turn the adjuster in side air vent 4 in the direction of the arrow to position 1.
- **To close the side air vent:** turn the adjuster in side air vent 4 in the direction of the arrow to position 2.

Useful information	110
Notes on breaking-in a new vehicle	110
Driving	110
AMG SPEEDSHIFT DCT 7-speed sports transmission	113
AMG button (SETUP)	121
Refueling	121
Parking	124
Driving tips	127
Driving systems	131

Useful information

- i** This Operator's Manual describes all models and all standard and optional equipment of your vehicle available at the time of publication of the Operator's Manual. Country-specific differences are possible. Please note that your vehicle may not be equipped with all features described. This also applies to safety-related systems and functions.
- i** Please read the information on qualified specialist workshops (▷ page 21).

Notes on breaking-in a new vehicle

Important safety notes

New brake pads/linings only reach their optimum braking effect after several hundred kilometers of driving. Until that time, you may need to use increased brake pedal pressure while braking. This also applies after the brake discs or the brake pads/linings have been replaced.

The first 1000 miles (1500 km)

The more you look after the engine when it is new, the more satisfied you will be with its performance in the future.

- You should therefore drive at varying vehicle and engine speeds for the first 1,000 miles (1,500 km).
- Do not drive faster than 85 mph (140 km/h) for the first 1,000 miles (1,500 km).
- Only allow the engine to reach a maximum engine speed of 4,500 rpm briefly.
- Avoid heavy loads, e.g. driving at full throttle, during this period. Do not exceed $\frac{2}{3}$ of the maximum permitted engine speed for each gear.

- Select manual drive program **M** and temporary manual drive program in good time.
- Do not carry out a RACE START.
- Do not manually shift to a lower gear to brake the vehicle.
- If possible, do not depress the accelerator pedal past the point of resistance (kickdown).

After 1,000 miles (1,500 km), you can increase the engine speed gradually and bring the vehicle to full speed.

- i** You should also observe these breaking-in notes if your vehicle's engine or transmission has been replaced.
- i** Always observe the respective speed limits.

Driving

Important safety notes

WARNING

Objects in the driver's footwell can restrict the pedal travel or obstruct a depressed pedal. The operating and road safety of the vehicle is jeopardized. There is a risk of an accident.

Make sure that all objects in the vehicle are stowed correctly, and that they cannot enter the driver's footwell. Install the floormats securely and as specified in order to ensure sufficient clearance for the pedals. Do not use loose floormats and do not place floormats on top of one another.

WARNING

If you switch off the ignition while driving, safety-relevant functions are only available with limitations, or not at all. This could affect, for example, the power steering and the brake boosting effect. You will require considerably more effort to steer and brake. There is a risk of an accident.

Do not switch off the ignition while driving.

! Warm up the engine quickly. Do not use the engine's full performance until it has reached operating temperature. The operating temperature has been reached when the engine oil temperature display in the on-board computer's AMG menu no longer flashes.

Only shift into reverse gear when the vehicle is stationary.

Where possible, avoid spinning the drive wheels when pulling away on slippery roads. You could otherwise damage the drive train.

! During a cold start with low engine oil temperatures (below 32 °F) (0 °C), the maximum engine speed is restricted in order to protect the engine. To protect the engine and maintain smooth engine operation, avoid driving at full throttle when the engine is cold.

Key positions

KEYLESS-GO start function

You can switch the engine on and off with the Start/Stop button. For this, the SmartKey must be inside the vehicle. The Start/Stop button is located in the center console and is illuminated when the vehicle is unlocked.

Pressing the Start/Stop button several times in succession corresponds to the different key positions in the ignition lock. This is only the case if you are not depressing the brake pedal.

If you depress the brake pedal and press the Start/Stop button, the engine starts immediately.

If there is a SmartKey in the ignition lock, this takes precedence over the KEYLESS-GO start function.

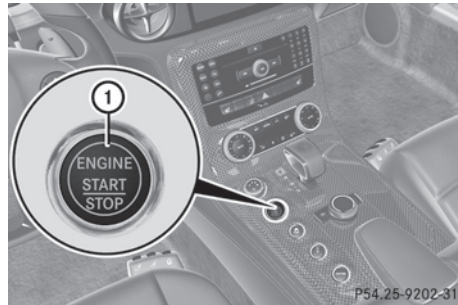

- ▶ **Position 0:** if Start/Stop button ① has not yet been pressed, this corresponds to the SmartKey being removed from the ignition.
- ▶ **Position 1:** press Start/Stop button ①. You can now activate the windshield wipers, for example.

If you press Start/Stop button ① twice when in this position and the driver's door is open, the power supply is deactivated again.

- ▶ **Position 2 (ignition):** press Start/Stop button ① twice.

The power supply is switched off again if:

- you press Start/Stop button ① once when in this position
- the driver's door is open

SmartKey

You can also start the vehicle with the SmartKey in the ignition lock.

The ignition lock is located in the rear stowage space of the center console.

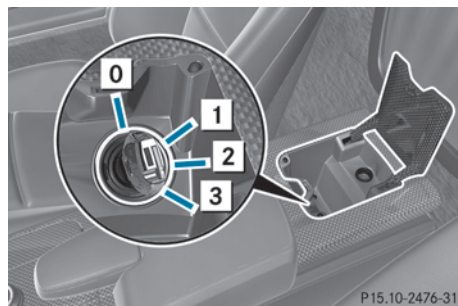

- 0 To remove the SmartKey
 - 1 Power supply for some consumers, such as the windshield wipers
 - 2 Ignition (power supply for all consumers) and drive position
 - 3 To start the engine
- i** The SmartKey can be turned in the ignition lock even if it is not the correct SmartKey for the vehicle. The ignition is not switched on. The engine cannot be started.

Starting the engine

Important safety notes

WARNING

If children are left unsupervised in the vehicle, they could:

- open the doors, thus endangering other people or road users.
- get out and disrupt traffic.
- operate the vehicle's equipment.

Additionally, children could set the vehicle in motion if, for example, they:

- release the parking brake.
- shifting the automatic transmission out of park position **P**
- Start the engine.

There is a risk of an accident and injury.

When leaving the vehicle, always take the SmartKey with you and lock the vehicle. Never leave children or animals unattended in the vehicle. Always keep the SmartKey out of reach of children.

WARNING

Combustion engines emit poisonous exhaust gases such as carbon monoxide. Inhaling these exhaust gases leads to poisoning. There is a risk of fatal injury. Therefore never leave the engine running in enclosed spaces without sufficient ventilation.

- i** Do not depress the accelerator pedal when starting the engine.

Starting procedure with the Start/Stop button

- i** The Start/Stop button can be used to start the vehicle without inserting the SmartKey into the ignition lock. You merely need to carry the SmartKey on your person.
- ▶ Depress the brake pedal and keep it depressed.
 - ▶ Press the Start/Stop button once (▷ page 111).
The engine starts.

Starting procedure with the SmartKey

If the Start/Stop button is inoperative, you can also start the vehicle using the SmartKey in the ignition lock.

- ▶ Turn the SmartKey to position **3** in the ignition lock (▷ page 111) and release it as soon as the engine is running.

Pulling away

AMG SPEEDSHIFT DCT 7-speed sports transmission

WARNING

If the engine speed is above the idling speed and you engage transmission position **D** or **R**, the vehicle could pull away suddenly. There is a risk of an accident.

When engaging transmission position **D** or **R**, always firmly depress the brake pedal and do not simultaneously accelerate.

- i** It is only possible to shift the transmission from position **P** to the desired position, if:
- the engine is running and
 - you depress the brake pedal
- Only then is the parking lock released. If the brake pedal is not depressed, the E-SELECT

lever can still be moved but the parking lock remains engaged.

- ▶ Depress the brake pedal and keep it depressed.
 - ▶ Use the E-SELECT lever to shift the transmission to position **D** or **R**.
 - ▶ Release the brake pedal.
 - ▶ Carefully depress the accelerator pedal. The electric parking brake is automatically released (▷ page 126).
- i** The vehicle locks centrally once you have pulled away. The locking knobs in the doors drop down.

Hill start assist

Hill start assist will aid you when pulling away on a hill. It holds the vehicle for a short time after you have removed your foot from the brake pedal. This gives you enough time to move your foot from the brake pedal to the accelerator pedal and depress it before the vehicle begins to roll.

⚠ WARNING

After a short time, hill start assist will no longer brake your vehicle and it could roll away. There is a risk of an accident and injury. Therefore, quickly move your foot from the brake pedal to the accelerator pedal. Never leave the vehicle when it is held by hill start assist.

- ▶ Take your foot off the brake pedal.
- i** Once you have taken your foot off the brake pedal, the vehicle is held for around one second.
- ▶ Pull away.

Hill start assist is not active if:

- you are pulling away on a level road or on a downhill gradient.
- the transmission is in position **N**.
- the vehicle is secured with the electric parking brake.
- ESP® is malfunctioning.

AMG SPEEDSHIFT DCT 7-speed sports transmission

Important safety notes

⚠ WARNING

If the engine speed is above the idling speed and you engage transmission position **D** or **R**, the vehicle could pull away suddenly. There is a risk of an accident.

When engaging transmission position **D** or **R**, always firmly depress the brake pedal and do not simultaneously accelerate.

Observe the "Important safety notes" section on activating/deactivating ESP®(▷ page 56).

E-SELECT selector lever

Overview of transmission positions

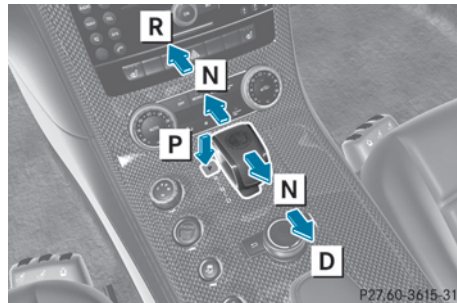

- P** Park position with parking lock
- R** Reverse gear
- N** Neutral
- D** Drive

! If the engine speed is too high or if the vehicle is rolling, do not shift the transmission directly from **D** to **R**, from **R** to **D** or directly to **P**.

Do not open the driver's door while the vehicle is in motion. At low speeds in transmission position **D** or **R**, park position **P** is otherwise engaged automatically. The transmission could be damaged.

i The E-SELECT lever always returns to its original position.

The current transmission position **P**, **R**, **N** or **D** appears in the transmission position display in the multifunction display.

If you wish to select a transmission position or to disengage park position **P**, the engine must be running.

Engaging park position P

- ▶ When the vehicle is stationary, depress the brake pedal.
- ▶ Press the **P** button in the center console.

i Park position **P** is disengaged if you:

- depress the brake pedal and
- push the E-SELECT lever forwards or back to the first point of resistance

The transmission shifts to neutral **N**.

To shift directly from **P** to **R**:

- ▶ Depress the brake pedal and push the E-SELECT lever forwards past the first point of resistance.

To shift directly from **P** to **D**:

- ▶ Depress the brake pedal and push the E-SELECT lever back past the first point of resistance.

Engaging park position P automatically

Park position is engaged automatically in the following circumstances:

- if you switch off the engine using the Start/Stop button and open the driver's or front-passenger door.
- if you remove the SmartKey from the ignition lock.
- if you open the door while traveling at low speed in transmission position **D** or **R**.

Shifting to neutral N

- ▶ When the vehicle is stationary, depress the brake pedal.
- ▶ Push the E-SELECT lever forwards or back to the first point of resistance.

i If you move the E-SELECT lever to **N** before switching off the engine, the transmission remains in **N** for approximately 30 minutes. If you open the driver's or front-passenger door during this period, the transmission automatically shifts to **P**.

The transmission remains in **N** if:

- the SmartKey is in the ignition lock and
- you use the E-SELECT lever to shift the transmission to **N** before switching the engine off

This still applies if you open the driver's or front-passenger door.

Further information is available in the "Car wash" section (▷ page 207).

Engaging reverse gear R

- ▶ When the vehicle is stationary, depress the brake pedal.
- ▶ Push the E-SELECT lever forward past the first point of resistance.

Shifting to transmission position D

- ▶ When the vehicle is stationary, depress the brake pedal.
- ▶ Push the E-SELECT lever back past the first point of resistance.

Transmission position and drive program display

Display in transmission positions P, R and N

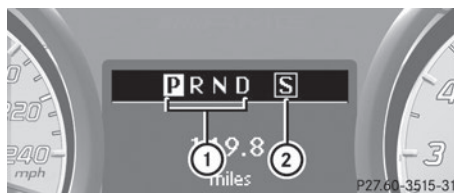

- ① Transmission position: currently selected transmission position is displayed in inverted colors
- ② Drive program (**C/S/S+/M**)

In addition to drive program ② being shown in the multifunction display, the currently selected drive program is indicated in red on the drive program selector switch.

In temporary manual drive program, the last active drive program ② and the selected gear ① appear in the multifunction display. For further information on the temporary manual drive program, see (▷ page 118).

Display when in transmission position D

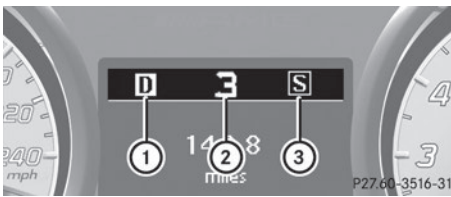

- ① Transmission position
- ② Gear
- ③ Drive program (C/S/S+)

When you have selected drive program **C**, **S** or **S+**, the transmission position is displayed in position ①. The selected gear is displayed in position ②.

Display when in transmission position D and manual drive program M



- ① Gear
- ② Drive program (M)

Display when in transmission position D and temporary manual drive program

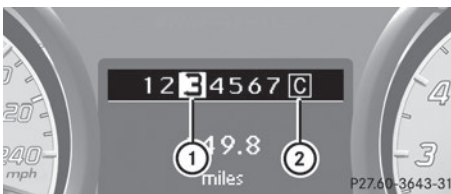

- ① Gear
- ② Drive program (C/S/S+)

Transmission positions

P

Park position

Do not shift the transmission into position **P** unless the vehicle is stationary. The parking lock should not be used as a brake when parking. Always apply the electronic parking brake in addition to the parking lock in order to secure the vehicle.

In the event of a malfunction of the vehicle's electronics, the transmission may lock in position **P**.

Have the vehicle electronics checked at a qualified specialist workshop, e.g. an authorized Mercedes-Benz Center, immediately.

R

Reverse gear

Only shift the transmission to **R** when the vehicle is stationary.

N**Neutral**

No power is transmitted from the engine to the drive wheels.

Releasing the brakes will allow you to move the vehicle freely, e.g. to push it.

Do not shift the transmission to **N** while driving. The transmission could otherwise be damaged.

If ESP® is deactivated or faulty: only shift the transmission to position **N** if the vehicle is in danger of skidding, e.g. on icy roads.

D**Drive**

The transmission shifts into drive programs (C/S/S+) automatically. All forward gears are available.

Changing gear

The transmission shifts into individual gears automatically. This is determined by:

- drive position **D**
- the selected drive program (**C/S/S+**)
- the position of the accelerator pedal
- the road speed

The shift points primarily depend on:

- the position of the accelerator pedal
Little throttle: early upshifts; high throttle: late upshifts
- the driving dynamics

A dynamic driving style with high longitudinal and lateral acceleration delays the shift points to higher engine speeds.

Driving tips**Double-clutch function**

When shifting down, the double-clutch function is active regardless of the currently selected drive program. The double-clutch function reduces the load change reaction on

the drive axle. The sound generated by the double-clutch function and its characteristics depend on the drive program selected.

Kickdown

i Kickdown is not available in manual drive program **M**.

Use kickdown for maximum acceleration:

- In the automatic drive programs, depress the accelerator pedal beyond the pressure point.
Depending on the selected drive program, the transmission shifts to the lowest gear permissible to give optimal acceleration.

Drive program selector

With the drive program selector switch, you can choose from a range of different transmission configurations or select the RACE START drive mode.



Drive program	Characteristic
C Controlled Efficiency	Comfort-oriented, optimum-economy engine and transmission settings
S Sport	Sporty engine and transmission settings
S+ SportPlus	Extremely sporty engine and transmission settings
M Manual	Manual gear shifting

Drive program	Characteristic
Driving mode	
RS RACE START	Optimal vehicle acceleration from a standstill

► Turn drive program selector switch ① until the desired drive program is shown in the multifunction display.

i In addition to the drive program being shown in the multifunction display, the currently selected drive program is indicated in red on the drive program selector switch.

i **RS** cannot be selected during normal driving. For further information on RACE START, see (► page 117).

Steering wheel paddle shifters

In manual drive program **M**, you need to change gear yourself using the steering wheel paddle shifters. The transmission shifts down automatically at low engine speeds.

For further information on manual drive program **M**(► page 120).

For further information on the temporary manual drive program, see (► page 118).

i In manual drive program **M** and temporary manual drive program, the transmission shift and response times are significantly shorter. The gear changes are sportier and more aggressive.

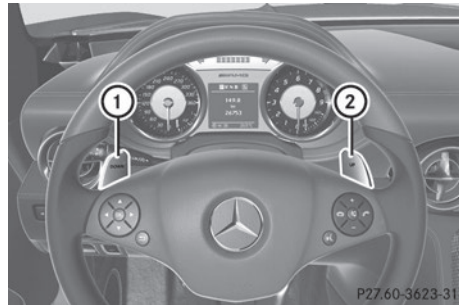

- ① Left steering wheel paddle shifter (DOWN): shift down
- ② Right steering wheel paddle shifter (UP): shift up

RACE START

RACE START enables optimal acceleration from a standing start under suitable high-grip road surface conditions.

RACE START is intended solely for activation on dedicated race circuits.

Conditions for activation

You can activate RACE START if:

- the doors are closed.
- the engine is running and the engine and transmission are at operating temperature. (► page 148)
- SPORT handling mode is switched on. (► page 56)
- the steering wheel is in the straight-ahead position.
- the vehicle is stationary and the brake pedal is depressed (left foot).
- the transmission is set to **D**.

Activating RACE START

- ▶ Depress the brake pedal with your left foot and keep it depressed.
- ▶ Turn the drive program selector switch clockwise (▷ page 116) until the **RS** indicator on the switch lights up in red. The multifunction display shows the message **RACE START Confirm: Paddle UP Cancel: Paddle DOWN**.
- ❗ If the conditions for activation are not fulfilled, RACE START is canceled. The **RACE START Not Possible** message appears in the multifunction display.
- ▶ **To cancel:** pull the left-hand steering wheel paddle shifter (DOWN) (▷ page 117). The multifunction display shows the **RACE START Canceled** message.
- ▶ **To confirm:** pull the right-hand steering wheel paddle shifter (UP) (▷ page 117). The **RACE START Available Depress gas pedal** message appears in the multifunction display.
- ❗ If you do not depress the accelerator pedal within a few seconds, RACE START is canceled. The multifunction display shows the **RACE START Canceled** message.
- ▶ Fully depress the accelerator pedal. The engine speed is increased. The **RACE START Release brake to start** message appears in the multifunction display.
- ❗ If you do not release the brake pedal within a few seconds, RACE START is canceled. The multifunction display shows the **RACE START Canceled** message.
- ▶ Take your foot off the brake pedal while keeping the accelerator pedal fully depressed. The vehicle pulls away at maximum acceleration. The **RACE START Active** message appears in the multifunction display.

RACE START is deactivated when the vehicle reaches a speed of approximately 30 mph

(50 km/h). Drive program **S+** is activated. SPORT handling mode remains switched on. RACE START is deactivated immediately if you release the accelerator pedal during RACE START or if any of the activation conditions are no longer fulfilled. The **RACE START Not Possible** or **RACE START Canceled** message appears in the multifunction display.

- ❗ If RACE START is used repeatedly within a short period of time, it is only available again after the vehicle has been driven a certain distance.

Automatic drive program

Automatic drive programs C, S and S+

Drive program **C** is characterized by the following:

- comfort-oriented engine and transmission settings
- optimal fuel consumption resulting from the transmission shifting up sooner
- the vehicle pulling away more gently in forward and reverse gears, unless the accelerator pedal is depressed fully
- increased sensitivity. This improves driving stability on slippery road surfaces, for example
- the transmission shifting up sooner; This results in the vehicle being driven at lower engine speeds and the wheels being less likely to spin

Drive programs **S** and **S+** are characterized by the following:

- sporty engine and transmission settings
- the transmission shifting up later and shifting down dynamically
- as a result of the later transmission upshifts, the fuel consumption may be higher
- if a period of dynamic driving is followed by an extended phase with a constant accelerator pedal position, the vehicle

shifts up to a higher gear. This optimizes fuel consumption

- i** In drive program **S+** the transmission shift and response times are significantly shorter with more aggressive gear changes. This is particularly the case when shifting up. The shift strategy in drive program **S+** is thus designed to interact dynamically with the high-revving engine.

If a gentle driving style is adopted in automatic drive programs **C/S/S+**, the drive program settings are adjusted to optimize fuel consumption. Depending on the operating conditions, the transmission shifts to a higher gear.

Temporary manual drive program

General notes

You can activate temporary manual drive program in automatic drive programs **C**, **S** and **S+**. In temporary manual drive program, you can briefly change gear yourself by using the steering wheel paddle shifters. The transmission must be in position **D**.

- i** In temporary manual drive program, the transmission shifts and response times are significantly shorter with sportier and more aggressive gear changes.

Activating

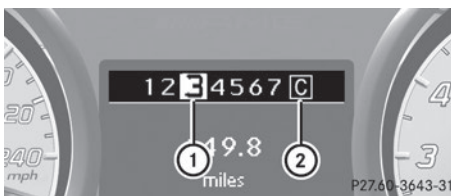

- ▶ Shift the transmission to position **D**.
- ▶ Pull the left or right steering wheel paddle shifter (▷ page 117). Temporary manual drive program is temporarily activated. The last active drive program **②** and the selected gear **①** appear in the multifunction display.

Shifting gears

If you pull on the left or right steering wheel paddle shifter, the automatic transmission switches to temporary manual drive program for a limited amount of time. Depending on which paddle shifter is pulled, the automatic transmission immediately shifts into the next gear down or up, if permitted.

- ▶ **To shift up:** pull the right-hand steering wheel paddle shifter (▷ page 117). The automatic transmission shifts up to the next gear.

- i** If the maximum engine speed is reached in the currently engaged gear and you continue to accelerate:

- the automatic transmission automatically shifts up in order to prevent engine damage
- the downshift override is displayed

- ▶ **To shift down:** pull on the left-hand steering wheel paddle shifter (▷ page 117). The automatic transmission shifts down to the next gear.

- i** If the engine exceeds the maximum engine speed when shifting down, the automatic transmission protects against engine damage by not shifting down.

- i** Automatic down shifting occurs when coasting.

- i** When using kickdown, the automatic transmission automatically shifts into a lower gear.

Deactivating

If you have activated temporary manual drive program, it will remain active for a certain amount of time. Under certain conditions the minimum amount of time is extended, e.g. in the case of lateral acceleration, during an overrun phase or when driving on steep terrain.

You can also deactivate temporary manual drive program yourself:

- ▶ Pull on the right-hand steering wheel paddle shifter and hold it in place (▷ page 117).
- or
- ▶ Turn the drive program selector (▷ page 116).
Temporary manual drive program is deactivated.

Display for downshift override



You cannot shift down with the left steering wheel paddle shifter if the engine speed would be too high due to a downshift. If you then pull the left steering wheel paddle shifter, both red segments ① light up briefly.

- ❗ In temporary manual drive program, the automatic transmission automatically shifts up in order to prevent engine damage. The segments in the upshift indicator are thus deactivated. Further information on the upshift indicator (▷ page 120).

Manual drive program

- ❗ In manual drive program **M**, the transmission shift and response times are significantly shorter with sportier and more aggressive gear changes.

In manual drive program **M**, you need to change gear yourself using the steering wheel paddle shifters (▷ page 117). The

transmission only shifts down automatically at low engine speeds depending on the respective gear.

- ❗ In manual drive program **M**, the transmission does not shift up automatically even when the engine limiting speed for the current gear is reached. When the engine limiting speed is reached, the fuel supply is cut to prevent the engine from overrevving. Always make sure that the engine speed does not reach the red area of the tachometer and observe the upshift indicator. There is otherwise a risk of engine damage.

- ▶ **To activate manual drive program M:** turn the drive program selector switch until **M** appears in the multifunction display of the instrument cluster. **M** lights up in red on the drive program selector switch.
- ▶ **To deactivate manual drive program M:** turn the drive program selector switch and select another drive program.

Upshift indicator

The upshift indicator is a four-stage display designed to assist you in sporty driving.

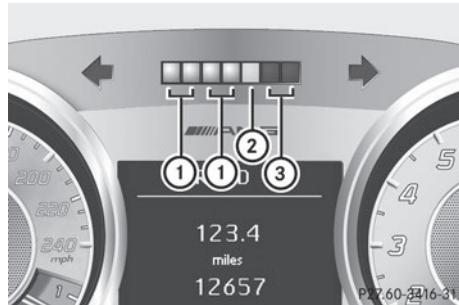

The upshift indicator allows you to recognize the ideal shift point for dynamic acceleration. White segments ① and yellow segment ② light up in succession from left to right.

When red segments ③ light up and the "up" message appears in the multifunction display, the ideal shift point has been reached:

▶ Shift up using the right-hand steering wheel paddle shifter (UP) as quickly as possible. The vehicle shifts up to the next gear.

❗ If you continue to increase the engine speed without shifting up in time, the fuel supply is shut off to protect the engine. This results in abruptly reduced acceleration.

Display for downshift override

You cannot shift down with the left steering wheel paddle shifter if the engine speed is too high due to a downshift. If you then pull the left steering wheel paddle shifter, both red segments ③ light up briefly.

AMG button (SETUP)

With the AMG button, you can call up and store a default drive program setting and the default suspension tuning.



- ▶ **To store:** press and hold AMG button ① until you hear a tone.
- ▶ **To call up:** press AMG button ①. The stored drive program is selected.
- ▶ **To display:** briefly press AMG button ①. The multifunction display shows the SETUP in the AMG menu (▷ page 148).

Refueling

Important safety notes

⚠ WARNING

Fuel is highly flammable. If you handle fuel incorrectly, there is a risk of fire and explosion.

You must avoid fire, open flames, creating sparks and smoking. Switch off the engine and, if applicable, the auxiliary heating before refueling.

⚠ WARNING

Fuel is poisonous and hazardous to health. There is a risk of injury.

You must make sure that fuel does not come into contact with your skin, eyes or clothing and that it is not swallowed. Do not inhale fuel vapors. Keep fuel away from children.

If you or others come into contact with fuel, observe the following:

- Wash away fuel from skin immediately using soap and water.
- If fuel comes into contact with your eyes, immediately rinse them thoroughly with clean water. Seek medical assistance without delay.
- If fuel is swallowed, seek medical assistance without delay. Do not induce vomiting.
- Immediately change out of clothing which has come into contact with fuel.

⚠ WARNING

Electrostatic buildup can create sparks and ignite fuel vapors. There is a risk of fire and explosion.

Always touch the vehicle body before opening the fuel filler flap or touching the fuel pump nozzle. Any existing electrostatic buildup is thereby discharged.

❗ Do not use diesel to refuel vehicles with a gasoline engine. Do not switch on the ignition if you accidentally refuel with the

wrong fuel. Otherwise, the fuel will enter the fuel system. Even small amounts of the wrong fuel could result in damage to the fuel system and the engine. Notify a qualified specialist workshop and have the fuel tank and fuel lines drained completely.

- ❗ Overfilling the fuel tank could damage the fuel system.
- ❗ Take care not to spill any fuel on painted surfaces. You could otherwise damage the paintwork.
- ❗ Use a filter when refueling from a fuel can. Otherwise, the fuel lines and/or injection system could be blocked by particles from the fuel can.

If you overfill the fuel tank, fuel could spray out when the fuel pump nozzle is removed. Further information on fuel and on fuel grades can be found in the "Fuel" section (▷ page 264).

Refueling

Fuel filler flap

When you open or close the vehicle with the SmartKey, the fuel filler flap is automatically unlocked or locked.

The fuel filler flap is located to the rear on the right. The position of the fuel filler cap is displayed in the instrument cluster . The arrow next to the filling pump indicates the side of the vehicle.

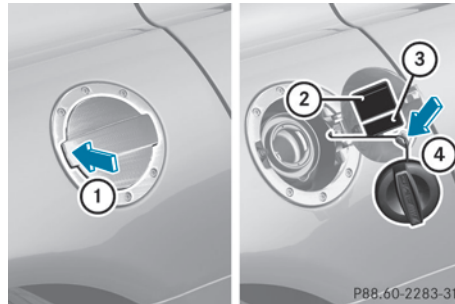

- ① To open the fuel filler flap
- ② Tire pressure table
- ③ Fuel type
- ④ To insert the fuel filler cap

Opening

- ▶ Switch off the engine.

i When the engine is running and the fuel filler flap is open, the engine diagnostics warning lamp  may light up.

Further information can be found in the "Warning and indicator lamps in the instrument cluster" chapter (▷ page 181).

- ▶ Open the driver's door. This switches the ignition to position **0**, which corresponds to having removed the SmartKey. The driver's door can be closed again.
- ▶ Press the fuel filler flap in the direction of arrow ①. The fuel filler flap opens slightly.
- ▶ Open the fuel filler flap.
- ▶ Turn the fuel filler cap counter-clockwise and remove it.
- ▶ Insert the fuel filler cap into the holder bracket on the inside of filler flap ④.
- ▶ Completely insert the fuel pump nozzle into the filler neck and refuel.
- ▶ Only fill the tank until the pump nozzle switches off.

❗ Overfilling the fuel tank could damage the fuel system.

Closing

- ▶ Replace the fuel filler cap and turn it clockwise. The fuel filler cap audibly engages.
- ▶ Close the fuel filler flap.

Problems with fuel and the fuel tank

Problem	Possible causes/consequences and ► Solutions
Fuel is leaking from the vehicle.	<p> Risk of explosion or fire</p> <p>The fuel line or the fuel tank is defective.</p> <ul style="list-style-type: none"> ► Set the Start/Stop button to key position 0 immediately. ► Do not restart the engine under any circumstances. ► Consult a qualified specialist workshop.
The fuel filler flap cannot be opened.	<p>The fuel filler flap is not unlocked.</p> <p>or</p> <p>The SmartKey battery is discharged.</p> <ul style="list-style-type: none"> ► Unlock the vehicle (▷ page 68). <p>or</p> <ul style="list-style-type: none"> ► Unlock the vehicle using the mechanical key (▷ page 69).
	<p>The fuel filler flap is unlocked, but the opening mechanism is jammed.</p> <ul style="list-style-type: none"> ► Consult a qualified specialist workshop.

Parking

Important safety notes

 **WARNING**

Flammable material such as leaves, grass or twigs may ignite if they come into contact with hot parts of the exhaust system or exhaust gas flow. There is a risk of fire.

Park the vehicle so that no flammable materials come into contact with parts of the vehicle which are hot. Take particular care not to park on dry grassland or harvested grain fields.

 **WARNING**

If you leave children unsupervised in the vehicle, they could set it in motion by, for example:

- release the parking brake.
- shift the automatic transmission out of the parking position **P**.
- start the engine.

In addition, they may operate vehicle equipment and become trapped. There is a risk of an accident and injury.

When leaving the vehicle, always take the SmartKey with you and lock the vehicle. Never leave children unsupervised in the vehicle.

-  If the engine speed is too high or if the vehicle is rolling, do not shift the transmission directly from **D** to **R**, from **R** to **D** or directly to **P**.

Do not open the driver's door while the vehicle is in motion. At low speeds in transmission position **D** or **R**, park position **P** is otherwise engaged automatically.

The transmission could be damaged.

-  Always secure the vehicle correctly against rolling away. Otherwise, the vehicle or its drivetrain could be damaged.

To ensure that the vehicle is secured against rolling away unintentionally:

- the electric parking brake must be applied.
- the transmission must be in position **P**.
- the SmartKey must be in position **O** in the ignition lock and then removed from the ignition lock, or the Start/Stop button must be pressed.
- on steep uphill or downhill gradients, turn the front wheels towards the curb.
- on steep uphill or downhill gradients, the front axle of an empty vehicle must be secured, for example with a wheel chock.
- on steep uphill or downhill gradients, the rear axle of a laden vehicle must be additionally secured, for example with a wheel chock.

Switching off the engine

Important safety notes

WARNING

When the engine is switched off, the transmission shifts into neutral position **N**. The vehicle may roll away. There is a risk of an accident.

After switching off the engine, always switch to parking position **P**. Prevent the parked vehicle from rolling away by applying the parking brake.

- ❗ Do not open the driver's door while the vehicle is in motion. At low speeds in transmission position **D** or **R**, park position **P** is otherwise engaged automatically. This can damage the transmission.

- i Observe the display messages in the instrument cluster (> page 151).

AMG SPEEDSHIFT DCT 7-speed sports transmission

- ▶ Shift the transmission to **P** with the button in the center console.

Using the Start/Stop button

- ▶ Press the Start/Stop button (> page 111). The engine stops and all the indicator lamps in the instrument cluster go out.

- ▶ Apply the electric parking brake.

- i The engine can be turned off while the vehicle is in motion by pressing and holding the Start/Stop button for about three seconds.

- i If you switch the engine off with the transmission in position **R** or **D**, the transmission automatically shifts to **N**.

If you move the E-SELECT lever to **N** before switching off the engine, the transmission remains in **N** for approximately 30 minutes.

If you open the driver's or front-passenger door during this period, the transmission automatically shifts to **P**.

Using the SmartKey

- ❗ Do not remove the SmartKey while the vehicle is in motion. Otherwise, at low speeds, parking lock **P** will be activated automatically.

Do not open the driver's door while the vehicle is in motion. At low speeds, transmission position **P** is engaged automatically.

This could cause damage to the transmission and the parking lock.

- ▶ Turn the SmartKey to position **O** in the ignition lock and remove it. The parking lock is activated.
- ▶ Apply the electric parking brake.

- i If you move the E-SELECT lever to **N** before switching off the engine, the transmission remains in **N** for approximately 30 minutes. If you open the driver's or front-passenger door during this period, the transmission automatically shifts to **P**.

The transmission remains in **N** if:

- the SmartKey is in the ignition lock and
- you use the E-SELECT lever to shift the transmission to **N** before switching the engine off

This still applies if you open the driver's or front-passenger door.

Further information on transmission position **N** when operating with a SmartKey is available in the "Car wash" section (> page 207).

Electric parking brake

General notes

WARNING

If you leave children unsupervised in the vehicle, they could set it in motion by, for example:

- release the parking brake.
- shift the automatic transmission out of the parking position **P**.
- start the engine.

In addition, they may operate vehicle equipment and become trapped. There is a risk of an accident and injury.

When leaving the vehicle, always take the SmartKey with you and lock the vehicle. Never leave children unsupervised in the vehicle.



Applying/releasing manually

- ▶ **To engage:** push handle ①.

When the electric parking brake is engaged, the red **PARK** (USA only) or  (Canada only) indicator lamp lights up in the instrument cluster.

- ① The electric parking brake can also be applied when the SmartKey is in position **0**.

- ▶ Pull handle ①.

The red **PARK** (USA only) or  (Canada only) indicator lamp in the instrument cluster goes out.

- ① The electric parking brake can only then be released when the ignition is switched on using the Start/Stop button.

Releasing the electric parking brake automatically

The electric parking brake is released automatically when the following conditions are simultaneously fulfilled:

- the engine is running.
- the transmission is in position **D** or **R**.
- the hood is closed.
- your seat belt is fastened.
- you accelerate.

If the transmission is in position **R**, the trunk lid must be closed.

If your seat belt is not fastened, the following conditions must be fulfilled to automatically release the electric parking brake:

- the driver's door is closed.
- you have shifted out of **P** or you have previously driven faster than 2 mph (3 km/h).

Emergency braking

The vehicle can also be braked during an emergency by using the electric parking brake.

▶ While driving, push handle ① of the electric parking brake (▷ page 126).

i The vehicle is braked as long as you keep the handle of the electric parking brake pressed. The longer the electric parking brake handle is depressed, the greater the braking force.

During braking:

- a warning tone sounds
- the **Release Parking Brake** message appears
- the red **PARK** (USA only) or **(P)** (Canada only) indicator lamp in the instrument cluster appears.

When the vehicle has been braked to a standstill, the electric parking brake is engaged.

Parking the vehicle for a long period

If you leave the vehicle parked for longer than four weeks, the battery may be damaged by exhaustive discharging.

If you leave the vehicle parked up for longer than six weeks, the vehicle may suffer damage as a result of lack of use.

▶ Visit a qualified specialist workshop and seek advice.

i You can obtain information about trickle chargers from a qualified specialist workshop.

Driving tips

General driving tips

Important safety notes

⚠ WARNING

If you switch off the ignition while driving, safety-relevant functions are only available with limitations, or not at all. This could affect, for example, the power steering and the brake boosting effect. You will require considerably

more effort to steer and brake. There is a risk of an accident.

Do not switch off the ignition while driving.

⚠ WARNING

If you operate mobile communication equipment while driving, you will be distracted from traffic conditions. You could also lose control of the vehicle. There is a risk of an accident.

Only operate this equipment when the vehicle is stationary.

Observe the legal requirements for the country in which you are driving. Some jurisdictions prohibit the driver from using a mobile phone while driving a vehicle.

If you make a call while driving, always use hands-free mode. Only operate the telephone when the traffic situation permits. If you are unsure, pull over to a safe location and stop before operating the telephone.

Bear in mind that at a speed of only 30 mph (approximately 50 km/h), the vehicle covers a distance of 44 ft (approximately 14 m) per second.

Drive sensibly – save fuel

Observe the following tips to save fuel:

- ▶ The tires should always be inflated to the recommended tire pressure.
- ▶ Remove unnecessary loads.
- ▶ Warm up the engine at low engine speeds.
- ▶ Avoid frequent acceleration or braking.
- ▶ Have all maintenance work carried out according to the service intervals listed in the Maintenance Booklet or the service interval display.

Fuel consumption also increases when driving in cold weather, in stop-start traffic and in hilly terrain.

Drinking and driving

WARNING

Drinking and driving and/or taking drugs and driving are very dangerous combinations. Even a small amount of alcohol or drugs can affect your reflexes, perceptions and judgment.

The possibility of a serious or even fatal accident is greatly increased when you drink or take drugs and drive.

Do not drink or take drugs and drive or allow anyone to drive who has been drinking or taking drugs.

Emission control

WARNING

Combustion engines emit poisonous exhaust gases such as carbon monoxide. Inhaling these exhaust gases leads to poisoning. There is a risk of fatal injury. Therefore never leave the engine running in enclosed spaces without sufficient ventilation.

Certain engine systems are designed to keep the level of poisonous components in exhaust fumes within legal limits.

These systems only work at peak efficiency if they are serviced exactly in accordance with the manufacturer's specifications. For this reason, all work on the engine must be carried out by qualified and authorized Mercedes-Benz technicians.

The engine settings must not be changed under any circumstances. Furthermore, all specific service work must be carried out at regular intervals and in accordance with the Mercedes-Benz service requirements. Details can be found in the Maintenance Booklet.

Braking

Important safety notes

WARNING

If you shift down on a slippery road surface in an attempt to increase the engine's braking effect, the drive wheels could lose their grip. There is an increased danger of skidding and accidents.

Do not shift down for additional engine braking on a slippery road surface.

Heavy and light loads

WARNING

If you rest your foot on the brake pedal while driving, the braking system can overheat. This increases the stopping distance and can even cause the braking system to fail. There is a risk of an accident.

Never use the brake pedal as a footrest. Never depress the brake pedal and the accelerator pedal at the same time.

 Depressing the brake pedal constantly results in excessive and premature wear to the brake pads.

If the brakes have been subjected to a heavy load, do not stop the vehicle immediately. Drive on for a short while. This allows the airflow to cool the brakes more quickly.

Wet roads

If you have driven for a long time in heavy rain without braking, there may be a delayed reaction from the brakes when braking for the first time. This may also occur after the vehicle has been washed or driven through deep water.

You have to depress the brake pedal more firmly. Maintain a greater distance from the vehicle in front.

After driving on a wet road or having the vehicle washed, brake firmly while paying attention to the traffic conditions. This will

warm up the brake discs, thereby drying them more quickly and protecting them against corrosion.

Limited braking performance on salt-treated roads

If you drive on salted roads, a layer of salt residue may form on the brake discs and brake pads. This can result in a significantly longer braking distance.

- Brake occasionally to remove any possible salt residue. Make sure that you do not endanger other road users when doing so.
- Carefully depress the brake pedal at the beginning and end of a journey.
- Maintain a greater distance to the vehicle ahead.

Servicing the brakes

! If the red brake warning lamp lights up in the instrument cluster and you hear a warning tone while the engine is running, the brake fluid level may be too low. Observe additional warning messages in the multifunction display.

The brake fluid level may be too low due to brake pad wear or leaking brake lines.

Have the brake system checked immediately. This work should be carried out at a qualified specialist workshop.

! As the ESP® system operates automatically, the engine and the ignition must be switched off (the SmartKey must be in position **0** or **1** in the ignition lock or the Start/Stop button must be in position **0** or **1**) if:

- the electric parking brake is tested using a brake dynamometer.
- the vehicle is towed with one axle raised.

Braking triggered automatically by ESP® may seriously damage the brake system.

All checks and maintenance work on the brake system must be carried out at a qualified specialist workshop. Have this work

carried out at an authorized Mercedes-Benz Center.

Have the brake pads replaced and the brake fluid renewed at a qualified specialist workshop, e.g. an authorized Mercedes-Benz Center.

If the brake system has only been subject to moderate loads, you should test the functionality of your brakes at regular intervals. To do so, press firmly on the brake pedal when driving at a high speed. This improves the grip of the brake pads.

You can find a description of Brake Assist (BAS) on (> page 55).

Mercedes-Benz recommends that you only have brake pads/linings installed on your vehicle which have been approved for Mercedes-Benz vehicles or which correspond to an equivalent quality standard. Brake pads/linings which have not been approved for Mercedes-Benz vehicles or which are not of an equivalent quality could affect your vehicle's operating safety.

Mercedes-Benz recommends that you only use brake fluid that has been specially approved for your vehicle by Mercedes-Benz, or which corresponds to an equivalent quality standard. Brake fluid which has not been approved for Mercedes-Benz vehicles or which is not of an equivalent quality could affect your vehicle's operating safety.

AMG high-performance composite brake system

WARNING

In wet conditions or after washing the vehicle, there may be a delayed reaction from the high performance brake pads of the ceramic brake system. There is a risk of an accident.

Drive with particular care in wet conditions and after washing the vehicle. If necessary, depress the brake pedal more firmly.

The performance-optimized brake pads can produce increased noise during brake application.

The AMG ceramic high-performance composite brake system is designed for heavy loads. This may lead to noise when braking. This will depend on:

- Speed
- Braking force
- Environmental conditions, such as temperature and humidity

The wear of individual components of the brake system, such as the brake pads/linings or brake discs, depends on the individual driving style and operating conditions.

For this reason, it is impossible to state a mileage that will be valid under all circumstances. An aggressive driving style will lead to high wear. You can obtain further information about this from your authorized Mercedes-Benz Center.

New and replaced brake pads and discs only reach their optimum braking effect after several hundred kilometers of driving. Compensate for this by applying greater force to the brake pedal. Keep this in mind, and adapt your driving and braking accordingly during this break-in period.

Excessive heavy braking results in correspondingly high brake wear. Observe the brake wear warning lamp in the instrument cluster and note any brake status messages in the multifunction display. Especially for high performance driving, it is important to maintain and have the brake system checked regularly.

Driving on wet roads

Hydroplaning

If water has accumulated to a certain depth on the road surface, there is a danger of hydroplaning occurring, even if:

- you drive at low speeds.
- the tires have adequate tread depth.

For this reason, in the event of heavy rain or in conditions in which hydroplaning may occur, you must drive in the following manner:

- lower your speed.
- avoid ruts.
- brake carefully.

Driving on flooded roads

- ❗ Do not drive through flooded areas. Check the depth of any water before driving through it. Drive slowly through standing water. Otherwise, water may enter the vehicle interior or the engine compartment. This can damage the electronic components in the engine or the automatic transmission. Water can also be drawn in by the engine's air suction nozzles and this can cause engine damage.

Winter driving

WARNING

If you shift down on a slippery road surface in an attempt to increase the engine's braking effect, the drive wheels could lose their grip. There is an increased danger of skidding and accidents.

Do not shift down for additional engine braking on a slippery road surface.

DANGER

If the exhaust pipe is blocked or adequate ventilation is not possible, poisonous gases such as carbon monoxide (CO) may enter the vehicle. This is the case, e.g. if the vehicle becomes trapped in snow. There is a risk of fatal injury.

If you leave the engine or the auxiliary heating running, make sure the exhaust pipe and area around the vehicle are clear of snow. To ensure an adequate supply of fresh air, open a window on the side of the vehicle that is not facing into the wind.

At the onset of winter, have your vehicle winterized at a qualified specialist workshop, e.g. at an authorized Mercedes-Benz Center. Drive particularly carefully on slippery road surfaces. Avoid sudden acceleration, steering and braking maneuvers. Do not use cruise control.

If the vehicle threatens to skid or cannot be stopped when moving at low speed:

- ▶ Shift the transmission to position **N**.

The outside temperature indicator is not designed to serve as an ice-warning device and is therefore unsuitable for that purpose. Changes in the outside temperature are displayed after a short delay.

Indicated temperatures just above the freezing point do not guarantee that the road surface is free of ice. The road may still be icy, especially in wooded areas or on bridges. You should pay special attention to road conditions when temperatures are around the freezing point.

For more information on driving with snow chains, see (> page 235).

For more information on driving with summer tires, see (> page 234).

Observe the notes in the "Winter operation" section (> page 234).

Driving systems

Cruise control

Important safety notes

Cruise control maintains a constant road speed for you. It brakes automatically in order to avoid exceeding the set speed.

On long and steep downhill gradients, especially if the vehicle is laden, you must select a lower gear in good time. By doing so, you will make use of the braking effect of the engine. This relieves the load on the brake system and prevents the brakes from overheating and wearing too quickly.

If you fail to adapt your driving style, cruise control can neither reduce the risk of an accident nor override the laws of physics. Cruise control cannot take into account the road, traffic and weather conditions. Cruise control is only an aid. You are responsible for the distance to the vehicle in front, for vehicle speed, for braking in good time and for staying in your lane.

Use cruise control only if road and traffic conditions make it appropriate to maintain a steady speed for a prolonged period. You can set any road speed above 20 mph (30 km/h).

Do not use cruise control:

- in road and traffic conditions which do not allow you to maintain a constant speed e.g. in heavy traffic or on winding roads
- on slippery road surfaces. Braking or accelerating could cause the drive wheels to lose traction and the vehicle could then skid
- when there is poor visibility, e.g. due to fog, heavy rain or snow

If there is a change of drivers, advise the new driver of the speed stored.

Cruise control lever

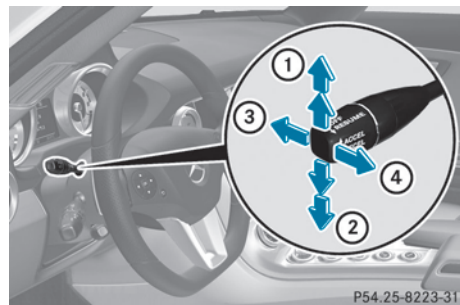

- ① To store the current speed or a higher speed
- ② To store the current speed or a lower speed
- ③ To deactivate cruise control
- ④ To store the current speed or call up the last stored speed

When you activate cruise control, the stored speed is shown in the lower section of the multifunction display.

Storing and maintaining the current speed

You can store the current speed if you are driving faster than 20 mph (30 km/h).

- ▶ Accelerate the vehicle to the desired speed.
- ▶ Briefly press the cruise control lever up ① or down ② to the pressure point.
- ▶ Remove your foot from the accelerator pedal.

Cruise control is activated. The vehicle automatically maintains the stored speed.

- i** Cruise control may be unable to maintain the stored speed on uphill gradients. The stored speed is resumed when the gradient evens out. Cruise control maintains the stored speed on downhill gradients by automatically applying the brakes.

Storing the current speed or calling up the last stored speed

WARNING

If you call up the stored speed and it differs from the current speed, the vehicle accelerates or decelerates. If you do not know the stored speed, the vehicle could accelerate or brake unexpectedly. There is a risk of an accident.

Pay attention to the road and traffic conditions before calling up the stored speed. If you do not know the stored speed, store the desired speed again.

- ▶ Briefly pull the cruise control lever towards you ④.
- ▶ Remove your foot from the accelerator pedal.
The first time cruise control is activated, it stores the current speed or regulates the

speed of the vehicle to the previously stored speed.

Setting a speed

Keep in mind that it may take a brief moment until the vehicle has accelerated or braked to the speed set.

- ▶ Press the cruise control lever to the pressure point, up ① for a higher speed or down ② for a lower speed.
- ▶ Keep the cruise control lever pressed until the desired speed is reached.
- ▶ Release the cruise control lever.
The new speed is stored.

- i** Cruise control is not deactivated if you depress the accelerator pedal. For example, if you accelerate briefly to overtake, cruise control adjusts the vehicle's speed to the last speed stored after you have finished overtaking.

Making adjustments in 1 mph increments

- ▶ Briefly press the cruise control lever to the pressure point, up ① for a higher speed or down ② for a lower speed.
The last speed stored is increased or reduced.

Making adjustments in 10 mph increments

- ▶ Briefly press the cruise control lever beyond the pressure point, up ① for a higher speed or down ② for a lower speed.
The last speed stored is increased or reduced.

Deactivating cruise control

There are several ways to deactivate cruise control:

- ▶ Briefly press the cruise control lever forwards ③.

or

- ▶ Brake.

Cruise control is automatically deactivated if:

- you press the electric parking brake handle.
- you are driving below 20 mph (30 km/h).
- ESP® intervenes or you deactivate ESP®
- you shift the transmission to **N** while the vehicle is in motion.

If cruise control is deactivated, you will hear a warning tone. The "Cruise Control Off" message is displayed in the multifunction display for approximately five seconds.

- ❗ The last speed stored is cleared when you switch off the engine.

AMG adaptive sport suspension system

General notes

The electronically controlled damping system works continuously. This improves driving safety and ride comfort.

The damping is tuned individually to each wheel and depends on:

- your driving style, e.g. sporty
- the road surface condition, e.g. bumps
- your individual selection of Sport or Sport +

- ❗ If you select Sport + mode and restart the engine, the mode reverts to Sport.

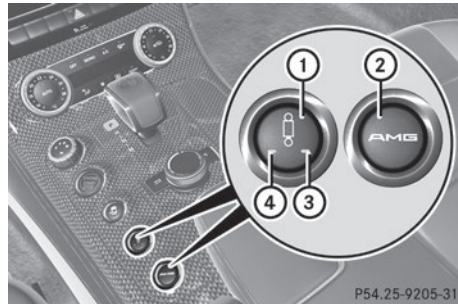

Sport mode

The firmer suspension tuning in Sport mode ensures even better contact with the road. Select this mode when employing a sporty driving style, e.g. on winding country roads.

- ▶ Press button ① once.
Indicator lamp ④ lights up. You have selected Sport mode.
The **AMG Ride Control SPORT** message appears in the multifunction display.

- ❗ Sport mode is the standard setting.
Indicator lamp ④ cannot be switched off.

Sport + mode

The very firm setting of the suspension tuning in Sport + mode ensures the best possible contact with the road. Select this mode only when driving on race circuits.

If indicator lamps ③ and ④ are off:

- ▶ Press button ① twice.
Indicator lamps ③ and ④ light up. You have selected Sport + mode.
The **AMG Ride Control SPORT +** message appears in the multifunction display.

If indicator lamp ④ lights up:

- ▶ Press button ① once.
Second indicator lamp ③ lights up. You have selected Sport + mode.
The **AMG Ride Control SPORT +** message appears in the multifunction display.

Storing and calling up settings

Once the suspension tuning and drive program have been selected, you can store and call up your settings using AMG button ②.

- ▶ **To store:** press AMG button ② until you hear a tone.
- ▶ **To call up:** press AMG button ②.
The stored suspension tuning and drive program are selected.
- ▶ **To display:** briefly press AMG button ②.
Your selection appears in the multifunction display.

Blind Spot Assist

General notes

Blind Spot Assist uses a radar sensor system to monitor the areas on both sides of your vehicle. It supports you from a speed of approximately 20 mph (30 km/h). A warning display in the exterior mirrors draws your attention to vehicles detected in the monitored area. If you then switch on the corresponding turn signal to change lanes, you will also receive a visual and audible collision warning. For this purpose, Blind Spot Assist uses sensors in the rear bumper.

Important safety notes

Blind Spot Assist is only an aid. It may fail to detect some vehicles and is no substitute for attentive driving.

WARNING

Blind Spot Assist does not react to:

- vehicles overtaken too closely on the side, placing them in the blind spot area
- vehicles which approach with a large speed differential and overtake your vehicle

As a result, Blind Spot Assist may not give warnings in such situations. There is a risk of an accident.

Always observe the traffic conditions carefully, and maintain a safe lateral distance.

USA only:

This device has been approved by the FCC as a "Vehicular Radar System". The radar sensor is intended for use in an automotive radar system only. Removing, tampering with, or altering the device will void any warranties, and is not permitted by the FCC. Do not tamper with, alter, or use in any non-approved way.

Any unauthorized modification to this device could void the user's authority to operate the equipment.

Monitoring range of the sensors

In particular, the detection of obstacles can be impaired if:

- dirt on the sensors or anything else covering the sensors
- there is poor visibility, e.g. due to fog, heavy rain or snow
- a narrow vehicle traveling in front, e.g. a motorbike or bicycle
- the road has very wide lanes
- the road has narrow lanes
- you are not driving in the middle of the lane
- there are barriers or similar lane borders

Vehicles in the monitoring range are then not indicated.

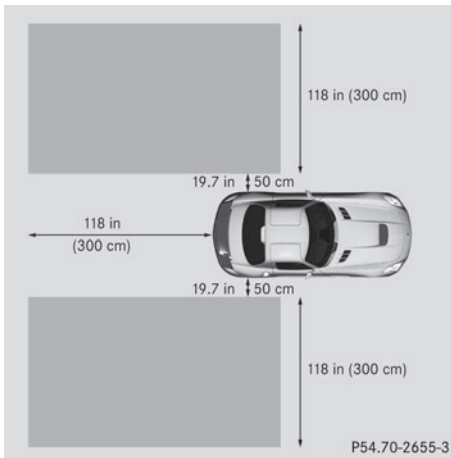

Blind Spot Assist monitors the area up to 10 ft (3 m) behind your vehicle and directly next to your vehicle, as shown in the diagram. If the lanes are narrow, vehicles driving in the lane beyond the lane next to your vehicle may be indicated, especially if the vehicles are not driving in the middle of their lane. This may be the case if the vehicles are driving on the inner side of their lane.

Due to the nature of the system:

- warnings may be issued in error when driving close to crash barriers or similar solid lane borders.
- warnings may be interrupted when driving alongside particularly long vehicles, e.g. trucks, for a prolonged time.

The two sensors for Blind Spot Assist are integrated into the sides of the rear bumper. Make sure that the bumper is free of dirt, ice or slush in the vicinity of the sensors. The radar sensors must not be covered, e.g. by overhanging loads. Following a severe impact or in the event of damage to the bumpers, have the function of the radar sensors checked at a qualified specialist workshop. Blind Spot Assist may otherwise not work properly.

Indicator and warning display



① Yellow indicator lamp/red warning lamp

When Blind Spot Assist is activated, indicator lamp ① in the exterior mirrors lights up yellow up to a speed of 20 mph (30 km/h). At speeds above 20 mph (30 km/h), the indicator lamp goes out and Blind Spot Assist is operational.

If a vehicle is detected within the blind spot monitoring range at speeds above 20 mph (30 km/h), warning lamp ① on the corresponding side lights up red. This warning is always given when a vehicle enters the blind spot monitoring range from behind or from the side. When you overtake a vehicle, the warning only occurs if the difference in speed is less than 7 mph (12 km/h).

The yellow indicator lamp goes out if reverse gear is engaged. In this event, Blind Spot Assist is no longer active.

The brightness of the indicator/warning lamps is adjusted automatically according to the ambient light.

Collision warning

If a vehicle is detected in the monitoring range of Blind Spot Assist and you switch on the corresponding turn signal, a double warning tone sounds. Red warning lamp ① flashes. If the turn signal remains on, vehicles detected are indicated by the flashing of red warning lamp ①. There are no further warning tones.

Switching on Blind Spot Assist

- ▶ Make sure that Blind Spot Assist (▷ page 145) is activated in the on-board computer.
- ▶ Ensure that key position **2** has been selected with the Start/Stop button. Warning lamps ① in the exterior mirrors light up red for approximately 1.5 seconds and then turn yellow.

Useful information	138
Important safety notes	138
Displays and operation	138
Menus and submenus	140
Display messages	151
Warning and indicator lamps in the instrument cluster	176

Useful information

- i** This Operator's Manual describes all models and all standard and optional equipment of your vehicle available at the time of publication of the Operator's Manual. Country-specific differences are possible. Please note that your vehicle may not be equipped with all features described. This also applies to safety-related systems and functions.
- i** Please read the information on qualified specialist workshops (▷ page 21).

Important safety notes

You will find an illustration of the instrument cluster in the "At a glance" section (▷ page 27).

WARNING

If you operate information systems and communication equipment integrated in the vehicle while driving, you will be distracted from traffic conditions. You could also lose control of the vehicle. There is a risk of an accident.

Only operate the equipment when the traffic situation permits. If you are not sure that this is possible, park the vehicle paying attention to traffic conditions and operate the equipment when the vehicle is stationary.

WARNING

If the instrument cluster has failed or malfunctioned, you may not recognize function restrictions in systems relevant to safety. The operating safety of your vehicle may be impaired. There is a risk of an accident.

Drive on carefully. Have the vehicle checked at a qualified specialist workshop immediately.

You must observe the legal requirements for the country in which you are currently driving when operating the on-board computer.

The on-board computer only shows messages or warnings from certain systems in the multifunction display. You should therefore make sure your vehicle is operating safely at all times. Otherwise, a vehicle that is not operating safely may cause an accident.

Displays and operation

Engine oil temperature display

The engine oil temperature gauge is in the instrument cluster on the right-hand side. Under normal operating conditions, the temperature may rise to 140 °C.

The transmission fluid temperature and the coolant temperature are displayed in the AMG menu (▷ page 148).

Tachometer

The red band in the tachometer indicates the engine's overrevving range.

! Do not drive in the overrevving range, as this could damage the engine.

The fuel supply is interrupted to protect the engine when the red band is reached.

Outside temperature display

You should pay special attention to road conditions when temperatures are around freezing point.

The outside temperature display is in the multifunction display (▷ page 140).

Changes in the outside temperature are displayed after a short delay.

Operating the on-board computer

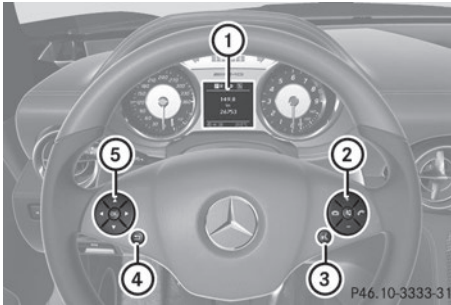

- ① Multifunction display
- ② Switches on the Voice Control System; see the separate operating instructions
- ③ Right control panel
- ④ Left control panel
- ⑤ Back button

► **To activate the on-board computer:** turn the SmartKey to position **1** in the ignition lock.

You can control the multifunction display and the settings in the on-board computer using the buttons on the multifunction steering wheel.

	• Calls up the menu and menu bar
	Press briefly:
	<ul style="list-style-type: none"> • Scrolls in lists • Selects a submenu or function • In the Audio menu: selects a stored station, an audio track or a video scene • In the Tel (telephone) menu: switches to the phone book and selects a name or telephone number

	Press and hold:
	<ul style="list-style-type: none"> • In the Audio menu: selects the previous/next station or selects an audio track or a video scene using rapid scrolling • In the Tel (telephone) menu: starts rapid scrolling through the phone book
	<ul style="list-style-type: none"> • Confirms a selection/display message • In the Tel (Telephone) menu: switches to the telephone book and starts dialing the selected number • In the Audio menu: stops the station search function at the desired station

Right control panel

	<ul style="list-style-type: none"> • Rejects or ends a call • Exits phone book/redial memory
	<ul style="list-style-type: none"> • Makes or accepts a call • Switches to the redial memory
	• Adjusts the volume
	• Mute

Back button**Press briefly:**

- Back
- Switches off the Voice Control System; see the separate operating instructions
- Hides display messages/calls up the last **Trip** menu function used
- Exits the telephone book/redial memory

**Press and hold:**

- Calls up the standard display in the **Trip** menu

Multifunction display

Values and settings as well as display messages are shown in the multifunction display.

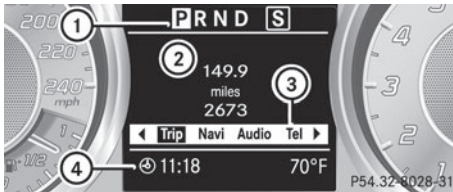

- ① Selector lever position/shift range and drive program
 - ② Text field
 - ③ Menu bar
 - ④ Status line with time and outside temperature
- ▶ **To show menu bar**③: press the ◀ or ▶ button on the steering wheel.

Menus and submenus**Menu overview**

Press the ◀ or ▶ button on the steering wheel to call up the menu bar and select a menu.

Operating the on-board computer (▷ page 139).

Depending on the equipment installed in the vehicle, you can call up the following menus:

- **Trip** menu (▷ page 140)
- **Navi** menu (navigation instructions) (▷ page 141)
- **Audio** menu (▷ page 142)
- **Tel** menu (telephone) (▷ page 144)
- **DriveAssist** menu (assistance) (▷ page 145)
- **Service** menu (▷ page 145)
- **Settings** menu (▷ page 145)
- **AMG** menu (▷ page 148)

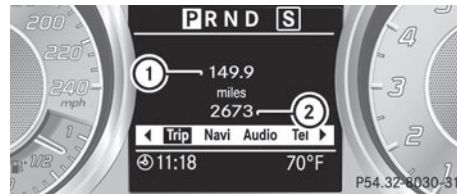
Trip menu**Standard display**

- ▶ Press and hold the ◀ button on the steering wheel until the **Trip** menu with trip odometer ① and odometer ② is shown.

Digital speedometer

- ▶ Press the ◀ or ▶ button on the steering wheel to select the **Trip** menu.
- ▶ Press the ▲ or ▼ button to select the digital speedometer.

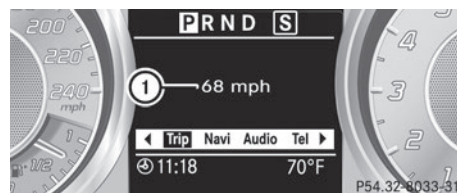

- ① Digital speedometer

Trip computer "From Start" or "From Reset"

The values in the **From Start** submenu are calculated from the start of a journey whilst the values in the **From Reset** submenu are calculated from the last time the submenu was reset.

- ▶ Press the ◀ or ▶ button on the steering wheel to select the **Trip** menu.
- ▶ Press the ▲ or ▼ button to select **From Start** or **From Reset**.

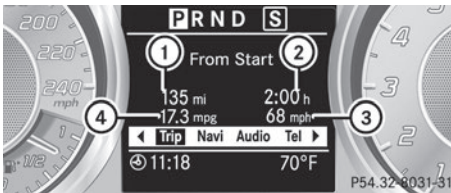

Example: trip computer "From Start"

- ① Distance
- ② Time
- ③ Average speed
- ④ Average fuel consumption

The **From Start** trip computer is automatically reset if:

- the ignition has been switched off for more than four hours.
- 999 hours have been exceeded.
- 9,999 miles have been exceeded.

The **From Reset** trip computer is automatically reset if the value exceeds 9,999 hours or 99,999 miles.

Calling up the range

- ▶ Press the ◀ or ▶ button on the steering wheel to select the **Trip** menu.

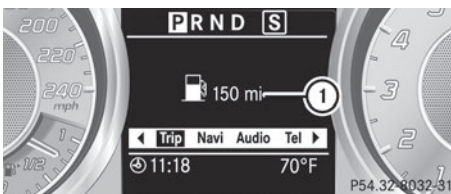

- ▶ Press ▲ or ▼ to select approximate range ①.

Approximate range ① is calculated according to the current driving style and the amount of fuel in the tank. If there is only half of the reserve fuel left in the fuel tank, then instead of range ①, the display shows a vehicle being refueled .

Navigation system menu

Displaying navigation instructions

In the **Navi** menu, the multifunction display shows navigation instructions. You can find further information in the separate COMAND operating instructions.

- ▶ Press the ◀ or ▶ button on the steering wheel to select the **Navi** menu.

Route guidance not active

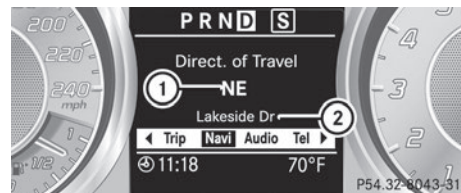

Example: direction of travel display

- ① Direction of travel
- ② Current road

Route guidance active

No change of direction announced

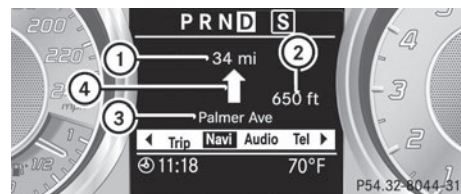

- ① Distance to the destination
- ② Distance to the next change of direction

- ③ Current road
- ④ Symbol for "follow the road's course"

Change of direction announced without a lane recommendation

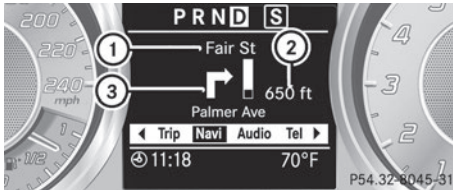

- ① Road into which the change of direction leads
- ② Distance to change of direction and visual distance display
- ③ Symbol for change of direction

When a change of direction is announced, you will see symbol ③ for the change of direction and distance graphic ②. The distance indicator shortens towards the top of the display as you approach the point of the announced change of direction.

Change of direction announced with a lane recommendation

Lane recommendations are only displayed if the relevant data is available on the digital map.

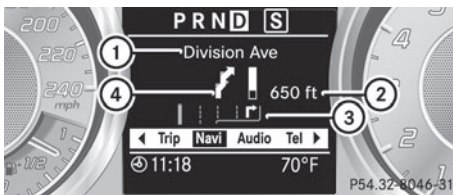

- ① Road into which the change of direction leads
- ② Distance to change of direction and visual distance display
- ③ Lane recommendation
- ④ Symbol for change of direction

On multilane roads, the system can display lane recommendation ③ for the next change

of direction. During the change of direction, additional lanes may be displayed.

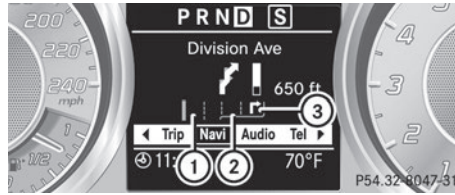

Lane recommendation display (example)

- ① Uninterrupted lane
- ② New lane during a change of direction
- ③ Lane recommended for the change of direction

You can find further information on lane recommendation in the separate COMAND operating instructions.

Other status indicators of the navigation system

- : you have reached the destination.
- **New Route...** or **Calculating Route:** calculating a new route
- **Off Map** or **Off Mapped Road:** the vehicle position is outside the area of the digital map (off-map position).
- **No Route:** no route could be calculated to the selected destination.

You can find further information on status indicators in the separate COMAND operating instructions.

Audio menu

Selecting a radio station

You can only change the waveband and store new stations using COMAND.

- ▶ Press the or button on the steering wheel to select the **Audio** menu.



① Waveband

② Station³

▶ **To select a stored station:** briefly press the or button.

▶ **To select a station from the station list:** press and hold the or button.

▶ **To select a station using manual tuning** (only when a station list is not received): press and hold or .

i SIRIUS XM satellite radio functions like a normal radio.

You can find further information on operating the satellite radio in the separate operating instructions.

Operating an audio player or audio media

Audio data from various audio devices or media can be played, depending on the equipment installed in the vehicle.

▶ Press the or button on the steering wheel to select the **Audio** menu.

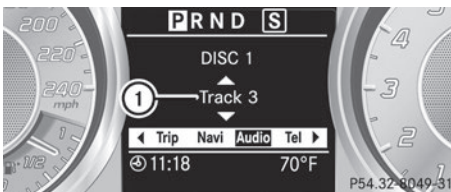

CD player display (example)

① Current title

▶ **To select the next/previous track:** briefly press the or button.

▶ **To select a track from the track list (rapid scrolling):** press and hold the or button until desired track has been reached.

If track information is stored on the audio device or medium, the multifunction display will show the number and name of the track. The current track does not appear in audio AUX mode (**A**uxiliary audio mode: external audio source connected).

Video DVD operation

▶ Press the or button on the steering wheel to select the **Audio** menu.

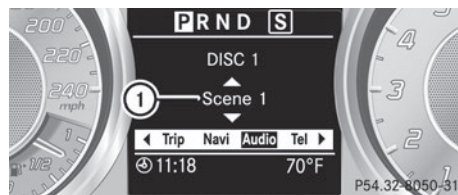

▶ **To select the next or previous scene:** briefly press the or button.

▶ **To select a scene from the scene list (rapid scrolling):** press and hold the or button until desired scene has been reached.

Telephone menu

Introduction

WARNING

If you operate information systems and communication equipment integrated in the vehicle while driving, you will be distracted from traffic conditions. You could also lose control of the vehicle. There is a risk of an accident.

Only operate the equipment when the traffic situation permits. If you are not sure that this

³ If the station has been stored, the memory position will also be displayed.

is possible, park the vehicle paying attention to traffic conditions and operate the equipment when the vehicle is stationary.

When telephoning, you must observe the legal requirements for the country in which you are currently driving.

Functions and displays are dependent on the optional equipment installed in your vehicle.

You can establish a Bluetooth® connection to COMAND (see the separate operating instructions).

- ▶ Switch on the mobile phone and COMAND.
- ▶ Press the ◀ or ▶ button on the steering wheel to select the **Te1** menu.

You will see one of the following display messages in the multifunction display:

- **Enter PIN:** the mobile phone has been placed in the mobile phone bracket and the PIN has not been entered.
- ▶ Enter the PIN using the mobile phone, Voice Control System or COMAND. The mobile phone will search for a network. In the meantime, the **Phone No Service** display message appears in the multifunction display.
- **Phone Ready** or the name of the network provider: the mobile phone has found a network and is ready to receive.
- **Phone No Service:** there is no network available or the mobile phone is searching for a network.

Accepting a call

If someone calls you when you are in the **Te1** menu, a display message appears in the multifunction display, for example:

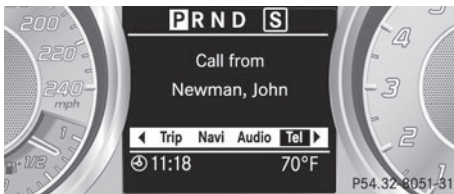

- ▶ Press the  button on the steering wheel to accept an incoming call.

You can accept a call even if you are not in the **Te1** menu.

Rejecting or ending a call

- ▶ Press the  button on the steering wheel.

You can end or reject a call even if you are not in the **Te1** menu.

Dialing an entry from the phone book

If your mobile phone is able to receive calls, you can search for and dial a number from the phone book in COMAND at any time.



- ▶ Copy the phone book from the mobile phone to COMAND.
- ▶ Press the ◀ or ▶ button on the steering wheel to select the **Te1** menu.
- ▶ Press the ▲, ▼ or OK button to switch to the phone book.
- ▶ Press the ▲ or ▼ button to select the name you want. To scroll rapidly, press and hold the ▲ or ▼ button for longer than one second. After a short time, the rapid scroll speeds up.

Rapid scrolling stops when you release the button or reach the end of the list.

- ▶ **If only one telephone number is stored for a name:** press the  or OK button to start dialing.







or

- ▶ **If there is more than one number for a particular name:** press the  or OK button to display the numbers.
- ▶ Press the ▲ or ▼ button to select the phone number you want.

- ▶ Press the  or **OK** button to start dialing.
- or
- ▶ **If you do not want to make a call:** press the  button.

Redialing



The on-board computer saves the last names or numbers dialed in the redial memory.

- ▶ Press the  or  button on the steering wheel to select the **Te** menu.
- ▶ Press the  button to switch to the redial memory.
- ▶ Press the  or  button to select the desired name or number.
- ▶ Press the  or **OK** button to start dialing.

Assistance menu

Activating/deactivating Blind Spot Assist

You can use the **Blind Spot Asst.** function to activate or deactivate Blind Spot Assist (▷ page 134).

- ▶ Press the  or  button on the steering wheel to select the **DriveAssist** menu.
- ▶ Press the **OK** button.
The current selection is displayed.
- ▶ **To activate/deactivate:** press the **OK** button again.

Maintenance menu



In the **Serv.** menu, you can:

- call up display messages (▷ page 152)
- check the tire pressure electronically (▷ page 238)
- call up the service due date (▷ page 206)

Settings menu

Introduction

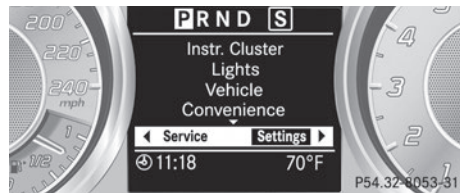

In the **Settings** menu you can:

- change the instrument cluster settings (▷ page 145)
- change the light settings (▷ page 146)
- change the vehicle settings (▷ page 147)
- change the convenience settings (▷ page 147)
- restore the factory settings (▷ page 148)









Instrument cluster

Selecting the unit of measurement for distance

The **Display Unit Speed-/Odometer:** function allows you to choose whether certain displays appear in km/h or mph in the multifunction display.









The selected units apply to:

- the odometer and the trip odometer
- the trip computer
- the digital speedometer in the **Trip** menu
- the digital speedometer in the **AMG** menu
- the navigation instructions in the **Navi** menu
- cruise control

- ▶ Press the  or  button on the steering wheel to select the **Settings** menu.
- ▶ Press the  or  button to select the **INST. CLUSTER** submenu.
- ▶ Press  to confirm.
- ▶ Press the  or  button to select the **Display Unit Speed-/Odometer:** function.
You will see the selected setting: **km** or **miles**.
- ▶ Press the  button to save the setting.

Permanent display for outside temperature or additional speedometer

The **Permanent Display: Outside Temperature/Speedometer** allows you to choose whether the multifunction display shows the outside temperature or the speed at the bottom right. The unit used in the additional speedometer depends on the display unit set (▷ page 145).

- ▶ Press the  or  button on the steering wheel to select the **Settings** menu.
- ▶ Press the  or  button to select the **Inst. cluster** submenu.
- ▶ Press  to confirm.
- ▶ Press the  or  button to select the **Permanent Display** function.
You will see the selected setting **Speedometer [km/h]** or **Speedometer [mph]** or **Outside Temperature**.
- ▶ Press the  button to save the setting.









Lights

Switching the daytime running lamps on/off

This function is not available in Canada.
If you have activated the **Lights:** function and the light switch is in the **AUTO** position, the daytime running lamps are switched on automatically when the engine is running. If it











is dark, the low-beam headlamps switch on automatically.

In the dark, the following also light up:

- the low-beam headlamps
 - the standing lamps
 - the tail lamps
 - the license plate lamp
 - the side marker lamps
- ▶ Press the  or  button on the steering wheel to select the **Settings** menu.
 - ▶ Press the  or  button to select the **LIGHTS** submenu.
 - ▶ Press  to confirm.
 - ▶ Press the  or  button to select the **Lights:** function.
You will see the selected setting: **Enabled** or **Disabled**.
 - ▶ Press the  button to save the setting.

Setting the brightness for the display and switches

You can use the **Brightness Display/Switches:** function to set the brightness of the multifunction display and the switches in the vehicle.

- ▶ Press the  or  button on the steering wheel to select the **Settings** menu.
- ▶ Press the  or  button to select the **LIGHTS** submenu.
- ▶ Press  to confirm.
- ▶ Press the  or  button to select the **Brightness Display/Switches:** function.
You see the selected setting **Level** with a value of between 0 and 100.
- ▶ Press the  button to save the setting.
- ▶ Press the  or  button to increase or decrease the brightness.

Activating/deactivating surround lighting and exterior lighting delayed switch-off

The **Locator Lighting**: function allows you to set whether the exterior lighting should come on when it is dark:

- for 40 seconds after unlocking the vehicle with the key.









The exterior lighting switches off if you open the driver's door.

- for 15 seconds after switching off the engine and closing the doors.

If the engine is switched off and no doors are opened, or if an open door is not closed, the exterior lighting goes out after 60 seconds.

If you activate the **Locator Lighting**: function, the following light up:

- the parking lamps
- the low-beam headlamps
- the license plate lamp
- the surround lighting in the exterior mirrors

- ▶ Press the  or  button on the steering wheel to select the **Settings** menu.
- ▶ Press the  or  button to select the **LIGHTS** submenu.
- ▶ Press  to confirm.
- ▶ Press the  or  button to select the **Locator Lighting**: function.
You will see the selected setting: **Enabled** or **Disabled**.
- ▶ Press the  button to save the setting.









Deactivating the delayed switch-off temporarily:

- ▶ Select key position **0** with the Start/Stop button before leaving the vehicle.
- ▶ Select key position **2** and then key position **0** again with the Start/Stop button
The delayed shut-off is deactivated.

The delayed shut-off is reactivated the next time you start the engine.

Activating/deactivating the interior lighting delayed switch-off

If you select key position **0** with the Start/Stop button when the **Light. delay** function is activated, the interior lighting lights up for approximately 20 seconds if it is dark.

- ▶ Press the  or  button on the steering wheel to select the **Settings** menu.
- ▶ Press the  or  button to select the **Light** submenu.
- ▶ Press  to confirm.
- ▶ Press the  or  button to select the **Light. delay** function.
You will see the selected setting: **on** or **off**.
- ▶ Press the  button to save the setting.

Convenience

Activating/deactivating the EASY-ENTRY/EXIT feature

WARNING







When the EASY-ENTRY/EXIT feature adjusts the steering wheel, you and other vehicle occupants – particularly children – could become trapped. There is a risk of injury.

While the EASY-ENTRY/EXIT feature is making adjustments, make sure that no one has any body parts in the sweep of the steering wheel.

If somebody becomes trapped:

- press one of the memory function position buttons, or
- move the switch for steering wheel adjustment in the opposite direction to that in which the steering wheel is moving.







The adjustment process is stopped.

- ▶ Press the  or  button on the steering wheel to select the **Settings** menu.
- ▶ Press the  or  button to select the **Convenience** submenu.
- ▶ Press **OK** to confirm.
- ▶ Press the  or  button to select the **Easy Entry/Exit** function.
You will see the selected setting: **Enabled** or **Disabled**.
- ▶ Press the **OK** button to save the setting.

Switching the fold-in mirrors with the locking feature on/off







If you switch on the **Fold Mirrors in when Locking** function, the exterior mirrors fold in when you lock the vehicle. If you unlock the vehicle and then open the driver's or front-passenger door, the exterior mirrors fold out again.

If you have switched the function on and you fold the exterior mirrors in using the button on the door (▶ page 85), they will not fold out automatically. The exterior mirrors can then only be folded out using the button on the door.

- ▶ Press the  or  button on the steering wheel to select the **Settings** menu.
- ▶ Press the  or  button to select the **CONVENIENCE** submenu.
- ▶ Press **OK** to confirm.
- ▶ Press the  or  button to select the **Fold Mirrors in when Locking** function.
You will see the selected setting: **Enabled** or **Disabled**.
- ▶ Press the **OK** button to save the setting.

Restoring the factory settings

For safety reasons, the **Lights**: function in the **LIGHTS** submenu is only reset if the vehicle is stationary.

- ▶ Press the  or  button on the steering wheel to select the **Settings** menu.
- ▶ Press the  or  button to select the **Factory Settings** submenu.
- ▶ Press **OK** to confirm.
The **Reset All Settings?** message appears.
- ▶ Press the  or  button to select **Yes** or **No**.
- ▶ Press the **OK** button to confirm the selection.
If you have selected **Yes**, the multifunction display shows a confirmation message.

AMG menu

AMG displays

- ▶ Press  or  on the steering wheel to select the **AMG** menu.

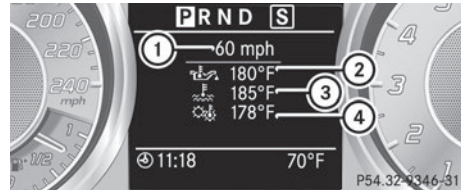

- ① Digital speedometer
- ② Engine oil temperature
- ③ Coolant temperature
- ④ Transmission fluid temperature

If the engine oil temperature is below 80 °C or if the transmission fluid temperature is below 60 °C, the corresponding temperature gauge flashes. Avoid driving at full engine output during this time.

SETUP

SETUP displays the drive program, the AMG adaptive sport suspension system setting and the selected traction assist.

- ▶ Press the or button on the steering wheel to select the **AMG** menu.
- ▶ Press the button repeatedly until **SETUP** is displayed.

or

▶ **Vehicles without AMG Performance**

Media: press the AMG button on the center console.

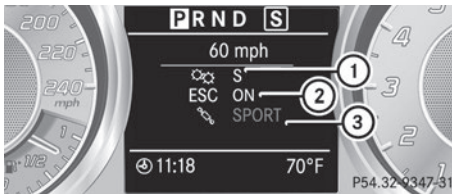

- ① Drive program (**C/S/S+/M**)
- ② ESP® mode (**ON/SPORT handling mode/OFF**)
- ③ AMG adaptive sport suspension system setting (**SPORT/SPORT +**)

RACETIMER

Displaying and starting RACETIMER

You can use the RACETIMER to store lap times.

- ▶ Press the or button on the steering wheel to select the **AMG** menu.
- ▶ Press the button repeatedly until the RACETIMER is shown.

i If the RACETIMER is selected, the and buttons are inoperative.

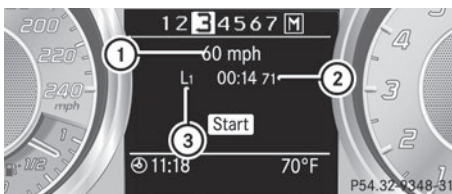

- ① Digital speedometer
- ② RACETIMER
- ③ Lap

You can start the RACETIMER when the engine is running or if key position **2** is selected with the Start/Stop button.

- ▶ **To start:** start the RACETIMER with .

Displaying the intermediate time



- ▶ Press the or button to select **Interm. Time**.
- ▶ Press to confirm.
The intermediate time is displayed for five seconds.

Starting a new lap

It is possible to store a maximum of sixteen laps.

- ▶ Press to confirm **New Lap**.

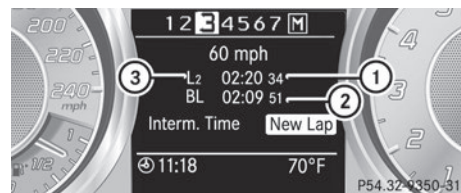

- ① RACETIMER
- ② Fastest lap time (best lap)
- ③ Lap

Stopping the RACETIMER

- ▶ Press the button on the steering wheel.



- ▶ Press to confirm **Yes**.

If you stop the vehicle and select key position **1** with the Start/Stop button, the RACETIMER interrupts timing. If you select key position **2** or **3** with the Start/Stop button and then press **[OK]** to select **START**, timing is continued.

Resetting the current lap

- ▶ Stop the RACETIMER.
- ▶ Press the **[◀]** or **[▶]** button to select **Reset Lap**.
- ▶ Press **[OK]** to reset the lap time to "0".

Deleting all laps

If you switch off the engine, the RACETIMER is reset to "0" after 30 seconds. All laps are deleted.

You cannot delete individual stored laps. If you have stopped 16 laps, the current lap does not have to be reset.

- ▶ Reset the current lap.
- ▶ Press **[OK]** to confirm **Reset**.
Reset Race Timer appears in the multifunction display.

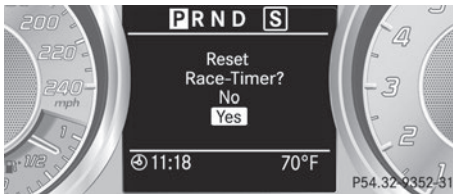

- ▶ Press the **[▼]** button to select **Yes** and press the **[OK]** button to confirm. All laps are deleted.

Overall statistics

This function is shown if you have stored at least one lap and stopped the RACETIMER.

- ▶ Press **[◀]** or **[▶]** on the steering wheel to select the **AMG** menu.
- ▶ Press the **[▲]** button repeatedly until the overall evaluation is shown.

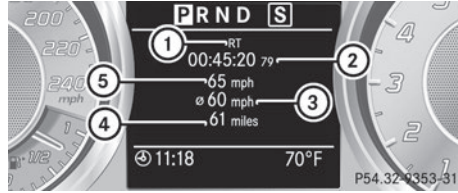

- ① RACETIMER overall evaluation
- ② Total time driven
- ③ Average speed
- ④ Distance covered
- ⑤ Maximum speed

Lap statistics

This function is only available if you have stored at least two laps and have stopped the RACETIMER.

- ▶ Press **[◀]** or **[▶]** on the steering wheel to select the **AMG** menu.
- ▶ Press the **[▲]** button repeatedly until the lap evaluation is shown. Each lap is shown in a separate submenu. The fastest lap is indicated by flashing symbol ①.

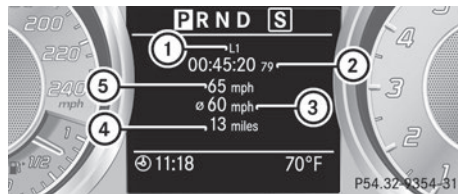

- ① Lap
 - ② Lap time
 - ③ Average lap speed
 - ④ Lap length
 - ⑤ Top speed during lap
- ▶ Press the **[▲]** or **[▼]** button to select a different lap evaluation.

Display messages

General notes

Display messages appear in the multifunction display.

Display messages with graphic displays may be shown in simplified form in the Operator's Manual and may therefore differ from the multifunction display.

Please respond in accordance with the display messages and follow the additional notes in this Operator's Manual.

Certain display messages are accompanied by an audible warning tone or a continuous tone.

When the ignition is switched off, all display messages are deleted, apart from some high-priority display messages. Once the causes of the high-priority display messages have been rectified, the corresponding display messages are also deleted.

When you stop and park the vehicle, please observe the notes on parking (▷ page 124).

Hiding display messages

- ▶ Press the or button on the steering wheel to hide the display message.
The display message is cleared.

The multifunction display shows high-priority display messages in red. Some high-priority display messages cannot be hidden.









The multifunction display shows these messages continuously until the causes for the messages have been remedied.









Message memory





The on-board computer saves certain display messages. You can call up the display messages in the **message memory**.





- ▶ Press the or button on the steering wheel to select the **Service** menu.
If there are display messages, the multifunction display shows **2 Messages**, for example.
- ▶ Press the or button to select the entry, e.g. **2 Messages**.
- ▶ Press to confirm.
- ▶ Press the or button to scroll through the display messages.







When the ignition is switched off, all display messages are deleted, apart from some high-priority display messages. Once the causes of the high-priority display messages have been rectified, the corresponding display messages are also deleted.

Braking	
Display messages	Possible causes/consequences and ► Solutions
<p>BRAKE (USA only)  (Canada only)</p> <p>ABS and ESC Currently Unavailable See Operator's Manual</p>	<p>ABS, ESP[®], BAS and hill start assist are temporarily unavailable. For example, the on-board voltage may be insufficient. In addition, the ,  and  warning lamps light up in the instrument cluster.</p> <p>The brake system continues to function normally, but without the functions listed above. The wheels could therefore lock if you brake hard, for example.</p> <p>▲ WARNING</p> <p>If the ABS malfunctions, the wheels may lock during hard braking. This limits the steerability of the vehicle when braking and may increase the braking distance. If ABS is deactivated due to a malfunction, BAS and ESP[®] are also deactivated. There is an increased risk of skidding and an accident.</p> <ul style="list-style-type: none"> ► Drive on carefully. ► Visit a qualified specialist workshop.
<p>BRAKE (USA only)  (Canada only)</p> <p>ABS and ESC Inoperative See Operator's Manual</p>	<p>ABS, ESP[®], BAS and hill start assist are unavailable due to a malfunction. In addition, the ,  and  warning lamps light up in the instrument cluster.</p> <p>The brake system continues to function normally, but without the functions listed above.</p> <p>▲ WARNING</p> <p>If the ABS malfunctions, the wheels may lock during hard braking. This limits the steerability of the vehicle when braking and may increase the braking distance. If ABS is deactivated due to a malfunction, BAS and ESP[®] are also deactivated. There is an increased risk of skidding and an accident.</p> <ul style="list-style-type: none"> ► Drive on carefully. ► Visit a qualified specialist workshop.

Display messages	Possible causes/consequences and ► Solutions
<p>BRAKE (USA only)  (Canada only)</p> <p>EBR, ABS, ESC Inoperative See Operator's Manual</p>	<p>EBD (electronic brake force distribution), ABS, ESP[®], BAS and hill start assist are not available due to a malfunction. In addition, the ,  and  warning lamps light up in the instrument cluster and a warning tone sounds.</p> <p>The brake system continues to function normally, but without the functions listed above.</p> <p> WARNING</p> <p>If EBD and ABS are malfunctioning, the rear wheels in particular could lock under braking. If ABS is deactivated due to a malfunction, BAS and ESP[®] are also deactivated. There is an increased risk of skidding and an accident.</p> <ul style="list-style-type: none"> ► Drive on carefully. ► Visit a qualified specialist workshop immediately.
<p>PARK (USA only)  (Canada only)</p> <p>Please Release Parking Brake</p>	<p> The indicator lamp (red) flashes and a warning tone sounds. You are driving with the electric parking brake applied.</p> <ul style="list-style-type: none"> ► Release the electric parking brake. <p>or</p> <ul style="list-style-type: none"> ► Consult a qualified specialist workshop. <p> The indicator lamp (red) flashes, the warning lamp (yellow) lights up and a warning tone sounds.</p> <p>The electric parking brake is malfunctioning and the braking effect is restricted.</p> <p>While the vehicle is in motion:</p> <ul style="list-style-type: none"> ► Release the electric parking brake handle. <p>While the vehicle is stationary:</p> <ul style="list-style-type: none"> ► Switch off the ignition and turn it back on. ► Release the electric parking brake. <p>If the display message continues to be displayed:</p> <ul style="list-style-type: none"> ► Shift the transmission to P with the button in the center console. ► Prevent the vehicle from rolling away before you leave it. ► Consult a qualified specialist workshop. <p> The indicator lamp (red) flashes and a warning tone sounds. You are making an emergency stop using the electric parking brake.</p> <ul style="list-style-type: none"> ► After the emergency stop: release the electric parking brake lever.

Display messages	Possible causes/consequences and ► Solutions
<p>PARK (USA only)  (Canada only) Parking Brake See Oper. Manual</p>	<p> The warning lamp (yellow) lights up. Additionally the indicator lamp (red) lights up. The electric parking brake is malfunctioning.</p> <p>To release:</p> <ul style="list-style-type: none"> ► Pull the electric parking brake handle. or ► Pull away carefully. ► Visit a qualified specialist workshop. <p>To apply:</p> <ul style="list-style-type: none"> ► Switch the ignition off. ► Pull the electric parking brake lever for at least ten seconds, until the display message disappears. <p>If the display message continues to be displayed:</p> <ul style="list-style-type: none"> ► Shift the transmission to P with the button in the center console. ► Prevent the vehicle from rolling away before you leave it. ► Consult a qualified specialist workshop. <hr/> <p> The indicator lamp (red) flashes. The power supply for the electric parking brake was interrupted.</p> <ul style="list-style-type: none"> ► Pull the electric parking brake handle. or ► Pull away carefully. or ► Pull the electric parking brake handle until the display message disappears. <hr/> <p> The indicator lamp (red) flashes and the warning lamp (yellow) lights up. The electric parking brake is malfunctioning.</p> <ul style="list-style-type: none"> ► Switch off the ignition and turn it back on. ► Engage or release the electric parking brake. or ► Pull away carefully. ► Visit a qualified specialist workshop.

Display messages	Possible causes/consequences and ► Solutions
	<p> The warning lamp (yellow) lights up. In addition, the indicator lamp (red) flashes for about 10 seconds after the electric parking brake has been engaged or released. It then goes out or remains lit.</p> <p>The electric parking brake is malfunctioning, e.g. because of overvoltage or undervoltage.</p> <ul style="list-style-type: none"> ► Pull away carefully. ► Visit a qualified specialist workshop. <p>If there is overvoltage or undervoltage:</p> <ul style="list-style-type: none"> ► Remove the cause for the overvoltage or undervoltage, e.g. by charging the battery or restarting the engine. ► Switch the ignition off and on, and then engage or release the electric parking brake. <p>If this does not release the electric parking brake:</p> <ul style="list-style-type: none"> ► Do not drive on. ► Consult a qualified specialist workshop.
<p> (USA only)  (Canada only)</p> <p>Parking Brake Inoperative</p>	<p> The warning lamp (yellow) lights up. In addition, the indicator lamp (red) flashes for about 10 seconds after the electric parking brake has been engaged or released. It then goes out or remains lit.</p> <p>The electric parking brake is malfunctioning.</p> <ul style="list-style-type: none"> ► Switch the ignition off and on, and then engage the electric parking brake. <p>If it is not possible to engage the electric parking brake:</p> <ul style="list-style-type: none"> ► Shift the transmission to P with the button in the center console. ► Prevent the vehicle from rolling away before you leave it. ► Visit a qualified specialist workshop.

Display messages	Possible causes/consequences and ► Solutions
<p>PARK (USA only)  (Canada only)</p> <p>Turn On the Ignition to Release the Parking Brake</p>	<p> The indicator lamp (red) flashes.</p> <p>You attempted to release the electric parking brake while the ignition was switched off.</p> <p>► Switch on the ignition.</p>
<p>PARK (USA only)  (Canada only)</p> <p>Check Brake Fluid Level</p>	<p>There is not enough brake fluid in the brake fluid reservoir. In addition, the  indicator lamp in the instrument cluster lights up and a warning tone sounds.</p> <p> WARNING</p> <p>Driving with the message Check Brake Fluid Level displayed can result in an accident.</p> <p>► Pull over and stop the vehicle safely as soon as possible, paying attention to road and traffic conditions. Do not continue driving under any circumstances.</p> <p>► Consult a qualified specialist workshop.</p> <p>Do not add brake fluid. This does not correct the malfunction.</p>
<p></p> <p>Check Brake Pad Wear</p>	<p>The brake pads/linings have reached their wear limit.</p> <p>► Visit a qualified specialist workshop.</p>



Safety systems

Display messages

Possible causes/consequences and ► Solutions



ESC Inoperative
See Operator's
Manual

ESP®, BAS and hill start assist are unavailable due to a malfunction. In addition, the  and  warning lamps light up in the instrument cluster.



 **WARNING**

If ESP® and BAS are deactivated, the danger of skidding and having an accident increases.

- Drive on carefully.
- Visit a qualified specialist workshop.



ESC Currently
Unavailable See
Operator's Manual

ESP®, BAS and hill start assist are temporarily unavailable. The self-diagnosis function might not be complete, for example. The brake system continues to function normally, but without the functions listed above. In addition, the  and  warning lamps light up in the instrument cluster.

 **WARNING**

If ESP® and BAS are deactivated, the danger of skidding and having an accident increases.

- Carefully drive a short distance making slight steering movements at a speed above 12 mph (20 km/h) until the display message disappears.

Front Passenger
Airbag Enabled
See Operator's
Manual

The front-passenger air bag and front-passenger knee bag are enabled during the journey, even though:

- a child, a small adult or an object weighing less than the system's weight threshold is located on the front-passenger seat
- the front-passenger seat is unoccupied







The system may detect objects or forces applying additional weight on the seat.

 **WARNING**

The front-passenger front air bag and front passenger knee bag may be triggered unintentionally.

There is an increased risk of injury.

- Pull over and stop the vehicle safely as soon as possible, paying attention to road and traffic conditions.
- Apply the parking brake.
- Switch the ignition off.
- Open the front-passenger door.

Display messages	Possible causes/consequences and ► Solutions
	<ul style="list-style-type: none"> ► Remove the child and the child restraint system from the front-passenger seat. ► Make sure that there are no objects on the seat adding to the weight. The system may otherwise detect the additional weight and interpret the seat occupant's weight as greater than it actually is. ► Keep the seat unoccupied, close the front-passenger door and switch on the ignition. <p>Observe the   (► page 42) indicator lamp and the multifunction display and check the following: Seat unoccupied and ignition switched on:</p> <ul style="list-style-type: none"> • the   indicator lamp must light up and remain lit. If the indicator lamp is on, OCS (► page 42) has disabled the front-passenger air bag. • the Front Passenger Airbag Enabled See Operator's Manual or Front Passenger Airbag Disabled See Operator's Manual display messages must not be shown in the multifunction display. Wait for a period of at least 60 seconds until the necessary system checks have been completed. This is necessary to make sure that the display messages do not appear in the multifunction display. <p>If these conditions are fulfilled, the front-passenger seat can be occupied again. Whether the   indicator lamp remains lit or goes out depends on how OCS classifies the occupant. If the conditions are not fulfilled, the system is not operating correctly.</p> <ul style="list-style-type: none"> ► Visit a qualified specialist workshop immediately. <p>For further information about the Occupant Classification System, see (► page 42).</p>

Display messages

Front Passenger
Airbag Disabled
See Operator's
Manual

Possible causes/consequences and ► Solutions

The front-passenger air bag and front-passenger knee bag are deactivated during the journey, although:

- an adult
or
- a person larger than a certain size is occupying the front-passenger seat



If additional forces are applied to the seat, the system may interpret the occupant's weight as lower than it actually is.

 **WARNING**



The front-passenger front air bag and front passenger knee bag may not be triggered in the event of an accident.



There is an increased risk of injury.

- Pull over and stop the vehicle safely as soon as possible, paying attention to road and traffic conditions.
- Apply the parking brake.
- Switch the ignition off.
- Have the occupant get out of the vehicle.
- Keep the seat unoccupied, close the front-passenger door and switch on the ignition.

Observe the   (▷ page 42) indicator lamp and the multifunction display and check the following:





Seat unoccupied and ignition switched on:

- the   indicator lamp must light up and remain lit. If the indicator lamp is on, OCS (▷ page 42) has disabled the front-passenger air bag.
- the [Front Passenger Airbag Enabled See Operator's Manual](#) or [Front Passenger Airbag Disabled See Operator's Manual](#) display messages must not be shown in the multifunction display. Wait for a period of at least 60 seconds until the necessary system checks have been completed. This is necessary and ensures that the display messages do not appear in the multifunction display.

If these conditions are fulfilled, the front-passenger seat can be occupied again. Whether the   indicator lamp remains lit or goes out depends on how OCS classifies the occupant.

If the conditions are not fulfilled, the system is not operating correctly.

- Visit a qualified specialist workshop immediately.



Display messages	Possible causes/consequences and ► Solutions
 <p>Tele Aid Inoperative</p>	<p>One or more main features of the mbrace system are malfunctioning.</p> <ul style="list-style-type: none"> ► Have the mbrace system checked immediately at a qualified specialist workshop.
 <p>SRS Malfunction Service Required</p>	<p>There is a malfunction in the SRS (Supplemental Restraint System). The  warning lamp also lights up in the instrument cluster.</p> <p>⚠ WARNING</p> <p>The air bags or Emergency Tensioning Devices may either be triggered unintentionally or, in the event of an accident, may not be triggered.</p> <p>There is an increased risk of injury.</p> <ul style="list-style-type: none"> ► Visit a qualified specialist workshop. <p>For further information about SRS, see (▷ page 37).</p>
 <p>Front Left SRS Malfunction Service Required or Front Right SRS Malfunction Service Required</p>	<p>SRS has malfunctioned at the front on the left or right. The  warning lamp also lights up in the instrument cluster.</p> <p>⚠ WARNING</p> <p>If SRS is malfunctioning, individual systems may be triggered unintentionally or might not be triggered in the event of an accident with a high rate of vehicle deceleration. In this condition, the restraint system provides only restricted protection.</p> <ul style="list-style-type: none"> ► Visit a qualified specialist workshop.



Lights



- i** Display messages about LEDs:
The display message will only appear if all or a number of LEDs have failed.







Display messages	Possible causes/consequences and ► Solutions
 Check Left Low Beam or Check Right Low Beam	The left or right-hand low-beam headlamp does not light up. In addition, the high-beam headlamp is also inoperative. ► Visit a qualified specialist workshop.
 AUTO Lamp Function Inoperative	The light sensor is defective. USA only: ► Switch off the daytime running lamps in the on-board computer (> page 146). ► Switch the lights on and off using the light switch.
 Check Rear Left Turn Signal or Check Rear Right Turn Signal	The LEDs in the rear left or right-hand indicator lamp do not light up. ► Visit a qualified specialist workshop.
 Check Left Mirror Turn Signal or Check Right Mirror Turn Signal	None of the LEDs in the left or right-hand exterior mirrors light up. ► Visit a qualified specialist workshop.
 Check Front Left Turn Signal or Check Front Right Turn Signal	The LEDs in the front left or right-hand indicator lamp do not light up. ► Visit a qualified specialist workshop.
 Check Center Brake Lamp	None of the LEDs in the high-mounted brake lamp light up. ► Visit a qualified specialist workshop.



Display messages	Possible causes/consequences and ► Solutions
 Check Left Brake Lamp or Check Right Brake Lamp	The left or right-hand brake light LEDs do not light up. ► Visit a qualified specialist workshop.
 Check Left Tail Lamp or Check Right Tail Lamp	The left or right-hand tail lamp LEDs do not light up. ► Visit a qualified specialist workshop.
 Check Left High Beam or Check Right High Beam	The left or right-hand low-beam headlamp does not light up. ► Visit a qualified specialist workshop.
 Check Left License Plate Lamp or Check Right License Plate Lamp	The left or right-hand license plate lamp does not light up. ► Replace the bulb (► page 95).
 Backup Light	None of the LEDs in the backup lamp light up. ► Visit a qualified specialist workshop.
 Check Left Daytime Running Light or Check Right Daytime Running Light	The LEDs in the left or right-hand daytime running lamp do not light up. As a result, the corresponding side/standing lamp has failed. ► Visit a qualified specialist workshop.

Display messages	Possible causes/consequences and ► Solutions
 <p>Check Front Left Sidemarker Lamp or Check Front Right Sidemarker Lamp</p>	<p>The left or right front side marker lamp is defective.</p> <p>► Visit a qualified specialist workshop.</p>
 <p>Check Rear Left Sidemarker Lamp or Check Rear Right Sidemarker Lamp</p>	<p>The rear left or right side marker lamp is defective.</p> <p>► Visit a qualified specialist workshop.</p>
 <p>Check Front Left Parking Lamp or Check Front Right Parking Lamp</p>	<p>The front left or front right parking or standing lamp is defective.</p> <p>► Visit a qualified specialist workshop.</p>
 <p>Switch Off Lights</p>	<p>The lights are still switched on when you leave the vehicle. A warning tone also sounds.</p> <p>► Turn the light switch to AUTO.</p>
 <p>Malfunction See Operator's Manual</p>	<p>The exterior lighting is defective.</p> <p>► Visit a qualified specialist workshop.</p>

Engine	
Display messages	Possible causes/consequences and ► Solutions
 <p>Coolant Low Stop Vehicle Turn Engine Off</p>	<p>The coolant is too hot. In addition, the  warning lamp in the instrument cluster lights up and a warning tone sounds.</p> <p>⚠ WARNING</p> <p>Do not drive when your engine is overheated. This can cause some fluids which may have leaked into the engine compartment to catch fire.</p> <p>Steam from the overheated engine can also cause serious burns which can occur just by opening the hood.</p> <p>There is a risk of injury.</p> <ul style="list-style-type: none"> ► Pull over and stop the vehicle safely and switch off the engine, paying attention to road and traffic conditions. ► Secure the vehicle against rolling away (► page 124). ► Wait until the engine has cooled down. ► Make sure that the air supply to the radiator is not blocked, e.g. by snow, slush or ice. ► Wait until the display message disappears before restarting the engine. Otherwise, the engine could be damaged. ► Pay attention to the coolant temperature display. ► If the coolant temperature increases again, visit a qualified specialist workshop immediately. <p>! If the coolant temperature is over 248 °F (120 °C), do not continue driving. The engine will otherwise be damaged.</p>
	<p>The fan motor is faulty.</p> <ul style="list-style-type: none"> ► At coolant temperatures below 248 °F (120 °C), drive to the nearest qualified specialist workshop. ► Avoid subjecting the engine to heavy loads, e.g. driving in mountainous terrain, and stop-and-go traffic.



Display messages	Possible causes/consequences and ► Solutions
	<p>The battery is not being charged. A warning tone also sounds. Possible causes are:</p> <ul style="list-style-type: none"> • a defective alternator • a torn poly-V-belt • a malfunction in the electronics <p>► Pull over and stop the vehicle safely and switch off the engine, paying attention to road and traffic conditions. ► Secure the vehicle against rolling away (▷ page 124). ► Open the hood. ► Check whether the poly-V-belt is torn.</p> <p>If the poly-V-belt is torn:</p> <p>! Do not continue driving. The engine could otherwise overheat. ► Consult a qualified specialist workshop.</p> <p>If the poly-V-belt is not damaged:</p> <p>► Visit a qualified specialist workshop.</p>
 <p>Check Coolant Level See Operator's Manual</p>	<p>The coolant level is too low.</p> <p>! Avoid making long journeys with too little coolant in the engine cooling system. The engine will otherwise be damaged.</p> <p>► Add coolant, observing the warning notes before doing so (▷ page 204). ► If coolant needs to be added more often than usual, have the engine coolant system checked at a qualified specialist workshop.</p>
 <p>Engine Oil Level Low Stop Vehicle Turn Engine Off</p>	<p>There is insufficient oil in the engine. There is a risk of engine damage.</p> <p>► Pull over and stop the vehicle safely and switch off the engine, paying attention to road and traffic conditions. ► Top up and check the engine oil level (▷ page 203).</p>

Display messages	Possible causes/consequences and ► Solutions
 <p>Check Engine Oil Level (Add 1 Liter)</p>	<p>The oil level is too low.</p> <ul style="list-style-type: none"> ▶ Check the oil level (> page 203). ▶ If necessary, add engine oil. ▶ Have the engine checked for leaks if you need to add engine oil more often than usual. <p>! Avoid long journeys with too little engine oil. The engine will otherwise be damaged.</p> <p>Information on approved engine oils can be obtained from any qualified specialist workshop or on the Internet at http://www.mbusa.com (USA only).</p>
 <p>Engine Oil Level Too High</p>	<p>You have added too much engine oil. The engine or catalytic converter may be damaged.</p> <ul style="list-style-type: none"> ▶ Siphon off excess engine oil until it is at the specified level. Observe the legal requirements.
 <p>Engine Oil Level Cannot Be Measured</p>	<p>The measuring system is faulty.</p> <ul style="list-style-type: none"> ▶ Visit a qualified specialist workshop.
 <p>Engine Oil Pressure Control See Operator's Manual</p>	<p>The oil pressure sensor has reported a malfunction. The oil pressure control is in emergency mode. The engine lubrication is guaranteed.</p> <ul style="list-style-type: none"> ▶ Visit a qualified specialist workshop.
 <p>Engine Oil Pressure Stop Vehicle Turn Engine Off</p>	<ul style="list-style-type: none"> ▶ Pull over and stop the vehicle safely and switch off the engine, paying attention to road and traffic conditions. ▶ Check the engine oil level (> page 203) and top up if necessary. ▶ If there are visible signs of oil loss from the vehicle, consult a qualified specialist workshop.
 <p>Fuel Level Low</p>	<p>There is only a small amount of fuel in the fuel tank.</p> <ul style="list-style-type: none"> ▶ Refuel at the nearest gas station.
 <p>Fuel Level Low</p>	<p>The fuel level has fallen below the reserve range.</p> <ul style="list-style-type: none"> ▶ Refuel at the nearest gas station.

Display messages	Possible causes/consequences and ► Solutions
 Gas Cap Loose	<p>The fuel system pressure is too low. The fuel filler cap is not closed correctly or the fuel system is leaking.</p> <ul style="list-style-type: none"> ► Check that the fuel filler cap is correctly closed. <p>If the fuel filler cap is not correctly closed:</p> <ul style="list-style-type: none"> ► Close the fuel filler cap. <p>If the fuel filler cap is correctly closed:</p> <ul style="list-style-type: none"> ► Visit a qualified specialist workshop.
 Replace Air Filter	<p>The air filter is dirty and must be replaced.</p> <ul style="list-style-type: none"> ► Visit a qualified specialist workshop.





Driving systems



Display messages	Possible causes/consequences and ► Solutions
Cruise Control Inoperative	<p>Cruise control is defective.</p> <p>A warning tone also sounds.</p> <ul style="list-style-type: none"> ► Visit a qualified specialist workshop.
Cruise Control - - - mph	<p>A condition for activating cruise control has not been fulfilled. You have tried to store a speed below 20 mph (30 km/h), for example.</p> <ul style="list-style-type: none"> ► Activate ESP® (► page 56). ► If conditions permit, drive faster than 20 mph (30 km/h) and store the speed. ► Check the activation conditions for cruise control (► page 131).







Display messages	Possible causes/consequences and ► Solutions
Blind Spot Assist Inoperative	<p>Blind Spot Assist is defective.</p> <p>The yellow  indicator lamps also light up in the exterior mirrors.</p> <p>► Visit a qualified specialist workshop.</p>
Blind Spot Assist Currently Unavailable See Operator's Manual	<p>Blind Spot Assist is temporarily inoperative if:</p> <ul style="list-style-type: none"> • the sensors are dirty. • its function is impaired due to heavy rain or snow. • the radar sensor system is outside the operating temperature range. • the radar sensor system is temporarily inoperative, e.g. due to electromagnetic radiation emitted by nearby TV or radio stations or other sources of electromagnetic radiation. <p>The yellow  indicator lamps also light up in the exterior mirrors.</p> <p>Blind Spot Assist is operational again and the display message disappears if:</p> <ul style="list-style-type: none"> • the dirt (e.g. slush) drops away while the vehicle is in motion. • the system detects that the sensors are fully available again. • the radar sensor system is back within the operating temperature range. <p>If the display message continues to be displayed:</p> <p>► Restart the engine.</p>

Tires	
Display messages	Possible causes/consequences and ► Solutions
Rectify Tire Pressure	<p>The tire pressure is too low in at least one of the tires, or the tire pressure difference between the wheels is too great.</p> <ul style="list-style-type: none"> ► Check the tire pressures at the next opportunity (▷ page 238). ► If necessary, correct the tire pressure. ► Restart the tire pressure monitor (▷ page 241).
Check Tires	<p>The tire pressure in one or more tires has dropped significantly. The wheel position is shown in the multifunction display. A warning tone also sounds.</p> <p> WARNING</p> <p>With tire pressures which are too low, there is a risk of the following hazards:</p> <ul style="list-style-type: none"> • they may burst, especially as the load and vehicle speed increase. • they may wear excessively and/or unevenly, which may greatly impair tire traction. • the driving characteristics, as well as steering and braking, may be greatly impaired. <p>There is a risk of an accident.</p> <ul style="list-style-type: none"> ► Stop the vehicle without making any sudden steering or braking maneuvers. Pay attention to the traffic conditions as you do so. ► Secure the vehicle against rolling away (▷ page 124). ► Check the tires and, if necessary, follow the instructions for a flat tire (▷ page 217). ► Check the tire pressure (▷ page 238). ► If necessary, correct the tire pressure.

Display messages	Possible causes/consequences and ► Solutions
Tire Press. Warning Caution Tire Malfunction	<p>The tire pressure in one or more tires has dropped suddenly. The wheel position is shown in the multifunction display.</p> <p> WARNING</p> <p>If you drive with a flat tire, there is a risk of the following hazards:</p> <ul style="list-style-type: none"> • a flat tire affects the ability to steer or brake the vehicle. • you could lose control of the vehicle. • continued driving with a flat tire will cause excessive heat build-up and possibly a fire. <p>There is a risk of an accident.</p> <ul style="list-style-type: none"> ► Stop the vehicle without making any sudden steering or braking maneuvers. Pay attention to the traffic conditions as you do so. ► Secure the vehicle against rolling away (► page 124). ► Check the tires and, if necessary, follow the instructions for a flat tire (► page 217).
Tire Press. Monitor Currently Unavailable	<p>Due to a source of radio interference, no signals can be received from the wheel sensors. The tire pressure monitor is temporarily malfunctioning.</p> <ul style="list-style-type: none"> ► Drive on. The tire pressure monitor restarts automatically as soon as the problem has been solved.
Tire Press. Sensor(s)Missing	<p>There is no signal from the tire pressure sensor of one or several wheels. The pressure of the affected tire is not displayed in the multifunction display.</p> <ul style="list-style-type: none"> ► Have the faulty tire pressure sensor replaced at a qualified specialist workshop.
Tire Pressure Monitor Inoperative No Wheel Sensors	<p>The wheels mounted do not have a suitable tire pressure sensor. The tire pressure monitor is deactivated.</p> <ul style="list-style-type: none"> ► Mount wheels with suitable tire pressure sensors. The tire pressure monitor is activated automatically after driving for a few minutes.
Tire Pressure Monitor Inoperative	<p>The tire pressure monitor is faulty.</p> <ul style="list-style-type: none"> ► Visit a qualified specialist workshop.

Vehicle	
Display messages	Possible causes/consequences and ► Solutions
	<p>The trunk lid is open.</p> <p>► Close the trunk lid.</p>
	<p>The hood is open.</p> <p>⚠ WARNING</p> <p>The open hood may block your view when the vehicle is in motion. There is a risk of an accident.</p> <p>► Pull over and stop the vehicle safely as soon as possible, paying attention to road and traffic conditions.</p> <p>► Close the hood.</p>
	<p>At least one door is open.</p> <p>A warning tone also sounds.</p> <p>► Close the doors.</p>
 Check Washer Fluid	<p>The washer fluid level in the washer fluid reservoir has dropped below the minimum.</p> <p>► Add washer fluid (▷ page 205).</p>







SmartKey	
Display messages	Possible causes/consequences and ► Solutions
 Change Key Battery	<p>The SmartKey batteries are discharged.</p> <p>► Change the batteries (▷ page 65).</p>
 Key Not Detected (red display message)	<p>The SmartKey is not in the vehicle. A warning tone also sounds. When you switch off the engine, you will be unable to restart it.</p> <p>► Pull over and stop the vehicle safely as soon as possible, paying attention to road and traffic conditions.</p> <p>► Locate the SmartKey.</p> <p>The key is not detected while driving because a powerful radio transmitter is causing interference. A warning tone also sounds.</p> <p>► Pull over and stop the vehicle safely as soon as possible, paying attention to road and traffic conditions.</p> <p>► Insert the key into the ignition lock and turn it to the desired position (▷ page 111).</p>

Display messages	Possible causes/consequences and ► Solutions
 <p>Key Not Detected (white display message)</p>	<p>You are in the vehicle and the key currently cannot be detected by the vehicle.</p> <ul style="list-style-type: none"> ► Change the location of the SmartKey in the vehicle. <p>If the SmartKey still cannot be detected:</p> <ul style="list-style-type: none"> ► Insert the key into the ignition lock and turn it to the desired position (▷ page 111).
 <p>Obtain a New Key</p>	<p>The SmartKey needs to be replaced.</p> <ul style="list-style-type: none"> ► Visit a qualified specialist workshop.
 <p>Key Does Not Belong to Vehicle</p>	<p>You have put the wrong SmartKey in the ignition lock.</p> <ul style="list-style-type: none"> ► Use the correct SmartKey.
 <p>Close Doors to Lock Vehicle</p>	<p>At least one door is open. A warning tone also sounds.</p> <ul style="list-style-type: none"> ► Close all doors and lock the vehicle again.
 <p>Remove 'Start' Button and Insert Key</p>	<p>The KEYLESS-GO start function is temporarily malfunctioning or is defective. A warning tone also sounds.</p> <ul style="list-style-type: none"> ► Insert the key into the ignition lock and turn it to the desired position (▷ page 111).
 <p>Take Your Key from Ignition</p>	<p>The SmartKey is in the ignition lock.</p> <ul style="list-style-type: none"> ► Remove the SmartKey.

Transmission







Display messages	Possible causes/consequences and ► Solutions
Apply Brake to Shift from 'P'	<p>You have attempted to move the transmission selector lever to position D, R or N without depressing the brake pedal.</p> <ul style="list-style-type: none"> ► Depress the brake pedal.
Apply Brake and Start Engine to Disengage 'P'	<p>When the engine is switched off, it is not possible to shift out of park position P.</p> <ul style="list-style-type: none"> ► Depress the brake pedal and start the engine.
Start Engine to Engage Gear	<p>The gear cannot be engaged when the engine is switched off.</p> <ul style="list-style-type: none"> ► Depress the brake pedal and start the engine.





Display messages	Possible causes/consequences and ► Solutions
Depress Brake to Start Engine	You cannot start the engine. The engine was switched off in position D or R . ► Depress the brake pedal and start the engine.
Door Open Not in 'P'	The driver's door is open and the transmission is in position R , N or D . A warning tone also sounds. ► Shift the transmission to P with the button in the center console. ► Press the electric parking brake handle.
Service Required Do Not Shift Gears Visit Dealer	You cannot change gear due to a malfunction. A warning tone also sounds. If transmission position D is selected: ► Do not switch off the engine. ► Drive to a qualified specialist workshop without shifting the transmission from position D . If transmission position R , N or P is selected: ► Make sure that the electric parking brake is applied. ► Prevent the vehicle from rolling away before you leave it (▷ page 253). ► Notify a qualified specialist workshop or breakdown service. If no transmission position and no drive program is displayed: ► Make sure that the electric parking brake is applied. ► Prevent the vehicle from rolling away before you leave it (▷ page 253). ► Notify a qualified specialist workshop or breakdown service.
Only Shift to 'P' when Vehicle is Stationary	The vehicle is moving. ► Pull over and stop the vehicle safely as soon as possible, paying attention to road and traffic conditions. ► Shift the transmission to P with the button in the center console.
Reversing Not Poss. Service Required	The sub geartrain with the even gears has failed. You can no longer engage reverse gear. The smoothness of the gear change is restricted. The transmission is in emergency mode. ► Visit a qualified specialist workshop.

Display messages	Possible causes/consequences and ► Solutions
 <p>Parking Lock Malfunct. Apply Parking Brake</p>	<p>Transmission position P cannot be selected.</p> <ul style="list-style-type: none"> ▶ Make sure that the electric parking brake is applied. ▶ Prevent the vehicle from rolling away before you leave it (> page 253). ▶ Visit a qualified specialist workshop. Have the vehicle transported on a recovery vehicle or towed with the rear axle raised (> page 226).
 <p>Stop Engage P</p>	<p>The transmission is faulty. The vehicle loses drive and rolls to a standstill.</p> <ul style="list-style-type: none"> ▶ Pull over and stop the vehicle safely as soon as possible, paying attention to road and traffic conditions. ▶ Make sure that the electric parking brake is applied. ▶ Prevent the vehicle from rolling away before you leave it (> page 253). ▶ Consult a qualified specialist workshop.
 <p>Transmission Oil Cooling Malfunction</p>	<p>The transmission coolant pump is faulty. The transmission may overheat.</p> <ul style="list-style-type: none"> ▶ In the on-board computer, select the AMG menu and check the transmission oil temperature. ▶ Avoid excessive loading, e.g. due to dynamic driving. ▶ If the transmission oil temperature is less than 248 °F(120 °C), you can continue driving to the nearest qualified specialist workshop.
 <p>Trans. Oil Overheated Drive on with Care</p>	<p>The transmission oil has overheated.</p> <p>Manual drive program M and shift range restriction are no longer available. Only drive program C is still available. The engine output is reduced according to the degree of overheating.</p> <ul style="list-style-type: none"> ▶ Allow the transmission oil to cool by adopting a defensive driving style.
 <p>Electr. Rear Axle Differential Lock Inoperative</p>	<p>The electronic rear axle differential lock is inoperative.</p> <ul style="list-style-type: none"> ▶ Visit a qualified specialist workshop.
 <p>Electr. Rear Axle Differential Lock Currently Unavailable</p>	<p>The electronic rear axle differential lock motor has overheated.</p> <ul style="list-style-type: none"> ▶ Allow electronic rear axle differential lock to cool by adopting a defensive driving style.





Warning and indicator lamps in the instrument cluster



Braking





Problem	Possible causes/consequences and ► Solutions
<p> The red brake system warning lamp comes on while the engine is running. A warning tone also sounds.</p> <p>(USA only)</p> <p> (Canada only)</p>	<p>There is not enough brake fluid in the brake fluid reservoir.</p> <p> WARNING</p> <p>The braking effect may be impaired. There is a risk of an accident.</p> <ul style="list-style-type: none"> ► Pull over and stop the vehicle safely as soon as possible, paying attention to road and traffic conditions. Do not continue driving under any circumstances. ► Secure the vehicle against rolling away (► page 124). ► Do not add brake fluid. Adding more will not remedy the malfunction. ► Consult a qualified specialist workshop. ► Observe the additional display messages in the multifunction display.
<p> The indicator lamp for the electric parking brake flashes and/or the yellow warning lamp for the electric parking brake lights up.</p> <p>(USA only)</p> <p> (Canada only)</p>	<p>The electric parking brake is temporarily malfunctioning or defective.</p> <p> WARNING</p> <p>In this condition, the vehicle is only of limited roadworthiness. This can lead to an accident.</p> <ul style="list-style-type: none"> ► Observe the additional display messages in the multifunction display.



Seat belts	
Problem	Possible causes/consequences and ► Solutions
 After starting the engine, the red seat belt warning lamp lights up for 6 seconds.	The seat belt warning lamp reminds the driver and front passenger to fasten their seat belts. ► Fasten your seat belt (▷ page 49).
 After starting the engine, the red seat belt warning lamp lights up. In addition, a warning tone sounds for up to 6 seconds.	The driver's seat belt is not fastened. ► Fasten your seat belt (▷ page 49). The warning tone ceases.
 The red seat belt warning lamp lights up after the engine starts, as soon as the driver's door or the front-passenger door is closed.	The driver or front passenger has not fastened their seat belt. ► Fasten your seat belt (▷ page 49). The warning lamp goes out.
	There are objects on the front-passenger seat. ► Remove the objects from the front-passenger seat and stow them in a secure place. The warning lamp goes out.
 The red seat belt warning lamp flashes and an intermittent audible warning sounds.	The driver or front passenger has not fastened their seat belt. The vehicle is being driven faster than 15 mph (25 km/h) or has briefly been driven faster than 15 mph (25 km/h). ► Fasten your seat belt (▷ page 49). The warning lamp goes out and the intermittent audible warning ceases.
	There are objects on the front-passenger seat. The vehicle is being driven faster than 15 mph (25 km/h) or has briefly been driven faster than 15 mph (25 km/h). ► Remove the objects from the front-passenger seat and stow them in a secure place. The warning lamp goes out and the intermittent audible warning ceases.



Safety systems





Problem	Possible causes/consequences and ► Solutions
 The yellow ABS warning lamp is lit while the engine is running.	<p>ABS has been deactivated due to a malfunction. ESP[®], BAS and hill start assist are therefore also deactivated.</p> <p> WARNING</p> <p>The brake system continues to function normally, but without the functions listed above. The wheels could therefore lock if you brake hard, for example.</p> <p>The steerability and braking characteristics may be severely affected. The braking distance in an emergency braking situation can increase.</p> <p>If ESP[®] is not operational, ESP[®] is unable to stabilize the vehicle. There is an increased risk of skidding and an accident.</p> <ul style="list-style-type: none"> ► Observe the additional display messages in the multifunction display. ► Drive on carefully. ► Visit a qualified specialist workshop. <p>If the ABS control unit is faulty, there is also a possibility that other systems, such as the navigation system or the transmission, will not be available.</p>
 The yellow ESP [®] and ESP [®] OFF warning lamps and the yellow ABS warning lamp are lit while the engine is running.	<p>ABS and ESP[®] are malfunctioning. Other systems, e.g. BAS and hill start assist, are unavailable due to a malfunction.</p> <p> WARNING</p> <p>The brake system continues to function normally, but without the functions listed above.</p> <p>The braking distance in an emergency braking situation can thus increase.</p> <p>If ESP[®] is not operational, ESP[®] is unable to stabilize the vehicle. There is an increased risk of skidding and an accident.</p> <ul style="list-style-type: none"> ► Observe the additional display messages in the multifunction display (► page 158). ► Drive on carefully. ► Visit a qualified specialist workshop.

Problem	Possible causes/consequences and ► Solutions
 The yellow ESP® warning lamp flashes while the vehicle is in motion.	<p>ESP® or traction control has intervened because there is a risk of skidding or at least one wheel has started to spin. Cruise control is switched off.</p> <ul style="list-style-type: none"> ► When pulling away, only depress the accelerator pedal as far as necessary. ► Ease off the accelerator pedal while the vehicle is in motion. ► Adapt your driving style to suit the road and weather conditions. ► Do not deactivate ESP®. <p>For exceptions, see: (► page 56).</p>
 The yellow SPORT handling mode warning lamp is lit while the engine is running.	<p>SPORT handling mode is activated.</p> <p> WARNING</p> <p>ESP® only stabilizes the vehicle in extreme situations. ESP® intervention may not be able to provide enough assistance in such situations, and the vehicle may start to skid. There is an increased risk of skidding and an accident.</p> <ul style="list-style-type: none"> ► Only switch to SPORT handling mode in accordance with the conditions written in the "Activating/deactivating SPORT handling mode" section (► page 56).

Problem	Possible causes/consequences and ► Solutions
 <p>The yellow ESP[®] and ESP[®] OFF warning lamps are lit while the engine is running.</p>	<p>ESP[®] is not available due to a malfunction.</p> <p> WARNING</p> <p>The brake system continues to function normally, but without the functions listed above.</p> <p>The braking distance in an emergency braking situation can thus increase.</p> <p>If ESP[®] is not operational, ESP[®] is unable to stabilize the vehicle. There is an increased risk of skidding and an accident.</p> <ul style="list-style-type: none"> ► Observe the additional display messages in the multifunction display. ► Drive on carefully. ► Visit a qualified specialist workshop.
 <p>The red SRS warning lamp is lit while the engine is running.</p>	<p>There is a malfunction in the SRS (Supplemental Restraint System).</p> <p> WARNING</p> <p>If the air bags or Emergency Tensioning Devices are either triggered unintentionally or, in the event of an accident, not triggered.</p> <p>There is an increased risk of injury.</p> <ul style="list-style-type: none"> ► Drive on carefully. ► Have SRS checked at a qualified specialist workshop immediately. <p>For further information about SRS, see (► page 37).</p>

Engine	
Problem	Possible causes/consequences and ► Solutions
 The yellow Check Engine warning lamp lights up while the engine is running.	<p>There may be a malfunction, for example:</p> <ul style="list-style-type: none"> • in the engine management • in the fuel injection system • in the exhaust system • in the ignition system • in the fuel system <p>The emission limit values may be exceeded and the engine may be in emergency mode.</p> <p>► Have the vehicle checked as soon as possible at a qualified specialist workshop.</p> <p>i In some states, you must visit a qualified specialist workshop as soon as the yellow check engine warning lamp lights up. This is due to the legal requirements in effect in these states. If in doubt, check whether such legal regulations apply in the state in which you are currently driving.</p>
 The yellow Check Engine warning lamp lights up while the engine is running. The smoothness of the gear change is restricted.	<p>The sub geartrain with the odd gears has failed. The transmission is in emergency mode.</p> <p>► Have the vehicle checked as soon as possible at a qualified specialist workshop.</p>
 The red engine oil temperature warning lamp comes on while the engine is running. A warning tone also sounds.	<p>The engine oil temperature has exceeded 284 °F (140 °C). The engine is not being cooled sufficiently and may be damaged.</p> <p>► Pull over and stop the vehicle safely and switch off the engine, paying attention to road and traffic conditions.</p> <p>► Allow the engine to cool down.</p>

Problem	Possible causes/consequences and ► Solutions
 <p>The red engine oil temperature warning lamp comes on while the engine is running. The engine oil temperature is not displayed.</p>	<p>The engine control unit data transfer is malfunctioning.</p> <ul style="list-style-type: none"> ► Visit a qualified specialist workshop.
 <p>The yellow reserve fuel warning lamp lights up while the engine is running.</p>	<p>The fuel level has dropped into the reserve range.</p> <ul style="list-style-type: none"> ► Refuel at the nearest gas station.
 <p>The yellow reserve fuel warning lamp flashes while the engine is running.</p>	<p>The fuel system pressure is too low. The fuel filler cap is not closed correctly or the fuel system is leaking.</p> <ul style="list-style-type: none"> ► Check that the fuel filler cap is correctly closed. ► If the fuel filler cap is not correctly closed: close the fuel filler cap. ► If the fuel filler cap is closed: visit a qualified specialist workshop.

Tires	
Problem	Possible causes/consequences and ► Solutions
 The yellow tire pressure monitor warning lamp (pressure loss/malfunction) is lit.	<p>The tire pressure monitor has detected a loss of pressure in at least one of the tires.</p> <p> WARNING</p> <p>With tire pressures which are too low, there is a risk of the following hazards:</p> <ul style="list-style-type: none"> • they may burst, especially as the load and vehicle speed increase. • they may wear excessively and/or unevenly, which may greatly impair tire traction. • the driving characteristics, as well as steering and braking, may be greatly impaired. <p>There is a risk of an accident.</p> <ul style="list-style-type: none"> ► Stop the vehicle without making any sudden steering or braking maneuvers. Pay attention to the traffic conditions as you do so. ► Secure the vehicle against rolling away (▷ page 124). ► Observe the additional display messages in the multifunction display. ► Check the tires and, if necessary, follow the instructions for a flat tire (▷ page 217). ► Check the tire pressure (▷ page 238). ► If necessary, correct the tire pressure.
 The yellow tire pressure monitor warning lamp (pressure loss/malfunction) flashes for approximately one minute and then remains lit.	<p>The tire pressure monitor is faulty.</p> <p> WARNING</p> <p>The system is possibly unable to recognize or register low tire pressure.</p> <p>There is a risk of an accident.</p> <ul style="list-style-type: none"> ► Observe the additional display messages in the multifunction display. ► Visit a qualified specialist workshop.

Useful information	186
Stowage areas	186
Features	188

Useful information

- i** This Operator's Manual describes all models and all standard and optional equipment of your vehicle available at the time of publication of the Operator's Manual. Country-specific differences are possible. Please note that your vehicle may not be equipped with all features described. This also applies to safety-related systems and functions.
- i** Please read the information on qualified specialist workshops (▷ page 21).

Stowage areas

Stowage space

Important safety notes

⚠ WARNING

If you do not correctly store objects in the vehicle interior, they can slip or be flung around, thus striking vehicle occupants. There is a risk of injury, especially when braking or abruptly changing directions.

- Always store objects so that they cannot be flung around in these or in similar situations.
- Always make sure that objects do not protrude from stowage compartments, parcel nets or stowage nets.
- Close lockable stowage compartments while driving.
- Stow and secure objects that are heavy, hard, pointy, sharp-edged, fragile or too large in the trunk.

Glove box

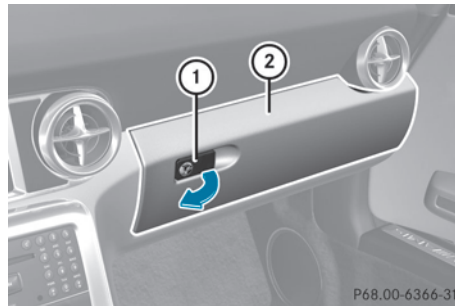

- ▶ **To open:** pull handle ① and open glove box flap ②.
- ▶ **To close:** fold glove box flap ② upwards until it engages.

The glove box can be locked and unlocked using the mechanical key, e.g. when leaving your vehicle at a workshop.

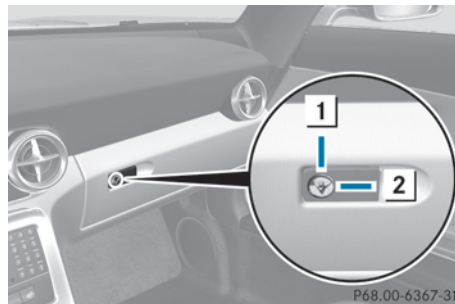

- ▶ **To lock:** insert the mechanical key into the lock and turn it 90° clockwise to position ②.
- ▶ **To unlock:** insert the mechanical key into the lock and turn it 90° counter-clockwise to position ①.

- i** Depending on the vehicle's equipment, you will find an AUX IN jack or a Media Interface installed in the glove box. A Media Interface is a universal interface for portable audio equipment, e.g. for an iPod® or USB device (see the separate COMAND operating instructions).

- i** There is a 12 V power socket located in the glove box.

Stowage compartment in the center console



- ▶ **To open:** press down at the middle of the marking on lid ①.
- ▶ **To close:** fold down cover ①.

- i** Depending on the equipment installed, your vehicle is equipped with an ashtray or a stowage compartment.

Stowage compartment under the armrest

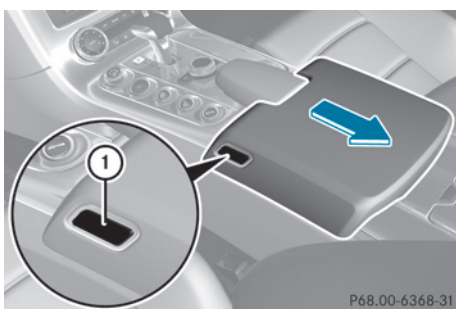

- ▶ **To open:** press button ① on the left or right and slide the armrest in the direction of the arrow. The armrest engages in two different detents.

Stowage compartment in the rear center console

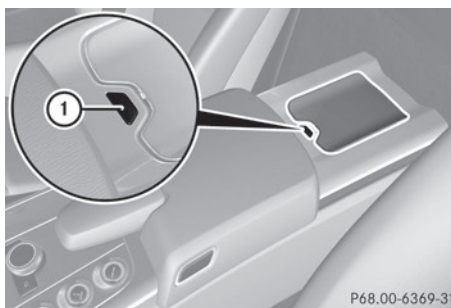

- ▶ Press button ①. The stowage compartment opens.

- i** In the stowage compartment, you will find the ignition lock (▶ page 111) and the trunk lid emergency release (▶ page 72).

Stowage space on the rear wall between the seats

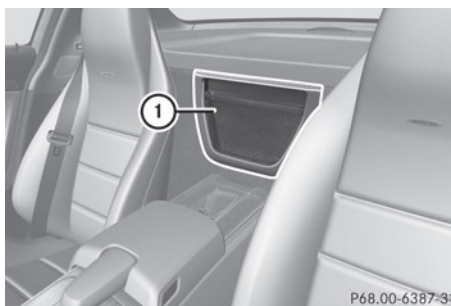

- ① Ruffled pocket

Stowage nets

There is a parcel net located in the front-passenger footwell.

Features

Cup holder

Important safety notes

- ❗ Only use the cup holders for containers of the right size and which have lids. The drinks could otherwise spill.

Cup holder in the center console

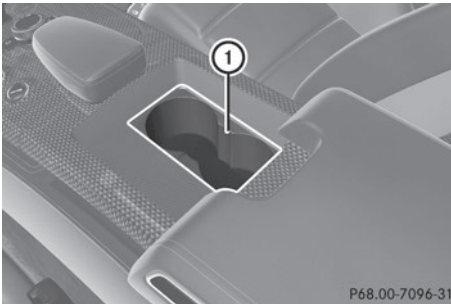

- ▶ Open the armrest (▶ page 187).
Cup holders (1) are under the armrest.

Sun visors

Overview of sun visors

⚠ WARNING

If the mirror cover of the vanity mirror is folded up when the vehicle is in motion, you could be blinded by incident light. There is a risk of an accident.

Always keep the mirror cover folded down while driving.

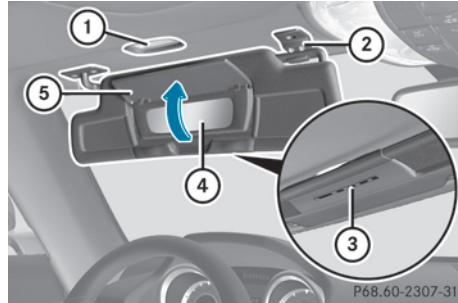

- ① Mirror light
- ② Bracket
- ③ Retaining strip, e.g. for a parking lot ticket
- ④ Vanity mirror
- ⑤ Mirror cover

Vanity mirror in the sun visor

Mirror light (1) only functions if the sun visor is clipped into bracket (2) and mirror cover (5) has been folded up.

Glare from the side

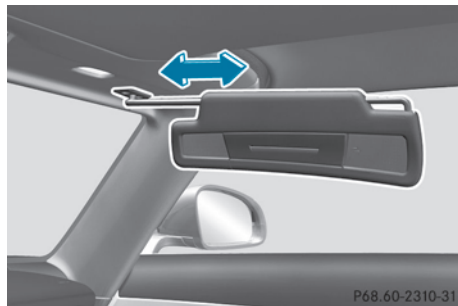

- ▶ Fold down the sun visor.
- ▶ Pull the sun visor out of bracket (2).
- ▶ Swing the sun visor to the side.
- ▶ Slide the sun visor horizontally as desired.

Ashtray

- ⓘ You can remove the ashtray insert and use the resulting compartment for stowage.

! The stowage space under the ashtray is not heat resistant. Before placing lit cigarettes in the ashtray, make sure that the ashtray is properly engaged. Otherwise, the stowage space could be damaged.

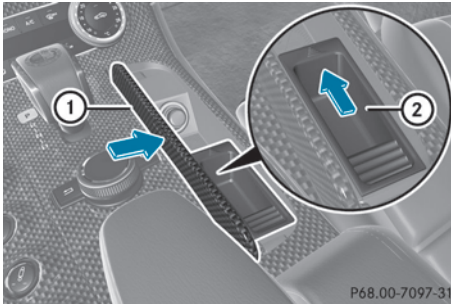

- ▶ **To open:** briefly press the middle of cover ①.
The stowage compartment opens.
- ▶ **To remove the insert:** slide insert ② forwards in the direction of the arrow.
- ▶ Remove insert ②.
- ▶ **To re-install the insert:** place insert ② into the holder and press it in the opposite direction of the arrow until it engages.
- ▶ **To close:** fold down cover ①.

Cigarette lighter

WARNING

You can burn yourself if you touch the hot heating element or the socket of the cigarette lighter.

In addition, flammable materials can ignite if:

- the hot cigarette lighter falls
- a child holds the hot cigarette lighter to objects, for example

There is a risk of fire and injury.

Always hold the cigarette lighter by the knob. Always make sure that the cigarette lighter is out of reach of children. Never leave children unsupervised in the vehicle.

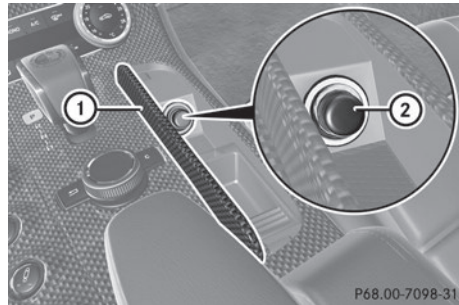

- ▶ Select key position 2 with the Start/Stop button (▶ page 111).
- ▶ **To open:** briefly press the middle of cover ①.
The stowage compartment opens.
- ▶ Press in cigarette lighter ②.
Cigarette lighter ② will pop out automatically when the heating element is red-hot.
- ▶ **To close:** fold down cover ①.

12 V sockets

Points to observe before use

- ▶ Select SmartKey position 1 (▶ page 111) using the Start/Stop button.

The sockets can be used for accessories with a maximum current draw of 180 W (15 A) each, e.g. bulbs or chargers for mobile phones.

If you use the sockets for long periods when the engine is switched off, the battery may discharge.

- i** You can also use the sockets when the ignition is switched off. An emergency cut-out ensures that the on-board voltage does not drop too low. If the on-board voltage is too low, the power to the sockets is automatically cut. This ensures that there is sufficient power to start the vehicle.

Socket in the glove box

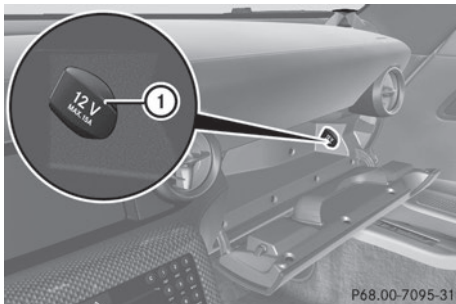

- ▶ Open the glove box (▷ page 186).
Lift up the cover of socket ①.

Socket on the center console

! If accessories are connected, make sure that a maximum current draw of 15 A is not exceeded. Otherwise, you will overload the fuse.

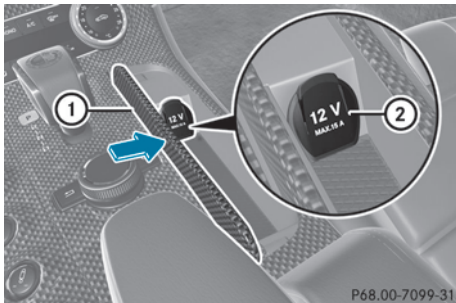

- ▶ **To open:** briefly press the middle of cover ①.
The stowage compartment opens.
- ▶ Lift up the cover of socket ②.
- ▶ **To close:** fold down cover ①.

mbrace⁴

General notes

You must have a license agreement to activate the mbrace service. Ensure that your

system is activated and ready for use, and press the  MB Info call button to register. If one of these steps is not carried out, it may not be possible to activate the system.

If you have questions about the activation, contact one of the following telephone hotlines:

- **USA:** Mercedes-Benz Customer Assistance Center at
1-800-FOR-MERCEdes (1-800-367-6372)
or 1-866-990-9007
- **Canada:** Customer Service at
1-888-923-8367

Shortly after successfully registering with the mbrace service, a user ID and password will be sent to you by mail.



USA only: you can use this password to log onto the mbrace area under "Owners Online" at <http://www.mbusa.com>.

The mbrace system is available if:

- it has been activated and is operational
 - the corresponding mobile phone network is available for transmitting data to the Customer Center
 - a service subscription is available
 - the starter battery is sufficiently charged
- i** Determining the location of the vehicle on a map is only possible if:
- GPS reception is available.
 - the vehicle position can be forwarded to the Customer Assistance Center.

The mbrace system

To adjust the volume during an mbrace call, proceed as follows:

- ▶ Press the  or  button on the multifunction steering wheel.

or

- ▶ Use the volume controller of COMAND.

⁴ The system is called TELE AID in Canada.

The mbrace system provides various services, e.g.:





- Automatic and manual emergency call
- Roadside Assistance call
- MB Info call

USA only: you can find information and a description of all available features under "Owners Online" at <http://www.mbusa.com>.

Self-diagnosis of the system

After you have switched on the ignition, the system carries out a self-diagnosis.

A malfunction in the system has been detected if one of the following conditions occurs:

- The indicator lamp in the SOS button does not come on during the system self-test.
- The indicator lamp in the  Roadside Assistance button does not light up during self-diagnosis of the system.
- The indicator lamp in the  MB Info call button does not light up during self-diagnosis of the system.
- The indicator lamp in one or more of the following buttons continues to light up red after the system self-diagnosis:
 - SOS button
 -  Roadside Assistance call button
 -  MB Info call button
- the **Tele Aid Inoperative** or **Tele Aid Not Activated** message appears in the multifunction display after the system self-diagnosis.

If a malfunction is indicated as outlined above, the system may not operate as expected. In the event of an emergency, help will have to be summoned by other means.

Have the system checked at the nearest authorized Mercedes-Benz Center or contact the following service hotlines:

- **USA:** Mercedes-Benz Customer Assistance Center at

1-800-FOR-MERCEdes (1-800-367-6372) or 1-866-990-9007

- **Canada:** Customer Service at 1-888-923-8367

Emergency call

Important safety notes

! You must have a license agreement to activate the mbrace service. Ensure that your system is activated and ready for use, and press the  MB Info call button to register. If one of these steps is not carried out, it may not be possible to activate the system.

If you have questions about the activation, contact one of the following telephone hotlines:

- **USA:** Mercedes-Benz Customer Assistance center at 1-800-FOR-MERCEdes (1-800-367-6372) or 1-866-990-9007
- **Canada:** Customer Service at 1-888-923-8367

General notes

An emergency call is dialed automatically if an air bag or Emergency Tensioning Device is triggered.

i You cannot end an automatically triggered emergency call yourself.

An emergency call can also be initiated manually.

As soon as the emergency call has been initiated, the indicator lamp in the SOS button flashes. The **Connecting Call** message appears in the multifunction display.

The audio output is muted.

Once the connection has been made, the **Call Connected** message appears in the multifunction display.

All important information on the emergency call is transmitted, for example:

- Current location of the vehicle (as determined by the GPS system)
- Vehicle identification number
- Information on the type of emergency

Shortly after the emergency call has been initiated, a voice connection is automatically established between the Mercedes-Benz Customer Assistance Center and the vehicle occupants.

- If the vehicle occupants respond, the Mercedes-Benz Customer Assistance Center attempts to get more information on the emergency.
- If there is no response from the vehicle occupants, an ambulance is immediately sent to the vehicle.

The mbrace system cannot initiate an emergency call if a voice connection cannot be established with the Response Center. This can occur for instance if the relevant mobile phone network is not available. The indicator lamp in the SOS button flashes continuously.

The **Call Failed** message appears in the multifunction display for approximately ten seconds.

In this case, summon assistance by other means.

Making an emergency call

WARNING

It can be dangerous to remain in the vehicle, even if you have pressed the SOS button in an emergency if:

- you see smoke inside or outside of the vehicle, e.g. if there is a fire after an accident
- the vehicle is on a dangerous section of road
- the vehicle is not visible or cannot easily be seen by other road users, particularly when dark or in poor visibility conditions

There is a risk of an accident and injury.

Leave the vehicle immediately in this or similar situations as soon as it is safe to do so. Move to a safe location along with other vehicle occupants. In such situations, secure the vehicle in accordance with national regulations, e.g. with a warning triangle.

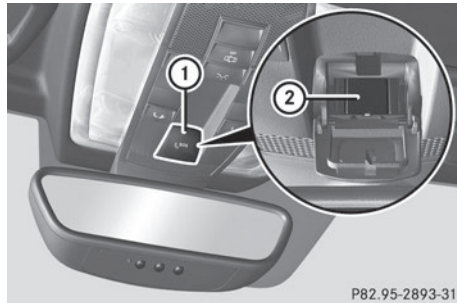

- ▶ **To initiate an emergency call manually:** press cover ① briefly to open.
- ▶ Press SOS button ② briefly. The indicator lamp in SOS button ② flashes until the emergency call is concluded.
- ▶ Wait for a voice connection to the Mercedes-Benz Customer Assistance Center.
- ▶ After the emergency call, close cover ①.

i If the mobile phone network is unavailable, mbrace will not be able to make the emergency call. If you leave the vehicle immediately after pressing the SOS button, you will not know whether mbrace placed the emergency call. In this case, always summon assistance by other means.

Roadside Assistance button



P82.95-2894-31

- ▶ Press Roadside Assistance button ① for more than two seconds. This initiates a call to the Mercedes-Benz Customer Assistance Center. The indicator lamp in Roadside Assistance button ① flashes while the call is active. The **Connecting Call** message appears on the multifunction display. The audio output is muted.

If a connection can be made, the **Call Connected** message appears in the multifunction display.

If a cellular phone network is available and there is sufficient GPS reception, the mbrace system transmits data to the Mercedes-Benz Customer Assistance Center, for example:

- Current location of the vehicle
- Vehicle identification number

- ❗ The COMAND display shows that an mbrace call is active. During the call, you can change to the navigation menu by pressing the NAVI button on COMAND, for example.

Voice output is not available.

A voice connection is established between the Mercedes-Benz Customer Assistance Center and the vehicle occupants.

The Mercedes-Benz Customer Assistance Center either sends a qualified Mercedes-Benz technician or arranges for your vehicle to be transported to the nearest authorized Mercedes-Benz Center. You may be charged for services such as repair work and/or

towing. Further details are available in your mbrace manual.

- ❗ The mbrace system failed to initiate a Roadside Assistance call if:

- the indicator lamp for Roadside Assistance call button ① is flashing continuously.
- no voice connection to the Mercedes-Benz Customer Assistance Center was established.

This may be because the corresponding mobile phone network is not available.

The **Call Failed** message appears in the multifunction display.

- ▶ **To end a call:** press the  button on the multifunction steering wheel.

or

- ▶ Press the corresponding button for ending a phone call on COMAND.

MB Info call button

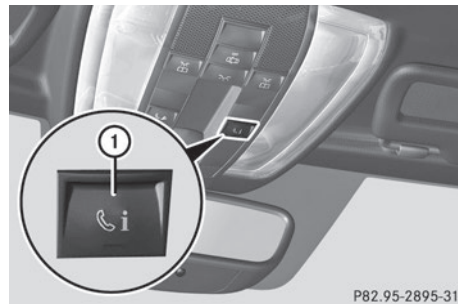

P82.95-2895-31

- ▶ Press MB Info call button ① for more than two seconds.

This initiates a call to the Mercedes-Benz Customer Assistance Center. The indicator lamp in MB Info call button ① flashes while the connection is being made. The **Connecting Call** message appears in the multifunction display and the COMAND system is muted.

If a connection can be made, the **Call Connected** message appears in the multifunction display.

If a cellular phone network is available and there is sufficient GPS reception, the mbrace system transmits data to the Mercedes-Benz Customer Assistance Center, for example:

- Current location of the vehicle
- Vehicle identification number

i The COMAND display shows that an mbrace call is active. During the call, you can change to the navigation menu by pressing the NAVI button on COMAND, for example.

Voice output is not available.

A voice connection is established between the Mercedes-Benz Customer Assistance Center and the vehicle occupants. You can obtain information on how to operate your vehicle's systems, on the location of the nearest authorized Mercedes-Benz Center, and on further products and services offered by Mercedes-Benz USA.

USA only: you can find further information on the mbrace system under "Owners Online" at <http://www.mbusa.com>.

i The mbrace system failed to initiate an MB Info call if:

- the indicator lamp in MB Info call button  is flashing continuously.
- no voice connection to the Mercedes-Benz Customer Assistance Center was established.

This may be because the corresponding mobile phone network is not available.

The **Call Failed** message appears in the multifunction display.

► **To end a call:** press the  button on the multifunction steering wheel.

or

► Press the corresponding button for ending a phone call on COMAND.

Call priority

When service calls are active, e.g. Roadside Assistance or MB Info calls, an emergency call can still be initiated. In this case, an emergency call will take priority and override all other active calls.

The indicator lamp of the respective button flashes until the call is ended. An emergency call can only be terminated by the Mercedes-Benz Customer Assistance Center.

All other calls can be ended by pressing:

- the  button on the multifunction steering wheel
- or the corresponding COMAND button for ending a telephone call

i If an mbrace call is initiated, audio output is muted. The mobile phone is no longer connected to COMAND. If you must use your mobile phone, we recommend that you do this only when the vehicle is stationary and in a safe location.

Downloading destinations in COMAND

Downloading destinations

i Information on the components and operating principles of COMAND can be found in the separate COMAND operating instructions.

This service is part of the mbrace PLUS Package and cannot be purchased separately.

i You can only use the Destination Download function if the vehicle is equipped with a navigation system.

Destination Download gives you access to a data bank with over 15 million Points of Interest (POIs). These can be downloaded on the navigation system in your vehicle. If you know the destination, the address can be downloaded. Alternatively, you can obtain the location of Points of Interest (POIs)/important destinations in the vicinity.

You are prompted to confirm route guidance to the address entered.

The system calculates the route and subsequently starts the route guidance with the address entered.

- i** If you select **No**, the address can be stored in the address book.
- i** The Destination Download function is available if the corresponding mobile phone network is available and data transfer is possible.

Route Assistance

This service is part of the mbrace PLUS Package and cannot be purchased separately.

- i** You can also use the Route Assistance function if your vehicle is not equipped with a navigation system.

Within the framework of this service, you receive a professional and reliable form of navigation support without having to leave your vehicle.

The customer service representative determines a suitable driving route based on your current vehicle position and the desired destination and guides you live through the current sections of the route.

Search & Send

"Search & Send" is a destination entry service. You can find further information on "Search & Send" in the separate COMAND operating instructions.

Vehicle remote closing

The remote closing feature can be used when you have forgotten to lock the vehicle and you are no longer nearby. The vehicle can then be locked by the Mercedes-Benz Customer Assistance Center.

The vehicle can be locked remotely up to four days after the ignition was last switched off.

- ▶ Contact the following service hotlines:

- **USA:** Mercedes-Benz Customer Assistance Center at 1-800-FOR-MERCEdes (1-800-367-6372) or 1-866-990-9007
 - **Canada:** Customer Service at 1-888-923-8367
- You will be asked for your PIN.

The next time you are inside the vehicle and you switch on the ignition, the **Tele Aid Doors Locked Remotely** message appears in the multifunction display.

USA only: alternatively, the vehicle can be locked via:

- the Internet, under the "Owners Online" section
- the telephone application (e.g. iPhone®, Blackberry)

To do this, you will need your identification number and password.

- i** The vehicle remote closing feature is available when the relevant mobile phone network is available and data connection is possible.

Stolen vehicle recovery service

If your vehicle has been stolen:

- ▶ Notify the police.
The police will issue a numbered incident report.
- ▶ This number will be forwarded to the Mercedes-Benz Customer Assistance Center together with your PIN.
The Mercedes-Benz Customer Assistance Center then attempts to locate the mbrace system. The Mercedes-Benz Customer Assistance Center contacts you and the local law enforcement agency if the vehicle is located. However, only the law enforcement agency is informed of the location of the vehicle.

- i** If the anti-theft alarm system is active for longer than 30 seconds, mbrace automatically informs the Mercedes-Benz Customer Assistance Center.

Rear spoiler

The rear spoiler improves vehicle downforce, and consequently improves driving stability. The rear spoiler can be set to a steep or flat position.

When the spoiler is set to the steep position, rear axle downforce increases and air resistance increases slightly.

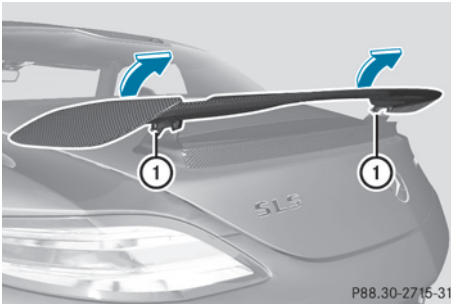

- ▶ **To adjust the position:** unscrew screws ① with a socket wrench.
- ▶ Clean the screws and threaded bolts or replace them with parts set A197 793 05 88.
- ▶ Move the rear spoiler to the upper or lower stop limit.
- ▶ Cover screws ① with a soluble, medium-strength screw locking material and tighten them again.
Tightening torque: 7.37 ft-lb (10 Nm)

Garage door opener

Important safety notes

WARNING

When you operate or program the garage door with the integrated garage door opener, persons in the range of movement of the garage door can become trapped or struck by the garage door. There is a risk of injury.

When using the integrated garage door opener, always make sure that nobody is

within the range of movement of the garage door.

WARNING

Combustion engines emit poisonous exhaust gases such as carbon monoxide. Inhaling these exhaust gases leads to poisoning. There is a risk of fatal injury. Therefore never leave the engine running in enclosed spaces without sufficient ventilation.

The HomeLink® garage door opener integrated in the rear-view mirror allows you to operate up to three different door and gate systems.

Use the integrated garage door opener only on garage doors that:

- have safety stop and reverse features and
- meet current U.S. federal safety standards

When programming a garage door opener, park the vehicle outside the garage.

- ❗ Certain garage door drives are incompatible with the integrated garage door opener. If you have difficulty programming the integrated garage door opener, contact an authorized Mercedes-Benz Center.

Alternatively, you can call the following telephone assistance services:

- **USA:** Mercedes-Benz Customer Assistance Center at 1-800-FOR-MERCEDES
- **Canada:** Customer Service at 1-800-387-0100

- ❗ Notes about the declaration of conformity can be found here (▷ page 21).

USA: FCC ID: CB2HMIHL4

Canada: IC: 279B-HMIHL4

Programming

Programing buttons

Pay attention to the "Important safety notes" (> page 196).

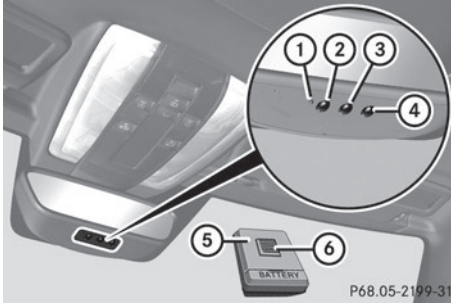

Integrated garage door opener in the rear-view mirror

Garage door remote control ⑤ is not part of the integrated garage door opener.

- ▶ Before programming for the first time, clear the integrated garage door opener memory (> page 199).
- ▶ Select key position **2** with the Start/Stop button (> page 111).
- ▶ Press and hold one of buttons ② to ④ on the integrated garage door opener. After a short time, indicator lamp ① lights up yellow.
 - ❗ Indicator lamp ① lights up yellow as soon as button ②, ③ or ④ is programmed for the first time. If the selected button has already been programmed, indicator lamp ① will only light up yellow after ten seconds have elapsed.
- ▶ Release button ②, ③ or ④. Indicator lamp ① flashes yellow.
- ▶ Point garage door remote control ⑤ towards buttons ② to ④ on the rear-view mirror at a distance of 2 to 8 inches (5 to 20 cm).
 - ❗ The required distance between remote control ⑤ and the integrated garage door opener depends on the garage door drive system. Several attempts might be

necessary. You should test every position for at least 25 seconds before trying another position.

- ▶ Press and hold button ⑥ on remote control ⑤ until indicator lamp ① lights up green. If indicator lamp ① lights up green or flashes, then programming was successful.
- ▶ Release button ⑥ on remote control ⑤ for the garage door drive system.
- ▶ If indicator lamp ① lights up red: repeat the programming procedure for the corresponding button on the rear-view mirror. When doing so, vary the distance between remote control ⑤ and the rear-view mirror.

- ❗ If the indicator lamp flashes green after successful programming, the garage door system is using a rolling code. After programming, you must synchronize the garage door opener integrated in the rear-view mirror with the receiver of the garage door system.

Synchronizing the rolling code

Pay attention to the "Important safety notes" (> page 196).

Your vehicle must be within reach of the garage door or exterior gate drive. Make sure that neither your vehicle nor any persons/objects are present within the sweep of the door or gate.

- ▶ Select key position **2** with the Start/Stop button (> page 111).
- ▶ Press the programming button of the door or gate drive (see the door or gate drive operating instructions, e.g. under "Programming additional remote controls").
 - ❗ Usually, you now have 30 seconds to initiate the next step.
- ▶ Press previously programmed button ②, ③ or ④ of the integrated garage door opener until the door closes. The rolling code synchronization is then complete.

Notes on programing the remote control

Canadian radio frequency laws require a "break" (or interruption) of the transmission signals after broadcasting for a few seconds. Therefore, these signals may not last long enough for the integrated garage door opener. The signal is not recognized during programing. Comparable with Canadian law, some U.S. garage door openers also feature a "break".

Proceed as follows:

- if you live in Canada
- if you have difficulties programing the garage door opener (regardless of where you live) when using the programing steps
- ▶ Press and hold one of buttons ② to ④ on the integrated garage door opener. After a short time, indicator lamp ① lights up yellow.
- ▶ Release the button. Indicator lamp ① flashes yellow.
- ▶ Press button ⑥ of garage door remote control ⑤ for two seconds, then release it for two seconds.
- ▶ Press button ⑥ again for two seconds.
- ▶ Repeat this sequence on button ⑥ of remote control ⑤ until indicator lamp ① lights up green. If indicator lamp ① turns red, repeat the process.
- ▶ Continue with the other programing steps (see above).

Problems when programing

If you are experiencing problems programing the integrated garage door opener on the rear-view mirror, take note of the following instructions:

- Check the transmitter frequency of garage door drive remote control ⑤. This can usually be found on the back of the remote control.

The integrated garage door opener is compatible with devices that have units

which operate in the frequency range of 280 to 433 MHz .

- Replace the batteries in garage door remote control ⑤. This increases the likelihood that garage door remote control ⑤ will transmit a strong and precise signal to the integrated garage door opener in the rear-view mirror.
- When programing, hold remote control ⑤ at varying distances and angles from the button that you are programing. Try various angles at a distance between 2 and 12 inches (5 to 30 cm) or at the same angle but at varying distances.
- If another remote control for the same garage door drive is available, repeat the same programing steps with this remote control. Before performing these steps, make sure that new batteries have been installed in garage door drive remote control ⑤.
- Note that some remote controls only transmit for a limited amount of time (the indicator lamp on the remote control goes out). Press button ⑥ on remote control ⑤ again before transmission ends.
- Align the antenna cable of the garage door opener unit. This can improve signal reception/transmission.

Opening/closing the garage door

Once programed, the integrated garage door opener ⑤ will assume the function of the garage door system's remote control. Please also read the operating instructions for the garage door system.

- ▶ Select key position 2 with the Start/Stop button.
- ▶ Press button ②, ③ or ④ which you have programed to operate the garage door.
 - Garage door system with a fixed code: indicator lamp ① lights up green.
 - Garage door system with a rolling code: indicator lamp ① flashes green.

- ▶ **i** The transmitter will transmit a signal as long as the button is pressed. The transmission is halted after a maximum of ten seconds and indicator lamp ① lights up yellow. Press button ②, ③ or ④ again if necessary.

Clearing the memory

- ▶ Select key position **2** with the Start/Stop button.
 - ▶ Press buttons ② and ④.
The indicator lamp lights up yellow.
 - ▶ Press and hold buttons ② and ④ until the indicator lamp turns green.
- ▶ **i** Make sure that you clear the memory of the integrated garage door opener before selling the vehicle.

Charge maintenance socket

The battery may drain if the vehicle is left stationary for long periods. In this case, Mercedes-Benz recommends attaching the trickle charger to the charge maintenance socket.

The charge maintenance socket is designed solely for connecting a trickle charger.

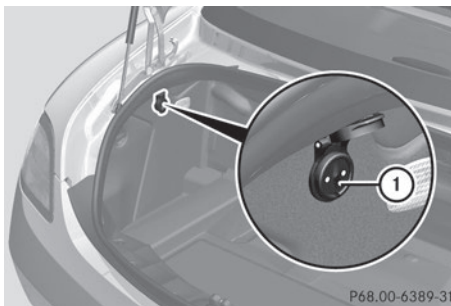

- ▶ Switch the ignition off.
- ▶ Open the trunk lid.
- ▶ Connect the cable provided in the trunk to the trickle charger.
- ▶ Connect the trickle charger to charge maintenance socket ①. Consult the

manufacturer's operating instructions on how to do so.

- ▶ **i** A trickle charger connected to charge maintenance socket ① only maintains the current charge level of the vehicle's electrical system battery. If the vehicle's electrical system battery is discharged, it needs to be charged with a battery charger. You will find further information on charging the battery at (▶ page 220).

Floormat on the driver's side

⚠ WARNING

Objects in the driver's footwell can restrict the pedal travel or obstruct a depressed pedal. The operating and road safety of the vehicle is jeopardized. There is a risk of an accident.

Make sure that all objects in the vehicle are stowed correctly, and that they cannot enter the driver's footwell. Install the floormats securely and as specified in order to ensure sufficient clearance for the pedals. Do not use loose floormats and do not place floormats on top of one another.

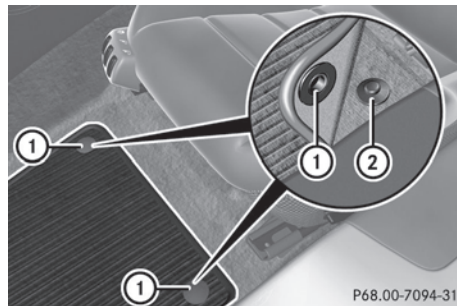

- ▶ Slide the seat backwards.
- ▶ **To install:** place the floormat in position.
- ▶ Press studs ① onto retainers ②.
- ▶ **To remove:** pull the floormat off retainers ②.
- ▶ Remove the floormat.

Useful information	202
Engine compartment	202
Maintenance	206
Care	207

Useful information

- i** This Operator's Manual describes all models and all standard and optional equipment of your vehicle available at the time of publication of the Operator's Manual. Country-specific differences are possible. Please note that your vehicle may not be equipped with all features described. This also applies to safety-related systems and functions.
- i** Please read the information on qualified specialist workshops (▷ page 21).

Engine compartment

Hood

Important safety notes

WARNING

If the hood is unlatched, it may open up when the vehicle is in motion and block your view. There is a risk of an accident.
Never unlatch the hood while driving.

WARNING

When opening and closing the hood, it may suddenly fall into the closed position. There is a risk of injury to persons within range of movement of the hood.
Open and close the hood only when no one is within its range of movement.

WARNING

Opening the hood when the engine is overheated or when there is a fire in the engine compartment could expose you to hot gases or other service products. There is a risk of injury.

Let an overheated engine cool down before opening the hood. If there is a fire in the engine compartment, keep the hood closed and contact the fire department.

WARNING

The engine compartment contains moving components. Certain components, such as the radiator fan, may continue to run or start again suddenly when the ignition is off. There is a risk of injury.

If you need to do any work inside the engine compartment,

- switch off the ignition
- never reach into the area where there is a risk of danger from moving components, such as the fan rotation area
- keep clothing away from moving parts

Opening the hood

WARNING

Certain components in the engine compartment, such as the engine, radiator and parts of the exhaust system, can become very hot. Working in the engine compartment poses a risk of injury.

Where possible, let the engine cool down and touch only the components described in the following.

WARNING

When the hood is open and the windshield wipers are set in motion, you can be injured by the wiper linkage. There is a risk of injury.
Always switch off the windshield wipers and the ignition before opening the hood.

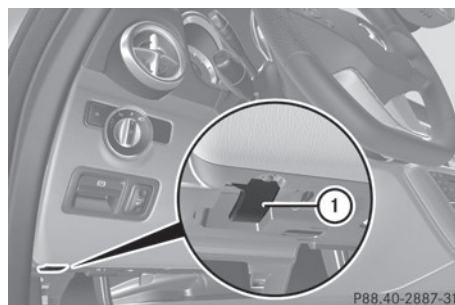

Hood release lever in driver's footwell

P88.40-2887-31

- ▶ Pull release lever ① on the hood.
The hood is released.

! Make sure that the windshield wipers are not folded away from the windshield. You could otherwise damage the windshield wipers or the hood.

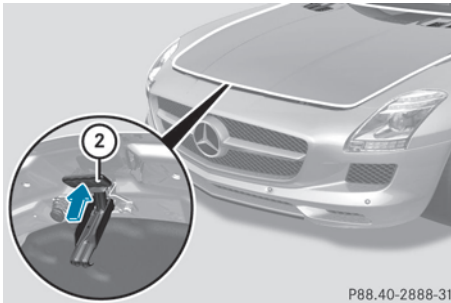

P88.40-2888-31

- ▶ Reach into the gap, pull hood catch handle ② up and lift the hood.

Closing the hood

- ▶ Lower the hood and let it fall from a height of approximately 8 inches (20 cm).
- ▶ Check that the hood has engaged properly. If the hood can be raised slightly, it is not properly engaged. Open it again and close it with a little more force.

Engine oil

General notes

Depending on the driving style, the vehicle consumes up to 0.9 US qt (0.8 l) of oil over a distance of 600 miles (1000 km). The oil consumption may be higher than this when the vehicle is new or if you frequently drive at high engine speeds.

Depending on the engine, the oil dipstick may be in a different location.

When checking the oil level:

- park the vehicle on a level surface.
- the engine should be switched off for approximately five minutes if the engine is at normal operating temperature.
- if the engine is not at normal operating temperature, e.g. if the engine was only started briefly, wait about 30 minutes before carrying out the measurement.

Checking the oil level using the oil dipstick

⚠ WARNING

Certain components in the engine compartment, such as the engine, radiator and parts of the exhaust system, can become very hot. Working in the engine compartment poses a risk of injury.

Where possible, let the engine cool down and touch only the components described in the following.

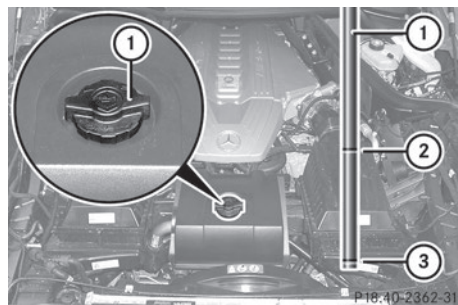

P16:40-2362-31

- ▶ Unscrew and remove oil filler cap ① with the integrated dipstick.
- ▶ Wipe the oil dipstick.
- ▶ Screw on oil filler cap ① again to the stop.
- ▶ Unscrew oil filler cap ① again and read the dipstick.
If the level is between MIN mark ③ and MAX mark ②, the oil level is correct.
- ▶ If the oil level has dropped to MIN mark ③ or below, add 1.1 US qt (1.0 liter) engine oil.

Adding engine oil

WARNING

Certain components in the engine compartment, such as the engine, radiator and parts of the exhaust system, can become very hot. Working in the engine compartment poses a risk of injury.

Where possible, let the engine cool down and touch only the components described in the following.

WARNING

If engine oil comes into contact with hot components in the engine compartment, it may ignite. There is a risk of fire and injury. Make sure that engine oil is not spilled next to the filler neck. Let the engine cool down and thoroughly clean the engine oil off the components before starting the engine.

Environmental note

When adding oil, take care not to spill any. If oil enters the soil or waterways, it is harmful to the environment.

! Only use engine oils and oil filters that have been approved for vehicles with a service system. You can obtain a list of the engine oils and oil filters tested and approved in accordance with the Mercedes-Benz Specifications for Service Products at any Mercedes-Benz Service center.

Damage to the engine or exhaust system is caused by the following:

- using engine oils and oil filters that have not been specifically approved for the service system
- replacing engine oil and oil filters after the interval for replacement specified by the service system has been exceeded
- using engine oil additives.

! Do not add too much oil. adding too much engine oil can result in damage to the

engine or to the catalytic converter. Have excess engine oil siphoned off.

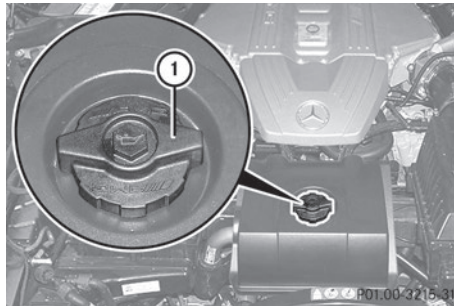

- ▶ Unscrew and remove oil filler cap ① with the integrated dipstick.
- ▶ Add engine oil.
If the oil level is at or below the MIN mark on the oil dipstick, add 1.1 US qt (1.0 l) of engine oil.
- ▶ Replace cap ① on the filler neck and tighten clockwise.
Ensure that the cap locks into place securely.
- ▶ Check the oil level again with the oil dipstick (▷ page 203).

You will find further information about engine oil in the "Technical data" section (▷ page 265).

Additional service products

Checking coolant level

WARNING

Certain components in the engine compartment, such as the engine, radiator and parts of the exhaust system, can become very hot. Working in the engine compartment poses a risk of injury.

Where possible, let the engine cool down and touch only the components described in the following.

⚠ WARNING

The engine cooling system is pressurized, particularly when the engine is warm. When opening the cap, you could be scalded by hot coolant spraying out. There is a risk of injury. Let the engine cool down before opening the cap. Wear eye and hand protection when opening the cap. Open the cap slowly half a turn to allow pressure to escape.

Only check the coolant level when the vehicle is on a level surface and the engine has cooled down.

- ▶ Set the Start/Stop button to key position **2**.
- ▶ Check the coolant temperature display in the "AMG" menu (> page 148). The coolant temperature must be below 158 °F (70 °C).

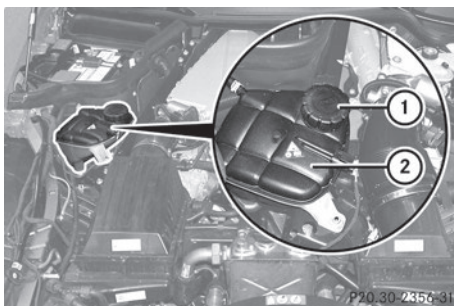

- ▶ Slowly turn cap **1** half a turn counter-clockwise and allow excess pressure to escape.
- ▶ Turn cap **1** further counter-clockwise and remove it. If the coolant is at the level of the marker bar in the filler neck when cold, there is enough coolant in coolant expansion tank **2**. If the coolant level is approximately 0.6 in (1.5 cm) above the marker bar in the filler neck when warm, there is enough coolant in coolant expansion tank **2**.

- ▶ If necessary, add coolant that has been tested and approved by Mercedes-Benz.
- ▶ Replace cap **1** and turn it clockwise as far as it will go.

You will find further information about coolant in the "Technical data" section (> page 267).

Windshield washer system and headlamp cleaning system

⚠ WARNING

Certain components in the engine compartment, such as the engine, radiator and parts of the exhaust system, can become very hot. Working in the engine compartment poses a risk of injury.

Where possible, let the engine cool down and touch only the components described in the following.

⚠ WARNING

Windshield washer concentrate is highly flammable. If it comes into contact with hot engine components or the exhaust system it could ignite. There is a risk of fire and injury. Make sure that no windshield washer concentrate is spilled next to the filler neck.

The washer fluid reservoir is used for both the windshield washer system and the headlamp cleaning system.

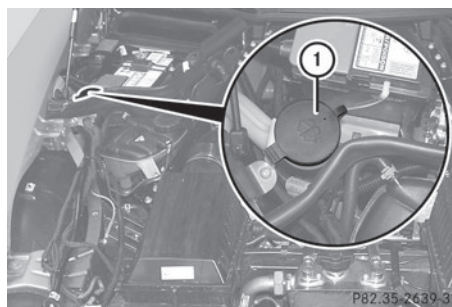

- ▶ **To open:** pull cap ① upwards by the tab.
- ▶ Add the premixed washer fluid.
- ▶ **To close:** press cap ① onto the filler neck until it engages.

If the washer fluid level drops below the recommended minimum of 1 liter, a message appears in the multifunction display prompting you to add washer fluid (▷ page 172).

Further information on windshield washer fluid/antifreeze (▷ page 268).

Maintenance

Service interval display

Service messages

Information on the type of service and service intervals (see the separate Maintenance Booklet).

You can obtain further information from an authorized Mercedes-Benz Center or at <http://www.mbusa.com> (USA only).

The service interval message informs you of the next service due date.

If a service due date has been exceeded, you also hear a warning tone.

The multifunction display shows a service message for several seconds, e.g.:

Next Service A in .. days

Service A Due

Service A Exceeded by .. days

The letter indicates which service is due. **A** stands for a minor service and **B** for a major service. A number or another letter may be displayed after the letter. This figure indicates any necessary additional maintenance work to be performed.

You can obtain further information from an authorized Mercedes-Benz Center.

The service interval display does not take into account any periods of time during which the battery is disconnected.

Maintaining the time-dependent service schedule:



- ▶ Note down the service due date displayed in the multifunction display before disconnecting the battery.

or





- ▶ After reconnecting the battery, subtract the battery disconnection periods from the service date shown on the display.

i The service interval display does not provide any information regarding the engine's oil level. Observe the notes on the engine oil level (▷ page 203).

Hiding a service message

- ▶ Press the  or  button on the steering wheel.

Displaying service messages

- ▶ Switch on the ignition.
- ▶ Press the  or  button on the steering wheel to select the **Serv.** menu.
- ▶ Press the  or  button to select the **ASSYST PLUS** submenu and confirm by pressing the  button.
The service due date appears in the multifunction display.

Points to remember

Resetting the service interval display

A qualified specialist workshop, e.g. an authorized Mercedes-Benz Center, will reset the service interval display after the necessary service work has been carried out. You can also obtain further information on maintenance work, for example.

- !** If the service interval display has been reset unintentionally, have the setting corrected at a Mercedes-Benz Center. Have service work carried out as described in the Maintenance Booklet. This may otherwise lead to increased wear and

damage to the major assemblies or the vehicle.

Special service requirements

The specified maintenance interval takes only the normal operation of the vehicle into account. Under arduous operating conditions or increased load on the vehicle, maintenance work must be carried out more frequently, for example:

- regular city driving with frequent intermediate stops
- if the vehicle is primarily used to travel short distances
- use in mountainous terrain or on poor road surfaces
- if the engine is often left idling for long periods

Under these or similar conditions, have, for example, the air filter, engine oil and oil filter replaced or changed more frequently. Under arduous operating conditions, the tires must be checked more often. Further information can be obtained at a qualified specialist workshop, e.g. an authorized Mercedes-Benz Center.

Driving abroad

An extensive Mercedes-Benz Service network is also available in other countries. You can obtain further information from any authorized Mercedes-Benz Center.

Care

General notes

Regular care of your vehicle is a condition for retaining the quality in the long term.

Use care products and cleaning agents recommended and approved by Mercedes-Benz.

! For cleaning your vehicle, do not use any of the following:

- dry, rough or hard cloths
- abrasive cleaning agents

- solvents
- cleaning agents containing solvents

Do not scrub.

Do not touch the surfaces or protective films with hard objects, e.g. a ring or ice scraper. You could otherwise scratch or damage the surfaces and protective film.

Environmental note

Dispose of empty packaging and cleaning cloths in an environmentally responsible manner.

! Do not park the vehicle for an extended period straight after cleaning it, particularly after having cleaned the wheels with wheel cleaner. Wheel cleaners could cause increased corrosion of the brake discs and brake pads/linings. For this reason, you should drive for a few minutes after cleaning. Braking heats the brake discs and the brake pads/linings, thus drying them. The vehicle can then be parked.

Exterior care

Automatic car wash

WARNING

Braking efficiency is reduced after washing the vehicle. There is a risk of an accident.

After the vehicle has been washed, brake carefully while paying attention to the traffic conditions until full braking power is restored.

You can wash the vehicle in an automatic car wash from the very start.

If the vehicle is very dirty, pre-wash it before cleaning it in an automatic car wash.

! Never clean your vehicle in a Touchless Automatic Car Wash as these use special cleaning agents. These cleaning agents can damage the paintwork or plastic parts.

! When washing your vehicle in a tow-through car wash, use the SmartKey instead of the Start/Stop button.

Start the engine using the SmartKey. Move the transmission to **N** with the E-SELECT lever. Use the SmartKey to switch the engine off again and then turn the SmartKey to position **2**. Make sure that you then leave the SmartKey in position **2**. You may otherwise damage the vehicle, the transmission or the car wash.

Check the transmission position in the instrument cluster.

- ❗ Use the E-SELECT lever to shift the transmission to **N** before switching the engine off. If you open the driver's or front-passenger door, the transmission remains in this position for up to 30 minutes if the SmartKey is in the ignition, even if the engine is switched off. If you do not shift the transmission to **N** using the E-SELECT lever beforehand, it shifts automatically to parking position **P** and locks the wheels if the driver's or front-passenger door is opened and the engine is switched off. This may damage the vehicle, the transmission or the car wash.

Observe the information on maneuvering (> page 124).

- ❗ Before driving into an automatic car wash, make sure that it is suitable for the dimensions of the vehicle. In particular, make sure that:

- there is enough ground clearance between the vehicle underbody and the guide rails of the automatic car wash.
- the clearance width of the automatic car wash is sufficient, particularly the width of the guide rails.
- you enter the automatic car wash straight and in the center of the guide rails in order to avoid damaging the tires or wheel rims.

Fold in the exterior mirrors before the vehicle is washed. The exterior mirrors could otherwise be damaged.

- ❗ Make sure that:

- the side windows and the roof are completely closed
- the climate control blower is switched off
- the windshield wiper switch is at position **0**

The vehicle could otherwise be damaged.

- ❗ In portal car washes, the windshield wipers may be moved up the windshield by the cleaning brushes when the ignition is switched off.

Set the Start/Stop button to key position **2** to reset the windshield wipers to their original position.

After using an automatic car wash, wipe off wax and drying agents from the windshield and the wiper blades. This will prevent smears and reduce wiping noises caused by residue on the windshield.

Washing by hand

In some countries, washing by hand is only allowed at specially equipped washing bays. Observe the legal requirements in each country.

- ▶ Do not use hot water and do not wash the vehicle in direct sunlight.
- ▶ Use a soft sponge to clean.
- ▶ Use a mild cleaning agent, such as a car shampoo approved by Mercedes-Benz.
- ▶ Thoroughly hose down the vehicle with a gentle jet of water.
- ▶ Do not point the water jet directly towards the air inlet.
- ▶ Use plenty of water and rinse out the sponge frequently.
- ▶ Rinse the vehicle with clean water and dry thoroughly with a chamois.
- ▶ Do not let the cleaning agent dry on the paintwork.

Carefully remove all deposits of road salt as soon as possible when driving in winter.

Power washers

WARNING

The water jet from a circular jet nozzle (dirt blasters) can cause invisible exterior damage to the tires or chassis components.

Components damaged in this way may fail unexpectedly. There is a risk of an accident.

Do not use power washers with circular jet nozzles to clean the vehicle. Have damaged tires or chassis components replaced immediately.

- !** Always maintain a distance of at least 11.8 in (30 cm) between the vehicle and the power washer nozzle. Information about the correct distance is available from the equipment manufacturer.

Move the power washer nozzle around when cleaning your vehicle.

Do not aim directly at any of the following:

- tires
- door gaps, roof gaps, joints, etc.
- electrical components
- battery
- connectors
- lights
- seals
- trim
- ventilation slots

Damaged seals or electrical components can lead to leaks or failures.

Cleaning the wheels

- !** Do not use acidic wheel cleaning products to remove brake dust. This could damage wheel bolts and brake components.

- !** Do not park the vehicle for an extended period straight after cleaning it, particularly after having cleaned the wheels with wheel cleaner. Wheel cleaners could cause increased corrosion of the brake discs and brake pads/linings. For this reason, you should drive for a few minutes after

cleaning. Braking heats the brake discs and the brake pads/linings, thus drying them. The vehicle can then be parked.

Cleaning the paintwork

Scratches, corrosive deposits, areas affected by corrosion and damage caused by inadequate care cannot always be completely repaired. In such cases, visit a qualified specialist workshop, e.g. an authorized Mercedes-Benz Center.

- ▶ Remove impurities immediately, where possible, whilst avoiding rubbing too hard.
- ▶ Soak insect remains with insect remover and rinse off the treated areas afterwards.
- ▶ Soak bird droppings with water and rinse off the treated areas afterwards.
- ▶ Remove coolant, brake fluid, tree resin, oils, fuels and greases by rubbing gently with a cloth soaked in petroleum ether or lighter fluid.
- ▶ Use tar remover to remove tar stains.
- ▶ Use silicone remover to remove wax.

- !** Do not affix:

- stickers
 - films
 - magnetic plates or similar items
- to painted surfaces. You could otherwise damage the paintwork.

If water no longer forms "beads" on the paint surface, use the paint care products recommended and approved by Mercedes-Benz. This is the case approximately every three to five months, depending on the climate conditions and the care product used. If dirt has penetrated the paint surface or the paint has become dull, the paint cleaner recommended and approved by Mercedes-Benz should be used.

Do not use these care products in the sun or on the hood while the hood is hot.

- ▶ Use a suitable touch-up stick, e.g. MB Touch-Up Stick, to correct smaller areas of paint damage quickly and provisionally.

Matte finish care

If your vehicle has a clear matte finish, observe the following instructions in order to avoid damage to the paintwork due to incorrect care.

These notes also apply to light alloy wheels with a clear matte finish.

! Never polish the vehicle or the light alloy wheels. Polishing causes the finish to shine.

! The following may cause the paint to become shiny and thus reduce the matte effect:

- Vigorous rubbing with unsuitable materials.
- Frequent use of car washes.
- Washing the vehicle in direct sunlight.

! Never use paint cleaner, buffing or polishing products such as gloss preserver (wax). These products are only suitable for high-gloss surfaces. Their use on vehicles with matte finish leads to considerable surface damage (shiny, spotted areas).

If wax comes into contact with the painted surface by accident, remove it immediately with commercially available petroleum ether. Do so carefully and do not apply too much pressure to the painted surface.

Ensure that no resinous, greasy or oily substances come into contact with the paint, as these can leave a residue. If such substances do come into contact with the painted surface accidentally, remove these immediately with commercially available petroleum ether. Do so carefully and do not apply too much pressure to the painted surface.

Tar stains or marks on the painted surface can be removed with a commercially available tar remover. Do so carefully and

do not apply too much pressure to the painted surface.

Always have paintwork repairs carried out at a qualified specialist workshop, e.g. an authorized Mercedes-Benz Center.

! Do not use wash programs with a hot wax treatment under any circumstances.

i The vehicle should preferably be washed by hand using a soft sponge, car shampoo and plenty of water.

i Use only insect remover and car shampoo from the range of recommended and approved Mercedes-Benz care products.

Cleaning the windows

WARNING

You could become trapped by the windshield wipers if they start moving while cleaning the windshield or wiper blades. There is a risk of injury.

Always switch off the windshield wipers and the ignition before cleaning the windshield or wiper blades.

! Only fold the windshield wipers away from the windshield when vertical. Otherwise, you will damage the hood.

▶ Clean the inside and outside of the windows with a damp cloth and a cleaning product that is recommended and approved by Mercedes-Benz.

! Do not use dry cloths, abrasive products, solvents or cleaning agents containing solvents to clean the inside of the windows. Do not touch the insides of the windows with hard objects, e.g. an ice scraper or ring. There is otherwise a risk of damaging the windows.

! Clean the water drainage channels of the windshield and the rear window at regular intervals. Deposits such as leaves, petals and pollen may under certain circumstances prevent water from draining

away. This can lead to corrosion damage and damage to electronic components.

Cleaning wiper blades

WARNING

You could become trapped by the windshield wipers if they start moving while cleaning the windshield or wiper blades. There is a risk of injury.

Always switch off the windshield wipers and the ignition before cleaning the windshield or wiper blades.

- !** Only fold the windshield wipers away from the windshield when vertical. Otherwise, you will damage the hood.
- !** Do not pull the wiper blade. Otherwise, the wiper blade could be damaged.
- !** Do not clean wiper blades too often and do not rub them too hard. Otherwise, the graphite coating could be damaged. This could cause wiper noise.
- ▶ Switch off the engine.
- ▶ Remove your foot from the brake pedal.
- ▶ Set the windshield wiper to the  position on the combination switch.
- ▶ Press the Start/Stop button repeatedly until the windshield wiper starts.
- ▶ When the wiper arms have reached a vertical position, press the Start/Stop button.
- ▶ Fold the wiper arm away from the windshield until it engages.
- ▶ Set the wiper blade at right angles to the wiper arm.
- ▶ Carefully clean the wiper blades with a damp cloth.
- ▶ Fold the windshield wiper arms back again before switching on the ignition.
- !** Hold the wiper arm securely when folding back. The windshield could be damaged if the wiper arm smacks against it suddenly.

Cleaning the exterior lighting

- ▶ Clean the plastic lenses of the exterior lighting using a wet sponge and a mild cleaning agent, e.g. Mercedes-Benz car shampoo or cleaning cloths.
- !** Only use cleaning agents or cleaning cloths which are suitable for plastic light lenses. Unsuitable cleaning agents or cleaning cloths could scratch or damage the plastic light lenses.

Cleaning the mirror turn signals

- !** Only use cleaning agents or cleaning cloths that are suitable for plastic lenses. Unsuitable cleaning agents or cleaning cloths could scratch or damage the plastic lenses of the mirror turn signals.
- ▶ Clean the plastic lenses of the mirror turn signals in the exterior mirror housing using a wet sponge and a mild cleaning agent, e.g. Mercedes-Benz car shampoo or cleaning cloths.

Cleaning the exhaust pipes

- !** Do not clean the exhaust pipe with acid-based cleaning agents such as sanitary cleansers or wheel cleaners.
- ▶ Clean the exhaust pipe with a chrome care product tested and approved by Mercedes-Benz.

Impurities combined with the effects of road grit and corrosive environmental factors may cause flash rust to form on the surface. You can restore the original shine of the exhaust pipe by cleaning it regularly, especially in winter and after washing.

Interior care

Cleaning the display

! For cleaning, do not use any of the following:

- alcohol-based thinner or gasoline
- abrasive cleaning agents
- commercially-available household cleaning agents

These may damage the display surface. Do not put pressure on the display surface when cleaning. This could lead to irreparable damage to the display.

- ▶ Before cleaning the display, make sure that it is switched off and has cooled down.
- ▶ Clean the display surface using a commercially available microfiber cloth and TFT/LCD display cleaner.
- ▶ Dry the display surface using a dry microfiber cloth.

Cleaning the plastic trim

WARNING

Care products and cleaning agents containing solvents cause surfaces in the cockpit to become porous. As a result, plastic parts may come loose in the event of air bag deployment. There is a risk of injury.

Do not use any care products and cleaning agents to clean the cockpit.

! Do not affix the following to plastic surfaces:

- stickers
- films
- scented oil bottles or similar items

You can otherwise damage the plastic.

! Do not allow cosmetics, insect repellent or sunscreen to come into contact with the plastic trim. This maintains the high-quality look of the surfaces.

▶ Wipe the plastic trim with a damp, lint-free cloth, e.g. a microfiber cloth.

▶ **Heavy soiling:** use car care and cleaning products recommended and approved by Mercedes-Benz. The surface may change color temporarily. Wait until the surface is dry again.

Cleaning the steering wheel and selector lever

▶ Thoroughly wipe with a damp cloth or use leather care agents that have been recommended and approved by Mercedes-Benz.

Cleaning genuine wood and trim elements

! Do not use solvent-based cleaning agents such as tar remover, wheel cleaners, polishes or waxes. There is otherwise a risk of damaging the surface.

! Do not use chrome polish on trim pieces. The trim pieces have a chrome look but are mostly made of anodized aluminum and can lose their shine if chrome polish is used. Use a damp, lint-free cloth instead when cleaning the trim pieces.

If the chrome-plated trim pieces are very dirty, you can use a chrome polish. If you are unsure as to whether the trim pieces are chrome-plated or not, consult an authorized Mercedes-Benz Center.

▶ Wipe the wooden trim and trim pieces with a damp, lint-free cloth, e.g. a microfiber cloth.

▶ **Heavy soiling:** use care and cleaning products recommended and approved by Mercedes-Benz.

Cleaning the seat covers

General notes

! Do not use microfibre cloths to clean genuine leather, artificial leather or DINAMICA covers. If used often, these can damage the cover.

i Note that regular care is essential to ensure that the appearance and comfort of the covers is retained over time.

Genuine leather seat covers

Leather is a natural product.

It exhibits natural surface characteristics, for example:

- differences in the texture
- signs of stretching and marking
- slight nuances of color

These are characteristics of leather and not material defects.

! To retain the natural appearance of the leather, observe the following cleaning instructions:

- Clean genuine leather covers carefully with a damp cloth and then wipe the covers down with a dry cloth.
- Make sure that the leather does not become soaked. It may otherwise become rough and cracked.
- Only use leather care agents that have been tested and approved by Mercedes-Benz. You can obtain these from a qualified specialist workshop.

Seat covers of other materials

! Observe the following when cleaning:

- Clean artificial leather covers with a cloth moistened with a solution containing 1% detergent (e.g. dish washing liquid).
- Clean cloth covers with a microfibre cloth moistened with a solution containing 1% detergent (e.g. dish washing liquid). Rub carefully and always wipe entire seat sections to avoid leaving visible lines. Leave the seat to dry

afterwards. Cleaning results depend on the type of dirt and how long it has been there.

- Clean Alcantara® covers with a damp cloth. Make sure that you wipe entire seat sections to avoid leaving visible lines.

Cleaning the seat belts

WARNING

Seat belts can become severely weakened if bleached or dyed. This could cause the seat belts to tear or fail, for instance, in the event of an accident. This poses an increased risk of injury or fatal injury.

Never bleach or dye the seat belts.

! Do not clean the seat belts using chemical cleaning agents. Do not dry the seat belts by heating at temperatures above 176 °F (80 °C) or in direct sunlight.

- ▶ Use clean, lukewarm water and soap solution.

Useful information	216
Where will I find...?	216
Flat tire	217
Battery (vehicle)	220
Jump-starting	224
Towing and tow-starting	226
Fuses	228

Useful information

- i** This Operator's Manual describes all models and all standard and optional equipment of your vehicle available at the time of publication of the Operator's Manual. Country-specific differences are possible. Please note that your vehicle may not be equipped with all features described. This also applies to safety-related systems and functions.
- i** Please read the information on qualified specialist workshops (▷ page 21).

Where will I find...?

First-aid kit

The first-aid kit is located in the left-hand stowage compartment in the trunk.

- ▶ Open the trunk lid.

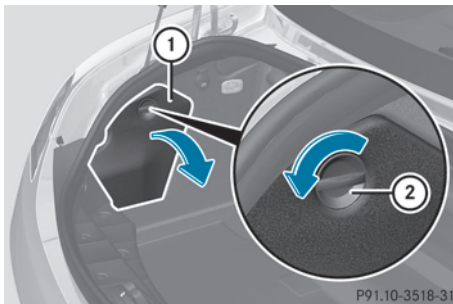

- ▶ Turn fastener **2** in the direction of the arrow.
 - ▶ Open stowage compartment **1**.
 - ▶ Open the Velcro fastener and remove the first aid kit.
- i** Check the expiration date on the first-aid kit at least once a year. Replace the contents if necessary, and replace missing contents.

Vehicle tool kit

Wheel-change tool kit and jack⁵

The wheel-change tool kit and the jack are located in the left-hand stowage space in the trunk.

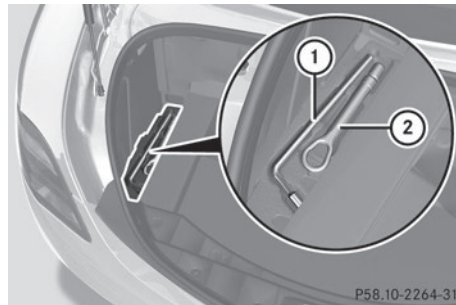

Left-hand stowage space in trunk floor

- 1** Lug wrench
 - 2** Towing eye
- ▶ Pull the loop on the floor covering and fold the floor covering forward.
 - ▶ Take out the jack and lug wrench **1** underneath it.

TIREFIT kit, wheel chock, alignment bolt and gloves

The TIREFIT kit, wheel chock, alignment bolt and gloves are located in the left-hand stowage compartment in the trunk.

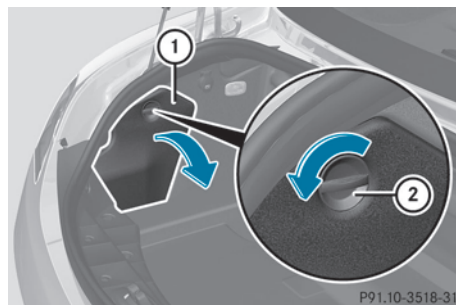

Left-hand stowage compartment in the trunk

⁵ Not included in the scope of delivery in all countries.

- ▶ Remove the jack from the left-hand stowage space in the trunk to allow the stowage compartment to be opened.
- ▶ Turn fastener ② in the direction of the arrow.
- ▶ Open stowage compartment ①.
- ▶ Remove the TIREFIT kit, wheel chock, alignment bolt and gloves.

Flat tire

Preparing the vehicle

Your vehicle is equipped with a TIREFIT kit.

- ▶ Stop the vehicle on solid, non-slippery and level ground, as far away as possible from traffic.
- ▶ Switch on the hazard warning lamps.
- ▶ Apply the electric parking brake manually (> page 126).
- ▶ Bring the front wheels into the straight-ahead position.
- ▶ Shift the transmission to **P** with the button in the center console.
- ▶ Switch off the engine.
- ▶ Remove the SmartKey from the ignition lock.
- ▶ All occupants must get out of the vehicle. Make sure that they are not endangered as they do so.
- ▶ Make sure that no one is near the danger area while a wheel is being changed. Anyone who is not directly assisting in the wheel change should, for example, stand behind the barrier.
- ▶ Get out of the vehicle. Pay attention to traffic conditions when doing so.
- ▶ Close the driver's door.

TIREFIT kit

Using the TIREFIT kit

TIREFIT is a tire sealant.

You can use TIREFIT to seal punctures of up to 0.16 in (4 mm), particularly those in the tire tread. You can use TIREFIT at outside temperatures down to -4 °F (-20 °C).

WARNING

In the following situations, the tire sealant is unable to provide sufficient breakdown assistance, as it is unable to seal the tire properly:

- there are cuts or punctures in the tire larger than those mentioned above.
- the wheel rim is damaged.
- you have driven at very low tire pressures or on a flat tire.

There is a risk of an accident.

Do not drive the vehicle. Contact a qualified specialist workshop.

WARNING

The tire sealant is harmful and causes irritation. It must not come into contact with your skin, eyes or clothing or be swallowed. Do not inhale TIREFIT fumes. Keep tire sealant away from children. There is a risk of injury. If you come into contact with the tire sealant, observe the following:

- Rinse off the tire sealant from your skin immediately with water.
- If the tire sealant comes into contact with your eyes, immediately rinse them thoroughly with clean water.
- If tire sealant is swallowed, immediately rinse your mouth out thoroughly and drink plenty of water. Do not induce vomiting, and seek medical attention immediately.
- Immediately change out of clothing which has come into contact with tire sealant.
- If an allergic reaction occurs, seek medical attention immediately.

- ▶ Do not remove any foreign objects which have penetrated the tire, e.g. screws or nails.
- ▶ Take the TIREFIT kit out of the trunk (▷ page 216).

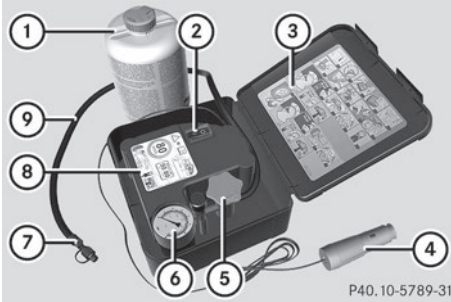

- ▶ Open the TIREFIT kit and remove "max. 80 km/h" sticker (8).
- ▶ Affix sticker (8) within the driver's field of vision.
- i** If TIREFIT leaks out, allow it to dry. It can then be removed like a layer of film. If you get TIREFIT on your clothing, have it cleaned as soon as possible with perchloroethylene.

Comply with the manufacturer's safety instructions on the tire inflation compressor label and on the tire sealant bottle.

- i** You will also find operating instructions (3) in the lid of the TIREFIT kit.
- ▶ Pull the cable and filler hose (9) out of the housing.

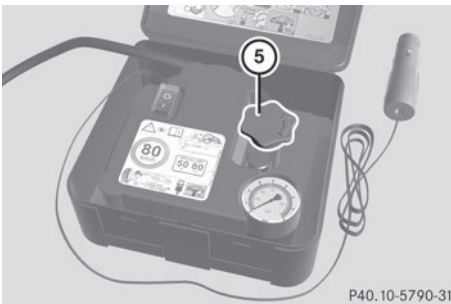

- ▶ Unscrew flanged cap (5).

- ▶ Unscrew the cap from tire sealant bottle (1). Make sure that the aluminum film is not damaged when doing so.

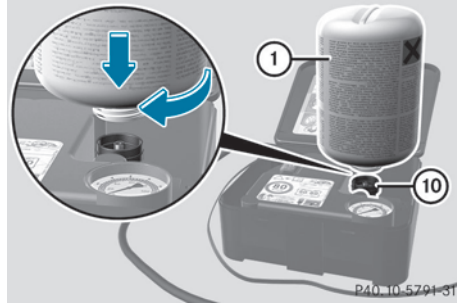

- ▶ Screw tire sealant bottle (1) clockwise tightly onto flange seal (10). This pierces the aluminum film.
- ▶ Remove the cap from the valve on the faulty tire.
- ▶ Make sure that pressure release screw (7) is closed.
- ▶ Remove the dust protection cap from filler hose (9).

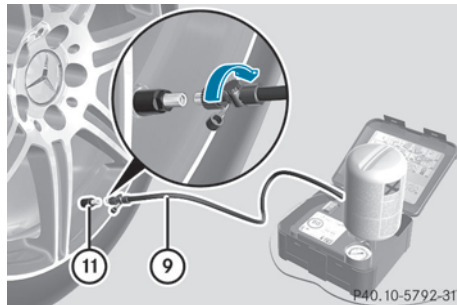

- ▶ Screw the end of filler hose (9) onto tire valve (11).
- ▶ Make sure that on/off switch (2) on the tire inflation compressor is set to 0.
- ▶ Insert connector (4) into the 12 V socket (▷ page 189).
- ▶ Select key position 2 with the Start/Stop button (▷ page 111).
- i** The battery discharges during tire inflation compressor usage. For this

reason, you should start the engine unless you are inflating the tire in an enclosed space.

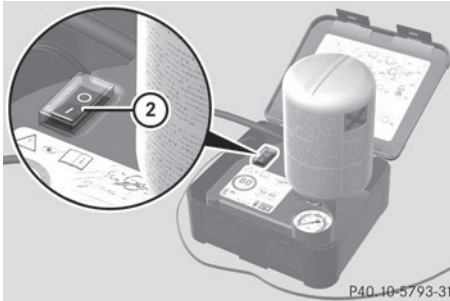

- ▶ Press on/off switch ② on the tire inflation compressor to I.
The tire inflation compressor is switched on. The tire is inflated.

i First, TIREFIT is pumped into the tire. The pressure can briefly rise to approximately 500 kPa (5 bar/73 psi).

Do not switch off the tire inflation compressor during this phase.

- ▶ Let the tire inflation compressor run for a maximum of ten minutes. The tire should then have attained a pressure of at least 180 kPa (1.8 bar/26 psi).
Switch the tire inflation compressor off briefly to read the correct value from pressure gauge ⑥.

! Do not operate the tire inflation compressor for longer than ten minutes at a time without a break. It may otherwise overheat.

The tire inflation compressor can be operated again once it has cooled down.

Tire pressure of at least 180 kPa (1.8 bar/26 psi) is not reached

If, after five minutes, a pressure of 180 kPa (1.8 bar/26 psi) has not been achieved:

- ▶ Switch off the tire inflation compressor, remove it and drive the vehicle approximately 30 ft (10 m) forward or back. This distributes the TIREFIT more evenly.
- ▶ Leave tire sealant bottle ① attached to the flange.
- ▶ Pump up the tire again.

⚠ WARNING

If the required tire pressure is not reached after the specified time, the tire is too badly damaged. The tire sealant cannot repair the tire in this instance. Damaged tires and a tire pressure that is too low can significantly impair the vehicle's braking and driving characteristics. There is a risk of accident.

Do not continue driving. Contact a qualified specialist workshop.

Tire pressure of 180 kPa (1.8 bar/26 psi) is reached

⚠ WARNING

A tire temporarily sealed with tire sealant impairs the driving characteristics and is not suitable for higher speeds. There is a risk of accident.

You should therefore adapt your driving style accordingly and drive carefully. Do not exceed the specified maximum speed with a tire that has been repaired using tire sealant.

If the tire pressure is at least 180 kPa (1.8 bar/26 psi):

- ▶ Press on/off switch ② on the tire inflation compressor to 0.
The tire inflation compressor is switched off.
- ▶ Remove connector ④ from the 12 V socket.
- ▶ Remove filler hose ⑨ from tire valve ⑪ and re-install the dust protection cap. Screw the valve cap onto the valve again. Leave tire sealant bottle ① attached to flange ⑩.

- ▶ Stow the TIREFIT kit in a safe and accessible place in the vehicle.
- ▶ **Pull away immediately.**

The maximum speed for a tire sealed with tire sealant is 50 mph (80 km/h). The upper part of the TIREFIT sticker must be affixed to the instrument cluster in the driver's field of vision.

! After use, excess TIREFIT may run out of the filler hose. This could cause stains.

- ▶ Stop after driving for approximately ten minutes and check the tire pressure with the tire inflation compressor. The tire pressure must now be at least 130 kPa (1.3 bar/19 psi).
- i** On tires that are equipped with a tire pressure sensor (tire pressure monitor), the use of sealant can lead to malfunction messages and incorrect displays. Therefore, use pressure gauge **⑥** in the TIREFIT kit to check and correct the tire pressure.

⚠ WARNING

If the required tire pressure is not reached after driving for a short period, the tire is too badly damaged. The tire sealant cannot repair the tire in this instance. Damaged tires and a tire pressure that is too low can significantly impair the vehicle's braking and driving characteristics. There is a risk of accident. Do not continue driving. Contact a qualified specialist workshop.

- ▶ Correct the tire pressure if it is still at least 130 kPa (1.3 bar/20 psi) (for the values, see the Tire and Loading Information placard on the driver's side B-pillar or tire pressure table on the fuel filler flap).
To increase the tire pressure: switch on the tire inflation compressor.
To reduce the tire pressure: open release screw **⑦**.

! The manufacturer does not guarantee that all tire damage can be repaired using

the TIREFIT kit, particularly in the case of cuts and punctures with a diameter of more than four millimeters or on the sidewall. The manufacturer is not responsible for damage caused by inappropriate use of the TIREFIT kit.

- ▶ Drive to the nearest workshop and have the tire changed there.
- ▶ Have the tire sealant bottle replaced as soon as possible at a qualified specialist workshop, e.g. at an authorized Mercedes-Benz Center.

🌱 Environmental note

Have the used tire sealant bottle disposed of professionally, e.g. at an authorized Mercedes-Benz Center.

- ▶ Have the TIREFIT kit replaced every four years at a qualified specialist workshop, e.g. an authorized Mercedes-Benz Center.

Battery (vehicle)

Important safety notes

Special tools and expert knowledge are required when working on the battery, e.g. removal and installing. You should therefore have all work involving the battery carried out at a qualified specialist workshop.

⚠ WARNING

Work carried out incorrectly on the battery can lead, for example, to a short circuit and thus damage the vehicle electronics. This can lead to function restrictions applying to safety-relevant systems, e.g. the lighting system, ABS (anti-lock braking system) or ESP® (Electronic Stability Program). The operating safety of your vehicle may be restricted. You could lose control of the vehicle, for example:

- braking
- in the event of abrupt steering maneuver and/or when the vehicle's speed is not adapted to the road conditions

There is a risk of an accident.

In the event of a short circuit or a similar incident, contact a qualified specialist workshop immediately. Do not drive any further. You should have all work involving the battery carried out at a qualified specialist workshop.

⚠ WARNING

Electrostatic build-up can lead to the creation of sparks, which could ignite the highly explosive gases of a battery. There is a risk of an explosion.

Before handling the battery, touch the vehicle body to remove any existing electrostatic build-up.

The highly flammable gas mixture forms when charging the battery as well as when jump-starting.

Always make sure that neither you nor the battery is electrostatically charged. A build-up of electrostatic charge can be caused, for example:

- by wearing clothing made from synthetic fibers
- due to friction between clothing and seats
- if you push or pull the battery across the carpet or other synthetic materials
- if you wipe the battery with a cloth

⚠ WARNING

During the charging process, a battery produces hydrogen gas. If a short circuit occurs or sparks are created, the hydrogen gas can ignite. There is a risk of an explosion.

- Make sure that the positive terminal of a connected battery does not come into contact with vehicle parts.
- Never place metal objects or tools on a battery.
- It is important that you observe the described order of the battery terminals when connecting and disconnecting a battery.
- When jump-starting, make sure that the battery poles with identical polarity are connected.
- It is particularly important to observe the described order when connecting and disconnecting the jumper cables.
- Never connect or disconnect the battery terminals while the engine is running.

⚠ WARNING

Battery acid is caustic. There is a risk of injury. Avoid contact with the skin, eyes or clothing. Do not inhale any battery gases. Do not lean over the battery. Keep children away from batteries. Wash battery acid immediately with water and seek medical attention.

♻ Environmental note

Batteries contain dangerous substances. It is against the law to dispose of them with the household rubbish. They must be collected separately and recycled to protect the environment.



Dispose of batteries in an environmentally friendly manner. Take discharged batteries to a qualified specialist workshop or a

special collection point for used batteries.

! Have the battery checked regularly at a qualified specialist workshop. Observe the service intervals in the Maintenance Booklet or contact a qualified specialist workshop for more information.

! You should have all work involving the battery carried out at a qualified specialist workshop. In the exceptional case that it is necessary for you to disconnect the battery yourself, make sure that:

- you switch off the engine and remove the SmartKey. On vehicles with KEYLESS-GO, ensure that the ignition is switched off. Check that all the indicator lamps in the instrument cluster are off. Otherwise, electronic components, such as the alternator, may be damaged.
- you first remove the negative terminal clamp and then the positive terminal clamp. Never swap the terminal clamps. Otherwise, the vehicle's electronic system may be damaged.
- the transmission is locked in position **P** after disconnecting the battery. The vehicle is secured against rolling away. You can then no longer move the vehicle.

The battery and the cover of the positive terminal clamp must be installed securely during operation.

Comply with safety precautions and take protective measures when handling batteries.



Risk of explosion.



Fire, open flames and smoking are prohibited when handling the battery. Avoid creating sparks.



Battery acid is caustic. Avoid contact with skin, eyes or clothing.

Wear suitable protective clothing, especially gloves, apron and faceguard.

Rinse any acid spills immediately with clear water. Contact a physician if necessary.

Wear eye protection.



Keep children away.



Observe this Operator's Manual.

For safety reasons, Mercedes-Benz recommends that you only use batteries which have been tested and approved for your vehicle by Mercedes-Benz. These batteries provide increased impact protection to prevent vehicle occupants from suffering acid burns should the battery be damaged in the event of an accident.

In order for the battery to achieve the maximum possible service life, it must always be sufficiently charged.

The vehicle battery, like other batteries, can discharge over time if you do not use the vehicle. In this case, have the battery disconnected at a qualified specialist workshop. You can also charge the battery with a charger recommended by Mercedes-Benz. Contact a qualified specialist workshop for further information.

Have the battery condition of charge checked more frequently if you use the vehicle mainly for short trips or if you leave it standing idle for a lengthy period. Consult a qualified specialist workshop if you wish to leave your vehicle parked for a long period of time.

- i** Remove the SmartKey if you park the vehicle and do not require any electrical consumers. The vehicle will then use very

little energy, thus conserving battery power.

- i** If the battery power supply has been interrupted, e.g. if the battery was fully discharged, you will need to reset the "exterior mirrors automatic folding function", by folding the mirrors out once (▷ page 85).

Charging the battery

WARNING

During charging and jump-starting, explosive gases can escape from the battery. There is a risk of an explosion.

Particularly avoid fire, open flames, creating sparks and smoking. Ensure there is sufficient ventilation while charging and jump-starting. Do not lean over a battery.

WARNING

Battery acid is caustic. There is a risk of injury. Avoid contact with the skin, eyes or clothing. Do not inhale any battery gases. Do not lean over the battery. Keep children away from batteries. Wash battery acid immediately with water and seek medical attention.

WARNING

A discharged battery can freeze at temperatures below freezing point. When jump-starting the vehicle or charging the battery, gases can escape from the battery. There is a risk of an explosion.

Allow the frozen battery to thaw out before charging it or jump-starting.

- !** Only use battery chargers with a maximum charging voltage of 14.8 V.

- !** Only charge the battery using the jump-starting connection point.

The jump-starting connection point is in the engine compartment (▷ page 224).

Never charge the battery if it is still installed in the vehicle, unless you use a battery

charger which has been tested and approved by Mercedes-Benz. A battery charger unit specially adapted for Mercedes-Benz vehicles and tested and approved by Mercedes-Benz is available as an accessory. It permits the charging of the battery in its installed position. Contact an authorized Mercedes-Benz Center for further information and availability. Charge the battery in accordance with the separate instructions for the accessory battery charger.

Read the battery charger's operating instructions before charging the battery.

- ▶ Open the hood (▷ page 202).
- ▶ Connect the battery charger to the positive terminal and ground point in the same order as when connecting the donor battery in the jump-starting procedure (▷ page 224).

Left-hand-drive vehicles are equipped with a weight-optimized lithium-ion battery.

Therefore, connect your vehicle to a trickle charger if it will be out of use for a long period, in order to:

- protect the battery against heavy discharging
- subsequently guarantee a reliable start

You can find further information in the "Charge maintenance socket" section (▷ page 199).

Jump-starting**⚠ WARNING**

Battery acid is caustic. There is a risk of injury.

Avoid contact with the skin, eyes or clothing. Do not inhale any battery gases. Do not lean over the battery. Keep children away from batteries. Wash battery acid immediately with water and seek medical attention.

⚠ WARNING

During charging and jump-starting, explosive gases can escape from the battery. There is a risk of an explosion.

Particularly avoid fire, open flames, creating sparks and smoking. Ensure there is sufficient ventilation while charging and jump-starting. Do not lean over a battery.

⚠ WARNING

During the charging process, a battery produces hydrogen gas. If a short circuit occurs or sparks are created, the hydrogen gas can ignite. There is a risk of an explosion.

- Make sure that the positive terminal of a connected battery does not come into contact with vehicle parts.
- Never place metal objects or tools on a battery.
- It is important that you observe the described order of the battery terminals when connecting and disconnecting a battery.
- When jump-starting, make sure that the battery poles with identical polarity are connected.
- It is particularly important to observe the described order when connecting and disconnecting the jumper cables.
- Never connect or disconnect the battery terminals while the engine is running.

⚠ WARNING

A discharged battery can freeze at temperatures below freezing point. When jump-starting the vehicle or charging the battery, gases can escape from the battery. There is a risk of an explosion.

Allow the frozen battery to thaw out before charging it or jump-starting.

- ❗ **!** Avoid repeated and lengthy starting attempts. Otherwise, the catalytic converter could be damaged by the non-combusted fuel.

Do not start the vehicle using a rapid charging device. If your vehicle's battery is discharged, the engine can be jump-started from another vehicle or from a second battery using jumper cables. Observe the following points:

- The battery is not accessible in all vehicles. If the other vehicle's battery is not accessible, jump-start the vehicle using a second battery or a jump-starting device.
- You may only jump-start the vehicle when the engine and exhaust system are cold.
- Do not start the engine if the battery is frozen. Let the battery thaw first.
- Only jump-start from batteries with a 12 V voltage rating.
- Only use jumper cables which have a sufficient cross-section and insulated terminal clamps.

- If the battery is fully discharged, leave the battery that is being used to jump-start connected for a few minutes before attempting to start. This charges the battery slightly.
- Make sure that the two vehicles do not touch.

Make sure that:

- the jumper cables are not damaged.
 - when the jumper cables are connected to the battery, uninsulated sections of the terminal clamp do not come into contact with other metal sections.
 - the jumper cables cannot come into contact with parts such as the V-belt pulley or the fan. These parts move when the engine is started and while it is running.
- ▶ Press the electric parking brake handle.
- ▶ Shift the transmission to **P** with the button in the center console.
- ▶ Remove the SmartKey from the ignition lock.
- ▶ Switch off all electrical consumers (e.g. radio, blower, etc.).
- ▶ Open the hood (▶ page 202).

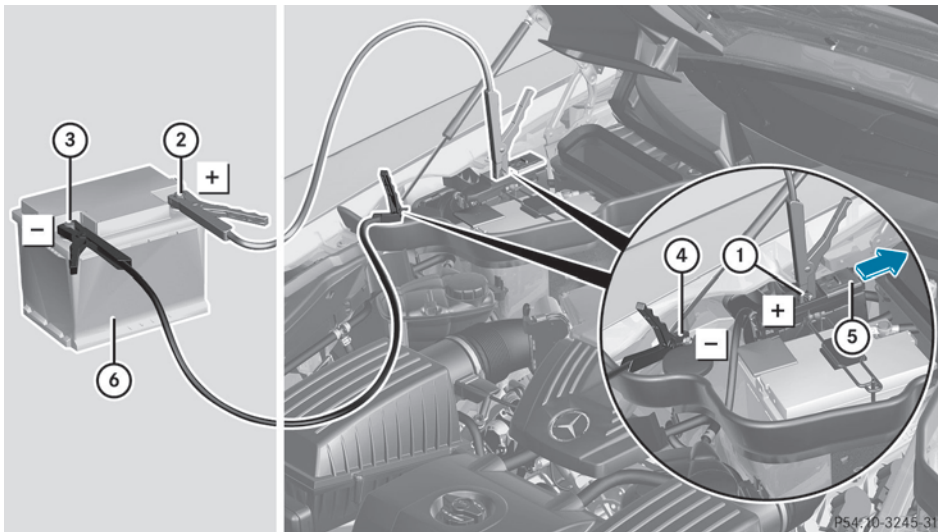

Position number ⑥ identifies the charged battery of the other vehicle or an equivalent jump-starting device.

- ▶ Slide cover ⑤ of positive terminal ① in the direction of the arrow.
- ▶ Connect positive terminal ① on your vehicle to positive terminal ② of donor battery ⑥ using the jumper cable, beginning with your own battery.
- ▶ Start the engine of the donor vehicle and run it at idling speed.
- ▶ Connect negative terminal ③ of donor battery ⑥ to earth point ④ of your vehicle using the jumper cable, connecting the jumper cable to donor battery ⑥ first.
- ▶ Start the engine.
- ▶ Before disconnecting the jumper cables, let the engine run for several minutes.

- ▶ First, remove the jumper cables from earth point ④ and negative terminal ③, then from positive clamp ① and positive terminal ②. Each time beginning with your vehicle's battery.
 - ▶ Slide cover ⑤ of the positive terminal in the opposite direction to the arrow.
 - ▶ Have the battery checked at a qualified specialist workshop.
- i** Jump-starting is not considered to be a normal operating condition.
- i** Jumper cables and further information regarding jump-starting can be obtained at any qualified specialist workshop.

Towing and tow-starting

Important safety notes

WARNING

The rear axle locks when:

- the engine is not running
- the engine stalls while the vehicle is being towed
- there is a malfunction in the power supply or the vehicle's electrical system

There is a risk of an accident.

In the event of a breakdown, you should always have the vehicle transported.

WARNING

If the brake system or power steering is malfunctioning and your vehicle is then towed away, significantly more effort may be required to steer and brake than is normally required. There is a risk of an accident.

In such cases, use a tow bar. Before towing, make sure that the steering moves freely.

WARNING

If the weight of the vehicle to be towed or tow-started is greater than the permissible gross weight of your vehicle:

- the towing eye could detach itself
- the vehicle/trailer combination could rollover.

There is a risk of an accident.

When towing or tow-starting another vehicle, its weight should not be greater than the permissible gross weight of your vehicle.

- !** Use the SmartKey instead of the Start/Stop button when towing the vehicle.

Start the engine and keep it running. Turn the SmartKey to position **2** in the ignition. Set the transmission to **N** using the E-SELECT lever. Make sure that you then leave the SmartKey in position **2**.

Check the transmission position in the instrument cluster.

- !** Make sure that the electric parking brake is released. If the electric parking brake is faulty, visit a qualified specialist workshop. Mercedes-Benz recommends that you use an authorized Mercedes-Benz Center for this purpose.

- !** When towing, pull away slowly and smoothly. If the tractive power is too high, the vehicles could be damaged.

- !** Only secure the tow rope or tow bar at the towing eyes. Otherwise, the vehicle could be damaged.

- !** Do not use the towing eyes for recovery purposes as this could damage the vehicle. If in doubt, recover the vehicle with a crane.

- !** The vehicle can be towed a maximum of 30 miles (50km). The towing speed of 30 mph (50 km/h) must not be exceeded. If the vehicle has to be towed more than 30 miles (50km), the entire vehicle must be raised and transported.

- !** Do not tow with sling-type equipment. This could damage the vehicle.

! Tow-starting the vehicle is not permitted. The transmission may otherwise be damaged.

If the vehicle can no longer be driven because of an accident or breakdown, you have the following options:

- transporting the vehicle
As a rule, you should have the vehicle transported.
- towing the vehicle with the rear axle raised
Only tow the vehicle with the rear axle raised in exceptional cases.
- towing the vehicle with a tow rope or tow bar
Only tow the vehicle in exceptional cases. The engine must be running if you tow the vehicle with a tow rope or tow bar. Observe the following notes.

Also observe the following notes:

- If the engine does not start, try jump-starting it (▷ page 224). Tow-starting the vehicle is not permitted.
- If it is not possible to jump-start the vehicle, have it transported to the nearest qualified specialist workshop, e.g. an authorized Mercedes-Benz Center.
- If the vehicle has transmission damage, have it transported to a qualified specialist workshop. Observe the display messages in the instrument cluster.

Installing/removing the towing eye

Installing the towing eye

- ▶ Take the towing eye and the wheel wrench⁶ out of the wheel-change tool kit (▷ page 216).

The bracket for the removable towing eye is in the bumper at the front. It is located under the cover.

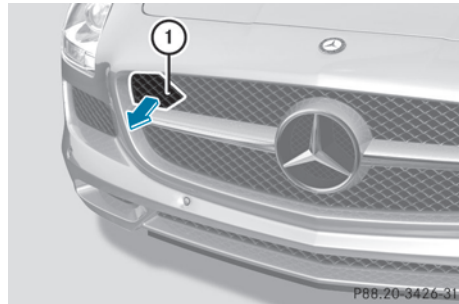

- ▶ Pull out cover (1) forwards.
- ▶ Take cover (1) off the opening.

Removing the towing eye

- ▶ Take the lug wrench⁶ from the wheel-change tool kit (▷ page 216).
- ▶ Insert the lug wrench handle into the towing eye and turn it counter-clockwise.
- ▶ Unscrew the towing eye.
- ▶ Attach cover (1) to the bumper and press until it engages.
- ▶ Return the towing eye and the lug wrench to the wheel-change tool kit.
- ▶ Return the towing eye and the lug wrench to the trunk.

Towing the vehicle with the rear axle raised

When towing your vehicle with the rear axle raised, it is important that you observe the safety instructions (▷ page 226).

Only tow the vehicle with the rear axle raised in exceptional cases.

- !** The engine must be switched off (SmartKey in ignition lock in position **0** or position **1**) if the vehicle is being towed with the rear axle raised or if the parking brake is being tested on a dynamometer. Intervention by ESP[®] could otherwise damage the brake system.

⁶ Not included in the scope of delivery.

- ▶ Switch on the hazard warning lamps (▷ page 92).
- ▶ Make sure that the SmartKey is in position **2** in the ignition and that the engine is running throughout the towing procedure.
- ▶ Move the transmission to **N** with the E-SELECT lever. Check the transmission position in the instrument cluster.

Towing a vehicle with both axles on the ground

It is important that you observe the safety instructions when towing away your vehicle (▷ page 226).

- ▶ Switch on the hazard warning lamps (▷ page 92).
- ▶  When towing with the hazard warning flashers switched on, use the combination switch as usual to signal in which direction you are changing. In this case, only the indicator lamps for the direction of travel flash. When you reset the combination switch, the hazard warning flashers start flashing again.
- ▶ Insert the SmartKey into the ignition lock (▷ page 111).
- ▶ Start the engine and leave the SmartKey in the ignition.
- ▶ Move the transmission to **N** with the E-SELECT lever.
- ▶ Check the transmission position in the instrument cluster display (▷ page 114).
- ▶ Leave the engine running throughout the entire towing procedure

Transporting the vehicle

The towing eye can be used to pull the vehicle onto a trailer or transporter for transporting purposes.

- ▶  You may only secure the vehicle by the wheels, not by parts of the vehicle such as

axle or steering components. Otherwise, the vehicle could be damaged.

- ▶ Start the engine.
- ▶ Switch on the ignition.
- ▶ Make sure that the SmartKey is in position **2** in the ignition and that the engine is running during the entire loading operation.
- ▶ Move the transmission to **N** with the E-SELECT lever. Check the transmission position in the instrument cluster.

As soon as the vehicle has been loaded:

- ▶ Prevent the vehicle from rolling away by applying the electric parking brake.
- ▶ Shift the transmission to **P** with the button in the center console.
- ▶ Turn the SmartKey to position **0** in the ignition lock and remove the SmartKey from the ignition lock.
- ▶ Secure the vehicle.

Fuses

Important safety notes

WARNING

If you manipulate or bridge a faulty fuse or if you replace it with a fuse with a higher amperage, the electric cables could be overloaded. This could result in a fire. There is a risk of an accident and injury.

Always replace faulty fuses with the specified new fuses having the correct amperage.

- ▶  Only use fuses that have been approved for Mercedes-Benz vehicles and which have the correct fuse rating for the system concerned. Otherwise, components or systems could be damaged.

The fuses in your vehicle serve to close down faulty circuits. If a fuse blows, all the components on the circuit and their functions stop operating.

Blown fuses must be replaced with fuses of the same rating, which you can recognize by

the color and value. The fuse ratings are listed in the fuse allocation chart.

If a newly inserted fuse also blows, have the cause traced and rectified at a qualified specialist workshop, e.g. an authorized Mercedes-Benz Center.

Before changing a fuse

- ▶ Park the vehicle and apply the electric parking brake.
- ▶ Switch off all electrical consumers.
- ▶ Remove the SmartKey from the ignition lock.

The fuses are located in various fuse boxes:

- fuse box in the footwell on the front-passenger side
- fuse box in the rear

The "Relay and fuse information sheet" is located with the wheel-change toolkit in the trunk.

Fuse box in the footwell

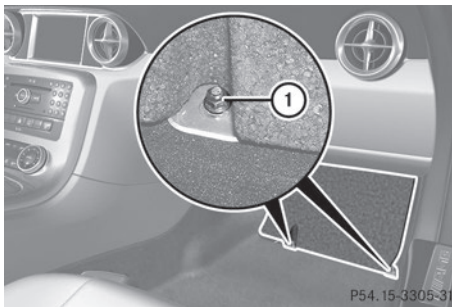

- ▶ **To open:** remove the carpet over the footrest.
- ▶ Loosen screws ① on the floor panel using a suitable tool.
- ▶ Remove the floor panel.
- ▶ **To close:** install the floor panel again.
- ▶ Screw in and tighten screws ①.
- ▶ Put in the carpet and press to secure.

- ❗ The floor panel must be installed properly, otherwise moisture or dirt could impair the function of the fuses.

Fuse box in the rear

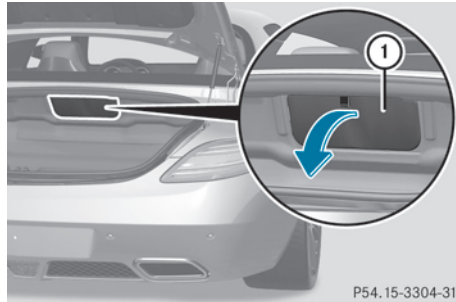

- ▶ **To open:** open the trunk.
- ▶ Fold cover ① in the center of the rear wall down in the direction of the arrow.
- ▶ **To close:** fold cover ① up in the opposite direction to the arrow and press to secure.
- ❗ The cover must be installed properly, otherwise moisture or dirt could impair the function of the fuses.

Useful information	232
Important safety notes	232
Operation	232
Winter operation	234
Tire pressure	235
Loading the vehicle	242
All about wheels and tires	245
Changing a wheel	252
Wheel and tire combinations	257

Useful information

- i** This Operator's Manual describes all models and all standard and optional equipment of your vehicle available at the time of publication of the Operator's Manual. Country-specific differences are possible. Please note that your vehicle may not be equipped with all features described. This also applies to safety-related systems and functions.
- i** Please read the information on qualified specialist workshops (▷ page 21).

Important safety notes

WARNING

If wheels and tires of the wrong size are used, the wheel brakes or suspension components may be damaged. There is a risk of an accident.

Always replace wheels and tires with those that fulfill the specifications of the original part.

When replacing wheels, make sure to use the correct:

- designation
- model

When replacing tires, make sure to use the correct:

- designation
- manufacturer
- model

Warning

A flat tire severely impairs the driving, steering and braking characteristics of the vehicle. There is a risk of an accident. do not drive with a flat tire. Immediately replace the flat tire with your spare wheel, or consult a qualified specialist workshop.

Accessories that are not approved for your vehicle by Mercedes-Benz or that are not

being used correctly can impair the operating safety.

Before purchasing and using non-approved accessories, visit a qualified specialist workshop and inquire about:

- suitability
- legal stipulations
- factory recommendations

Information on dimensions and types of wheels and tires for your vehicle can be found (▷ page 257).

Information on air pressure for the tires on your vehicle can be found:

- on the vehicle's Tire and Loading Information placard on the B-pillar
- on the tire pressure label on the fuel filler flap
- under "Tire pressure"

- i** Further information on wheels and tires can be obtained at any qualified specialist workshop.

Operation

Information on driving

- If the vehicle is heavily loaded, check the tire pressures and correct them if necessary.
- While driving, pay attention to vibrations, noises and unusual handling characteristics, e.g. pulling to one side. This may indicate that the wheels or tires are damaged. If you suspect that a tire is defective, reduce your speed immediately. Stop the vehicle as soon as possible to check the wheels and tires for damage. Hidden tire damage could also be causing the unusual handling characteristics. If you find no signs of damage, have the wheels and tires checked at a qualified specialist workshop.
- When parking your vehicle, make sure that the tires do not get deformed by the curb or other obstacles. If it is necessary to drive

over curbs, speed humps or similar elevations, try to do so slowly and at an obtuse angle. Otherwise, the tires, particularly the sidewalls, may be damaged.

Notes on high performance tires

WARNING

Due to the special tire tread in combination with the optimized rubber compound, there is an increased risk of hydroplaning and skidding on a damp or wet road surface. Tire grip is also noticeably reduced at low outside temperatures and low tire operating temperatures. There is a risk of an accident. Turn on ESP® and adapt your driving style accordingly. When the outside temperature falls below 10 °C, use M+S tires.

-  Different driving styles may lead to high tire wear and the tires may reach the minimum tire tread depth after only a short time.

Regular checking of wheels and tires

WARNING

Damaged tires can cause tire inflation pressure loss. As a result, you could lose control of your vehicle. There is a risk of accident.

Check the tires regularly for signs of damage and replace any damaged tires immediately.

Regularly check the wheels and tires of your vehicle for damage at least once a month, as well as after driving off-road or on rough roads. Damaged wheels can cause a loss of tire pressure. Pay particular attention to damage such as:

- cuts in the tires
- punctures
- tears in the tires

- bulges on tires
- deformation or severe corrosion on wheels

Regularly check the tire tread depth and the condition of the tread across the whole width of the tire (▷ page 233). If necessary, turn the front wheels to full lock in order to inspect the inner side of the tire surface.

All wheels must have a valve cap to protect the valve against dirt and moisture. Do not mount anything onto the valve other than the standard valve cap or other valve caps approved by Mercedes-Benz for your vehicle. Do not use any other valve caps or systems, e.g. tire pressure monitoring systems.

Regularly check the pressure of all the tires particularly prior to long trips. Adjust the tire pressure as necessary (▷ page 235).

The service life of tires depends on the following factors amongst other things:

- driving style
- tire pressure
- distance covered

Tire tread

WARNING

Insufficient tire tread will reduce tire traction. The tire is no longer able to dissipate water. This means that on wet road surfaces, the risk of hydroplaning increases, in particular where speed is not adapted to suit the driving conditions. There is a risk of accident.

If the tire pressure is too high or too low, tires may exhibit different levels of wear at different locations on the tire tread. Thus, you should regularly check the tread depth and the condition of the tread across the entire width of all tires.

Minimum tire tread depth for:

- Summer tires: $\frac{1}{8}$ in (3 mm)
- M+S tires: $\frac{1}{6}$ in (4 mm)

For safety reasons, replace the tires before the legally prescribed limit for the minimum tire tread depth is reached.

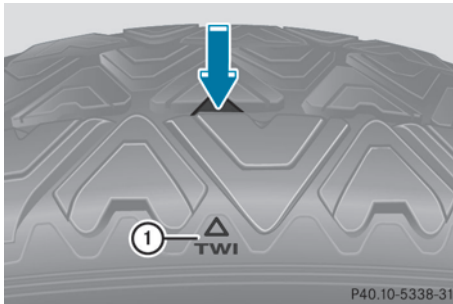

Bar indicator ① for tread wear is integrated into the tire tread.

Treadwear indicators (TWI) are required by law. Six indicators are positioned on the tire tread. They are visible once the tread depth is approximately $\frac{1}{16}$ in (1.6 mm). If this is the case, the tire is so worn that it must be replaced.

Selecting, mounting and replacing tires

- Only mount tires and wheels of the same type and make.
- Only mount tires of the correct size onto the wheels.
- Break in new tires at moderate speeds for the first 60 miles (100 km). They only reach their full performance after this distance.
- Do not drive with tires which have too little tread depth, as this significantly reduces the traction on wet roads (hydroplaning).
- Replace the tires after six years at the latest, regardless of wear.

Winter operation

General notes

Have your vehicle winterproofed at a qualified specialist workshop at the onset of winter. Observe the notes in the "Changing a wheel" section (▷ page 252).

Driving with summer tires

At temperatures below 45 °F (+7 °C), summer tires experience a considerable loss in elasticity and therefore traction and braking power. Change the tires on your vehicle to M+S tires. Using summer tires at very cold temperatures could cause cracks to form, thereby damaging the tires permanently. Mercedes-Benz cannot accept responsibility for this type of damage.

M+S tires

⚠ WARNING

M+S tires with a tire tread depth of less than $\frac{1}{8}$ in (4 mm) are not suitable for use in winter and do not provide sufficient traction. There is a risk of an accident.

M+S tires with a tread depth of less than $\frac{1}{8}$ in (4 mm) must be replaced immediately.

At temperatures below 45 °F (+7 °C), use winter tires or all-season tires. Both types of tire are identified by the M+S marking.

Only winter tires bearing the ❄ snowflake symbol in addition to the M+S marking provide the best possible grip in wintry road conditions. Only these tires will allow driving safety systems such as ABS and ESP® to function optimally in winter. This is because these tires were specifically developed for driving in snow.

Use M+S tires of the same make and tread on all wheels to maintain safe handling characteristics.

Always observe the maximum permissible speed specified for the M+S tires you have mounted.

When you have mounted the M+S tires:

- ▶ Check the tire pressures (▷ page 235).
- ▶ Restart the tire pressure monitor (▷ page 241).

Snow chains

WARNING

If snow chains are installed to the front wheels, they may drag against the vehicle body or chassis components. This could cause damage to the vehicle or the tires. There is a risk of an accident.

To avoid hazardous situations:

- never install snow chains to the front wheels
- always install snow chains in pairs to the rear wheels.

! On some tire sizes there is not enough space for snow chains. To avoid damage to the vehicle or tires, observe the "Wheel and tire combinations" section under "Tires and wheels".

For safety reasons, Mercedes-Benz recommends that you only use snow chains that have been specially approved for your vehicle by Mercedes-Benz, or are of a corresponding standard of quality.

- You may not attach snow chains to all wheel-tire combination, see the information under "Wheels and tires" in the "Technical data" section.
 - Only use snow chains when driving on roads completely covered by snow. Remove the snow chains as soon as possible when you come to a road that is not snow-covered.
 - Local regulations may restrict the use of snow chains. Observe the appropriate regulations if you wish to mount snow chains.
 - Do not exceed the maximum permissible speed of 30 mph (50 km/h).
- i** You can deactivate ESP® (> page 55) when pulling away with snow chains installed. You can thereby allow the wheels to spin in a controlled manner, achieving an increased driving force (cutting action).

Tire pressure

Tire pressure specifications

Important safety notes

WARNING

Underinflated or overinflated tires pose the following risks:

- the tires may burst, especially as the load and vehicle speed increase.
- the tires may wear excessively and/or unevenly, which may greatly impair tire traction.
- the driving characteristics, as well as steering and braking, may be greatly impaired.

There is a risk of an accident.

Follow recommended tire inflation pressures and check the pressure of all the tires including the spare wheel:

- monthly, at least
- if the load changes
- before beginning a long journey
- under different operating conditions, e.g. off-road driving

If necessary, correct the tire pressure.

- i** The specifications on the sample Tire and Loading Information placard and tire pressure tables are examples. Tire pressure specifications are vehicle-specific and may deviate from the data shown here. The tire pressure specifications that are valid for your vehicle can be found on the Tire and Loading Information placard and tire pressure table on the vehicle.

General notes

The recommended tire pressures for the tires mounted at the factory can be found on the labels described here.

Further information on tire pressures can be obtained at a qualified specialist workshop.

Tire and Loading Information placard

TIRE AND LOADING INFORMATION
RENSEIGNEMENTS SUR LES PNEUS ET LE CHARGEMENT

SEATING CAPACITY / NOMBRE DE PLACES: TOTAL 7, FRONT 2, MIDDLE 3, REAR 2
The combined weight of occupants and cargo should never exceed 1000 kg or 2000 lbs. The weight distribution should always be as follows: front 60%, rear 40%.

TIRE PNEU	SIZE DIMENSIONS	COLD TIRE PRESSURE / PRESSION DES PNEUS À FROID	SEE OWNER'S MANUAL FOR ADDITIONAL INFORMATION
FRONT AVANT	255/40 ZR18 99Y XL	200 kPa, 29 PSI	VOIR LE MANUEL DE L'USAGER POUR PLUS DE RENSEIGNEMENTS
REAR ARRIÈRE	286/35 ZR18 101Y XL	200 kPa, 29 PSI	
SPARE DE SECOURS	175/55-18 95P	420 kPa, 60 PSI	

P40.00-2205-31

① Recommended tire pressures

The Tire and Loading Information placard is on the B-pillar on the driver's side (▷ page 242).

The Tire and Loading Information placard contains the recommended tire pressures for cold tires. The recommended tire pressures are valid for the maximum permissible load and up to the maximum permissible vehicle speed.

Tire pressure table

The tire pressure table is on the inside of the fuel filler flap.

COLD TIRE PRESSURE

LOAD	240 km/h / 150 mph	100 km/h / 62 mph
normal load	200 kPa / 29 PSI	200 kPa / 29 PSI
maximum load	200 kPa / 29 PSI	200 kPa / 29 PSI

Warm tires up to: + 4 psi

P40.00-2179-31

Example: tire pressure table for all tires permitted for this vehicle by the factory

The tire pressure table contains the recommended pressures for cold tires for various operating conditions, i.e. differing load and speed conditions.

LUFTDRUCK PRESSURE PRESSION PRESSION
für kalte Reifen / for cold tires / des pneus froids / de inflado

100 kPa = 1 bar

TIRE SIZE	100 kPa	100 psi	100 kPa	100 psi
195/55 R16	200 kPa	29 PSI	200 kPa	29 PSI
215/45 R17	200 kPa	29 PSI	200 kPa	29 PSI
215/40 R18	200 kPa	29 PSI	200 kPa	29 PSI

Warme Reifen / Warm tires up to: + 30 kPa / + 4 psi

Pneus échauffés jusqu'à: Neumáticos calientes hasta:

P40.00-2183-31

Example: tire pressure table with tire dimensions

If a tire size precedes a tire pressure, the tire pressure information following is only valid for that tire size. The load conditions "partially laden" and "fully laden" are defined in the table for different numbers of occupants and amounts of luggage. The actual number of seats may differ.

Luftdruck für kalte Reifen / Tire pressure cold tires / Pression des pneus froids / Presión de inflado

100 kPa = 1 bar

TIRE SIZE	100 kPa	100 psi	100 kPa	100 psi
R18	200 kPa	29 PSI	200 kPa	29 PSI
R19	200 kPa	29 PSI	200 kPa	29 PSI

bis 240 km/h / 150 mph / Winterreifen / Winter tires / Pneus hiver / Neumáticos de invierno: + 30 kPa / + 4 psi

Warme Reifen bis: / Warm tires up to: / Pneus échauffés jusqu'à: / Neumáticos calientes hasta: + 30 kPa / + 4 psi

P40.00-2184-31

Some tire pressure tables show only the rim diameters instead of the full tire size, e.g.

R18. The rim diameter is part of the tire size and can be found on the tire sidewall (▷ page 246).

If the tire pressures have been set to the lower values for lighter loads and/or lower road speeds, the pressures should be reset to the higher values:

- if you want to drive with an increased load and/or
- if you want to drive at higher road speeds

i The tire pressures for increased loads and/or higher road speeds, shown in the tire pressure table, may have a negative effect on driving comfort.

If the tire pressure is not set correctly, this can lead to an excessive build up of heat and a sudden loss of pressure.

For more information, contact a qualified specialist workshop.

Important notes on tire pressure

WARNING

If the tire pressure drops repeatedly, the wheel, valve or tire may be damaged. Tire pressure that is too low may result in a tire blow-out. There is a risk of an accident.

- Check the tire for foreign objects.
- Check whether the wheel is losing air or the valve is leaking.

If you are unable to rectify the damage, contact a qualified specialist workshop.

WARNING

If you fit unsuitable accessories onto tire valves, the tire valves may be overloaded and malfunction, which can cause tire pressure loss. Due to their design, retrofitted tire pressure monitors keep the tire valve open. This can also result in tire pressure loss. There is a risk of an accident.

Only screw the standard valve cap or other valve caps approved by Mercedes-Benz for your vehicle onto the tire valve.

Use a suitable pressure gauge to check the tire pressure. The outer appearance of a tire does not permit any reliable conclusion about the tire pressure. On vehicles equipped with the electronic tire pressure monitor, the tire pressure can be checked in the on-board computer.

The tire temperature and pressure increase when the vehicle is in motion. This is dependent on the driving speed and the load. Therefore, you should only correct tire pressures when the tires are cold.

The tires are cold:

- if the vehicle has been parked without direct sunlight on the tires for at least three hours and
- if the vehicle has not been driven further than 1 mile (1.6 km)

The tire temperature changes depending on the outside temperature, the vehicle speed and the tire load. If the tire temperature changes by 18 °F (10 °C), the tire pressure changes by approximately 10 kPa (0.1 bar/ 1.5 psi). Take this into account when checking the pressure of warm tires. Only correct the tire pressure if it is too low for the current operating conditions. If you check the tire pressure when the tires are warm, the resulting value will be higher than if the tires were cold. This is normal. Do not reduce the tire pressure to the value specified for cold tires. The tire pressure would otherwise be too low.

Observe the recommended tire pressures for cold tires:

- on the Tire and Loading Information placard on the B-pillar on the driver's side
- in the tire pressure table on the inside of the fuel filler flap

Underinflated or overinflated tires

Underinflated tires

WARNING

Tires with pressure that is too low can overheat and burst as a consequence. In addition, they also suffer from excessive and/or irregular wear, which can severely impair the braking properties and the driving characteristics. There is a risk of an accident. Avoid tire pressures that are too low in all the tires, including the spare wheel.

Underinflated tires may:

- overheat, leading to tire defects
- adversely affect handling

- wear excessively and/or unevenly
- have an adverse effect on fuel consumption

Overinflated tires

WARNING

Tires with excessively high pressure can burst because they are damaged more easily by road debris, potholes etc. In addition, they also suffer from irregular wear, which can severely impair the braking properties and the driving characteristics. There is a risk of an accident.

Avoid tire pressures that are too high in all the tires, including the spare wheel.

Overinflated tires may:

- increase the braking distance
- adversely affect handling
- wear excessively and/or unevenly
- have an adverse effect on ride comfort
- be more susceptible to damage

Maximum tire pressures

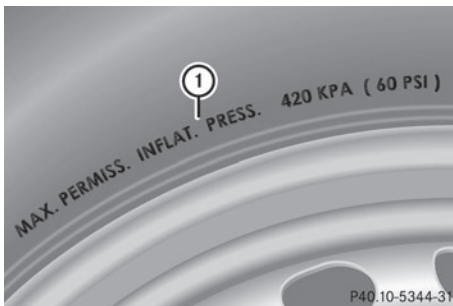

- ① Example: maximum permissible tire pressure

Never exceed the maximum permissible tire inflation pressure. Always observe the recommended tire pressure for your vehicle when adjusting the tire pressure (> page 235).

- i** The actual values for tires are vehicle-specific and may deviate from the values in the illustration.

Checking the tire pressures

Important safety notes

Observe the notes on tire pressure (> page 235).

Information on air pressure for the tires on your vehicle can be found:

- on the vehicle's Tire and Loading Information placard on the B-pillar (> page 242)
- on the tire pressure label on the fuel filler flap (> page 122)
- in the "Tire pressure" section (> page 235).

Checking tire pressures manually

To determine and set the correct tire pressure, proceed as follows:

- ▶ Remove the valve cap of the tire that is to be checked.
- ▶ Press the tire pressure gauge securely onto the valve.
- ▶ Read the tire pressure and compare it with the recommended value on the Tire and Loading Information placard on the B-pillar on the driver's side of your vehicle.
- ▶ If necessary, increase the tire pressure to the recommended value (> page 235).
- ▶ If the tire pressure is too high, release air by pressing down the metal pin in the valve using the tip of a pen, for example. Then check the tire pressure again using the tire pressure checker.
- ▶ Screw the valve cap onto the valve.
- ▶ Repeat these steps for the other tires.

Tire pressure monitor

General notes

If a tire pressure monitor is installed, the vehicle's wheels have sensors that monitor the tire pressures in all four tires. The tire pressure monitor warns you if the pressure

drops in one or more of the tires. The tire pressure monitor only functions if the correct sensors are installed on all wheels.

Information on tire pressures is displayed in the multifunction display. After a few minutes of driving, the current tire pressure of each tire is shown in the **Service** menu of the multifunction display.



Example

For information on the message display, refer to the "Checking the tire pressure electronically" section (> page 240).

Important safety notes

WARNING

Each tire, including the spare (if provided), should be checked at least once every two weeks when cold and inflated to the pressure recommended by the vehicle manufacturer on the Tire and Loading Information placard on the driver's door B-pillar or the tire pressure label on the inside of the fuel filler flap. If your vehicle has tires of a different size than the size indicated on the Tire and Loading Information placard or, if available, the tire pressure label, you should determine the proper tire pressure for those tires.

As an added safety feature, your vehicle has been equipped with a tire pressure monitoring system (TPMS) that illuminates a low tire pressure telltale when one or more of your tires are significantly underinflated.

Accordingly, when the low tire pressure telltale lights up, you should stop and check your tires as soon as possible, and inflate them to the proper pressure. Driving on a significantly underinflated tire causes the tire to overheat and can lead to tire failure.

Underinflation also reduces fuel efficiency and tire tread life, and may affect the vehicle's handling and stopping ability. Please note that the TPMS is not a substitute for proper tire maintenance, and it is the driver's responsibility to maintain correct tire pressure, even if underinflation has not reached the level to trigger illumination of the TPMS low tire pressure telltale.

Your vehicle has also been equipped with a TPMS malfunction indicator to indicate when the system is not operating properly. The TPMS malfunction indicator is combined with the low tire pressure telltale. When the system detects a malfunction, the warning lamp will flash for approximately a minute and then remain continuously illuminated. This sequence will be repeated every time the vehicle is started as long as the malfunction exists. When the malfunction indicator is illuminated, the system may not be able to detect or signal low tire pressure as intended.

TPMS malfunctions may occur for a variety of reasons, including the installation of incompatible replacement or alternate tires or wheels on the vehicle that prevent the TPMS from functioning properly. Always check the TPMS malfunction telltale after replacing one or more tires or wheels on your vehicle to ensure that the replacement or alternate Tires and wheels allow the TPMS to continue to function properly.

It is the driver's responsibility to set the tire pressure to that recommended for cold tires which is suitable for the operating situation (> page 235). Note that the correct tire pressure for the current operating situation must first be taught-in to the tire pressure monitor. If there is a substantial loss of pressure, the warning threshold for the warning message is aligned to the reference values taught-in. Restart the tire pressure monitor after adjusting the pressure of the cold tires (> page 241). The current pressures are saved as new reference values.

As a result, a warning message will appear if the tire pressure drops significantly.

The tire pressure monitor does not warn you of an incorrectly set tire pressure. Observe the notes on the recommended tire pressure (▷ page 235).

The tire pressure monitor is not able to warn you of a sudden loss of pressure, e.g. if the tire is penetrated by a foreign object. In the event of a sudden loss of pressure, bring the vehicle to a halt by braking carefully. Avoid abrupt steering maneuvers.

The tire pressure monitor has a yellow warning lamp in the instrument cluster for indicating a pressure loss or malfunction. Whether the warning lamp flashes or lights up indicates whether a tire pressure is too low or the tire pressure monitor is malfunctioning:

- if the warning lamp is lit continuously, the tire pressure on one or more tires is significantly too low. The tire pressure monitor is not malfunctioning.
- if the warning lamp flashes for around a minute and then remains lit constantly, the tire pressure monitor is malfunctioning.

i In addition to the warning lamp, a message appears in the multifunction display.

Further information can be found on (▷ page 170).

If the tire pressure monitor is malfunctioning, it may take more than ten minutes for the tire pressure warning lamp to inform you of the malfunction by flashing for approximately one minute and then remaining lit. When the malfunction has been rectified, the tire pressure warning lamp goes out after a few minutes of driving.

The tire pressure values indicated by the on-board computer may differ from those measured at a gas station with a pressure gauge. The tire pressures shown by the on-board computer refer to those measured at sea level. At high altitudes, the tire pressure values indicated by a pressure gauge are

higher than those shown by the on-board computer. In this case, do not reduce the tire pressures.

The operation of the tire pressure monitor can be affected by interference from radio transmitting equipment (e.g. radio headphones, two-way radios) that may be being operated in or near the vehicle.

Checking the tire pressure electronically

- ▶ Make sure that the SmartKey is in position **2** in the ignition lock (▷ page 111).
- ▶ Press the ◀ or ▶ button on the steering wheel to select the **Serv.** menu.
- ▶ Press the ▲ or ▼ button to select **Tire Pressure**.
- ▶ Press the **OK** button.

The current tire pressure of each tire is shown in the multifunction display.

If the vehicle has been parked for over 20 minutes, the **Tire pressure will be displayed after driving a few minutes** message appears.

After a teach-in process, the tire pressure monitor automatically detects new wheels or new sensors. As long as a clear allocation of the tire pressure value to the individual wheels is not possible, the **Tire Pressure Monitor Active** display message is shown instead of the tire pressure display. The tire pressures are already being monitored.

i If an emergency spare wheel is mounted, the system may continue to show the tire pressure of the wheel that has been removed for a few minutes. If this occurs, note that the value displayed for the position where the spare wheel is mounted is not the same as the current tire pressure of the emergency spare wheel.

Tire pressure monitor warning messages

If the tire pressure monitor detects a pressure loss in one or more tires, a warning message is shown in the multifunction display and the yellow tire pressure monitor warning lamp comes on.

- If the **Correct Tire Pressure** message appears in the multifunction display, the tire pressure in at least one tire is too low and must be corrected at the next opportunity.
- If the **Check Tire Pressure** message appears in the multifunction display, the tire pressure in one or more tires has dropped significantly and the tires must be checked.
- If the **Tire Pressure Warning Tire Malfunction** message appears in the multifunction display, the tire pressure in one or more tires has dropped suddenly and the tires must be checked.

Observe the instructions and safety notes in the display messages in the "Tires" section (▷ page 170).

- ❗ If the wheel positions on the vehicle are rotated, the tire pressures may be displayed for the wrong positions for a short time. This is rectified after a few minutes of driving, and the tire pressures are displayed for the correct positions.

Restarting the tire pressure monitor

When you restart the tire pressure monitor, all existing warning messages are deleted and the warning lamps go out. The monitor uses the currently set tire pressures as the reference values for monitoring. In most cases, the tire pressure monitor will automatically detect the new reference values after you have changed the tire pressure. However, you can also define reference values manually as described here. The tire pressure monitor then monitors the new tire pressure values.

- ▶ Set the tire pressure to the value recommended for the corresponding driving situation on the Tire and Loading Information placard on the driver's side B-pillar (▷ page 235).
Additional tire pressure values for different loads can also be found on the tire pressure table on the inside of the fuel filler flap (▷ page 235).
- ▶ Make sure that the tire pressure is correct on all four wheels.
- ▶ Make sure that the SmartKey is in position **2** in the ignition lock.
- ▶ Press the ◀ or ▶ button on the steering wheel to select the **Serv.** menu.
- ▶ Press the ▲ or ▼ button to select **Tire Pressure**.
- ▶ Press the **OK** button.
The multifunction display shows the current tire pressure for the individual tires or the **Tire pressure will be displayed after driving a few minutes** message.
- ▶ Press the ▼ button.
The **Use Current Pressures as New Reference Values** message appears in the multifunction display.

If you wish to confirm the restart:

- ▶ Press the **OK** button.
The **Tire Press. Monitor Restarted** message appears in the multifunction display.
After driving for a few minutes, the system checks whether the current tire pressures are within the specified range. The new tire pressures are then accepted as reference values and monitored.

If you wish to cancel the restart:

- ▶ Press the ↩ button.
The tire pressure values stored at the last restart will continue to be monitored.

Loading the vehicle

Instruction labels for tires and loads

WARNING

Overloaded tires can overheat, causing a blowout. Overloaded tires can also impair the steering and driving characteristics and lead to brake failure. There is a risk of accident.

Observe the load rating of the tires. The load rating must be at least half of the GAWR of your vehicle. Never overload the tires by exceeding the maximum load.

Two instruction labels on your vehicle show the maximum possible load.

- (1) The Tire and Loading Information placard is on the B-pillar on the driver's side. The Tire and Loading Information placard shows the maximum permissible number of occupants and the maximum permissible vehicle load. It also contains details of the tire sizes and corresponding pressures for tires mounted at the factory.
- (2) The vehicle identification plate is on the B-pillar on the driver's side. The vehicle identification plate informs you of the gross vehicle weight rating. It is made up of the vehicle weight, all vehicle occupants, the fuel and the cargo. You can also find information about the maximum gross axle weight rating on the front and rear axle.

The maximum gross axle weight rating is the maximum weight that can be carried by one axle (front or rear axle). Never exceed the maximum load or the maximum gross axle weight rating for the front or rear axle.



① B-pillar, driver's side

Maximum permissible gross vehicle weight rating

TIRE		LOADING INFORMATION	
PNEU		RENSEIGNEMENTS POUR LES PNEUS ET LE CHARGEMENT	
SEATING CAPACITY NOMBRE DE SIÈGES	TOTAL	FRONT AVANT	MIDDLE MILIEU
7	7	2	3
REAR ARRIÈRE		2	
The combined weight of occupants and cargo should never exceed XXXX kg or XXXX lbs.* Le poids total des occupants et des marchandises ne doit jamais dépasser XXXX kg ou XXXX lbs.*			
TIRE PNEU	SIZE TAILLE	COLD TIRE PRESSURE PRESSION DES PNEUS À FROID	SEE OWNERS MANUAL FOR ADDITIONAL INFORMATIONS
FRONT AVANT	255/40 ZR18 99YXL	200 KPA, 29 PSI	
REAR ARRIÈRE	285/35 ZR18 101YXL	200 KPA, 29 PSI	
SPARE DE RECHANGE	175/55-18 95P	420 KPA, 40 PSI	

P40.00-2131-31

- Specification for maximum gross vehicle weight ① is listed in the Tire and Loading Information placard: "The combined weight of occupants and cargo should never exceed XXX kilograms or XXX lbs."

The gross weight of all vehicle occupants, cargo, luggage and trailer load/noseweight (if applicable) must not exceed the specified value.

- ① The specifications shown on the Tire and Loading Information placard in the illustration are examples. The maximum permissible gross vehicle weight rating is vehicle-specific and may differ from that in the illustration. You can find the valid maximum permissible gross vehicle weight rating for your vehicle on the Tire and Loading Information placard.

Number of seats

The placard is titled "TIRE AND LOADING INFORMATION" and "RENSEIGNEMENTS POUR LES PNEUS ET LE CHARGEMENT". It features a tire icon and a circled '1' pointing to the seating capacity information. The seating capacity is listed as 7 total seats, with 2 in the front, 3 in the middle, and 2 in the rear. Below this, it states: "The combined weight of occupants and cargo should never exceed XXXX kg or XXXX lbs." and "Le poids total des occupants et des marchandises ne doit jamais dépasser XXXX kg ou XXXX lbs." The placard also includes a table for tire specifications and a reference to the owner's manual.

TIRE PNEU	SIZE TAILLE	COLD TIRE PRESSURE PRESSION DES PNEUS A FROID	SEE OWNERS MANUAL FOR ADDITIONAL INFORMATION
FRONT AVANT	255/40 ZR18 99Y XL	200 KPA, 29 PSI	SEE OWNERS MANUAL FOR ADDITIONAL INFORMATION
REAR ARRIERE	286/35 ZR18 101Y XL	200 KPA, 29 PSI	
SPARE DE RECHANGE	175/55-18 95P	420 KPA, 60 PSI	

P40.00-2132-31

Maximum number of seats ① indicates the maximum number of occupants allowed to travel in the vehicle. This information can be found on the Tire and Loading Information placard.

i The specifications shown on the Tire and Loading Information placard in the illustration are examples. The number of seats is vehicle-specific and can differ from the details shown. The number of seats in your vehicle can be found on the Tire and Loading Information placard.

Determining the correct load limit

Step-by-step instructions

The following steps have been developed as required of all manufacturers under Title 49, Code of U.S. Federal Regulations, Part 575 pursuant to the "National Traffic and Motor Vehicle Safety Act of 1966".

- ▶ **Step 1:** Locate the statement "The combined weight of occupants and cargo should never exceed XXX kg or XXX lbs." on your vehicle's Tire and Loading Information placard.
- ▶ **Step 2:** Determine the combined weight of the driver and passengers that will be riding in your vehicle.
- ▶ **Step 3:** Subtract the combined weight of the driver and passengers from XXX kilograms or XXX lbs.

▶ **Step 4:** The resulting figure equals the available amount of cargo and luggage load capacity. For example, if the "XXX" amount equals 1400 lbs and there will be five 150 lbs passengers in your vehicle, the amount of available cargo and luggage load capacity is 650 lbs (1 400 - 750 (5 x 150) = 650 lbs).

▶ **Step 5:** Determine the combined weight of luggage and cargo being loaded on the vehicle. That weight may not safely exceed the available cargo and luggage load capacity calculated in step 4.

Example: steps 1 to 3

The following table shows examples on how to calculate total and cargo load capacities with varying seating configurations and number and size of occupants. The following examples use a load limit of 1 500 lbs (680 kg). **This is for illustration purposes only.** Make sure you are using the actual load limit for your vehicle stated on your vehicle's Tire and Loading Information placard (> page 243).

The greater the combined weight of the occupants, the lower the maximum luggage load.

Step 1

	Example 1	Example 2
Combined maximum weight of occupants and cargo (data from the Tire and Loading Information placard)	1500 lbs (680 kg)	1500 lbs (680 kg)

Step 2

	Example 1	Example 2
Number of people in the vehicle (driver and occupants)	1	2
Weight of the occupants	Occupant 1: 175 lbs (80 kg)	Occupant 1: 175 lbs (80 kg) Occupant 2: 195 lbs (88 kg)
Gross weight of all occupants	175 lbs (80 kg)	370 lbs (168 kg)

Step 3

	Example 1	Example 2
Permissible load (maximum gross vehicle weight rating from the Tire and Loading Information placard minus the gross weight of all occupants)	1500 lbs (680 kg) -175 lbs (80 kg) = 1325 lbs (600 kg)	1500 lbs (680 kg) -370 lbs (168 kg) = 1130 lbs (512 kg)

Vehicle identification plate

Even if you have calculated the total cargo carefully, you should still make sure that the gross vehicle weight rating and the gross axle weight rating are not exceeded. Details can be found on the vehicle identification plate on

the B-pillar on the driver's side of the vehicle (> page 242).

Gross vehicle weight: the gross weight of the vehicle, all passengers, cargo and trailer load/noseweight (if applicable) must not exceed the permissible gross vehicle weight.

Gross axle weight rating: the maximum permissible weight that can be carried by one axle (front or rear axle).

To ensure that your vehicle does not exceed the maximum permissible values (gross vehicle weight and maximum gross axle weight rating), have your loaded vehicle (including driver, occupants, cargo, and full trailer load if applicable) weighed on a suitable vehicle weighbridge.

All about wheels and tires

Uniform Tire Quality Grading Standards

Overview of Tire Quality Grading Standards

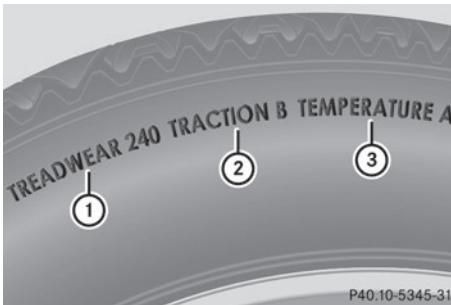

Uniform Tire Quality Grading Standards are U.S. government specifications. Their purpose is to provide drivers with uniform reliable information on tire performance data. Tire manufacturers have to grade tires using three performance factors: tread wear ①, tire traction ② and heat resistance ③. All tires sold in North America are provided with the corresponding quality class mark on the sidewall of the tire, even though these regulations do not apply to Canada. Quality grades can be found, where applicable, on the tire sidewall between the tread shoulder and maximum tire width.

Example:

- **Treadwear grade:** 200
- **Traction grade:** AA
- **Temperature grade:** A

All passenger car tires must conform to the statutory safety requirements in addition to these grades.

- ① The actual values for tires are vehicle-specific and may deviate from the values in the illustration.

Treadwear

The treadwear grade is a comparative rating based on the wear rate of the tire when tested under controlled conditions on a specified U.S. government course. For example, a tire graded 150 would wear one and one-half times as well on the government course as a tire graded 100.

The relative performance of tires depends upon the actual conditions of their use, however, and may depart significantly from the norm due to variations in driving habits, service practices and differences in road characteristics and climate conditions.

Traction

WARNING

The traction grade assigned to this tire is based on straight-ahead braking traction tests, and does not include acceleration, cornering, hydroplaning, or peak traction characteristics.

- ❗ **Avoid wheelspin.** This can lead to damage to the drive train.

The traction grades – from highest to lowest – are AA, A, B and C. Those grades represent the tire's ability to stop on wet pavement as measured under controlled conditions on specified government test surfaces of asphalt and concrete. A tire marked C may have poor traction performance.

The safe speed on a wet, snow covered or icy road is always lower than on dry road surfaces.

You should pay special attention to road conditions when temperatures are around freezing point.

Mercedes-Benz recommends a minimum tread depth of $\frac{1}{8}$ in (4 mm) on all four winter tires. Observe the legally required minimum tire tread depth (▷ page 233). Winter tires can reduce the braking distance on snow-covered surfaces in comparison with summer tires. The braking distance is still much further than on surfaces that are not icy or covered with snow. Take appropriate care when driving. Further information on winter tires (M+S tires) (▷ page 234).

Temperature

WARNING

The temperature grade for this tire is established for a tire that is properly inflated and not overloaded. Excessive speed, underinflation, or excessive loading, either separately or in combination, can cause excessive heat build-up and possible tire failure.

The temperature grades are A (the highest), B, and C. They represent the tire's resistance to the generation of heat and its ability to dissipate heat when tested under controlled conditions on a specified indoor laboratory test wheel. Sustained high temperature can cause the material of the tire to degenerate and reduce tire life, and excessive temperature can lead to sudden tire failure. The grade C corresponds to a level of performance which all passenger car tires must meet under the Federal Motor Vehicle Safety Standard No. 109. Grades B and A represent higher levels of performance on the laboratory test wheel than the minimum required by law.

Tire labeling

Overview

The following markings are on the tire in addition to the tire name (sales designation) and the manufacturer's name:

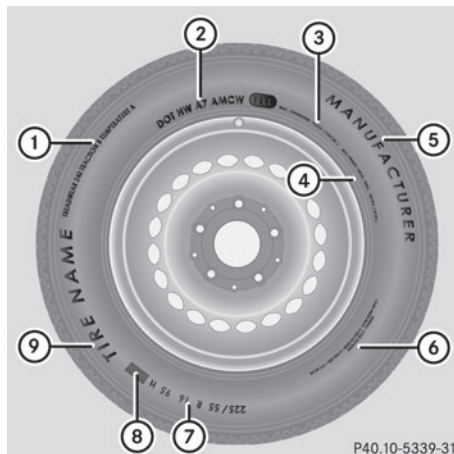

- ① Uniform Tire Quality Grading Standard (▷ page 250)
 - ② DOT, Tire Identification Number (▷ page 249)
 - ③ Maximum tire load (▷ page 249)
 - ④ Maximum tire pressure (▷ page 238)
 - ⑤ Manufacturer
 - ⑥ Tire material (▷ page 250)
 - ⑦ Tire size designation, load-bearing capacity and speed rating (▷ page 246)
 - ⑧ Load index (▷ page 249)
 - ⑨ Tire name
- i** Tire data is vehicle-specific and may deviate from the data in the example.

Tire size designation, load-bearing capacity and speed rating

WARNING

Exceeding the stated tire load-bearing capacity and the approved maximum speed could lead to tire damage or the tire bursting. There is a risk of accident.

Therefore, only use tire types and sizes approved for your vehicle model. Observe the tire load rating and speed rating required for your vehicle.

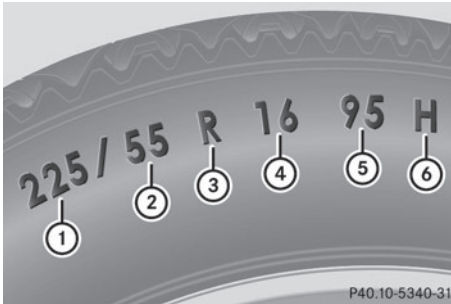

- ① Tire width
- ② Nominal aspect ratio in %
- ③ Tire code
- ④ Rim diameter
- ⑤ Load bearing index
- ⑥ Speed rating

i Tire data is vehicle-specific and may deviate from the data in the example.

General: depending on the manufacturer's standards, the size imprinted in the tire wall may not contain any letters or may contain one letter that precedes the size description. If there is no letter preceding the size description (as shown above): these are passenger vehicle tires according to European manufacturing standards.

If "P" precedes the size description: these are passenger vehicle tires according to U.S. manufacturing standards.

If "LT" precedes the size description: these are light truck tires according to U.S. manufacturing standards.

If "T" precedes the size description: these are compact emergency spare wheels at high tire pressure, to be used only temporarily in an emergency.

Tire width: tire width ① shows the nominal tire width in millimeters.

Aspect ratio: aspect ratio ② is the size ratio between the tire height and tire width and is shown in percent. The aspect ratio is calculated by dividing the tire width by the tire height.

Tire code: tire code ③ specifies the tire type. "R" represents radial tires; "D" represents diagonal tires; "B" represents diagonal radial tires.

Optionally, tires with a maximum speed of over 149 mph (240 km/h) may have "ZR" in the size description depending on the manufacturer (e.g. 245/40 ZR 18).

Rim diameter: rim diameter ④ is the diameter of the bead seat, not the diameter of the rim flange. The rim diameter is specified in inches (in).

Load-bearing index: load-bearing index ⑤ is a numerical code that specifies the maximum load-bearing capacity of a tire.

Do not overload the tires by exceeding the specified load limit. The maximum permissible load can be found on the vehicle's Tire and Loading Information placard on the B-pillar on the driver's side (> page 242).

Example:

Load-bearing index 91 indicates a maximum load of 1,356 lb (615 kg) that the tires can bear. For further information on the maximum tire load in kilograms and lbs, see (> page 249).

For further information on the load bearing index, see "Load index" (> page 249).

Speed rating: speed rating ⑥ specifies the approved maximum speed of the tire.

Regardless of the speed rating, always observe the speed limits. Drive carefully and adapt your driving style to the traffic conditions.

Summer tires

Index	Speed rating
Q	up to 100 mph (160 km/h)
R	up to 106 mph (170 km/h)
S	up to 112 mph (180 km/h)
T	up to 118 mph (190 km/h)
H	up to 130 mph (210 km/h)
V	up to 149 mph (240 km/h)
W	up to 168 mph (270 km/h)
Y	up to 186 mph (300 km/h)
ZR...Y	up to 186 mph (300 km/h)
ZR...(..Y)	over 186 mph(300 km/h)
ZR	over 149 mph (240 km/h)

- Optionally, tires with a maximum speed of over 149 mph (240 km/h) may have "ZR" in the size description depending on the manufacturer (e.g. 245/40 ZR 18).

The service specification is made up of load-bearing index (5) and speed rating (6).

- If the size description of your tire includes "ZR" and there are no service specifications, ask the tire manufacturer in order to find out the maximum speed.

If a service specification is available, the maximum speed is limited according to the speed rating in the service specification. Example: 245/40 ZR 18 97 Y. In this example, "97 Y" is the service specification. The letter "Y" represents the speed index and the maximum speed of the tire is limited to 186 mph (300 km/h).

- The size description for all tires with maximum speeds of over 186 mph (300 km/h) must include "ZR" **and** the service specification must be given in brackets. Example:

⁷ Or M+S  for winter tires.

275/40 ZR 18 (99 Y). The speed index "(Y)" indicates that the maximum speed of the tire is over 186 mph (300 km/h). Ask the tire manufacturer about the maximum speed.

All-weather tires and winter tires

Index	Speed rating
Q M+S ⁷	up to 100 mph (160 km/h)
T M+S ⁷	up to 118 mph (190 km/h)
H M+S ⁷	up to 130 mph (210 km/h)
V M+S ⁷	Up to 149 mph (240 km/h)

- i** Not all tires with the M+S marking provide the driving characteristics of winter tires. In addition to the M+S marking, winter tires also have the  snowflake symbol on the tire wall. Tires with this marking fulfill the requirements of the Rubber Manufacturers Association (RMA) and the Rubber Association of Canada (RAC) regarding snow traction, and were specially developed for driving on snow.

The speed rating of tires mounted at the factory may be higher than the maximum speed that the electronic speed limiter permits.

Make sure that your tires have the required speed rating for your vehicle as specified in the "Tires" section (▷ page 257), e.g. if you buy new tires.

Further information about reading tire data can be obtained from any qualified specialist workshop.

Load index



i Tire data is vehicle-specific and may deviate from the data in the example.

In addition to the load-bearing index, load index ① may be imprinted after the letters that identify speed rating ⑥ (▷ page 246) on the sidewall of the tire.

- If no specification is given: no text (as in the example above), represents a standard load (SL) tire
- XL or Extra Load: represents a reinforced tire
- Light Load: represents a light load tire
- C, D, E: represents a load range that depends on the maximum load that the tire can carry at a certain pressure

Maximum load rating



Maximum tire load ① is the maximum permissible weight for which the tire is approved.

Do not overload the tires by exceeding the specified load limit. The maximum

permissible load can be found on the vehicle's Tire and Loading Information placard on the B-pillar on the driver's side (▷ page 242).

i The actual values for tires are vehicle-specific and may deviate from the values in the illustration.

DOT, Tire Identification Number (TIN)

U.S. tire regulations stipulate that every tire manufacturer or retreader must imprint a TIN in or on the sidewall of each tire produced.

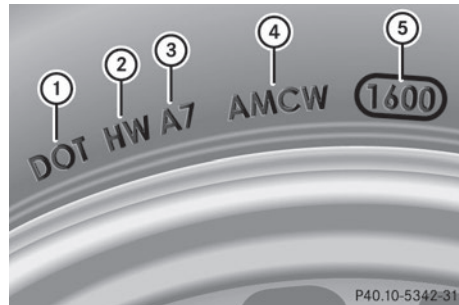

The TIN is a unique identification number. The TIN enables tire manufacturers to inform purchasers of recalls and other safety-relevant matters. It makes it possible for the purchaser to easily identify the affected tires. The TIN is made up of manufacturer identification code ②, tire size ③, tire type code ④ and manufacturing date ⑤.

i Tire data is vehicle-specific and may deviate from the data in the example.

DOT (Department of Transportation): tire symbol ① marks that the tire complies with the requirements of the U.S. Department of Transportation.

Manufacturer identification code: manufacturer identification code ② provides details on the tire manufacturer. New tires have a code with two symbols.

Tire size: identifier ③ describes the tire size.

Tire type code: tire type code ④ can be used by the manufacturer as a code to describe specific characteristics of the tire.

Date of manufacture: date of manufacture ⑤ provides information about the age of a tire. The first and second positions represent the week of manufacture, starting with "01" for the first calendar week. Positions three and four represent the year of manufacture. For example, a tire that is marked with "3208" was manufactured in week 32 in 2008.

Tire characteristics

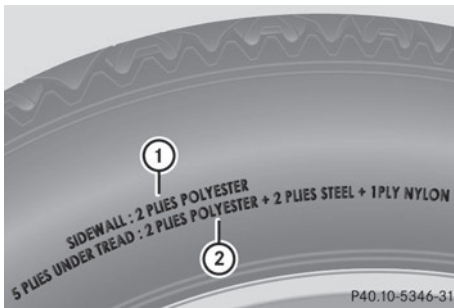

i Tire data is vehicle-specific and may deviate from the data in the example.

This information describes the tire cord and the number of layers in sidewall ① and under tire tread ②.

Definition of terms for tires and loading

Tire ply composition and material used

Describes the number of plies or the number of layers of rubber-coated fabric in the tire tread and sidewall. These are made of steel, nylon, polyester and other materials.

Bar

Metric unit for tire pressure. There are 14.5038 pounds per square inch (psi) to 1 bar; there are 100 kilopascals (kPa) to 1 bar.

DOT (Department of Transportation)

DOT-marked tires fulfill the requirements of the U S Department of Transportation.

Normal occupant weight

The number of occupants the vehicle is designed to seat, multiplied by 68 kilograms (150 lbs).

Uniform Tire Quality Grading Standards

A uniform standard to grade the quality of tires with regards to tread quality, tire traction and temperature characteristics. The quality grading assessment is made by the manufacturer following specifications from the U.S. government. The ratings are molded into the sidewall of the tire.

Recommended tire pressures

The recommended tire pressure for your vehicle under normal driving conditions. You will find the recommendation on the Tire and Loading Information placard on the B-pillar on the driver's side of your vehicle. The recommended tire pressure provides the best balance between handling characteristics, ride comfort and wear. Supplemental information pertaining to special driving situations can be found on the tire inflation pressure label on the inside of the fuel filler flap.

Increased vehicle weight due to optional equipment

The combined weight of all standard and optional equipment available for the vehicle, regardless of whether it is actually installed on the vehicle or not.

Rim

This is the part of the wheel on which the tire is mounted.

GAWR (Gross Axle Weight Rating)

The GAWR is the maximum permissible axle weight. The actual load on an axle must never exceed the gross axle weight rating. The gross axle weight rating can be found on the

vehicle identification plate on the B-pillar on the driver's side.

Speed rating

The speed rating is part of the tire identification. It specifies the speed range for which the tire is approved.

GVW (Gross Vehicle Weight)

The gross vehicle weight includes the weight of the vehicle including fuel, tools, the spare wheel, accessories installed, occupants, luggage and the drawbar noseweight, if applicable. The gross vehicle weight must not exceed the gross vehicle weight rating (GVWR) as specified on the vehicle identification plate on the B-pillar on the driver's side.

GVWR (Gross Vehicle Weight Rating)

The GVWR is the maximum permitted gross weight of the fully loaded vehicle (weight of the vehicle including all accessories, occupants, fuel, luggage and the drawbar noseweight if applicable). The gross vehicle weight rating is specified on the vehicle identification plate on the B-pillar on the driver's side.

Maximum loaded vehicle weight

The maximum weight is the sum of the curb weight of the vehicle, the weight of the accessories, the total load limit and the weight of the optional equipment installed at the factory.

Kilopascal (kPa)

Metric unit for tire pressure. 6.9 kPa is the equivalent of 1 psi. Another unit for tire pressure is bar. There are 100 kilopascals (kPa) to 1 bar.

Load index

In addition to the load-bearing index, the load index may also be imprinted on the sidewall of the tire. This specifies the load-bearing capacity more precisely.

Curb weight

The weight of a vehicle with standard equipment including the maximum capacity of fuel, oil and coolant. It also includes the air-conditioning system and optional equipment if these are installed in the vehicle, but does not include passengers or luggage.

Maximum load rating

The maximum load rating in kilograms or pounds is the maximum weight for which a tire is approved.

Maximum permissible tire pressure

Maximum permissible tire pressure for one tire.

Maximum load on one tire

Maximum load on one tire. This is calculated by dividing the maximum axle load of one axle by two.

PSI (pounds per square inch)

A standard unit of measure for tire pressure.

Aspect ratio

Relationship between tire height and tire width in percent.

tire pressure

This is pressure inside the tire applying an outward force to each square inch of the tire's surface. The tire pressure is specified in pounds per square inch (psi), in kilopascal (kPa) or in bar. The tire pressure should only be corrected when the tires are cold. For this, the vehicle must have been stationary for at least three hours or not have traveled more than 1.6 km (1 mile) in this time.

Tire pressure of cold tires

The tires are cold:

- if the vehicle has been parked without direct sunlight on the tires for at least three hours and
- if the vehicle has not been driven more than 1 mile (1.6 km)

Tread

The part of the tire that comes into contact with the road.

Bead

The tire bead ensures that the tire sits securely on the wheel. There are several steel wires in the bead to prevent the tire from coming loose from the wheel rim.

Sidewall

The part of the tire between the tread and the bead.

Weight of optional extras

The combined weight of those optional extras that weigh more than the replaced standard part and more than 2.3 kilograms (5 lbs). These optional extras, such as high-performance brakes, level control, a roof rack or a high-performance battery, are not included in the curb weight and the weight of the accessories.

TIN (Tire Identification Number)

This is a unique identifier which can be used by a tire manufacturer to identify tires, for example for a product recall, and thus identify the purchasers. The TIN is made up of the manufacturer's identity code, tire size, tire type code and the manufacturing date.

Load bearing index

The load bearing index (also load index) is a code that contains the maximum load bearing capacity of a tire.

Traction

Traction is the result of friction between the tires and the road surface.

Treadwear indicators

This is indicated by narrow bars (treadwear bars) that are distributed over the tire tread. If the tire tread is level with the bars, the wear limit of $\frac{1}{16}$ in (1.6 mm) has been reached.

Occupant distribution

The distribution of occupants in a vehicle at their designated seating positions.

Total load limit

Rated cargo and luggage load plus 68 kilograms (150 lb) times the vehicle's designated seating capacity.

Changing a wheel**Flat tire**

The "Breakdown assistance" section (> page 217) contains information and notes on how to deal with a flat tire.

Rotating the wheels**⚠ WARNING**

Interchanging the front and rear wheels may severely impair the driving characteristics if the wheels or tires have different dimensions. The wheel brakes or suspension components may also be damaged. There is a risk of accident.

Rotate front and rear wheels only if the wheels and tires are of the same dimensions.

❗ On vehicles equipped with a tire pressure monitor, electronic components are located in the wheel.

Tire-mounting tools should not be used near the valve. This could damage the electronic components.

Only have tires changed at a qualified specialist workshop.

Always pay attention to the instructions and safety notes when changing a wheel (> page 253).

The wear patterns on the front and rear tires differ, depending on the operating conditions. Rotate the wheels before a clear wear pattern has formed on the tires. Front tires typically wear more on the shoulders and the rear tires in the center.

If your vehicle's tire configuration allows, you can change the wheels according to the intervals in the tire manufacturer's warranty book in your vehicle documents. If no warranty book is available, the tires should be rotated every 3,000 to 6,000 miles (5,000 to 10,000 km), or earlier if tire wear requires. Do not change the direction of wheel rotation.

Clean the contact surfaces of the wheel and the brake disc thoroughly every time a wheel is rotated. Check the tire pressure and reactivate the tire pressure monitor if necessary.

Direction of rotation

Tires with a specified direction of rotation have additional benefits, e.g. if there is a risk of hydroplaning. You will only gain these benefits if the correct direction of rotation is maintained.

An arrow on the sidewall of the tire indicates its correct direction of rotation.

Storing wheels

Store wheels that are not being used in a cool, dry and preferably dark place. Protect the tires from oil, grease, gasoline and diesel.

Cleaning the wheels

WARNING

The water jet from a circular jet nozzle (dirt blasters) can cause invisible exterior damage to the tires or chassis components.

Components damaged in this way may fail unexpectedly. There is a risk of an accident.

Do not use power washers with circular jet nozzles to clean the vehicle. Have damaged tires or chassis components replaced immediately.

Mounting a wheel

Preparing the vehicle

- ▶ Stop the vehicle on solid, non-slippery and level ground.
- ▶ Apply the electric parking brake manually.
- ▶ Bring the front wheels into the straight-ahead position.
- ▶ Shift the transmission to position **P**.
- ▶ Switch off the engine.
- ▶ Open the driver's door.
The on-board electronics now have status **O**. This is the same as the SmartKey having been removed.
- ▶ Remove Start/Stop button from ignition lock (▷ page 111).
- ▶ Take the following objects from the left-hand stowage compartment and the left-hand stowage space in the trunk:
 - lug wrench
 - folding wheel chock
 - jack
 - alignment bolt
- ▶ Secure the vehicle to prevent it from rolling away.

Securing the vehicle to prevent it from rolling away

If your vehicle is equipped with a wheel chock, it can be found in the vehicle tool kit (▷ page 216).

The folding wheel chock is an additional safety measure to prevent the vehicle from rolling away, for example when changing a wheel.

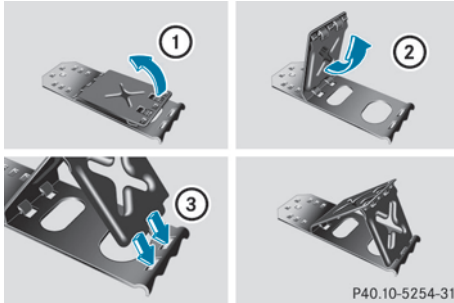

- ▶ Fold both plates upwards ①.
- ▶ Fold out lower plate ②.
- ▶ Guide the lugs on the lower plate fully into the openings in base plate ③.

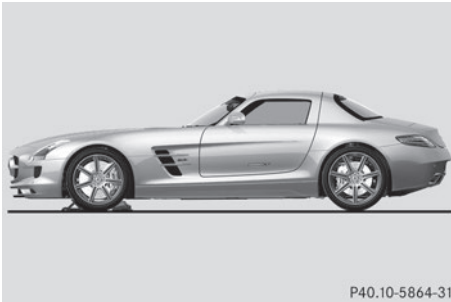

Securing the vehicle on level ground

- ▶ **On level ground:** place chocks or other suitable items under the front and rear of the wheel that is diagonally opposite the wheel you wish to change.

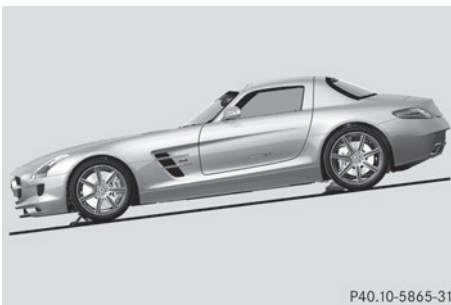

Securing the vehicle on slight downhill gradients

- ▶ **On downhill gradients:** place chocks or other suitable items in front of the wheels of the front and rear axle.

Raising the vehicle

⚠ WARNING

If you do not position the jack correctly at the appropriate jacking point of the vehicle, the jack could tip over with the vehicle raised. There is a risk of injury.

Only position the jack at the appropriate jacking point of the vehicle. The base of the jack must be positioned vertically, directly under the jacking point of the vehicle.

The following must be observed when raising the vehicle:

- to raise the vehicle, only use the vehicle-specific jack that has been tested and approved by Mercedes-Benz. If used incorrectly, the jack could tip over with the vehicle raised.
- the jack is designed only to raise and hold the vehicle for a short time while a wheel is being changed. It is not suited for performing maintenance work under the vehicle.
- avoid changing the wheel on uphill and downhill slopes.
- before raising the vehicle, secure it from rolling away by applying the electric parking brake and positioning wheel chocks. Never release the electric parking brake while the vehicle is raised.
- the jack must be placed on a firm, flat and non-slip surface. On a loose surface, a large, load-bearing underlay must be used. On a slippery surface, a non-slip underlay must be used, e.g. rubber mats.
- do not use wooden blocks or similar objects as a jack underlay. Otherwise, the jack will not be able to achieve its load-bearing capacity due to the restricted height.
- make sure that the distance between the underside of the tires and the ground does not exceed 1.2 in (3 cm).
- never place your hands and feet under the raised vehicle.

- never lie under the raised vehicle.
- never start the engine when the vehicle is raised.
- never open or close a door or the trunk lid when the vehicle is raised.
- make sure that no persons are present in the vehicle when the vehicle is raised.

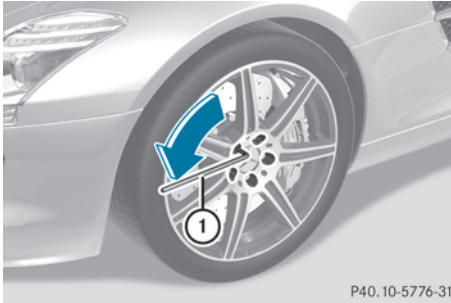

- ▶ Using lug wrench (1), loosen the bolts on the wheel you wish to change by about one full turn. Do not unscrew the wheel bolts completely.

The mounting for the jack is centered between the front and rear wheel housings (arrow).

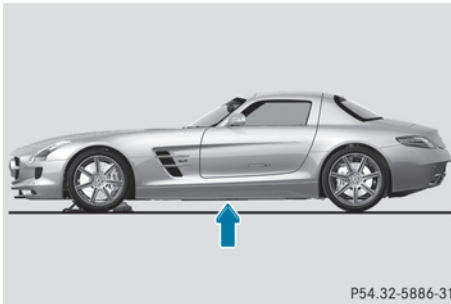

- ⚠ The jack is designed exclusively for jacking up the vehicle at the jacking points. Otherwise, your vehicle could be damaged.

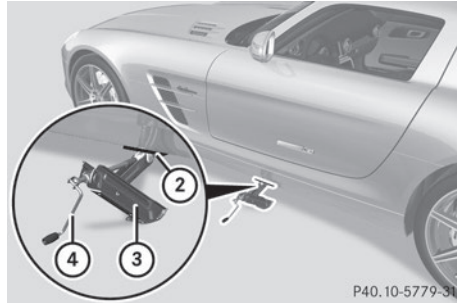

- ▶ Position jack (3) at jacking point (2).

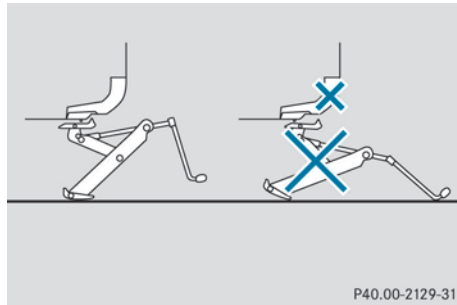

Example

- ▶ Make sure that the base of the jack is positioned directly under jacking point (2).
- ▶ Turn crank (4) clockwise until jack (3) sits completely on jacking point (2) and the base of the jack lies evenly on the ground.
- ▶ Turn crank (4) until the tire is raised a maximum of 1.2 inches (3 cm) off the ground.

Removing a wheel

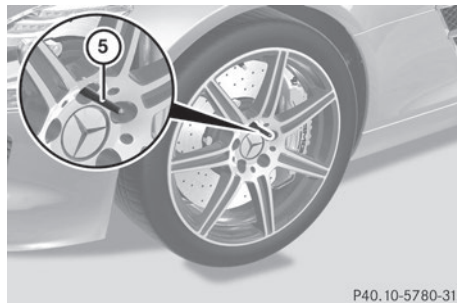

- ▶ Unscrew the uppermost wheel bolt completely.
- ▶ Screw alignment bolt ⑤ into the thread instead of the wheel bolt.
- ▶ Unscrew the remaining wheel bolts fully.

! Do not place wheel bolts in sand or on a dirty surface. The bolt and wheel hub threads could otherwise be damaged when you screw them in.

! AMG ceramic high performance compound brake system:

When detaching or attaching the wheel, the wheel rim may hit against the ceramic brake disc and damage it.

For this reason, you should proceed carefully. Request the assistance of a second person or use a second alignment bolt.

- ▶ Remove the wheel.

Mounting a new wheel

⚠ WARNING

Oiled or greased wheel bolts or damaged wheel bolts/hub threads can cause the wheel bolts to come loose. As a result, you could lose a wheel while driving. There is a risk of accident.

Never oil or grease wheel bolts. In the event of damage to the threads, contact a qualified specialist workshop immediately. Have the damaged wheel bolts or hub threads replaced/renewed. Do not continue driving.

⚠ WARNING

If you tighten the wheel bolts or wheel nuts when the vehicle is raised, the jack could tip over. There is a risk of injury.

Only tighten the wheel bolts or wheel nuts when the vehicle is on the ground.

Always pay attention to the instructions and safety notes in the "Changing a wheel" section (▶ page 252).

Only use wheel bolts that have been designed for the wheel and the vehicle. For safety reasons, Mercedes-Benz recommends that you only use wheel bolts which have been approved for Mercedes-Benz vehicles and the respective wheel.

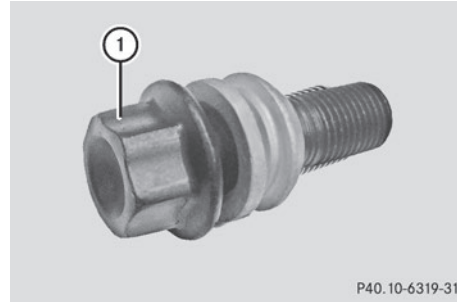

① Wheel bolt

- ▶ Clean the wheel and wheel hub contact surfaces.

! To prevent damage to the paintwork, hold the wheel securely against the wheel hub while screwing in the first wheel bolt.

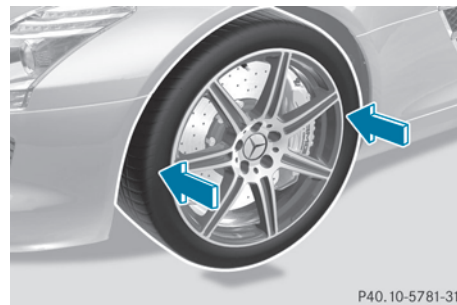

- ▶ Place the wheel onto the alignment bolt and push it on.



P40.10-5782-31

- ▶ Tighten the wheel bolts until they are finger-tight.
- ▶ Unscrew the alignment bolt.
- ▶ Tighten the last wheel bolt until it is finger-tight.

Lowering the vehicle

WARNING

The wheels could work loose if the wheel nuts and bolts are not tightened to the specified tightening torque. There is a risk of accident. Have the tightening torque immediately checked at a qualified specialist workshop after a wheel is changed.

- ▶ Turn the crank of the jack counter-clockwise until the vehicle is once again standing firmly on the ground.
- ▶ Place the jack to one side.

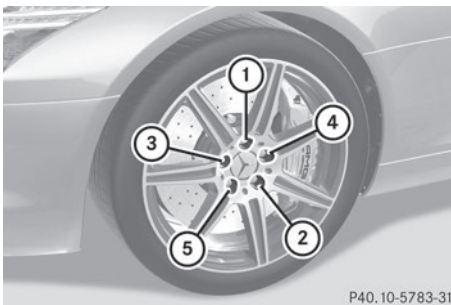

P40.10-5783-31

- ▶ Tighten the wheel bolts evenly in a crosswise pattern in the sequence indicated (① to ⑤). The specified tightening torque is **133 lb-ft (180 Nm)**.

- ▶ Turn the jack back to the out-of-use position and stow it in the trunk again with the rest of the wheel-changing tools.

Wheel and tire combinations

General notes

! For safety reasons, Mercedes-Benz recommends that you only use tires and wheels which have been approved by Mercedes-Benz specifically for your vehicle.

These tires have been specially adapted for use with the control systems, such as ABS or ESP®, and are marked as follows:

- MO = Mercedes-Benz Original
- MOE = Mercedes-Benz Original Extended (tires featuring run-flat characteristics)
- MO1 = Mercedes-Benz Original (only certain AMG tires)

Mercedes-Benz Original Extended tires may only be used on wheels that have been specifically approved by Mercedes-Benz.

Only use tires, wheels or accessories tested and approved by Mercedes-Benz. Certain characteristics, e.g. handling, vehicle noise emissions or fuel consumption, may otherwise be adversely affected. In addition, when driving with a load, tire dimension variations could cause the tires to come into contact with the bodywork and axle components. This could result in damage to the tires or the vehicle.

Mercedes-Benz accepts no liability for damage resulting from the use of tires, wheels or accessories other than those tested and approved.

Information on tires, wheels and approved combinations can be obtained from any qualified specialist workshop.

- i** The Tire and Load Information placard with the recommended tire pressures is on the B-pillar on the driver's side. Further information about driving at high speeds or

driving with vehicle loads that are lighter than the maximum vehicle load can be found in the tire pressure table on the inside of the fuel filler flap. Check tire pressures regularly, and only when the tires are cold. Comply with the maintenance recommendations of the tire manufacturer. These are located in the vehicle document wallet.

Further information on recommended tire pressures as well as tire pressures for specific driving situations, see (▷ page 235).

i Notes on the vehicle equipment – always equip the vehicle with:

- tires of the same size on a given axle (left/right)
- with the same type of tires on all wheels at a given time (summer tires, winter tires)

i The following pages contain information on approved wheel rims and tire sizes for equipping your vehicle with winter tires. Winter tires are not available at the factory as standard equipment or optional extras. If you wish to equip your vehicle with approved winter tires, you will also require, in certain circumstances, wheel rims of an appropriate size, as the sizes of approved winter tires can deviate from those of standard tires. This is dependent on the model and the equipment installed at the factory.

The tires and wheel rims, as well as further information, can be obtained at a qualified specialist workshop.

Tires

Summer tires

Front axle	
Summer tires	275/35 ZR19 (100Y) XL
Light alloy rim	10J x 19 H2 Wheel offset: 1.97 in (50 mm)
Rear axle	
Summer tyres ⁸	325/30 ZR20 (106Y) XL
Light alloy rim	12J x 20 H2 Wheel offset: 2.60 in (66 mm)

Winter tires

Front axle	
Winter tires	265/35 R19 98W XL M+S
Light alloy rim	9.5J x 19 H2 Wheel offset: 2.36 in (60 mm) or 9.5J x 19 H2 Wheel offset: 2.32 in (59 mm)
Rear axle	
Winter tires	295/30 R20 101W XL M+S
Light alloy rim	11J x 20 H2 Wheel offset: 2.68 in (68 mm)

⁸ Snow chains not permitted.

Useful information	262
Information regarding technical data	262
Warranty	262
Identification plates	262
Service products and filling capacities	263
Vehicle data	268

Useful information

- i** This Operator's Manual describes all models and all standard and optional equipment of your vehicle available at the time of publication of the Operator's Manual. Country-specific differences are possible. Please note that your vehicle may not be equipped with all features described. This also applies to safety-related systems and functions.
- i** Please read the information on qualified specialist workshops (▷ page 21).

Information regarding technical data

You can find technical data on the Internet at: <http://www.mercedes-benz.com>

- i** The data stated here specifically refers to a vehicle with standard equipment. Consult an authorized Mercedes-Benz Center for the data for all vehicle variants and trim levels.

Warranty

The Service and Warranty Information booklet contains detailed information about the warranties covering your vehicle.

Your authorized Mercedes-Benz Center will exchange or repair any defective parts originally installed in the vehicle in accordance with the terms of the following warranties:

- New Vehicle Limited Warranty
- Emission System Warranty
- Emission Performance Warranty
- California, Connecticut, Maine, Massachusetts, New York, Pennsylvania, Rhode Island and Vermont Emission Control System Warranty
- State warranty enforcement laws (Lemon Laws)

Replacement parts and accessories are covered by the Mercedes-Benz Parts and Accessories warranties. You can obtain information about this from any authorized Mercedes-Benz Center.

- i** Should you lose your Service and Warranty Information booklet, have an authorized Mercedes-Benz Center arrange for a replacement. It will be mailed to you.

Identification plates

Vehicle identification plate with vehicle identification number (VIN) and paint code number

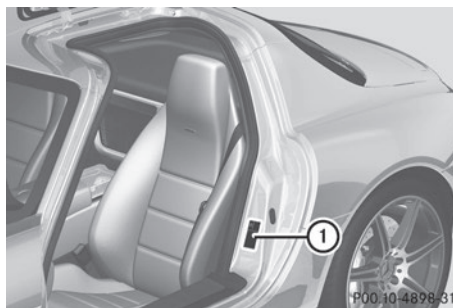

- ▶ Open the driver's door.
You will see vehicle identification plate ①.

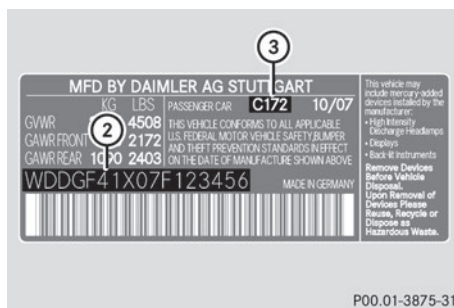

Example: vehicle identification plate (USA only)

- ② VIN
- ③ Paint code

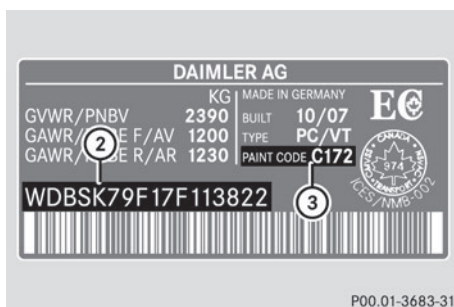

Example: vehicle identification plate (Canada only)

- ② VIN
- ③ Paint code

i The data shown on the identification plate is example data. This data is different for every vehicle and can deviate from the data shown here. You can find the data applicable to your vehicle on the vehicle identification plate.

VIN

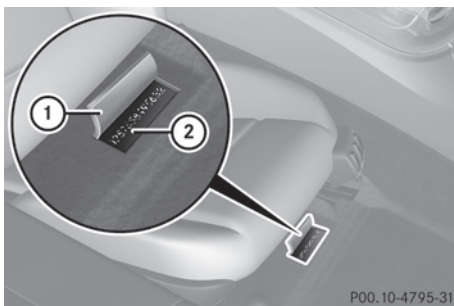

- ▶ Slide the right-hand front seat to its rearmost position.
- ▶ Fold floor covering ① upwards. You will see VIN ②.

Additionally, the vehicle identification number (VIN) can be found in the following locations:

- on the vehicle identification plate (▷ page 262)
- on the lower edge of the windshield (▷ page 263)

Engine number

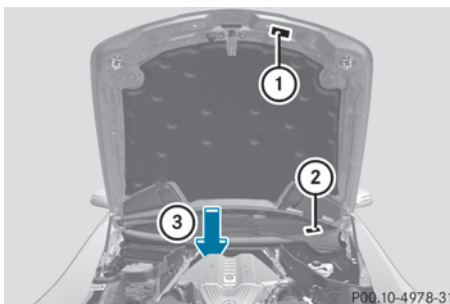

- ① Emission control information plate, including the certification of both federal and Californian emissions standards
- ② VIN (on the lower edge of the windshield)
- ③ Engine number (stamped into the crankcase)

Service products and filling capacities

Important safety notes

⚠ WARNING

Service products may be poisonous and hazardous to health. There is a risk of injury. Comply with instructions on the use, storage and disposal of service products on the labels of the respective original containers. Always store service products sealed in their original containers. Always keep service products out of the reach of children.

♻ Environmental note

Dispose of service products in an environmentally responsible manner.

Service products include the following:

- Fuels
- Lubricants (e.g. engine oil, transmission oil)
- Coolant
- Brake fluid
- Windshield washer fluid
- Climate control system refrigerant

Components and service products must be matched. You should therefore only use products that have been tested and approved by Mercedes-Benz.

Information on tested and approved products can be obtained at an authorized Mercedes-Benz Center or on the Internet at <http://bevo.mercedes-benz.com>.

You can recognize service products approved by Mercedes-Benz by the following inscription on the containers:

- MB-Freigabe (e.g. MB-Freigabe 331.0)
- MB-Approval (e.g. MB-Approval 331.0)

Other designations or recommendations indicate a level of quality or a specification in accordance with an MB Sheet Number (e.g. MB 331.0). They have not necessarily been approved by Mercedes-Benz.

Fuel

Technical data

Important safety notes

WARNING

Fuel is highly flammable. If you handle fuel incorrectly, there is a risk of fire and explosion.

You must avoid fire, open flames, creating sparks and smoking. Switch off the engine and, if applicable, the auxiliary heating before refueling.

WARNING

Fuel is poisonous and hazardous to health. There is a risk of injury.

You must make sure that fuel does not come into contact with your skin, eyes or clothing and that it is not swallowed. Do not inhale fuel vapors. Keep fuel away from children.

If you or others come into contact with fuel, observe the following:

- Wash away fuel from skin immediately using soap and water.
- If fuel comes into contact with your eyes, immediately rinse them thoroughly with clean water. Seek medical assistance without delay.
- If fuel is swallowed, seek medical assistance without delay. Do not induce vomiting.
- Immediately change out of clothing which has come into contact with fuel.

Tank capacity

Total capacity	22.5 gal (85 l)
Of which reserve	Approx. 3.7 gal (14 l)

Gasoline

Fuel grade

 Do not use diesel to refuel vehicles with a gasoline engine. Do not switch on the ignition if you accidentally refuel with the wrong fuel. Otherwise, the fuel will enter the fuel system. Even small amounts of the wrong fuel could result in damage to the fuel system and the engine. Notify a qualified specialist workshop and have the fuel tank and fuel lines drained completely.

 Only refuel using unleaded gasoline with a minimum octane rating of 91.

 To ensure the longevity and full performance of the engine, only premium-grade unleaded gasoline must be used.

If standard premium-grade unleaded gasoline is unavailable and unleaded gasoline of a lower grade is used for refueling, observe the following precautions:

- only fill the fuel tank to half full with regular unleaded gasoline and fill the rest

with premium-grade unleaded gasoline as soon as possible.

- do not drive at the maximum speed.
- avoid sudden acceleration and engine speeds above 3000 rpm.
- never refuel using fuel with an octane number lower than 87. Otherwise, engine failure could occur.

! Only use the fuel recommended. Operating the vehicle with other fuels can lead to engine failure.

Reformulated Gasoline (RFG) and/or unleaded gasoline with additives can be used. The concentration of additives in the fuel, however, must not exceed 10%, e.g.:

- Ethanol
- TAME
- ETBE
- IPA
- TBA

For MTBE, the concentration should not exceed 15%.

The concentration of methanol in gasoline, including other additives, must not exceed 3%.

Using mixtures of methanol and ethanol is not permitted. Gasohol, a mixture of 10% ethanol and 90% unleaded gasoline, may be used.

All of these blends must fulfill the fuel requirements, e.g.:

- knock resistance
- boiling point
- vapor pressure

You will usually find information about the fuel grade on the pump. If you cannot find the label on the pump, ask the staff for assistance.

i For further information, consult an authorized Mercedes-Benz Center or on the Internet at <http://www.mbusa.com> (USA only).

Information on refueling (▷ page 122).

Additives

! Operating the engine with fuel additives added later can lead to engine failure. Do not mix fuel additives with fuel. This does not include additives for the removal and prevention of residue buildup. Gasoline must only be mixed with additives recommended by Mercedes-Benz. Comply with the instructions for use on the product label. More information about recommended additives can be obtained from any authorized Mercedes-Benz Center.

Mercedes-Benz recommends that you use fuel brands that have the additives.

The quality of the fuel available in some countries may not be sufficient. Residue could build up as a result. In such cases, and in consultation with an authorized Mercedes-Benz Center, the gasoline may be mixed with the cleaning additive recommended by Mercedes-Benz (part no. A000989254512). You must observe the notes and mixing ratios specified on the container.

Engine oil

General notes

! Never use engine oil or an oil filter of a specification other than is necessary to fulfill the prescribed service intervals. Do not change the engine oil or oil filter in order to achieve longer replacement intervals than those prescribed. You could otherwise cause engine damage or damage to the exhaust gas aftertreatment.

Follow the instructions in the service interval display regarding the oil change. Otherwise, you may damage the engine and the exhaust gas aftertreatment.

When handling engine oil, observe the important safety notes on service products (▷ page 263).

The engine oils are matched to the performance of Mercedes-Benz engines and

service intervals. You should therefore only use engine oils and oil filters that are approved for vehicles with maintenance systems.

For a list of approved engine oils and oil filters, consult an authorized Mercedes-Benz Center. Or visit the website <http://bevo.mercedes-benz.com>.

The table shows which engine oils have been approved for your vehicle.

MB sheet number	229.5 ⁹
------------------------	--------------------

- i** MB approval is indicated on the oil containers.

Filling capacities

The following values refer to an oil change including the oil filter.

Engine with oil filter	10.0 US qt (9.5 l)
-------------------------------	--------------------

Additives

- !** Do not use any additives in the engine oil. This could damage the engine.

Engine oil viscosity

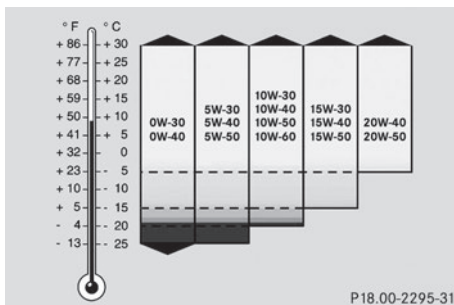

Viscosity describes the flow characteristics of a fluid. If an engine oil has a high viscosity, this means that it is thick; a low viscosity means that it is thin.

Select an engine oil with an SAE classification (viscosity) suitable for the prevailing outside

temperatures. The table shows you which SAE classifications are to be used. The low-temperature characteristics of engine oils can deteriorate significantly, e.g. as a result of aging, soot and fuel deposits. It is therefore strongly recommended that you carry out regular oil changes using an approved engine oil with the appropriate SAE classification.

Refrigerant of the air-conditioning system

Important safety notes

Type of refrigerant

The climate control system of your vehicle is filled with refrigerant R-134a.

The instruction label regarding the refrigerant type used can be found on the radiator cross member.

Refrigerant R-134a

- !** Only the refrigerant R-134a and the PAG oil approved by Mercedes-Benz may be used. The approved PAG oil may not be mixed with any other PAG oil that is not approved for R-134a refrigerant. Otherwise, the climate control system may be damaged.

Service work, such as topping-up refrigerant or replacing components, may only be carried out by a qualified specialist workshop. All applicable regulations must be adhered to, SAE standard J639 included.

Always have work on the climate control system carried out at a qualified specialist workshop.

⁹ Restriction: only use SAE 0W-40/SAE 5W-40 engine oils.

Refrigerant instruction label

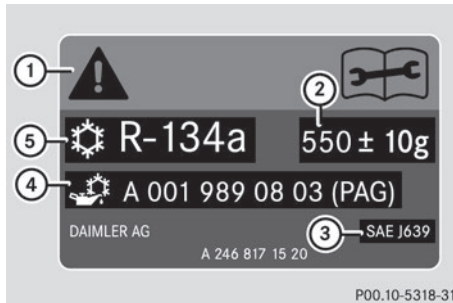

Example: refrigerant instruction label

- ① Warning symbol
- ② Refrigerant filling capacity
- ③ Applicable SAE standards
- ④ PAG oil part number
- ⑤ Type of refrigerant

Warning symbols ① indicate:

- possible dangers
- having service work carried out at a qualified specialist workshop

Filling capacities

Missing values were not available at time of going to print.

All models	Capacity
Refrigerant	28.2 oz (800 g)
PAG oil	

Brake fluid

WARNING

The brake fluid constantly absorbs moisture from the air. This lowers the boiling point of the brake fluid. If the boiling point of the brake fluid is too low, vapor pockets may form in the brake system when the brakes are applied hard. This would impair braking efficiency. There is a risk of an accident.

You should have the brake fluid renewed at the specified intervals.

When handling brake fluid, observe the important safety notes on service products (> page 263).

The brake fluid change intervals can be found in the Maintenance Booklet.

Only use brake fluid approved by Mercedes-Benz according to MB Approval 331.0.

Information about approved brake fluid can be obtained at any qualified specialist workshop or on the Internet at <http://bevo.mercedes-benz.com>.

- i** Have the brake fluid regularly replaced at a qualified specialist workshop and the replacement confirmed in the Maintenance Booklet.

Coolant

Important safety notes

- !** Only add coolant that has been premixed with the desired antifreeze protection. You could otherwise damage the engine.

Further information on coolants can be found in the Mercedes-Benz Specifications for Service Products, MB Specifications for Service Products 310.1, e.g. on the Internet at <http://bevo.mercedes-benz.com>. Or contact a qualified specialist workshop.

- !** Always use a suitable coolant mixture, even in countries where high temperatures prevail.

Otherwise, the cooling system is not sufficiently protected from corrosion and overheating.

- i** Have the coolant regularly replaced at a qualified specialist workshop and the replacement confirmed in the Maintenance Booklet.

Comply with the important safety precautions for service products when handling coolant (▷ page 263).

The coolant is a mixture of water and antifreeze/corrosion inhibitor. It performs the following tasks:

- corrosion protection
- antifreeze protection
- raising the boiling point

If the coolant has antifreeze protection down to -35 °F (-37 °C), the boiling point of the coolant during operation is approximately 266 °F (130 °C).

The antifreeze/corrosion inhibitor concentration in the engine cooling system should:

- be at least 50%. This will protect the engine cooling system against freezing down to approximately -35 °F (-37 °C).
- not exceed 55% (antifreeze protection down to -49 °F [-45 °C]). Otherwise, heat will not be dissipated as effectively.

If the vehicle has lost coolant, add equal amounts of water and antifreeze/corrosion inhibitor. Mercedes-Benz recommends an antifreeze/corrosion inhibitor concentrate in accordance with MB Specifications for Service Products 310.1.

The coolant is checked with every maintenance interval at a qualified specialist workshop.

- i** When the vehicle is first delivered, it is filled with a coolant mixture that ensures adequate antifreeze and corrosion protection.

Windshield/headlamp cleaning system

Important safety notes

- !** Only use washer fluid that is suitable for plastic lamp lenses, e.g. MB SummerFit or MB WinterFit. Unsuitable washer fluid

could damage the plastic lenses of the headlamps.

- !** Do not add distilled or de-ionized water to the washer fluid container. Otherwise, the level sensor may be damaged.

- !** Only MB SummerFit and MB WinterFit washer fluid should be mixed together. The spray nozzles may otherwise become blocked.

At temperatures above freezing:

- ▶ Fill the washer fluid reservoir with a mixture of water and windshield washer fluid, e.g. MB SummerFit.

Add 1 part MB SummerFit to 100 parts water.

At temperatures below freezing:

- ▶ Fill the washer fluid reservoir with a mixture of water and windshield washer fluid, e.g. MB WinterFit.

Adapt the mixing ratio to the outside temperature.

- Down to 14 °F (-10 °C): mix 1 part MB WinterFit to 2 parts water.
- Down to -4 °F (-20 °C): mix 1 part MB WinterFit to 1 part water.
- Down to -20.2 °F (-29 °C): mix 2 parts MB WinterFit to 1 part water.

- i** Add windshield washer fluid, e.g. MB SummerFit or MB WinterFit, to the washer fluid all year round.

Filling capacities

Model	Capacity
All models	7.4 US qt (7.0 l)

Vehicle data

Dimensions and weights

The data stated here specifically refers to a vehicle with standard equipment. Consult an

authorized Mercedes-Benz Center data for all vehicle variants and trim levels.

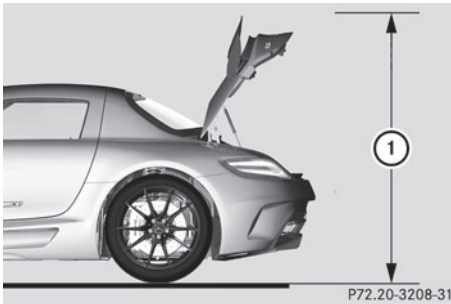

① Opening height	67.6 in (1717 mm)
------------------	-------------------

Wheelbase	105.5 in (2680 mm)
Front track	67.0 in (1702 mm)
Rear track	66.0 in (1676 mm)
Ground clearance	3.4 in (86 mm)
Turning radius	40.4 ft (12.3 m)
Maximum trunk load	137 lb (62 kg)



① Range of movement exceeding vehicle width	13.3 in (339 mm)
② Height when opened (exterior mirrors folded in)	73.8 in (1874 mm) (exterior mirrors folded in)
② Height when opened (exterior mirrors folded out)	76.7 in (1947 mm) (exterior mirrors folded out)

Vehicle length	182.9 in (4646 mm)
Vehicle width including exterior mirrors	81.7 in (2075 mm)
Vehicle height	49.8 in (1264 mm)

Publication details

Internet

Further information about Mercedes-Benz vehicles and about Daimler AG can be found on the following websites:

Editorial office

©Daimler AG: Not to be reprinted, translated or otherwise reproduced, in whole or in part, without written permission from Daimler AG.

Vehicle manufacturer

Daimler AG
Mercedesstraße 137
70327 Stuttgart
Germany



1975842581

Order no. 6515 4911 13 Part no. 197 584 25 81 Edition A2 2014 BS