



# B-Class

Operator's Manual



Order no. 65151753 13 Part no. 2465844000 Edition B 2015

B-Class Operator's Manual



Mercedes-Benz

## Symbols

Registered trademarks:

- Bluetooth® is a registered trademark of Bluetooth SIG Inc.
- DTS is a registered trademark of DTS, Inc.
- Dolby and MLP are registered trademarks of DOLBY Laboratories.
- BabySmart™, ESP® and PRE-SAFE® are registered trademarks of Daimler AG.
- HomeLink® is a registered trademark of Johnson Controls.
- iPod® and iTunes® are registered trademarks of Apple Inc.
- Logic7® is a registered trademark of Harman International Industries.
- Microsoft® and Windows media® are registered trademarks of Microsoft Corporation.
- SIRIUS is a registered trademark of Sirius XM Radio Inc.
- HD Radio is a registered trademark of iBiquity Digital Corporation.
- Gracenote® is a registered trademark of Gracenote, Inc.
- ZAGATSurvey® and related brands are registered trademarks of ZagatSurvey, LLC.

In this Operator's Manual you will find the following symbols:

### **WARNING**

Warning notes make you aware of dangers which could pose a threat to your health or life, or to the health and life of others.

### **Environmental note**

Environmental notes provide you with information on environmentally aware actions or disposal.

 Notes on material damage alert you to dangers that could lead to damage to your vehicle.

 Practical tips or further information that could be helpful to you.

▶ This symbol indicates an instruction that must be followed.

▶ Several of these symbols in succession indicate an instruction with several steps.

(▷ This symbol tells you where you can find more information about a topic.

▷▷ This symbol indicates a warning or an instruction that is continued on the next page.

**Dis-**  
**play** This text indicates a message in the multifunction/COMAND/Audio display.

Parts of the software in the vehicle are protected by copyright © 2005  
The FreeType Project  
<http://www.freetype.org>. All rights reserved.

## Publication details

### Internet

Further information about Mercedes-Benz vehicles and about Daimler AG can be found on the following websites:

<http://www.mercedes-benz.ca>

### Editorial office

©Daimler AG: not to be reprinted, translated or otherwise reproduced, in whole or in part, without written permission from Daimler AG.

### Vehicle manufacturer

Daimler AG  
Mercedesstraße 137  
70327 Stuttgart  
Germany

## Welcome to the world of Mercedes-Benz

We urge you to read this Operator's Manual carefully and familiarize yourself with the vehicle before driving. For your own safety and a longer vehicle life, follow the instructions and warning notices in this manual.

Ignoring them could result in damage to the vehicle or personal injury to you or others.

Vehicle damage caused by failure to follow instructions is not covered by the Mercedes-Benz Limited Warranty.

The equipment or product designation of your vehicle may vary depending on:

- model
- order
- country specification
- availability

Mercedes-Benz therefore reserves the right to introduce changes in the following areas:

- design
- equipment
- technical features

The equipment in your vehicle may therefore differ from that shown in the descriptions and illustrations.

The following are integral components of the vehicle:

- Operator's Manual
- Maintenance Booklet
- Equipment-dependent supplements

Keep these documents in the vehicle at all times. If you sell the vehicle, always pass all documents on to the new owner.

You can also use the B-Class Guide smartphone app:



Apple® iOS



Android™

Please note that the Mercedes-Benz Guides App may not yet be available in your country.

The technical documentation team at Daimler AG wishes you safe and pleasant motoring.

Mercedes-Benz USA, LLC  
Mercedes-Benz Canada, Inc.  
A Daimler Company

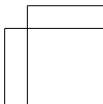
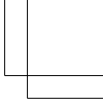
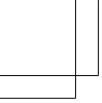

<b>Index</b> .....	<b>4</b>	<b>At a glance</b> .....	<b>27</b>
<b>Introduction</b> .....	<b>20</b>	<b>Safety</b> .....	<b>37</b>
		<b>Opening and closing</b> .....	<b>69</b>
		<b>Seats, steering wheel and mirrors</b> ....	<b>91</b>
		<b>Lights and windshield wipers</b> .....	<b>103</b>
		<b>Climate control</b> .....	<b>119</b>
		<b>Driving and parking</b> .....	<b>133</b>
		<b>On-board computer and displays</b> ....	<b>191</b>
		<b>Stowage and features</b> .....	<b>247</b>
		<b>Maintenance and care</b> .....	<b>269</b>
		<b>Roadside Assistance</b> .....	<b>283</b>
		<b>Wheels and tires</b> .....	<b>301</b>
		<b>Technical data</b> .....	<b>333</b>

**1, 2, 3 ...****4ETS (Electronic Traction System)**

see ETS/4ETS (Electronic Traction System)

**4MATIC**

Display message ..... 232

**4MATIC (permanent four-wheel**

**drive)** ..... 172

**12 V socket**

see Sockets

**A****ABS (Anti-lock Braking System)**

Display message ..... 208

Function/notes ..... 61

Important safety notes ..... 61

Warning lamp ..... 238

**Accident**

Automatic measures after an accident ..... 54

**Activating/deactivating cooling**

**with air dehumidification** ..... 124

**Active Parking Assist**

Detecting parking spaces ..... 176

Display message ..... 227

Exiting a parking space ..... 178

Function/notes ..... 175

Important safety notes ..... 175

Parking ..... 177

**ADAPTIVE BRAKE** ..... 66

**Adaptive Brake Assist**

Function/notes ..... 63

**Adaptive Highbeam Assist**

Function/notes ..... 107

Switching on/off ..... 108

**Additional speedometer** ..... 204

**Additives (engine oil)** ..... 338

**Air bag**

Occupant Classification System (OCS) ..... 47

**Air bags**

Deployment ..... 52

Display message ..... 218

Front air bag (driver, front passenger) ..... 45

Important safety notes ..... 44

Introduction ..... 44

Knee bag ..... 46

PASSENGER AIR BAG indicator lamps ..... 39

Side impact air bag ..... 46

Window curtain air bag ..... 46

**Air vents**

Important safety notes ..... 131

Rear ..... 132

Setting the center air vents ..... 131

Setting the side air vents ..... 131

**Air-conditioning system**

see Climate control

**Alarm**

ATA (Anti-Theft Alarm system) ..... 67

Switching off (ATA) ..... 67

Switching the function on/off (ATA) ..... 67

**Animals in the vehicle** ..... 60

**Ashtray** ..... 261

**Assistance display (on-board computer)** ..... 202

**Assistance menu (on-board computer)** ..... 201

**ASSYST PLUS**

Displaying a service message ..... 275

Driving abroad ..... 275

Hiding a service message ..... 274

Information about Service ..... 275

Resetting the service interval display ..... 275

Service message ..... 274

Special service requirements ..... 275

**ATA (Anti-Theft Alarm system)**

Activating/deactivating ..... 67

Function ..... 67

Switching off the alarm ..... 67

**ATTENTION ASSIST**

Activating/deactivating ..... 203

Display message ..... 225

Function/notes ..... 183

**Audio menu (on-board computer)** .... 199

**Audio system**

see separate operating instructions

**Authorized Mercedes-Benz Center**

see Qualified specialist workshop

- AUTO lights**  
 Display message ..... 222  
 see Lights
- Automatic car wash (care)** ..... 276
- Automatic engine start (ECO start/stop function)** ..... 139
- Automatic engine switch-off (ECO start/stop function)** ..... 139
- Automatic headlamp mode** ..... 104
- Automatic transmission**  
 Accelerator pedal position ..... 146  
 Automatic drive program ..... 147  
 Changing gear ..... 146  
 DIRECT SELECT lever ..... 142  
 Drive program display ..... 143  
 Driving tips ..... 146  
 Emergency running mode ..... 150  
 Engaging drive position ..... 145  
 Engaging neutral ..... 144  
 Engaging park position automatically ..... 143  
 Engaging reverse gear ..... 144  
 Engaging the park position ..... 143  
 Holding the vehicle stationary on uphill gradients ..... 146  
 Kickdown ..... 146  
 Manual drive program ..... 148  
 Overview ..... 142  
 Problem (malfunction) ..... 150  
 Program selector button ..... 147  
 Pulling away ..... 138  
 Starting the engine ..... 137  
 Steering wheel paddle shifters ..... 147  
 Transmission position display ..... 143  
 Transmission positions ..... 145
- Automatic transmission emergency mode** ..... 150
- B**
- Backup lamp**  
 Changing bulbs ..... 112  
 Display message ..... 221
- Bag hook** ..... 255
- BAS (Brake Assist System)** ..... 61
- Battery (SmartKey)**  
 Checking ..... 73  
 Important safety notes ..... 73  
 Replacing ..... 74
- Battery (vehicle)**  
 Charging ..... 291  
 Display message ..... 223  
 Important safety notes ..... 289  
 Jump starting ..... 293
- Blind Spot Assist**  
 Activating/deactivating (on-board computer) ..... 203  
 Display message ..... 226  
 Notes/function ..... 185
- Brake fluid**  
 Display message ..... 214  
 Notes ..... 338
- Brake force distribution**  
 see EBD (electronic brake force distribution)
- Brake lamps**  
 Display message ..... 220
- Brakes**  
 ABS ..... 61  
 Adaptive Brake Assist ..... 63  
 BAS ..... 61  
 Brake fluid (notes) ..... 338  
 Display message ..... 208  
 EBD ..... 66  
 Hill start assist ..... 138  
 HOLD function ..... 170  
 Important safety notes ..... 157  
 Maintenance ..... 158  
 Parking brake ..... 153  
 Riding tips ..... 157  
 Warning lamp ..... 237
- Breakdown**  
 see Flat tire
- Brightness control (instrument cluster lighting)** ..... 29
- Buttons on the steering wheel** ..... 193
- C**
- Calling up a malfunction**  
 see Display messages
- Care**  
 Car wash ..... 276  
 Carpets ..... 282  
 Display ..... 280  
 Exhaust pipe ..... 280

- Exterior lights ..... 279
- Gear or selector lever ..... 280
- Interior ..... 280
- Matte finish ..... 277
- Notes ..... 275
- Paint ..... 277
- Plastic trim ..... 280
- Power washer ..... 277
- Rear view camera ..... 279
- Roof lining ..... 282
- Seat belt ..... 282
- Seat cover ..... 281
- Sensors ..... 279
- Steering wheel ..... 280
- Trim pieces ..... 281
- Washing by hand ..... 276
- Wheels ..... 278
- Windows ..... 278
- Wiper blades ..... 278
- Wooden trim ..... 281
- Cargo compartment cover**
- Important safety notes ..... 256
- Installing/removing ..... 256
- Notes/how to use ..... 256
- Cargo compartment enlargement ...** 252
- Cargo compartment floor**
- Height adjustment ..... 258
- Important safety notes ..... 257
- Opening/closing ..... 258
- Stowage well (under) ..... 257
- Cargo net**
- Attaching ..... 257
- Important safety information ..... 256
- Cargo tie down rings** ..... 255
- CD player/CD changer (on-board computer)** ..... 199
- Center console**
- Lower section ..... 33
- Upper section ..... 32
- Central locking**
- Automatic locking (on-board computer) ..... 205
- Locking/unlocking (SmartKey) ..... 70
- Changing bulbs**
- High-beam headlamps ..... 111
- License plate lighting ..... 113
- Low-beam headlamps ..... 111
- Rear fog lamp ..... 112
- Reversing lamps ..... 112
- Turn signals (front) ..... 112
- Child**
- Restraint system ..... 55
- Child seat**
- Forward-facing restraint system ..... 58
- LATCH-type (ISOFIX) child seat anchors ..... 56
- On the front-passenger seat ..... 58
- Rearward-facing restraint system .... 58
- Top Tether ..... 57
- Child-proof locks**
- Important safety notes ..... 59
- Rear doors ..... 59
- Children**
- Special seat belt retractor ..... 55
- Cigarette lighter** ..... 262
- Cleaning**
- Mirror turn signal ..... 279
- Climate control**
- Air-conditioning system ..... 121
- Automatic climate control (dual-zone) ..... 123
- Controlling automatically ..... 126
- Cooling with air dehumidification .. 124
- Defrosting the windows ..... 128
- Defrosting the windshield ..... 128
- General notes ..... 120
- Indicator lamp ..... 126
- Information about using automatic climate control ..... 123
- Notes on using the air-conditioning system ..... 121
- Overview of systems ..... 120
- Problem with the rear window defroster ..... 130
- Problems with cooling with air dehumidification ..... 126
- Refrigerant ..... 340
- Refrigerant filling capacity ..... 340
- Setting the air distribution ..... 127
- Setting the air vents ..... 131
- Setting the airflow ..... 127
- Setting the temperature ..... 126
- Switching air-recirculation mode on/off ..... 130
- Switching on/off ..... 124
- Switching residual heat on/off ..... 130



- Switching the rear window defroster on/off ..... 129
  - Switching the ZONE function on/off ..... 127
  - Cockpit**
    - Overview ..... 28
  - COLLISION PREVENTION ASSIST PLUS**
    - Activating/deactivating ..... 203
    - Display message ..... 214
    - Operation/notes ..... 62
  - COMAND display**
    - Cleaning ..... 280
  - Combination switch** ..... 106
  - Compass**
    - Calibrating ..... 267
    - Calling up ..... 267
    - Magnetic field zone maps ..... 268
    - Setting ..... 267
  - Consumption statistics (on-board computer)** ..... 196
  - Convenience closing feature** ..... 83
  - Convenience opening feature** ..... 82
  - Coolant (engine)**
    - Checking the level ..... 273
    - Display message ..... 222
    - Filling capacity ..... 339
    - Important safety notes ..... 339
    - Temperature gauge ..... 192
    - Warning lamp ..... 244
  - Cooling**
    - see Climate control
  - Copyright** ..... 26
  - Crash-responsive emergency lighting** ..... 109
  - Cruise control**
    - Activation conditions ..... 161
    - Cruise control lever ..... 161
    - Deactivating ..... 162
    - Display message ..... 228
    - Driving system ..... 161
    - Function/notes ..... 161
    - Important safety notes ..... 161
    - Setting a speed ..... 162
    - Storing and maintaining current speed ..... 162
  - Cup holder**
    - Center console ..... 260
    - Important safety notes ..... 259
    - Rear compartment ..... 260
  - Customer Assistance Center (CAC)** ..... 24
  - Customer Relations Department** ..... 24
- ## D
- Data**
    - see Technical data
  - Daytime running lamps**
    - Display message ..... 221
    - Function/notes ..... 104
    - Switching on/off (on-board computer) ..... 205
  - Declarations of conformity** ..... 23
  - Diagnostics connection** ..... 23
  - Digital speedometer** ..... 197
  - DIRECT SELECT lever**
    - Automatic transmission ..... 142
  - Display messages**
    - ASSYST PLUS ..... 274
    - Calling up (on-board computer) ..... 207
    - Driving systems ..... 225
    - Engine ..... 222
    - General notes ..... 207
    - Hiding (on-board computer) ..... 207
    - Lights ..... 219
    - Safety systems ..... 208
    - SmartKey ..... 234
    - Tires ..... 229
    - Vehicle ..... 230
  - Distance display (on-board computer)** ..... 202
  - Distance recorder** ..... 196
  - Distance warning (warning lamp)** .... 246
  - Distance warning function**
    - Function/notes ..... 62
    - Warning lamp ..... 246
  - DISTRONIC PLUS**
    - Activation conditions ..... 164
    - Cruise control lever ..... 164
    - Deactivating ..... 167
    - Display message ..... 227
    - Displays in the multifunction display ..... 168

- Driving tips ..... 169
- Function/notes ..... 163
- Important safety notes ..... 163
- Setting the specified minimum distance ..... 167
- Doors**
- Automatic locking (on-board computer) ..... 205
- Automatic locking (switch) ..... 78
- Central locking/unlocking (SmartKey) ..... 70
- Control panel ..... 34
- Display message ..... 232
- Emergency locking ..... 79
- Emergency unlocking ..... 78
- Important safety notes ..... 77
- Opening (from inside) ..... 77
- Drinking and driving** ..... 156
- Drive program**
- Automatic ..... 147
- Display (DIRECT SELECT lever) ..... 143
- Manual ..... 148
- Driver's door**
- see Doors
- Driving abroad**
- Mercedes-Benz Service ..... 275
- Driving on flooded roads** ..... 160
- Driving safety systems**
- ABS (Anti-lock Braking System) ..... 61
- ADAPTIVE BRAKE ..... 66
- Adaptive Brake Assist ..... 63
- BAS (Brake Assist System) ..... 61
- COLLISION PREVENTION ASSIST PLUS ..... 62
- Distance warning function ..... 62
- EBD (electronic brake force distribution) ..... 66
- ESP® (Electronic Stability Program) ..... 64
- ETS/4ETS (Electronic Traction System) ..... 64
- Important safety information ..... 60
- Overview ..... 60
- STEER CONTROL ..... 66
- Driving systems**
- Active Parking Assist ..... 175
- ATTENTION ASSIST ..... 183
- Blind Spot Assist ..... 185
- Cruise control ..... 161
- Display message ..... 225
- DISTRONIC PLUS ..... 163
- HOLD function ..... 170
- Lane Keeping Assist ..... 187
- Lane Tracking package ..... 185
- PARKTRONIC ..... 172
- Rear view camera ..... 180
- Driving tips**
- Automatic transmission ..... 146
- Brakes ..... 157
- Break-in period ..... 134
- Checking brake lining thickness .... 159
- DISTRONIC PLUS ..... 169
- Downhill gradient ..... 157
- Drinking and driving ..... 156
- Driving in winter ..... 160
- Driving on flooded roads ..... 160
- Driving on wet roads ..... 160
- Exhaust check ..... 156
- Fuel ..... 156
- General ..... 155
- Hydroplaning ..... 160
- Icy road surfaces ..... 160
- Limited braking efficiency on salted roads ..... 158
- Snow chains ..... 305
- The first 1000 miles (1500 km) .... 134
- Wet road surface ..... 158
- DVD video**
- Operating (on-board computer) .... 200

## E

### **EASY-VARIO-PLUS system**

- Cargo compartment enlargement .. 252

### **EBD (electronic brake force distribution)**

- Display message ..... 210
- Function/notes ..... 66

### **ECO display**

- Function/notes ..... 156
- On-board computer ..... 196

### **ECO start/stop function**

- Automatic engine start ..... 139
- Automatic engine switch-off ..... 139
- Deactivating/activating ..... 140
- General information ..... 139

- Important safety notes ..... 139
  - Introduction ..... 139
  - Emergency**
    - Automatic measures after an accident ..... 54
  - Emergency release**
    - Driver's door ..... 78
    - Vehicle ..... 78
  - Emergency spare wheel**
    - General notes ..... 329
    - Important safety notes ..... 329
    - Removing ..... 330
    - Technical data ..... 331
  - Emergency Tensioning Devices**
    - Activation ..... 52
  - Emergency unlocking**
    - Tailgate ..... 80
  - Emissions control**
    - Service and warranty information .... 21
  - Engine**
    - Check Engine warning lamp ..... 244
    - Display message ..... 222
    - ECO start/stop function ..... 139
    - Engine number ..... 335
    - Irregular running ..... 141
    - Jump-starting ..... 293
    - Starting problems ..... 141
    - Starting the engine with the SmartKey ..... 137
    - Starting with the Start/Stop button ..... 138
    - Switching off ..... 153
    - Tow-starting (vehicle) ..... 298
  - Engine electronics**
    - Problem (malfunction) ..... 141
  - Engine oil**
    - Adding ..... 272
    - Additives ..... 338
    - Checking the oil level ..... 271
    - Checking the oil level using the dipstick ..... 272
    - Display message ..... 224
    - Filling capacity ..... 338
    - Notes about oil grades ..... 337
    - Notes on oil level/consumption .... 271
    - Viscosity ..... 338
  - ESP® (Electronic Stability Program)**
    - Activating/deactivating (on-board computer) ..... 202
    - Characteristics ..... 65
    - Deactivating/activating (notes) ..... 65
    - Display message ..... 208
    - ETS/4ETS ..... 64
    - Function/notes ..... 64
    - General notes ..... 64
    - Important safety information ..... 64
    - Trailer stabilization ..... 66
    - Warning lamp ..... 240
  - ETS/4ETS (Electronic Traction System)** ..... 64
  - Exhaust**
    - see Exhaust pipe
  - Exhaust check** ..... 156
  - Exhaust pipe**
    - Cleaning ..... 280
  - Exterior lighting**
    - Cleaning ..... 279
    - see Lights
  - Exterior mirrors**
    - Adjusting ..... 98
    - Dipping (automatic) ..... 99
    - Folding in when locking (on-board computer) ..... 206
    - Folding in/out (automatically) ..... 99
    - Folding in/out (electrically) ..... 98
    - Out of position (troubleshooting) .... 99
    - Setting ..... 99
    - Storing settings (memory function) ..... 101
    - Storing the parking position ..... 100
  - Eyeglasses compartment** ..... 249
- F**
- Filler cap**
    - see Fuel filler flap
  - Flat tire**
    - MOExtended tires ..... 285
    - Preparing the vehicle ..... 284
    - TIREFIT kit ..... 286
    - see Emergency spare wheel
  - Floormats** ..... 268

- Fog lamps**  
Switching on/off ..... 105
- Folding table** ..... 251
- Front fog lamps**  
Display message ..... 220  
Switching on/off ..... 105
- Front-passenger seat**  
Folding the backrest forward/  
back ..... 251
- Fuel**  
Additives ..... 337  
Consumption information ..... 337  
Consumption statistics ..... 196  
Displaying the current consumption ..... 196  
Displaying the range ..... 196  
Driving tips ..... 156  
E10 ..... 336  
Fuel gauge ..... 29  
Grade (gasoline) ..... 336  
Important safety notes ..... 335  
Problem (malfunction) ..... 152  
Refueling ..... 150  
Tank content/reserve fuel ..... 336
- Fuel filler flap**  
Opening ..... 151
- Fuel level**  
Calling up the range (on-board  
computer) ..... 196
- Fuel tank**  
Capacity ..... 336  
Problem (malfunction) ..... 152
- Fuses**  
Allocation chart ..... 300  
Before changing ..... 299  
Fuse box in the engine compart-  
ment ..... 299  
Fuse box in the front-passenger  
footwell ..... 300  
Important safety notes ..... 298
- G**
- Garage door opener**  
Clearing the memory ..... 266  
General notes ..... 263  
Important safety notes ..... 264  
Opening/closing the garage door .. 266
- Programming (button in the rear-  
view mirror) ..... 264  
Synchronizing the rolling code ..... 264
- Gasoline** ..... 336
- Genuine parts** ..... 20
- Glove box** ..... 249
- H**
- Hazard warning lamps**  
Display message ..... 233  
Switching on/off ..... 107
- Head restraints**  
Adjusting ..... 94  
Adjusting (manually) ..... 95  
Adjusting (rear) ..... 95
- Headlamps**  
Fogging up ..... 108  
see Automatic headlamp mode
- Heating**  
see Climate control
- High beam flasher** ..... 107
- High-beam headlamps**  
Adaptive Highbeam Assist ..... 107  
Changing bulbs ..... 111  
Display message ..... 220  
Switching on/off ..... 106
- Hill start assist** ..... 138
- HOLD function**  
Activating ..... 171  
Deactivating ..... 171  
Display message ..... 225  
Function/notes ..... 170
- Hood**  
Closing ..... 271  
Display message ..... 232  
Important safety notes ..... 270  
Opening ..... 270
- Horn** ..... 28
- Hydroplaning** ..... 160
- I**
- Ignition lock**  
see Key positions
- Immobilizer** ..... 67

- Indicator and warning lamps**
    - COLLISION PREVENTION ASSIST PLUS ..... 246
  - Indicator lamps**
    - see Warning and indicator lamps
  - Instrument cluster**
    - Overview ..... 29
    - Settings ..... 204
    - Warning and indicator lamps ..... 30
  - Instrument cluster lighting** ..... 192
  - Interior lighting**
    - Control ..... 109
    - Emergency lighting ..... 109
    - Overview ..... 108
    - Reading lamp ..... 108
- J**
- Jack**
    - Storage location ..... 284
    - Using ..... 323
  - Jump starting (engine)** ..... 293
- K**
- Key positions**
    - Start/Stop button ..... 135
  - KEYLESS-GO**
    - Convenience closing feature ..... 83
    - Deactivation ..... 71
    - Locking ..... 71
    - Unlocking ..... 71
  - Kickdown**
    - Driving tips ..... 146
    - Manual drive program ..... 149
  - Knee bag** ..... 46
- L**
- Lamps**
    - see Warning and indicator lamps
  - Lane Keeping Assist**
    - Activating/deactivating (on-board computer) ..... 203
    - Display message ..... 226
    - Function/information ..... 187
  - Lane Tracking package** ..... 185
  - LATCH-type (ISOFIX) child seat anchors** ..... 56
  - License plate lamp**
    - Changing bulbs ..... 113
  - License plate lamp (display message)** ..... 220
  - Light function, active**
    - Display message ..... 221
  - Light sensor (display message)** ..... 222
  - Lights**
    - Adaptive Highbeam Assist ..... 107
    - Automatic headlamp mode ..... 104
    - Fog lamps ..... 105
    - Fogged up headlamps ..... 108
    - Hazard warning lamps ..... 107
    - High beam flasher ..... 107
    - High-beam headlamps ..... 106
    - Light switch ..... 104
    - Low-beam headlamps ..... 105
    - Parking lamps ..... 106
    - Rear fog lamp ..... 105
    - Setting exterior lighting ..... 104
    - Standing lamps ..... 106
    - Switching the daytime running lamps on/off (on-board computer) ..... 205
    - Turn signals ..... 106
  - LIM indicator lamp**
    - DISTRONIC PLUS ..... 164
  - Loading guidelines** ..... 248
  - Locking**
    - see Central locking
  - Locking (doors)**
    - Automatic ..... 78
    - Emergency locking ..... 79
    - From inside (central locking button) ..... 78
  - Locking centrally**
    - see Central locking
  - Locking verification signal (on-board computer)** ..... 205
  - Low-beam headlamps**
    - Changing bulbs ..... 111
    - Display message ..... 219
    - Switching on/off ..... 105
  - Lumbar support**
    - Adjusting the 4-way lumbar support ..... 95

**M**

<b>M+S tires</b> .....	304
<b>Malfunction message</b> see Display messages	
<b>Matte finish (cleaning instructions)</b> .....	277
<b>mbrace</b> Display message .....	214
<b>Mechanical key</b> Function/notes .....	72
Inserting .....	73
Locking vehicle .....	79
Removing .....	73
Unlocking the driver's door .....	78
<b>Memory card (audio)</b> .....	199
<b>Memory function</b> .....	101
<b>Message memory (on-board computer)</b> .....	207
<b>Messages</b> see Display messages	
<b>Mirror turn signal</b> Cleaning .....	279
<b>Mirrors</b> see Exterior mirrors see Rear-view mirror see Vanity mirror (in the sun visor)	
<b>Mobile phone</b> Menu (on-board computer) .....	200
<b>Modifying the programming (SmartKey)</b> .....	72
<b>MOExtended tires</b> .....	285
<b>Mounting wheels</b> Lowering the vehicle .....	325
Mounting a new wheel .....	325
Preparing the vehicle .....	322
Raising the vehicle .....	323
Removing a wheel .....	325
Securing the vehicle against rolling away .....	323
<b>MP3</b> Operation .....	199
<b>Multifunction display</b> Function/notes .....	195
Permanent display .....	205
<b>Multifunction steering wheel</b> Operating the on-board computer ..	193
Overview .....	31

**N**

<b>Navigation</b> Menu (on-board computer) .....	197
<b>Notes on breaking-in a new vehicle</b> .....	134

**O**

<b>Occupant Classification System (OCS)</b> Conditions .....	47
Faults .....	51
Operation .....	47
System self-test .....	49
<b>Occupant safety</b> Automatic measures after an accident .....	54
Children in the vehicle .....	54
Important safety notes .....	39
Introduction to the restraint system .....	38
Occupant Classification System (OCS) .....	47
PASSENGER AIR BAG indicator lamps .....	39
Pets in the vehicle .....	60
Restraint system warning lamp .....	39
Seat belt .....	40
<b>OCS</b> Conditions .....	47
Faults .....	51
Operation .....	47
System self-test .....	49
<b>Odometer</b> .....	196
<b>On-board computer</b> Assistance graphic menu .....	202
Assistance menu .....	201
Audio menu .....	199
Convenience submenu .....	206
Display messages .....	207
Displaying a service message .....	275
DISTRONIC PLUS .....	168
Factory settings .....	206
Important safety notes .....	192
Instrument cluster submenu .....	204
Lighting submenu .....	205
Menu overview .....	195

- Message memory ..... 207
  - Navigation menu ..... 197
  - Operation ..... 193
  - Service menu ..... 204
  - Settings menu ..... 204
  - Standard display ..... 196
  - Telephone menu ..... 200
  - Trip menu ..... 196
  - Vehicle submenu ..... 205
  - Video DVD operation ..... 200
  - Operating safety**
    - Declaration of conformity ..... 23
    - Important safety notes ..... 22
  - Operating system**
    - see On-board computer
  - Operator's Manual**
    - Vehicle equipment ..... 21
  - Outside temperature display** ..... 193
  - Overhead control panel** ..... 35
  - Override feature**
    - Rear side windows ..... 60
- P**
- Paint code number** ..... 334
  - Paintwork (cleaning instructions)** ... 277
  - Panic alarm** ..... 38
  - Panorama roof with power tilt/  
sliding panel**
    - Important safety notes ..... 85
    - Operating ..... 86
    - Problem (malfunction) ..... 89
  - Parking**
    - Important safety notes ..... 152
    - Parking brake ..... 153
    - Position of exterior mirror, front-  
passenger side ..... 100
    - Rear view camera ..... 180
    - see Active Parking Assist
    - see PARKTRONIC
  - Parking aid**
    - Active Parking Assist ..... 175
    - see Exterior mirrors
    - see PARKTRONIC
  - Parking brake**
    - Display message ..... 211
    - Electric parking brake ..... 153
    - Warning lamp ..... 243
  - Parking lamps**
    - Switching on/off ..... 106
  - PARKTRONIC**
    - Deactivating/activating ..... 174
    - Driving system ..... 172
    - Function/notes ..... 172
    - Important safety notes ..... 172
    - Problem (malfunction) ..... 175
    - Range of the sensors ..... 173
    - Warning display ..... 173
  - PASSENGER AIR BAG**
    - Display message ..... 218
    - Indicator lamps ..... 39
  - PASSENGER AIRBAG**
    - Problems (malfunction) ..... 218
  - Pets in the vehicle** ..... 60
  - Plastic trim (cleaning instruc-  
tions)** ..... 280
  - Power washers** ..... 277
  - Power windows**
    - see Side windows
  - Program selector button** ..... 147
  - Protection against theft**
    - ATA (Anti-Theft Alarm system) ..... 67
    - Immobilizer ..... 67
  - Protection of the environment**
    - General notes ..... 20
  - Pulling away**
    - Automatic transmission ..... 138
    - Hill start assist ..... 138
- Q**
- QR code**
    - Mercedes-Benz Guide App ..... 1
    - Rescue card ..... 25
  - Qualified specialist workshop** ..... 24
- R**
- Radio**
    - Selecting a station ..... 199
    - see separate operating instructions
  - Radio-wave reception/transmis-  
sion in the vehicle**
    - Declaration of conformity ..... 23
  - Rain closing feature (panorama  
roof with power tilt/sliding panel)** .... 87

- Reading lamp** ..... 108
- Rear compartment**  
 Setting the air vents ..... 132
- Rear fog lamp**  
 Changing bulbs ..... 112  
 Display message ..... 220  
 Switching on/off ..... 105
- Rear lamps**  
 see Lights
- Rear seat**  
 Adjusting the angle of the backrests ..... 254  
 Folding the backrest forwards/back (vehicles with the EASY-VARIO-PLUS system) ..... 253  
 Folding the backrest forwards/back (vehicles without the EASY-VARIO-PLUS system) ..... 252  
 Fore-and-aft adjustment ..... 254
- Rear view camera**  
 Cleaning instructions ..... 279  
 Displays in the Audio display ..... 180  
 Displays in the COMAND display ... 180  
 Function/notes ..... 180  
 Switching on/off ..... 180
- Rear window defroster**  
 Problem (malfunction) ..... 130  
 Switching on/off ..... 129
- Rear window wiper**  
 Replacing the wiper blade ..... 116  
 Switching on/off ..... 114
- Rear-view mirror**  
 Anti-glare (manual) ..... 98  
 Dipping (automatic) ..... 99
- Recuperation display** ..... 196
- Refrigerant (air-conditioning system)**  
 Important safety notes ..... 340
- Refueling**  
 Fuel gauge ..... 29  
 Important safety notes ..... 150  
 Refueling process ..... 151  
 see Fuel
- Remote control**  
 Garage door opener ..... 263  
 Programming (garage door opener) ..... 264
- Replacing bulbs**  
 Important safety notes ..... 109  
 Overview of bulb types ..... 110  
 Removing/replacing the cover (front wheel arch) ..... 111
- Rescue card** ..... 25
- Reserve (fuel tank)**  
 see Fuel
- Reserve fuel**  
 Display message ..... 225  
 Warning lamp ..... 244  
 see Fuel
- Residual heat (climate control)** ..... 130
- Restraint system**  
 Display message ..... 215  
 Introduction ..... 38  
 Warning lamp ..... 243  
 Warning lamp (function) ..... 39
- Reversing feature**  
 Panorama sliding sunroof ..... 86  
 Roller sunblind ..... 87  
 Side windows ..... 81
- Roadside Assistance (breakdown)** .... 22
- Roller sunblind**  
 Opening/closing ..... 88  
 Panorama roof with power tilt/sliding panel ..... 87
- Roof carrier** ..... 259
- Roof lining and carpets (cleaning guidelines)** ..... 282
- Roof load (maximum)** ..... 341

## S

### Safety

- Children in the vehicle ..... 54

### Seat belts

- Adjusting the height ..... 42  
 center rear-compartment seat ..... 43  
 Cleaning ..... 282  
 Correct usage ..... 41  
 Fastening ..... 42  
 Important safety guidelines ..... 40  
 Introduction ..... 40  
 Releasing ..... 43  
 Warning lamp ..... 235  
 Warning lamp (function) ..... 43



- Seats**
- Adjusting (electrically) ..... 94
  - Adjusting (manually) ..... 94
  - Adjusting the 4-way lumbar support ..... 95
  - Adjusting the head restraint ..... 94
  - Cleaning the cover ..... 281
  - Correct driver's seat position ..... 92
  - Folding the backrest (rear compartment) forwards/back (vehicles with the EASY-VARIO-PLUS system) ..... 253
  - Folding the backrest (rear compartment) forwards/back (vehicles without the EASY-VARIO-PLUS system) ..... 252
  - Important safety notes ..... 93
  - Seat heating problem ..... 97
  - Storing settings (memory function) ..... 101
  - Switching seat heating on/off ..... 96
- Securing cargo** ..... 255
- Selector lever**
- Cleaning ..... 280
- Sensors (cleaning instructions)** ..... 279
- Service menu (on-board computer)** ..... 204
- Service message**  
see ASSYST PLUS
- Service products**
- Brake fluid ..... 338
  - Coolant (engine) ..... 339
  - Engine oil ..... 337
  - Fuel ..... 335
  - Important safety notes ..... 335
  - Refrigerant (air-conditioning system) ..... 340
  - Washer fluid ..... 339
- Setting the air distribution** ..... 127
- Setting the airflow** ..... 127
- Settings**
- Factory (on-board computer) ..... 206
  - On-board computer ..... 204
- Side impact air bag** ..... 46
- Side marker lamp (display message)** ..... 221
- Side windows**
- Cleaning ..... 278
  - Convenience closing feature ..... 83
  - Convenience opening feature ..... 82
  - Important safety information ..... 81
  - Opening/closing ..... 82
  - Problem (malfunction) ..... 85
  - Resetting ..... 84
  - Reversing feature ..... 81
- Sliding sunroof**  
see Panorama roof with power tilt/sliding panel
- SmartKey**
- Changing the battery ..... 74
  - Changing the programming ..... 72
  - Checking the battery ..... 73
  - Convenience closing feature ..... 83
  - Convenience opening feature ..... 82
  - Display message ..... 234
  - Door central locking/unlocking ..... 70
  - Important safety notes ..... 70
  - KEYLESS-GO start function ..... 72
  - Loss ..... 75
  - Mechanical key ..... 72
  - Positions (ignition lock) ..... 135
  - Problem (malfunction) ..... 75
  - Starting the engine ..... 137
- SmartKey positions (ignition lock)** .. 135
- Snow chains** ..... 305
- Sockets**
- Center console ..... 263
  - General notes ..... 262
  - Luggage compartment ..... 263
  - Rear compartment ..... 263
- Special seat belt retractor** ..... 55
- Specialist workshop** ..... 24
- Speed, controlling**  
see Cruise control
- Speedometer**
- Activating/deactivating the additional speedometer ..... 204
  - Digital ..... 197
  - In the Instrument cluster ..... 29
  - Segments ..... 193
  - Selecting the unit of measurement ..... 204
- Standing lamps**
- Display message ..... 221

- Switching on/off ..... 106
  - Start/Stop button**
    - Removing ..... 136
    - Starting the engine ..... 138
  - Start/stop function**
    - see ECO start/stop function
  - Starting (engine)** ..... 137
  - Status overview (on-board computer)** ..... 201
  - STEER CONTROL** ..... 66
  - Steering (display message)** ..... 233
  - Steering assistant STEER CONTROL**
    - see STEER CONTROL
  - Steering wheel**
    - Adjusting (manually) ..... 97
    - Button overview ..... 31
    - Buttons (on-board computer) ..... 193
    - Cleaning ..... 280
    - Important safety notes ..... 97
    - Paddle shifters ..... 147
  - Steering wheel paddle shifters** ..... 147
  - Stowage compartments**
    - Armrest (front) ..... 250
    - Armrest (under) ..... 250
    - Center console ..... 249
    - Center console (rear) ..... 250
    - Cup holders ..... 259
    - Eyeglasses compartment ..... 249
    - Glove box ..... 249
    - Important safety information ..... 249
    - Map pockets ..... 251
    - Stowage net ..... 251
    - Under driver's seat/front-passenger seat ..... 250
  - Stowage net** ..... 251
  - Summer tires** ..... 304
  - Sun visor** ..... 261
  - Switching air-recirculation mode on/off** ..... 130
- T**
- Tachometer** ..... 193
  - Tail lamps**
    - Display message ..... 220
    - see Lights
  - Tailgate**
    - Display message ..... 232
    - Emergency unlocking ..... 80
    - Important safety notes ..... 79
    - Opening dimensions ..... 341
    - Opening/closing (from outside) ..... 80
  - Tank content**
    - Fuel gauge ..... 29
  - Technical data**
    - Capacities ..... 335
    - Emergency spare wheel ..... 331
    - Information ..... 334
    - Tires/wheels ..... 326
    - Vehicle data ..... 341
  - Telephone**
    - Accepting a call (multifunction steering wheel) ..... 200
    - Display message ..... 233
    - Introduction ..... 200
    - Menu (on-board computer) ..... 200
    - Number from the phone book ..... 200
    - Redialing ..... 201
    - Rejecting/ending a call ..... 200
  - Temperature**
    - Coolant ..... 192
    - Outside temperature ..... 193
    - Setting (climate control) ..... 126
  - Through-loading feature** ..... 252
  - Tire pressure**
    - Checking manually ..... 309
    - Display message ..... 229
    - Maximum ..... 308
    - Not reached (TIREFIT) ..... 288
    - Notes ..... 307
    - Reached (TIREFIT) ..... 288
    - Recommended ..... 305
  - Tire pressure loss warning system**
    - General notes ..... 309
    - Important safety notes ..... 309
    - Restarting ..... 309
  - TIREFIT kit** ..... 286
  - Tires**
    - Aspect ratio (definition) ..... 321
    - Average weight of the vehicle occupants (definition) ..... 320
    - Bar (definition) ..... 319
    - Changing a wheel ..... 322
    - Characteristics ..... 319

Checking .....	303	Summer tires .....	304
Curb weight (definition) .....	321	Temperature .....	315
Definition of rotation .....	319	TIN (Tire Identification Number) (definition) .....	321
Direction of rotation .....	322	Tire bead (definition) .....	321
Display message .....	229	Tire pressure (definition) .....	321
Distribution of the vehicle occu- pants (definition) .....	322	Tire pressures (recommended) .....	320
DOT (Department of Transporta- tion) (definition) .....	320	Tire size (data) .....	326
DOT, Tire Identification Number (TIN) .....	319	Tire size designation, load-bearing capacity, speed rating .....	316
GAWR (Gross Axle Weight Rating) (definition) .....	320	Tire tread .....	303
General notes .....	326	Tire tread (definition) .....	321
GVW (Gross Vehicle Weight) (def- inition) .....	320	Total load limit (definition) .....	322
GVWR (Gross Vehicle Weight Rat- ing) (definition) .....	320	Traction .....	315
Important safety notes .....	302	Traction (definition) .....	321
Increased vehicle weight due to optional equipment (definition) .....	320	Tread wear .....	315
Information on driving .....	302	Uniform Tire Quality Grading Standards .....	314
Kilopascal (kPa) (definition) .....	320	Uniform Tire Quality Grading Standards (definition) .....	320
Labeling (overview) .....	316	Wear indicator (definition) .....	321
Load bearing index (definition) .....	321	Wheel and tire combination .....	328
Load index .....	318	Wheel rim (definition) .....	320
Load index (definition) .....	320	see Flat tire	
M+S tires .....	304	<b>Top Tether</b> .....	57
Maximum load on a tire (defini- tion) .....	321	<b>Tow-starting</b>	
Maximum loaded vehicle weight (definition) .....	320	Emergency engine starting .....	298
Maximum permissible tire pres- sure (definition) .....	321	Important safety notes .....	295
Maximum tire load .....	318	Installing the towing eye .....	296
Maximum tire load (definition) .....	321	Removing the towing eye .....	297
MOExtended tires .....	304	<b>Towing a trailer</b>	
Optional equipment weight (defi- nition) .....	321	ESP® (Electronic Stability Pro- gram) .....	66
PSI (pounds per square inch) (def- inition) .....	321	<b>Towing away</b>	
Replacing .....	322	Important safety guidelines .....	295
Service life .....	304	Installing the towing eye .....	296
Sidewall (definition) .....	321	Notes for 4MATIC vehicles .....	298
Speed rating (definition) .....	320	Removing the towing eye .....	297
Storing .....	322	Transporting the vehicle .....	298
Structure and characteristics (definition) .....	319	With both axles on the ground .....	297
		With front axle raised .....	297
		<b>Towing eye</b> .....	284
		<b>Transmission</b>	
		see Automatic transmission	
		<b>Transmission position display (DIRECT SELECT lever)</b> .....	143
		<b>Transporting the vehicle</b> .....	298

- Trim pieces (cleaning instructions)** ..... 281
  - Trip computer (on-board computer)** ..... 196
  - Trip odometer**
    - Calling up ..... 196
    - Resetting (on-board computer) ..... 197
  - Trunk load (maximum)** ..... 341
  - Turn signals**
    - Changing bulbs (front) ..... 112
    - Display message ..... 219
    - Switching on/off ..... 106
  - Type identification plate**  
see Vehicle identification plate
- U**
- Unlocking**
    - Emergency unlocking ..... 78
    - From inside the vehicle (central unlocking button) ..... 78
- V**
- Vanity mirror (in the sun visor)** ..... 261
  - Vehicle**
    - Correct use ..... 24
    - Data acquisition ..... 25
    - Display message ..... 230
    - Equipment ..... 21
    - Individual settings ..... 204
    - Limited Warranty ..... 25
    - Loading ..... 310
    - Locking (in an emergency) ..... 79
    - Locking (SmartKey) ..... 70
    - Lowering ..... 325
    - Maintenance ..... 21
    - Parking for a long period ..... 155
    - Pulling away ..... 138
    - Raising ..... 323
    - Reporting problems ..... 24
    - Securing from rolling away ..... 323
    - Transporting ..... 298
    - Unlocking (in an emergency) ..... 78
    - Unlocking (SmartKey) ..... 70
    - Vehicle data ..... 341
  - Vehicle data**
    - Roof load (maximum) ..... 341
    - Trunk load (maximum) ..... 341
  - Vehicle dimensions** ..... 341
  - Vehicle emergency locking** ..... 79
  - Vehicle identification number**  
see VIN
  - Vehicle identification plate** ..... 334
  - Vehicle tool kit** ..... 284
  - Ventilation**
    - Setting the vents ..... 131
  - Video**
    - Operating the DVD ..... 200
  - VIN** ..... 334
- W**
- Warning and indicator lamps**
    - ABS ..... 238
    - Brakes ..... 237
    - Check Engine ..... 244
    - Coolant ..... 244
    - Distance warning ..... 246
    - ESP® ..... 240
    - ESP® OFF ..... 241
    - LIM (DISTRONIC PLUS) ..... 164
    - Overview ..... 30
    - PASSENGER AIR BAG ..... 39
    - Reserve fuel ..... 244
    - Restraint system ..... 243
    - Seat belt ..... 235
  - Warranty** ..... 21
  - Washer fluid**
    - Display message ..... 233
  - Wheel and tire combination**  
see Tires
  - Wheel bolt tightening torque** ..... 325
  - Wheel chock** ..... 323
  - Wheels**
    - Changing a wheel ..... 322
    - Checking ..... 303
    - Cleaning ..... 278
    - Emergency spare wheel ..... 329
    - General notes ..... 326
    - Important safety notes ..... 302
    - Information on driving ..... 302
    - Interchanging/changing ..... 322
    - Mounting a new wheel ..... 325
    - Removing a wheel ..... 325
    - Storing ..... 322

Tightening torque .....	325
Wheel size/tire size .....	326
<b>Window curtain air bag</b>	
Display message .....	216
Operation .....	46
<b>Windows</b>	
see Side windows	
<b>Windshield</b>	
Defrosting .....	128
<b>Windshield washer system</b>	
Adding washer fluid .....	273
Notes .....	339
<b>Windshield wipers</b>	
Display message .....	233
Problem (malfunction) .....	117
Rear window wiper .....	114
Replacing the wiper blades .....	115
Switching on/off .....	114
<b>Winter driving</b>	
Slippery road surfaces .....	160
Snow chains .....	305
<b>Winter operation</b>	
General notes .....	304
<b>Winter tires</b>	
M+S tires .....	304
<b>Wiper blades</b>	
Cleaning .....	278
Important safety notes .....	115
Replacing (rear window) .....	116
Replacing (windshield) .....	115
<b>Wooden trim (cleaning instructions)</b> .....	281

**Z**

<b>ZONE function</b>	
Switching on/off .....	127

## Protection of the environment

### General notes

#### 🌱 Environmental note

Daimler's declared policy is one of comprehensive environmental protection.

The objectives are for the natural resources that form the basis of our existence on this planet to be used sparingly and in a manner that takes the requirements of both nature and humanity into account.

You too can help to protect the environment by operating your vehicle in an environmentally responsible manner.

Fuel consumption and the rate of engine, transmission, brake and tire wear are affected by these factors:

- operating conditions of your vehicle
- your personal driving style

You can influence both factors. You should bear the following in mind:

Operating conditions:

- avoid short trips as these increase fuel consumption.
- always make sure that the tire pressures are correct.
- do not carry any unnecessary weight.
- remove roof racks once you no longer need them.
- a regularly serviced vehicle will contribute to environmental protection. You should therefore adhere to the service intervals.
- always have service work carried out at a qualified specialist workshop.

Personal driving style:

- do not depress the accelerator pedal when starting the engine.
- do not warm up the engine when the vehicle is stationary.
- drive carefully and maintain a safe distance from the vehicle in front.
- avoid frequent, sudden acceleration and braking.

- change gear in good time and use each gear only up to  $\frac{2}{3}$  of its maximum engine speed.
- switch off the engine in stationary traffic.
- keep an eye on the vehicle's fuel consumption.

### Environmental concerns and recommendations

Wherever the operating instructions require you to dispose of materials, first try to regenerate or re-use them. Observe the relevant environmental rules and regulations when disposing of materials. In this way you will help to protect the environment.

### Genuine Mercedes-Benz parts

#### 🌱 Environmental note

Daimler AG also supplies reconditioned major assemblies and parts which are of the same quality as new parts. They are covered by the same Limited Warranty entitlements as new parts.

❗ Air bags and Emergency Tensioning Devices, as well as control units and sensors for these restraint systems, may be installed in the following areas of your vehicle:

- doors
- door pillars
- door sills
- seats
- cockpit
- instrument cluster
- center console

Do not install accessories such as audio systems in these areas. Do not carry out repairs or welding. You could impair the operating efficiency of the restraint systems.

Have aftermarket accessories installed at a qualified specialist workshop.

You could jeopardize the operating safety of your vehicle if you use parts, tires and wheels as well as accessories relevant to safety which have not been approved by Mercedes. This could lead to malfunctions in safety-relevant systems, e.g. the brake system. Use only genuine Mercedes-Benz parts or parts of equal quality. Only use tires, wheels and accessories that have been specifically approved for your vehicle.

Genuine Mercedes-Benz parts are subject to strict quality control. Every part has been specifically developed, manufactured or selected for and adapted to Mercedes-Benz vehicles. Only genuine Mercedes-Benz parts should therefore be used.

More than 300,000 different genuine Mercedes-Benz parts are available for Mercedes-Benz models.

All authorized Mercedes-Benz Centers maintain a supply of genuine Mercedes-Benz parts for necessary service and repair work. In addition, strategically located parts delivery centers provide quick and reliable parts service.

Always specify the vehicle identification number (VIN) when ordering genuine Mercedes-Benz parts (> page 334).

## Operator's Manual

### Vehicle equipment

This Operator's Manual describes all models and all standard and optional equipment of your vehicle available at the time of going to print. Country-specific differences are possible. Bear in mind that your vehicle may not feature all functions described here. This also applies to safety-relevant systems and functions. The equipment in your vehicle may therefore differ from that shown in the descriptions and illustrations.

The original purchase agreement lists all systems installed in your vehicle.

Should you have any questions concerning equipment and operation, please consult an authorized Mercedes-Benz Center.

The Operator's Manual and Maintenance Booklet are important documents and should be kept in the vehicle.

## Service and vehicle operation

### Warranty

The implied warranty for your vehicle applies in accordance with the warranty terms and conditions in the Service and Warranty Information booklet.

Your authorized Mercedes-Benz Center will replace and repair all factory-installed parts in accordance with the following warranty terms and conditions:

- New Vehicle Limited Warranty
- Emission System Warranty
- Emission Performance Warranty
- California, Connecticut, Maine, Massachusetts, New York, Pennsylvania, Rhode Island and Vermont Emission Control System Warranty
- State warranty enforcement laws (lemon laws)

Replacement parts and accessories are covered by the Mercedes-Benz Parts and Accessories warranties. These are available at any authorized Mercedes-Benz Center.

- i** Should you lose your Service and Warranty Information booklet, have an authorized Mercedes-Benz Center arrange for a replacement. The new Service and Warranty Information booklet will be posted to you.

### Maintenance

The Service and Warranty Booklet describes all the necessary maintenance work which should be done at regular intervals.

Always have the Service and Warranty Booklet with you when you bring the vehicle to an authorized Mercedes-Benz Center. The ser-

vice advisor will record every service for you in the Service and Warranty Booklet.

### Roadside Assistance

The Mercedes-Benz Roadside Assistance Program offers technical help in the event of a breakdown. Calls to the toll-free Roadside Assistance Hotline are answered by our agents 24 hours a day, 365 days a year.

**1-800-FOR-MERCEdes(1-800-367-6372) (USA)**

**1-800-387-0100 (Canada)**

For additional information, refer to the Mercedes-Benz Roadside Assistance Program brochure (USA) or the "Roadside Assistance" section in the Service and Warranty booklet (Canada). You will find both in your vehicle literature portfolio.

### Change of address or change of ownership

In the event of a change of address, please send us the "Notification of Address Change" in the Service and Guarantee booklet or simply call the Mercedes-Benz Customer Assistance Center (USA) at the hotline number 1-800-FOR-MERCEdes(1-800-367-6372) or Customer Service Center (Canada) at 1-800-387-0100. This will assist us in contacting you in a timely manner should the need arise.

If you sell your Mercedes, please leave the entire literature in the vehicle so that it is available to the next owner.

If you have purchased a used car, please send us the "Notification of Used Car Purchase" in the Service and Guarantee booklet or simply call the Mercedes-Benz Customer Assistance Center (USA) at the hotline number 1-800-FOR-MERCEdes(1-800-367-6372) or Customer Service (Canada) at 1-800-387-0100.

### Vehicle operation outside Canada

If you plan to operate your vehicle in foreign countries, please be aware that:

- service facilities or replacement parts may not be readily available.
- unleaded fuel for vehicles with a catalytic converter may not be available. Leaded fuel may cause damage to the catalytic converter.
- the fuel may have a considerably lower octane rating. Unsuitable fuel can cause engine damage.

Some Mercedes-Benz models are available for delivery in Europe through our European Delivery Program. For details, consult an authorized Mercedes-Benz Center or write to one of the following addresses.

#### In the USA

Mercedes-Benz USA, LLC  
European Delivery Department  
One Mercedes Drive  
Montvale, NJ 07645-0350

#### In Canada

Mercedes-Benz Canada, Inc.  
European Delivery Department  
98 Vanderhoof Avenue  
Toronto, Ontario M4G 4C9

### Operating safety

#### Important safety notes

#### WARNING

If you do not have the prescribed service/maintenance work or any required repairs carried out, this can result in malfunctions or system failures. There is a risk of an accident. Always have the prescribed service/maintenance work as well as any required repairs carried out at a qualified specialist workshop.



**⚠ WARNING**

Flammable material such as leaves, grass or twigs may ignite if they come into contact with hot parts of the exhaust system. There is a risk of fire.

When driving off road or on unpaved roads, check the vehicle's underside regularly. In particular, remove parts of plants or other flammable materials which have become trapped. In the case of damage, contact a qualified specialist workshop.

**⚠ WARNING**

Modifications to electronic components, their software as well as wiring can impair their function and/or the function of other networked components. In particular, systems relevant to safety could also be affected. As a result, these may no longer function as intended and/or jeopardize the operating safety of the vehicle. There is an increased risk of an accident and injury.

Never tamper with the wiring as well as electronic components or their software. You should have all work to electrical and electronic equipment carried out at a qualified specialist workshop.

If you make any changes to the vehicle electronics, the general operating permit is rendered invalid.

**!** There is a risk of damage to the vehicle if:

- the vehicle becomes stuck, e.g. on a high curb or an unpaved road
- you drive too fast over an obstacle, e.g. a curb or a hole in the road
- a heavy object strikes the undercarriage or parts of the chassis

In situations like this, the body, the undercarriage, chassis parts, wheels or tires could be damaged without the damage being visible. Components damaged in this way can unexpectedly fail or, in the case of an accident, no longer withstand the strain they are designed to.

If the underbody paneling is damaged, combustible materials such as leaves, grass or twigs can gather between the underbody and the underbody paneling. If these materials come in contact with hot parts of the exhaust system, they can catch fire.

In such situations, have the vehicle checked and repaired immediately at a qualified specialist workshop. If on continuing your journey you notice that driving safety is impaired, pull over and stop the vehicle immediately, paying attention to road and traffic conditions. In such cases, consult a qualified specialist workshop.

**Declarations of conformity****Vehicle components which receive and/or transmit radio waves**

**USA:** "The wireless devices of this vehicle comply with Part 15 of the FCC Rules. Operation is subject to the following two conditions: 1) These devices may not cause harmful interference, and 2) These devices must accept any interference received, including interference that may cause undesired operation. Changes or modifications not expressly approved by the party responsible for compliance could void the user's authority to operate the equipment."

**Canada:** "The wireless devices of this vehicle comply with Industry Canada license-exempt RSS standard(s). Operation is subject to the following two conditions: (1) These devices may not cause interference, and (2) These devices must accept any interference, including interference that may cause undesired operation of the device."

**Diagnostics connection**

The diagnostics connection is only intended for the connection of diagnostic equipment at a qualified specialist workshop.

**⚠ WARNING**

If you connect equipment to the diagnostics connection in the vehicle, it may affect the operation of the vehicle systems. As a result, the operating safety of the vehicle could be affected. There is a risk of an accident.

Do not connect any equipment to a diagnostics connection in the vehicle.

**⚠ WARNING**

Objects in the driver's footwell can restrict the pedal travel or obstruct a depressed pedal. The operating and road safety of the vehicle is jeopardized. There is a risk of an accident.

Make sure that all objects in the vehicle are stowed correctly, and that they cannot enter the driver's footwell. Install the floor mats securely and as specified in order to ensure sufficient clearance for the pedals. Do not use loose floor mats and do not place floor mats on top of one another.

**!** If the engine is switched off and equipment on the diagnostics connection is used, the starter battery may discharge.

Connecting equipment to the diagnostics connection can lead to emissions monitoring information being reset, for example. This may lead to the vehicle failing to meet the requirements of the next emissions test during the main inspection.

**Qualified specialist workshop**

An authorized Mercedes-Benz Center is a qualified specialist workshop. It has the necessary specialist knowledge, tools and qualifications to correctly carry out the work required on your vehicle. This is especially the case for work relevant to safety.

Observe the notes in the Maintenance Booklet.

Always have the following work carried out at an authorized Mercedes-Benz Center:

- work relevant to safety
- service and maintenance work
- repair work
- alterations, installation work and modifications
- work on electronic components

**Correct use**

If you remove any warning stickers, you or others could fail to recognize certain dangers. Leave warning stickers in position.

Observe the following information when driving your vehicle:

- the safety notes in this manual
- the vehicle technical data
- traffic rules and regulations
- laws and safety standards pertaining to motor vehicles

**Problems with your vehicle**

If you should experience a problem with your vehicle, particularly one that you believe may affect its safe operation, we urge you to contact an authorized Mercedes-Benz Center immediately to have the problem diagnosed and rectified. If the problem is not resolved to your satisfaction, please discuss the problem again with a Mercedes-Benz Center or contact us at one of the following addresses.

**In the USA**

Customer Assistance Center  
Mercedes-Benz USA, LLC  
One Mercedes Drive  
Montvale, NJ 07645-0350

**In Canada**

Customer Relations Department  
Mercedes-Benz Canada, Inc.  
98 Vanderhoof Avenue  
Toronto, Ontario M4G 4C9

### Limited Warranty

**I** Follow the instructions in this manual about the proper operation of your vehicle as well as about possible vehicle damage. Damage to your vehicle that arises from culpable contraventions against these instructions is not covered either by the Mercedes-Benz Limited Warranty or by the New or Used-Vehicle Warranty.

### QR codes for the rescue card

The QR codes are secured in the fuel filler flap and on the opposite side on the B-pillar. In the event of an accident, rescue services can use the QR code to quickly find the appropriate rescue card for your vehicle. The current rescue card contains the most important information about your vehicle in a compact form, e.g. the routing of the electric cables.

You can find more information under [https://portal.aftersales.i.daimler.com/public/content/asportal/en/communication/informationen\\_fuer/QRCode.html](https://portal.aftersales.i.daimler.com/public/content/asportal/en/communication/informationen_fuer/QRCode.html).

### Data stored in the vehicle

#### Data recording

This vehicle is capable of recording diagnostic information relating to vehicle operation, malfunctions, and user settings. This may include information about the performance or status of various systems, including but not limited to, engine, throttle, steering or brake systems, that is stored and can be read out with suitable devices, particularly when the vehicle is serviced. The data obtained is used to properly diagnose and service your vehicle or to further optimize and develop vehicle functions.

### COMAND/mbrace

If the vehicle is equipped with COMAND or mbrace, additional data about the vehicle's operation, the use of the vehicle in certain situations, and the location of the vehicle may be compiled through COMAND or the mbrace system.

For additional information please refer to the COMAND User Manual and/or the mbrace Terms and Conditions.

### Event data recorders

This vehicle is equipped with an event data recorder (EDR). The main purpose of an EDR is to record data that will assist in understanding how a vehicle's systems performed in certain crash or near crash-like situations, such as during air bag deployment or when hitting a road obstacle. The EDR is designed to record data related to vehicle dynamics and safety systems for a short period of time, typically 30 seconds or less.

The EDR in this vehicle is designed to record such data as:

- how various systems in your vehicle are operating
- whether or not the driver and passenger seat belts are fastened
- how far (if at all) the driver is depressing the accelerator and/or brake pedal and
- how fast the vehicle is traveling

This data can help provide a better understanding of the circumstances in which crashes and injuries occur. NOTE: EDR data is recorded by your vehicle only if a non-trivial crash situation occurs; no data is recorded by the EDR under normal driving conditions and no personal data (e.g., name, gender, age, and crash location) are recorded. However, other parties, such as law enforcement, can combine the EDR data with the type of personal identification data routinely acquired during a crash investigation.

To read data recorded by an EDR, special equipment is required, and access to the vehicle or the EDR is needed. In addition to the vehicle manufacturer, other parties that have the special equipment, such as law enforcement, can read the information by accessing the vehicle or the EDR.

EDR data may be used in civil and criminal matters as a tool in accident reconstruction, accident claims, and vehicle safety. Since the Crash Data Retrieval CDR tool that is used to extract data from the EDR is commercially available, Mercedes-Benz USA, LLC ("MBUSA") expressly disclaims any and all liability arising from the extraction of this information by unauthorized Mercedes-Benz personnel.

MBUSA will not share EDR data with others without the consent of the vehicle owners or, if the vehicle is leased, without the consent of the lessee. Exceptions to this representation include responses to subpoenas by law enforcement; by federal, state or local government; in connection with or arising out of litigation involving MBUSA or its subsidiaries and affiliates; or, as required by law.

Warning: The EDR is a component of the Restraint System Module. Tampering with, altering, modifying or removing the EDR component may result in a malfunction of the Restraint System Module and other systems.

State laws or regulations regarding EDRs that conflict with federal regulation are pre-empted. This means that in the event of such conflict, the federal regulation governs. As of February 2013, 13 states have enacted laws relating to EDRs.

<http://www.mercedes-benz.com/opensource>

### Information on copyright

#### General information

Information on license for free and open-source software used in your vehicle and its electronic components is available on the following website:

Cockpit ..... 28  
Instrument cluster ..... 29  
Multifunction steering wheel ..... 31  
Center console ..... 32  
Door control panel ..... 34  
Overhead control panel ..... 35



## Cockpit

At a glance

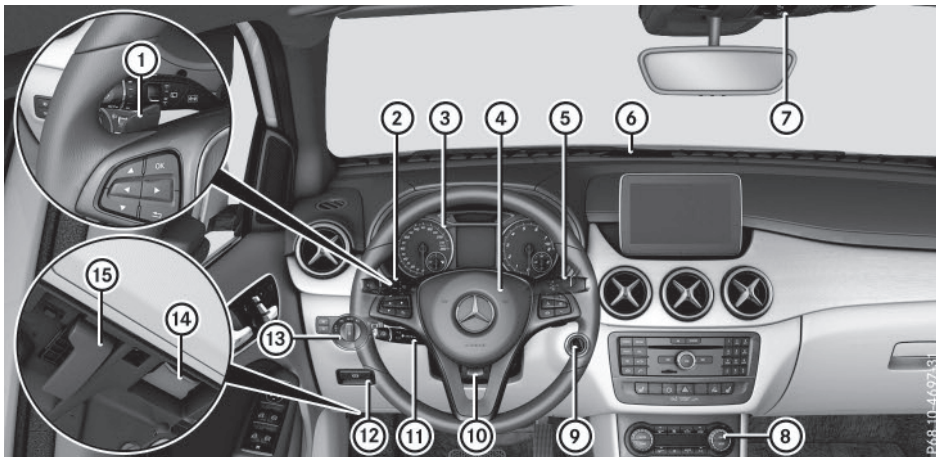

	Function	Page
①	Steering wheel paddle shifters	147
②	Combination switch	106
③	Instrument cluster	29
④	Horn	
⑤	DIRECT SELECT lever	142
⑥	PARKTRONIC warning display	172
⑦	Overhead control panel	35

	Function	Page
⑧	Climate control systems	120
⑨	Ignition lock	135
⑩	Adjusts the steering wheel	97
⑪	Cruise control lever	161
⑫	Electric parking brake	153
⑬	Light switch	104
⑭	Diagnostics connection	23
⑮	Opens the hood	270

## Instrument cluster

## Displays and controls

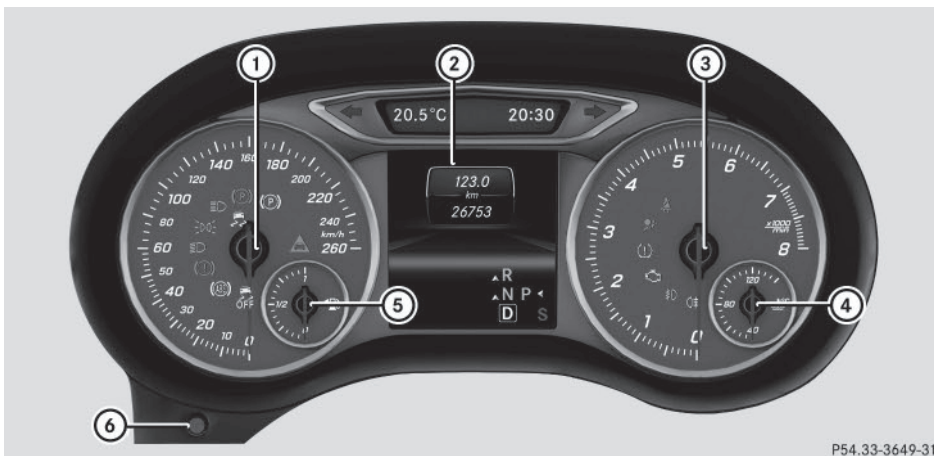

P54.33-3649-31

	Function	Page		Function	Page
①	Speedometer Speedometer segments	193	⑤	Fuel gage Fuel filler flap location indicator  : the fuel filler cap is on the left.	
②	Multifunction display	195	⑥	Instrument cluster lighting	192
③	Tachometer	193			
④	Coolant temperature	192			

- i** Information on the display of the outside temperature in the multifunction display can be found under "Outside temperature display" (▷ page 193).

## Warning and indicator lamps

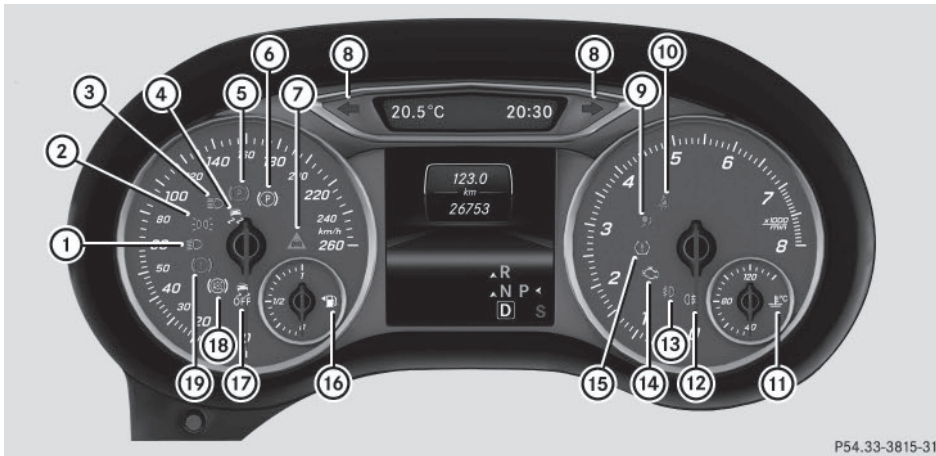

P54.33-3815-31

	Function	Page
①	Low-beam head-lamps	105
②	Parking lamps	106
③	High-beam head-lamps	106
④	ESP®	240
⑤	Electric parking brake (red) (USA only) (Canada only)	243
⑥	Electric parking brake (yellow)	243
⑦	Distance warning	246
⑧	Turn signals	106
⑨	Restraint system	38





	Function	Page
⑩	Seat belt	235
⑪	Coolant	244
⑫	Rear fog lamp	105
⑬	Front fog lamps	105
⑭	Check Engine	244
⑮	This lamp has no function	
⑯	Reserve fuel	
⑰	ESP® OFF	240
⑱	ABS	238
⑲	Brakes	237









Multifunction steering wheel



At a glance

	Function	Page
①	Multifunction display	195
②	Audio 20/COMAND display (see the separate operating instructions)	
③	 Switches on the Voice Control System (see the separate operating instructions)  Mute  Adjusts the volume  Rejects or ends a call Exits phone book/redial memory  Makes or accepts a call Switches to the redial memory	200



	Function	Page
④	  Selects a menu   Selects a submenu or scrolls through lists  Confirms a selection Hides display messages  Back Switches off the Voice Control System (see the separate operating instructions)	193



## Center console

## Center console, upper section



P68.20-4757-31

	Function	Page
①	Audio system/COMAND; see the separate operating instructions	
②	 Seat heating	96
③	 PARKTRONIC	172
④	 ECO start/stop func- tion	139

	Function	Page
⑤	 Hazard warning lamps	107
⑥	PASSENGER AIR BAG indi- cator lamp	39
⑦	 Selects the drive pro- gram	147

## Center console, lower section

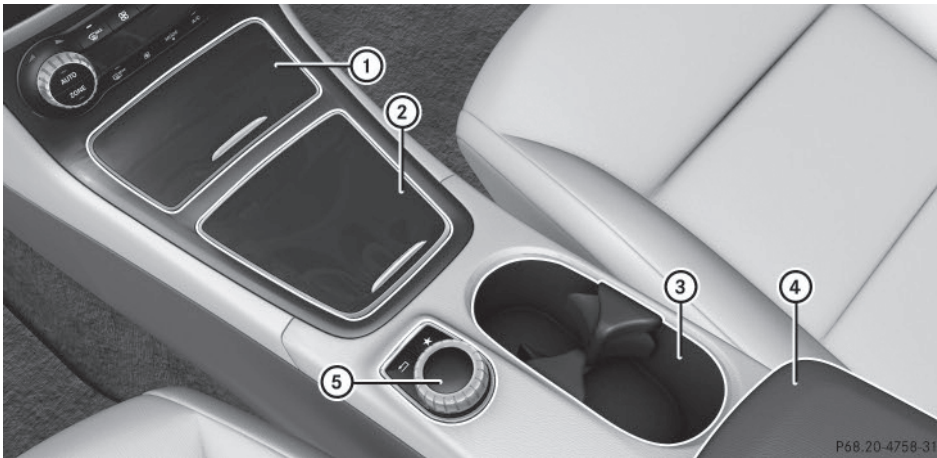







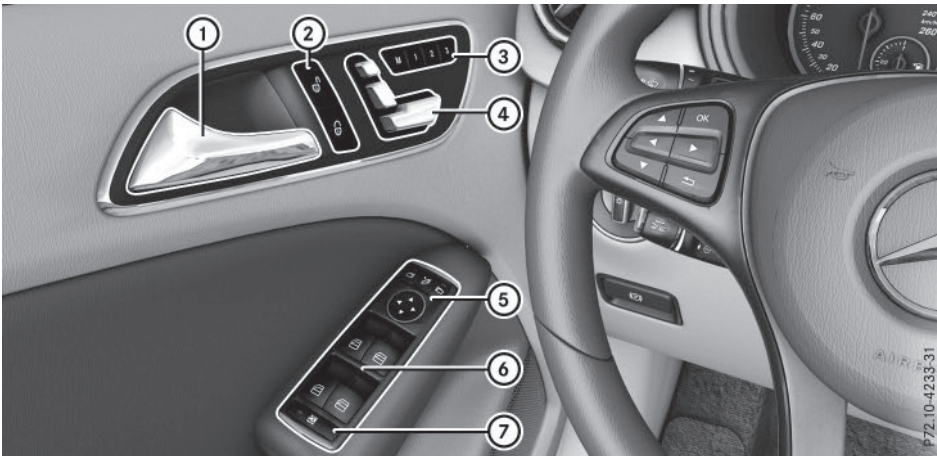





At a glance

	Function	Page		Function	Page
①	Ashtray	261	④	Stowage compartment with Media Interface	249
	Cigarette lighter	262			
	Socket	262	⑤	Audio/COMAND controller; see the separate operating instructions	
	Stowage compartment	249			
②	Stowage compartment	249			
③	Cup holder	259			

## Door control panel







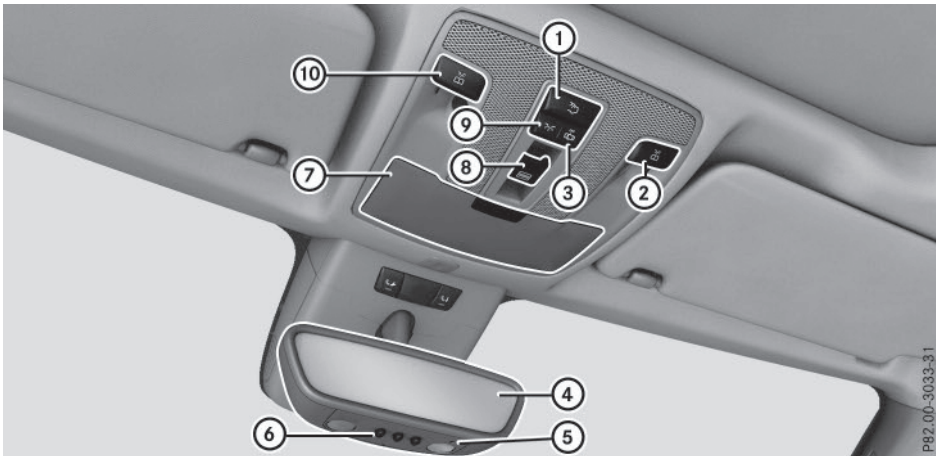

	Function	Page
①	Opens the door	77
②	  Unlocks/locks the vehicle	78
③	    Saves the seat and exterior mirror settings	101
④	Adjusts the seats electrically	94
⑤	    Adjusts and folds the exterior mirrors in/out electrically	98

	Function	Page
⑥	 Opens/closes the side windows	82
⑦	 Activates/deactivates the override feature for the side windows in the rear compartment	60

## Overhead control panel



At a glance

	Function	Page		Function	Page
①	 Switches the rear interior lighting on/off	108	⑦	Eyeglasses compartment	249
②	 Switches the right-hand reading lamp on/off	108	⑧	 Opens/closes the panorama roof with power tilt/sliding panel with roller sunblinds	86
③	 Switches the front interior lighting/automatic interior lighting control off	108	⑨	 Switches the front interior lighting on	108
④	Rear-view mirror	98	⑩	 Switches the left-hand reading lamp on/off	108
⑤	Sets the compass	267			
⑥	Buttons for the garage door opener	264			



Useful information .....	38
Panic alarm .....	38
Occupant safety .....	38
Children in the vehicle .....	54
Pets in the vehicle .....	60
Driving safety systems .....	60
Protection against theft .....	67

### Useful information

- i** This Operator's Manual describes all models and all standard and optional equipment of your vehicle available at the time of publication of the Operator's Manual. Country-specific differences are possible. Please note that your vehicle may not be equipped with all features described. This also applies to safety-related systems and functions.
- i** Read the information on qualified specialist workshops (▷ page 24).

### Panic alarm



- ▶ **To activate:** press and hold the **PANIC** button ① for approx. one second. A visual and audible alarm is triggered if the alarm system is armed.
  - ▶ **To deactivate:** press **PANIC** button ① again.
- or
- ▶ Insert the SmartKey into the ignition lock. or, in vehicles with KEYLESS-GO start-function or KEYLESS-GO
  - ▶ Press the Start/Stop button.  
The SmartKey must be in the vehicle.

### Occupant safety

#### Restraint system: introduction

The restraint system reduces the risk of vehicle occupants coming into contact with parts of the vehicle's interior in the event of an accident. The restraint system can also reduce the forces to which vehicle occupants are subjected during an accident.

The restraint system comprises:

- Seat belt system
- Air bags
- Child restraint system
- Child seat securing systems

The components of the restraint system work in conjunction with each other. They can only deploy their protective function if, at all times, all vehicle occupants:

- have fastened their seat belts correctly (▷ page 41)
- have adjusted their seat and head restraint properly (▷ page 93).

As the driver, you also have to make sure that the steering wheel is adjusted correctly. Observe the information relating to the correct driver's seat position (▷ page 92).

You also have to make sure that an air bag can inflate properly if deployed (▷ page 44).

An air bag supplements a correctly worn seat belt. As an additional safety device, the air bag increases the level of protection for vehicle occupants in the event of an accident. For example, if, in the event of an accident, the protection offered by the seat belt is sufficient, the air bags are not deployed. When an accident occurs, only the air bags that increase protection in that particular accident situation are deployed. However, seat belts and air bags generally do not protect against objects penetrating the vehicle from the outside.

Information on restraint system operation can be found under "Triggering of the Emergency Tensioning Devices and air bags" (▷ page 52).



For more information about children traveling with you in the vehicle and on child restraint systems, see "Children in the vehicle" (▷ page 54).

### Important safety notes

#### WARNING

Modifications to the restraint system may cause it to no longer work as intended. The restraint system may then not perform its intended protective function and may fail in an accident or trigger unexpectedly, for example. This poses an increased risk of injury or even fatal injury.

Never modify parts of the restraint system. Never tamper with the wiring, the electronic components or their software.

If it is necessary to modify an air bag system to accommodate a person with disabilities, contact an authorized Mercedes-Benz Center for details. USA only: for further information contact our Customer Assistance Center at 1-800-FOR-MERCEDES (1-800-367-6372).

### Restraint system warning lamp

The functions of the restraint system are checked after the ignition is switched on and at regular intervals while the engine is running. Therefore, malfunctions can be detected in good time.

The  restraint system warning lamp in the instrument cluster lights up when the ignition is switched on. It goes out no later than a few seconds after the vehicle is started. The components of the restraint system are in operational readiness.

A malfunction has occurred if the  restraint system warning lamp:

- does not light up after the ignition is switched on
- does not go out after a few seconds with the engine running
- lights up again while the engine is running

#### WARNING

If restraint system is malfunctioning, restraint system components may be triggered unintentionally or might not be triggered at all in the event of an accident with a high rate of vehicle deceleration. This can affect the Emergency Tensioning Device or air bag, for example. This poses an increased risk of injury or even fatal injury.

Have the restraint system checked and repaired in a qualified specialist workshop as soon as possible.

### PASSENGER AIR BAG indicator lamp



PASSENGER AIR BAG OFF indicator lamp ① and PASSENGER AIR BAG ON indicator lamp ② are part of the Occupant Classification System (OCS).

The indicator lamps display the status of the front-passenger front air bag.

- PASSENGER AIR BAG ON lights up: the front-passenger front air bag is enabled. If, in the event of an accident, all deployment criteria are met, the front-passenger front air bag is deployed.
- PASSENGER AIR BAG OFF lights up: the front-passenger front air bag is deactivated. It will then not be deployed in the event of an accident.

Depending on the person in the front-passenger seat, the front-passenger front air bag must either be deactivated or enabled; see the following points. You must make sure of this both before and during a journey.

- **Children in a child restraint system:** whether the front-passenger front air bag is enabled or deactivated depends on the installed child restraint system, and the age and size of the child. Therefore, be sure to observe the notes on the "Occupant Classification System (OCS)" (▷ page 47) and on "Children in the vehicle" (▷ page 54). There you will also find instructions on rearward and forward-facing child restraint systems on the front-passenger seat.
- **All other persons:** depending on the classification of the person in the front-passenger seat, the front-passenger front air bag is enabled or deactivated (▷ page 47). Be sure to observe the notes on "Seat belts" (▷ page 40) and "Air bags" (▷ page 44). There you can also find information on the correct seat position.

## Seat belts

### Introduction

Seat belts are the most effective means of restricting the movement of vehicle occupants in the event of an accident or the vehicle rolling over. This reduces the risk of vehicle occupants coming into contact with parts of the vehicle interior or being ejected from the vehicle. Furthermore, the seat belt helps to keep the vehicle occupant in the best position in relation to the air bag.

The seat belt system comprises:

- Seat belts
- Emergency Tensioning Devices for the front seat belts and the outer seat belts in the rear
- Seat belt force limiters for the front seat belts and the outer seat belts in the rear

If the seat belt is pulled out of the belt outlet quickly or with a jerky movement, the belt retractor locks. The belt strap cannot be extracted any further.

The Emergency Tensioning Device tightens the seat belt in an accident, pulling the belt close against the body. However it does not pull the vehicle occupant back in the direction of the backrest.

The Emergency Tensioning Device does not correct an incorrect seat position or the routing of an incorrectly fastened seat belt.

When triggered, a seat belt force limiter helps to reduce the force exerted by the seat belt on the vehicle occupant.

The seat belt force limiters for the front seats are synchronized with the front air bags, which absorb part of the deceleration force. This can reduce the force exerted on the vehicle occupants during an accident.

**!** If the front-passenger seat is unoccupied, do not insert the belt tongue into the buckle of the front-passenger seat. This may otherwise lead to the triggering of the Emergency Tensioning Device in the event of an accident, which will then need to be replaced.

### Important safety notes

The use of seat belts and child restraint systems is required by law in:

- all 50 states
- the U.S. territories
- the District of Columbia
- all Canadian provinces

Even where this is not required by law, all vehicle occupants should correctly fasten their seat belts before starting the journey.

#### **WARNING**

If the seat belt is incorrectly fastened, it cannot protect as intended. Furthermore, an incorrectly fastened seat belt can cause additional injury, for example, in an accident, during braking or when abruptly changing direc-

tion. This poses an increased risk of injury or even fatal injury.

Make sure that all vehicle occupants are seated properly with a correctly fastened seat belt.

#### **WARNING**

The seat belt does not offer the intended level of protection if you have not moved the backrest to an almost vertical position. When braking or in the event of an accident, you could slide underneath the seat belt and sustain abdomen or neck injuries, for example. This poses an increased risk of injury or even fatal injury.

Adjust the seat properly before beginning your journey. Always ensure that the backrest is in an almost vertical position and that the shoulder section of your seat belt is routed across the center of your shoulder.

#### **WARNING**

Persons under 5 ft (1.50 m) in height cannot fasten the seat belt correctly without an additional suitable restraint system. If the seat belt is incorrectly fastened, it cannot protect as intended. Furthermore, an incorrectly fastened seat belt can cause additional injury, for example, in an accident, during braking or an abrupt change of direction. This poses an increased risk of injury or even fatal injury.

For this reason, always secure persons under 5 ft (1.50 m) in height in suitable restraint systems.

If a child younger than 12 years and under 5 ft (1.50 m) in height is traveling in the vehicle:

- always secure the child in a child restraint system suitable for this Mercedes-Benz vehicle. The child restraint system must be appropriate to the age, weight and size of the child
- always observe the instructions and safety notes in the "Children in the vehicle" section of this Operator's Manual (> page 54) in addition to the child

restraint system manufacturer's installation instructions

- be sure to observe the instructions and safety notes on the "Occupant classification system (OCS)" (> page 47)

#### **WARNING**

The seat belts may not perform their intended protective function if:

- they are damaged, modified, extremely dirty, bleach or dyed
- the seat belt buckle is damaged or extremely dirty
- the Emergency Tensioning Devices, belt anchorages or inertia reels have been modified

Seat belts may sustain non-visible damage in an accident, e.g. due to glass splinters. Modified or damaged seat belts may tear or fail, e.g. in an accident. Modified Emergency Tensioning Devices could accidentally trigger or fail to deploy when necessary. This poses an increased risk of injury or even fatal injury.

Never modify the seat belts, Emergency Tensioning Devices, belt anchorages or inertia reels. Make sure that the seat belts are undamaged, not worn out and clean. Following an accident, have the seat belts checked immediately at a qualified specialist workshop.

Only use seat belts that have been approved for your vehicle by Mercedes-Benz. Any such modifications could invalidate the vehicle's general operating permit.

### **Proper use of the seat belts**

Observe the safety notes on the seat belt (> page 40).

All vehicle occupants must be wearing the seat belt correctly before beginning the journey. Also make sure that all vehicle occupants are always wearing the seat belt correctly while the vehicle is in motion.

When fastening the seat belt, always make sure that:

- the seat belt tongue is only inserted to the belt buckle belonging to that seat.
- the seat belt is tight across your body.  
Avoid wearing bulky clothing, e.g. a winter coat.
- the seat belt is not twisted.  
Only then can the forces which occur be distributed over the area of the belt.
- the shoulder section of the belt is always routed across the center of your shoulder.  
The shoulder section of the belt must not come into contact with your neck or be routed under your arm. Where possible, adjust the seat belt to the appropriate height.
- the lap belt passes tightly and as low down as possible across your lap.  
The lap belt must always be routed across your hip joints and not across your abdomen. This applies particularly to pregnant women. If necessary, push the lap belt down to your hip joint and pull it tight using the shoulder section of the belt.
- the seat belt is not routed across sharp, pointed or fragile objects.  
If you have such items located on or in your clothing, e.g. pens, keys or eyeglasses, store these in a suitable place.
- only one person is using a seat belt at a time.  
Infants and children must never travel sitting on the lap of a vehicle occupant. In the event of an accident, they could be crushed between the vehicle occupant and seat belt.
- objects are never secured with a seat belt if the seat belt is also being used by one of the vehicle's occupants.

Seat belts are only intended to secure and restrain vehicle occupants. Always observe the "Loading guidelines" for securing objects, luggage or loads (▷ page 248).

### Fastening and adjusting the seat belts

Observe the safety notes on the seat belt (▷ page 40) and the notes on correct use of seat belts (▷ page 41).

If the center rear seat belt is being used, also observe the information about the seat belt for the center rear seat (▷ page 43).

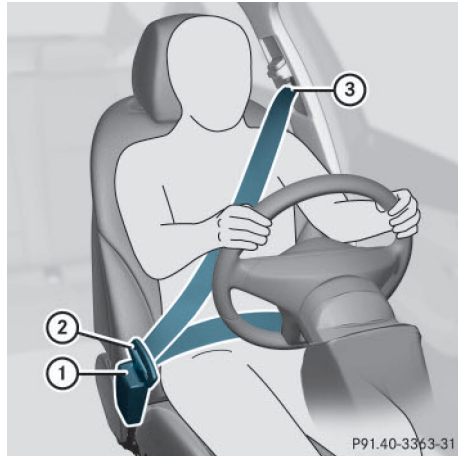

- ▶ Adjust the seat (▷ page 92).  
The seat backrest must be in an almost vertical position.
- ▶ Pull the seat belt smoothly from belt outlet ③.
- ▶ Engage seat belt tongue ② in belt buckle ①.
- ▶ If necessary, pull upwards on the shoulder section of the seat belt to tighten the belt across your body.

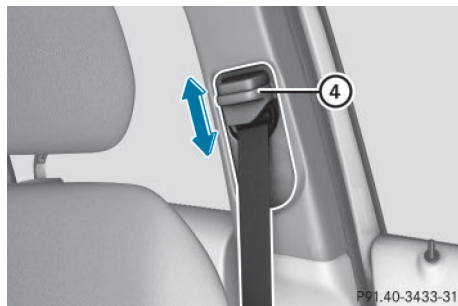

The shoulder section of the seat belt must always be routed across the center of the shoulder. Adjust the belt outlet if necessary.

- ▶ **To raise:** slide the belt outlet upwards.  
The belt outlet will engage in various positions.
- ▶ **To lower:** hold belt outlet release ④ and slide belt outlet downwards.
- ▶ Let go of belt outlet release ④ in the desired position and make sure that the belt outlet engages.

All seat belts except the driver's seat belt are equipped with a special seat belt retractor to securely fasten child restraint systems in the vehicle. Further information can be found under "Special seat belt retractor" (▷ page 55).

### Seat belt for the center rear seat

If the left-hand rear seat backrest is folded down and back up again, the rear center seat belt may lock. The seat belt can then not be pulled out.

- ▶ **To release the rear center seat belt:** pull the seat belt out approximately 1 in (25 mm) at the belt outlet on the backrest and then release it again.  
The seat belt is retracted and released.

### Releasing seat belts

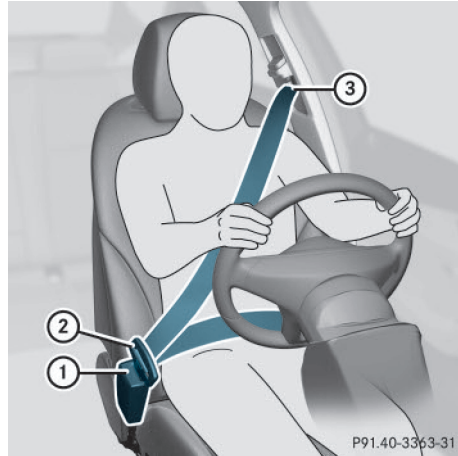

- ❗ Make sure that the seat belt is fully rolled up. Otherwise, the seat belt or belt tongue will be trapped in the door or in the seat mechanism. This could damage the door, the door trim panel and the seat belt. Damaged seat belts can no longer fulfill their protective function and must be replaced. Visit a qualified specialist workshop.



- ▶ Press release button ①, hold belt tongue ② firmly and guide it back towards belt outlet ③.

### Belt warning for the driver and front passenger

The  seat belt warning lamp in the instrument cluster is a reminder that all vehicle occupants must wear their seat belts. It may light up continuously or flash. In addition, there may be a warning tone.

Regardless of whether the driver's seat belt has already been fastened, the  seat belt warning lamp lights up for six seconds each time the engine is started. If, after six seconds, the driver or front-passenger seat belt has not been fastened and the doors are closed, the  seat belt warning lamp lights up. As soon as the driver's and front-passenger seat belts are fastened or a front door is opened again, the  seat belt warning lamp goes out.

If the driver's seat belt is not fastened after the engine is started, an additional warning tone will sound. This warning tone stops after six seconds or when the driver's seat belt is fastened.

If the vehicle's speed exceeds 15 mph (25 km/h) once and the driver's and front-passenger seat belts are not fastened, a

warning tone sounds. A warning tone also sounds with increasing intensity for 60 seconds or until the driver or front passenger have fastened their seat belts.

If the driver or front passenger unfasten their seat belts during the journey, the seat belt warning is activated again.

- i** For more information on the  seat belt warning lamp, see "Warning and indicator lamps in the instrument cluster, seat belts" (▷ page 235).

## Air bags

### Introduction

The installation point of an air bag can be recognized by the AIR BAG symbol.

An air bag complements the correctly fastened seat belt. It is no substitute for the seat belt. The air bag provides additional protection in applicable accident situations.

Not all air bags are deployed in an accident. The different air bag systems function independently from one another (▷ page 52).

However, no system available today can completely eliminate injuries and fatalities.

It is also not possible to rule out a risk of injury caused by an air bag due to the high speed at which the air bag must be deployed.

### Important safety notes

#### WARNING

If you do not sit in the correct seat position, the air bag cannot protect as intended and could even cause additional injury when deployed. This poses an increased risk of injury or even fatal injury.

To avoid hazardous situations, always make sure that all of the vehicle's occupants:

- have fastened their seat belts correctly, including pregnant women
- are sitting correctly and maintain the greatest possible distance to the air bags
- follow the following instructions

Always make sure that there are no objects between the air bag and the vehicle's occupants.

- Adjust the seats properly before beginning your journey. Always make sure that the seat is in an almost upright position. The center of the head restraint must support the head at about eye level.
- Move the driver's and front-passenger seats as far back as possible. The driver's seat position must allow the vehicle to be driven safely.
- Only hold the steering wheel on the outside. This allows the air bag to be fully deployed.
- Always lean against the backrest while driving. Do not lean forwards or lean against the door or side window. You may otherwise be in the deployment area of the air bags.
- Always keep your feet in the footwell in front of the seat. Do not put your feet on the dashboard, for example. Your feet may otherwise be in the deployment area of the air bag.
- For this reason, always secure persons less than 5 ft (1.50 m) tall in suitable restraint systems. Up to this height, the seat belt cannot be worn correctly.

#### **If a child is traveling in your vehicle, also observe the following notes:**

- Always secure children under 12 years of age and less than 5 ft (1.50 m) in height in suitable child restraint systems.
- Child restraint systems should be installed on the rear seats.

- Only secure a child in a rearward-facing child restraint system on the front-passenger seat when the front-passenger front air bag is deactivated. If the PASSENGER AIR BAG OFF indicator lamp is permanently lit, the front-passenger front air bag is deactivated (▷ page 39).
- Always observe the instructions and safety notes on the "Occupant Classification System (OCS)" (▷ page 47) and on "Children in the vehicle" (▷ page 54) in addition to the child restraint system manufacturer's installation instructions.

### Objects in the vehicle interior may prevent an air bag from functioning correctly.

Before starting your journey and to avoid risks resulting from the speed of the air bag as it deploys, make sure that:

- there are no people, animals or objects between the vehicle occupants and an air bag.
- there are no objects between the seat, door and B-pillar.
- no hard objects, e.g. coat hangers, hang on the grab handles or coat hooks.
- no accessories, such as cup holders, are attached to the vehicle within the deployment area of an air bag, e.g. to doors, side windows, rear side trim or side walls.
- no heavy, sharp-edged or fragile objects are in the pockets of your clothing. Store such objects in a suitable place.

#### WARNING

If you modify the air bag cover or affix objects such as stickers to it, the air bag can no longer function correctly. There is an increased risk of injury.

Never modify an air bag cover or affix objects to it.

#### WARNING

Sensors to control the air bags are located in the doors. Modifications or work not performed correctly to the doors or door paneling, as well as damaged doors, can lead to the

function of the sensors being impaired. The air bags might therefore not function properly any more. Consequently, the air bags cannot protect vehicle occupants as they are designed to do. There is an increased risk of injury.

Never modify the doors or parts of the doors. Always have work on the doors or door paneling carried out at a qualified specialist workshop.

### Front air bags

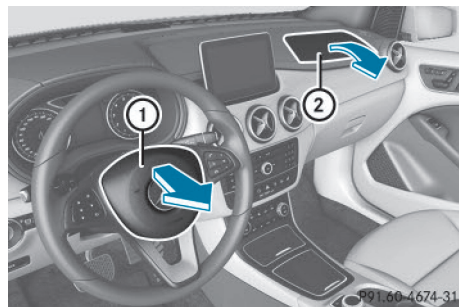

Driver's air bag ① deploys in front of the steering wheel. Front-passenger front air bag ② deploys in front of and above the glove box.

When deployed, the front air bags offer additional head and thorax protection for the occupants in the front seats.

The PASSENGER AIR BAG OFF and PASSENGER AIR BAG ON indicator lamps inform you about the status of the front-passenger front air bag (▷ page 39).

The front-passenger front air bag will only deploy if:

- the system, based on the OCS weight sensor readings, detects that the front-passenger seat is occupied (▷ page 47). The PASSENGER AIR BAG ON indicator lamp is lit (▷ page 47)
- the restraint system control unit predicts a high accident severity

### Driver's knee bag

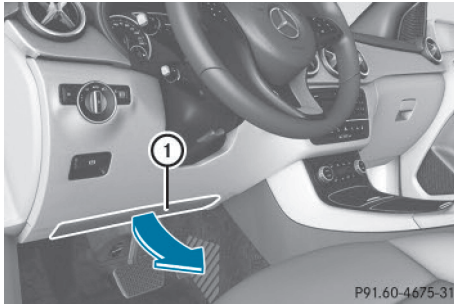

Driver's knee bag ① deploys under the steering column. The driver's knee bag is triggered together with the front air bag.

The driver's knee bag offers additional thigh, knee and lower leg protection for the occupant in the driver's seat.

### Side impact air bags

#### WARNING

Unsuitable seat covers could restrict or even prevent the deployment of the air bags integrated into the seats. Consequently, the air bags cannot protect vehicle occupants as they are designed to do. In addition, the function of the Occupant Classification System (OCS) could be restricted. This poses an increased risk of injury or even fatal injury.

You should only use seat covers that have been approved for the respective seat by Mercedes-Benz.

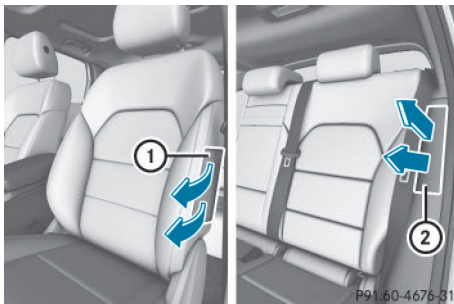

Front side impact air bags ① and rear side impact air bags ② deploy next to the outer bolster of the seat backrest.

When deployed, the side impact air bag offers additional thorax protection. It also offers additional pelvis protection for occupants in the front seats. However, it does not protect the:

- head
- neck
- arms

In the event of a side impact, the side impact air bag is deployed on the side on which the impact occurs.

The side impact air bag on the front-passenger side (front) deploys under the following conditions:

- the OCS system detects that the front-passenger seat is occupied or
- the belt tongue is engaged in the belt buckle of the front-passenger seat

If the belt tongue is engaged in the belt buckle, the side impact air bag on the front-passenger side deploys if an appropriate accident situation occurs. In this case, deployment is independent of whether the front-passenger seat is occupied or not.

### Window curtain air bags

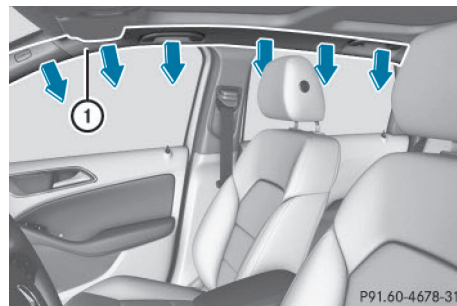

Window curtain air bags ① are integrated into the side of the roof frame and deployed in the area from the A-pillar to the C-pillar.

When deployed, the window curtain air bag enhances the level of protection for the head.



However, it does not protect the chest or arms.

In the event of a side impact, the window curtain air bag is deployed on the side on which the impact occurs.

If the system determines that they can offer additional protection to that provided by the seat belt, a window curtain air bag may be deployed in other accident situations (▷ page 52).

### Occupant Classification System (OCS)

#### Introduction

The Occupant Classification System (OCS) categorizes the person in the front-passenger seat. Depending on that result, the front-passenger front air bag is either enabled or deactivated.

The system does not deactivate:

- the side impact air bag
- the window curtain air bag
- the Emergency Tensioning Devices

#### Prerequisites

To be classified correctly, the front passenger must sit:

- with the seat belt fastened correctly
- in an almost upright position with their back against the seat backrest
- with their feet resting on the floor, if possible

If the front passenger does not observe these conditions, OCS may produce a false classification, e.g. because the front passenger:

- transfers their weight by supporting themselves on a vehicle armrest
- sits in such a way that their weight is raised from the seat cushion

If it is absolutely necessary to install a child restraint system on the front-passenger seat, be sure to observe the correct positioning of

the child restraint system. Never place objects under or behind the child restraint system, e.g. cushions. The entire base of the child restraint system must always rest on the seat cushion of the front-passenger seat. The backrest of the forward-facing child restraint system must lie as flat as possible against the backrest of the front-passenger seat.

The child restraint system must not touch the roof or be subjected to a load by the head restraint. Adjust the angle of the seat backrest and the head restraint position accordingly.

Only then can OCS be guaranteed to function correctly. Always observe the child restraint system manufacturer's installation instructions.

#### Operation of Occupant Classification System (OCS)



- ① PASSENGER AIR BAG OFF indicator lamp
- ② PASSENGER AIR BAG ON indicator lamp

The indicator lamps inform you whether the front-passenger front air bag is deactivated or enabled.

- Press the Start/Stop button once or twice, or turn the key to position **1** or **2** in the ignition lock.

The system carries out self-diagnostics.

The PASSENGER AIR BAG OFF and PASSENGER AIR BAG ON indicator lamps must light up simultaneously for approximately six seconds.

The indicator lamps display the status of the front-passenger front air bag.

- PASSENGER AIR BAG OFF lights up: the front-passenger front air bag is deactivated. It will then not be deployed in the event of an accident.
- PASSENGER AIR BAG ON lights up: the front-passenger front air bag is enabled. If, in the event of an accident, all deployment criteria are met, the front-passenger front air bag is deployed.

If the status of the front-passenger front air bag changes while the vehicle is in motion, an air bag display message appears in the instrument cluster (▷ page 2 18). When the front-passenger seat is occupied, always pay attention to the PASSENGER AIR BAG ON and PASSENGER AIR BAG OFF indicator lamps. Be aware of the status of the front-passenger front air bag both before and during the journey.

#### WARNING

If the PASSENGER AIR BAG OFF indicator lamp is lit, the front-passenger front air bag is disabled. It will not be deployed in the event of an accident and cannot perform its intended protective function. A person in the front-passenger seat could then, for example, come into contact with the vehicle's interior, especially if the person is sitting too close to the dashboard. This poses an increased risk of injury or even fatal injury.

When the front-passenger seat is occupied, always ensure that:

- the classification of the person in the front-passenger seat is correct and the front-passenger front air bag is enabled or disabled in accordance with the person in the front-passenger seat
- the front-passenger seat has been moved back as far back as possible.
- the person is seated correctly.

Make sure, both before and during the journey, that the status of the front-passenger front air bag is correct.

#### WARNING

If you secure a child in a rearward-facing child restraint system on the front-passenger seat and the PASSENGER AIR BAG ON indicator lamp is lit up, the front-passenger front air bag may deploy in an accident. The child could be struck by the air bag. This poses an increased risk of injury or even fatal injury.

Make sure that the front-passenger front air bag has been disabled. The PASSENGER AIR BAG OFF indicator lamp must be lit.

If the PASSENGER AIR BAG OFF indicator lamp remains off and/or the PASSENGER AIR BAG ON indicator lamp lights up, do not install a rearward-facing child restraint system on the front-passenger seat. You can find more information on OCS under "Problems with the Occupant Classification System" (▷ page 5 1).

#### WARNING

If you secure a child in a forward-facing child restraint system on the front-passenger seat and you position the front-passenger seat too close to the dashboard, in the event of an accident, the child could:

- come into contact with the vehicle's interior if the PASSENGER AIR BAG OFF indicator lamp is lit, for example
- be struck by the air bag if the PASSENGER AIR BAG ON is lit up

This poses an increased risk of injury or even fatal injury.

Move the front-passenger seat as far back as possible. Always make sure that the shoulder belt strap is correctly routed from the vehicle belt outlet to the shoulder belt guide on the child restraint system. The shoulder belt strap must be routed forwards and downwards from the vehicle belt outlet. If necessary, adjust the vehicle belt outlet and the front-passenger seat accordingly. Always observe the child restraint system manufacturer's installation instructions.

If OCS determines that:

- the front-passenger seat is unoccupied, the PASSENGER AIR BAG OFF indicator lamp lights up after the system self-test and remains lit. This indicates that the front-passenger front air bag is deactivated.
- the front-passenger seat is occupied by a child of up to 12 months old in a standard child restraint system, the PASSENGER AIR BAG OFF indicator lamp lights up after the system self-test and remains lit. This indicates that the front-passenger front air bag is deactivated.

But in the case of a 12-month-old child in a standard child restraint system, the PASSENGER AIR BAG ON can light up permanently after the system self-test. This indicates that the front-passenger front air bag is activated. The result of the classification is dependent on, among other factors, the child restraint system and the child's stature. It is recommended that you install the child restraint system on a suitable rear seat.

- the front-passenger seat is occupied by a person of smaller stature (e.g. a teenager or small adult), either the PASSENGER AIR BAG ON or PASSENGER AIR BAG OFF indicator lamp lights up and remains lit after the system self-test depending on the result of the classification.
  - If the PASSENGER AIR BAG ON indicator lamp lights up, move the front-passenger seat as far back as possible. Alternatively, a person of smaller stature can sit on a rear seat.
  - If the PASSENGER AIR BAG OFF indicator lamp is lit, a person of smaller stature should not use the front-passenger seat.
- the front-passenger seat is occupied by an adult or a person of a stature corresponding to that of an adult, the PASSENGER AIR BAG ON indicator lamp lights up after the system self-test and remains lit. This indicates that the front-passenger front air bag is activated.

If children are traveling in the vehicle, be sure to observe the notes on "Children in the vehicle" (▷ page 54).

When OCS is malfunctioning, the red  restraint system warning lamp in the instrument cluster and the PASSENGER AIR BAG OFF indicator lamp light up simultaneously. The front-passenger front air bag is deactivated in this case and does not deploy during an accident. Have the system checked by qualified technicians as soon as possible. Consult an authorized Mercedes-Benz Center. The front-passenger seat should only be repaired at an authorized Mercedes-Benz Center.

If the front-passenger seat, the seat cover or the seat cushion is damaged, have the necessary repair work carried out at an authorized Mercedes-Benz Center.

For safety reasons, Mercedes-Benz recommends that you only use seat accessories that have been approved by Mercedes-Benz. If the driver's air bag deploys, this does not mean that the front-passenger front air bag will also deploy. The Occupant Classification System (OCS) categorizes the occupant in the front-passenger seat. Depending on that result, the front-passenger front air bag is either enabled or deactivated.

### System self-test

#### DANGER

If both the PASSENGER AIR BAG OFF and PASSENGER AIR BAG ON indicator lamps do not light up during the system self-test, the system is malfunctioning. The front-passenger front air bag might be triggered unintentionally or might not be triggered at all in the event of an accident with high deceleration. This poses an increased risk of injury or even fatal injury.

In this case the front-passenger seat may not be used. Do not install a child restraint system on the front-passenger seat. Have the Occupant Classification System (OCS) checked and repaired immediately at a qualified specialist workshop.

**⚠ DANGER**

If the PASSENGER AIR BAG OFF indicator lamp remains lit after the system self-test, the front-passenger front air bag is disabled. It will not be deployed in the event of an accident. In this case, the front-passenger front air bag cannot perform its intended protective function, e.g. when a person is seated in the front-passenger seat.

That person could, for example, come into contact with the vehicle's interior, especially if the person is sitting too close to the dashboard. This poses an increased risk of injury or even fatal injury.

When the front-passenger seat is occupied, always ensure that:

- the classification of the person in the front-passenger seat is correct and the front-passenger front air bag is enabled or disabled in accordance with the person in the front-passenger seat
- the person is seated properly with a correctly fastened seatbelt
- the front-passenger seat has been moved back as far back as possible

If the PASSENGER AIR BAG OFF indicator lamp remains lit when it should not, the front-passenger seat may not be used. Do not install a child restraint system on the front-passenger seat. Have the Occupant Classification System (OCS) checked and repaired immediately at a qualified specialist workshop.

**⚠ WARNING**

Objects between the seat surface and the child restraint system could affect OCS operation. This could result in the front-passenger air bag not functioning as intended during an accident. This poses an increased risk of injury or even fatal injury.

Do not place any objects between the seat surface and the child restraint system. The entire base of the child restraint system must always rest on the seat cushion of the front-passenger seat. The backrest of the forward-

facing child restraint system must, as far as possible, be resting on the backrest of the front-passenger seat. Always comply with the child restraint system manufacturer's installation instructions.

After the system self-test, the PASSENGER AIR BAG OFF or PASSENGER AIR BAG ON indicator lamp display the status of the front-passenger front air bag (> page 47).

For more information about the OCS, see "Problems with the Occupant Classification System" (> page 51).

## Problems with the Occupant Classification System (OCS)

Be sure to observe the notes on "System self-test" (▷ page 49).

Problem	Possible causes/consequences and ► Solutions
<p>The PASSENGER AIR BAG OFF indicator lamp lights up and remains lit, even though the front-passenger seat is occupied by an adult or a person of a stature corresponding to that of an adult.</p>	<p>The classification of the person on the front-passenger seat is incorrect.</p> <ul style="list-style-type: none"> <li>▶ Make sure the conditions for a correct classification of the person on the front-passenger seat are met (▷ page 47).</li> <li>▶ If the PASSENGER AIR BAG OFF indicator lamp remains lit, the front-passenger seat may not be used.</li> <li>▶ Have OCS checked as soon as possible at an authorized Mercedes-Benz Center.</li> </ul>
<p>The PASSENGER AIR BAG OFF indicator lamp does not light up and/or does not stay on.</p> <p>The front-passenger seat is:</p> <ul style="list-style-type: none"> <li>• unoccupied</li> <li>• occupied by the weight of a child up to 12 months old in a child restraint system</li> </ul>	<p>OCS is malfunctioning.</p> <ul style="list-style-type: none"> <li>▶ Make sure there is nothing between the seat cushion and the child seat.</li> <li>▶ Make sure that the entire base of the child restraint system rests on the seat cushion of the front-passenger seat. The backrest of the forward-facing child restraint system must lie as flat as possible against the backrest of the front-passenger seat. If necessary, adjust the position of the front-passenger seat.</li> <li>▶ When installing the child restraint system, make sure that the seat belt is tight. Do not pull the seat belt tight using the front-passenger seat adjustment. This could result in the seat belt and the child restraint system being pulled too tightly.</li> <li>▶ Check for correct installation of the child restraint system. Make sure that the head restraint does not apply a load to the child restraint system. If necessary, adjust the head restraint accordingly.</li> <li>▶ Make sure that no objects are applying additional weight onto the seat.</li> <li>▶ If the PASSENGER AIR BAG OFF indicator lamp remains off and/or the PASSENGER AIR BAG ON indicator lamp lights up, do not install a child restraint system on the front-passenger seat. It is recommended that you install the child restraint system on a suitable rear seat.</li> <li>▶ Have OCS checked as soon as possible at an authorized Mercedes-Benz Center.</li> </ul>

## Deployment of Emergency Tensioning Devices and air bags

### Important safety notes

#### WARNING

The air bag parts are hot after an air bag has been deployed. There is a risk of injury.

Do not touch the air bag parts. Have a deployed air bag replaced at a qualified specialist workshop as soon as possible.

#### WARNING

A deployed air bag no longer offers any protection and cannot provide the intended protection in an accident. There is an increased risk of injury.

Have the vehicle towed to a qualified specialist workshop in order to have a deployed air bag replaced.

It is important for your safety and that of your passenger to have deployed air bags replaced and to have any malfunctioning air bags repaired. This will help to make sure the air bags continue to perform their protective function for the vehicle occupants in the event of a crash.

#### WARNING

Pyrotechnic Emergency Tensioning Devices that have been deployed are no longer operational and are unable to perform their intended protective function. This poses an increased risk of injury or even fatal injury.

Therefore, have pyrotechnic Emergency Tensioning Devices which have been triggered immediately replaced at a qualified specialist workshop.

If Emergency Tensioning Devices are triggered or air bags are deployed, you will hear a bang, and a small amount of powder may also be released. The  restraint system warning lamp lights up.

Only in rare cases will the bang affect your hearing. The powder that is released generally does not constitute a health hazard, but it

may cause short-term breathing difficulties in people with asthma or other respiratory problems. To avoid this, you may wish to get out of the vehicle or open the windows as soon as it is safe to do so.

Air bags and pyrotechnic Emergency Tensioning Devices (ETDs) contain perchlorate material, which may require special handling and regard for the environment. National guidelines must be observed during disposal. In California, see [www.dtsc.ca.gov/HazardousWaste/Perchlorate/index.cfm](http://www.dtsc.ca.gov/HazardousWaste/Perchlorate/index.cfm).

### Method of operation

During the first stage of a collision, the restraint system control unit evaluates important physical data relating to vehicle deceleration or acceleration, such as:

- duration
- direction
- intensity

Based on the evaluation of this data, the restraint system control unit triggers the Emergency Tensioning Devices during a frontal or rear collision.

An Emergency Tensioning Device can only be triggered, if:

- the ignition is switched on
- the components of the restraint system are operational; see "Restraint system warning lamp" (▷ page 39)
- the belt tongue is engaged in the buckle on the respective front-passenger seat

The Emergency Tensioning Devices in the rear compartment are triggered independently of the lock status of the seat belts.

If the restraint system control unit detects a more severe accident, further components of the restraint system are activated independently of each other in certain frontal collision situations:

- Front air bags and driver's knee bag
- Window curtain air bag, if the system determines that deployment can offer additional protection to that provided by the seat belt

The front-passenger front air bag is activated or deactivated depending on the person on the front-passenger seat. The front-passenger front air bag can only deploy in an accident if the PASSENGER AIR BAG ON indicator lamp is lit. Observe the information on the PASSENGER AIR BAG indicator lamps (▷ page 39).

Your vehicle has two-stage front air bags. During the first deployment stage, the front air bag is filled with propellant gas to reduce the risk of injuries. The front air bag is fully deployed with the maximum amount of propellant gas if a second deployment threshold is reached within a few milliseconds.

The activation threshold of the Emergency Tensioning Devices and the air bag are determined by evaluating the rate of vehicle deceleration or acceleration which occurs at various points in the vehicle. This process is pre-emptive in nature. Deployment should take place in good time at the start of the collision. The rate of vehicle deceleration or acceleration and the direction of the force are essentially determined by:

- the distribution of forces during the collision
- the collision angle
- the deformation characteristics of the vehicle
- the characteristics of the object with which the vehicle has collided

Factors which can only be seen and measured after a collision has occurred do not play a decisive role in the deployment of an air bag. Nor do they provide an indication of air bag deployment.

The vehicle can be deformed considerably, without an air bag being deployed. This is the case if only parts which are relatively easily deformed are affected and the rate of deceleration is not high. Conversely, air bags may

be deployed even though the vehicle suffers only minor deformation. This is the case if, for example, very rigid vehicle parts such as longitudinal body members are hit, and sufficient deceleration occurs as a result.

If the restraint system control unit detects a side impact, the relevant restraint system components are deployed independently of each other.

- Side impact air bags on the side of impact, independently of the Emergency Tensioning Device and the use of the seat belt on the driver's seat and outer seats in the second row

The side impact air bag on the front-passenger side (front) deploys under the following conditions:

- the OCS system detects that the front-passenger seat is occupied or
- the belt tongue is engaged in the belt buckle of the front-passenger seat
- Window curtain air bag on the side of impact, independently of the use of the seat belt and independently of whether the front-passenger seat is occupied
- Emergency Tensioning Device, if the system determines that deployment can offer additional protection in this situation

**i** Not all air bags are deployed in an accident. The different air bag systems work independently of each other.

How the air bag system works is determined by the severity of the accident detected, especially the vehicle deceleration or acceleration and the apparent type of accident:

- frontal collision
- side impact

### Automatic measures after an accident

Immediately after an accident, the following measures are implemented, depending on the type and severity of the impact:

- the hazard warning lamps are activated
- the emergency lighting is activated
- the vehicle doors are unlocked
- the front side windows are lowered
- the engine is switched off and the fuel supply is cut off
- vehicles with mbrace: automatic emergency call

### Children in the vehicle

#### Important safety notes

Accident statistics show that children secured in the rear seats are safer than children secured in the front-passenger seat. For this reason, Mercedes-Benz strongly advises that you install a child restraint system on a rear seat. Children are generally better protected there.

If a child younger than 12 years and under 5 ft (1.50 m) in height is traveling in the vehicle:

- always secure the child in a child restraint system suitable for Mercedes-Benz vehicles. The child restraint system must be appropriate to the age, weight and size of the child
- be sure to observe the instructions and safety notes in this section in addition to the child restraint system manufacturer's installation instructions
- be sure to observe the instructions and safety notes on the "Occupant classification system (OCS)" (▷ page 47)

#### WARNING

If you leave children unsupervised in the vehicle, they could set it in motion by, for example:

- release the parking brake.
- shift the automatic transmission out of the parking position **P**.
- start the engine.

In addition, they may operate vehicle equipment and become trapped. There is a risk of an accident and injury.

When leaving the vehicle, always take the SmartKey with you and lock the vehicle. Never leave children unsupervised in the vehicle.

#### WARNING

If persons, particularly children are subjected to prolonged exposure to extreme heat or cold, there is a risk of injury, possibly even fatal. Never leave children unattended in the vehicle.

#### WARNING

If the child restraint system is subjected to direct sunlight, parts may get very hot. Children may burn themselves on these parts, particularly on the metal parts of the child restraint system. There is a risk of injury.

If you leave the vehicle, taking the child with you, always ensure that the child restraint system is not exposed to direct sunlight. Protect it with a blanket, for example. If the child restraint system has been exposed to direct sunlight, let it cool down before securing the child in it. Never leave children unattended in the vehicle.

Always ensure that all vehicle occupants have their seat belts fastened correctly and are sitting properly. Particular attention must be paid to children.

Observe the safety notes on the seat belt (▷ page 40) and the notes on correct use of seat belts (▷ page 41).

A booster seat may be necessary to achieve proper seat belt positioning for children over



41 lbs (18 kg) until they reach a height where a three-point seat belt fits properly without a booster seat.

### Special seat belt retractor

#### WARNING

If the seat belt is released while driving, the child restraint system will no longer be secured properly. The special seat belt retractor is disabled and the inertia reel draws in a portion of the seat belt. The seat belt cannot be immediately refastened. There is an increased risk of injury, possibly even fatal. Stop the vehicle immediately, paying attention to road and traffic conditions. Reactivate the special seat belt retractor and secure the child restraint system properly.

All seat belts except the driver's seat belt are equipped with a special seat belt retractor. When activated, the special seat belt retractor ensures that the seat belt will not slacken once the child restraint system has been secured.

Installing a child restraint system:

- ▶ Always comply with the child restraint system manufacturer's installation instructions.
- ▶ Pull the seat belt smoothly from the belt outlet.
- ▶ Engage the seat belt tongue in the belt buckle.

Activating the special seat belt retractor:

- ▶ Pull the seat belt out fully and let the inertia reel retract it again.  
While the seat belt is retracting, you should hear a ratcheting sound. The special seat belt retractor is activated.
- ▶ Push the child seat restraint system down so that the seat belt is tight and does not loosen.

Removing a child restraint system/deactivating the special seat belt retractor:

- ▶ Always comply with the child restraint system manufacturer's installation instructions.
- ▶ Press the release button of the belt buckle, hold the belt tongue firmly and guide it back towards the belt outlet.  
The special seat belt retractor is deactivated.

### Child restraint system

The use of seat belts and child restraint systems is required by law in:

- all 50 states
- the U.S. territories
- the District of Columbia
- all Canadian provinces

If you install a rearward-facing child restraint system on the center rear seat, the rear arm rest must be folded back as far as possible.

You can obtain further information about the correct child restraint system from any authorized Mercedes-Benz Center.

#### WARNING

If the child restraint system is installed incorrectly on a suitable seat, it cannot protect as intended. The child cannot then be restrained in the event of an accident, heavy braking or sudden changes of direction. There is an increased risk of injury, possibly even fatal.

Make sure that you observe the child restraint system manufacturer's installation instructions and the notes on use. Please ensure, that the base of the child restraint system is always resting completely on the seat cushion. Never place objects, e.g. cushions, under or behind the child restraint system. Only use child restraint systems with the original cover designed for them. Only replace damaged covers with genuine covers.

**⚠ WARNING**

If the child restraint system is installed incorrectly or is not secured, it can come loose in the event of an accident, heavy braking or a sudden change in direction. The child restraint system could be thrown about, striking vehicle occupants. There is an increased risk of injury, possibly even fatal.

Always install child restraint systems properly, even if they are not being used. Make sure that you observe the child restraint system manufacturer's installation instructions.

You will find further information on stowing objects, luggage or loads under "Loading guidelines" (> page 248).

**⚠ WARNING**

Child restraint systems or their securing systems which have been damaged or subjected to a load in an accident can no longer protect as intended. The child cannot then be restrained in the event of an accident, heavy braking or sudden changes of direction. There is an increased risk of injury, possibly even fatal.

Replace child restraint systems which have been damaged or subjected to a load in an accident as soon as possible. Have the securing systems on the child restraint system checked at a qualified specialist workshop, before you install a child restraint system again.

The securing systems of child restraint systems are:

- the seat belt system
- the LATCH-type (ISOFIX) securing rings
- the Top Tether anchorages

If it is absolutely necessary to carry a child on the front-passenger seat, be sure to observe the information on the "Occupant Classification System (OCS)" (> page 47). There you will also find information on deactivating the front-passenger front air bag.

All child restraint systems must meet the following standards:

- U.S. Federal Motor Vehicle Safety Standards 213 and 225
- Canadian Motor Vehicle Safety Standards 213 and 210.2

Confirmation that the child restraint system corresponds to the standards can be found on an instruction label on the child restraint system. This confirmation can also be found in the installation instructions that are included with the child restraint system.

Observe the warning labels in the vehicle interior and on the child restraint system.

**LATCH-type (ISOFIX) child seat securing system****⚠ WARNING**

LATCH-type (ISOFIX) child restraint systems do not offer sufficient protective effect for children whose weight is greater than 48 lbs (22 kg) who are secured using the safety belt integrated in the child restraint system. In the event of an accident, a child might not be restrained correctly. This poses an increased risk of injury or even fatal injury.

If the child weighs more than 48 lbs (22 kg), only use LATCH-type (ISOFIX) child restraint systems with which the child is also secured with the vehicle seat belt. Also secure the child restraint system with the Top Tether belt, if available.

Always comply with the manufacturer's installation and operating instructions for the child restraint system used.

Before every trip, make sure that the LATCH-type (ISOFIX) child restraint system is engaged correctly in both LATCH-type (ISOFIX) securing rings

**!** When installing the child restraint system, make sure that the seat belt for the middle seat does not get trapped. The seat belt could otherwise be damaged.



① LATCH-type (ISOFIX) securing rings

- ▶ Install the LATCH-type (ISOFIX) child restraint system on both LATCH-type (ISOFIX) securing rings ①.

ISOFIX is a standardized securing system for specially designed child restraint systems on the rear seats. LATCH-type (ISOFIX) securing rings ① for two LATCH-type (ISOFIX) child restraint systems are installed on the left and right rear seats.

Non-LATCH-type (ISOFIX) child seats may also be used and can be installed using the vehicle's seat belt system. Install the child seat according to the manufacturer's instructions.

**Top Tether**

**Introduction**

Top Tether provides an additional connection between the child restraint system secured with a LATCH-type (ISOFIX) child seat mount and the vehicle. This helps reduce the risk of injury even further. If the child restraint system is equipped with a Top Tether belt, this should always be used.

**Important safety notes**

**⚠ WARNING**

If the rear seat backrests are not locked, they could fold forwards in the event of an accident, heavy braking or sudden changes of direction. As a result, child restraint systems cannot perform their intended protective

function. Rear seat backrests that are not locked can also cause additional injuries, e.g. in the event of an accident. This poses an increased risk of injury or even fatal injury. Always lock rear seat backrests after installing a Top Tether belt. Observe the lock verification indicator. Adjust the rear seat backrests so that they are in an upright position.

If the rear backrest is not engaged and locked, the red lock verification indicator will be visible (▷ page 252).

**Top Tether anchorages**

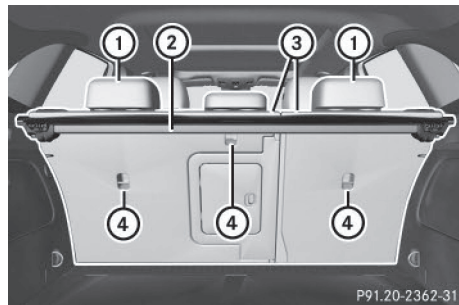

The Top Tether anchorages are located on the rear side of the rear seat backrests.

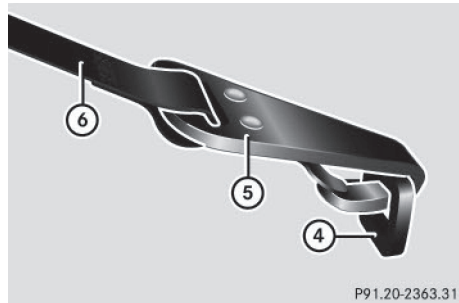

- ▶ Move head restraint ① upwards.
- ▶ Release rear seat backrest ③ and fold it forwards (▷ page 252).
- ▶ Route Top Tether belt ⑥ under head restraint ① between the two head restraint bars.
- ▶ Hook Top Tether hook ⑤ of Top Tether belt ⑥ into Top Tether anchorage ④.

Make sure that:

- Top Tether hook ⑤ is hooked into Top Tether anchorage ④ as shown.
  - Top Tether belt ⑥ is not twisted.
  - Top Tether belt ⑥ is routed between rear seat backrest ③ and cargo compartment cover ② if cargo compartment cover ② is installed.
  - Top Tether belt ⑥ is routed between the rear seat backrest ③ and the cargo net if the cargo net is installed.
- ▶ Swing back rear seat backrest ③ until it engages.  
The red lock verification indicator is no longer visible.
  - ▶ Install the LATCH-type (ISOFIX) child restraint system with Top Tether. Always comply with the child restraint system manufacturer's installation instructions when doing so.
  - ▶ Tension Top Tether belt ⑥. Always comply with the child restraint system manufacturer's installation instructions when doing so.
  - ▶ Move head restraint ① back down again slightly if necessary (▷ page 95). Make sure that you do not interfere with the correct routing of Top Tether belt ⑥.

### Child restraint system on the front-passenger seat

#### General notes

Accident statistics show that children secured in the rear seats are safer than children secured in the front-passenger seat. For this reason, Mercedes-Benz strongly advises that you install the child restraint system on a rear seat.

If it is absolutely necessary to install a child restraint system on the front-passenger seat, be sure to observe the instructions and safety notes on the "Occupant Classification System (OCS)" (▷ page 47).

You can thus avoid the risks that could arise as a result of:

- an incorrectly categorized person in the front-passenger seat
- the unintentional deactivation of the front-passenger front air bag
- the unsuitable positioning of the child restraint system, e.g. too close to the dashboard

#### Rearward-facing child restraint system

If it is absolutely necessary to install a rearward-facing child restraint system on the front-passenger seat, always make sure that the front-passenger front air bag is deactivated. Only if the PASSENGER AIR BAG OFF indicator lamp is permanently lit (▷ page 39) is the front-passenger front air bag deactivated.

Always observe the child restraint system manufacturer's installation and operating instructions.

#### Forward-facing child restraint system

If it is absolutely necessary to install a forward-facing child restraint system on the front-passenger seat, always move the front-passenger seat as far back as possible. The entire base of the child restraint system must always rest on the seat cushion of the front-passenger seat. The backrest of the child restraint system must lie as flat as possible against the backrest of the front-passenger seat. The child restraint system must not touch the roof or be subjected to a load by the head restraint. Adjust the angle of the seat backrest and the head restraint position accordingly. Always make sure that the shoulder belt strap is correctly routed from the vehicle belt outlet to the shoulder belt guide on the child restraint system. The shoulder belt strap must be routed forwards and downwards from the vehicle belt outlet. If necessary, adjust the vehicle belt outlet and the front-passenger seat accordingly.

Always observe the child restraint system manufacturer's installation and operating instructions.

### Child-proof locks

#### Important safety notes

##### WARNING

If children are traveling in the vehicle, they could:

- open doors, thus endangering other people or road users
- exit the vehicle and be caught by oncoming traffic
- operate vehicle equipment and become trapped

There is a risk of an accident and injury.

Always activate the child-proof locks and override feature if children are traveling in the vehicle. When leaving the vehicle, always take the key with you and lock the vehicle. Never leave children unattended in the vehicle.

Override feature for:

- the rear doors (▷ page 59)
- the rear side windows (▷ page 60)

##### WARNING

If you leave children unsupervised in the vehicle, they could set it in motion by, for example:

- release the parking brake.
- shift the automatic transmission out of the parking position **P**.
- start the engine.

In addition, they may operate vehicle equipment and become trapped. There is a risk of an accident and injury.

When leaving the vehicle, always take the SmartKey with you and lock the vehicle. Never leave children unsupervised in the vehicle.

##### WARNING

If persons, particularly children are subjected to prolonged exposure to extreme heat or cold, there is a risk of injury, possibly even fatal. Never leave children unattended in the vehicle.

##### WARNING

If the child restraint system is subjected to direct sunlight, parts may get very hot. Children may burn themselves on these parts, particularly on the metal parts of the child restraint system. There is a risk of injury.

If you leave the vehicle, taking the child with you, always ensure that the child restraint system is not exposed to direct sunlight. Protect it with a blanket, for example. If the child restraint system has been exposed to direct sunlight, let it cool down before securing the child in it. Never leave children unattended in the vehicle.

#### Child-proof locks for the rear doors

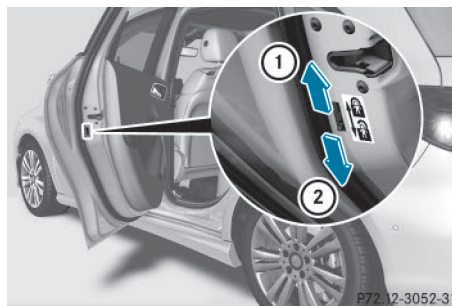

You secure each door individually with the child-proof locks on the rear doors. A door secured with a child-proof lock cannot be opened from inside the vehicle. When the vehicle is unlocked, the door can be opened from the outside.

- ▶ **To activate:** press the child-proof lock lever up in the direction of arrow ①.
- ▶ Make sure that the child-proof locks are working properly.
- ▶ **To deactivate:** press the child-proof lock lever down in the direction of arrow ②.

### Override feature for the rear side windows

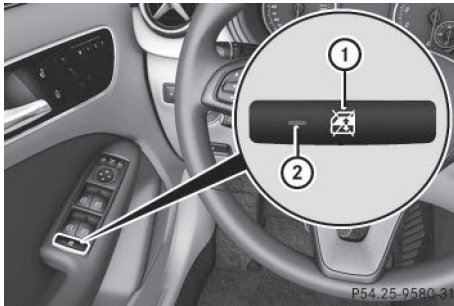

- ▶ **To enable/disable:** press button ①. If indicator lamp ② is lit, operation of the rear side windows is disabled. Operation is only possible using the switches in the driver's door. If indicator lamp ② is off, operation is possible using the switches in the rear compartment.

### Pets in the vehicle

#### **WARNING**

If you leave animals unattended or unsecured in the vehicle, they could press buttons or switches, for example.

As a result, they could:

- activate vehicle equipment and become trapped, for example
- activate or deactivate systems, thereby endangering other road users

Unsecured animals could also be flung around the vehicle in the event of an accident or sudden steering or braking, thereby injuring vehicle occupants. There is a risk of an accident and injury.

Never leave animals unattended in the vehicle. Always secure animals properly during the journey, e.g. use a suitable animal transport box.

### Driving safety systems

#### Overview of driving safety systems

In this section, you will find information about the following driving safety systems:

- **ABS (Anti-lock Braking System)** (▷ page 61)
- **BAS (Brake Assist System)** (▷ page 61)
- **COLLISION PREVENTION ASSIST PLUS** (▷ page 62)
- **ESP® (Electronic Stability Program)** (▷ page 64)
- **EBD (Electronic Brake force Distribution)** (▷ page 66)
- **ADAPTIVE BRAKE** (▷ page 66)
- **STEER CONTROL** (▷ page 66)

#### Important safety notes

If you fail to adapt your driving style or if you are inattentive, the driving safety systems can neither reduce the risk of an accident nor override the laws of physics. Driving safety systems are merely aids designed to assist driving. You are responsible for maintaining the distance to the vehicle in front, for vehicle speed, for braking in good time, and for staying in lane. Always adapt your driving style to suit the prevailing road and weather conditions and maintain a safe distance from the vehicle in front. Drive carefully.

The driving safety systems described only work as effectively as possible when there is adequate contact between the tires and the road surface. Please pay special attention to the notes on tires, recommended minimum tire tread depths, etc. (▷ page 302).

In wintry driving conditions, always use winter tires (M+S tires) and if necessary, snow

chains. Only in this way will the driving safety systems described in this section work as effectively as possible.

### ABS (Anti-lock Braking System)

#### General information

ABS regulates brake pressure in such a way that the wheels do not lock when you brake. This allows you to continue steering the vehicle when braking.

The  ABS warning lamp in the instrument cluster lights up when the ignition is switched on. It goes out when the engine is running.

#### Important safety notes

- i** Observe the "Important safety notes" section (▷ page 60).

#### WARNING

If ABS is faulty, the wheels could lock when braking. The steerability and braking characteristics may be severely impaired. Additionally, further driving safety systems are deactivated. There is an increased danger of skidding and accidents.

Drive on carefully. Have ABS checked immediately at a qualified specialist workshop.

When ABS is malfunctioning, other systems, including driving safety systems, will also become inoperative. Observe the information on the ABS warning lamp (▷ page 238) and display messages which may be shown in the instrument cluster (▷ page 208).

ABS works from a speed of about 5 mph (8 km/h), regardless of road-surface conditions. ABS works on slippery surfaces, even when you only brake gently.

#### Braking

- ▶ **If ABS intervenes:** continue to depress the brake pedal vigorously until the braking situation is over.
- ▶ **To make a full brake application:** depress the brake pedal with full force.

If ABS intervenes when braking, you will feel a pulsing in the brake pedal.

The pulsating brake pedal can be an indication of hazardous road conditions, and functions as a reminder to take extra care while driving.

### BAS (Brake Assist System)

#### General information

BAS operates in emergency braking situations. If you depress the brake pedal quickly, BAS automatically boosts the braking force, thus shortening the stopping distance.

#### Important safety notes

- i** Observe the "Important safety notes" section (▷ page 60).

#### WARNING

If BAS is malfunctioning, the braking distance in an emergency braking situation is increased. There is a risk of an accident.

In an emergency braking situation, depress the brake pedal with full force. ABS prevents the wheels from locking.

#### Braking

- ▶ Keep the brake pedal firmly depressed until the emergency braking situation is over. ABS prevents the wheels from locking.

The brakes will function as usual once you release the brake pedal. BAS is deactivated.

## COLLISION PREVENTION ASSIST PLUS

### General information

COLLISION PREVENTION ASSIST PLUS consists of a distance warning function with an autonomous emergency braking function and adaptive Brake Assist.

COLLISION PREVENTION ASSIST PLUS can help you to minimize the risk of a front-end collision with a vehicle ahead or reduce the effects of such a collision.

If COLLISION PREVENTION ASSIST PLUS detects that there is a risk of a collision, you will be warned visually and acoustically. If you do not react to the visual and audible collision warning, autonomous braking can be initiated in critical situations. If you apply the brake yourself in a critical situation, the COLLISION PREVENTION ASSIST PLUS adaptive Brake Assist assists you.

### Important safety notes

In particular, the detection of obstacles can be impaired if:

- there is dirt on the sensors or anything else covering the sensors
- there is snow or heavy rain
- there is interference by other radar sources
- there are strong radar reflections, for example in parking garages
- a narrow vehicle traveling in front, e.g. a motorbike
- a vehicle traveling in front on a different line
- new vehicles or after a service on the COLLISION PREVENTION ASSIST PLUS system

Observe the notes in the section on braking-in (> page 134).

Following damage to the front end of the vehicle, have the configuration and operation of the radar sensor checked at a qualified specialist workshop. This also applies to collisions at low speeds where there is no visible damage to the front of the vehicle.

## Distance warning function

### Important safety notes

**i** Observe the "Important safety notes" section for driving safety systems (> page 60).

#### WARNING

The distance warning function does not react:

- to people or animals
- to oncoming vehicles
- to crossing traffic
- when cornering

Thus, the distance warning function cannot provide a warning in all critical situations. There is a risk of an accident.

Always pay careful attention to the traffic situation and be ready to brake.

#### WARNING

The distance warning function cannot always clearly identify objects and complex traffic situations.

In such cases, the distance warning function may:

- give an unnecessary warning
- not give a warning

There is a risk of an accident.

Always pay careful attention to the traffic situation and do not rely solely on the distance warning function.

### Function

► **To activate/deactivate:** activate or deactivate the distance warning function in the on-board computer (> page 203).

**Vehicles with a black and white multi-function display:** when the distance warning function is activated, the  symbol appears in the status overview in the multi-function display.

**Vehicles with a color multifunction display:** when the distance warning function is deactivated, the  symbol appears in the assistance graphics in the multifunction display in display.



The distance warning function can help you to minimize the risk of a front-end collision with a vehicle ahead or reduce the effects of such a collision. If the distance warning function detects that there is a risk of a collision, you will be warned visually and acoustically.

Starting at a speed of around 4 mph (7 km/h), the distance warning function warns you if you rapidly approach a vehicle in front. An intermittent warning tone will then sound, and the  distance warning lamp will light up in the instrument cluster.

► Brake immediately in order to increase the distance from the vehicle in front.

or

► Take evasive action, provided it is safe to do so.

Due to the nature of the system, particularly complicated but non-critical driving conditions may also cause the system to display a warning.

With the help of the radar sensor system, the distance warning function can detect obstacles that are in the path of your vehicle for an extended period of time.

Up to a speed of around 44 mph (70 km/h), the distance warning function can also react to stationary obstacles, such as stopped or parked vehicles.

If you approach an obstacle and the distance warning function detects a risk of a collision, the system will initially alert you both visually and acoustically.

### Autonomous braking function

If the driver does not react to the distance warning signal in a critical situation, COLLISION PREVENTION ASSIST PLUS can assist with the autonomous braking function.

The autonomous braking function:

- gives the driver more time to react to critical driving situations
- can help the driver to avoid an accident or
- reduces the effects of an accident

**Vehicles without DISTRONIC PLUS:** the autonomous braking function is available in the following speed ranges:

- 5 - 65 mph (7 - 105 km/h) for moving objects
- 5 - 31 mph (7 - 50 km/h) for stationary objects

**Vehicles with DISTRONIC PLUS:** the autonomous braking function is available in the following speed ranges:

- 5 - 124 mph (7 - 200 km/h) for moving objects
- 5 - 31 mph (7 - 50 km/h) for stationary objects

If the autonomous braking function requires a particularly high braking force, preventative passenger protection measures (PRE-SAFE®) are activated simultaneously.

### Adaptive Brake Assist

- ① Observe the "Important safety notes" section (▷ page 60).

Adaptive Brake Assist provides braking assistance in hazardous situations at speeds above 4 mph (7 km/h). It uses radar sensor technology to assess the traffic situation.

#### WARNING

Adaptive Brake Assist cannot always clearly identify objects and complex traffic situations.

In such cases, Adaptive Brake Assist can:

- intervene unnecessarily
- not intervene

There is a risk of an accident.

Always pay careful attention to the traffic situation and be ready to brake. Terminate the intervention in a non-critical driving situation.

#### WARNING

Adaptive Brake Assist does not react:

- to people or animals
- to oncoming vehicles

- to crossing traffic
- when cornering

As a result, the Adaptive Brake Assist may not intervene in all critical conditions. There is a risk of an accident.

Always pay careful attention to the traffic situation and be ready to brake.

Due to the nature of the system, particularly complicated but non-critical driving conditions may also cause Brake Assist to intervene.

If adaptive Brake Assist is not available due to a malfunction in the radar sensor system, the brake system remains available with full brake boosting effect and BAS.

With the help of adaptive Brake Assist, the distance warning signal can detect obstacles that are in the path of your vehicle for an extended period of time.

If adaptive Brake Assist detects a risk of collision with the vehicle in front, it calculates the braking force necessary to avoid a collision. If you apply the brakes forcefully, adaptive Brake Assist will automatically increase the braking force to a level suitable for the traffic conditions.

- ▶ Keep the brake pedal depressed until the emergency braking situation is over. ABS prevents the wheels from locking.

The brakes will work normally again if:

- you release the brake pedal.
- there is no longer any danger of a collision.
- no obstacle is detected in front of your vehicle.

Adaptive Brake Assist is then deactivated.

If adaptive Brake Assist demands particularly high braking force, preventative passenger protection measures (PRE-SAFE®) are activated simultaneously.

Up to a speed of approximately 155 mph (250 km/h), adaptive Brake Assist is capable of reacting to moving objects that have already been detected as such at least once over the period of observation.

Up to a speed of approximately 44 mph (70 km/h), adaptive Brake Assist reacts to stationary obstacles.

## ESP® (Electronic Stability Program)

### General notes

- i** Observe the "Important safety notes" section (> page 60).

ESP® monitors driving stability and traction, i.e. power transmission between the tires and the road surface.

If ESP® detects that the vehicle is deviating from the direction desired by the driver, one or more wheels are braked to stabilize the vehicle. The engine output is also modified to keep the vehicle on the desired course within physical limits. ESP® assists the driver when pulling away on wet or slippery roads. ESP® can also stabilize the vehicle during braking.

## ETS/4ETS (Electronic Traction System)

- i** Observe the "Important safety notes" section (> page 60).

ETS traction control is part of ESP®. On vehicles with 4MATIC, 4ETS is part of ESP®.

Traction control brakes the drive wheels individually if they spin. This enables you to pull away and accelerate on slippery surfaces, for example if the road surface is slippery on one side. In addition, more drive torque is transferred to the wheel or wheels with traction. Traction control remains active, even if you deactivate ESP®.

### Important safety notes



- i** Observe the "Important safety notes" section (> page 60).

#### WARNING

If ESP® is malfunctioning, ESP® is unable to stabilize the vehicle. Additionally, further driv-

ing safety systems are deactivated. This increases the risk of skidding and an accident. Drive on carefully. Have ESP® checked at a qualified specialist workshop.

ESP® is only deactivated if the  warning lamp is lit continuously.

If the  warning lamp and the  warning lamp are lit continuously, ESP® is not available due to a malfunction.

Observe the information on warning lamps (▷ page 240) and display messages which may be shown in the instrument cluster (▷ page 208).

Only use wheels with the recommended tire sizes. Only then will ESP® function properly.

## Characteristics of ESP®

### General information

If the  ESP® warning lamp goes out before beginning the journey, ESP® is automatically active.

If ESP® intervenes, the  ESP® warning lamp flashes in the instrument cluster.

If ESP® intervenes:

- ▶ Do not deactivate ESP® under any circumstances.
- ▶ Only depress the accelerator pedal as far as necessary when pulling away.
- ▶ Adapt your driving style to suit the prevailing road and weather conditions.

### ECO start/stop function

The ECO start/stop function switches the engine off automatically when the vehicle stops moving. The engine starts automatically when the driver wants to pull away again. ESP® remains in its previously selected status. **Example:** if ESP® was deactivated before the engine was switched off, ESP® remains deactivated when the engine is switched on again.

## Deactivating/activating ESP®

### Important safety notes

You can select between the following states of ESP®:

- ESP® is activated.
- ESP® is deactivated.

### WARNING

If you deactivate ESP®, ESP® no longer stabilizes the vehicle. There is an increased risk of skidding and an accident.

Only deactivate ESP® in the situations described in the following.

It may be best to deactivate ESP® in the following situations:

- when using snow chains
- in deep snow
- on sand or gravel

 Activate ESP® as soon as the situations described above no longer apply. ESP® will otherwise not be able to stabilize the vehicle if the vehicle starts to skid or a wheel starts to spin.

 Avoid spinning the driven wheels for an extended period with ESP® deactivated. You could otherwise damage the drivetrain.

## Deactivating/activating ESP®

You can deactivate or activate ESP® via the on-board computer (▷ page 202).

### ESP® deactivated:

The  ESP® OFF warning lamp in the instrument cluster lights up.

### ESP® activated:

The  ESP® OFF warning lamp in the instrument cluster goes out.

## Characteristics when ESP® is deactivated

If ESP® is deactivated and one or more wheels start to spin, the  ESP® warning lamp in the instrument cluster flashes. In such situations, ESP® will not stabilize the vehicle.

If you deactivate ESP®:

- ESP® no longer improves driving stability.
- engine torque is no longer limited and the drive wheels are able to spin.

The spinning of the wheels results in a cutting action for better traction on loose surfaces.

- traction control is still activated.
- ESP® still provides support when you brake.

### ESP® trailer stabilization

#### General information

If your vehicle/trailer combination begins to swerve, ESP® assists you in this situation. ESP® slows the vehicle down by braking and limiting the engine output until the vehicle/trailer combination has stabilized.

#### Important safety notes

##### WARNING

If road and weather conditions are poor, trailer stabilization will not be able to prevent the vehicle/trailer combination from swerving. Trailers with a high center of gravity can tip over before ESP® can detect this. There is a risk of an accident.

Always adapt your driving style to the prevailing road and weather conditions.

If your vehicle with trailer (vehicle/trailer combination) begins to lurch, you can only stabilize the vehicle/trailer combination by depressing the brake firmly.

ESP® trailer stabilization is active above speeds of about 65 km/h.

ESP® trailer stabilization does not work if ESP® is deactivated or disabled because of a malfunction.

### EBD (electronic brake force distribution)

#### General information

EBD monitors and controls the brake pressure on the rear wheels to improve driving stability while braking.

#### Important safety notes

-  Observe the "Important safety notes" section (▷ page 60).

##### WARNING

If EBD is malfunctioning, the rear wheels can lock, e.g. under full braking. This increases the risk of skidding and an accident.

You should therefore adapt your driving style to the different handling characteristics. Have the brake system checked at a qualified specialist workshop.

Observe information regarding indicator and warning lamps (▷ page 238) as well as display messages (▷ page 210).

### ADAPTIVE BRAKE

ADAPTIVE BRAKE enhances braking safety and offers increased braking comfort. In addition to the braking function, ADAPTIVE BRAKE also has the HOLD function (▷ page 170) and hill start assist (▷ page 138).

### STEER CONTROL

#### General information

STEER CONTROL helps you by transmitting a noticeable steering force to the steering wheel in the direction required for vehicle stabilization.

This steering assistance is provided in particular if:

- both right wheels or both left wheels are on a wet or slippery road surface when you brake.
- the vehicle starts to skid.

### Important safety notes

- ❗ Observe the "Important safety notes" section (▷ page 60).

No steering assistance is provided from STEER CONTROL, if:

- ESP® is malfunctioning.
- the lighting is faulty.

If ESP® is malfunctioning, you will be assisted further by the electrical power steering.

## Protection against theft

### Immobilizer

The immobilizer prevents your vehicle from being started without the correct SmartKey.

- ▶ **To activate with the SmartKey:** remove the SmartKey from the ignition lock.
- ▶ **To activate with KEYLESS-GO start-function or KEYLESS-GO:** switch the ignition off and open the driver's door.
- ▶ **To deactivate:** switch on the ignition.

When leaving the vehicle, always take the SmartKey with you and lock the vehicle. Anyone can start the engine if a valid SmartKey has been left inside the vehicle.

- ❗ The immobilizer is always deactivated when you start the engine.

In the event that the engine cannot be started (yet the vehicle's battery is charged), the system is not operational. Contact an authorized Mercedes-Benz Center or call 1-800-FOR-MERCEdes (in the USA) or 1-800-387-0100 (in Canada).

### ATA (anti-theft alarm system)



- ▶ **To arm:** lock the vehicle with the SmartKey or KEYLESS-GO. Indicator lamp ① flashes. The alarm system is armed after approximately 15 seconds.
- ▶ **To disarm:** unlock the vehicle with the SmartKey or KEYLESS-GO.

or

- ▶ Insert the SmartKey into the ignition lock.

A visual and audible alarm is triggered if the alarm system is armed and you open:

- a door
- the vehicle with the mechanical key
- the tailgate
- the hood

- ▶ **To turn the alarm off with the SmartKey:** press the  or  button on the SmartKey.

The alarm is switched off.

or

- ▶ **Vehicles with KEYLESS-GO start-function or KEYLESS-GO:** remove the Start/Stop button from the ignition lock (▷ page 135).

- ▶ Insert the SmartKey into the ignition lock. The alarm is switched off.

- **To stop the alarm using KEYLESS-GO:**  
grasp the outside door handle. The SmartKey must be outside the vehicle.  
The alarm is switched off.

or

- Press the Start/Stop button on the dashboard. The SmartKey must be inside the vehicle.  
The alarm is switched off.

The alarm is not switched off, even if you close the open door that triggered it, for example.

- i** If the alarm continues for more than 30 seconds, the mbrace emergency call system automatically notifies the Customer Assistance Center. This is done either by text message or data connection. The emergency call system sends the message or data provided that:
- you have subscribed to the mbrace service.
  - the mbrace service has been activated properly.
  - the necessary mobile phone network is available.

Useful information .....	70
SmartKey .....	70
Doors .....	77
Cargo compartment .....	79
Side windows .....	81
Panorama roof with power tilt/ sliding panel .....	85

### Useful information

- i** This Operator's Manual describes all models and all standard and optional equipment of your vehicle available at the time of publication of the Operator's Manual. Country-specific differences are possible. Please note that your vehicle may not be equipped with all features described. This also applies to safety-related systems and functions.
- i** Read the information on qualified specialist workshops (▷ page 24).

### SmartKey

#### Important safety notes

##### WARNING

If children are left unsupervised in the vehicle, they could:

- open the doors, thus endangering other people or road users.
  - get out and disrupt traffic.
  - operate the vehicle's equipment.
- Additionally, children could set the vehicle in motion if, for example, they:
- release the parking brake.
  - shifting the automatic transmission out of park position **P**
  - Start the engine.

There is a risk of an accident and injury.

When leaving the vehicle, always take the SmartKey with you and lock the vehicle. Never leave children or animals unattended in the vehicle. Always keep the SmartKey out of reach of children.

##### WARNING

If you attach heavy or large objects to the SmartKey, the SmartKey could be unintentionally turned in the ignition lock. This could cause the engine to be switched off. There is a risk of an accident.

Do not attach any heavy or large objects to the SmartKey. Remove any bulky key rings before inserting the SmartKey into the ignition lock.

- !** Keep the SmartKey away from strong magnetic fields. Otherwise, the remote control function could be affected. Strong magnetic fields can occur in the vicinity of powerful electrical installations.

Do not keep the SmartKey:



- with electronic devices, e.g. a mobile phone or another SmartKey.
- with metallic objects, e.g. coins or metal foil.
- inside metallic objects, e.g. a metal case.

#### Vehicles with KEYLESS-GO start function:

do not keep the SmartKey in the cargo compartment. Otherwise, the SmartKey may not be detected, e.g. when starting the engine using the Start/Stop button.

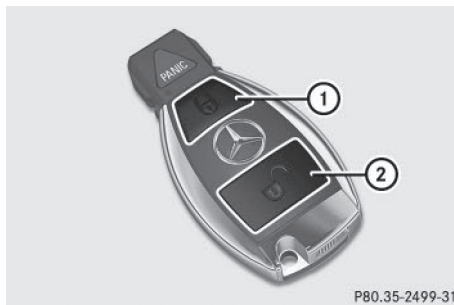
#### SmartKey functions



- ①  To lock the vehicle
- ②  To unlock the vehicle

If you do not open the vehicle within approximately 40 seconds of unlocking, the vehicle will lock again.

If you do not open the vehicle within approximately 40 seconds of unlocking:

- the vehicle is locked again.
- protection against theft is reactivated.

► **To lock centrally:** press button ①.



The SmartKey centrally locks/unlocks:

- the doors
- the tailgate
- the fuel filler flap

The turn signals flash once when unlocking and three times when locking.

- i** When the locator lighting is activated in Audio 20/COMAND, it also lights up when it is dark after the vehicle is unlocked with the remote control (see the separate operating instructions).
- i** You can also set an audible signal to confirm that the vehicle has been locked. The audible signal can be activated and deactivated using the on-board computer (▷ page 205).

## KEYLESS-GO

### General notes

Bear in mind that the engine can be started by any of the vehicle occupants if there is a SmartKey in the vehicle.

### Locking/unlocking centrally

You can start, lock or unlock the vehicle using KEYLESS-GO. To do this, you only need carry the SmartKey with you. You can combine the functions of KEYLESS-GO with those of a conventional SmartKey. Unlock the vehicle by using KEYLESS-GO, for instance, and lock it using the  button on the SmartKey.

The driver's door and the door at which the handle is used, must both be closed. The SmartKey must be outside the vehicle. When locking or unlocking with KEYLESS-GO, the distance between the SmartKey and the corresponding door handle must not be greater than 3 ft (1 m).

A check which periodically establishes a radio connection between the vehicle and the SmartKey determines whether a valid SmartKey is in the vehicle. This occurs, for example:

- when starting the engine
- whilst driving
- when the external door handles are touched
- during convenience closing

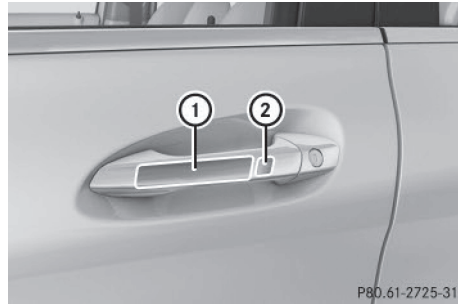

- ▶ **To unlock the vehicle:** touch the inner surface of the door handle.
- ▶ **To lock the vehicle:** touch sensor surface ① or ②.  
Make sure that you do not touch the inner surface of the door handle.
- ▶ **Convenience closing feature:** touch recessed sensor surface ② for an extended period.  
Further information on the convenience closing feature (▷ page 83).



- ▶ **To unlock the tailgate:** pull the tailgate handle.

### Deactivating and activating

If you do not intend to use the vehicle for a longer period of time, you can deactivate KEYLESS-GO. The SmartKey will then use very little power, thereby conserving battery power. For the purposes of activation/deactivation, the vehicle must not be nearby.





- ▶ **To deactivate:** press the  button on the SmartKey twice in rapid succession. The battery check lamp of the SmartKey (▷ page 73) lights up twice briefly and KEYLESS-GO is deactivated.
- ▶ **To activate:** press any button on the SmartKey or insert the SmartKey into the ignition lock. KEYLESS-GO and all of its associated features are available again.

### KEYLESS-GO start function



Bear in mind that the engine can be started by any of the vehicle occupants if there is a SmartKey in the vehicle.

### Changing the settings of the locking system



You can change the settings of the locking system. This means that only the driver's door and the fuel filler flap are unlocked when the vehicle is unlocked. This is useful if you frequently travel on your own.

- ▶ **To change the setting:** simultaneously press the  and  buttons for approximately 6 seconds until the battery check lamp (▷ page 73) flashes twice.
- ❗ If the setting of the locking system is changed within the signal range of the vehicle, pressing the  or  button:
  - locks or
  - unlocks the vehicle

The SmartKey now functions as follows:

- ▶ **To unlock the driver's door:** press the  button once.
- ▶ **To unlock centrally:** press the  button twice.
- ▶ **To lock centrally:** press the  button.

The KEYLESS-GO function is changed as follows:

- ▶ **To unlock the driver's door:** touch the inner surface of the door handle on the driver's door.
- ▶ **To unlock centrally:** touch the inner surface of the door handle on the front-passenger door or the rear door.
- ▶ **To lock centrally:** touch the outer sensor surface on one of the door handles.
- ▶ **To restore the factory settings:** simultaneously press the  and  buttons for approximately 6 seconds until the battery check lamp flashes twice (▷ page 73).



### Mechanical key

#### General notes

If the vehicle can no longer be locked or unlocked with the SmartKey or KEYLESS-GO, use the mechanical key.

If you use the mechanical key to unlock and open the driver's door or the trunk lid, the anti-theft alarm system will be triggered (▷ page 67).

There are several ways to turn off the alarm:

- ▶ **To turn the alarm off with the SmartKey:** press the  or  button on the SmartKey.
- or
- ▶ Insert the SmartKey into the ignition lock.
- or
- ▶ **To deactivate the alarm with KEYLESS-GO:** press the Start/Stop button in the igni-

tion lock. The SmartKey must be in the vehicle.

or

- ▶ Lock or unlock the vehicle using KEYLESS-GO. The SmartKey must be outside the vehicle.

If you unlock the vehicle using the mechanical key, the fuel filler flap will not be unlocked automatically.

- ▶ **To unlock the fuel filler flap:** insert the SmartKey into the ignition lock.

### Removing the mechanical key



- ▶ Push release catch ① in the direction of the arrow and at the same time remove mechanical key ② from the SmartKey.

For further information about:

- unlocking the driver's door (▷ page 78)
- unlocking the cargo compartment (▷ page 80)
- locking the vehicle (▷ page 79)

### Inserting the mechanical key

- ▶ Push mechanical key ② completely into the SmartKey until it engages and release catch ① is back in its basic position.

### SmartKey battery

#### Important safety notes

##### WARNING

Batteries contain toxic and corrosive substances. If batteries are swallowed, it can result in severe health problems. There is a risk of fatal injury.



Keep batteries out of the reach of children. If a battery is swallowed, seek medical attention immediately.



The SmartKey batteries contain perchlorate material, which may require special handling and regard for the environment. National guidelines must be observed during disposal. In California, see [www.dtsc.ca.gov/HazardousWaste/Perchlorate/index.cfm](http://www.dtsc.ca.gov/HazardousWaste/Perchlorate/index.cfm).

Mercedes-Benz recommends that you have the battery replaced at a qualified specialist workshop.

#### Checking the battery



- ▶ Press the  or  button. The battery is working properly if battery check lamp ① lights up briefly. The battery is discharged if battery check lamp ① does not light up briefly.
- ▶ Change the battery (▷ page 74).

**i** If the SmartKey battery is checked within the signal reception range of the vehicle, pressing the  or  button:

- locks or
- unlocks the vehicle

**i** You can get a battery at any qualified specialist workshop.

- ▶ Make sure that the surface of the battery is free of lint, grease and other contaminants.
- ▶ Insert the front tabs of battery tray cover **1** and then press to close it.
- ▶ Insert mechanical key into the SmartKey ([▷ page 73](#)).
- ▶ Check the function of all SmartKey buttons on the vehicle.

### Replacing the battery

You require a CR 2025 3 V cell battery.

- ▶ Take the mechanical key out of the SmartKey ([▷ page 72](#)).

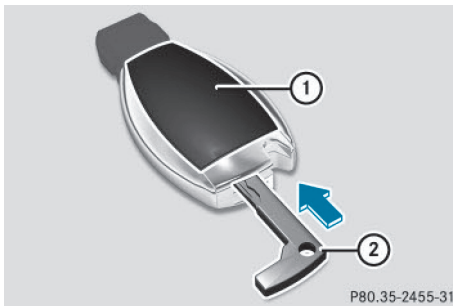



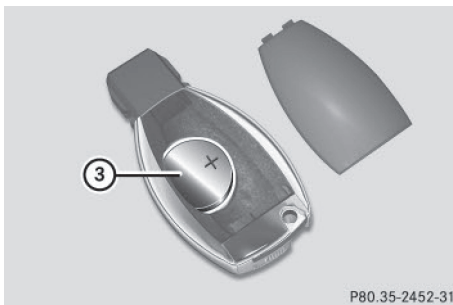

- ▶ Press mechanical key **2** into the opening in the SmartKey in the direction of the arrow until battery tray cover **1** opens. When doing so, do not hold cover **1** shut.
- ▶ Remove battery tray cover **1**.



- ▶ Repeatedly tap the SmartKey against your palm until battery **3** falls out.
- ▶ Insert the new battery with the positive terminal facing upwards. Use a lint-free cloth to do so.

## Problems with the SmartKey

Problem	Possible causes/consequences and ► Solutions
<p>You cannot lock or unlock the vehicle using the SmartKey.</p>	<p>The SmartKey battery is discharged or nearly discharged.</p> <p>► <b>Vehicles without KEYLESS-GO or KEYLESS-GO start function:</b> try again to lock/unlock the vehicle using the remote control function of the SmartKey. Point the tip of the SmartKey at the driver's door handle from close range and press the  or  button.</p> <p>If this does not work:</p> <ul style="list-style-type: none"> <li>► Check the SmartKey battery (▷ page 73) and replace it if necessary (▷ page 74).</li> <li>► Unlock (▷ page 78) or lock (▷ page 79) the vehicle using the mechanical key.</li> </ul> <p>There is interference from a powerful source of radio waves.</p> <p>► <b>Vehicles without KEYLESS-GO or KEYLESS-GO start function:</b> try again to lock/unlock the vehicle using the remote control function of the SmartKey. Point the tip of the SmartKey at the driver's door handle from close range and press the  /  button.</p> <p>If this does not work:</p> <ul style="list-style-type: none"> <li>► Unlock (▷ page 78) or lock (▷ page 79) the vehicle using the mechanical key.</li> </ul> <p>The SmartKey is faulty.</p> <ul style="list-style-type: none"> <li>► Unlock (▷ page 78) or lock (▷ page 79) the vehicle using the mechanical key.</li> <li>► Have the SmartKey checked at a qualified specialist workshop.</li> </ul>
<p>You can no longer lock or unlock the vehicle using KEYLESS-GO.</p>	<p>The SmartKey battery is discharged or nearly discharged.</p> <ul style="list-style-type: none"> <li>► Check the SmartKey battery (▷ page 73) and replace it if necessary (▷ page 74).</li> </ul> <p>If this does not work:</p> <ul style="list-style-type: none"> <li>► Unlock (▷ page 78) or lock (▷ page 79) the vehicle using the mechanical key.</li> </ul> <p>There is interference from a powerful source of radio waves.</p> <ul style="list-style-type: none"> <li>► Unlock (▷ page 78) or lock (▷ page 79) the vehicle using the mechanical key.</li> </ul>

Problem	Possible causes/consequences and ► Solutions
	<p>KEYLESS-GO is malfunctioning.</p> <ul style="list-style-type: none"> <li>► Lock/unlock the vehicle using the remote control function of the SmartKey.</li> <li>► Have the vehicle and SmartKey checked at a qualified specialist workshop.</li> </ul> <p>If the vehicle can also not be locked/unlocked using the remote control function:</p> <ul style="list-style-type: none"> <li>► Unlock (▷ page 78) or lock (▷ page 79) the vehicle using the mechanical key.</li> <li>► Have the vehicle and SmartKey checked at a qualified specialist workshop.</li> </ul>
<p>The engine cannot be started using the SmartKey.</p>	<p>The on-board voltage is too low.</p> <ul style="list-style-type: none"> <li>► Switch off non-essential consumers, e.g. seat heating or interior lighting, and try to start the engine again.</li> </ul> <p>If this does not work:</p> <ul style="list-style-type: none"> <li>► Check the starter battery and charge it if necessary (▷ page 291).</li> </ul> <p>or</p> <ul style="list-style-type: none"> <li>► Jump-start the vehicle (▷ page 293).</li> </ul> <p>or</p> <ul style="list-style-type: none"> <li>► Consult a qualified specialist workshop.</li> </ul>
<p>The engine cannot be started using the Start/Stop button. The SmartKey is in the vehicle.</p>	<p>The vehicle is locked.</p> <ul style="list-style-type: none"> <li>► Unlock the vehicle and try to start the vehicle again.</li> </ul> <p>The SmartKey battery is discharged or nearly discharged.</p> <ul style="list-style-type: none"> <li>► Check the SmartKey battery (▷ page 73) and replace it if necessary (▷ page 74).</li> </ul> <p>If this does not work:</p> <ul style="list-style-type: none"> <li>► Start your vehicle with the SmartKey in the ignition lock.</li> </ul> <p>There is interference from a powerful source of radio waves.</p> <ul style="list-style-type: none"> <li>► Start your vehicle with the SmartKey in the ignition lock.</li> </ul>

Problem	Possible causes/consequences and ► Solutions
You have lost a Smart-Key.	<ul style="list-style-type: none"> <li>► Have the SmartKey deactivated at a qualified specialist workshop.</li> <li>► Report the loss immediately to the vehicle insurers.</li> <li>► If necessary, have the locks changed as well.</li> </ul>
You have lost the mechanical key.	<ul style="list-style-type: none"> <li>► Report the loss immediately to the vehicle insurers.</li> <li>► If necessary, have the locks changed as well.</li> </ul>

## Doors

### Important safety notes

#### **WARNING**

If children are left unsupervised in the vehicle, they could:

- open the doors, thus endangering other people or road users.
- get out and disrupt traffic.
- operate the vehicle's equipment.

Additionally, children could set the vehicle in motion if, for example, they:

- release the parking brake.
- shifting the automatic transmission out of park position **P**
- Start the engine.

There is a risk of an accident and injury.

When leaving the vehicle, always take the SmartKey with you and lock the vehicle. Never leave children or animals unattended in the vehicle. Always keep the SmartKey out of reach of children.

You should preferably place luggage or loads in the cargo compartment. Observe the load-guidelines (► page 248).

### Unlocking and opening doors from the inside

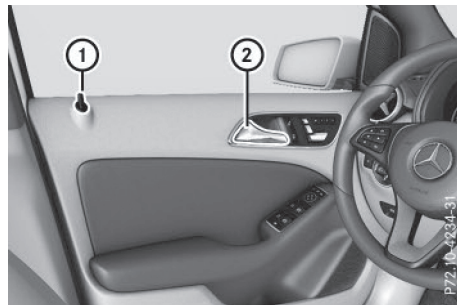

- **To unlock and open a front door:** pull door handle ②.  
If the door is locked, locking knob ① pops up. The door is unlocked and opens.
- **To unlock a rear door:** pull up locking knob ①.  
The door is unlocked and can be opened.
- **To open a rear door:** pull door handle ②.

You can open a door from inside the vehicle even if it has been locked. You can only open the rear doors from inside the vehicle if they are not secured by the child-proof locks (► page 59).

If the vehicle has previously been locked with the SmartKey from the outside, opening a door from the inside will trigger the anti-theft alarm system. Switch off the alarm (► page 67).

### Centrally locking and unlocking the vehicle from the inside

You can centrally lock or unlock the vehicle from the inside. This can be useful if you wish to lock the vehicle before pulling away, for example.

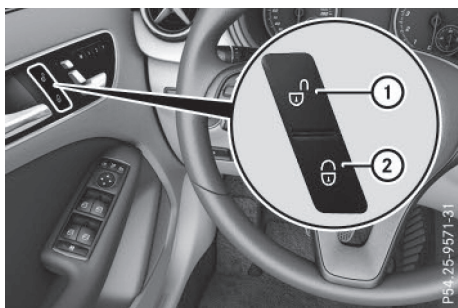

► **To unlock:** press button ①.

► **To lock:** press button ②.

If all the doors and the tailgate are closed, the vehicle locks.

Meanwhile, the fuel filler flap will not be locked or unlocked.

You cannot unlock the vehicle centrally from the inside if the vehicle has been locked with the SmartKey or KEYLESS-GO.

You can open a door from inside the vehicle even if it has been locked. You can open the rear doors from inside the vehicle unless they are secured by the child-proof lock (▷ page 59).

If the vehicle has previously been locked with the SmartKey from the outside, opening a door from the inside will trigger the anti-theft alarm system. Switch off the alarm (▷ page 67).

If a locked door is opened from the inside, the previous unlock status of the vehicle will be taken into consideration if:

- the vehicle was locked using the locking button for the central locking, or
- if the vehicle was locked automatically

The vehicle will be fully unlocked if it had previously been fully unlocked. If only the driver's door had been previously unlocked, only the

door which has been opened from the inside is unlocked.

### Automatic locking feature

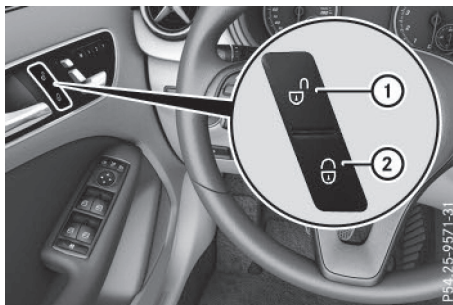

► **To deactivate:** press and hold button ① for about five seconds until a tone sounds.

► **To activate:** press and hold button ② for about five seconds until a tone sounds.

**i** If you press one of the two buttons and do not hear a tone, the relevant setting has already been selected.

The vehicle is locked automatically when the ignition is switched on and the wheels are turning.

You could therefore lock yourself out if:

- the vehicle is being pushed.
- the vehicle is being towed.
- the vehicle is on a roller dynamometer.

You can also switch the automatic locking function on and off using the on-board computer (▷ page 205).

### Unlocking the driver's door (mechanical key)

If the vehicle can no longer be locked or unlocked with the SmartKey or KEYLESS-GO, use the mechanical key.

If you use the mechanical key to unlock and open the driver's door, the anti-theft alarm system will be triggered (▷ page 67).



- ▶ Take the mechanical key out of the SmartKey (▷ page 72).
- ▶ Insert the mechanical key into the lock of the driver's door as far as it will go.

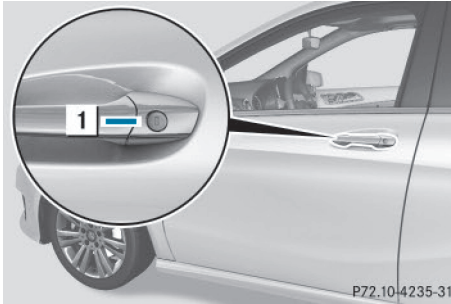

- ▶ Turn the mechanical key counter-clockwise as far as it will go to position **1**. The door is unlocked.
- ▶ Turn the mechanical key back and remove it.
- ▶ Insert mechanical key into the SmartKey (▷ page 73).

### Locking the vehicle (mechanical key)

If the vehicle can no longer be locked with the SmartKey or KEYLESS-GO, use the mechanical key.

- ▶ Open the driver's door.
- ▶ Close the front-passenger door, the rear doors and the tailgate.
- ▶ Press the locking button on the driver's door (▷ page 78).
- ▶ Check whether the locking knobs on the front-passenger door and the rear doors are still visible. Press down the locking knobs by hand, if necessary.
- ▶ Close the driver's door.
- ▶ Take the mechanical key out of the SmartKey (▷ page 72).
- ▶ Insert the mechanical key into the lock of the driver's door as far as it will go.

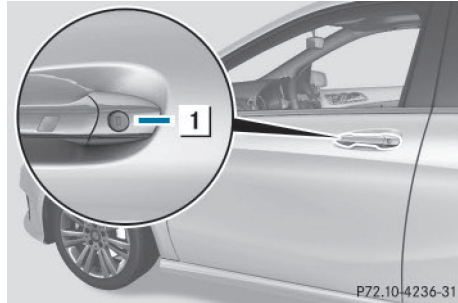

- ▶ Turn the emergency key element clockwise as far as it will go to position **1**.
- ▶ Turn the mechanical key back and remove it.
- ▶ Make sure that the doors and the tailgate are locked.
- ▶ Insert mechanical key into the SmartKey (▷ page 73).

**i** If you lock the vehicle as described above, the fuel filler flap is not locked. The anti-theft alarm system is not armed.

### Cargo compartment

#### Important safety notes

#### **⚠ WARNING**

Combustion engines emit poisonous exhaust gases such as carbon monoxide. If the tailgate is open when the engine is running, particularly if the vehicle is moving, exhaust fumes could enter the passenger compartment. There is a risk of poisoning.

Turn off the engine before opening the tailgate. Never drive with the tailgate open.

#### **⚠ WARNING**

If objects, luggage or loads are not secured or not secured sufficiently, they could slip, tip over or be flung around and thereby hit vehicle occupants. There is a risk of injury, particularly in the event of sudden braking or a sudden change in direction.

Always store objects so that they cannot be flung around. Secure objects, luggage or loads against slipping or tipping before the journey.

**!** The tailgate swings upwards and to the rear when opened. Therefore, make sure that there is sufficient clearance above and behind the tailgate.

**i** The opening dimensions of the tailgate can be found in the "Vehicle data" section (▷ page 341).

You should preferably place luggage or loads in the cargo compartment. Observe the loading guidelines (▷ page 248).

Do not leave the SmartKey in the cargo compartment. You could otherwise lock yourself out.

The tailgate can be:

- opened and closed manually from outside
- released with the emergency release from the inside

### Opening/closing from outside

#### Opening



- ▶ Press the  button on the SmartKey.
- ▶ Pull handle **1**.
- ▶ Raise the tailgate.

#### Closing



- ▶ Pull the tailgate down using handle **1**.
- ▶ Allow the tailgate to drop into the lock.
- ▶ If necessary, lock the vehicle with the  button on the SmartKey or with KEYLESS-GO.

### Tailgate emergency release

#### General notes

**!** The tailgate swings upwards and to the rear when opened. Therefore, make sure that there is sufficient clearance above and behind the tailgate.

**i** The opening dimensions of the tailgate can be found in the "Vehicle data" section (▷ page 341).

If the tailgate can no longer be unlocked:

- using the SmartKey, or
- using the remote operating switch in the door control panel:

Use the emergency release on the inside of the tailgate.

You can reach the emergency release via the cargo compartment.

## Opening

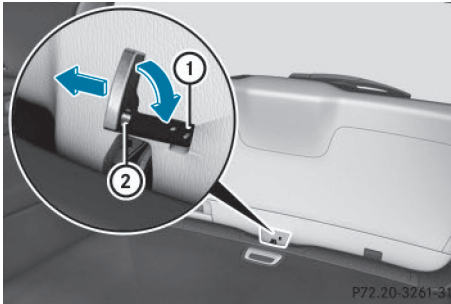

- ▶ Remove cargo compartment cover (▷ page 256).
- ▶ Fold the rear seat backrest forwards (▷ page 252).
- ▶ Take the mechanical key out of the SmartKey (▷ page 72).
- ▶ Insert mechanical key ② into the opening in paneling ①.
- ▶ Turn mechanical key ② 90° clockwise.
- ▶ Push mechanical key ② in the direction of the arrow and open the tailgate.
- ▶ Insert mechanical key into the SmartKey (▷ page 73).

## Side windows

### Important safety notes

#### WARNING

While opening the side windows, body parts could become trapped between the side window and the door frame as the side window moves. There is a risk of injury.

Make sure that nobody touches the side window during the opening procedure. If somebody becomes trapped, release the switch or pull the switch to close the side window again.

#### WARNING

While closing the side windows, body parts in the closing area could become trapped. There is a risk of injury.

When closing make sure that no parts of the body are in the closing area. If somebody becomes trapped, release the switch or press the switch to open the side window again.

#### WARNING

If children operate the side windows they could become trapped, particularly if they are left unsupervised. There is a risk of injury.

Activate the override feature for the rear side windows. When leaving the vehicle, always take the SmartKey with you and lock the vehicle. Never leave children unsupervised in the vehicle.

### Side window reversing feature

The side windows are equipped with an automatic reversing feature. If a solid object blocks or restricts a side window from traveling upwards during the automatic closing process, the side window opens again automatically. During the manual closing process, the side window only opens again automatically after the corresponding switch is released. The automatic reversing feature is only an aid and is no substitute for your attention when closing a side window.

#### WARNING

The reversing feature does not react:

- to soft, light and thin objects, e.g. small fingers
- while resetting

This means that the reversing feature cannot prevent someone being trapped in these situations. There is a risk of injury.

Make sure that no body parts are in close proximity during the closing procedure. If someone becomes trapped, press the switch to open the side window again.

### Opening and closing the side windows

The switches for all side windows are located on the driver's door. There is also a switch on each door for the corresponding side window. The switches on the driver's door take precedence.

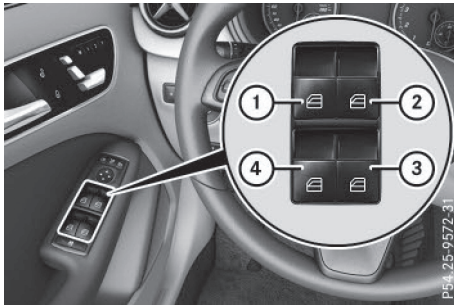

- ① Front left
- ② Front right
- ③ Rear right
- ④ Rear left

- ▶ Turn the SmartKey to position **1** or **2** in the ignition lock (▷ page 135).
- ▶ **To open manually:** press and hold the corresponding switch.
- ▶ **To open fully:** press the switch beyond the point of resistance and release it. Automatic operation is started.
- ▶ **To close manually:** pull the corresponding switch and hold it.
- ▶ **To close fully:** pull the switch beyond the point of resistance and release it. Automatic operation is started.
- ▶ **To interrupt automatic operation:** press/pull the corresponding switch again.
- ❗ If you press/pull the switch beyond the point of resistance, automatic operation is started in the corresponding direction. You can stop automatic operation by pressing/pulling the switch again.
- ❗ You can continue to operate the side windows after you switch off the engine or remove the SmartKey. This function

remains active for five minutes or until the driver's or front-passenger door is opened.



- ❗ When the override feature for the side windows is activated (▷ page 60), the side windows cannot be operated from the rear.

### Convenience opening

**Vehicles with KEYLESS-GO, the KEYLESS-GO start function, Exclusive Package or AMG Exclusive Package:** you can ventilate the vehicle before you start driving.

The SmartKey can also be used to carry out the following functions simultaneously:

- unlock the vehicle
- open the side windows
- open the panorama roof with power tilt/sliding panel and the roller sunblind

- ❗ The convenience opening feature can only be operated using the SmartKey.
- ▶ **Vehicles with Exclusive Package or AMG Exclusive Package but without KEYLESS-GO and the KEYLESS-GO start function:** for the following operations, point the tip of the SmartKey at the door handle on the driver's door. The SmartKey must be close to the driver's door handle.
- ❗ **Vehicles with KEYLESS-GO or the KEYLESS-GO start function:** the SmartKey must be in close proximity to the vehicle.
- ▶ Press and hold the  button until the side windows and the panorama sunroof are in the desired position. If the roller sunblind of the panorama roof with power tilt/sliding panel is closed, the roller sunblind is opened first.
- ▶ Press and hold the  button again until the panorama roof with power tilt/sliding panel is in the desired position.
- ▶ **To interrupt convenience opening:** release the  button.

## Convenience closing feature

### Important safety notes

#### WARNING

When the convenience closing feature is operating, parts of the body could become trapped in the closing area of the side window and the sliding sunroof. There is a risk of injury.

Observe the complete closing procedure when the convenience closing feature is operating. Make sure that no body parts are in close proximity during the closing procedure.

**Vehicles with KEYLESS-GO, the KEYLESS-GO start function, Exclusive Package or AMG Exclusive Package:** at the same time you can:

- lock the vehicle
- close the side windows
- close the panorama roof with power tilt/sliding panel

On vehicles with a panorama roof with power tilt/sliding panel, you can then close the roller sunblind.

 Notes on the automatic reversing feature for:

- the side window (▷ page 81)
- the panorama roof with power tilt/sliding panel (▷ page 86)
- the roller sunblind (▷ page 87)

### Using the SmartKey

▶ **Vehicles with Exclusive Package or AMG Exclusive Package but without KEYLESS-GO and the KEYLESS-GO start function:** for the following operations, point the tip of the SmartKey at the door handle on the driver's door. The SmartKey must be close to the driver's door handle.

 **Vehicles with KEYLESS-GO or the KEYLESS-GO start function:** the SmartKey must be in close proximity to the vehicle.

- ▶ Press and hold the  button until the side windows and the panorama roof with power tilt/sliding panel are fully closed.
- ▶ Make sure that all the side windows and the panorama roof with power tilt/sliding panel are closed.

On vehicles with a panorama roof with power tilt/sliding panel:

- ▶ Press and hold the  button again until the roller sunblind of the panorama sliding sunroof closes.



▶ **To interrupt convenience closing:** release the  button.

### Using KEYLESS-GO

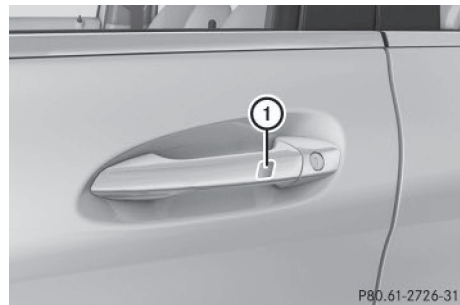
The driver's door and the door at which the handle is used, must both be closed. The SmartKey must be outside the vehicle. The gap between the SmartKey and the corresponding door handle should not be greater than 3 ft (1 m).



▶ Touch recessed sensor surface  on the door handle until the side windows and the panorama roof with power tilt/sliding panel are fully closed.

 Make sure you only touch recessed sensor surface .

▶ Make sure that all the side windows are closed.

▶ Make sure that all the side windows and the panorama roof with power tilt/sliding panel are closed.

On vehicles with a panorama roof with power tilt/sliding panel:

- ▶ Touch recessed sensor surface ① on the door handle again until the roller sunblind of the panorama sliding sunroof closes.
- ▶ **To interrupt convenience closing:** release recessed sensor surface ① on the door handle.

### Resetting the side windows

If a side window can no longer be closed fully, you must reset it.

- ▶ Close all the doors.
- ▶ Turn the SmartKey to position **1** or **2** in the ignition lock (▷ page 135).
- ▶ Pull the corresponding switch on the door control panel until the side window is completely closed (▷ page 82).
- ▶ Hold the switch for an additional second.

If the side window opens again slightly:

- ▶ Immediately pull the corresponding switch on the door control panel until the side window is completely closed (▷ page 82).
- ▶ Hold the switch for an additional second.
- ▶ If the respective side window remains closed after the button is released, then it has been set correctly. If this is not the case, repeat the steps above again.

**Problems with the side windows****⚠ WARNING**

If you close a side window again immediately after it has been blocked or reset, the side window closes with increased or maximum force. The reversing feature is then not active. Parts of the body could be trapped in the closing area in the process. This poses an increased risk of injury or even fatal injury.

Make sure that no parts of the body are in the closing area. To stop the closing process, release the switch or push the switch again to reopen the side window.

Problem	Possible causes/consequences and ► Solutions
A side window cannot be closed because it is blocked by objects, e.g. leaves in the window guide.	<ul style="list-style-type: none"> <li>► Remove the objects.</li> <li>► Close the side window.</li> </ul>
A side window cannot be closed and you cannot see the cause.	<p>If a side window is obstructed during closing and reopens again slightly:</p> <ul style="list-style-type: none"> <li>► Immediately after the window blocks, pull the corresponding switch again until the side window has closed. The side window is closed with increased force.</li> </ul> <p>If a side window is obstructed again during closing and reopens again slightly:</p> <ul style="list-style-type: none"> <li>► Immediately after the window blocks, pull the corresponding switch again until the side window has closed. The side window is closed without the anti-entrapment feature.</li> </ul>

**Panorama roof with power tilt/sliding panel****Important safety notes**

In the following section, the term "sliding sunroof" refers to the panorama roof with power tilt/sliding panel.

**⚠ WARNING**

While opening and closing the sliding sunroof, body parts in close proximity could become trapped. There is a risk of injury.

Make sure that no body parts are in close proximity during the opening and closing procedures.

If somebody becomes trapped:

- release the switch immediately, or
- during automatic operation, push the switch briefly in any direction

The opening or closing procedure will be stopped.

**⚠ WARNING**

If children operate the sliding sunroof they could become trapped, particularly if they are left unsupervised. There is a risk of injury.

When leaving the vehicle, always take the SmartKey with you and lock the vehicle. Never leave children unsupervised in the vehicle.

**!** Only open the sliding sunroof if it is free of snow and ice. Otherwise, malfunctions may occur.

Do not allow anything to protrude from the sliding sunroof. Otherwise, the seals could be damaged.

**!** The weather can change abruptly. It could start to rain or snow. Make sure that the sliding sunroof is closed when you leave the vehicle. The vehicle electronics can be damaged if water enters the vehicle interior.

**i** Resonance noises can occur in addition to the usual airflow noises when the sliding sunroof is open. They are caused by minor pressure fluctuations in the vehicle interior. Change the position of the sliding sunroof or open a side window slightly to reduce or eliminate these noises.

### Sliding sunroof reversing feature

The sliding sunroof is equipped with an automatic reversing feature. If a solid object blocks or restricts the sliding sunroof during the closing process, the sliding sunroof opens again automatically. However, the automatic reversing feature is only an aid and does not relieve you of the responsibility of paying attention when closing the sliding sunroof.

#### **⚠ WARNING**

The reversing feature does not react:

- to soft, light and thin objects, e.g. small fingers
- over the last 1/6 in (4 mm) of the closing movement
- during resetting
- when closing the sliding sunroof again manually immediately after automatic reversing

This means that the reversing feature cannot prevent someone being trapped in these situations. There is a risk of injury.

Make sure that no body parts are in close proximity during the closing procedure.

If somebody becomes trapped:

- release the switch immediately, or
- during automatic operation, push the switch briefly in any direction

The closing process is stopped.

### Operating the sliding sunroof

#### Opening and closing



Overhead control panel

- ① To raise
- ② To open
- ③ To close/lower

► Turn the SmartKey to position **1** or **2** in the ignition lock (▷ page 135).

► Make sure that the roller sunblind is open.

► Press or pull the  switch in the corresponding direction.

**i** If you press/pull the  switch beyond the point of resistance, automatic operation is started in the corresponding direction. You can stop automatic operation by pressing/pulling the switch again.

**i** After opening the sliding sunroof, the roller sunblind closes slightly automatically. This reduces drafts in the vehicle interior.

**i** You can continue to operate the sliding sunroof after switching off the engine or removing the SmartKey from the ignition lock. This function remains active for five minutes or until you open a front door.



**i** The sliding sunroof cannot be opened if a roof carrier is installed. In order to allow ventilation of the vehicle interior, you can raise the sliding sunroof.

If contact is made with a roof carrier approved by Mercedes-Benz, the sliding sunroof lowers slightly but remains raised at the rear.

### Rain-closing feature

The rain-closing feature is only available for vehicles with a rain sensor.

When the SmartKey is in position **0** in the ignition lock or is removed, the sliding sunroof closes automatically:

- if it starts to rain
- at extreme outside temperatures
- after six hours
- if there is a malfunction in the power supply

The sliding sunroof remains raised at the rear in order to allow ventilation of the vehicle interior.

**i** If the sliding sunroof is obstructed while being closed by the rain-closing feature, it opens again slightly. The rain-closing feature is then deactivated.

The sliding sunroof does not close if:

- it is raised at the rear.
- it is blocked.
- no rain is falling on the area of the windshield being monitored by the rain sensor, e.g. because the vehicle is under a bridge.

### Operating the roller sunblind for the sliding sunroof

#### Important safety notes

##### **WARNING**

When opening or closing the roller sunblind, parts of the body could be trapped between the roller sunblind and the frame or sliding sunroof. There is a risk of injury.

When opening or closing make sure that no parts of the body are in the sweep of the roller sunblind.

If somebody becomes trapped:

- release the switch immediately, or
- during automatic operation, push the switch briefly in any direction

The opening or closing procedure will be stopped.

The roller sunblind shields the vehicle interior from sunlight. The roller sunblind can only be opened and closed when the sliding sunroof is closed.

### Roller sunblind reversing feature

The roller sunblind is equipped with an automatic reversing feature. If a solid object blocks or restricts the roller sunblind during the closing process, the roller sunblind opens again automatically. The automatic reversing feature is only an aid and is not a substitute for your attentiveness to the roller sunblind while it is closing.

##### **WARNING**

The reversing feature does not react:

- to soft, light and thin objects, e.g. small fingers
- when closing the roller sunblind again manually immediately after automatic reversing

This means that the reversing feature cannot prevent someone being trapped in these situations. There is a risk of injury.

When closing make sure that no parts of the body are in the sweep of the roller sunblind.

If somebody becomes trapped:

- release the switch immediately, or
- during automatic operation, push the switch briefly in any direction

The closing process is stopped.

### Opening and closing



Overhead control panel

- ① To open
- ② To open
- ③ To close



- ▶ Turn the SmartKey to position **1** or **2** in the ignition lock (▷ page 135).
- ▶ Press or pull the  switch in the corresponding direction.



**i** If you press/pull the  switch beyond the point of resistance, automatic operation is started in the corresponding direction. You can stop automatic operation by pressing/pulling the switch again.

**i** After opening the sliding sunroof, the roller sunblind closes slightly automatically. This reduces drafts in the vehicle interior.

### Resetting the sliding sunroof and the roller sunblind

Reset the sliding sunroof and the roller sunblind if the sliding sunroof or the roller sunblind does not move smoothly:

- ▶ Turn the SmartKey to position **1** or **2** in the ignition lock (▷ page 135).
- ▶ Pull the  switch repeatedly to the point of resistance in the direction of arrow **③** until the sliding sunroof is fully closed.
- ▶ Keep the  switch pulled for an additional second.



- ▶ Pull the  switch repeatedly to the point of resistance in the direction of arrow **③** until the roller sunblind is fully closed.
- ▶ Keep the  switch pulled for an additional second.
- ▶ Make sure that the sliding sunroof (▷ page 86) and the roller sunblind (▷ page 88) can be fully opened and closed again.
- ▶ If this is not the case, repeat the steps above again.

**Problems with the sliding sunroof** **WARNING**

If you do not reset the sliding sunroof after a malfunction or voltage supply interruption, then the backing up function will malfunction or not work. The sliding sunroof closes with increased or maximum force. Parts of the body could be trapped in the closing area in the process. This poses an increased risk of injury or even fatal injury.

In such or similar situations always make sure that no parts of the body are in the closing area. Always reset the sliding sunroof after a malfunction or voltage supply interruption.

-  If the sliding sunroof still cannot be opened or closed as a result of a malfunction, contact a qualified specialist workshop.

Problem	Possible causes/consequences and ► Solutions
The sliding sunroof cannot be closed and you cannot see the cause.	<p>If the sliding sunroof is obstructed during closing and reopens again slightly:</p> <ul style="list-style-type: none"> <li>► Immediately after it blocks, pull the  switch down again to the point of resistance until the sliding sunroof is closed. The sliding sunroof is closed with increased force.</li> </ul> <p>If the sliding sunroof is obstructed again during closing and then reopens slightly:</p> <ul style="list-style-type: none"> <li>► Immediately after it blocks, pull the  switch down again to the point of resistance until the sliding sunroof is closed. The sliding sunroof is closed without the anti-entrapment feature.</li> </ul>



Useful information .....	92
Correct driver's seat position .....	92
Seats .....	93
Steering wheel .....	97
Mirrors .....	98
Memory function .....	101

## Useful information

- i** This Operator's Manual describes all models and all standard and optional equipment of your vehicle available at the time of publication of the Operator's Manual. Country-specific differences are possible. Please note that your vehicle may not be equipped with all features described. This also applies to safety-related systems and functions.
- i** Read the information on qualified specialist workshops (▷ page 24).

## Correct driver's seat position

**⚠ WARNING**

You could lose control of your vehicle if you do the following while driving:

- adjust the driver's seat, head restraint, steering wheel or mirrors
- fasten the seat belt

There is a risk of an accident.

Adjust the driver's seat, head restraint, steering wheel and mirror and fasten your seat belt before starting the engine.



P9 148-3464-31

- ▶ Observe the safety guidelines on seat adjustment (▷ page 93).
  - ▶ Make sure that seat ③ is adjusted properly.
    - Manual seat adjustment (▷ page 94)
    - Electrical seat adjustment (▷ page 94)
- When adjusting the seat, make sure that:
- you are as far away from the driver's air bag as possible
  - you are sitting in a normal upright position
  - you can fasten the seat belt properly
  - you have moved the backrest to an almost vertical position
  - you have set the seat cushion angle so that your thighs are gently supported
  - you can depress the pedals properly
- ▶ Check whether the head restraint is adjusted properly (▷ page 94).

When doing so, make sure that you have adjusted the head restraint so that the back of your head is supported at eye level by the center of the head restraint.

- ▶ Observe the safety notes on steering column adjustment (▷ page 97).
- ▶ Make sure that steering wheel ① is adjusted properly.

Adjusting the steering wheel (▷ page 97)

When adjusting the steering wheel, make sure that:

- you can hold the steering wheel with your arms slightly bent
  - you can move your legs freely
  - you can see all the displays in the instrument cluster clearly
- ▶ Observe the safety guidelines for seat belts (▷ page 40).
  - ▶ Check whether you have fastened seat belt ② properly (▷ page 42).

The seat belt should:

- fit snugly across your body
  - be routed across the middle of your shoulder
  - be routed in your pelvic area across the hip joints
- ▶ Before starting off, adjust the rear-view mirror and the exterior mirrors (▷ page 98) in such a way that you have a good view of road and traffic conditions.
- ▶ **Vehicles with a memory function:** save the seat and exterior mirror settings (▷ page 101).

## Seats

### Important safety notes

#### WARNING

Children could become trapped if they adjust the seats, particularly when unattended. There is a risk of injury.

When leaving the vehicle, always take the SmartKey with you and lock the vehicle. Never leave children unsupervised in the vehicle.

The seats can still be adjusted when there is no SmartKey in the ignition lock.

#### WARNING

When you adjust a seat, you or other vehicle occupants could become trapped, e.g. on the seat guide rail. There is a risk of injury.

Make sure when adjusting a seat that no one has any body parts in the sweep of the seat.

Observe the safety notes on "Air bags" (▷ page 44) and "Children in the vehicle" (▷ page 54).

#### WARNING

If the driver's seat is not engaged, it could move unexpectedly while the vehicle is in motion. This could cause you to lose control of the vehicle. There is a risk of an accident.

Always make sure that the driver's seat is engaged before starting the vehicle.

#### WARNING

You could lose control of your vehicle if you do the following while driving:

- adjust the driver's seat, head restraint, steering wheel or mirrors
- fasten the seat belt

There is a risk of an accident.

Adjust the driver's seat, head restraint, steering wheel and mirror and fasten your seat belt before starting the engine.

#### WARNING

If you adjust the seat height carelessly, you or other vehicle occupants could be trapped and thereby injured. Children in particular could accidentally press the electrical seat adjustment buttons and become trapped. There is a risk of injury.

While moving the seats, make sure that your hands or other body parts do not get under the lever assembly of the seat adjustment system.

 To avoid damage to the seats and the seat heating, observe the following information:

- keep liquids from spilling on the seats. If liquid is spilled on the seats, dry them as soon as possible.
- if the seat covers are damp or wet, do not switch on the seat heating. The seat heating should also not be used to dry the seats.
- clean the seat covers as recommended; see the "Interior care" section.
- do not transport heavy loads on the seats. Do not place sharp objects on the seat cushions, e.g. knives, nails or tools. The seats should only be occupied by passengers, if possible.
- when the seat heating is in operation, do not cover the seats with insulating mate-

rials, e.g. blankets, coats, bags, seat covers, child seats or booster seats.

- ❗ Make sure that there are no objects in the footwell under or behind the seats when moving the seats back. There is a risk that the seats and/or the objects could be damaged.

➤ Further related subjects:

- cargo compartment enlargement (folding down the rear seats) (▷ page 252)

### Adjusting the seats manually

#### Seat fore-and-aft adjustment



- ▶ Lift handle ① and slide the seat forwards or backwards.
- ▶ Release lever ② again. Make sure that you hear the seat engage in position.

#### Backrest angle

- ▶ Relieve the pressure on the backrest.
- ▶ Turn handwheel ④ forwards or backwards.

#### Seat height

- ▶ Pull handle ③ upwards or push it down repeatedly until the seat has reached the desired height.

#### Seat cushion angle

Adjust the angle so that your thighs are lightly supported.

- ▶ Turn handwheel ② forwards or backwards.

#### Adjusting the seats electrically

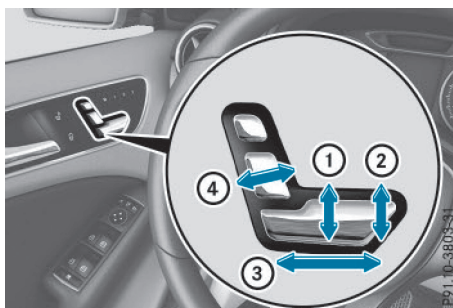

- ① Seat height
- ② Seat cushion angle
- ③ Seat fore-and-aft adjustment
- ④ Backrest angle

- You can store the seat settings using the memory function (▷ page 101).

#### Adjusting the head restraints

#### Important safety notes

##### ⚠ WARNING

You could lose control of your vehicle if you do the following while driving:

- adjust the driver's seat, head restraint, steering wheel or mirrors
- fasten the seat belt

There is a risk of an accident.

Adjust the driver's seat, head restraint, steering wheel and mirror and fasten your seat belt before starting the engine.

##### ⚠ WARNING

If head restraints are not installed and adjusted correctly, they cannot provide protection as intended. There is an increased risk of



injury in the head and neck area, e.g. in the event of an accident or when braking. Always drive with the head restraints installed. Before driving off, make sure for every vehicle occupant that the center of the head restraint supports the back of the head at about eye level.

Using the fore-and-aft adjustment, adjust the head restraint so that it is as close as possible to your head.

### Adjusting the head restraints manually

#### Adjusting the head restraint height

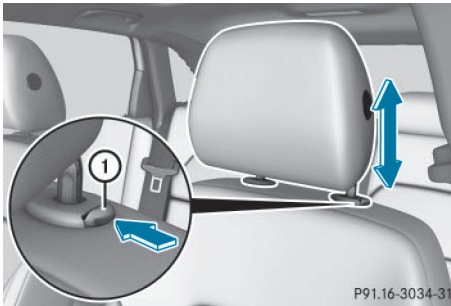

P91.16-3034-31

- ▶ **To raise:** pull the head restraint up to the desired position.
- ▶ **To lower:** press release catch ① in the direction of the arrow and push the head restraint down to the desired position.

#### Adjusting the fore/aft position of the head restraint

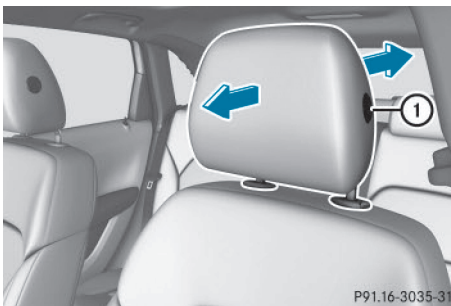

P91.16-3035-31

With this function you can adjust the distance between the head restraint and the back of the seat occupant's head.

- ▶ **To move forwards:** pull the head restraint forwards in the direction of the arrow until it engages. There are several notches.
- ▶ **To move backwards:** press and hold release button ① and push the head restraint backwards.
- ▶ When the head restraint is in the desired position, release the button and make sure that the head restraint is engaged in position.

#### Rear seat head restraints

##### Adjusting the rear seat head restraint height

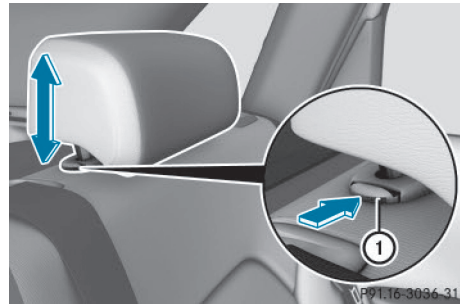

P91.16-3036-31

- ▶ **To raise:** pull the head restraint up to the desired position.
- ▶ **To lower:** press release catch ① and push the head restraint down until it is in the desired position.

#### Adjusting the 4-way lumbar support

You can adjust the contour of the front seat backrests individually to provide optimum support for your back.

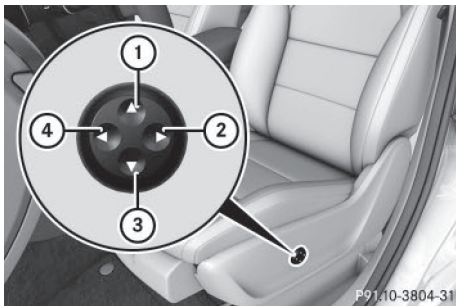

- ① To raise the backrest contour
- ② To soften the backrest contour
- ③ To lower the backrest contour
- ④ To harden the backrest contour

#### Switching the seat heating on/off

##### Switching on/off

#### WARNING

Repeatedly switching on the seat heating can cause the seat cushion and backrest pads to become very hot. The health of persons with limited temperature sensitivity or a limited ability to react to excessively high temperatures may be affected or they may even suffer burn-like injuries. There is a risk of injury.

Therefore, do not switch the seat heating on repeatedly.



The three red indicator lamps in the button indicate the heating level you have selected.

The system automatically switches down from level 3 to level 2 after approximately eight minutes.

The system automatically switches down from level 2 to level 1 after approximately ten minutes.

The system automatically switches off approximately 20 minutes after it is set to level 1.

- ▶ Turn the SmartKey to position 1 or 2 in the ignition lock (▷ page 135).
- ▶ **To switch on:** press button ① repeatedly until the desired heating level is set.
- ▶ **To switch off:** press button ① repeatedly until all the indicator lamps go out.

**i** If the battery voltage is too low, the seat heating may switch off.

## Problems with the seat heating

Problem	Possible causes/consequences and ► Solutions
The seat heating has switched off prematurely or cannot be switched on.	<p>The on-board voltage is too low because too many electrical consumers are switched on.</p> <p>► Switch off electrical consumers that you do not need, such as the rear window defroster or interior lighting.</p> <p>Once the battery is sufficiently charged, the seat heating will switch back on automatically.</p>

## Steering wheel

### Important safety notes

#### WARNING

You could lose control of your vehicle if you do the following while driving:

- adjust the driver's seat, head restraint, steering wheel or mirrors
- fasten the seat belt

There is a risk of an accident.

Adjust the driver's seat, head restraint, steering wheel and mirror and fasten your seat belt before starting the engine.

#### WARNING

Children could injure themselves if they adjust the steering wheel. There is a risk of injury.

When leaving the vehicle, always take the SmartKey with you and lock the vehicle. Never leave children unsupervised in the vehicle.

### Adjusting the steering wheel

#### WARNING

If the steering wheel is unlocked while the vehicle is in motion, it could change position unexpectedly. This could cause you to lose control of the vehicle. There is a risk of an accident.

Before starting off, make sure the steering wheel is locked. Never unlock the steering wheel while the vehicle is in motion.

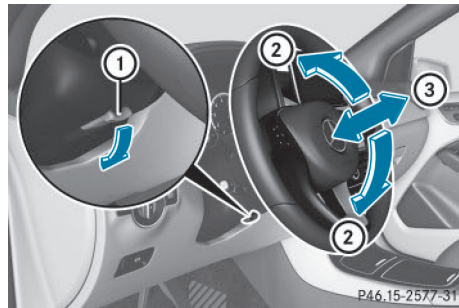

① Release lever

② To adjust the steering wheel height

③ To adjust the steering wheel position (fore-and-aft adjustment)

- Push release lever ① down completely. The steering column is unlocked.
- Adjust the steering wheel to the desired position.
- Push release lever ① up completely. The steering column is locked.
- Check if the steering column is locked. When doing so, try to push the steering wheel up or down or try to move it in the fore-and-aft direction.

## Mirrors

### Rear-view mirror



- ▶ **Anti-glare mode:** flick anti-glare lever ① forwards or back.

### Exterior mirrors

#### Adjusting the exterior mirrors

##### **WARNING**

You could lose control of your vehicle if you do the following while driving:

- adjust the driver's seat, head restraint, steering wheel or mirrors
- fasten the seat belt

There is a risk of an accident.

Adjust the driver's seat, head restraint, steering wheel and mirror and fasten your seat belt before starting the engine.

##### **WARNING**

The exterior mirror on the front-passenger side reduces the size of the image. Visible objects are actually closer than they appear. This means that you could misjudge the distance from road users traveling behind, e.g. when changing lane. There is a risk of an accident.

For this reason, always make sure of the actual distance from the road users traveling behind by glancing over your shoulder.

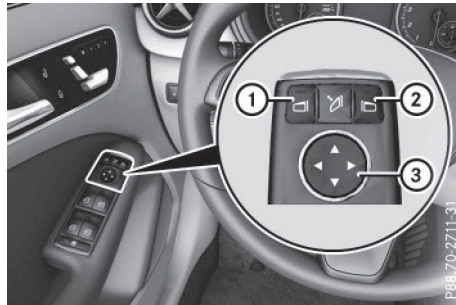

- ▶ Turn the SmartKey to position 1 or 2 in the ignition lock (▷ page 135).
- ▶ Press button ① for the left-hand exterior mirror or button ② for the right-hand exterior mirror. The indicator lamp in the corresponding button lights up in red. The indicator lamp goes out again after some time. You can adjust the selected mirror using adjustment button ③ as long as the indicator lamp is lit.
- ▶ Press adjustment button ③ up, down, or to the left or right until you have adjusted the exterior mirror to the correct position. You should have a good overview of traffic conditions.

The convex exterior mirrors provide a larger field of vision.

After the engine has been started, the exterior mirrors are automatically heated at low outside temperatures. Heating takes a maximum of ten minutes.

- i** You can also heat up the exterior mirrors manually by switching on the rear window defroster.

#### Folding the exterior mirrors in or out electrically

This function is only available in Canada.



- ▶ Turn the SmartKey to position **1** or **2** in the ignition lock (▷ page 135).
  - ▶ Briefly press button **1**.  
Both exterior mirrors fold in or out.
- i** Make sure that the exterior mirrors are always folded out fully while driving. They could otherwise vibrate.
- i** If you are driving faster than 30 mph (47 km/h), you can no longer fold in the exterior mirrors.

### Setting the exterior mirrors

This function is only available in Canada.

If the battery has been disconnected or completely discharged, the exterior mirrors must be reset. The exterior mirrors will otherwise not fold in when you select the "Fold in mirrors when locking" function in the on-board computer (▷ page 206).

- ▶ Turn the SmartKey to position **1** in the ignition lock (▷ page 135).
- ▶ Briefly press button **1**.

### Folding the exterior mirrors in or out automatically

This function is only available in Canada.

If the "Fold in mirrors when locking" function is activated in the on-board computer (▷ page 206):

- the exterior mirrors fold in automatically as soon as you lock the vehicle from the outside.
- the exterior mirrors fold out again automatically as soon as you unlock the vehicle and then open the driver's or front-passenger door.

**i** If the exterior mirrors have been folded in manually, they do not fold out.

### Exterior mirror pushed out of position

If an exterior mirror has been pushed out of position, proceed as follows:

- ▶ **Vehicles without electrically folding exterior mirrors:** move the exterior mirror into the correct position manually.
- ▶ **Vehicles with electrically folding exterior mirrors:** press and hold mirror-folding button (▷ page 98) until you hear a click and then the mirrors engage in position. The mirror housing is engaged again and you can adjust the exterior mirrors as usual (▷ page 98).

### Automatic anti-glare mirrors

#### **⚠ WARNING**

Electrolyte may escape if the glass in an automatic anti-glare mirror breaks. The electrolyte is harmful and causes irritation. It must not come into contact with your skin, eyes, respiratory organs or clothing or be swallowed. There is a risk of injury.

If you come into contact with the electrolyte, observe the following:

- Rinse off the electrolyte from your skin immediately with water.
- Immediately rinse the electrolyte out of your eyes thoroughly with clean water.
- If the electrolyte is swallowed, immediately rinse your mouth out thoroughly. Do not induce vomiting.

- If electrolyte comes into contact with your skin or hair or is swallowed, seek medical attention immediately.
- Immediately change out of clothing which has come into contact with electrolyte.
- If an allergic reaction occurs, seek medical attention immediately.

The "Automatic anti-glare mirrors" function is only available if the vehicle is equipped with the "Mirrors package".

The rear-view mirror and the exterior mirror on the driver's side automatically go into anti-glare mode if:

- the ignition is switched on and
- incident light from headlamps strikes the sensor in the rear-view mirror

The mirrors do not go into anti-glare mode if reverse gear is engaged or the interior lighting is switched on.

#### Parking position for the exterior mirror on the front-passenger side

##### General notes

The "Parking position of the exterior mirror on the front-passenger side" function is only available if the vehicle is equipped with the "Mirrors package".

##### Setting and storing the parking position

###### Using reverse gear

You can position the front-passenger side exterior mirror in such a way that you can see the rear wheel on that side as soon as you engage reverse gear. You can store this position.

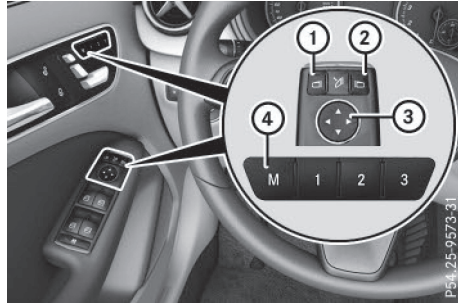

- ① Button for the driver's side exterior mirror
- ② Button for the front-passenger side exterior mirror
- ③ Adjustment button
- ④ Memory button **M**

- ▶ Make sure that the vehicle is stationary.
  - ▶ Turn the SmartKey to position **2** in the ignition lock (▷ page 135).
  - ▶ Press button ② for the exterior mirror on the front-passenger side.
  - ▶ Engage reverse gear.
    - The exterior mirror on the front-passenger side moves to the preset parking position.
  - ▶ Use adjustment button ③ to adjust the exterior mirror. You should see the rear wheel and the curb in the exterior mirror. The parking position is stored.
- i** If you shift the transmission to another position, the exterior mirror on the front-passenger side returns to the driving position.

###### Using the memory button

You can position the front-passenger side exterior mirror in such a way that you can see the rear wheel on that side as soon as you engage reverse gear. This setting can be stored using memory button **M** ④.

- ▶ Make sure that the vehicle is stationary.
- ▶ Turn the SmartKey to position **2** in the ignition lock (▷ page 135).
- ▶ Press button ② for the exterior mirror on the front-passenger side.

- ▶ Use adjustment button ③ to adjust the exterior mirror. You should see the rear wheel and the curb in the exterior mirror.
- ▶ Press memory button **M** ④ and one of the arrows on adjustment button ③ within three seconds.  
The parking position is stored if the exterior mirror does not move.
- ▶ If the mirror moves out of position, repeat the steps.

### Calling up a stored parking position setting

- ▶ Turn the SmartKey to position **2** in the ignition lock (▷ page 135).
- ▶ Adjust the exterior mirror on the front-passenger side with the corresponding button (▷ page 98).
- ▶ Engage reverse gear.

The exterior mirror on the front-passenger side moves to the stored parking position.

The exterior mirror on the front-passenger side moves back to its original position:

- as soon as you exceed a speed of 9 mph (15 km/h)
- about ten seconds after you have disengaged reverse gear
- if you press button ① for the exterior mirror on the driver's side

## Memory function

### Important safety notes

#### WARNING

If you use the memory function on the driver's side while driving, you could lose control of the vehicle as a result of the adjustments being made. There is a risk of an accident.

Only use the memory function on the driver's side when the vehicle is stationary.

#### WARNING

When the memory function adjusts the seat, you and other vehicle occupants – particularly children – could become trapped. There is a risk of injury.

While the memory function is making adjustments, make sure that no one has any body parts in the sweep of the seat. If somebody becomes trapped, immediately release the memory function position button. The adjustment process is stopped.

#### WARNING

Children could become trapped if they activate the memory function, particularly when unattended. There is a risk of injury.

When leaving the vehicle, always take the SmartKey with you and lock the vehicle. Never leave children unsupervised in the vehicle.

The memory function can be used at any time, e.g. even when the SmartKey isn't in the ignition lock.

### Storing settings

With the memory function, you can store up to three different settings, e.g. for three different people.

The following settings are stored as a single memory preset:

- seat and backrest position
- driver's side: position of the exterior mirrors on the driver's and front-passenger sides



- ▶ Adjust the seat (▷ page 94).
- ▶ Adjust the exterior mirror on the driver's side (▷ page 98).
- ▶ Briefly press the **M** memory button and then press storage position button **1**, **2** or **3** within three seconds.

The settings are stored in the selected preset position. A tone sounds when the settings have been completed.

#### Calling up a stored setting

- ▶ Press and hold the relevant preset position button **1**, **2** or **3** until the seat and exterior mirrors are in the stored position.
- i** The setting procedure is interrupted as soon as you release the storage position button.



Useful information .....	104
Exterior lighting .....	104
Interior lighting .....	108
Replacing bulbs .....	109
Windshield wipers .....	114

### Useful information

- i** This Operator's Manual describes all models and all standard and optional equipment of your vehicle available at the time of publication of the Operator's Manual. Country-specific differences are possible. Please note that your vehicle may not be equipped with all features described. This also applies to safety-related systems and functions.
- i** Read the information on qualified specialist workshops (▷ page 24).

### Exterior lighting

#### General notes

For reasons of safety, Mercedes-Benz recommends that you drive with the lights switched on even during the daytime. In some countries, operation of the headlamps varies due to legal requirements and self-imposed obligations.

#### Setting the exterior lighting

##### Setting options

Exterior lighting can be set using:

- the light switch
- the combination switch (▷ page 106)

### Light switch

#### Operation

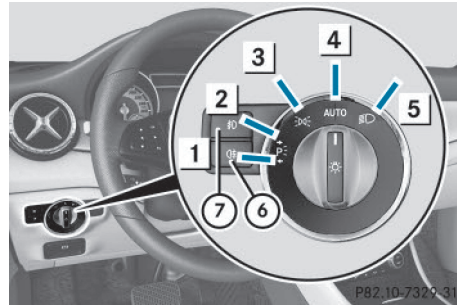

- 1** Left-hand standing lamps
- 2** Right-hand standing lamps
- 3** Parking lamps, license plate and instrument cluster lighting
- 4** **AUTO** Automatic headlamp mode, controlled by the light sensor
- 5** Low-beam/high-beam headlamps
- 6** Rear fog lamp
- 7** Fog lamp (only vehicles with front fog lamps)

If you hear a warning tone when you leave the vehicle, the lights may still be switched on.

- ▶ Turn the light switch to **AUTO**.

The exterior lighting (except the parking/standing lamps) switches off automatically if you:

- remove the SmartKey from the ignition lock
- open the driver's door with the SmartKey in position **0**

#### Automatic headlamp mode

**AUTO** is the favored light switch setting. The light setting is automatically selected according to the brightness of the ambient light (exception: poor visibility due to weather conditions such as fog, snow or spray):

- SmartKey in position **1** in the ignition lock: the parking lamps are switched on or off

automatically depending on the brightness of the ambient light.

- With the engine running: if you have activated the "Daytime running lamps" function via the on-board computer, the daytime running lamps or the parking lamps and the low-beam headlamps are switched on or off automatically depending on the brightness of the ambient light.

► **To switch on automatic headlamp mode:** turn the light switch to .

 **WARNING**



When the light switch is set to , the low-beam headlamps may not be switched on automatically if there is fog, snow or other causes of poor visibility due to the weather conditions such as spray. There is a risk of an accident.

In such situations, turn the light switch to .

The automatic headlamp feature is only an aid. The driver is responsible for the vehicle's lighting at all times.

The daytime running lamps improve the visibility of your vehicle during the day. The daytime running lamps function is required by law in Canada. It cannot therefore be deactivated.

When the engine is running and the vehicle is stationary: if you move the selector lever from a drive position to **P**, the daytime running lamps/low-beam headlamps go out after three minutes.



When the engine is running, the vehicle is stationary and in bright ambient light: if you turn the light switch to , you turn on the daytime running lamps and parking lamps. If the engine is running and you turn the light switch to , the manual settings take precedence over the daytime running lamps.

### Low-beam headlamps

Even if the light sensor does not detect that it is dark, the parking lamps and low-beam headlamps switch on when the ignition is switched on and the light switch is set to the

 position. This is a particularly useful function in the event of rain and fog.

► **To switch on the low-beam headlamps:** turn the SmartKey in the ignition lock to position **2** or start the engine.

► Turn the light switch to . The green  indicator lamp in the instrument cluster lights up.

### Front fog lamps

In conditions where visibility is poor due to fog, snow or rain, the fog lamps improve visibility as well as making it easier for other road users to see you. They can be operated together with the parking lamps or together with the parking lamps and low-beam headlamps.

► **To switch on the front fog lamps:** turn the SmartKey in the ignition lock to position **2** or start the engine.

► Turn the light switch to  or .

► Press the  button.

The green  indicator lamp in the instrument cluster lights up.

► **To switch off the front fog lamps:** press the  button.





The green  indicator lamp in the instrument cluster goes out.

### Rear fog lamp



The rear fog lamp improves visibility of your vehicle for the traffic behind in the event of thick fog. Please take note of the country-specific regulations for the use of rear fog lamps.



► **To switch on the rear fog lamps:** turn the SmartKey to position **2** in the ignition lock or start the engine.

► Turn the light switch to  or .

- ▶ Press the  button.  
The yellow  indicator lamp in the instrument cluster lights up.
- ▶ **To switch off the rear fog lamp:** press the  button.  
The yellow  indicator lamp in the instrument cluster goes out.



### Parking lamps

**!** If the battery has been excessively discharged, the parking lamps or standing lamps are automatically switched off to enable the next engine start. Always park your vehicle safely and sufficiently lit according to legal standards. Avoid the continuous use of the  parking lamps for several hours. If possible, switch on the  right or the  left standing lamp.

- ▶ **To switch on:** turn the light switch to .  
The green  indicator lamp in the instrument cluster lights up.

### Standing lamps

Switching on the standing lamps ensures the corresponding side of the vehicle is illuminated.

- ▶ **To switch on the standing lamps:** the SmartKey is not in the ignition lock or it is in position **0**.
- ▶ Turn the light switch to  (left-hand side of the vehicle) or  (right-hand side of the vehicle).

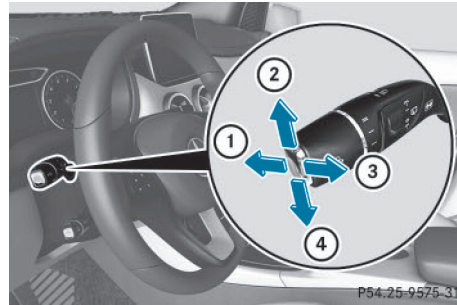

### Combination switch

#### Turn signal



- ① High-beam headlamps
  - ② Turn signal, right
  - ③ High-beam flasher
  - ④ Turn signal, left
- ▶ **To indicate briefly:** press the combination switch briefly to the pressure point in the direction of arrow ② or ④.  
The corresponding turn signal flashes three times.
  - ▶ **To indicate:** press the combination switch beyond the pressure point in the direction of arrow ② or ④.

#### High-beam headlamps

- ▶ **To switch on the high-beam headlamps:** turn the SmartKey in the ignition lock to position **2** or start the engine.
- ▶ Turn the light switch to  or **AUTO**.
- ▶ Press the combination switch beyond the pressure point in the direction of arrow ①.  
In the **AUTO** position, the high-beam headlamps are only switched on when it is dark and the engine is running.  
The blue  indicator lamp in the instrument cluster lights up when the high-beam headlamps are switched on.
- ▶ **To switch off the high-beam headlamps:** move the combination switch back to its normal position.  
The blue  indicator lamp in the instrument cluster goes out.

Vehicles with Adaptive Highbeam Assist: when Adaptive Highbeam Assist is active, it controls activation of the high-beam headlamps (▷ page 107).

### High-beam flasher

- ▶ **To switch on:** turn the SmartKey in the ignition lock to position **1** or **2**, or start the engine.
- ▶ Pull the combination switch in the direction of arrow **③**.

### Hazard warning lamps



- ▶ **To switch on the hazard warning lamps:** press button **①**.  
All turn signals flash. If you now switch on a turn signal using the combination switch, only the turn signal lamp on the corresponding side of the vehicle will flash.
- ▶ **To switch off the hazard warning lamps:** press button **①**.

The hazard warning lamps automatically switch on if:

- an air bag is deployed or
- the vehicle decelerates rapidly from a speed of above 45 mph (70 km/h) and comes to a standstill

The hazard warning lamps switch off automatically if the vehicle reaches a speed of above 6 mph (10 km/h) again after a full brake application.

The hazard warning lamps still operate if the ignition is switched off.

### Adaptive Highbeam Assist

#### General notes

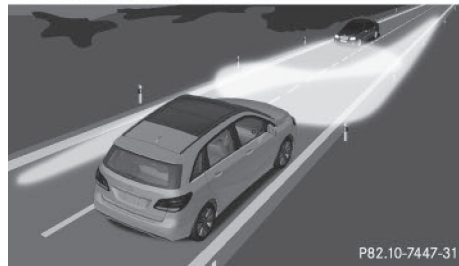

You can use this function to set the headlamps to change between low beam and high beam automatically. The system recognizes vehicles with their lights on, either approaching from the opposite direction or traveling in front of your vehicle, and consequently switches the headlamps from high beam to low beam.

Once the system no longer detects any other vehicles, it reactivates the high-beam headlamps.

The system's optical sensor is located behind the windshield near the overhead control panel.

#### Important safety notes

##### **WARNING**

Adaptive Highbeam Assist does not recognize road users:

- who have no lights, e.g. pedestrians
- who have poor lighting, e.g. cyclists
- whose lighting is blocked, e.g. by a barrier

In very rare cases, Adaptive Highbeam Assist may fail to recognize other road users that have lights, or may recognize them too late. In this or similar situations, the automatic high-beam headlamps will not be deactivated or activated regardless. There is a risk of an accident.

Always carefully observe the traffic conditions and switch off the high-beam headlamps in good time.

Adaptive Highbeam Assist cannot take into account road, weather or traffic conditions. Adaptive Highbeam Assist is only an aid. You are responsible for adjusting the vehicle's lighting to the prevailing light, visibility and traffic conditions.

In particular, the detection of obstacles can be restricted if there is:

- poor visibility, e.g. due to fog, heavy rain or snow
- dirt on the sensors or the sensors are obscured

### Switching Adaptive Highbeam Assist on/off

- ▶ **To switch on:** turn the light switch to **AUTO**.
- ▶ Press the combination switch beyond the pressure point in the direction of arrow ①. The  indicator lamp in the multifunction display lights up when it is dark and the light sensor activates the low-beam headlamps.

If you are driving at speeds above approximately 19 mph (30 km/h) and no other road users are recognized:

The high-beam headlamps are switched on automatically. The  indicator lamp in the instrument cluster also lights up.

If you are driving at speeds below approximately 16 mph (25 km/h) or other road users have been detected or the roads are adequately lit:

The high-beam headlamps are switched off automatically. The  indicator lamp in

the instrument cluster goes out. The  indicator lamp in the multifunction display remains lit.

- ▶ **To deactivate:** move the combination switch back to its normal position.

The  indicator lamp in the multifunction display goes out.

### Headlamps fogged up on the inside





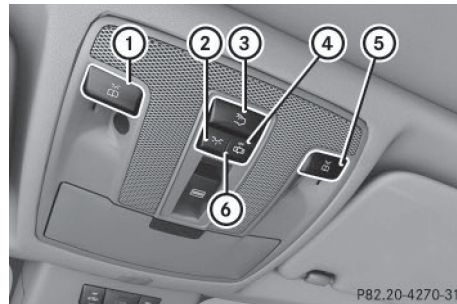

Certain climatic and physical conditions may cause moisture to form in the headlamp. This moisture does not affect the functionality of the headlamp.

## Interior lighting

### Overview of interior lighting

#### Front overhead control panel



- ①  Switches the left-hand front reading lamp on/off
- ②  Switches the front interior lighting on
- ③  Switches the rear interior lighting on/off
- ④  Switches the front interior lighting/automatic interior lighting control off
- ⑤  Switches the right-hand front reading lamp on/off
- ⑥  Switches the automatic interior lighting control on

**Control panel in the grab handle in the rear compartment**

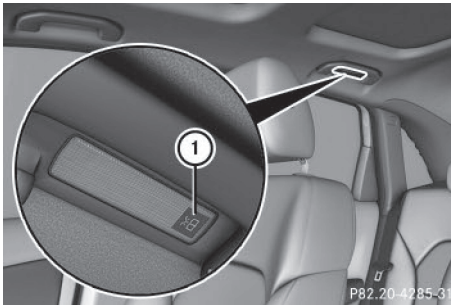

① To switch the reading lamp on/off

**Interior lighting control**

**General notes**

In order to prevent the vehicle's battery from discharging, the interior lighting functions are automatically deactivated after some time unless the SmartKey is in position **2** in the ignition lock.

The color and brightness for the ambient lighting may be set using COMAND or Audio 20 (see the separate operating instructions).

**Automatic interior lighting control**





- ▶ **To switch on:** set the switch to center position ⑥.
- ▶ **To switch off:** set the switch to the  position.

The interior lighting automatically switches on if you:

- unlock the vehicle
- open a door
- remove the SmartKey from the ignition lock.

The interior light is activated for a short while when the SmartKey is removed from the ignition lock. This delayed switch-off can be adjusted using COMAND or Audio 20 (see the separate Operator's Manual).

**Manual interior lighting control**

- ▶ **To switch the front interior lighting on:** set the switch to the  position.
- ▶ **To switch the front interior lighting off:** set the switch to the  position or (if the door is closed) to the center position.
- ▶ **To switch the rear interior lighting on/off:** press the  button.
- ▶ **To switch the reading lamps on/off:** press the  button.

**Crash-responsive emergency lighting**

The interior lighting is activated automatically if the vehicle is involved in an accident.

- ▶ **To switch off the crash-responsive emergency lighting:** press the hazard warning lamp button.
- or
- ▶ Lock and then unlock the vehicle using the SmartKey.

**Replacing bulbs**

**Important safety notes**

 **WARNING**

Bulbs, lamps and connectors can get very hot when operating. If you change a bulb, you could burn yourself on these components. There is a risk of injury.

Allow these components to cool down before changing a bulb.

Do not use a bulb that has been dropped or if its glass tube has been scratched.

The bulb may explode if:

- you touch it
- it is hot
- you drop it
- you scratch it

Only operate bulbs in enclosed lamps designed for that purpose. Only install spare

bulbs of the same type and the specified voltage.

Marks on the glass tube reduce the service life of the bulbs. Do not touch the glass tube with your bare hands. If necessary, clean the glass tube when cold with alcohol or spirit and rub it off with a lint-free cloth.

Protect bulbs from moisture during operation. Do not allow bulbs to come into contact with liquids.

Replace only the bulbs listed (▷ page 110). Have the bulbs that you cannot replace yourself changed at a qualified specialist workshop.

If you require assistance changing bulbs, consult a qualified specialist workshop.

If the new bulb still does not light up, consult a qualified specialist workshop.

Bulbs and lamps are an important aspect of vehicle safety. You must therefore make sure that these function correctly at all times. Have the headlamp setting checked regularly.

**Vehicles with LED headlamps:** the light clusters of your vehicle are equipped with LED light bulbs. Do not replace the bulbs yourself. Contact a qualified specialist workshop which has the necessary specialist knowledge and tools to carry out the work required.

#### Overview: changing bulbs/bulb types

You can change the following bulbs. The bulb type can be found in the legend.

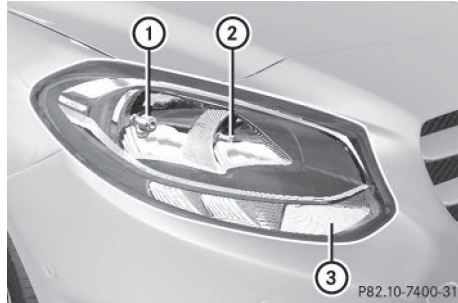

Vehicles with halogen headlamps

- ① Low-beam headlamp: H7 55 W
- ② High-beam headlamp: H7 55 W
- ③ Turn signal lamp: PY 21 W

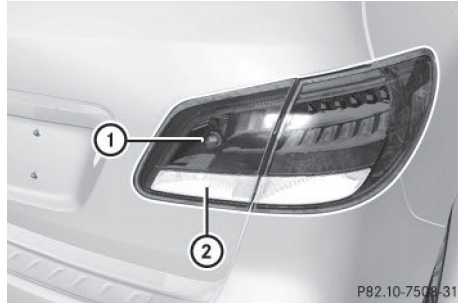

Tail lamps (vehicles with halogen headlamps)

- ① Rear fog lamp: P 21 W
- ② Backup lamp: W 16 W

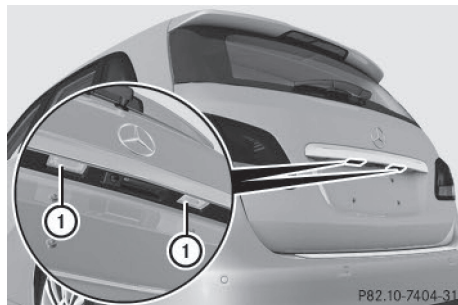

License plate lamp (vehicles with halogen headlamps)

- ① License plate lamp: C 5 W



### Changing the front bulbs

#### Removing and installing the cover in the front wheel housing

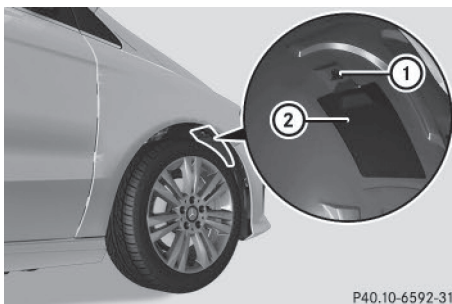

P40.10-6592-31

You must remove the cover of the front wheel housing before you can change the front turn signal lamp.

- ▶ **To remove:** switch off the lights.
- ▶ Turn the front wheels inwards.
- ▶ Turn rotary knob ① through 90°.  
Cover ② is released.
- ▶ Push cover ② down.
- ▶ Turn rotary knob ① through 90°.  
Cover ② is locked.

#### Low-beam headlamps (halogen headlamps)

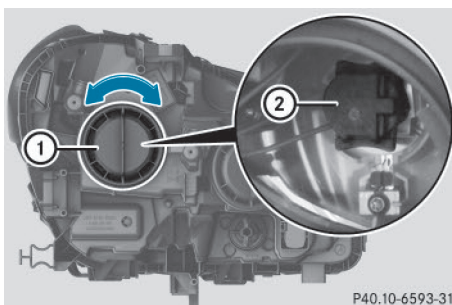

P40.10-6593-31

- ▶ Remove the cover in the front wheel housing (▷ page 111).
- ▶ Turn housing cover ① counter-clockwise and remove it.
- ▶ Turn bulb holder ② counter-clockwise and pull out.

- ▶ Take the bulb out of bulb holder ②.
- ▶ Insert the new bulb into bulb holder ②.
- ▶ Insert bulb holder ② and turn it clockwise.
- ▶ Press on housing cover ① and turn it to the right.
- ▶ Replace the cover in the front wheel housing (▷ page 111).

#### High-beam headlamps (halogen headlamps)

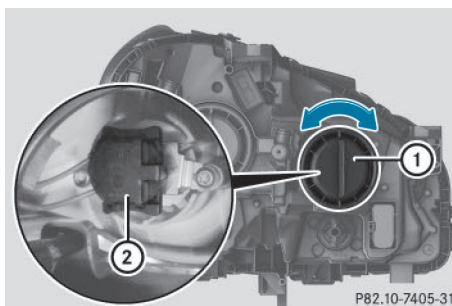

P82.10-7405-31

- ▶ Switch off the lights.
- ▶ Open the hood.
- ▶ Turn housing cover ① counter-clockwise and remove it.
- ▶ Turn bulb ② counter-clockwise and pull out.
- ▶ Insert the new bulb and engage it to the stop.
- ▶ Press on housing cover ① and turn it to the right.

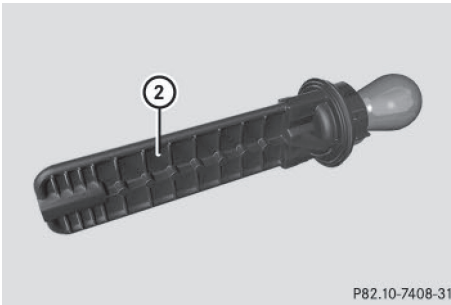
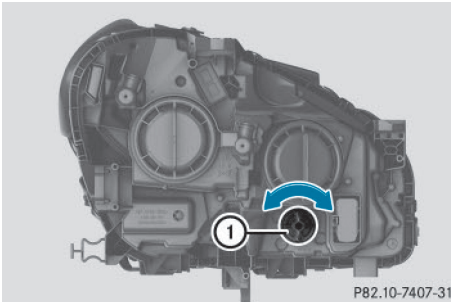
**Turn signals (halogen headlamps)**

- ▶ Remove the cover in the front wheel housing (▷ page 111).
- ▶ Turn handle extension ② counter-clockwise and pull it out of holder ①.
- ▶ Press the bulb lightly, turn it counter-clockwise and pull it out.
- ▶ Insert the new bulb into bulb holder ①.
- ▶ Insert handle extension ② into holder ① and turn it clockwise until it engages.

**Changing the rear bulbs****Tail lamps****Backup lamp and rear fog lamp**

Due to their location, have the bulbs in the backup lamp and the fog lamp in the tailgate replaced at a qualified specialist workshop.

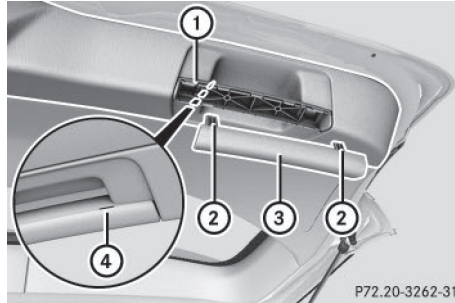

- ▶ Switch off the lights.
- ▶ Open the tailgate.
- ▶ In recess ④ on the inside of the closing handle, pry off and remove the upper section of handle ③ with a flat and smooth object, e.g. a screwdriver.
- ▶ Pull the lower section of handle ① using a sharp, sudden movement to remove it from the paneling and then place it to one side.

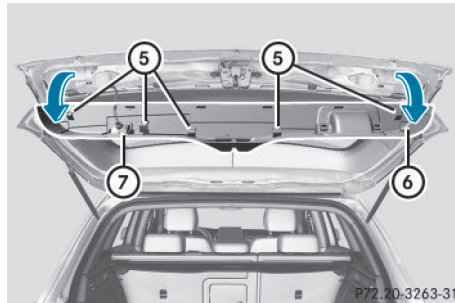

- ▶ Reach under the right-hand side of paneling ⑥ and apply a gentle jolting force along the entire length of the paneling in order to unclip it.
- ▶ Pull out connector ⑦ of the surround lighting by releasing the latches.
- ▶ Place paneling ⑥ to one side.

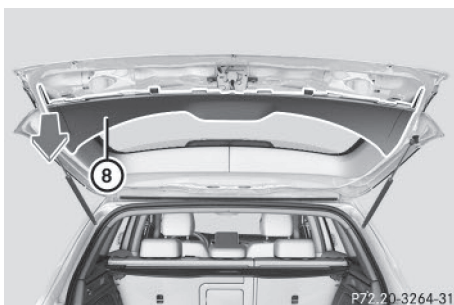

- ▶ On the side where the bulb is to be replaced, unclip the remaining part of trim ⑧ from the assembly using a sudden, sharp movement, until the bulb holder is accessible.

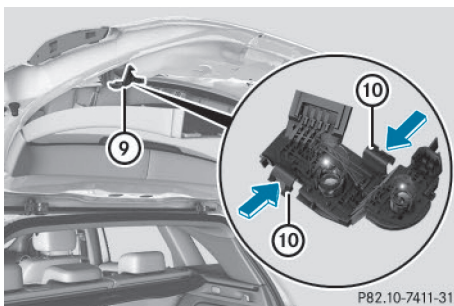

- ▶ Remove bulb holder ⑨ using both sides of lever ⑩.

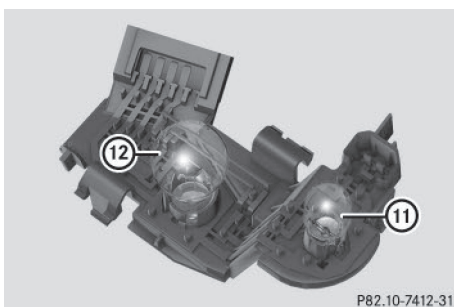

Bulb holder

- ▶ **Backup lamp** ⑪: remove the bulb from bulb holder ⑨.
- ▶ Insert the new bulb into the bulb holder.

- ▶ **Rear fog lamp** ⑫: press the bulb gently into bulb holder ⑨, turn it counter-clockwise and remove it from the bulb holder.
- ▶ Insert the new bulb into the bulb holder and turn it clockwise.
- ▶ Reinsert the bulb holder until you hear it engage audibly.
- ▶ Position paneling ⑧ and engage it in place by tapping it with your hand.
- ▶ Before continuing with the installation, check that all the metal clips are inserted in the parts placed to one side: 2 clips ② in the upper part of handle ③ and 5 clips ⑤ in paneling ⑥.
- ▶ If not, remove the missing metal clips from the metal openings in the tailgate and insert them in the appropriate places.
- ▶ Take paneling ⑥ and connect plug connector ⑦ to the surround lighting.
- ⓘ The surround lighting only illuminates when the tailgate has been shut and reopened.
- ▶ Position paneling ⑥ and engage it in place by tapping it with your hand, starting from the outside.
- ▶ Clip in the lower section of handle ① again.
- ▶ Insert and engage the upper section of handle ③ into lower section ①.

## License plate lamp

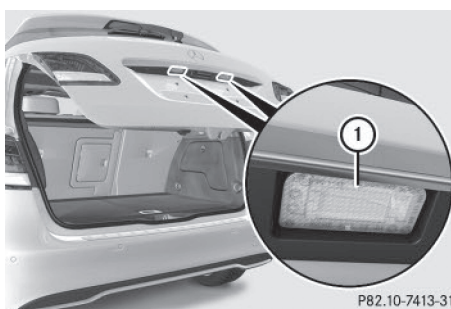

- ▶ Switch off the lights.
- ▶ Open the tailgate.

- ▶ Apply a screwdriver to lamp lens ① from the outside.
- ▶ Lever out lamp lens ① and remove it.
- ▶ Replace the bulb.
- ▶ Insert lamp lens ① into the license plate lamp and press it in until it engages.

## Windshield wipers

### Switching the windshield wipers on/off

**!** Do not operate the windshield wipers when the windshield is dry, as this could damage the wiper blades. Moreover, dust that has collected on the windshield can scratch the glass if wiping takes place when the windshield is dry.

If it is necessary to switch on the windshield wipers in dry weather conditions, always use washer fluid when operating the windshield wipers.

**!** If the windshield wipers leave smears on the windshield after the vehicle has been washed in an automatic car wash, wax or other residues may be the reason for this. Clean the windshield using washer fluid after washing the vehicle in an automatic car wash.

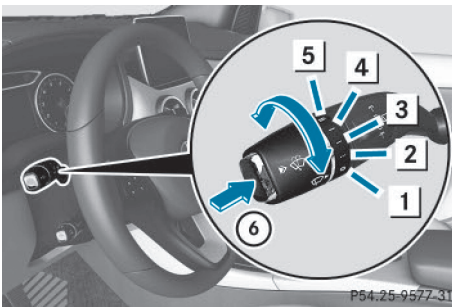

Combination switch

- 1 0 Windshield wiper off
- 2 ... Intermittent wipe, low (rain sensor set to low sensitivity)
- 3 .... Intermittent wipe, high (rain sensor set to high sensitivity)

- 4 — Continuous wipe, slow
- 5 ≡ Continuous wipe, fast
- 6 Single wipe / Wipes the windshield using washer fluid

- ▶ Switch on the ignition.
- ▶ Turn the combination switch to the corresponding position.

**!** Vehicles with a rain sensor: if the windshield becomes dirty in dry weather conditions, the windshield wipers may be activated inadvertently. This could then damage the windshield wiper blades or scratch the windshield.

For this reason, you should always switch off the windshield wipers in dry weather.

Vehicles with a rain sensor: in the or position, the appropriate wiping frequency is automatically set according to the intensity of the rain. In the position, the rain sensor is more sensitive than in the position, causing the windshield wiper to wipe more frequently.

If the wiper blades are worn, the windshield will no longer be wiped properly. This could prevent you from observing the traffic conditions.

### Switching the rear window wiper on/off

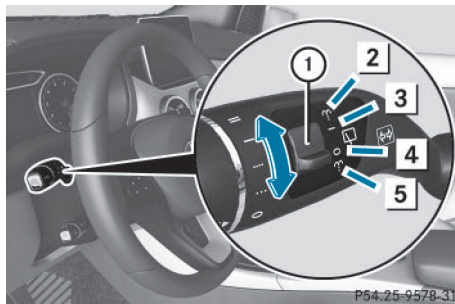



Combination switch

- ① Switch
- ② Wipes with washer fluid
- ③ **I** Switches on intermittent wiping

- 4 **0** Switches off intermittent wiping
- 5  Wipes with washer fluid

- ▶ Switch on the ignition.
- ▶ Turn switch ① on the combination switch to the corresponding position.

**Vehicles with a black and white multi-function display:** when the rear window wiper is switched on, the  symbol appears in the status overview in the instrument cluster. Further information on the status overview (▶ page 201).

**Vehicles with a color multifunction display:** when the rear window wiper is switched on, the  symbol appears in the assistance graphic in the instrument cluster. Further information on the assistance graphic (▶ page 202).

## Replacing the wiper blades

### Important safety notes

#### **WARNING**

If the windshield wipers begin to move while you are changing the wiper blades, you could be trapped by the wiper arm. There is a risk of injury.

Always switch off the windshield wipers and ignition before changing the wiper blades.

- !** To avoid damaging the wiper blades, make sure that you touch only the wiper arm of the wiper.
- !** Never open the hood/tailgate if a wiper arm has been folded away from the windshield/rear window.

Never fold a windshield wiper arm without a wiper blade back onto the windshield/rear window.

Hold the windshield wiper arm firmly when you change the wiper blade. If you release the wiper arm without a wiper blade and it falls onto the windshield/rear window, the windshield/rear window may be damaged by the force of the impact.

Mercedes-Benz recommends that you have the wiper blades changed at a qualified specialist workshop.

## Changing the windshield wiper blades

### Removing the wiper blades

- ▶ Remove the SmartKey from the ignition lock.
- ▶ Fold the wiper arm away from the windshield.

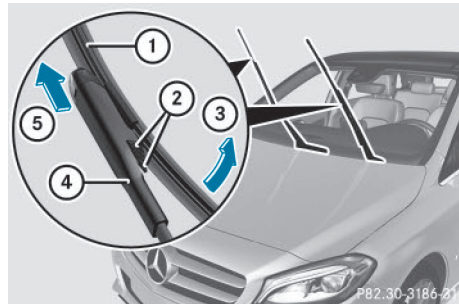

- ▶ Press both release clips ②.
- ▶ Fold wiper blade ① in the direction of arrow ③ away from wiper arm ④.
- ▶ Remove wiper blade ① in the direction of arrow ⑤.

### Installing the wiper blades

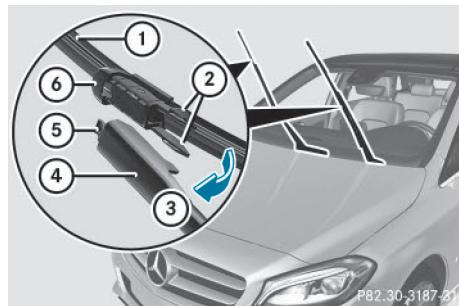

- ▶ Position new wiper blade ① with recess ⑥ on lug ⑤.
- ▶ Fold wiper blade ① in the direction of arrow ③ onto the wiper arm, until retaining clips ② engage in bracket ④.

- ▶ Make sure that wiper blade ① is seated correctly.
- ▶ Fold the wiper arm back onto the windshield.

### Replacing the rear window wiper blade

#### Removing a wiper blade

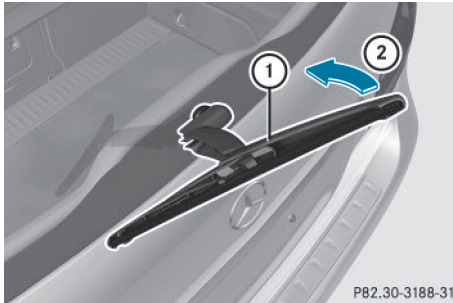

- ▶ Remove the SmartKey from the ignition lock.
- ▶ Fold wiper arm ① away from the rear window until you feel it engage.
- ▶ Position wiper blade ② at a right angle to wiper arm ①.
- ▶ Hold wiper arm ① and press wiper blade ② in the direction of the arrow until it releases.
- ▶ Remove wiper blade ②.

#### Installing a wiper blade

- ▶ Place new wiper blade ② onto wiper arm ①.
- ▶ Hold wiper arm ① and press wiper blade ② in the opposite direction to the arrow until it engages.
- ▶ Make sure that wiper blade ② is seated correctly.
- ▶ Position wiper blade ② parallel to wiper arm ①.
- ▶ Fold wiper arm ① back onto the rear window.

**Problems with the windshield wipers**

<b>Problem</b>	<b>Possible causes/consequences and ► Solutions</b>
The windshield wipers are jammed.	Leaves or snow, for example, may be obstructing the windshield wiper movement. The wiper motor has been deactivated. <ul style="list-style-type: none"><li>► For safety reasons, you should remove the SmartKey from the ignition lock.</li><li>► Remove the cause of the obstruction.</li><li>► Switch the windshield wipers back on.</li></ul>
The windshield wipers fail completely.	The windshield wiper drive is malfunctioning. <ul style="list-style-type: none"><li>► Select another wiper speed on the combination switch.</li><li>► Have the windshield wipers checked at a qualified specialist workshop.</li></ul>
The windshield washer fluid from the spray nozzles no longer hits the center of the windshield.	The spray nozzles are misaligned. <ul style="list-style-type: none"><li>► Have the spray nozzles adjusted at a qualified specialist workshop.</li></ul>





Useful information .....	120
Overview of climate control systems .....	120
Operating the climate control systems .....	124
Air vents .....	131

### Useful information

- i** This Operator's Manual describes all models and all standard and optional equipment of your vehicle available at the time of publication of the Operator's Manual. Country-specific differences are possible. Please note that your vehicle may not be equipped with all features described. This also applies to safety-related systems and functions.
- i** Read the information on qualified specialist workshops (▷ page 24).

### Overview of climate control systems

#### General notes

Observe the settings recommended on the following pages. The windows could otherwise fog up.

To prevent the windows from fogging up:

- switch off climate control only briefly
- switch on air-recirculation mode only briefly
- switch on the cooling with air dehumidification function
- switch on the defrost windshield function briefly, if required

The air-conditioning system/dual-zone automatic climate control regulates the temperature and the humidity of the vehicle interior and filters out undesirable substances from the air.

The air-conditioning system/dual-zone automatic climate control can only be operated when the engine is running. Optimum operation is only achieved with the side windows and panorama roof with power tilt/sliding panel closed.

The residual heat function can only be activated or deactivated with the ignition switched off (▷ page 130).

Always keep the ventilation flaps behind the side paneling in the cargo compartment clear.

Otherwise the vehicle will not be ventilated correctly.

- i** Ventilate the vehicle for a brief period during warm weather, e.g. using the convenience opening feature (▷ page 82). This will speed up the cooling process and the desired interior temperature will be reached more quickly.
- i** The integrated filter filters out most particles of dust and soot and completely filters out pollen. It also reduces gaseous pollutants and odors. A clogged filter reduces the amount of air supplied to the vehicle interior. For this reason, you should always observe the interval for replacing the filter, which is specified in the Maintenance Booklet. As it depends on environmental conditions, e.g. heavy air pollution, the interval may be shorter than stated in the Maintenance Booklet.
- i** It is possible that under certain circumstances the residual heat function may be activated automatically an hour after the SmartKey has been removed in order to dry the automatic climate control. The vehicle is then ventilated for 30 minutes.

**Air-conditioning system control panel**

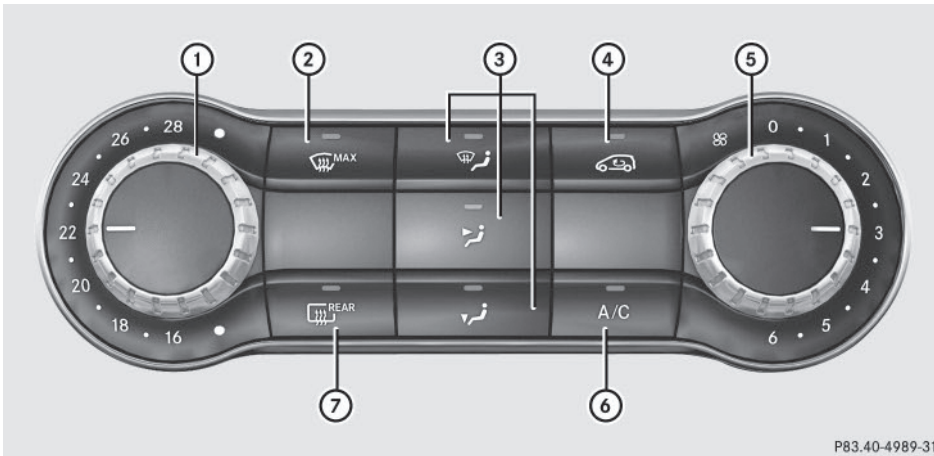

P83.40-4989-31

- ① Sets the temperature (▷ page 126)
- ② Defrosts the windshield (▷ page 128)
- ③ Sets the air distribution (▷ page 127)
- ④ Activates/deactivates air-recirculation mode (▷ page 130)
- ⑤ Sets the airflow (▷ page 127)
- ⑥ Switches cooling with air dehumidification on/off (▷ page 124)
- ⑦ Switches the rear window defroster on/off (▷ page 129)

**Notes on using the air-conditioning system**

**Air-conditioning system**

Below, you can find a number of notes and recommendations to help you use the air-conditioning system optimally.

- Switch on the air-conditioning system by turning control knob ⑤ clockwise to the desired position (except position 0).
- Set the temperature to 22 °C.
- **Recommendation for avoiding misted windows at low exterior temperatures or in rain:** switch on the  A/C cooling with dehumidification function (▷ page 124). Set air distribution to  and if possible switch off  and  (▷ page 127). Deactivate air-recirculation mode  (▷ page 130).

Set airflow control ⑤ to a setting between 3 and 6 (▷ page 127).

- **Recommendation for rapid cooling or heating of the vehicle interior:** briefly set airflow control ⑤ to a setting between 3 and 6 (▷ page 127).
- **Recommendation for a constant vehicle interior temperature:** set airflow control ⑤ to a setting between 1 and 3 (▷ page 127).
- **Recommendation for air distribution in winter:** select the  and  settings (▷ page 127).
- **Recommendation for air distribution in summer:** select the  or  and  settings (▷ page 127).

- Only use the "Windshield defrosting" function briefly until the windshield is clear again.

- Only use air-recirculation mode briefly, e.g. if there are unpleasant outside odors or when in a tunnel. The windows could otherwise fog up, since no fresh air is drawn into the vehicle in air-recirculation mode.
- If you change the settings of the climate control system, the climate status display appears for approximately three seconds at the bottom of the screen in the Audio/COMAND display (see separate operating instructions). You will see the current settings of the various climate control functions.

### ECO start/stop function

---

During automatic engine switch-off, the climate control system only operates at a reduced capacity. If you require the full climate control output, you can switch off the ECO start/stop function by pressing the ECO button (▷ page 140).

## Control panel for dual-zone automatic climate control

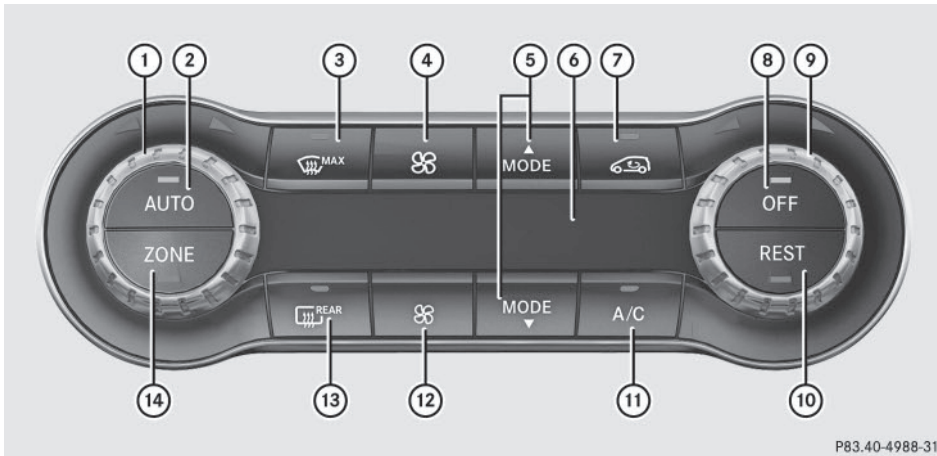

- ① Sets the temperature, left (▷ page 126)
- ② Sets climate control to automatic (▷ page 126)
- ③ Defrosts the windshield (▷ page 128)
- ④ Increases the airflow (▷ page 127)
- ⑤ Sets the air distribution (▷ page 127)
- ⑥ Display
- ⑦ Activates/deactivates air-recirculation mode (▷ page 130)
- ⑧ Switches climate control on/off (▷ page 124)
- ⑨ Sets the temperature, right (▷ page 126)
- ⑩ Switches the residual heat function on/off (▷ page 130)
- ⑪ Switches cooling with air dehumidification on/off (▷ page 124)
- ⑫ Reduces the airflow (▷ page 127)
- ⑬ Switches the rear window defroster on/off (▷ page 129)
- ⑭ Switches the ZONE function on/off (▷ page 127)

### Optimum use of dual-zone climate control

#### Climate control system

The following contains instructions and recommendations to enable you to get the most out of your dual-zone automatic climate control.

- Activate climate control using the **AUTO** and **A/C** buttons. The indicator lamps in the **AUTO** and **A/C** buttons light up.
- Set the temperature to 22 °C.
- Only use the "Windshield defrosting" function briefly until the windshield is clear again.
- Only use air-recirculation mode briefly, e.g. if there are unpleasant outside odors or when in a tunnel. The windows could otherwise fog up, since no fresh air is drawn into the vehicle in air-recirculation mode.
- Use the ZONE function to adopt the temperature settings on the driver's side for the front-passenger side as well. The indicator lamp in the **ZONE** button goes out.

- Use the residual heat function if you want to heat or ventilate the vehicle interior when the ignition is switched off. The residual heat function can only be activated or deactivated with the ignition switched off.
- If you change the settings of the climate control system, the climate status display appears for approximately three seconds at the bottom of the screen in the Audio/COMAND display (see separate operating instructions). You will see the current settings of the various climate control functions.

### ECO start/stop function

During automatic engine switch-off, the climate control system only operates at a reduced capacity. If you require the full climate control output, you can switch off the ECO start/stop function by pressing the ECO button (▷ page 140).

## Operating the climate control systems

### Switching climate control on/off

#### General notes

When the climate control is switched off, the air supply and air circulation are also switched off. The windows could fog up. Therefore, switch off climate control only briefly

#### Air-conditioning system

- ▶ Turn the SmartKey to position **2** in the ignition lock (▷ page 135).
- ▶ **To switch on:** turn control **5** clockwise to the desired position (except position **0**) (▷ page 121).
- ▶ **To switch off:** turn control **5** counter-clockwise to position **0** (▷ page 121).

### Dual-zone automatic climate control

- ▶ Turn the SmartKey to position **2** in the ignition lock (▷ page 135).
  - ▶ **To activate:** press the **AUTO** button. The indicator lamp in the **AUTO** button lights up. Airflow and air distribution are set to automatic mode.
- or
- ▶ Press the **OFF** button. The indicator lamp in the **OFF** button goes out. The previously selected settings are restored.
  - ▶ **To deactivate:** press the **OFF** button. The indicator lamp in the **OFF** button lights up.

- i** Dual-zone automatic climate control: switch on climate control primarily using the **AUTO** button.

### Activating/deactivating cooling with air dehumidification

#### General notes





If you deactivate the "Cooling with air-dehumidification" function, the air inside the vehicle will not be cooled. The air inside the vehicle will also not be dehumidified. The windows can fog up more quickly. Therefore, only deactivate the "Cooling with air-dehumidification" function briefly.

The "Cooling with air dehumidification" function is only available when the engine is running. The air inside the vehicle is cooled and dehumidified according to the temperature selected.

Condensation may drip from the underside of the vehicle when it is in cooling mode. This is normal and not a sign that there is a malfunction.

### Switching on/off

---

- ▶ **To activate:** press the  button.  
The indicator lamp in the  button lights up.
- ▶ **To deactivate:** press the  button.  
The indicator lamp in the  button goes out. The "Cooling with air dehumidification" function has a delayed switch-off feature.

### Problems with the "Cooling with air dehumidification" function

Problem	Possible causes/consequences and ► Solutions
The indicator lamp in the  button flashes three times or remains off. The "Cooling with air dehumidification" function cannot be switched on.	Cooling with air dehumidification has been deactivated due to a malfunction. ► Visit a qualified specialist workshop.

### Setting climate control to automatic

#### General notes



The automatic function is only available in conjunction with dual-zone automatic climate control.



In automatic mode, the set temperature is maintained automatically at a constant level. The system automatically regulates the temperature of the dispensed air, the airflow and the air distribution.

The automatic mode functions optimally when the "Cooling with air dehumidification" function is activated. If necessary, cooling with air dehumidification can be deactivated.



If you deactivate the "Cooling with air-dehumidification" function, the air inside the vehicle will not be cooled. The air inside the vehicle will also not be dehumidified. The windows can fog up more quickly. Therefore, only deactivate the "Cooling with air-dehumidification" function briefly.

#### Setting climate control to automatic

- Turn the SmartKey to position **2** in the ignition lock (▷ page 135).
- Set the desired temperature.
- **To activate:** press the  button. The indicator lamp in the  button lights up. Automatic air distribution and airflow are activated.

- **To switch to manual mode:** press the  or  button.

or

- Press the  or  button. The indicator lamp in the  button goes out. Automatic air distribution and airflow are deactivated.

### Setting the temperature



#### Air-conditioning system

You can set the temperature for the entire vehicle. The set temperature is automatically maintained at a constant level.

- Turn the SmartKey to position **2** in the ignition lock (▷ page 135).
- **To increase/reduce:** turn control  clockwise or counter-clockwise (▷ page 121). Only change the temperature setting in small increments. Start at 22 °C.

#### Dual-zone automatic climate control

Different temperatures can be set for the driver's and front-passenger sides. The set temperature is automatically maintained at a constant level.

- Turn the SmartKey to position **2** in the ignition lock (▷ page 135).
- **To increase/reduce:** turn thumbwheel  or  to the left or right (▷ page 123). Only





change the temperature setting in small increments. Start at 22 °C.

## Setting the air distribution

### Air-conditioning system



#### Air distribution settings

-  Directs air through the defroster vents
-  Directs air through the center and side air vents
-  Directs air through the footwell air vents

**i** You can also activate several air distribution settings simultaneously. To do this, press multiple air distribution buttons. The air is then directed through various vents.





**i** Regardless of the air distribution setting, airflow is always directed through the side air vents. The side air vents can only be closed if the adjusters are turned clockwise until they engage.



#### Setting the air distribution

- ▶ Turn the SmartKey to position **2** in the ignition lock (▷ page 135).
- ▶ Press one or more of the , ,  buttons.  
The corresponding indicator lamp lights up briefly.

### Dual-zone automatic climate control



#### Air distribution settings

-  Directs air through the defroster vents
-  Directs air through the center and side air vents
-  Directs air through the footwell air vents
-  Directs air through the center, side and footwell vents
-  Directs air through the defroster, center and side air vents

-  Directs air through the defroster and footwell vents
-  Directs air through the defroster, center, side and footwell vents

**i** Regardless of the air distribution setting, airflow is always directed through the side air vents. The side air vents can only be closed if the adjusters are turned clockwise until they engage.

#### Setting the air distribution



- ▶ Turn the SmartKey to position **2** in the ignition lock (▷ page 135).
- ▶ Press the  or  button repeatedly until the desired symbol appears in the display.

## Setting the airflow

### Air-conditioning system



- ▶ Turn the SmartKey to position **2** in the ignition lock (▷ page 135).
- ▶ **To increase/reduce:** turn control  clockwise or counter-clockwise (▷ page 121).



### Dual-zone automatic climate control

- ▶ Turn the SmartKey to position **2** in the ignition lock (▷ page 135).
- ▶ **To increase/reduce:** press the  or  button.

## Switching the ZONE function on/off

This function is only available with dual-zone automatic climate control.

- ▶ **To activate:** press the  button.  
The indicator lamp in the  button lights up.  
The temperature setting for the driver's side is not adopted for the front-passenger side.

- ▶ **To deactivate:** press the  button. The indicator lamp in the  button goes out. The temperature setting for the driver's side is adopted for the front-passenger side.



## Defrosting the windshield



### General notes



You can use this function to defrost the windshield or to defrost the inside of the windshield and the side windows.

- i** You should only select the "Windshield defrosting" function until the windshield is clear again.



### Activating/deactivating the defrosting function for the windshield

- ▶ Turn the SmartKey to position **2** in the ignition lock (▷ page 135).
- ▶ **To activate:** press the  button. The indicator lamp in the  button lights up. The climate control system switches to the following functions:
  - high airflow
  - high temperature
  - air distribution to the windshield and front side windows
  - air-recirculation mode off
- i** The "Windshield defrosting" function automatically sets the blower output to the optimum defrosting effect. As a result, the airflow may increase or decrease automatically after the  button is pressed.
- i** You can adjust the blower output manually while the "Windshield defrosting" function is in operation:



- Air-conditioning system: turn airflow control  counter-clockwise or clockwise (▷ page 121).
- Dual-zone automatic climate control: press the  or  button.

- ▶ **To deactivate:** press the  button. The indicator lamp in the  button goes out. The previously selected settings are restored. Air-recirculation mode remains deactivated.

or

- ▶ Dual-zone climate control: press the  button. The indicator lamp in the  button goes out. Airflow and air distribution are set to automatic mode.



or

- ▶ Air-conditioning system: turn temperature control  counter-clockwise or clockwise (▷ page 121).
- Dual-zone automatic climate control: turn temperature control  or  counter-clockwise or clockwise (▷ page 123).

## Defrosting the windows



### Windows fogged up on the inside

#### Air-conditioning system



- ▶ Activate the  "Cooling with air dehumidification" function.
- ▶ If the windows continue to fog up, activate the  "Windshield defrosting" function.

- i** You should only select this setting until the windshield is clear again.

#### Dual-zone automatic climate control

- ▶ Activate the  "Cooling with air dehumidification" function.
- ▶ Activate automatic mode .
- ▶ If the windows continue to fog up, activate the  "Windshield defrosting" function.
- i** You should only select this setting until the windshield is clear again.

### Windows fogged up on the outside

- ▶ Activate the windshield wipers.
  - ▶ Set the air distribution to  or .
- i** You should only select this setting until the windshield is clear again.



### Rear window defroster

#### General notes

The rear window defroster has a high current draw. You should therefore switch it off as soon as the rear window is clear. Otherwise, the rear window defroster switches off automatically after several minutes.

If the battery voltage is too low, the rear window defroster may switch off.

#### Switching on/off

- ▶ Turn the SmartKey to position **2** in the ignition lock (▷ page 135).
- ▶ Press the  button.  
The indicator lamp in the  button lights up or goes out.

### Problems with the rear window defroster

Problem	Possible causes/consequences and ► Solutions
The rear window defroster has deactivated prematurely or cannot be activated.	The battery has not been sufficiently charged. ► Switch off any consumers that are not required, e.g. reading lamps, interior lighting or the seat heating. When the battery is sufficiently charged, the rear window defroster can be activated again.

### Activating/deactivating air-recirculation mode



#### General notes

You can deactivate the flow of fresh air if unpleasant odors are entering the vehicle from outside. The air already inside the vehicle will then be recirculated.

If you switch on air-recirculation mode, the windows can fog up more quickly, in particular at low temperatures. Only use air-recirculation mode briefly to prevent the windows from fogging up.

The operation of air-recirculation mode is the same for all control panels.



#### Switching on/off

- Turn the SmartKey to position **2** in the ignition lock (► page 135).
- **To activate:** press the  button.  
The indicator lamp in the  button lights up.

Air-recirculation mode switches on automatically:

- at high outside temperatures
- at high levels of pollution

When air-recirculation mode is activated automatically, the indicator lamp in the  button is not lit. Outside air is added after about 30 minutes.

- **To deactivate:** press the  button.  
The indicator lamp in the  button goes out.

**i** Air-recirculation mode deactivates automatically:

- after approximately five minutes at outside temperatures below approximately 7 °C
- after approximately five minutes if the "Cooling with air dehumidification" function is deactivated
- after approximately 30 minutes at outside temperatures above approximately 7 °C if the cooling with air dehumidification function is activated

### Activating/deactivating the residual heat function

#### General notes

The residual heat function is only available with dual-zone automatic climate control.

It is possible to make use of the residual heat of the engine to continue heating the vehicle for approximately 30 minutes after the engine has been switched off. The heating time depends on the set interior temperature.

- i** The blower will run at a low speed regardless of the airflow setting.
- i** If you activate the residual heat function at high temperatures, only the ventilation will be activated. The blower runs at medium speed.
- i** You cannot use the ventilation to cool the vehicle interior to a temperature lower than the outside temperature.

### Switching on/off

- ▶ Turn the key to position **0** in the ignition lock or remove it (▷ page 135).
- ▶ **To activate:** press the **REST** button. The indicator lamp in the **REST** button lights up.
- ▶ **To deactivate:** press the **REST** button. The indicator lamp in the **REST** button goes out.

**i** Residual heat is deactivated automatically:

- after approximately 30 minutes
- when the ignition is switched on
- if the battery voltage drops

### Air vents

#### Important safety notes

#### WARNING

Very hot or very cold air can flow from the air vents. This could result in burns or frostbite in the immediate vicinity of the air vents. There is a risk of injury.

Make sure that all vehicle occupants always maintain a sufficient distance to the air outlets. If necessary, redirect the airflow to another area of the vehicle interior.

In order to ensure the direct flow of fresh air through the air vents into the vehicle interior, please observe the following notes:

- keep the air inlet between the windshield and the hood free of blockages, such as ice, snow or leaves.
  - never cover the air vents or air intake grilles in the vehicle interior.
- i** You can move the adjusters for the air vents vertically or horizontally to set the direction of the airflow.
- i** For optimal climate control in the vehicle, open the air vents completely and set the adjusters to the central position.

### Setting the center air vents

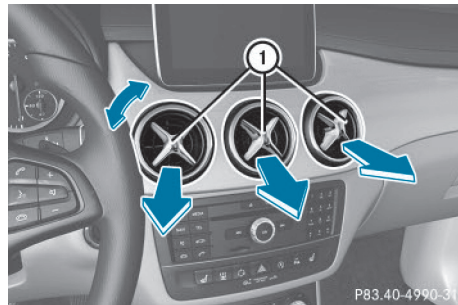

- ▶ **To open the center air vents:** turn the adjuster in one of center air vents ① counter-clockwise.
- ▶ **To close the center air vent:** turn the adjuster in one of center air vents ① clockwise as far as it will go.

### Setting the side air vents

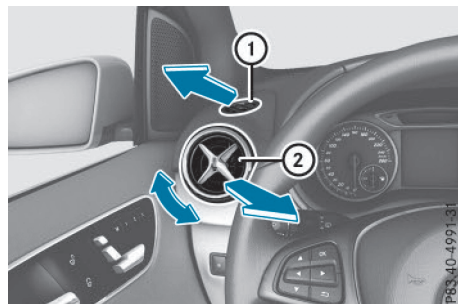

- ① Side window defroster vent
- ② Side air vent

- ▶ **To open a side air vent:** turn the adjuster in side air vent ② to the left.
- ▶ **To close a side air vent:** turn the adjuster in side air vent ② clockwise as far as it will go.

### Setting the rear-compartment air vents

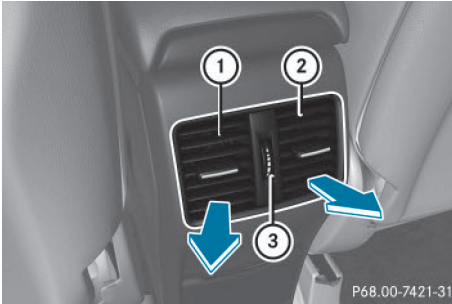

- ① Rear-compartment air vent, left
- ② Rear-compartment air vent, right
- ③ Rear-compartment air vent thumbwheel

► **To open/close:** turn thumbwheel ③ up or down.

❗ If the control panel in the front is switched off, no air can flow through the rear air vents.

Useful information .....	134
Notes on breaking-in a new vehicle .....	134
Driving .....	134
Automatic transmission .....	142
Refueling .....	150
Parking .....	152
Driving tips .....	155
Driving systems .....	161

### Useful information

- i** This Operator's Manual describes all models and all standard and optional equipment of your vehicle available at the time of publication of the Operator's Manual. Country-specific differences are possible. Please note that your vehicle may not be equipped with all features described. This also applies to safety-related systems and functions.
- i** Read the information on qualified specialist workshops (▷ page 24).

### Notes on breaking-in a new vehicle

#### Important safety notes

The sensor system of some driving and driving safety systems adjusts automatically while a certain distance is being driven after the vehicle has been delivered or after repairs. Full system effectiveness is not reached until the end of this teach-in procedure.

New and replaced brake pads and discs only reach their optimum braking effect after several hundred kilometers of driving. Compensate for this by applying greater force to the brake pedal.

#### The first 1000 miles (1500 km)

The more you look after the engine when it is new, the more satisfied you will be with its performance in the future.

- You should therefore drive at varying vehicle and engine speeds for the first 1000 miles (1500 km).
- Avoid heavy loads, e.g. driving at full throttle, during this period.
- Change gear in good time, before the tachometer needle is  $\frac{2}{3}$  of the way to the red area of the tachometer.

- Do not manually shift to a lower gear to brake the vehicle.
- Try to avoid depressing the accelerator pedal beyond the point of resistance (kick-down).
- Ideally, for the first 1000 miles (1500 km), drive in program **E**.

After 1,000 miles (1,500 km), you can increase the engine speed gradually and bring the vehicle to full speed.

You should also observe these notes on breaking-in if the engine or parts of the drive train on your vehicle have been replaced.

Always observe the respective speed limits.

### Driving

#### Important safety notes

##### WARNING

Objects in the driver's footwell can restrict the pedal travel or obstruct a depressed pedal. The operating and road safety of the vehicle is jeopardized. There is a risk of an accident.

Make sure that all objects in the vehicle are stowed correctly, and that they cannot enter the driver's footwell. Install the floor mats securely and as specified in order to ensure sufficient clearance for the pedals. Do not use loose floor mats and do not place floor mats on top of one another.

##### WARNING

Unsuitable footwear can hinder correct usage of the pedals, e.g.:

- shoes with thick soles
- shoes with high heels
- slippers

There is a risk of an accident.

Wear suitable footwear to ensure correct usage of the pedals.



### WARNING

If you switch off the ignition while driving, safety-relevant functions are only available with limitations, or not at all. This could affect, for example, the power steering and the brake boosting effect. You will require considerably more effort to steer and brake. There is a risk of an accident.

Do not switch off the ignition while driving.

### WARNING

If the parking brake has not been fully released when driving, the parking brake can:

- overheat and cause a fire
- lose its hold function.

There is a risk of fire and an accident. Release the parking brake fully before driving off.

- !** Do not warm up the engine with the vehicle stationary. Drive off immediately. Avoid high engine speeds and driving at full throttle until the engine has reached its operating temperature.

Only shift the automatic transmission to the desired drive position when the vehicle is stationary.

Where possible, avoid spinning the drive wheels when pulling away on slippery roads. You could otherwise damage the drive train.

## SmartKey positions

### SmartKey

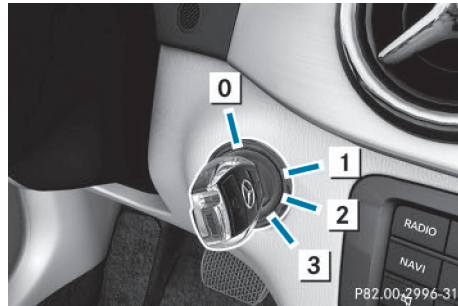

- 0** To remove the SmartKey (shift the transmission to position **P**)
  - 1** Power supply for some consumers, such as the windshield wipers
  - 2** Ignition (power supply for all consumers) and drive position
  - 3** To start the engine
- i** The SmartKey can be turned in the ignition lock even if it is not the correct SmartKey for the vehicle. The ignition is not switched on. The engine cannot be started.

## Start/Stop button

### General notes

Vehicles with KEYLESS-GO are equipped with SmartKeys featuring the integrated KEYLESS-GO function and a detachable Start/Stop button.

A check which periodically establishes a radio connection between the vehicle and the SmartKey determines whether a valid SmartKey is in the vehicle. This occurs, for example, when starting the engine.

When you insert the Start/Stop button into the ignition lock, the system needs approximately two seconds recognition time. You can then use the Start/Stop button.

Pressing the Start/Stop button several times in succession corresponds to the different key positions in the ignition lock. This is only

the case if you are not depressing the brake pedal.

If you depress the brake pedal and press the Start/Stop button, the engine starts immediately.

To start the vehicle without actively using the SmartKey:

- the Start/Stop button must be inserted in the ignition lock.
- the SmartKey must be in the vehicle.
- the vehicle must not be locked with the SmartKey or KEYLESS-GO (▷ page 71).

Do not keep the KEYLESS-GO key:

- with electronic devices, e.g. a mobile phone or another SmartKey.
- with metallic objects, e.g. coins or metal foil.
- inside metallic objects, e.g. a metal case.

This can affect the functionality of KEYLESS-GO.

If you lock the vehicle with the SmartKey's remote control or with KEYLESS-GO, after a short time:

- you will not be able to switch on the ignition with the Start/Stop button.
- you will not be able to start the engine with the Start/Stop button until the vehicle is unlocked again.

If you lock the vehicle centrally using the button on the front door (▷ page 78), you can continue to start the engine with the Start/Stop button.

The engine can be switched off while the vehicle is in motion by pressing and holding the Start/Stop button for three seconds. This function operates independently of the ECO start/stop automatic engine switch-off function.

### Key positions with the Start/Stop button

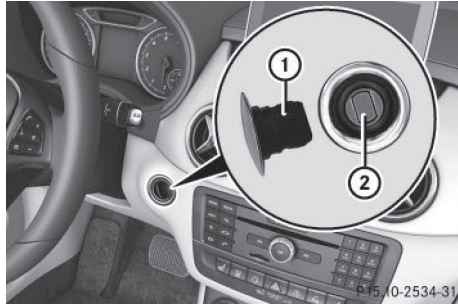

- ① Start/Stop button
- ② Ignition lock

As soon as the ignition is switched on, all the indicator lamps in the instrument cluster light up. Further information on situations where an indicator lamp either fails to go out after starting the engine or lights up while driving (▷ page 237).

If Start/Stop button ① has not yet been pressed, this corresponds to the key being removed from the ignition.

- **To switch on the power supply:** press Start/Stop button ① once.  
The power supply is switched on. You can now activate the windshield wipers, for example.

The power supply is switched off again if:

- the driver's door is opened and
- you press Start/Stop button ① twice when in this position

- **To switch on the ignition:** press Start/Stop button ① twice.

The ignition is switched on.

The ignition is switched off when:

- the driver's door is opened and
- you press Start/Stop button ① twice when in this position

### Removing the Start/Stop button

You can remove the Start/Stop button from the ignition lock and start the vehicle as normal using the SmartKey.

You can only switch between Start/Stop button mode and SmartKey operation when the vehicle is stationary.

You must also engage park position **P**.

- ▶ Remove Start/Stop button ① from ignition lock ②.

You do not have to remove the Start/Stop button from the ignition lock when you leave the vehicle. You should, however, always take the SmartKey with you when leaving the vehicle. As long as the SmartKey is in the vehicle:

- the vehicle can be started using the Start/Stop button
- the electrically powered equipment can be operated

## Starting the engine

### Important safety notes

#### WARNING

If children are left unsupervised in the vehicle, they could:

- open the doors, thus endangering other people or road users.
- get out and disrupt traffic.
- operate the vehicle's equipment.

Additionally, children could set the vehicle in motion if, for example, they:

- release the parking brake.
- shifting the automatic transmission out of park position **P**
- Start the engine.

There is a risk of an accident and injury.

When leaving the vehicle, always take the SmartKey with you and lock the vehicle. Never leave children or animals unattended in the vehicle. Always keep the SmartKey out of reach of children.

#### WARNING

Combustion engines emit poisonous exhaust gases such as carbon monoxide. Inhaling these exhaust gases leads to poisoning. There

is a risk of fatal injury. Therefore never leave the engine running in enclosed spaces without sufficient ventilation.

#### WARNING

Flammable materials introduced through environmental influence or by animals can ignite if in contact with the exhaust system or parts of the engine that heat up. There is a risk of fire.

Carry out regular checks to make sure that there are no flammable foreign materials in the engine compartment or in the exhaust system.

- ❗ Do not depress the accelerator when starting the engine.

### General notes

During a cold start, the engine runs at higher speeds to enable the catalytic converter to reach its operating temperature. The sound of the engine may change during this time.

### Automatic transmission

- ▶ Shift the transmission to position **P** (▷ page 143).

The transmission position display in the multifunction display shows

**P** (▷ page 143).

When the transmission is in position **N**, you can also start the engine with the brake pedal depressed.

### Starting procedure with the SmartKey

To start the engine using the SmartKey instead of the Start/Stop button, pull the Start/Stop button out of the ignition lock.

- ▶ Turn the SmartKey to position **3** (▷ page 135) in the ignition lock and release it as soon as the engine is running.

### Starting procedure with the Start/Stop button

The Start/Stop button can be used to start the vehicle manually without inserting the SmartKey into the ignition lock. The Start/Stop button must be inserted in the ignition lock and the SmartKey must be in the vehicle. This mode for starting the engine operates independently of the ECO start/stop automatic engine start function.

You can start the engine if a valid SmartKey is in the vehicle. Switch off the engine and always take the SmartKey with you when leaving the vehicle, even if you only leave it for a short time. Pay attention to the important safety notes.

- ▶ Depress the brake pedal and keep it depressed.
- ▶ Press the Start/Stop button once (▷ page 135).  
The engine starts.

### Pulling away

#### Automatic transmission

##### WARNING

If the engine speed is above the idling speed and you engage transmission position **D** or **R**, the vehicle could pull away suddenly. There is a risk of an accident.

When engaging transmission position **D** or **R**, always firmly depress the brake pedal and do not simultaneously accelerate.

Depress the accelerator carefully when pulling away.

The vehicle locks centrally once you have pulled away. The locking knobs in the doors drop down.

You can open the doors from the inside at any time.

You can also deactivate the automatic locking feature (▷ page 205).

It is only possible to shift the transmission from position **P** to the desired position if you depress the brake pedal. Only then can the parking lock be deactivated.

If you do not depress the brake pedal, the DIRECT SELECT lever can still be moved but the parking lock remains engaged.

At transmission fluid temperatures below  $-4^{\circ}\text{F}$  ( $-20^{\circ}\text{C}$ ), you can only shift out of park position **P** into another transmission position when the engine is running.

-  Upshifts take place at higher engine speeds after a cold start. This helps the catalytic converter to reach its operating temperature more quickly.

Information on the automatic release of the electric parking brake (▷ page 153).

### Hill start assist

Hill start assist helps you when pulling away forwards or in reverse on an uphill gradient. It holds the vehicle for a short time after you have removed your foot from the brake pedal. This gives you enough time to move your foot from the brake pedal to the accelerator pedal and to depress it before the vehicle begins to roll.

##### WARNING

After a short time, hill start assist will no longer brake your vehicle and it could roll away. There is a risk of an accident and injury.

Therefore, quickly move your foot from the brake pedal to the accelerator pedal. Never leave the vehicle when it is held by hill start assist.

Hill start assist is not active if:

- you are pulling away on a level road or on a downhill gradient.
- the transmission is in position **N**.
- the electric parking brake is applied.
- ESP® is malfunctioning.

Further information on holding the vehicle stationary on uphill gradients (▷ page 146).

## ECO start/stop function

### Introduction

The ECO start/stop function switches the engine off automatically if the vehicle is stopped under certain conditions.

The engine starts automatically when the driver wants to pull away again. The ECO start/stop function thereby helps you to reduce the fuel consumption and emissions of your vehicle.

### Important safety notes

#### WARNING

If the engine is switched off automatically and you exit the vehicle, the engine is restarted automatically. The vehicle may begin moving. There is a risk of accident and injury.

If you wish to exit the vehicle, always turn off the ignition and secure the vehicle against rolling away.

### General notes

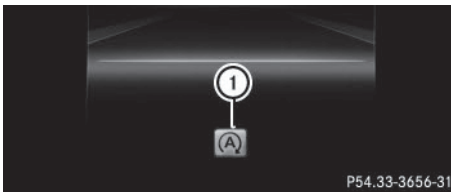

① ECO start/stop display (example: color multifunction display)

If the engine has been switched off automatically by the ECO start/stop function, the  ECO symbol is shown in the multifunction display.

The stop/start function is automatically activated each time you start the engine with the SmartKey.

### Automatic engine switch-off

If the vehicle is braked to a standstill in **D** or **N**, the ECO start/stop function switches off the engine automatically.

The ECO start/stop function is operational when:

- the indicator lamp in the ECO button is lit green.
- the outside temperature is within the range that is suitable for the system.
- the engine is at normal operating temperature.
- the set temperature for the vehicle interior has been reached.
- the battery is sufficiently charged.
- the system detects that the windshield is not fogged up when the air-conditioning system is switched on.
- the hood is closed.
- the driver's door is closed and the driver's seat belt is fastened.

All of the vehicle's systems remain active when the engine is stopped automatically.

The HOLD function can also be activated if the engine has been switched off automatically. It is then not necessary to continue applying the brakes during the automatic stop phase.

When you depress the accelerator pedal, the engine starts automatically and the braking effect of the HOLD function is deactivated.

The engine can be switched off automatically a maximum of four times (first stop and three subsequent stops) in succession.

### Automatic engine start

The engine starts automatically if:

- you switch off the ECO start/stop function by pressing the ECO button
- in transmission position **D** or **N** the brake pedal is released and the HOLD function is not active
- you depress the accelerator pedal
- you engage reverse gear **R**
- you move the transmission out of position **P**
- you unfasten your seat belt or open the driver's door

- the vehicle starts to roll
- the brake system requires this
- the temperature in the vehicle interior deviates from the set range
- the system detects moisture on the windshield when the air-conditioning system is switched on
- the battery's condition of charge is too low

Shifting the transmission to position **P** does not start the engine

### Deactivating/activating the ECO start/stop function

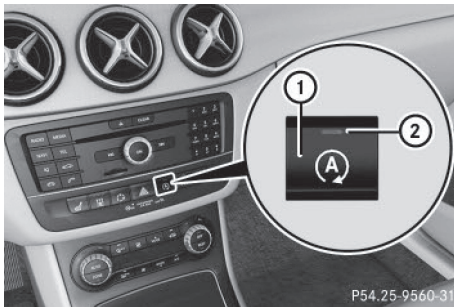

- **To deactivate:** press ECO button ①.  
Indicator lamp ② goes out.
- **To activate:** press ECO button ①.  
Indicator lamp ② lights up.

If the indicator lamp on the ECO button is off, the ECO start/stop function has been deactivated manually or as the result of a malfunction.

Problems with the engine	
Problem	Possible causes/consequences and ► Solutions
The engine does not start.	<p>The HOLD function or DISTRONIC PLUS is activated.</p> <ul style="list-style-type: none"> <li>► Deactivate the HOLD function (▷ page 170) or DISTRONIC PLUS (▷ page 163).</li> <li>► Try to start the engine again.</li> </ul>
The engine does not start. The starter motor can be heard.	<ul style="list-style-type: none"> <li>• There is a malfunction in the engine electronics.</li> <li>• There is a malfunction in the fuel supply.</li> </ul> <p>Before attempting to start the engine again:</p> <ul style="list-style-type: none"> <li>► Turn the key to position <b>0</b> in the ignition lock.</li> </ul> <p>or</p> <ul style="list-style-type: none"> <li>► Press the Start/Stop button repeatedly until all indicator lamps in the instrument cluster go out.</li> <li>► Try to start the engine again (▷ page 137). Avoid excessively long and frequent attempts to start the engine as these will drain the battery.</li> </ul> <p>If the engine does not start after several attempts:</p> <ul style="list-style-type: none"> <li>► Consult a qualified specialist workshop.</li> </ul>
The engine does not start. You cannot hear the starter motor.	<p>The on-board voltage is too low because the battery is too weak or discharged.</p> <ul style="list-style-type: none"> <li>► Jump-start the vehicle (▷ page 293).</li> </ul> <p>If the engine does not start despite attempts to jump-start it:</p> <ul style="list-style-type: none"> <li>► Consult a qualified specialist workshop.</li> </ul> <p>The starter motor was exposed to a thermal load that was too high.</p> <ul style="list-style-type: none"> <li>► Allow the starter motor to cool down for approximately two minutes.</li> <li>► Try to start the engine again.</li> </ul> <p>If the engine still does not start:</p> <ul style="list-style-type: none"> <li>► Consult a qualified specialist workshop, e.g. an authorized Mercedes-Benz Center.</li> </ul>

Problem	Possible causes/consequences and ► Solutions
The engine is not running smoothly and is misfiring.	<p>There is a malfunction in the engine electronics or in a mechanical component of the engine management system.</p> <ul style="list-style-type: none"> <li>► Only depress the accelerator pedal slightly. Otherwise, non-combusted fuel may get into the catalytic converter and damage it.</li> <li>► Have the cause rectified immediately at a qualified specialist workshop.</li> </ul>
The coolant temperature gauge shows a value above 248 °F (120 °C). The coolant warning lamp may also be on and a warning tone may sound.	<p>The coolant level is too low. The coolant is too hot and the engine is no longer being cooled sufficiently.</p> <ul style="list-style-type: none"> <li>► Stop as soon as possible and allow the engine and the coolant to cool down.</li> <li>► Check the coolant level (► page 273). Observe the warning notes as you do so and add coolant if necessary.</li> </ul>

### Automatic transmission

#### Important safety notes

##### WARNING

If the engine speed is above the idling speed and you engage transmission position **D** or **R**, the vehicle could pull away suddenly. There is a risk of an accident.

When engaging transmission position **D** or **R**, always firmly depress the brake pedal and do not simultaneously accelerate.

##### WARNING

The automatic transmission switches to neutral position **N** when you switch off the engine. The vehicle may roll away. There is a risk of an accident.

After switching off the engine, always switch to parking position **P**. Prevent the parked vehicle from rolling away by applying the parking brake.

Bear in mind that the power transmission between the engine and the transmission is interrupted when the engine is switched off.

To prevent the vehicle from rolling away:

- when the engine is switched off and the vehicle is stationary shift the automatic transmission to park position **P** and
- apply the electric parking brake

#### DIRECT SELECT lever

#### Overview of transmission positions

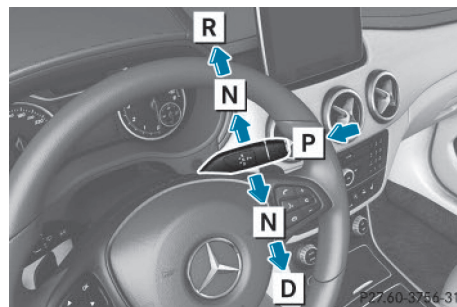

- P** Park position with parking lock
- R** Reverse gear
- N** Neutral
- D** Drive

The DIRECT SELECT lever is on the right of the steering column.



The DIRECT SELECT lever always returns to its original position. The current transmission position **P**, **R**, **N** or **D** appears in the transmission position display in the multifunction display (▷ page 143).

### Transmission position and drive program display

**!** If the transmission position display in the multifunction display is not working, you should pull away carefully to check whether the desired transmission position is engaged. Ideally, you should select transmission position **D** and drive program **E** or **S**.

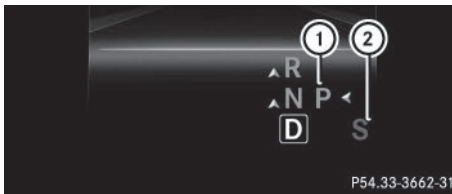

- ① Transmission position display
- ② Drive program display

The current transmission position and drive program appear in the multifunction display. The arrows in the transmission position display show how and into which transmission positions you can shift using the DIRECT SELECT lever.

### Engaging park position P

**!** If the engine speed is too high or the vehicle is moving, do not shift the automatic transmission directly from **D** to **R**, from **R** to **D** or directly to **P**. The automatic transmission could otherwise be damaged.

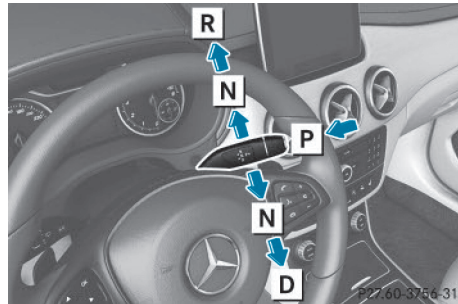

- P** Park position with parking lock
- R** Reverse gear
- N** Neutral
- D** Drive

▶ Push the DIRECT SELECT lever in the direction of arrow **P**.

Transmission position display **P** is shown in the multifunction display.

When you have engaged park position **P**, make sure that the transmission position display shows **P** in the multifunction display.

You can only engage park position **P** when the vehicle is stationary.

Depressing the brake and pushing the DIRECT SELECT lever up or down disengages the parking lock. The transmission is in **N** neutral.

At transmission fluid temperatures below  $-4^{\circ}\text{F}$  ( $-20^{\circ}\text{C}$ ), you can only shift out of park position **P** into another transmission position when the engine is running.

In order to shift from park position **P** directly into **R** or **D**:

- depress the brake pedal and
- push the DIRECT SELECT lever up or down past the first point of resistance

### Engaging park position P automatically

Park position **P** is automatically engaged if:

- you switch off the engine using the SmartKey and remove the SmartKey
- you switch off the engine using the SmartKey or using the Start/Stop button and

open the driver's door or front-passenger door

- the driver's door is opened when the vehicle is stationary or driving at very low speed and the transmission is in position **D** or **R**

### Engaging reverse gear R

**!** Only shift the automatic transmission to **R** when the vehicle is stationary.

- ▶ If the transmission is in position **D** or **N**: push the DIRECT SELECT lever up past the first point of resistance.
- ▶ If the transmission is in position **P**: depress the brake pedal and push the DIRECT SELECT lever up past the first point of resistance.

The ECO start/stop function is not available when reverse gear is engaged. Further information on the ECO start/stop function (▷ page 139).

### Shifting to neutral N

#### WARNING

If children are left unsupervised in the vehicle, they could:

- open the doors, thus endangering other people or road users.
- get out and disrupt traffic.
- operate the vehicle's equipment.

Additionally, children could set the vehicle in motion if, for example, they:

- release the parking brake.
- shifting the automatic transmission out of park position **P**
- Start the engine.

There is a risk of an accident and injury.

When leaving the vehicle, always take the SmartKey with you and lock the vehicle. Never leave children or animals unattended in the vehicle. Always keep the SmartKey out of reach of children.

- ▶ If the transmission is in position **D** or **R**: push the DIRECT SELECT lever up or down to the first point of resistance.
- ▶ If the transmission is in position **P**: depress the brake pedal and push the DIRECT SELECT lever up or down to the first point of resistance.

If you switch the engine off with the transmission in position **R** or **D**, the automatic transmission shifts to **N** automatically.

**With the SmartKey:** if you then open the driver's door or the front-passenger door or remove the SmartKey from the ignition, the automatic transmission shifts to **P** automatically.

**With the Start/Stop button:** if you then open the driver's door or the front-passenger door, the automatic transmission shifts to **P** automatically.

If you want the automatic transmission to remain in neutral **N**, e.g. when having the vehicle cleaned in an automatic car wash with a towing system:

#### Using the SmartKey:

- ▶ Switch on the ignition.
- ▶ Depress the brake pedal and keep it depressed.
- ▶ Shift to neutral **N**.
- ▶ Release the brake pedal.
- ▶ Release the electric parking brake.
- ▶ Switch off the ignition and leave the SmartKey in the ignition lock.

#### With the Start/Stop button:

- ▶ Remove the Start/Stop button from the ignition lock.
- ▶ Insert the SmartKey into the ignition lock.
- ▶ Switch on the ignition.
- ▶ Depress the brake pedal and keep it depressed.
- ▶ Shift to neutral **N**.
- ▶ Release the brake pedal.

- ▶ Release the electric parking brake.
- ▶ Switch off the ignition and leave the SmartKey in the ignition lock.

### Engaging drive position D

- ▶ If the transmission is in position **R** or **N**: push the DIRECT SELECT lever down past the first point of resistance.
- ▶ If the transmission is in position **P**: depress the brake pedal and push the DIRECT SELECT lever down past the first point of resistance.

### Transmission positions

**P**

#### Park position

This prevents the vehicle from rolling away when stopped.

Do not shift the transmission into position **P** (▷ page 143) unless the vehicle is stationary. The parking lock should not be used as a brake when parking. Always apply the electronic parking brake in addition to the parking lock in order to secure the vehicle.

If the vehicle electronics are malfunctioning, the transmission may be locked in position **P**. Have the vehicle electronics checked immediately at a qualified specialist workshop.

Park position **P** is automatically engaged if:

- you switch off the engine using the SmartKey and remove the SmartKey
- you switch off the engine using the SmartKey or using the Start/Stop button and open the driver's door or front-passenger door
- the driver's door is opened when the vehicle is stationary or driving at very low speed and the transmission is in position **D** or **R**

**R**

#### Reverse gear

Only shift the transmission to **R** when the vehicle is stationary.

**N****Neutral**

Do not shift the transmission to **N** while driving. Otherwise, the automatic transmission could be damaged.

No power is transmitted from the engine to the drive wheels.

Releasing the brakes will allow you to move the vehicle freely, e.g. to push it or tow it.

If ESP® is deactivated or faulty: shift the transmission to position **N** if the vehicle is in danger of skidding, e.g. on icy roads.

If you switch the engine off with the transmission in position **R** or **D**, the automatic transmission shifts to **N** automatically.

**!** Rolling in neutral **N** can damage the drive train.

**D****Drive**

The automatic transmission changes gear automatically. All forward gears are available.

**Driving tips****Changing gear**

The automatic transmission shifts to the individual gears automatically when it is in transmission position **D**. This automatic gear shifting behavior is determined by:

- the selected drive program (> page 147)
- the position of the accelerator pedal (> page 146)
- the road speed

**Accelerator pedal position**

Your style of driving influences how the automatic transmission shifts gear:

- little throttle: early upshifts
- more throttle: late upshifts

**Holding the vehicle stationary on uphill gradients****⚠ WARNING**

If the clutch overheats, the electronic management system is automatically deactivated. This interrupts the power transmission. The vehicle may, for example, roll backwards on gradients. There is a risk of an accident.

Never hold the vehicle stationary on uphill gradients by depressing the accelerator.

The clutch may overheat if you hold the vehicle stationary on uphill gradients by depressing the accelerator pedal. If the clutch overheats, a warning tone sounds.

The **Stop Vehicle Shift to P Leave Engine Running** display message appears in the multifunction display. You will only be able to continue your journey once the clutch has cooled down and the display message in the multifunction display has disappeared.

Never hold the vehicle stationary on uphill gradients by depressing the accelerator. Instead, only ever hold the vehicle stationary on uphill gradients by:

- depressing the brake pedal
- activating the HOLD function
- engaging the electric parking brake

**Kickdown**

Use kickdown for maximum acceleration.

- ▶ Depress the accelerator pedal beyond the pressure point.  
The automatic transmission shifts to a lower gear depending on the engine speed.
- ▶ Ease off the accelerator pedal once the desired speed is reached.  
The automatic transmission shifts back up.

For further information on kickdown in manual drive program **M** (> page 148).

### Rocking the vehicle free

Shifting the transmission repeatedly between gears **D** and **R** may help to free the vehicle if it has become stuck in slush or snow. The vehicle's engine management system limits the speed to a maximum of 5 mph (9 km/h) when shifting back and forth. To shift back and forth between transmission positions **D** and **R**, move the DIRECT SELECT lever up and down past the point of resistance.

### Program selector button

The program selector button allows you to choose between drive programs with different driving characteristics.



- ▶ Press program selector button ①. The selected drive program appears in the multifunction display.

The automatic transmission shifts to automatic drive program **E** each time the engine is started.

<b>E</b> Economy	Comfortable, economical driving
<b>S</b> Sport	Sporty driving style
<b>M</b> Manual	Manual gear shifting

For further information on the automatic drive program, see (▷ page 147).

### Steering wheel paddle shifters

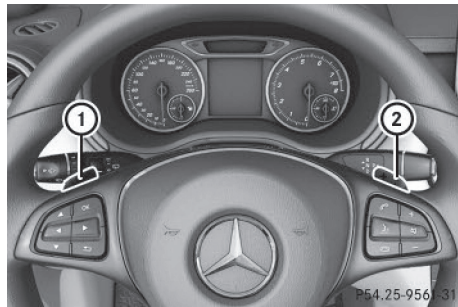

- ① Left steering wheel paddle shifter (shifts down)
- ② Right steering wheel paddle shifter (shifts up)

In drive program **M**, you can change gear yourself using the steering wheel paddle shifters.

If you pull the left or right steering wheel paddle shifter when in automatic drive program **E** or **S**, the automatic transmission shifts into drive program **M** for a limited time. Depending on which paddle shifter is pulled, the automatic transmission immediately shifts into the next gear down or up.

You can only change gear with the steering wheel paddle shifters when the transmission is in position **D**.

For further information on the manual drive program, see (▷ page 148).

### Automatic drive program

Drive program **E** is characterized by the following:

- comfort-oriented engine settings.
- optimal fuel consumption resulting from the automatic transmission shifting up sooner.
- the vehicle pulling away more gently in forward and reverse gears, unless the accelerator pedal is depressed fully.

- increased sensitivity. This improves driving stability on slippery road surfaces, for example.
- the automatic transmission shifting up sooner. This results in the vehicle being driven at lower engine speeds and the wheels being less likely to spin.

Drive program **S** is characterized by the following:

- sporty engine settings.
- the automatic transmission shifting up later.
- the fuel consumption possibly being higher as a result of the later automatic transmission shift points.

### Manual drive program

#### General information

In manual drive program **M**, you can change gear yourself by using the steering wheel paddle shifters. For this, the transmission must be in position **D**. The gear currently selected and engaged is shown in the multifunction display.

Manual drive program **M** differs from drive programs **E** and **S** with regard to spontaneity, responsiveness and smoothness of gear changes.

Gear	Driving situations
<b>3</b>	You can use the engine's braking effect
<b>2</b>	You can use the braking effect of the engine on downhill gradients and for driving: <ul style="list-style-type: none"> <li>• on steep mountain roads</li> <li>• in mountainous terrain</li> <li>• in arduous conditions</li> </ul>
<b>1</b>	To use the braking effect of the engine on extremely steep downhill gradients and on long downhill stretches

### Switching on the manual drive program

#### Activating permanently

- ▶ Press the program selector button (▷ page 147) repeatedly until **M** appears in the multifunction display. Manual drive program **M** remains active until drive program **E** or **S** is engaged.

#### Activating temporarily

- ▶ Pull the right or left steering wheel paddle shifter (▷ page 147). Manual drive program **M** is temporarily active. Depending on which paddle shifter is pulled, the automatic transmission immediately shifts into the next gear down or up.

When manual drive program **M** is activated via the steering wheel paddle shifters, the temporarily active manual drive program **M** will be deactivated automatically after a limited time, if the driving situation permits. In this case, the automatic transmission shifts into the automatic drive program that was last engaged, i.e. **E** or **S**. When driving on downhill gradients, the temporarily active manual drive program **M** will only be deactivated if the accelerator pedal is depressed while the vehicle is rolling downhill.

#### Upshifting

- ▶ Pull the right-hand steering wheel paddle shifter (▷ page 147). The automatic transmission shifts up to the next gear.

To prevent engine damage the automatic transmission shifts up automatically:

- if the maximum engine speed on the currently engaged gear is reached and
- you continue to accelerate.

### Shift recommendation



The gearshift recommendations assist you in adopting an economical driving style. The recommended gear is shown in the multifunction display.

- ▶ Shift to recommended gear ② according to gearshift recommendation ① when shown in the multifunction display of the instrument cluster.

### Downshifting

- ▶ Pull the left-hand steering wheel paddle shifter (▷ page 147).  
The automatic transmission shifts down to the next gear.

If you slow down or stop without shifting down, the automatic transmission automatically shifts down.

For maximum acceleration, pull the left-hand steering wheel paddle shifter until the transmission selects the optimum gear for the current speed.

If the engine exceeds the maximum engine speed when shifting down, the automatic transmission protects against engine damage by not shifting down.

### Kickdown

You can also use kickdown for maximum acceleration in manual drive program **M**.

- ▶ Depress the accelerator pedal beyond the pressure point.  
The automatic transmission shifts to a lower gear depending on the engine speed.
- ▶ Shift back up once the desired speed is reached.

During kickdown, you cannot shift gears using the steering wheel paddle shifters. If you apply full throttle, the automatic transmission shifts up to the next gear when the maximum engine speed is reached. This prevents the engine from overrevving.

### Switching off the manual drive program

- ▶ Press the program selector button (▷ page 147) repeatedly until **E** or **S** appears in the multifunction display.

### Deactivating the temporary manual drive program

- ▶ Pull and hold the right-hand steering wheel paddle shifter until the automatic transmission shifts into the last active automatic drive program: **E** or **S**.

If manual drive program **M** is deactivated, the automatic transmission in automatic drive program **E** or **S** may shift from the current gear into a higher or lower gear. This is dependent on the position of the accelerator pedal, speed and load.

### Problems with the transmission

Problem	Possible causes/consequences and ► Solutions
The transmission has problems shifting gear.	The transmission is losing oil. ► Have the transmission checked at a qualified specialist workshop immediately.
The acceleration ability is deteriorating. The transmission no longer shifts into all of the gears. Reverse gear can no longer be engaged.	The transmission is in emergency mode. ► Stop the vehicle. ► Shift the transmission to position <b>P</b> . ► Switch off the engine. ► Wait at least ten seconds before restarting the engine. ► Shift the transmission to position <b>D</b> . ► Have the transmission checked at a qualified specialist workshop immediately.

### Refueling

#### Important safety notes

#### WARNING

Fuel is highly flammable. If you handle fuel incorrectly, there is a risk of fire and explosion.

You must avoid fire, open flames, creating sparks and smoking. Switch off the engine and, if applicable, the auxiliary heating before refueling.

#### WARNING

Fuel is poisonous and hazardous to health. There is a risk of injury.

You must make sure that fuel does not come into contact with your skin, eyes or clothing and that it is not swallowed. Do not inhale fuel vapors. Keep fuel away from children.

If you or others come into contact with fuel, observe the following:

- Wash away fuel from skin immediately using soap and water.
- If fuel comes into contact with your eyes, immediately rinse them thoroughly with

clean water. Seek medical assistance without delay.

- If fuel is swallowed, seek medical assistance without delay. Do not induce vomiting.
- Immediately change out of clothing which has come into contact with fuel.

#### WARNING

Electrostatic buildup can create sparks and ignite fuel vapors. There is a risk of fire and explosion.

Always touch the vehicle body before opening the fuel filler flap or touching the fuel pump nozzle. Any existing electrostatic buildup is thereby discharged.

- ❗ Do not use diesel to refuel vehicles with a gasoline engine. Do not switch on the ignition if you accidentally refuel with the wrong fuel. Otherwise, the fuel will enter the fuel system. Even small amounts of the wrong fuel could result in damage to the fuel system and the engine. Notify a qualified specialist workshop and have the fuel tank and fuel lines drained completely.



- ❗ Overfilling the fuel tank could damage the fuel system.
- ❗ Take care not to spill any fuel on painted surfaces. You could otherwise damage the paintwork.
- ❗ Use a filter when refueling from a fuel can. Otherwise, the fuel lines and/or injection system could be blocked by particles from the fuel can.

Do not get into the vehicle again during the refueling process. Otherwise, electrostatic charge could build up again.

If you overfill the fuel tank, fuel could spray out when the fuel pump nozzle is removed.

For further information on fuel and fuel quality (▷ page 335).

## Refueling

### General information

The fuel filler flap is unlocked or locked automatically when you unlock or lock the vehicle with the key.

The position of the fuel filler cap is displayed  in the instrument cluster. The arrow on the filling pump indicates the side of the vehicle.

### Opening the fuel filler flap

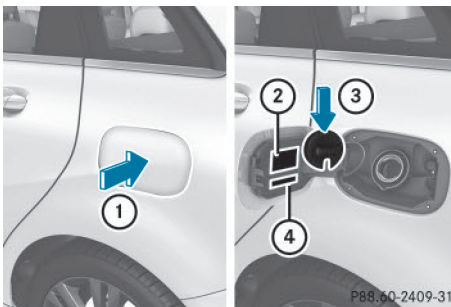

- ① To open the fuel filler flap
- ② Tire pressure table

- ③ To insert the fuel filler cap
- ④ Instruction label for fuel type to be refueled

▶ **Vehicles without KEYLESS-GO:** remove the SmartKey from the ignition lock.

▶ **Vehicles with KEYLESS-GO start-function or KEYLESS-GO:** open the driver's door.

The on-board electronics now have status **0**. This is the same as the SmartKey having been removed.

▶ Press the fuel filler flap in the direction of arrow ①.

The fuel filler flap swings up.

▶ Turn the fuel filler cap counterclockwise and remove it.

▶ Insert the fuel filler cap into the holder on the inside of fuel filler flap ③.

▶ Completely insert the filler neck of the fuel pump nozzle into the tank, hook in place and refuel.

▶ Only fill the tank until the pump nozzle switches off.

Do not add any more fuel after the pump stops filling for the first time. Otherwise, fuel may leak out.

### Closing the fuel filler flap

▶ Replace the cap on the filler neck and turn clockwise until it engages audibly.

▶ Close the fuel filler flap.

Close the fuel filler flap before locking the vehicle.

If you are driving with the fuel filler cap open, the  reserve fuel warning lamp flashes. A message appears in the multifunction display (▷ page 225).

In addition, the  Check Engine warning lamp may light up (▷ page 244).

For further information on warning and indicator lamps in the instrument cluster, see (▷ page 244).

## Problems with fuel and the fuel tank

Problem	Possible causes/consequences and ► Solutions
Fuel is leaking from the vehicle.	<p>The fuel line or the fuel tank is faulty.</p> <p> <b>WARNING</b></p> <p>Risk of explosion or fire.</p> <ul style="list-style-type: none"> <li>► Turn the SmartKey to position <b>0</b> immediately and remove it (▷ page 135).</li> <li>► Do not restart the engine under any circumstances.</li> <li>► Consult a qualified specialist workshop.</li> </ul>
The fuel filler flap cannot be opened.	<p>The fuel filler flap is not unlocked.</p> <ul style="list-style-type: none"> <li>► Unlock the vehicle (▷ page 70).</li> </ul>
	<p>The SmartKey battery is discharged or nearly discharged.</p> <ul style="list-style-type: none"> <li>► Unlock the vehicle using the mechanical key (▷ page 72).</li> </ul>
	<p>The fuel filler flap is unlocked, but the opening mechanism is jammed.</p> <ul style="list-style-type: none"> <li>► Consult a qualified specialist workshop.</li> </ul>

## Parking

## Important safety notes

 **WARNING**

Flammable material such as leaves, grass or twigs may ignite if they come into contact with hot parts of the exhaust system or exhaust gas flow. There is a risk of fire.

Park the vehicle so that no flammable materials come into contact with parts of the vehicle which are hot. Take particular care not to park on dry grassland or harvested grain fields.

 **WARNING**

If you leave children unsupervised in the vehicle, they could set it in motion by, for example:

- release the parking brake.
- shift the automatic transmission out of the parking position **P**.
- start the engine.

In addition, they may operate vehicle equipment and become trapped. There is a risk of an accident and injury.

When leaving the vehicle, always take the SmartKey with you and lock the vehicle. Never leave children unsupervised in the vehicle.

-  Always secure the vehicle correctly against rolling away. Otherwise, the vehicle or its drivetrain could be damaged.

To ensure that the vehicle is secured against rolling away unintentionally:

- the electric parking brake must be applied.
- the transmission must be in position **P** and the transmission position display must show **P**.
- the SmartKey must be removed from the ignition lock.
- on uphill or downhill gradients, the front wheels must be turned towards the curb.

## Switching off the engine

### Important safety notes

#### WARNING

The automatic transmission switches to neutral position **N** when you switch off the engine. The vehicle may roll away. There is a risk of an accident.

After switching off the engine, always switch to parking position **P**. Prevent the parked vehicle from rolling away by applying the parking brake.

### Vehicles with automatic transmission

- ▶ Apply the electric parking brake.
- ▶ Shift the transmission to position **P**.
- ▶ **With the SmartKey:** turn the SmartKey to position **0** in the ignition lock and remove it. The immobilizer is activated.
- ▶ **With the Start/Stop button:** press the Start/Stop button (▷ page 135). The engine stops and all the indicator lamps in the instrument cluster go out. When the driver's door is closed, this corresponds to key position **1**. When the driver's door is open, this corresponds to key position **0**: "Key removed".

If you switch the engine off with the transmission in position **R** or **D**, the automatic transmission shifts to **N** automatically.

**With the SmartKey:** if you then open the driver's door or the front-passenger door or remove the SmartKey from the ignition, the automatic transmission shifts to **P** automatically.

**With the Start/Stop button:** if you then open the driver's door or the front-passenger door, the automatic transmission shifts to **P** automatically.

If you want the automatic transmission to remain in neutral **N**, e.g. when having the vehicle cleaned in an automatic car wash with a towing system:

### Using the SmartKey:

- ▶ Switch on the ignition.
- ▶ Depress the brake pedal and keep it depressed.
- ▶ Shift to neutral **N**.
- ▶ Release the brake pedal.
- ▶ Release the electric parking brake.
- ▶ Switch off the ignition and leave the SmartKey in the ignition lock.

### With the Start/Stop button:

- ▶ Remove the Start/Stop button from the ignition lock.
- ▶ Insert the SmartKey into the ignition lock.
- ▶ Switch on the ignition.
- ▶ Depress the brake pedal and keep it depressed.
- ▶ Shift to neutral **N**.
- ▶ Release the brake pedal.
- ▶ Release the electric parking brake.
- ▶ Switch off the ignition and leave the SmartKey in the ignition lock.

If you attempt to turn off the engine when the selector lever is not in position **P**:

- a message appears in the multifunction display
- a warning signal sounds

## Electric parking brake

### General notes

#### WARNING

If you leave children unsupervised in the vehicle, they could set it in motion by, for example:

- release the parking brake.
- shift the automatic transmission out of the parking position **P**.
- start the engine.

In addition, they may operate vehicle equipment and become trapped. There is a risk of an accident and injury.

When leaving the vehicle, always take the SmartKey with you and lock the vehicle. Never leave children unsupervised in the vehicle.

The function of the electric parking brake is dependent on the on-board voltage. If the on-board voltage is low or there is a malfunction in the system, it may not be possible to apply the released parking brake.



- ▶ If this is the case, only park the vehicle on level ground and secure it to prevent it rolling away.
- ▶ Shift the automatic transmission to position **P**.

It may not be possible to release an applied parking brake if the on-board voltage is low or there is a malfunction in the system. Contact a qualified specialist workshop.

The electric parking brake performs a function test at regular intervals while the engine is switched off. The sounds that can be heard while this is occurring are normal.

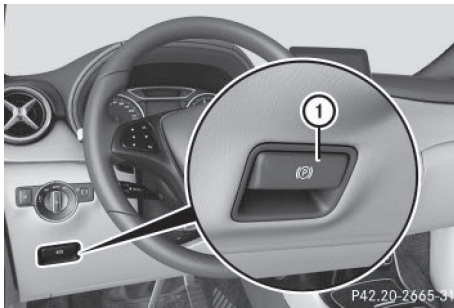
### Applying/releasing manually



- ▶ **To engage:** push handle ①.  
When the electric parking brake is engaged, the  red indicator lamp lights up in the instrument cluster.  
The electric parking brake can also be applied when the SmartKey is removed.
- ▶ **To release:** pull handle ①.  
The red  indicator lamp in the instrument cluster goes out.

The electric parking brake can only be released:

- when the SmartKey is in position **1** or **2** in the ignition lock (▷ page 135) or
- if the ignition was switched on using the Start/Stop button

### Applying automatically

The electric parking brake is automatically applied when the transmission is in position **P** and:

- the engine is switched off or
- the driver is not wearing a seat belt and the driver's door is opened.

To prevent the electric parking brake from being automatically applied, pull handle ①. The electric parking brake is also engaged automatically if:

- DISTRONIC PLUS brings the vehicle to a standstill or
- the HOLD function is keeping the vehicle stationary
- Active Parking Assist is keeping the vehicle stationary

In addition, at least one of the following conditions must be fulfilled:

- there is a system malfunction.
- the power supply is insufficient.
- the vehicle is stationary for a lengthy period.

The red  indicator lamp in the instrument cluster goes out.

The electric parking brake is not automatically engaged if the engine is switched off by the ECO start/stop function.

### Releasing automatically

Your vehicle's electric parking brake is automatically released if all of the following conditions are met:

- the engine is running.
- the transmission is in position **D** or **R**.

- the seat belt has been fastened.
- you depress the accelerator pedal.

If the transmission is in position **R**, the tailgate must be closed.

If your seat belt is not fastened, the following conditions must be fulfilled to automatically release the electric parking brake:

- the driver's door is closed.
- you have shifted out of transmission position **P** or you have previously driven faster than 2 mph (3 km/h).

Ensure that you do not depress the accelerator pedal unintentionally. Otherwise the parking brake will be released and the vehicle will start to move.

### Emergency braking

The vehicle can also be braked during an emergency by using the electric parking brake.

- ▶ While driving, push handle ① of the electric parking brake (▷ page 153).  
The vehicle is braked as long as you keep handle ① of the electric parking brake pressed. The longer the electric parking brake handle ① is depressed, the greater the braking force.

During braking:

- a warning tone sounds
- the **ReRelease park. brake** message appears
- the red  indicator lamp in the instrument cluster flashes

When the vehicle has been braked to a standstill, the electric parking brake is engaged.

### Parking the vehicle for a long period

If you leave the vehicle parked for longer than four weeks, the battery may be damaged by exhaustive discharging.

If you leave the vehicle parked for longer than six weeks, the vehicle may suffer damage as a result of lack of use.

- ▶ Visit a qualified specialist workshop and seek advice.

- ① You can obtain information about trickle chargers from a qualified specialist workshop.

### Driving tips

#### General notes

#### Important safety notes

##### WARNING

If you switch off the ignition while driving, safety-relevant functions are only available with limitations, or not at all. This could affect, for example, the power steering and the brake boosting effect. You will require considerably more effort to steer and brake. There is a risk of an accident.

Do not switch off the ignition while driving.

##### WARNING

If you operate mobile communication equipment while driving, you will be distracted from traffic conditions. You could also lose control of the vehicle. There is a risk of an accident.

Only operate this equipment when the vehicle is stationary.

Observe the legal requirements for the country in which you are driving. Some jurisdictions prohibit the driver from using a mobile phone while driving a vehicle.

If you make a call while driving, always use hands-free mode. Only operate the telephone when the traffic situation permits. If you are unsure, pull over to a safe location and stop before operating the telephone.

Bear in mind that at a speed of only 30 mph (approximately 50 km/h), the vehicle covers a distance of 44 ft (approximately 14 m) per second.

### Drive sensibly – save fuel

Observe the following tips to save fuel:

- The tires should always be inflated to the recommended tire pressure.
- Remove unnecessary loads.
- Remove roof racks when they are not needed.
- Warm up the engine at low engine speeds.
- Avoid frequent acceleration or braking.
- Have all maintenance work carried out as indicated by the service intervals in the Maintenance Booklet or by the service interval display.

Fuel consumption also increases when driving in cold weather, in stop-start traffic and in hilly terrain.

### Drinking and driving

#### WARNING

Drinking and driving and/or taking drugs and driving are very dangerous combinations. Even a small amount of alcohol or drugs can affect your reflexes, perceptions and judgment.

The possibility of a serious or even fatal accident is greatly increased when you drink or take drugs and drive.

Do not drink or take drugs and drive or allow anyone to drive who has been drinking or taking drugs.

### Emission control

#### WARNING

Combustion engines emit poisonous exhaust gases such as carbon monoxide. Inhaling these exhaust gases leads to poisoning. There is a risk of fatal injury. Therefore never leave the engine running in enclosed spaces without sufficient ventilation.

Certain engine systems are designed to keep the level of poisonous components in exhaust fumes within legal limits.

These systems only work at peak efficiency if they are serviced exactly in accordance with the manufacturer's specifications. For this reason, only have work on the engine carried out by qualified and authorized Mercedes-Benz technicians.

The engine settings must not be changed under any circumstances. Furthermore, all specific service work must be carried out at regular intervals and in accordance with the Mercedes-Benz service requirements. Details can be found in the Maintenance Booklet.

### ECO display

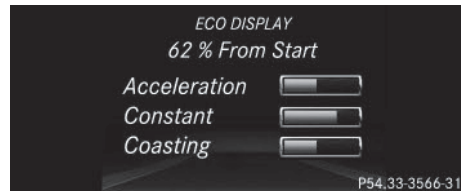

The ECO display provides feedback on how economical your driving characteristics are. The ECO display assists you in achieving the most economical driving style for the selected settings and prevailing conditions. Your driving style can significantly influence the vehicle's consumption.

The ECO display consists of three bars:

- **Acceleration**
- **Constant**
- **Coasting**

The percent value is the average value of the three bars. The three bars and the mean value begin at the value of 50%. A higher percentage indicates a more economical driving style.

The ECO display does not indicate the actual fuel consumption. A fixed percentage count in the ECO display does not indicate a fixed consumption.

Apart from driving style, consumption is dependent on many factors such as, e.g.:

- load
- tire pressure
- cold start
- choice of route
- electrical consumers switched on

These factors are not included in the ECO display.

The evaluation of your driving style is carried out using the following three categories:

- **Acceleration** (evaluation of all acceleration processes):
  - The bar fills up: moderate acceleration, especially at higher speeds
  - The bar empties: sporty acceleration
- **Constant** (assessment of driving behavior at all times)
  - The bar fills up: constant speed and avoidance of unnecessary acceleration and deceleration
  - The bar empties: fluctuations in speed
- **Coasting** (assessment of all deceleration processes)
  - The bar fills up: anticipatory driving, keeping your distance and early release of the accelerator. The vehicle can coast without use of the brakes.
  - The bar empties: frequent braking

An economical driving style specially requires driving at moderate engine speeds.

To achieve a higher value in the categories **Acceleration** and **Constant**:

- observe the gearshift recommendations.
- drive in drive program **E**.

On long journeys at a constant speed, e.g. on the highway, only the bar for **Constant** will change.

The ECO display summarizes the driving characteristics from the start of the journey to its completion. For this reason, the bars change dynamically at the beginning of the journey. On longer journeys, there are fewer changes.

For more dynamic changes, carry out a manual reset.

For further information on the ECO display, see (▷ page 196).

## Braking

### Important safety notes

#### WARNING

If you shift down on a slippery road surface in an attempt to increase the engine's braking effect, the drive wheels could lose their grip. There is an increased danger of skidding and accidents.

Do not shift down for additional engine braking on a slippery road surface.

### Downhill gradients

**!** On long and steep gradients, you must reduce the load on the brakes by shifting to a lower gear in good time. This allows you to take advantage of the engine's braking effect. For this, you need to have selected manual drive program **M**. This helps you to avoid overheating the brakes and wearing them out excessively.

When you take advantage of the engine's braking effect, a drive wheel may not turn for some time, e.g. on a slippery road surface. This could cause damage to the drive train. This type of damage is not covered by the Mercedes-Benz warranty.

Briefly depressing the accelerator pedal on downhill gradients while the manual drive program **M** is temporarily activated: the automatic transmission may switch to the last active automatic drive program **E** or **S**. The automatic transmission may shift to a higher gear. This can reduce the engine's braking effect.

## Heavy and light loads

### WARNING

If you rest your foot on the brake pedal while driving, the braking system can overheat. This increases the stopping distance and can even cause the braking system to fail. There is a risk of an accident.

Never use the brake pedal as a footrest. Never depress the brake pedal and the accelerator pedal at the same time.

- ! Depressing the brake pedal constantly results in excessive and premature wear to the brake pads.

If the brakes have been subjected to a heavy load, do not stop the vehicle immediately. Drive on for a short while. This allows the air-flow to cool the brakes more quickly.

## Wet roads

If you have driven for a long time in heavy rain without braking, there may be a delayed reaction from the brakes when braking for the first time. This may also occur after the vehicle has been washed or driven through deep water.

You have to depress the brake pedal more firmly. Maintain a greater distance from the vehicle in front.

After driving on a wet road or having the vehicle washed, brake firmly while paying attention to the traffic conditions. This will warm up the brake discs, thereby drying them more quickly and protecting them against corrosion.

## Limited braking performance on salt-treated roads

If you drive on salted roads, a layer of salt residue may form on the brake discs and brake pads. This can result in a significantly longer braking distance.

- In order to prevent any salt build-up, apply the brakes occasionally while paying attention to the traffic conditions.
- Carefully depress the brake pedal at the beginning and end of a journey.
- Maintain a greater distance to the vehicle ahead.

## Servicing the brakes

- ! If the red brake warning lamp lights up in the instrument cluster and you hear a warning tone while the engine is running, the brake fluid level may be too low. Observe additional warning messages in the multi-function display.

The brake fluid level may be too low due to brake pad wear or leaking brake lines.

Have the brake system checked immediately. This work should be carried out at a qualified specialist workshop.

- ! A function or performance test should only be carried out on a 2-axle dynamometer. If you are planning to have the vehicle tested on such a dynamometer, contact an authorized Mercedes-Benz Center to obtain further information first. Otherwise, you could damage the drive train or the brake system.

- ! As the ESP<sup>®</sup> system operates automatically, the engine and the ignition must be switched off (the SmartKey must be in position **0** or **1** in the ignition lock) if:

- the electric parking brake is tested on a brake dynamometer (for a maximum of ten seconds)
- the vehicle is towed with the front axle raised.

Braking triggered automatically by ESP<sup>®</sup> may seriously damage the brake system.

All checks and maintenance work on the brake system must be carried out at a qualified specialist workshop. Consult a qualified specialist workshop to arrange this.



Have brake pads installed and brake fluid replaced at a qualified specialist workshop. If the brake system has only been subject to moderate loads, you should test the functionality of your brakes at regular intervals.

You can find a description of Brake Assist (BAS) on (▷ page 61).

Mercedes-Benz recommends that you only have brake pads/linings installed on your vehicle which have been approved for Mercedes-Benz vehicles or which correspond to an equivalent quality standard. Brake pads/linings which have not been approved for Mercedes-Benz vehicles or which are not of an equivalent quality could affect your vehicle's operating safety.

Mercedes-Benz recommends that you only use brake fluid that has been specially approved for your vehicle by Mercedes-Benz, or which corresponds to an equivalent quality standard. Brake fluid which has not been approved for Mercedes-Benz vehicles or which is not of an equivalent quality could affect your vehicle's operating safety.

### Checking brake lining thickness

You can measure the brake pad/lining thickness using a test gage. Color-coding (green or red) on the test gage allows you to determine whether the brake pad/lining thickness is still sufficient. The test gage is in the vehicle document wallet in the glove box.

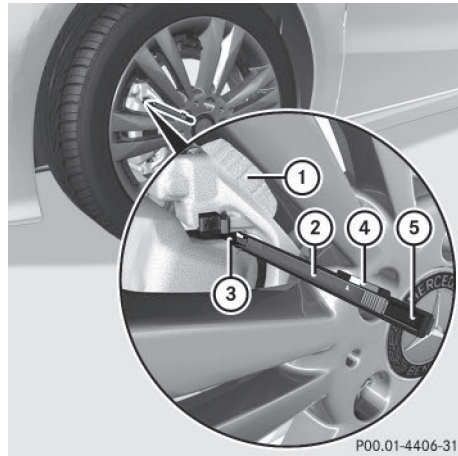

Front wheel

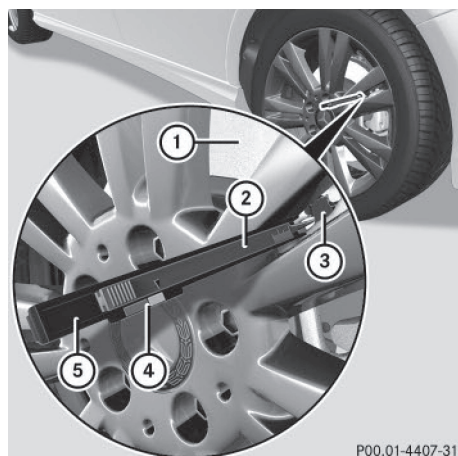

Rear wheel

- ▶ Bring the vehicle and wheels into a suitable position so that you can attach test gage (5).
- ▶ Secure the vehicle against rolling away (▷ page 152).
- ▶ Engage park position **P**.
- ▶ Switch off the engine.
- ▶ Place test gage (5) between the wheel's spokes on brake pad/lining (3).

- ▶ Hold test gage ⑤ vertically on brake disc ① and slide measuring pin ② onto brake disc ①.
- ▶ Check which color field ④ the arrow on measuring pin ② is pointing to.
  - Green:** the brake pad/lining thickness is sufficient.
  - Red:** the brake pad/lining thickness is not sufficient. Have the brake pads/lining checked at a qualified specialist workshop.

To avoid an inaccurate measurement:

- make sure you position the wheels suitably
- do not put the measuring pin on a recess in the brake disc

### Driving on wet roads

#### Hydroplaning

If water has accumulated to a certain depth on the road surface, there is a danger of hydroplaning occurring, even if:

- you drive at low speeds.
- the tires have adequate tread depth.

For this reason, in the event of heavy rain or in conditions in which hydroplaning may occur, you must drive in the following manner:

- lower your speed.
- avoid ruts.
- avoid sudden steering movements.
- brake carefully.

#### Driving on flooded roads

**!** Do not drive through flooded areas. Check the depth of any water before driving through it. Drive slowly through standing water. Otherwise, water may enter the vehicle interior or the engine compartment. This can damage the electronic components in the engine or the automatic transmission. Water can also be drawn in by the engine's air suction nozzles and this can cause engine damage.

### Winter driving

#### WARNING

If you shift down on a slippery road surface in an attempt to increase the engine's braking effect, the drive wheels could lose their grip. There is an increased danger of skidding and accidents.

Do not shift down for additional engine braking on a slippery road surface.

#### DANGER

If the exhaust pipe is blocked or adequate ventilation is not possible, poisonous gases such as carbon monoxide (CO) may enter the vehicle. This is the case, e.g. if the vehicle becomes trapped in snow. There is a risk of fatal injury.

If you leave the engine or the auxiliary heating running, make sure the exhaust pipe and area around the vehicle are clear of snow. To ensure an adequate supply of fresh air, open a window on the side of the vehicle that is not facing into the wind.

Have your vehicle winter-proofed at a qualified specialist workshop at the onset of winter.

Drive particularly carefully on slippery road surfaces. Avoid sudden acceleration, steering and braking maneuvers. Do not use the cruise control or DISTRONIC PLUS.

If the vehicle threatens to skid or cannot be stopped when moving at low speed:

- ▶ Shift the transmission to position **N**.
- ▶ Try to bring the vehicle under control using corrective steering.

The outside temperature indicator is not designed to serve as an ice-warning device and is therefore unsuitable for that purpose. Changes in the outside temperature are displayed after a short delay.

Indicated temperatures just above the freezing point do not guarantee that the road surface is free of ice. The road may still be icy, especially in wooded areas or on bridges.

You should pay special attention to road conditions when temperatures are around freezing point.

For more information on driving with snow chains, see (▷ page 305).

For more information on driving with summer tires, see (▷ page 304).

Observe the notes in the "Winter operation" section (▷ page 304).

## Driving systems

### Cruise control

#### General notes

Cruise control maintains a constant road speed for you. It brakes automatically in order to avoid exceeding the set speed. On long and steep downhill gradients, especially if the vehicle is laden, you must select a low gear in good time. For this, you will need to have selected manual drive program **M** (▷ page 148). By doing so, you will make use of the braking effect of the engine. This relieves the load on the brake system and prevents the brakes from overheating and wearing too quickly.

Use cruise control only if road and traffic conditions make it appropriate to maintain a steady speed for a prolonged period. You can store any road speed above 20 mph (30 km/h).

The speed indicated in the speedometer may differ slightly from the speed stored.

#### Important safety notes

If you fail to adapt your driving style, cruise control can neither reduce the risk of an accident nor override the laws of physics. Cruise control cannot take into account the road, traffic and weather conditions. Cruise control is only an aid. You are responsible for the distance to the vehicle in front, for vehicle speed, for braking in good time and for staying in your lane.

Do not use cruise control:

- in road and traffic conditions which do not allow you to maintain a constant speed e.g. in heavy traffic or on winding roads
- on slippery road surfaces. Braking or accelerating could cause the drive wheels to lose traction and the vehicle could then skid
- when there is poor visibility, e.g. due to fog, heavy rain or snow

If there is a change of drivers, advise the new driver of the speed stored.

#### Cruise control lever

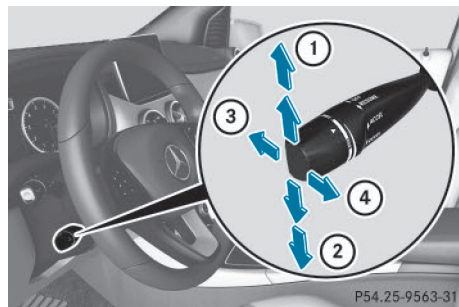

- ① To activate or increase speed
- ② To activate or reduce speed
- ③ Deactivating cruise control
- ④ To activate at the current speed/last stored speed

When you activate cruise control, the stored speed is shown in the multifunction display for five seconds.

#### Activation conditions

To activate cruise control, all of the following activation conditions must be fulfilled:

- the electric parking brake must be released.
- ESP® must be active, but not intervening.
- the transmission must be in position **D**.

## Storing, maintaining and calling up a speed

### Storing and maintaining the current speed

You can store the current speed if you are driving faster than 20 mph (30 km/h).

- ▶ Accelerate the vehicle to the desired speed.
- ▶ Briefly press the cruise control lever up ① or down ④.
- ▶ Remove your foot from the accelerator pedal.  
Cruise control is activated. The vehicle automatically maintains the stored speed.

**i** Cruise control may be unable to maintain the stored speed on uphill gradients. The stored speed is resumed when the gradient evens out. Cruise control maintains the stored speed on downhill gradients by automatically applying the brakes.

### Storing the current speed or calling up the last stored speed

#### WARNING

If you call up the stored speed and it differs from the current speed, the vehicle accelerates or decelerates. If you do not know the stored speed, the vehicle could accelerate or brake unexpectedly. There is a risk of an accident.

Pay attention to the road and traffic conditions before calling up the stored speed. If you do not know the stored speed, store the desired speed again.

- ▶ Briefly pull the cruise control lever towards you ③.
- ▶ Remove your foot from the accelerator pedal.  
The first time cruise control is activated, it stores the current speed or regulates the speed of the vehicle to the previously stored speed.

## Setting a speed

Keep in mind that it may take a brief moment until the vehicle has accelerated or braked to the speed set.

- ▶ Press the cruise control lever up ① for a higher speed or down ④ for a lower speed.
- ▶ **To adjust the set speed in 1 mph increments (1 km/h increments):** briefly press the cruise control lever up ① or down ④ to the pressure point.  
The last stored speed increases or decreases in 1 mph (1 km/h) increments.
- ▶ **To adjust the set speed in 5 mph increments (10 km/h increments):** briefly press the cruise control lever up ① or down ④ to the pressure point.  
The last stored speed increases or decreases in 5 mph (10 km/h) increments.

**i** Cruise control is not deactivated if you depress the accelerator pedal. For example, if you accelerate briefly to overtake, cruise control adjusts the vehicle's speed to the last speed stored after you have finished overtaking.

## Deactivating cruise control

There are several ways to deactivate cruise control:

- ▶ Briefly press the cruise control lever forwards ③.
- or
- ▶ Brake.

Cruise control is automatically deactivated if:

- the vehicle is secured with the electric parking brake
- you are driving at less than 20 mph (30 km/h)
- ESP® intervenes or you deactivate ESP®
- you shift the transmission to position **N** while driving

If cruise control is deactivated, you will hear a warning tone. You will see the **Cruise Con-**

tro1 Off message in the multifunction display for approximately five seconds.

- i** When you switch off the engine, the last speed stored is cleared.

## DISTRONIC PLUS

### General notes

DISTRONIC PLUS regulates the speed and automatically helps you maintain the distance to the vehicle detected in front. Vehicles are detected with the aid of the radar sensor system. DISTRONIC PLUS brakes automatically to avoid exceeding the set speed or to maintain the designated distance from the vehicle in front.

Change into a lower gear in good time on long and steep downhill gradients. This is especially important if the vehicle is laden. By doing so, you will make use of the braking effect of the engine. This relieves the load on the brake system and prevents the brakes from overheating and wearing too quickly.

If DISTRONIC PLUS detects that there is a risk of a collision, you will be warned visually and acoustically. DISTRONIC PLUS cannot prevent a collision without your intervention. An intermittent warning tone will then sound and the distance warning lamp will light up in the instrument cluster. Brake immediately in order to increase the distance to the vehicle in front or take evasive action provided it is safe to do so.

DISTRONIC PLUS operates in range between 0 mph (0 km/h) and 120 mph (200 km/h).

Do not use DISTRONIC PLUS while driving on roads with steep gradients.

### Important safety notes

#### WARNING

DISTRONIC PLUS does not react to:

- people or animals
- stationary obstacles on the road, e.g. stopped or parked vehicles
- oncoming and crossing traffic

As a result, DISTRONIC PLUS may neither give warnings nor intervene in such situations.

There is a risk of an accident.

Always pay careful attention to the traffic situation and be ready to brake.

#### WARNING

DISTRONIC PLUS cannot always clearly identify other road users and complex traffic situations.

In such cases, DISTRONIC PLUS may:

- give an unnecessary warning and then brake the vehicle
- neither give a warning nor intervene
- accelerate or brake unexpectedly

There is a risk of an accident.

Continue to drive carefully and be ready to brake, in particular when warned to do so by DISTRONIC PLUS.

#### WARNING

DISTRONIC PLUS brakes your vehicle with up to 50% of the maximum possible deceleration. If this braking force is insufficient, DISTRONIC PLUS warns you visually and audibly. There is a risk of an accident.

In such cases, apply the brakes yourself and try to take evasive action.

- !** If DISTRONIC PLUS or the HOLD function is activated, the vehicle brakes automatically in certain situations.

To prevent damage to the vehicle, deactivate DISTRONIC PLUS and the HOLD function in the following or other similar situations:

- when towing the vehicle
- in the car wash

If you fail to adapt your driving style, DISTRONIC PLUS can neither reduce the risk of accident nor override the laws of physics. DISTRONIC PLUS cannot take into account the road, traffic and weather conditions. DISTRONIC PLUS is only an aid. You are responsible for the distance to the vehicle in front, for vehicle speed, for braking in good time and for staying in your lane.

Do not use DISTRONIC PLUS:

- in road and traffic conditions which do not allow you to maintain a constant speed e.g. in heavy traffic or on winding roads
- on slippery road surfaces. Braking or accelerating could cause the drive wheels to lose traction and the vehicle could then skid
- when there is poor visibility, e.g. due to fog, heavy rain or snow

DISTRONIC PLUS may not detect narrow vehicles driving in front, e.g. motorcycles, or vehicles driving on a different line.

In particular, the detection of obstacles can be impaired if:

- there is dirt on the sensors or anything else covering the sensors
- there is snow or heavy rain
- there is interference by other radar sources
- there are strong radar reflections, for example, in parking garages

If DISTRONIC PLUS no longer detects a vehicle in front, DISTRONIC PLUS may unexpectedly accelerate the vehicle to the stored speed.

This speed may:

- be too high if you are driving in a filter lane or an exit lane
- be so high when driving in the right-hand lane that you overtake vehicles in the left-hand lane
- be so high when driving in the left-hand lane that you overtake vehicles in the right-hand lane

If there is a change of drivers, advise the new driver of the speed stored.

### Cruise control lever

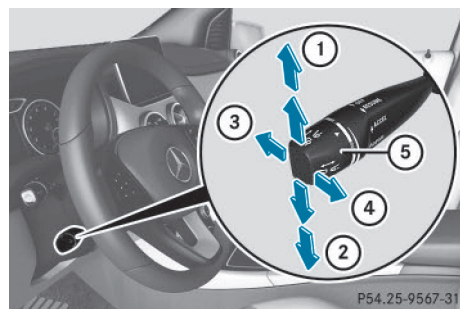

- ① To activate or increase speed
- ② To activate or reduce speed
- ③ Deactivating DISTRONIC PLUS
- ④ To activate at the current speed/last stored speed
- ⑤ Setting the specified minimum distance

### Activating DISTRONIC PLUS

#### Activation conditions

To activate DISTRONIC PLUS, all of the following activation conditions must be fulfilled:

- the engine must be started. It may take up to two minutes after pulling away before DISTRONIC PLUS is operational.
- the electric parking brake must be released.
- ESP® must be active, but not intervening.
- Active Parking Assist must not be activated.
- the transmission must be in position **D**.

- the driver's door must be closed when you shift from **P** to **D** or your seat belt must be fastened.
- the front-passenger door and rear doors must be closed.

### Arming

- ▶ Briefly pull the cruise control lever towards you ④, up ① or down ⑤. DISTRONIC PLUS is selected.
  - ▶ Keep the cruise control lever pressed up ① or down ⑤ until the desired speed is set.
  - ▶ Remove your foot from the accelerator pedal. Your vehicle adapts its speed to that of the vehicle in front, but only up to the desired stored speed.
- i** If you do not fully release the accelerator pedal, the **DISTRONIC PLUS Passive** message appears in the multifunction display. The set distance to a slower-moving vehicle in front will then not be maintained. You will be driving at the speed you determine by the position of the accelerator pedal.

You can also activate DISTRONIC PLUS when stationary. The lowest speed that can be set is 30 km/h.

### Driving with DISTRONIC PLUS

#### Pulling away and driving

The vehicle can also pull away when it is facing an unidentified obstacle or is driving on a different line from another vehicle. The vehicle then brakes automatically. Be ready to brake at all times.

If you depress the brake, DISTRONIC PLUS is deactivated unless your vehicle is stationary.

#### ▶ If you want to pull away with

**DISTRONIC PLUS:** remove your foot from the brake pedal.

- ▶ Briefly pull the cruise control lever (▷ page 164) towards you ④.

or

- ▶ Accelerate briefly.

Your vehicle pulls away and adapts its speed to that of the vehicle in front.

If no vehicle is detected in front, your vehicle accelerates to the set speed.

If there is no vehicle in front, DISTRONIC PLUS operates in the same way as cruise control.

If DISTRONIC PLUS detects that the vehicle in front has slowed down, it brakes your vehicle. In this way, the distance you have selected is maintained.

If DISTRONIC PLUS detects a faster-moving vehicle in front, it increases the driving speed. The vehicle is only accelerated up to the speed you have stored.

#### Selecting the drive program

DISTRONIC Plus supports a sporty driving style when you have selected the **S** or **M** driving program (▷ page 147). Acceleration behind the vehicle in front or to the set speed is then noticeably more dynamic. If you have selected the **E** (AMG vehicles: **C**) drive program, the vehicle accelerates more gently. This setting is recommended in stop-and-start traffic.

#### Changing lanes

If you change to the passing lane, DISTRONIC PLUS supports you when:

- you are driving faster than 70 km/h
- DISTRONIC PLUS is maintaining the distance to a vehicle in front
- you switch on the appropriate turn signal
- DISTRONIC PLUS does not detect a danger of collision

If these conditions are fulfilled, your vehicle is accelerated. Acceleration will be interrupted

if changing lanes takes too long or if the distance between your vehicle and the vehicle in front becomes too small.

### Stopping

#### WARNING

When leaving the vehicle, even if it is braked only by DISTRONIC PLUS, it could roll away if:

- there is a malfunction in the system or in the voltage supply.
- DISTRONIC PLUS has been deactivated with the cruise control lever, e.g. by a vehicle occupant or from outside the vehicle.
- the electrical system in the engine compartment, the battery or the fuses have been tampered with.
- the battery is disconnected.
- the accelerator pedal has been depressed, e.g. by a vehicle occupant.

There is a risk of an accident.

If you wish to exit the vehicle, always turn off DISTRONIC PLUS and secure the vehicle against rolling away.

For further information on deactivating DISTRONIC PLUS (▷ page 167).

If DISTRONIC PLUS detects that the vehicle in front is stopping, it brakes your vehicle until it is stationary.

Once your vehicle is stationary, it remains stationary and you do not need to depress the brake.

- i** After a time, the electric parking brake secures the vehicle and relieves the service brake.
- i** Depending on the specified minimum distance, your vehicle will come to a standstill at a sufficient distance behind the vehicle in front. The specified minimum distance is set using the control on the cruise control lever.

When the HOLD function is activated, the transmission is shifted automatically to position **P** if:

- the driver's seat belt is not fastened and the driver's door is open.
- the engine is switched off, unless it is automatically switched off by the ECO start/stop function.

The electric parking brake secures the vehicle automatically if DISTRONIC PLUS is activated when the vehicle is stationary and:

- a system malfunction occurs.
- the power supply is not sufficient.

If a malfunction in the electric parking brake occurs, then the transmission may also be shifted into position **P** automatically.

### Setting a speed

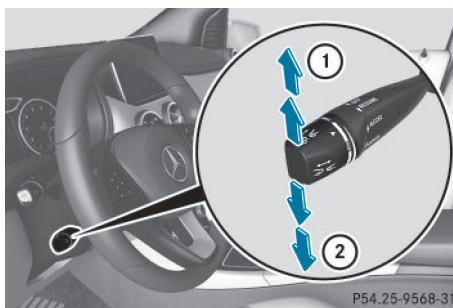

- ① To store the current speed or a higher speed
- ② To store the current speed or a lower speed

Keep in mind that it may take a brief moment until the vehicle has accelerated or braked to the speed set.

- ▶ Press the cruise control lever up ① for a higher speed or down ② for a lower speed.

- i** DISTRONIC PLUS is not deactivated if you depress the accelerator pedal. If you accelerate to overtake, DISTRONIC PLUS adjusts the vehicle's speed to the last speed stored after you have finished overtaking.



### Setting the specified minimum distance

You can set the specified minimum distance for DISTRONIC PLUS by varying the time span between one and two seconds. With this function, you can set the minimum distance that DISTRONIC PLUS keeps to the vehicle in front, dependent on vehicle speed. You can see this distance in the multifunction display (▷ page 168).

- i** Make sure that you maintain the minimum distance to the vehicle in front as required by law. Adjust the distance to the vehicle in front if necessary.

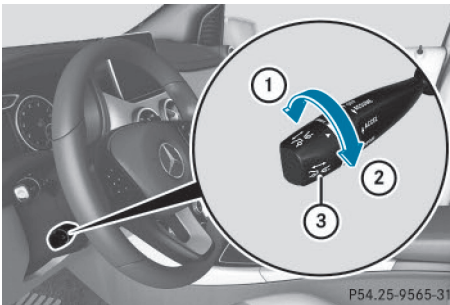

- ▶ **To increase:** turn control ③ in direction ②. DISTRONIC PLUS then maintains a greater distance between your vehicle and the vehicle in front.
- ▶ **To decrease:** turn control ③ in direction ①. DISTRONIC PLUS then maintains a shorter distance between your vehicle and the vehicle in front.

### Deactivating DISTRONIC PLUS

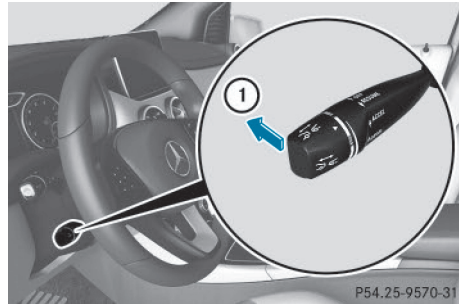

There are several ways to deactivate DISTRONIC PLUS:

- ▶ Briefly press the cruise control lever forwards ①.
- or

- ▶ Brake, unless the vehicle is stationary

If you deactivate DISTRONIC PLUS, you will see the **DISTRONIC PLUS Off** message in the multifunction display for approximately five seconds.

- i** The last speed stored remains stored until you switch off the engine. DISTRONIC PLUS is not deactivated if you depress the accelerator pedal.

DISTRONIC PLUS is automatically deactivated if:

- you engage the electric parking brake or if the vehicle is automatically secured with the electric parking brake
- ESP® intervenes or you deactivate ESP®
- the transmission is in the **P**, **R** or **N** position
- you pull the cruise control lever towards you in order to pull away and the front-passenger door or one of the rear doors is open
- the vehicle is skidding
- you activate Active Parking Assist

If DISTRONIC PLUS is deactivated, you will hear a warning tone. You will see the **DISTRONIC PLUS Off** message in the multifunction display for approximately five seconds.

## DISTRONIC PLUS displays in the instrument cluster

### Displays in the speedometer



Example: DISTRONIC PLUS displays in the speedometer

When DISTRONIC PLUS is activated and there are no vehicles detected in front, one or two segments ② in the set speed range light up. If DISTRONIC PLUS detects a vehicle in front, segments ② between speed of the vehicle in front ③ and stored speed ① light up.

**i** For design reasons, the speed displayed in the speedometer may differ slightly from the speed set for DISTRONIC PLUS.

### Display when DISTRONIC PLUS is deactivated

**Vehicles with a black and white multifunction display:** you can select the distance display function using the on-board computer.

**Vehicles with a color multifunction display:** in the Assistance menu of the on-board computer, you can select the assistance graphic.

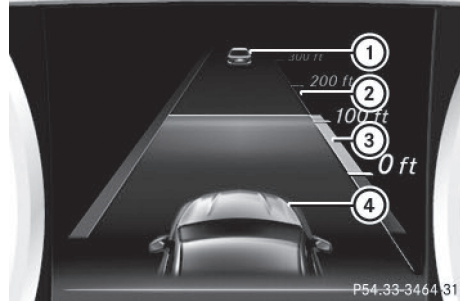

### Assistance graphic

- ① Vehicle in front, if detected
- ② Distance indicator, current distance to the vehicle in front
- ③ Specified minimum distance to the vehicle in front; adjustable
- ④ Own vehicle

► **Vehicles with color multifunction display:** select the **Assistance Graphic** function using the on-board computer (> page 202).

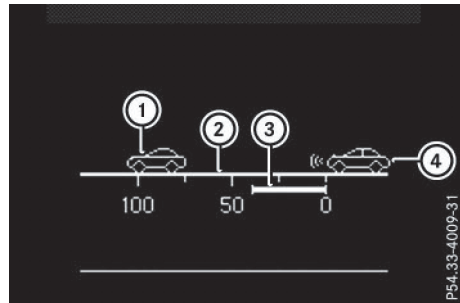

Distance display in vehicles with a black and white multifunction display

- ① Vehicle in front, if detected
- ② Distance indicator, current distance to the vehicle in front
- ③ Specified minimum distance to the vehicle in front; adjustable
- ④ Own vehicle

► **Vehicles with black and white multifunction display:** select the **Distance Display** function using the on-board computer (> page 202).

**Display when DISTRONIC PLUS is activated**

You will initially see the stored speed for about five seconds when you activate DISTRONIC PLUS.

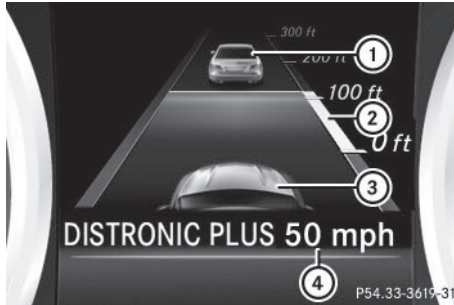

Assistance graphic

- ① Vehicle in front, if detected
- ② Specified minimum distance to the vehicle in front; adjustable
- ③ Own vehicle
- ④ DISTRONIC PLUS active (text only appears when the cruise control lever is actuated)

► **Vehicles with color multifunction display:** select the **Assistance Graphic** function using the on-board computer (> page 202).

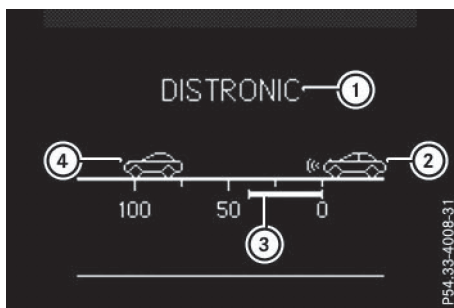

Distance display in vehicles with a black and white multifunction display

- ① DISTRONIC PLUS activated
- ② Own vehicle
- ③ Specified minimum distance to the vehicle in front; adjustable
- ④ Vehicle in front, if detected

► **Vehicles with black and white multifunction display:** select the **Distance Display** function using the on-board computer (> page 202).

**Tips for driving with DISTRONIC PLUS**

**General notes**

The following contains descriptions of certain road and traffic conditions in which you must be particularly attentive. In such situations, brake if necessary. DISTRONIC PLUS is then deactivated.

**Cornering, going into and coming out of a bend**

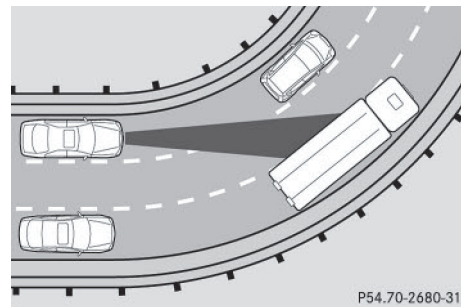

The ability of DISTRONIC PLUS to detect vehicles when cornering is limited. Your vehicle may brake unexpectedly or late.

**Vehicles traveling on a different line**

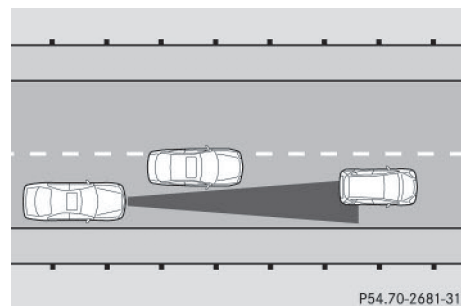

DISTRONIC PLUS may not detect vehicles traveling on a different line. The distance to the vehicle in front will be too short.

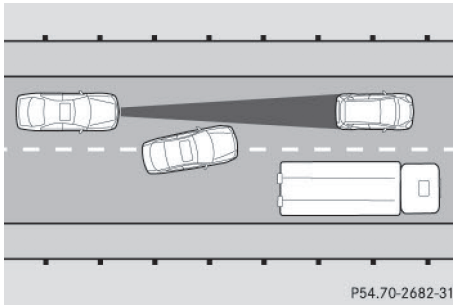
**Other vehicles changing lanes**

DISTRONIC PLUS has not detected the vehicle cutting in yet. The distance to this vehicle will be too short.

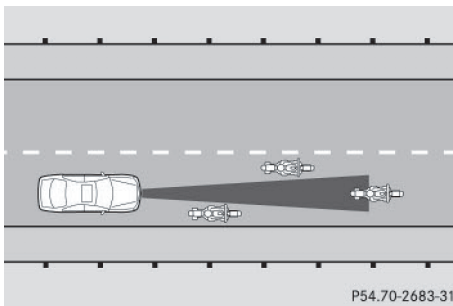
**Narrow vehicles**

DISTRONIC PLUS has not yet detected the vehicle in front on the edge of the road, because of its narrow width. The distance to the vehicle in front will be too short.

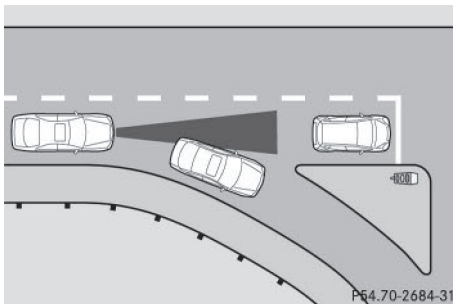
**Obstructions and stationary vehicles**

DISTRONIC PLUS does not brake for obstacles or stationary vehicles. If, for example, the

detected vehicle turns a corner and reveals an obstacle or stationary vehicle, DISTRONIC PLUS will not brake for these.

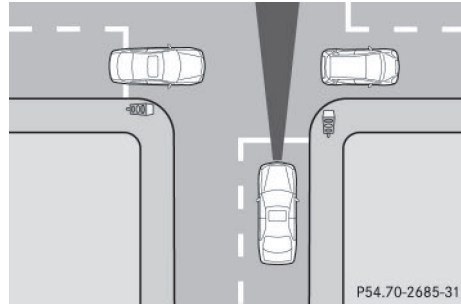
**Crossing vehicles**

DISTRONIC PLUS may detect vehicles that are crossing your lane by mistake. Activating DISTRONIC PLUS at traffic lights with crossing traffic, for example, could cause your vehicle to pull away unintentionally.

**HOLD function****General notes**

The HOLD function can assist the driver in the following situations:

- when pulling away, especially on steep slopes
- when maneuvering on steep slopes
- when waiting in traffic

The vehicle is kept stationary without the driver having to depress the brake pedal.

The braking effect is canceled and the HOLD function deactivated when you depress the accelerator pedal to pull away.

## Important safety notes

### WARNING

When leaving the vehicle, it can still roll away despite being braked by the HOLD function if:

- there is a malfunction in the system or in the voltage supply.
- the HOLD function has been deactivated by pressing the accelerator pedal or the brake pedal, e.g. by a vehicle occupant.
- the electrical system in the engine compartment, the battery or the fuses have been tampered with.
- the battery is disconnected

There is a risk of an accident.

If you wish to exit the vehicle, always turn off the HOLD function and secure the vehicle against rolling away.

**!** If DISTRONIC PLUS or the HOLD function is activated, the vehicle brakes automatically in certain situations.

To prevent damage to the vehicle, deactivate DISTRONIC PLUS and the HOLD function in the following or other similar situations:

- when towing the vehicle
- in the car wash

Deactivating the HOLD function  
(▷ page 171).

### Activation conditions

You can activate the HOLD function if:

- the vehicle is stationary
- the engine is running or if it has been automatically switched off by the ECO start/stop function
- the driver's door is closed or your seat belt is fastened
- the electric parking brake is released
- DISTRONIC PLUS is deactivated
- the transmission is in position **D**, **R** or **N** on vehicles with automatic transmission

## Activating the HOLD function



- ▶ Make sure that the activation conditions are met.
- ▶ Depress the brake pedal.
- ▶ Quickly depress the brake pedal further until ① appears in the multifunction display.  
The HOLD function is activated. You can release the brake pedal.

**i** If depressing the brake pedal the first time does not activate the HOLD function, wait briefly and then try again.

## Deactivating the HOLD function

The HOLD function is deactivated automatically if:

- you accelerate. On vehicles with automatic transmission: only when the transmission is in position **D** or **R**.
- the transmission is in position **P** on vehicles with automatic transmission.
- you depress the brake pedal again with a certain amount of pressure until ① disappears from the multifunction display.
- you activate DISTRONIC PLUS.
- you secure the vehicle using the electric parking brake.

**i** After a time, the electric parking brake secures the vehicle and relieves the service brake.

When the HOLD function is activated, the transmission is shifted automatically to position **P** if:

- the driver's seat belt is not fastened and the driver's door is open.
- the engine is switched off, unless it is automatically switched off by the ECO start/stop function.

The electric parking brake secures the vehicle automatically if the HOLD function is activated when the vehicle is stationary and:

- a system malfunction occurs.
- the power supply is not sufficient.

#### 4MATIC

**!** Never tow the vehicle with one axle raised. This may damage the differential. Damage of this sort is not covered by the Mercedes-Benz Limited Warranty. All wheels must remain either on the ground or be fully raised. Observe the instructions for towing the vehicle with all wheels in full contact with the ground.

4MATIC, together with ESP<sup>®</sup>, improves the traction of your vehicle whenever a drive wheel spins due to insufficient grip.

If you fail to adapt your driving style, 4MATIC can neither reduce the risk of accident nor override the laws of physics. 4MATIC cannot take account of road, weather and traffic conditions. 4MATIC is only an aid. You are responsible for the distance to the vehicle in front, for vehicle speed, for braking in good time and for staying in your lane.

If a drive wheel spins due to insufficient grip:

- Only depress the accelerator pedal as far as necessary when pulling away.
- Accelerate less when driving.

**i** In wintry driving conditions, the maximum effect of 4MATIC can only be achieved if you use winter tires (M+S tires), with snow chains if necessary.

#### PARKTRONIC

##### Important safety notes

PARKTRONIC is an electronic parking aid with ultrasonic sensors. It monitors the area around your vehicle using six sensors in the front bumper and six sensors in the rear bumper. PARKTRONIC indicates visually and audibly the distance between your vehicle and an object.

PARKTRONIC is only an aid. It is not a replacement for your attention to your immediate surroundings. You are always responsible for safe maneuvering, parking and exiting a parking space. When maneuvering, parking or pulling out of a parking space, make sure that there are no persons, animals or objects in the area in which you are maneuvering.

**!** When parking, pay particular attention to objects above or below the sensors, such as flower pots or trailer drawbars.

PARKTRONIC does not detect such objects when they are in the immediate vicinity of the vehicle. You could damage the vehicle or the objects.

The sensors may not detect snow and other objects that absorb ultrasonic waves.

Ultrasonic sources such as an automatic car wash, the compressed-air brakes on a truck or a pneumatic drill could cause PARKTRONIC to malfunction.

PARKTRONIC may not function correctly on uneven terrain.

PARKTRONIC is activated automatically when you:

- switch on the ignition
- shift the transmission to position **D**, **R** or **N**
- release the electric parking brake

## Range of the sensors

### General notes

PARKTRONIC does not take objects into consideration that are:

- below the detection range, e.g. people, animals or objects.
- above the detection range, e.g. overhanging loads, truck overhangs or loading ramps.



- ① Sensors in the front bumper, left-hand side (example)

The sensors must be free from dirt, ice or slush. They can otherwise not function correctly. Clean the sensors regularly, taking care not to scratch or damage them (▷ page 279).

## Range

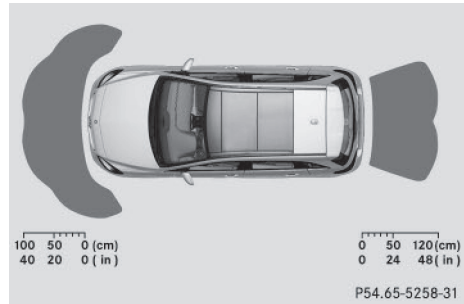

If there is an obstacle within this range, the relevant warning displays light up and a warning tone sounds. If the distance falls below the minimum, the distance may no longer be shown.

## Warning displays

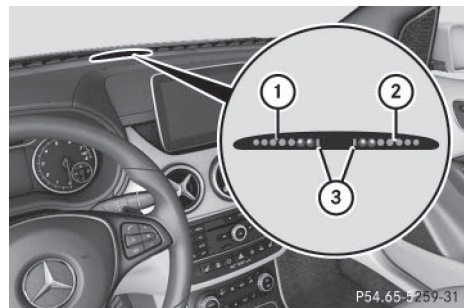

Warning display for the front area

- ① Segments on the left-hand side of the vehicle
- ② Segments on the right-hand side of the vehicle
- ③ Segments showing operational readiness

The warning displays show the distance between the sensors and the obstacle. The warning display for the front area is located

on the dashboard above the center air vents. The warning display for the rear area is located on the headliner in the rear compartment. The warning display for each side of the vehicle is divided into five yellow and two red segments. PARKTRONIC is operational if yellow segments showing operational readiness ③ light up.

One or more segments light up as the vehicle approaches an obstacle, depending on the vehicle's distance from the obstacle.

From the:

- sixth segment onwards, you will hear an intermittent warning tone for approximately two seconds.
- seventh segment onwards, you will hear a warning tone for approximately two seconds. This indicates that you have now reached the minimum distance.

### Deactivating/activating PARKTRONIC

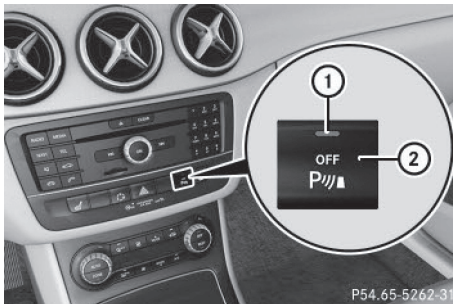

- ① Indicator lamp
- ② Deactivating/activating PARKTRONIC

If indicator lamp ① lights up, PARKTRONIC is deactivated.

- i** PARKTRONIC is automatically activated when you turn the key to position **2** in the ignition lock.



## Problems with PARKTRONIC

Problem	Possible causes/consequences and ► Solutions
Only the red segments in the PARKTRONIC warning displays are lit. You also hear a warning tone for approximately two seconds. PARKTRONIC is then deactivated and the indicator lamp on the PARKTRONIC button lights up.	PARKTRONIC has malfunctioned and has switched off. ► If problems persist, have PARKTRONIC checked at a qualified specialist workshop.
Only the red segments in the PARKTRONIC warning displays are lit. PARKTRONIC is then deactivated.	The PARKTRONIC sensors are dirty or there is interference. ► Clean the PARKTRONIC sensors (▷ page 279). ► Switch the ignition back on.  The problem may be caused by an external source of radio or ultrasound waves. ► See if PARKTRONIC functions in a different location.

### Active Parking Assist

#### General notes

Active Parking Assist is an electronic parking aid with ultrasound. It measures the road on both sides of the vehicle. A parking symbol indicates a suitable parking space. Active steering intervention and brake application can assist you during parking and when exiting a parking space. You may also use PARKTRONIC (▷ page 172).

#### Important safety notes

Active Parking Assist is merely an aid. It is not a replacement for your attention to your immediate surroundings. You are always responsible for safe maneuvering, parking and exiting a parking space. Make sure that no persons, animals or objects are in the maneuvering range.

When PARKTRONIC is switched off, Active Parking Assist is also unavailable.

#### WARNING

While parking or pulling out of a parking space, the vehicle swings out and can drive onto areas of the oncoming lane. This could result in a collision with another road user. There is a risk of an accident.

Pay attention to other road users. Stop the vehicle if necessary or cancel the Active Parking Assist parking procedure.

**!** If unavoidable, you should drive over obstacles such as curbs slowly and not at a sharp angle. Otherwise, you may damage the wheels or tires.

Active Parking Assist may possibly indicate parking spaces which are not suitable for parking, for example:

- where parking or stopping is prohibited
- in front of driveways or entrances and exits
- on unsuitable surfaces

Parking tips:

- On narrow roads, drive as close to the parking space as possible.
- Parking spaces that are littered or overgrown might be identified or measured incorrectly.
- Parking spaces that are partially occupied by trailer drawbars might not be identified as such or be measured incorrectly.
- Snowfall or heavy rain may lead to a parking space being measured inaccurately.
- Pay attention to the PARKTRONIC (> page 173) warning messages during the parking procedure.
- You can intervene in the steering procedure to correct it at any time. Active Parking Assist will then be canceled.
- When transporting a load which protrudes from your vehicle, you should not use Active Parking Assist.
- Never use Active Parking Assist when snow chains are installed.
- Make sure that the tire pressures are always correct. This has a direct influence on the parking characteristics of the vehicle.

Use Active Parking Assist for parking spaces:

- that are parallel or at right-angles to the direction of travel
- that are on straight roads, not bends
- that are on the same level as the road, e.g. not on the pavement

### Detecting parking spaces

Objects located above the height range of Active Parking Assist will not be detected when the parking space is measured. These are not taken into account when the parking procedure is calculated, e.g. overhanging loads, tail sections or loading ramps of goods vehicles.

### WARNING

If there are objects above the detection range:

- Active Park Assist may steer too early
- the vehicle may not stop in front of these objects.

You may cause a collision as a result. There is a risk of an accident.

If there are objects above the detection range, stop and deactivate Active Parking Assist.

For further information on the detection range (> page 173).

Active Parking Assist does not assist you parking in spaces at right angles to the direction of travel if:

- two parking spaces are located directly next to one another
- the parking space is directly next to a low obstacle such as a low curb
- you park forwards

Active Parking Assist does not assist you parking in spaces that are parallel or at right angles to the direction of travel if:

- the parking space is on a curb
- the system reads the parking space as being blocked, for example by foliage or grass paving blocks
- the area is too small for the vehicle to maneuver into
- the parking space is bordered by an obstacle, e.g. a tree, a post or a trailer

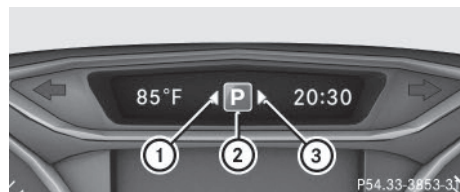

① Detected parking space on the left

② Parking symbol

③ Detected parking space on the right



Active Parking Assist is switched on automatically when driving forwards. The system is operational at speeds of up to approximately

22 mph (35 km/h). While in operation, the system independently locates and measures parking spaces on both sides of the vehicle.

Active Parking Assist will only detect parking spaces:

- that are parallel or at right-angles to the direction of travel
- that are parallel to the direction of travel and at least 59 in (1.5 m) wide
- that are parallel to the direction of travel and at least 39.5 in (1.0 m) longer than your vehicle
- that are at right angles to the direction of travel and at least 39.5 in (1.0 m) wider than your vehicle

**i** Note that Active Parking Assist cannot measure the length of a parking space if it is at right angles to the direction of travel. You will need to judge whether your vehicle will fit into the parking space.

When driving at speeds below 19 mph (30 km/h), you will see parking symbol  as a status indicator in the instrument cluster. When a parking space has been detected, an arrow towards the right or the left also appears. By default, Active Parking Assist only displays parking spaces on the front-passenger side. Parking spaces on the driver's side are displayed as soon as the turn signal on the driver's side is activated. When parking on the driver's side, this must remain activated until you confirm the use of Active Parking Assist by pressing the  button on the multifunction steering wheel. The system automatically determines whether the parking space is parallel or at right-angles to the direction of travel.

A parking space is displayed while you are driving past it, and until you are approximately 50 ft (15 m) away from it.

## Parking

### WARNING

If you leave the vehicle when it is only being braked by Active Parking Assist it could roll away if:

- there is a malfunction in the system or in the voltage supply.
- the electrical system in the engine compartment, the battery or the fuses have been tampered with.
- the battery is disconnected.
- the accelerator pedal has been depressed, e.g. by a vehicle occupant.

There is a risk of an accident.

Before leaving the vehicle, always secure it against rolling away.

**i** When PARKTRONIC detects obstacles, Active Parking Assist brakes automatically during the parking process. You are responsible for braking in good time.

► Stop the vehicle when the parking space symbol shows the desired parking space in the instrument cluster.

► Shift the transmission to position **R**. The **Start Park Assist? Yes: OK No:**  message appears in the multifunction display.

► **To cancel the procedure:** press the  button on the multifunction steering wheel or pull away.

or

► **To park using Active Parking Assist:** press the  button on the multifunction steering wheel.

The **Park Assist Active Accelerate and Brake Observe Surroundings** message appears in the multifunction display.

► Let go of the multifunction steering wheel.  
 ► Back up the vehicle, being ready to brake at all times. When backing up, drive at a speed below approximately 6 mph (10 km/h).

Otherwise Active Parking Assist will be canceled.

Active Parking Assist brakes the vehicle to a standstill when the vehicle approaches the rear border of the parking space.

Maneuvering may be required in tight parking spaces.

The **Park Assist Active Select D Observe Surroundings** message appears in the multifunction display.

- ▶ Shift the transmission to position **D** while the vehicle is stationary. Active Parking Assist immediately steers in the other direction.

The **Park Assist Active Accelerate and Brake Observe Surroundings** message appears in the multifunction display.

- ❗ You will achieve the best results by waiting for the steering procedure to complete before pulling away.

- ▶ Drive forwards and be ready to brake at all times.

Active Parking Assist brakes the vehicle to a standstill when the vehicle approaches the front border of the parking space.

Maneuvering may be required in tight parking spaces.

The **Park Assist Active Select R Observe Surroundings** message appears in the multifunction display.

As soon as the parking procedure is complete, the **Park Assist Switched Off** message appears and a warning tone sounds. The vehicle is now parked.

The vehicle is kept stationary without the driver having to depress the brake pedal. The braking effect is canceled when you depress the accelerator pedal.

Active Parking Assist no longer supports you with steering interventions and brake applications. When Active Parking Assist is finished, you must steer and brake again yourself. PARKTRONIC is still available.

Parking tips:

- The way your vehicle is positioned in the parking space after parking is dependent on various factors. These include the position and shape of the vehicles parked in front and behind it and the conditions of the location. It may be the case that Active Parking Assist guides you too far into a parking space, or not far enough into it. In some cases, it may also lead you across or onto the curb. If necessary, you should cancel the parking procedure with Active Parking Assist.
- You can also select preselect transmission position **D**. The vehicle redirects and does not drive as far into the parking space. Should the transmission change take place too early, the parking procedure will be canceled. A sensible parking position can no longer be achieved from this position.



### Exiting a parking space

In order that Active Parking Assist can support you when you exit the parking space:

- you need to have parked using Active Parking Assist.
- the border of the parking space must be high enough at the front and the rear. A curb is too small, for example.
- the border of the parking space must not be too wide, as the position of the vehicle must not exceed an angle of 45° to the starting position as it is maneuvering into the parking space.
- a maneuvering distance of at least 3.3 ft (1.0 m) must be available.

Active Parking Assist can only assist you with exiting a parking space if you have parked the vehicle parallel to the direction of travel using Active Parking Assist.

- ❗ If PARKTRONIC detects obstacles, Active Parking Assist brakes automatically whilst the vehicle exits the parking space. You are responsible for braking in good time.

- ▶ Start the engine.
- ▶ Release the electric parking brake.
- ▶ Switch on the turn signal in the direction you are pulling away.
- ▶ Shift the transmission to position **D** or **R**. The **Start Park Assist? Yes: OK No:** message appears in the multifunction display .
- ▶ **To cancel the procedure:** press the  button on the multifunction steering wheel or pull away.

or

- ▶ **To exit a parking space using Active Parking Assist:** press the  button on the multifunction steering wheel. The **Park Assist Active Accelerate and Brake Observe Surroundings** message appears in the multifunction display.
  - ▶ Let go of the multifunction steering wheel.
  - ▶ Pull away, being ready to brake at all times. Do not exceed a maximum speed of approximately 6 mph (10 km/h) when exiting a parking space. Otherwise Active Parking Assist will be canceled.
  - ▶ Depending on the message or as required, shift the transmission to position **D** or **R**. Active Parking Assist immediately steers in the other direction. The **Park Assist Active Accelerate and Brake Observe Surroundings** message appears in the multifunction display.
- i** You will achieve the best results by waiting for the steering procedure to complete before pulling away.
- If you back up after activation, the steering wheel is moved to the straight-ahead position.
- ▶ Drive forwards and back up as prompted by the PARKTRONIC warning displays, several times if necessary.

Once you have exited the parking space completely, the steering wheel is moved to the straight-ahead position. You hear a tone and the **Park Assist Finished** message appears in the multifunction display. You will

then have to steer and merge into traffic on your own. PARKTRONIC is still available. You can take over the steering, before the vehicle has exited the parking space completely. This is useful, for example when you recognize that it is already possible to pull out of the parking space.

### Canceling Active Parking Assist

- ▶ Stop the movement of the multifunction steering wheel or steer yourself. Active Parking Assist will be canceled at once. The **Park Assist Canceled** message appears in the multifunction display.

or

- ▶ Press the PARKTRONIC button ( $\triangleright$  page 174). PARKTRONIC is switched off and Active Parking Assist is immediately canceled. The **Park Assist Canceled** message appears in the multifunction display.

Active Parking Assist is canceled automatically if:

- the electric parking brake is engaged
- transmission position **P** is selected
- parking using Active Parking Assist is no longer possible
- you are driving faster than 6 mph (10 km/h)
- a wheel spins, ESP<sup>®</sup> intervenes or fails. The  warning lamp lights up in the instrument cluster

A warning tone sounds. The parking symbol disappears and the multifunction display shows the **Park Assist Canceled** message.

When Active Parking Assist is canceled, you must steer and brake again yourself.

If a system malfunction occurs, the vehicle is braked to a standstill. To drive on, depress the accelerator again.

## Rear view camera

### General notes

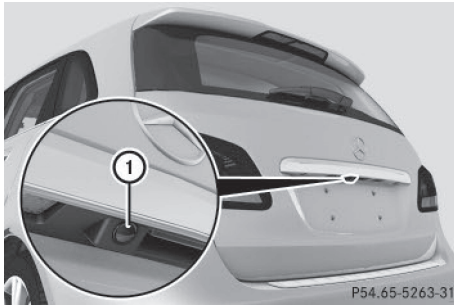

The rear view camera ① is an optical parking and maneuvering aid. It uses guide lines to show the area behind your vehicle in the Audio/COMAND display.

The area behind the vehicle is displayed as a mirror image, as in the rear view mirror.

**i** The text shown in the Audio/COMAND display depends on the language setting. The following are examples of rear view camera messages in the Audio/COMAND display.

Observe the notes on cleaning (▷ page 279).

### Important safety notes

The rear view camera is only an aid. It is not a replacement for your attention to your immediate surroundings. You are always responsible for safe maneuvering and parking. When maneuvering or parking, make sure that there are no persons, animals or objects in the area in which you are maneuvering.

Under the following circumstances, the rear view camera will not function, or will function in a limited manner:

- if the trunk lid is open
- in heavy rain, snow or fog
- at night or in very dark places
- if the camera is exposed to very bright light
- if the area is lit by fluorescent bulbs or LED lighting (the display may flicker)

- if there is a sudden change in temperature, e.g. when driving into a heated garage in winter
- if the camera lens is dirty or obstructed. Observe the notes on cleaning (▷ page 279)
- if the rear of your vehicle is damaged. In this event, have the camera position and setting checked at a qualified specialist workshop

The field of vision and other functions of the rear view camera may be restricted due to additional accessories on the rear of the vehicle (e.g. license plate holder, bicycle rack).

### Activating/deactivating the rear view camera

- ▶ **To activate:** make sure that the key is in position **2** in the ignition lock.
- ▶ Make sure that the **Activation by R gear** function is selected in Audio 20/COMAND; see the Digital Operator's Manual.
- ▶ Engage reverse gear. The area behind the vehicle is shown with guide lines in the Audio 20/COMAND display. The image from the rear view camera is available throughout the maneuvering process.

**To deactivate:** the rear view camera deactivates if you shift the transmission to **P** or after driving forwards a short distance.

### Displays in the Audio 20/COMAND display

The rear view camera may show a distorted view of obstacles, show them incorrectly or not at all. The rear view camera does not show objects in the following positions:

- very close to the rear bumper
- under the rear bumper
- in the area immediately above the tailgate handle

**!** Objects not at ground level may appear to be further away than they actually are, e.g.:

- the bumper of a parked vehicle
- the drawbar of a trailer
- the ball coupling of a trailer tow hitch
- the rear section of an HGV
- a slanted post

Use the guidelines only for orientation. Approach objects no further than the bottom-most guideline.

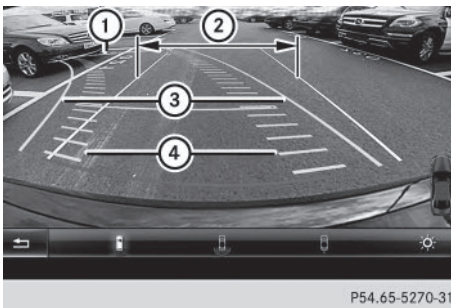

P54.65-5270-31

- ① Yellow guide line at a distance of approximately 13 ft (4.0 m) from the rear of the vehicle
- ② White guide line without turning the steering wheel, vehicle width including the exterior mirrors (static)
- ③ Yellow guide line for the vehicle width including the exterior mirrors, for current steering wheel angle (dynamic)
- ④ Yellow lane marking tires at current steering wheel angle (dynamic)

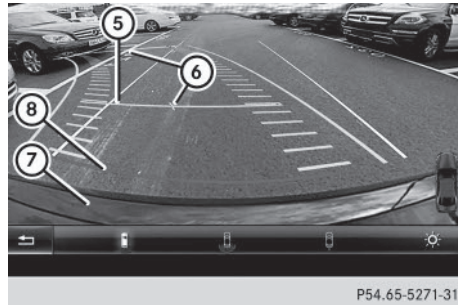

P54.65-5271-31

- ⑤ Yellow guide line at a distance of approximately 3 ft (1.0 m) from the rear of the vehicle
- ⑥ Vehicle center axle (marker assistance)
- ⑦ Bumper
- ⑧ Red guide line at a distance of approximately 12 in (0.30 m) from the rear of the vehicle



P54.65-5272-31

- ① Front warning display
- ② Additional PARKTRONIC measurement operational readiness indicator
- ③ Rear warning display

**Vehicles with PARKTRONIC:** when PARKTRONIC is operational (> page 173), additional measurement operational readiness indicator ② appears in the Audio 20/COMAND display. If the PARKTRONIC warning displays are active or light up, warning displays ① and ③ are also active or light up correspondingly in the Audio 20/COMAND display.

### "Reverse parking" function

Backing up straight into a parking space without turning the steering wheel

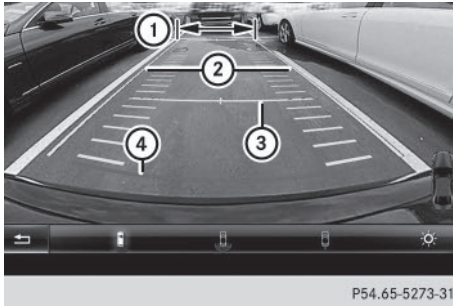

- ① White guide line without turning the steering wheel, vehicle width including the exterior mirrors (static)
  - ② Yellow guide line for the vehicle width including the exterior mirrors, for current steering wheel angle (dynamic)
  - ③ Yellow guide line at a distance of approximately 3 ft (1.0 m) from the rear of the vehicle
  - ④ Red guide line at a distance of approximately 12 in (0.30 m) from the rear of the vehicle
- ▶ Make sure that the rear view camera is switched on (▷ page 180). The lane and the guide lines are shown.
  - ▶ With the help of white guide line ①, check whether the vehicle will fit into the parking space.
  - ▶ Using white guide line ① as a guide, carefully back up until you reach the end position. Red guide line ④ is then at the end of the parking space. The vehicle is almost parallel in the parking space.

### Reverse perpendicular parking with the steering wheel at an angle

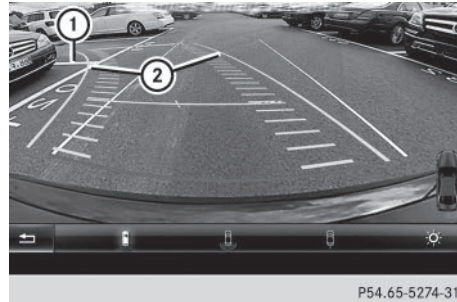

- ① Parking space marking
  - ② Yellow guide line for the vehicle width including the exterior mirrors, for current steering wheel angle (dynamic)
- ▶ Drive past the parking space and bring the vehicle to a standstill.
  - ▶ Make sure that the rear view camera is switched on (▷ page 180). The lane and the guide lines are shown.
  - ▶ While the vehicle is at a standstill, turn the steering wheel in the direction of the parking space until yellow guide line ② reaches parking space marking ①.
  - ▶ Keep the steering wheel in that position and back up carefully.



- ① Yellow guide line for the vehicle width including the exterior mirrors, for current steering wheel angle (dynamic)



- ▶ Stop the vehicle when it is almost exactly in front of the parking space. The white lane should be as close to parallel with the parking space marking as possible.

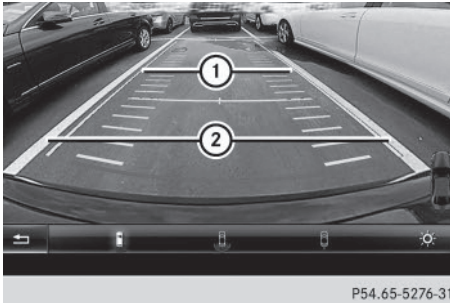

P54.65-5276-31

- ① White guide line at current steering wheel angle
  - ② Parking space marking
- ▶ Turn the steering wheel to the center position while the vehicle is stationary.

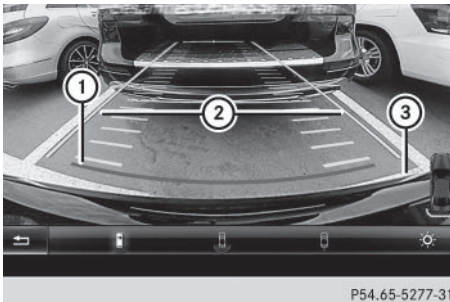

P54.65-5277-31

- ① Red guide line at a distance of approximately 12 in (0.30 m) from the rear of the vehicle
  - ② White guide line without turning the steering wheel
  - ③ End of parking space
- ▶ Back up carefully until you have reached the final position. Red guide line ① is then at end of parking space ③. The vehicle is almost parallel in the parking space.

## Wide-angle function

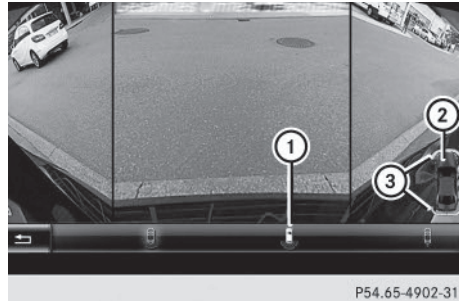

P54.65-4902-31

- ① Symbol for the wide-angle view function
- ② Own vehicle
- ③ PARKTRONIC warning displays

You can also use the rear view camera to select a wide-angle view.

When PARKTRONIC is operational (> page 173), a symbol for your own vehicle appears in the Audio 20/COMAND display. If the PARKTRONIC warning displays are active, warning displays ③ light up in the Audio 20/COMAND display in yellow or red respectively.

## ATTENTION ASSIST

### General notes

ATTENTION ASSIST helps you during long, monotonous journeys, such as on highways. It is active in the 37 mph (60 km/h) to 125 mph (200 km/h) range. If ATTENTION ASSIST detects typical indicators of fatigue or increasing lapses in concentration on the part of the driver, it suggests taking a break.

### Important safety notes

ATTENTION ASSIST is only an aid to the driver. It might not always recognize fatigue or increasing inattentiveness in time or fail to recognize them at all. The system is not a substitute for a well-rested and attentive driver.

The functionality of ATTENTION ASSIST is restricted and warnings may be delayed or not occur at all:

- if the length of the journey is less than approximately 30 minutes
- if the road condition is poor, e.g. if the surface is uneven or if there are potholes
- if there is a strong side wind
- if you have adopted a sporty driving style with high cornering speeds or high rates of acceleration
- if you are predominantly driving slower than 37 mph (60 km/h) or faster than 125 mph (200 km/h)
- if the time has been set incorrectly
- in active driving situations, such as when you change lanes or change your speed

ATTENTION ASSIST is reset when you continue your journey and starts assessing your tiredness again if:

- you switch off the engine
- you take off your seat belt and open the driver's door, e.g. for a change of drivers or to take a break

### Displaying Attention Level with black and white multifunction display



- ▶ Select the status overview using the on-board computer (▷ page 201).
- ▶ Press  to display the ATTENTION ASSIST assessment.

The following information is displayed:

- length of the journey since the last break.
- the attention level determined by ATTENTION ASSIST (**Attention Level**), displayed in a bar display in five levels from high to low
- If ATTENTION ASSIST is unable to calculate the attention level and cannot issue a warning, the **System Suspended** message appears. The bar display then changes the display, e.g. if you are driving at a speed below 37 mph (60 km/h) or above 124 mph (200 km/h).

### Displaying Attention Level with color multifunction display



You can have current status information displayed in the assistance menu (▷ page 201) of the on-board computer.

- ▶ Select the Assistance display for Attention Assist using the on-board computer (▷ page 202).

The following information is displayed:

- length of the journey since the last break.
- the attention level determined by ATTENTION ASSIST (**Attention Level**), displayed in a bar display in five levels from high to low
- If ATTENTION ASSIST is unable to calculate the attention level and cannot issue a warning, the **System Suspended** message appears. The bar display then changes the display, e.g. if you are driving at a speed

below 37 mph (60 km/h) or above 124 mph (200 km/h).

### Activating ATTENTION ASSIST

- ▶ Activate ATTENTION ASSIST using the on-board computer (▷ page 203).  
The system determines the attention level of the driver depending on the setting selected:

Selection **Standard**: the sensitivity with which the system determines the attention level is set to normal.

Selection **Sensitive**: the sensitivity is set higher. The attention level detected by Attention Assist is adapted accordingly and the driver is warned earlier.

**Vehicles with black and white multifunction display**: when ATTENTION ASSIST is activated, the multifunction display in the status overview shows the  symbol.

**Vehicles with color multifunction display**: when ATTENTION ASSIST is deactivated, the multifunction display in the assistance graphic shows the  symbol.

When ATTENTION ASSIST has been deactivated, it is automatically reactivated after the engine has been stopped. The sensitivity selected corresponds to the last selection activated (standard/sensitive).

### Warning in the multifunction display

If fatigue or increasing lapses in concentration are detected, a warning appears in the multifunction display: **ATTENTION ASSIST Take a Break!**

In addition to the message shown in the multifunction display, you will then hear a warning tone.

- ▶ If necessary, take a break.
- ▶ Confirm the message by pressing the  button on the steering wheel.

On long journeys, take regular breaks in good time to allow yourself to rest properly. If you do not take a break and ATTENTION ASSIST

still detects increasing lapses in concentration, you will be warned again after 15 minutes at the earliest. This will only happen if ATTENTION ASSIST still detects typical indicators of fatigue or increasing lapses in concentration.

If a warning is output in the multifunction display, a service station search is performed in COMAND. You can select a service station and navigation to this service station will then begin. This function can be activated and deactivated in COMAND.

### Lane Tracking package

#### General notes

The Lane Tracking package consists of Blind Spot Assist (▷ page 185) and Lane Keeping Assist (▷ page 187).

#### Blind Spot Assist

##### General notes

Blind Spot Assist monitors the areas on either side of the vehicle that are not visible to the driver with two lateral, rear-facing radar sensors. A warning display in the exterior mirrors draws your attention to vehicles detected in the monitored area. If you then switch on the corresponding turn signal to change lanes, you will also receive a visual and audible collision warning.

Blind Spot Assist supports you from a speed of approximately 20 mph (30 km/h).

##### Important safety notes

#### WARNING

Blind Spot Assist does not react to:

- vehicles overtaken too closely on the side, placing them in the blind spot area
- vehicles which approach with a large speed differential and overtake your vehicle

As a result, Blind Spot Assist may not give warnings in such situations. There is a risk of an accident.

Always observe the traffic conditions carefully, and maintain a safe lateral distance.

Blind Spot Assist is only an aid. It may fail to detect some vehicles and is no substitute for attentive driving. Always ensure that there is sufficient distance to the side for other road users and obstacles.

**i** USA only:

This device has been approved by the FCC as a "Vehicular Radar System". The radar sensor is intended for use in an automotive radar system only. Removing, tampering with, or altering the device will void any warranties, and is not permitted by the FCC. Do not tamper with, alter, or use in any non-approved way.

Any unauthorized modification to this device could void the user's authority to operate the equipment.

### Radar sensors

The radar sensors for Blind Spot Assist are integrated into the rear bumper. Make sure that the bumpers are free from dirt, ice or slush. The sensors must not be covered, for example by cycle racks or overhanging loads. Following a severe impact or in the event of damage to the bumpers, have the function of the radar sensors checked at a qualified specialist workshop. Blind Spot Assist may no longer work properly.

### Monitoring range of the sensors

In particular, the detection of obstacles can be impaired if:

- there is dirt on the sensors or anything else covering the sensors
- there is poor visibility, e.g. due to fog, heavy rain or snow
- a narrow vehicle traveling in front, e.g. a motorbike or bicycle
- the road has very wide lanes
- the road has narrow lanes
- you are not driving in the middle of the lane
- there are barriers or similar lane borders

Vehicles in the monitoring range are then not indicated.

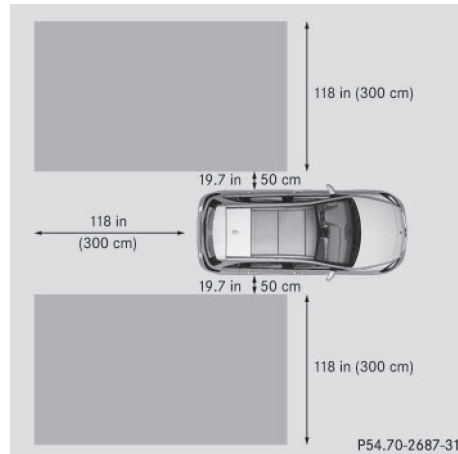

Blind Spot Assist monitors the area up to 10 ft (3 m) behind your vehicle and directly next to your vehicle, as shown in the diagram.

If the lanes are narrow, vehicles driving in the lane beyond the lane next to your vehicle may be indicated, especially if the vehicles are not driving in the middle of their lane. This may be the case if the vehicles are driving on the inner side of their lane.

Due to the nature of the system:

- warnings may be issued in error when driving close to crash barriers or similar solid lane borders.
- warnings may be interrupted when driving alongside particularly long vehicles, e.g. trucks, for a prolonged time.

### Warning display

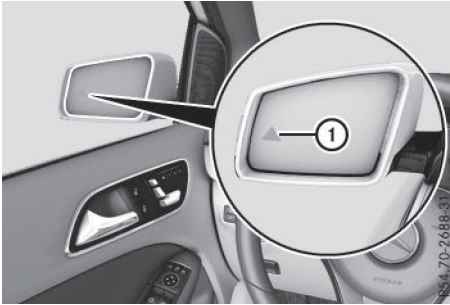

#### ① Warning display

Blind Spot Assist is not active at speeds below approximately 20 mph (30 km/h). Vehicles in the monitoring range are then not indicated. When Blind Spot Assist is activated, indicator lamp ① in the exterior mirrors lights up yellow at speeds of up to 20 mph (30 km/h). At speeds above 20 mph (30 km/h), the indicator lamp goes out and Blind Spot Assist is operational.

If a vehicle is detected within the blind spot monitoring range at speeds above 20 mph (30 km/h), warning lamp ① on the corresponding side lights up red. This warning is always emitted when a vehicle enters the blind spot monitoring range from behind or from the side. When you overtake a vehicle, the warning only occurs if the difference in speed is less than 7 mph (12 km/h).

The yellow indicator lamp goes out if reverse gear is engaged. In this event, Blind Spot Assist is no longer active.

The brightness of the indicator/warning lamps is adjusted automatically according to the ambient light.

### Collision warning

If a vehicle is detected in the monitoring range of Blind Spot Assist and you switch on the corresponding turn signal, a double warning tone sounds. Red warning lamp ① flashes. If the turn signal remains on, detected vehicles are indicated by the flashing of red warning lamp ①. There are no further warning tones.

### Switching on Blind Spot Assist

- ▶ Make sure that Blind Spot Assist is activated in the on-board computer (▷ page 203).
- ▶ Turn the SmartKey to position **2** in the ignition lock. Warning lamps ① in the exterior mirrors light up red for approximately 1.5 seconds and then turn yellow.

### Lane Keeping Assist

#### General notes

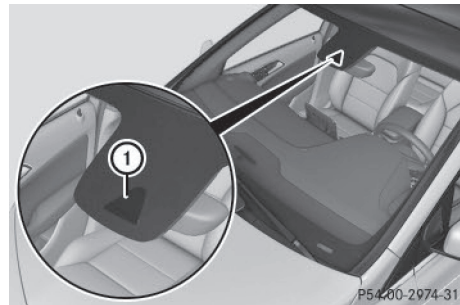

Lane Keeping Assist monitors the area in front of your vehicle with camera ①, which is mounted at the top of the windshield. Active Lane Keeping Assist detects lane markings on the road and can warn you before you leave your lane unintentionally.

This function is available in the range between 40 mph and 120 mph (60 km/h and 200 km/h).

A warning may be given if a front wheel passes over a lane marking. It will warn you by means of intermittent vibration in the steering wheel for up to 1.5 seconds.

### Important safety notes

#### ⚠ WARNING

Lane Keeping Assist may not always clearly recognize lane markings.

In this case, Lane Keeping Assist may:

- give an unnecessary warning
- not give a warning

There is a risk of an accident.

Always pay particular attention to the traffic situation and stay in lane, in particular if warned by Lane Keeping Assist.

#### WARNING

The Lane Keeping Assist warning does not return the vehicle to the original lane. There is a risk of an accident.

You should always steer, brake or accelerate yourself, in particular if warned by Lane Keeping Assist.

If you fail to adapt your driving style, Lane Keeping Assist can neither reduce the risk of an accident nor override the laws of physics. Lane Keeping Assist cannot take into account the road, traffic and weather conditions. Lane Keeping Assist is merely an aid. You are responsible for the distance to the vehicle in front, for vehicle speed, for braking in good time and for staying in your lane.

The Lane Keeping Assist does not keep the vehicle in the lane.

The system may be impaired or may not function if:

- there is poor visibility, e.g. due to insufficient illumination of the road, or due to snow, rain, fog or spray
- there is glare, e.g. from oncoming traffic, the sun or reflections (e.g. when the road surface is wet)
- the windshield is dirty, fogged up, damaged or covered, for instance by a sticker, in the vicinity of the camera
- there are no, several or unclear lane markings for a lane, e.g. in areas with road construction work
- the lane markings are worn away, dark or covered up, e.g. by dirt or snow
- the distance to the vehicle in front is too small and the lane markings thus cannot be detected

- the lane markings change quickly, e.g. lanes branch off, cross one another or merge
- the road is narrow and winding
- there are strong shadows cast on the road

#### Switching on Lane Keeping Assist

- ▶ Activate Lane Keeping Assist using the on-board computer; to do so, select **Standard** or **Adaptive** (▷ page 203).

If you drive at speeds above 60 km/h and lane markings are detected, the lane markings in the assistance graphics display (▷ page 202) are shown in green.

When **Standard** is selected, no warning vibration occurs if:

- you have switched on the turn signals. In this event, the warnings are suppressed for a certain period of time.
- a driving safety system intervenes, such as ABS, BAS or ESP®.

When **Adaptive** is selected, no warning vibration occurs if:

- you have switched on the turn signals. In this event, the warnings are suppressed for a certain period of time.
- a driving safety system intervenes, e.g. ABS, BAS or ESP®.
- you accelerate hard, e.g. kickdown.
- you brake hard.
- you steer actively, e.g. swerve to avoid an obstacle or change lanes quickly.
- you cut the corner on a sharp bend.

In order that you are warned only when necessary and in good time if you cross the lane marking, the system recognizes certain conditions and warns you accordingly.

The warning vibration occurs earlier if:

- you approach the outer lane marking on a bend.
- the road has very wide lanes, e.g. a highway.
- the system recognizes solid lane markings.

The warning vibration occurs later if:

- the road has narrow lanes.
- you cut the corner on a bend.





Useful information .....	192
Important safety notes .....	192
Displays and operation .....	192
Menus and submenus .....	195
Display messages .....	207
Warning and indicator lamps in the instrument cluster .....	235

### Useful information

- i** This Operator's Manual describes all models and all standard and optional equipment of your vehicle available at the time of publication of the Operator's Manual. Country-specific differences are possible. Please note that your vehicle may not be equipped with all features described. This also applies to safety-related systems and functions.
- i** Read the information on qualified specialist workshops (▷ page 24).

### Important safety notes

#### **WARNING**

If you operate information systems and communication equipment integrated in the vehicle while driving, you will be distracted from traffic conditions. You could also lose control of the vehicle. There is a risk of an accident.

Only operate the equipment when the traffic situation permits. If you are not sure that this is possible, park the vehicle paying attention to traffic conditions and operate the equipment when the vehicle is stationary.

You must observe the legal requirements for the country in which you are currently driving when operating the on-board computer.

#### **WARNING**

If the instrument cluster has failed or malfunctioned, you may not recognize function restrictions in systems relevant to safety. The operating safety of your vehicle may be impaired. There is a risk of an accident.

Drive on carefully. Have the vehicle checked at a qualified specialist workshop immediately.

The on-board computer only shows messages or warnings from certain systems in the multifunction display. You should therefore make

sure your vehicle is operating safely at all times.

If the operating safety of your vehicle is impaired, pull over as soon as it is safe to do so. Contact a qualified specialist workshop.

For an overview, see the instrument panel illustration (▷ page 29).



### Displays and operation

#### Instrument cluster lighting

The light sensor in the instrument cluster automatically controls the brightness of the multifunction display. In daylight, the displays in the instrument cluster are not illuminated. The lighting in the instrument cluster, in the displays and the controls in the vehicle interior can be adjusted using the brightness control knob.

The brightness control knob is located on the bottom left of the instrument cluster (▷ page 29).

- ▶ Turn the brightness control knob clockwise or counter-clockwise.

If the light switch is set to **AUTO**,  or , the brightness is dependent upon the brightness of the ambient light.

#### Coolant temperature display

#### **WARNING**

Opening the hood when the engine is overheated or when there is a fire in the engine compartment could expose you to hot gases or other service products. There is a risk of injury.

Let an overheated engine cool down before opening the hood. If there is a fire in the engine compartment, keep the hood closed and contact the fire department.

- !** A display message is shown if the coolant temperature is too high.

If the coolant temperature is over 248 °F (120 °C), do not continue driving. The engine will otherwise be damaged.

The coolant temperature gage is in the instrument cluster on the right-hand side (▷ page 29).

Under normal operating conditions and with the specified coolant level, the coolant temperature may rise to 248 °F (120 °C).

### Tachometer

**!** Do not drive in the overrevving range, as this could damage the engine.

The red band in the tachometer indicates the engine's overrevving range.

The engine is limited within a range to protect the engine when the red band is reached.

### Outside temperature display

You should pay special attention to road conditions when temperatures are around freezing point.

Bear in mind that the outside temperature display indicates the temperature measured and does not record the road temperature.

The outside temperature display is in the multifunction display (▷ page 195).

Changes in the outside temperature are displayed after a short delay.

### Speedometer with segments

The speedometer is divided into segments only on vehicles with DISTRONIC PLUS.

The segments in the speedometer indicate which speed range is available.

- DISTRONIC PLUS activated (▷ page 163):  
One or two segments in the set speed range light up.
- DISTRONIC PLUS detects a vehicle in front that is driving at a slower speed than the stored speed:

The segments between the speed of the vehicle in front and the stored speed light up.

### Operating the on-board computer



- ① Multifunction display
- ② Right control panel
- ③ Left control panel

► **To activate the on-board computer:** turn the SmartKey to position 1 in the ignition lock.

You can control the multifunction display and the settings in the on-board computer using the buttons on the multifunction steering wheel.

## Left control panel



- Calls up the menu and menu bar

**Press briefly:**

- Scrolls in lists
- Selects a submenu or function
- Vehicles with Audio 20: in the **Audio** menu, selects the previous/next stored station, when the preset list or station list is active, or an audio track
- Vehicles with COMAND: in the **Audio** menu, selects the previous/next station, when the preset list or station list is active, or an audio track or video scene
- In the **Tel** (telephone) menu: switches to the phone book and selects a name or telephone number

**Press and hold:**

- Vehicles with Audio 20: in the **Audio** menu, selects the previous/next station, when the preset list or station list is active, or selects an audio track using rapid scrolling
- Vehicles with COMAND: in the **Audio** menu, selects a preset list or station list in the desired waveband or an audio track or video scene using rapid scrolling
- In the **Tel** (Telephone) menu: starts rapid scrolling if the phone book is open



- Confirms a selection/display message
- In the **Tel** (Telephone) menu: switches to the telephone book and starts dialing the selected number

**Press briefly:**

- Back
- Switches off the Voice Control System (see the separate operating instructions)
- Hides display messages/calls up the last **Trip** menu function used
- Exits the telephone book/redial memory

**Press and hold:**

- Calls up the standard display in the **Trip** menu

## Right control panel



- Switches on the Voice Control System (see the separate operating instructions)



- Mute



- Adjusts the volume



- Rejects or ends a call
- Exits phone book/redial memory



- Makes or accepts a call
- Switches to the redial memory

**Multifunction display**

**Black and white multifunction display**



**Color multifunction display**

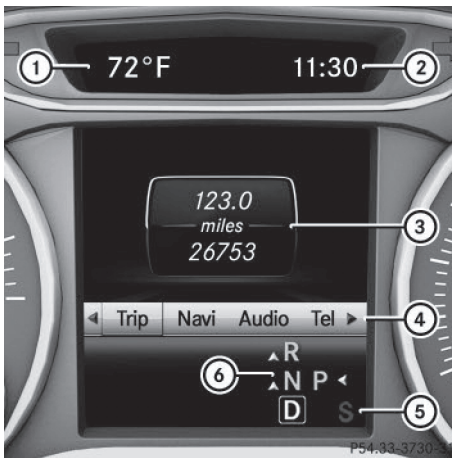

- ① Permanent display: outside temperature or speed (> page 205)
- ② Time
- ③ Text field
- ④ Menu bar
- ⑤ Drive program (> page 143)
- ⑥ Transmission position (> page 143)

**Overview**

▶ **To display menu bar** (4): press the ◀ or ▶ button on the steering wheel. Menu bar (4) disappears after a few seconds.

Text field (3) shows the selected menu or submenu as well as display messages.

The following menu illustrations differ in vehicles with black and white and color multifunction display. The examples given in this Operator's Manual apply to vehicles equipped with color multifunction display.

**i** You can set the time using Audio 20 or COMAND; see the separate operating instructions.

**Further displays**

The following messages may appear in the multifunction display:

- ⬆ Gearshift recommendation when shifting manually (> page 148)
- ◀ P ▶ Active Parking Assist (> page 175)
- CRUISE** Cruise control (> page 161)
- A** ECO start/stop function (> page 139)
- HOLD** HOLD function (> page 170)

**Menus and submenus**

**Menu overview**

Press the ◀ or ▶ button on the steering wheel to call up the menu bar and select a menu.

Operating the on-board computer (> page 193).

Depending on the equipment installed in the vehicle, you can call up the following menus:

- **Trip** menu (> page 196)
- **Navi** menu (navigation instructions) (> page 197)
- **Audio** menu (> page 199)
- **Tel** menu (telephone) (> page 200)

- **DriveAssist** menu (assistance) (▷ page 201)
- **Serv.** menu (▷ page 204)
- **Sett.** menu (settings) (▷ page 204)

The **Audio**, **Navi** and **Tel** menus differ slightly in vehicles with Audio 20 and in vehicles with COMAND. The examples given in this Operator's Manual apply to vehicles equipped with COMAND.

### Trip menu

#### Standard display



- ▶ Press and hold the button on the steering wheel until the **Trip** menu with trip odometer ① and odometer ② is shown.

#### Trip computer "From Start" or "From Reset"

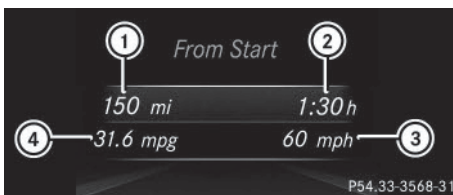

- ① Distance
  - ② Driving time
  - ③ Average speed
  - ④ Average fuel consumption
- ▶ Press the or button on the steering wheel to select the **Trip** menu.
  - ▶ Press the or button to select **From Start** or **From Reset**.

The values in the **From Start** submenu are calculated from the start of a journey whilst

the values in the **From Reset** submenu are calculated from the last time the submenu was reset (▷ page 197).

The **From Start** trip computer is automatically reset when:

- the ignition has been switched off for more than four hours.
- 999 hours have been exceeded.
- 9,999 miles have been exceeded.

The **From Reset** trip computer is automatically reset if the value exceeds 9,999 hours or 99,999 miles.

#### ECO display

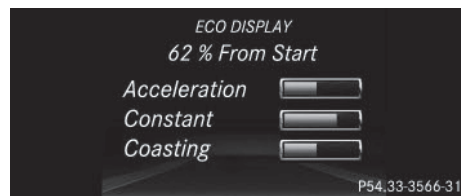

- ▶ Press the or button on the steering wheel to select the **Trip** menu.
- ▶ Press the or button to select **ECO DISPLAY**.

If the ignition remains switched off for longer than four hours, the ECO display will be automatically reset.

For further information on the ECO display, see (▷ page 156).

#### Displaying the range and current fuel consumption

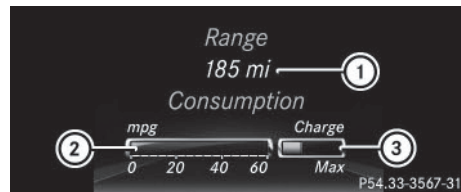

- ▶ Press the or button on the steering wheel to select the **Trip** menu.
- ▶ Press the or button to select approximate range ① and current fuel consumption ②.

Approximate range ① that can be covered is calculated according to your current driving style and the amount of fuel in the tank. If there is only a small amount of fuel left in the fuel tank, the display shows a vehicle being refueled instead of approximate range ①.

Recuperation display ③ shows you if energy has been recuperated from the kinetic energy in overrun mode and saved in the battery. Recuperation display ③ depends on the engine installed and is therefore not available in all vehicles.

### Digital speedometer

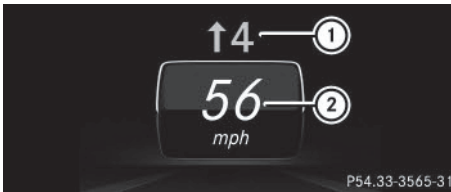

- ▶ Press the or button on the steering wheel to select the **Trip** menu.
- ▶ Press the or button to select digital speedometer ②.

A gearshift recommendation ① can also be displayed.

Observe the information on gearshift recommendation ① when shifting manually (▷ page 148).

### Resetting values

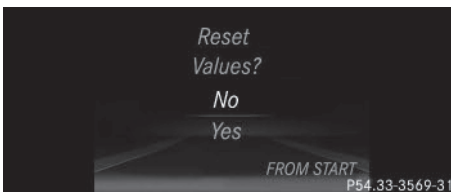

- ▶ Press the or button on the steering wheel to select the **Trip** menu.
- ▶ Press the or button to select the function that you wish to reset.
- ▶ Press the button.
- ▶ Select **Yes** and press to confirm.

You can reset the values of the following functions:

- Trip odometer
- "From Start" trip computer
- "From Reset" trip computer
- ECO display

If you reset the values in the ECO display, the values in the "From start" trip computer are also reset. If you reset the values in the "From start" trip computer, the values in the ECO display are also reset.

### Navigation system menu

#### Displaying navigation instructions

In the **Navi** menu, the multifunction display shows navigation instructions.

Further information on navigation can be found in the separate Audio 20 or COMAND operating instructions.

- ▶ Switch on Audio 20 or COMAND, see the separate operating instructions.
- ▶ Press the or button on the steering wheel to select the **Navi** menu.

#### Route guidance not active



- ① Direction of travel
- ② Current road

### Route guidance active

#### No change of direction announced



- ① Distance to the destination
- ② Distance to the next change of direction
- ③ Current road
- ④ "Follow the road's course" symbol

#### Change of direction without lane recommendation

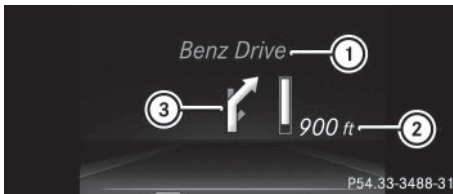

- ① Road into which the change of direction leads
- ② Distance to change of direction and visual distance display
- ③ Change-of-direction symbol

When a change of direction is to be made, you will see symbol ③ for the change of direction and distance graphic ②. The distance indicator shortens towards the top of the display as you approach the point of the announced change of direction. The change of direction starts once the distance display reaches zero.

#### Change of direction announced with a lane recommendation

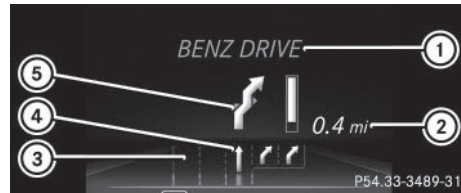

- ① Road into which the change of direction leads
- ② Distance to change of direction and visual distance display
- ③ Lanes not recommended
- ④ Recommended lane and new lane during a change of direction
- ⑤ Change-of-direction symbol

On multilane roads, lane recommendations can be displayed for the next change of direction if the digital map supports this data. During the change of direction, new lanes may be added.

Lane not recommended ③: you will not be able to complete the next change of direction if you stay in this lane.

Recommended lane and new lane during a change of direction ④: in this lane you will be able to complete the next two changes of direction without changing lane.

#### Other status indicators of the navigation system



The navigation system displays additional information and the vehicle status.

Possible displays:

- [New Route...](#) or [Calculating Route...](#)



A new route is calculated.

- **Off Mapped Road**

The vehicle position is inside the area of the digital map but the road is not recognized, e.g. newly built streets, car parks or private land.

- **No Route**

No route could be calculated to the selected destination.



- 

You have reached the destination or an intermediate destination.





### Audio menu

#### Selecting a radio station



- ① Active station list
  - ② Station frequency with memory position
- Station ② is displayed with the station frequency or station name. The memory position is only displayed along with station ② if this has been stored.
- ▶ Switch on Audio 20 or COMAND and select Radio; see the separate operating instructions.
  - ▶ Press the  or  button on the steering wheel to select the **Audio** menu.



#### Vehicles with Audio 20

- ▶ **To select a station in the preset list:** briefly press the  or  button.
- ▶ **To select a station in the station list:** press and hold the  or  button.

#### Vehicles with COMAND

- ▶ **To select a preset list or station list:** press and hold the  or  button

until the preset list or station list is shown in the desired frequency range.

- ▶ **To select a station:** press  or  briefly.

**i** SIRIUS XM satellite radio functions like a normal radio.







You can find further information on operation in the "Satellite radio" section of the separate Audio 20 or COMAND operating instructions.



#### Operating an audio player or audio media



① Current title

Audio data from various audio devices or media can be played, depending on the equipment installed in the vehicle.

- ▶ Switch on Audio 20 or COMAND and select audio CD or MP3 mode; see the separate operating instructions.
- ▶ Press the  or  button on the steering wheel to select the **Audio** menu.
- ▶ **To select the next/previous track:** briefly press the  or  button.
- ▶ **To select a track from the track list (rapid scrolling):** press and hold the  or  button until the desired track has been reached.

If you press and hold  or , the rapid scrolling speed is increased. Not all audio drives or data carriers support this function.

If track information is stored on the audio device or medium, the multifunction display will show the number and title of the track.

### Video DVD operation

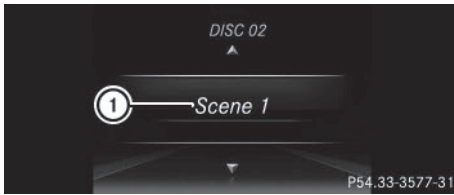

You can only operate DVD videos in the **Audio** menu in vehicles with COMAND.

- ▶ Switch on COMAND and select video DVD (see the separate operating instructions).
- ▶ Press the or button on the steering wheel to select the **Audio** menu.
- ▶ **To select the next or previous scene:** briefly press the or button.
- ▶ **To select a scene from the scene list (rapid scrolling):** press and hold the or button until desired scene ① has been reached.

### Telephone menu

#### Introduction

#### WARNING

If you operate information systems and communication equipment integrated in the vehicle while driving, you will be distracted from traffic conditions. You could also lose control of the vehicle. There is a risk of an accident.

Only operate the equipment when the traffic situation permits. If you are not sure that this is possible, park the vehicle paying attention to traffic conditions and operate the equipment when the vehicle is stationary.

When telephoning, you must observe the legal requirements for the country in which you are currently driving.

- ▶ Switch on the mobile phone (see the manufacturer's operating instructions).
- ▶ Switch on Audio 20 or COMAND, see the separate operating instructions.

- ▶ Establish a Bluetooth® connection to Audio 20 or COMAND, see the separate operating instructions.
- ▶ Press the or button on the steering wheel to select the **Te1** menu.

You will see one of the following display messages in the multifunction display:

- **Phone READY** or the name of the network provider: the mobile phone has found a network and is ready to receive.
- **Phone No Service:** there is no network available or the mobile phone is searching for a network.

### Accepting a call



- ▶ Press the button on the steering wheel to accept an incoming call.

If someone calls you when you are in the **Te1** menu, a display message appears in the multifunction display.

You can accept a call at any time, even if you are not in the **Te1** menu.

### Rejecting or ending a call

- ▶ Press the or button on the steering wheel.



You can end or reject a call even if you are not in the **Te1** menu.

### Dialing an entry from the phone book



- ▶ Press the or button on the steering wheel to select the **Te1** menu.
- ▶ Press the , or button to switch to the phone book.
- ▶ Authorize access to the phone book on the phone.

- ▶ Press the  or  button to select the desired name.



or

- ▶ **To begin rapid scrolling:** press and hold the  or  button for longer than one second.



Rapid scrolling stops when you release the button or reach the end of the list.

- ▶ **If only one telephone number is stored for a name:** press the  or  button to start dialing.



or

- ▶ **If there is more than one number for a particular name:** press the  or  button to display the numbers.

- ▶ Press the  or  button to select the number you want to dial.

- ▶ Press the  or  button to start dialing.

or

- ▶ **If you do not want to make the call:** press the  or  button.

## Redialing

The on-board computer saves the last names or numbers dialed in the redial memory.

- ▶ Press the  or  button on the steering wheel to select the **Te1** menu.

- ▶ Press the  button to switch to the redial memory.

- ▶ Press the  or  button to select the desired name or number.

- ▶ Press the  or  button to start dialing.

or

- ▶ **If you do not want to make the call:** press the  or  button.

## Assistance menu

### Introduction



Depending on the equipment installed in the vehicle, you have the following options in the **DriveAssist** menu:

- Only vehicles with black and white multifunction display: showing status overview (▷ page 201)
- Only vehicles with black and white multifunction display: showing distance display (▷ page 202)
- Only vehicles with color multifunction display: showing the assistance graphic (▷ page 202)
- Activating/deactivating ESP® (▷ page 202)
- Activating/deactivating COLLISION PREVENTION ASSIST PLUS (▷ page 203)
- Activating/deactivating ATTENTION ASSIST (▷ page 203)
- Activating/deactivating Blind Spot Assist (▷ page 203)
- Activating/deactivating Lane Keeping Assist (▷ page 203)

### Showing the status overview

The **Status Overview** is only available in vehicles with black and white multifunction displays.

- ▶ Press the  or  button on the steering wheel to select the **DriveAssist** menu.

- ▶ Press  or  to select **Status Overview**.

- ▶ Press the  button.





The **Status Overview** shows you the status of and/or information from the follow-

ing driving systems or driving safety systems:

- COLLISION PREVENTION ASSIST PLUS (▷ page 62)
  - ATTENTION ASSIST (▷ page 183)
  - Lane Keeping Assist (▷ page 187)
  - Rear window wiper (▷ page 114)
- ▶ Press  to display the ATTENTION ASSIST assessment.

### Showing the distance display





The Distance display is only available in vehicles with a monochrome multifunction display and DISTRONIC PLUS.

- ▶ Press the  or  button on the steering wheel to select the **DriveAssist** menu.
- ▶ Press  or  to select **Distance Display**.
- ▶ Press the  button.  
The DISTRONIC PLUS distance display appears in the multifunction display (▷ page 168).

### Displaying the assistance graphic



The Assistance graphic is only available in vehicles with a color multifunction display.

- ▶ Press the  or  button on the steering wheel to select the **DriveAssist** menu.
- ▶ Press  or  to select **Assist. Graphic**.
- ▶ Press the  button.

The multifunction display shows the DISTRONIC PLUS distance display in the assistance graphic.

The assistance graphic displays the status of and information from the following driving systems or driving safety systems:

- DISTRONIC PLUS (▷ page 168)
  - COLLISION PREVENTION ASSIST PLUS (▷ page 62)
  - ATTENTION ASSIST (▷ page 183)
  - Lane Keeping Assist (▷ page 187)
  - Rear window wiper (▷ page 114)
- ▶ Press  to display the ATTENTION ASSIST assessment.

### Deactivating/activating ESP®

Observe the important safety notes on ESP® (▷ page 64).

#### WARNING







If you deactivate ESP®, ESP® no longer stabilizes the vehicle. There is an increased risk of skidding and an accident.

Only deactivate ESP® in the situations described in the following.



It may be best to deactivate ESP® in the following situations:

- when using snow chains
- in deep snow
- on sand or gravel

For further information about ESP®, see (▷ page 64).

- ▶ Start the engine.
- ▶ Press the  or  button on the steering wheel to select the **DriveAssist** menu.
- ▶ Press  or  to select **ESP**.
- ▶ Press the  button.  
The current selection is displayed.
- ▶ **To activate/deactivate:** press the  button again.









ESP® is deactivated if the  warning lamp in the instrument cluster lights up continuously when the engine is running.

If the  and  warning lamps light up continuously, ESP® is not available due to a malfunction.

Observe the information on warning lamps (▷ page 240).











Observe the information on display messages (> page 208).

### Activating/deactivating COLLISION PREVENTION ASSIST PLUS

- ▶ Press the  or  button on the steering wheel to select the **DriveAssist** menu.
- ▶ Press the  or  button to select **Collision Prevent. Assist**.
- ▶ Press the  button.  
The current selection is displayed.
- ▶ **To activate/deactivate:** press the  button again.  
Vehicles with black and white multifunction display: when COLLISION PREVENTION ASSIST PLUS is activated, the multifunction display in the status overview shows the  symbol.  
Vehicles with color multifunction display: when COLLISION PREVENTION ASSIST PLUS is deactivated, the multifunction display shows the  symbol in the assistance graphic.

For further information about COLLISION PREVENTION ASSIST PLUS, see (> page 62).







### Activating/deactivating ATTENTION ASSIST

- ▶ Press the  or  button on the steering wheel to select the **DriveAssist** menu.
- ▶ Press the  or  button to select **Attention Assist**.
- ▶ Press the  button.  
The current selection is displayed.
- ▶ Press  to confirm.
- ▶ Press the  or  button to set **Off**, **Standard** or **Sensitive**.
- ▶ Press the  button to save the setting.  
Vehicles with black and white multifunction display: when Lane Keeping Assist is activated, the multifunction display in the status overview shows the  symbol.  
Vehicles with color multifunction display: when Lane Keeping Assist is deactivated,

the multifunction display shows the  symbol in the assistance graphic.











For further information about ATTENTION ASSIST, see (> page 183).

### Activating/deactivating Blind Spot Assist

- ▶ Press the  or  button on the steering wheel to select the **DriveAssist** menu.
- ▶ Press the  or  button to select **Blind Spot Assist**.
- ▶ Press the  button.  
The current selection is displayed.
- ▶ **To activate/deactivate:** press the  button again.

For further information about Blind Spot Assist, see (> page 185).

### Activating/deactivating Lane Keeping Assist

- ▶ Press the  or  button on the steering wheel to select the **DriveAssist** menu.
- ▶ Press the  or  button to select **Lane Keeping Assist**.
- ▶ Press the  button.  
The current selection is displayed.
- ▶ Press  to confirm.
- ▶ Press the  or  button to set **Off**, **Standard** or **Adaptive**.
- ▶ Press the  button to save the setting.  
Vehicles with a black and white multifunction display: when Lane Keeping Assist is activated, the multifunction display in the status overview shows the  symbol.  
Vehicles with a color multifunction display: when Lane Keeping Assist is activated, the multifunction display shows the lane markings as bright lines in the assistance graphic.

For further information about Lane Keeping Assist, see (> page 187).

### Service menu



Depending on the equipment installed in the vehicle, you have the following options in the **Serv.** menu:

- Calling up display messages in message memory (▷ page 207)
- Restarting the tire pressure loss warning system (Canada only) (▷ page 309)
- Calling up the service due date (▷ page 275)

### Settings menu

#### Introduction



Depending on the equipment installed in the vehicle, in the **Sett.** menu you have the following options:

- Changing the instrument cluster settings
- Changing the vehicle settings
- Changing the convenience settings
- Restoring the factory settings

#### Instrument cluster

##### Unit of measurement for distance

The **Display Unit Speed-/Odometer:** function allows you to choose whether certain displays appear in kilometers or miles in the multifunction display.

- ▶ Press the or button on the steering wheel to select the **Sett.** menu.
- ▶ Press the or button to select the **Instrument Cluster** submenu.
- ▶ Press to confirm.
- ▶ Press the or button to select the **Display Unit Speed-/Odometer** function.  
You will see the selected setting: **km** or **miles**.
- ▶ Press the button to save the setting.

The selected unit of measurement for distance applies to:

- digital speedometer in the **Trip** menu
- odometer and the trip odometer
- trip computer
- current fuel consumption and approximate range
- navigation instructions in the **Navi** menu
- cruise control
- DISTRONIC PLUS
- ASSYST PLUS service interval display

##### Switching the additional speedometer on/off

The **Speedometer [km/h]** or **Speedometer [mph]** function allows you to choose whether the multifunction display in the status area shows the speed in **km/h** or in **mph** instead of the outside temperature.

- ▶ Press the or button on the steering wheel to select the **Sett.** menu.
- ▶ Press the or button to select the **Instrument Cluster** submenu.
- ▶ Press to confirm.
- ▶ Press the or button to select the **Speedometer [km/h]** or **Speedometer [mph]** function.  
You will see the selected setting: **On** or **Off**.
- ▶ Press the button to save the setting.

## Selecting the permanent display function

You can determine whether the multifunction display permanently shows the outside temperature or your speed in km/h (USA) or mph (Canada).

- ▶ Press the ◀ or ▶ button on the steering wheel to select the **Sett.** menu.
- ▶ Press the ▼ or ▲ button to select the **Instrument Cluster** submenu.
- ▶ Press **OK** to confirm.
- ▶ Press the ▼ or ▲ button to select the **Permanent Display:** function.  
You will see the selected setting: **Outside Temperature** or **Speedometer [km/h]/Speedometer [mph]**.
- ▶ Press the **OK** button to save the setting.

**i** The speed is highlighted in km/h or in mph conversely to your speedometer.

## Lights

### Switching the daytime running lamps on/off

This function is not available in Canada.

- ▶ Press the ◀ or ▶ button on the steering wheel to select the **Sett.** menu.
- ▶ Press the ▼ or ▲ button to select the **Lights** submenu.
- ▶ Press **OK** to confirm.
- ▶ Press the ▼ or ▲ button to select the **Daytime Running Lights** function.

Vehicles with black and white multifunction display: you will see the selected setting: **On** or **Off**.

Vehicles with color multifunction display: if the **Daytime Running Lights** function has been switched on, the cone of light and the  symbol in the multifunction display are shown in orange.

- ▶ Press the **OK** button to save the setting.

Further information on daytime running lights (▷ page 104).

## Vehicle

### Activating/deactivating the automatic door locking mechanism

- ▶ Press the ◀ or ▶ button on the steering wheel to select the **Sett.** menu.
- ▶ Press the ▼ or ▲ button to select the **Vehicle** submenu.
- ▶ Press **OK** to confirm.
- ▶ Press ▼ or ▲ to select the **Automatic Door Lock:** function (vehicles with a black and white multifunction display) or the **Automatic Door Lock** function (vehicles with a color multifunction display).  
Vehicles with a black and white multifunction display: you see the selected setting **On** or **Off**.

Vehicles with color multifunction display: when the **Automatic Door Lock** function is activated, the vehicle doors are displayed in orange in the multifunction display.

- ▶ Press the **OK** button to save the setting.





If you select the **Automatic Door Lock:** function (vehicles with black and white multifunction display) or the **Automatic Door Lock** function (vehicles with color multifunction display), the vehicle is centrally locked above a speed of approximately 9 mph (15 km/h).

For further information on the automatic locking feature, see (▷ page 78).

### Activating/deactivating the acoustic locking verification signal

If you activate the **Acoustic Lock Feedback:** function (vehicles with a black and white multifunction display) or the **Acoustic Lock** function (vehicles with a color multifunction display), an acoustic tone sounds when you lock the vehicle.

- ▶ Press the ◀ or ▶ button on the steering wheel to select the **Sett.** menu.
- ▶ Press the ▼ or ▲ button to select the **Vehicle** submenu.
- ▶ Press **OK** to confirm.

- ▶ Press  or  to select the **Acoustic Lock Feedback**: function (vehicles with a black and white multifunction display) or the **Acoustic Lock** function (vehicles with a color multifunction display).  
Vehicles with a black and white multifunction display: you see the selected setting **On** or **Off**.  
Vehicles with a color multifunction display: if the **Acoustic Lock** function is activated, the  symbol in the multifunction display lights up orange.
- ▶ Press the  button to save the setting.







### Convenience

#### Switching the fold-in mirrors when locking feature on/off

This function is only available when the vehicle is equipped with the electrical fold-in function.

If you switch on the **Fold Mirrors in when Locking** function (vehicles with black and white multifunction display) or the **Auto. Mirror Folding** function (vehicles with color multifunction display), the exterior mirrors fold in when you lock the vehicle. If you unlock the vehicle and then open the driver's or front-passenger door, the exterior mirrors fold out again.

If you have switched on the **Fold Mirrors in when Locking** (vehicles with black and white multifunction display) or **Auto. Mirror Folding** (vehicles with color multifunction display) function and you fold in the exterior mirrors using the button on the door (> page 98), they will not fold out automatically. The exterior mirrors can then only be folded out using the button on the door.

- ▶ Press the  or  button on the steering wheel to select the **Sett.** menu.
- ▶ Press the  or  button to select the **Convenience** submenu.
- ▶ Press  to confirm.
- ▶ Press  or  to select the **Fold Mirrors in when Locking** function (veh-









cles with a black and white multifunction display) or the **Auto. Mirror Folding** function (vehicles with a color multifunction display).

Vehicles with a black and white multifunction display: you see the selected setting **On** or **Off**.

Vehicles with a color multifunction display: if the **Auto. Mirror Folding** function is activated, the vehicle's exterior mirror is displayed in orange in the multifunction display.

- ▶ Press the  button to save the setting.

### Restoring the factory settings

- ▶ Press the  or  button on the steering wheel to select the **Sett.** menu.
- ▶ Press the  or  button to select the **Factory Settings** submenu.
- ▶ Press  to confirm.  
The **Reset All Settings?** message appears.
- ▶ Press the  or  button to select **No** or **Yes**.
- ▶ Press the  button to confirm the selection.  
If you have selected **Yes**, the multifunction display shows a confirmation message.

For safety reasons, the **Daytime Running Lights** function in the **Lights** submenu is only reset if the vehicle is stationary.



## Display messages

### Introduction

#### General notes

Display messages appear in the multifunction display.

Display messages with graphic displays may be shown in simplified form in the Operator's Manual and may therefore differ from the multifunction display.

Please respond in accordance with the display messages and follow the additional notes in this Operator's Manual.



Certain display messages are accompanied by an audible warning tone or a continuous tone.

When the ignition is switched off, all display messages are deleted, apart from some high-priority display messages. Once the causes of the high-priority display messages have been rectified, the corresponding display messages are also deleted.

When you stop and park the vehicle, please observe the notes on:

- HOLD function (▷ page 170)
- Parking (▷ page 152)

#### Hiding display messages







- ▶ Press the  or  button on the steering wheel to hide the display message. The display message is cleared.

The multifunction display shows high-priority display messages in red. Some high-priority display messages cannot be hidden.

The multifunction display shows these messages continuously until the causes for the messages have been remedied.

#### Message memory

The on-board computer saves certain display messages in the **message memory**. You can call up the display messages:

- ▶ Press the  or  button on the steering wheel to select the **Serv.** menu. If there are display messages, the multifunction display shows **2 Messages**, for example.
- ▶ Press the  or  button to select the entry, e.g. **2 Messages**.
- ▶ Press  to confirm.
- ▶ Press the  or  button to scroll through the display messages.

## Safety systems

## Display messages





Currently Unavailable See Operator's Manual

## Possible causes/consequences and ► Solutions

ABS (Anti-lock Braking System), BAS (Brake Assist), ESP® (Electronic Stability Program), the HOLD function and hill start assist are temporarily unavailable.

COLLISION PREVENTION ASSIST PLUS may also have failed.

In addition, the ,  and  warning lamps may light up in the instrument cluster.

ATTENTION ASSIST is deactivated.

Possible causes are:

- self-diagnosis is not yet complete.
- the on-board voltage may be insufficient.

 **WARNING**

The brake system continues to function normally, but without the functions listed above. The wheels could therefore lock if you brake hard, for example.

The steerability and braking characteristics may be severely affected. The braking distance in an emergency braking situation can increase.

If ESP® is not operational, ESP® is unable to stabilize the vehicle. There is an increased risk of skidding and an accident.

- Carefully drive a short distance on a suitable stretch of road, making slight steering movements at a speed above 12 mph (20 km/h).

If the display message disappears, the functions mentioned above are available again.

If the display message continues to be displayed:





- Drive on carefully.
- Visit a qualified specialist workshop.



Inoperative See Operator's Manual

ABS, BAS, ESP®, the HOLD function and hill start assist are not available due to a malfunction.



COLLISION PREVENTION ASSIST PLUS may also have failed.

The , ,  and **BRAKE** (USA only)/ (Canada only) warning lamps in the instrument cluster may also light up.

ATTENTION ASSIST is deactivated.

 **WARNING**

The brake system continues to function normally, but without the functions listed above. The wheels could therefore lock if you brake hard, for example.



Display messages	Possible causes/consequences and ► Solutions
	<p>The steerability and braking characteristics may be severely affected. The braking distance in an emergency braking situation can increase.</p> <p>If ESP® is not operational, ESP® is unable to stabilize the vehicle. There is an increased risk of skidding and an accident.</p> <ul style="list-style-type: none"> <li>► Drive on carefully.</li> <li>► Visit a qualified specialist workshop immediately.</li> </ul>
<div style="border: 1px solid black; padding: 2px; width: 20px; height: 20px; margin-bottom: 5px;">  </div> <p>Currently Unavailable See Operator's Manual</p>	<p>ESP®, BAS, the HOLD function and hill start assist are temporarily unavailable.</p> <p>COLLISION PREVENTION ASSIST PLUS may also have failed.</p> <p>In addition, the  and  warning lamps may light up in the instrument cluster.</p> <p>ATTENTION ASSIST is deactivated.</p> <p>The self-diagnosis function might not be complete, for example.</p> <p><b>⚠ WARNING</b></p> <p>The brake system continues to function normally, but without the functions listed above.</p> <p>The braking distance in an emergency braking situation can thus increase.</p> <p>If ESP® is not operational, ESP® is unable to stabilize the vehicle. There is an increased risk of skidding and an accident.</p> <ul style="list-style-type: none"> <li>► Carefully drive a suitable distance, making slight steering movements at a speed above 12 mph (20 km/h).</li> </ul> <p>If the display message disappears, the functions mentioned above are available again.</p> <p>If the display message continues to be displayed:</p> <ul style="list-style-type: none"> <li>► Drive on carefully.</li> <li>► Visit a qualified specialist workshop.</li> </ul>

**Display messages****Possible causes/consequences and ► Solutions**

Inoperative See  
Operator's Manual

ESP®, BAS, the HOLD function and hill start assist are unavailable due to a malfunction.

COLLISION PREVENTION ASSIST PLUS may also have failed.

In addition, the  and  warning lamps may light up in the instrument cluster.

ATTENTION ASSIST is deactivated.

 **WARNING**

The brake system continues to function normally, but without the functions listed above.

The braking distance in an emergency braking situation can thus increase.

If ESP® is not operational, ESP® is unable to stabilize the vehicle. There is an increased risk of skidding and an accident.

- Drive on carefully.
- Visit a qualified specialist workshop.



Inoperative See  
Operator's Manual

EBD (electronic brake force distribution), ABS, BAS, ESP®, the HOLD function and hill start assist are not available due to a malfunction.

COLLISION PREVENTION ASSIST PLUS may also have failed.

A warning tone sounds.

In addition, the ,  and  warning lamps may light up in the instrument cluster.













 **WARNING**









The brake system continues to function normally, but without the functions listed above. The front and rear wheels could therefore lock if you brake hard, for example.











The steerability and braking characteristics may be severely affected. The braking distance in an emergency braking situation can increase.







If ESP® is not operational, ESP® is unable to stabilize the vehicle. There is an increased risk of skidding and an accident.

- Drive on carefully.
- Visit a qualified specialist workshop immediately.



Display messages	Possible causes/consequences and ► Solutions
<p><b>PARK</b> (USA only)  (Canada only)</p> <p>Turn On the Ignition to Release the Parking Brake</p>	<p>The red  (USA only)/  (Canada only) indicator lamp lights up.</p> <p>You attempted to release the electric parking brake while the ignition was switched off.</p> <ul style="list-style-type: none"> <li>► <b>SmartKey:</b> turn the SmartKey to position <b>1</b> in the ignition lock.</li> <li>► <b>KEYLESS-GO:</b> switch on the ignition.</li> </ul>
<p><b>PARK</b> (USA only)  (Canada only)</p> <p>Please Release Parking Brake</p>	<p>The red  (USA only)/  (Canada only) indicator lamp flashes and a warning tone sounds. A condition for automatic release of the electric parking brake is not fulfilled (► page 153). You are driving with the electric parking brake applied.</p> <ul style="list-style-type: none"> <li>► Release the electric parking brake manually.</li> </ul> <p>The red  (USA only)/  (Canada only) indicator lamp flashes and a warning tone sounds. You are using the electric parking brake for emergency braking (► page 153).</p>
<p><b>PARK</b> (USA only)  (Canada only)</p> <p>Parking Brake See Operator's Manual</p>	<p>The yellow  warning lamp lights up. The electric parking brake is malfunctioning.</p> <p><b>To apply:</b></p> <ul style="list-style-type: none"> <li>► Switch the ignition off.</li> <li>► Press the electric parking brake handle for at least ten seconds.</li> <li>► Shift the selector lever to position <b>P</b>.</li> <li>► Consult a qualified specialist workshop.</li> </ul> <p>The yellow  warning lamp and the red  (USA only)/  (Canada only) indicator lamp light up. The electric parking brake is malfunctioning.</p> <p><b>To release:</b></p> <ul style="list-style-type: none"> <li>► Switch off the ignition and turn it back on.</li> <li>► Release the electric parking brake manually.</li> </ul> <p>or</p> <ul style="list-style-type: none"> <li>► Release the electric parking brake automatically (► page 153).</li> </ul> <p>If the electric parking brake still cannot be released:</p> <ul style="list-style-type: none"> <li>► Do not drive on.</li> <li>► Consult a qualified specialist workshop.</li> </ul>









Display messages	Possible causes/consequences and ► Solutions
	<p>The red  (USA only)/ (Canada only) indicator lamp flashes and the yellow  warning lamp lights up. The electric parking brake is malfunctioning.</p> <p><b>To release:</b></p> <ul style="list-style-type: none"> <li>► Switch off the ignition and turn it back on.</li> <li>► Release the electric parking brake manually.</li> </ul> <p><b>To apply:</b></p> <ul style="list-style-type: none"> <li>► Switch off the ignition and turn it back on.</li> <li>► Apply the electric parking brake manually.</li> </ul> <p>If the red  (USA only)/ (Canada only) indicator lamp continues to flash:</p> <ul style="list-style-type: none"> <li>► Do not drive on.</li> <li>► Secure the vehicle against rolling away (▷ page 323).</li> <li>► Shift the selector lever to position <b>P</b>.</li> <li>► Turn the front wheels towards the curb.</li> <li>► Consult a qualified specialist workshop.</li> </ul>
	<p>The yellow  warning lamp lights up. The red  (USA only)/ (Canada only) indicator lamp flashes for about ten seconds after the electric parking brake has been applied or released. It then goes out or remains lit. The electric parking brake is malfunctioning.</p> <ul style="list-style-type: none"> <li>► Switch off the ignition and turn it back on.</li> <li>► Apply the electric parking brake.</li> </ul> <p>If it is not possible to engage the electric parking brake:</p> <ul style="list-style-type: none"> <li>► Shift the selector lever to position <b>P</b>.</li> <li>► Visit a qualified specialist workshop.</li> </ul> <p>If it is not possible to release the electric parking brake manually:</p> <ul style="list-style-type: none"> <li>► Release the electric parking brake automatically (▷ page 153).</li> </ul> <p>If the electric parking brake still cannot be released:</p> <ul style="list-style-type: none"> <li>► Consult a qualified specialist workshop.</li> </ul>

Display messages	Possible causes/consequences and ► Solutions
	<p>The yellow  warning lamp lights up. If you manually apply or release the electric parking brake, the red  (USA only)/ (Canada only) indicator lamp flashes.</p> <p>The electric parking brake is malfunctioning. It is not possible to apply the electric parking brake manually.</p> <ul style="list-style-type: none"> <li>► Shift the selector lever to <b>P</b>, as the electric parking brake is not applied automatically.</li> <li>► Visit a qualified specialist workshop.</li> </ul>
<p> (USA only)  (Canada only)</p> <p><b>Parking Brake Inoperative</b></p>	<p>The yellow  warning lamp lights up. The red  (USA only)/ (Canada only) indicator lamp flashes for about ten seconds after the electric parking brake has been applied or released. It then goes out or remains lit.</p> <p>The electric parking brake is malfunctioning, e.g. because of overvoltage or undervoltage.</p> <ul style="list-style-type: none"> <li>► Remove the cause for the overvoltage or undervoltage, e.g. by charging the battery or restarting the engine.</li> <li>► Engage or release the electric parking brake.</li> </ul> <p>If it remains impossible to apply or release the electric parking brake:</p> <ul style="list-style-type: none"> <li>► Switch off the ignition and turn it back on.</li> <li>► Engage or release the electric parking brake.</li> </ul> <p>If the electric parking brake still cannot be released:</p> <ul style="list-style-type: none"> <li>► Consult a qualified specialist workshop.</li> </ul> <p>If the electric parking brake still cannot be applied:</p> <ul style="list-style-type: none"> <li>► Visit a qualified specialist workshop.</li> </ul> <p>The yellow  warning lamp lights up and the red  (USA only)/ (Canada only) indicator lamp flashes.</p> <p>It is not possible to apply the electric parking brake manually.</p> <ul style="list-style-type: none"> <li>► Shift the selector lever to position <b>P</b>.</li> <li>► Visit a qualified specialist workshop.</li> </ul>

Display messages	Possible causes/consequences and ► Solutions
<p> (USA only)  (Canada only)</p> <p>Check Brake Fluid Level</p>	<p>There is not enough brake fluid in the brake fluid reservoir. A warning tone sounds. The  (USA only)/  (Canada only) warning lamps in the instrument cluster may also light up.</p> <p> <b>WARNING</b></p> <p>The braking effect may be impaired. There is a risk of an accident.</p> <ul style="list-style-type: none"> <li>► Pull over and stop the vehicle safely as soon as possible, paying attention to road and traffic conditions. Do not continue driving under any circumstances.</li> <li>► Secure the vehicle against rolling away (▷ page 152).</li> <li>► Consult a qualified specialist workshop.</li> <li>► Do not add brake fluid. This does not correct the malfunction.</li> </ul>
<p></p> <p>Check Brake Pad Wear</p>	<p>The brake pads/linings have reached their wear limit.</p> <ul style="list-style-type: none"> <li>► Visit a qualified specialist workshop.</li> </ul>
<p></p> <p>Inoperative</p>	<p>One or more main features of the mbrace system are malfunctioning.</p> <ul style="list-style-type: none"> <li>► Have the mbrace system checked immediately at a qualified specialist workshop.</li> </ul>
<p>Collision Prevention Assist Plus Currently Unavailable See Operator's Manual</p>	<p>COLLISION PREVENTION ASSIST PLUS is temporarily not operational.</p> <p>Possible causes are:</p> <ul style="list-style-type: none"> <li>• the radar sensor system is temporarily inoperative, e.g. due to electromagnetic radiation emitted by nearby TV or radio stations or other sources of electromagnetic radiation.</li> <li>• the system is outside the operating temperature range.</li> <li>• the on-board voltage is too low.</li> </ul> <p>When the causes stated above no longer apply, the display message disappears.</p> <p>COLLISION PREVENTION ASSIST PLUS is operational again.</p> <p>If the display message does not disappear:</p> <ul style="list-style-type: none"> <li>► Pull over and stop the vehicle safely as soon as possible, paying attention to road and traffic conditions.</li> <li>► Secure the vehicle against rolling away (▷ page 152).</li> <li>► Restart the engine.</li> </ul>



Display messages	Possible causes/consequences and ► Solutions
<p>Collision Prevention Assist Plus Inoperative</p>	<p>COLLISION PREVENTION ASSIST PLUS is temporarily inoperative due to a malfunction. Adaptive Brake Assist may also have failed.</p> <p>► Visit a qualified specialist workshop.</p>
<p>Radar Sensors Dirty See Operator's Manual</p>	<p>At least one of the following driving systems or driving safety systems is temporarily restricted or inoperative:</p> <ul style="list-style-type: none"> <li>• COLLISION PREVENTION ASSIST PLUS</li> <li>• DISTRONIC PLUS</li> </ul> <p>Possible causes are:</p> <ul style="list-style-type: none"> <li>• the sensors in the radiator trim and/or in the bumpers are dirty.</li> <li>• the function of the driving system and/or driving safety system is impaired due to heavy rain or snow.</li> </ul> <p>A warning tone also sounds.</p> <p>When the causes stated above no longer apply, the display message disappears. All driving systems/driving safety systems are operative again.</p> <p>If the display message does not disappear:</p> <ul style="list-style-type: none"> <li>► Pull over and stop the vehicle safely as soon as possible, paying attention to road and traffic conditions.</li> <li>► Secure the vehicle against rolling away (▷ page 152).</li> <li>► Switch off the engine.</li> <li>► Clean the sensors in the following locations (▷ page 279):                             <ul style="list-style-type: none"> <li>• in the radiator trim</li> <li>• in the front bumper</li> <li>• in the rear bumper, particularly in the middle of the rear bumper</li> </ul> </li> <li>► Restart the engine.</li> </ul> <p>The display message disappears.</p>
<p> SRS Malfunction Service Required</p>	<p>The restraint system is faulty. The  warning lamp also lights up in the instrument cluster.</p> <p><b>⚠ WARNING</b></p> <p>The air bags or Emergency Tensioning Devices may either be triggered unintentionally or, in the event of an accident, may not be triggered.</p> <p>There is an increased risk of injury.</p> <p>► Visit a qualified specialist workshop.</p> <p>For further information about the restraint system, see (▷ page 38).</p>

Display messages	Possible causes/consequences and ► Solutions
 <p>Front Left Malfunction Service Required or Front Right Malfunction Service Required</p>	<p>The restraint system has malfunctioned at the front on the left or right. The  warning lamp also lights up in the instrument cluster.</p> <p><b>⚠ WARNING</b></p> <p>The air bags or Emergency Tensioning Devices may either be triggered unintentionally or, in the event of an accident, may not be triggered.</p> <p>There is an increased risk of injury.</p> <p>► Visit a qualified specialist workshop.</p>
 <p>Rear Left Malfunction Service Required or Rear Right Malfunction Service Required</p>	<p>The rear left-hand or right-hand restraint system has malfunctioned. The  warning lamp also lights up in the instrument cluster.</p> <p><b>⚠ WARNING</b></p> <p>The air bags or Emergency Tensioning Devices may either be triggered unintentionally or, in the event of an accident, may not be triggered.</p> <p>There is an increased risk of injury.</p> <p>► Visit a qualified specialist workshop.</p>
 <p>Rear Center Malfunction Service Required</p>	<p>The rear center restraint system has malfunctioned. The  warning lamp also lights up in the instrument cluster.</p> <p><b>⚠ WARNING</b></p> <p>The air bags or Emergency Tensioning Devices may either be triggered unintentionally or, in the event of an accident, may not be triggered.</p> <p>There is an increased risk of injury.</p> <p>► Visit a qualified specialist workshop.</p>
 <p>Left Side Curtain Airbag Malfunction Service Required or Right Side Curtain Airbag Malfunction Service Required</p>	<p>There is a malfunction in the left-hand or right-hand window curtain air bag. The  warning lamp also lights up in the instrument cluster.</p> <p><b>⚠ WARNING</b></p> <p>The left or right window curtain air bag may either be triggered unintentionally or, in the event of an accident, may not be triggered.</p> <p>There is an increased risk of injury.</p> <p>► Visit a qualified specialist workshop.</p>



Display messages	Possible causes/consequences and ► Solutions
<p>Front Passenger Airbag Disabled See Operator's Manual</p>	<p>The front-passenger air bag is deactivated during the journey, even though:</p> <ul style="list-style-type: none"> <li>• an adult</li> <li>or</li> <li>• a person of the corresponding stature is on the front-passenger seat</li> </ul> <p>If additional forces are applied to the seat, the system may interpret the occupant's weight as lower than it actually is.</p> <p> <b>WARNING</b></p> <p>The front-passenger air bag does not deploy during an accident. There is an increased risk of injury.</p> <ul style="list-style-type: none"> <li>► Pull over and stop the vehicle safely as soon as possible, paying attention to road and traffic conditions.</li> <li>► Secure the vehicle against rolling away (► page 152).</li> <li>► Switch the ignition off.</li> <li>► Have the occupant get out of the vehicle.</li> <li>► Keep the seat unoccupied, close the front-passenger door and switch on the ignition.</li> <li>► Observe the PASSENGER AIR BAG indicator lamps in the center console and the multifunction display and check the following: <ul style="list-style-type: none"> <li>Seat unoccupied and ignition switched on: <ul style="list-style-type: none"> <li>• the PASSENGER AIR BAG OFF and PASSENGER AIR BAG ON indicator lamps must light up simultaneously for approximately six seconds</li> <li>• the PASSENGER AIR BAG OFF indicator lamp must then light up and remain lit. If the indicator lamp is on, OCS has disabled the front-passenger front air bag (► page 47)</li> <li>• the <a href="#">Front Passenger Airbag Enabled See Operator's Manual</a> or <a href="#">Front Passenger Airbag Disabled See Operator's Manual</a> display messages must not be shown in the multifunction display.</li> </ul> </li> </ul> </li> <li>► Wait for a period of at least 60 seconds until the necessary system checks have been completed.</li> <li>► Make sure that the display messages do not appear in the multifunction display.</li> </ul> <p>If these conditions are fulfilled, the front-passenger seat can be occupied again. Whether the PASSENGER AIR BAG OFF or ON indicator lamp remains lit or goes out depends on how OCS classifies the occupant.</p> <p>If the conditions are not fulfilled, the system is not operating correctly.</p>









Display messages	Possible causes/consequences and ► Solutions
	<p>► Visit a qualified specialist workshop immediately.</p> <p>For further information about the Occupant Classification System, see (&gt; page 47).</p>
<p>Front Passenger Airbag Enabled See Operator's Manual</p>	<p>The front-passenger air bag is enabled during the journey, even though:</p> <ul style="list-style-type: none"> <li>• a child, a small adult or an object weighing less than the system's weight threshold is located on the front-passenger seat or</li> <li>• the front-passenger seat is unoccupied</li> </ul> <p>The system may detect objects or forces applying additional weight on the seat.</p> <p> <b>WARNING</b></p> <p>The air bag may deploy unintentionally. There is an increased risk of injury.</p> <ul style="list-style-type: none"> <li>► Pull over and stop the vehicle safely as soon as possible, paying attention to road and traffic conditions.</li> <li>► Secure the vehicle against rolling away (&gt; page 152).</li> <li>► Switch the ignition off.</li> <li>► Open the front-passenger door.</li> <li>► Remove the child and the child restraint system from the front-passenger seat.</li> <li>► Make sure that there are no objects on the seat adding to the weight.</li> </ul> <p>The system may otherwise detect the additional weight and interpret the seat occupant's weight as greater than it actually is.</p> <ul style="list-style-type: none"> <li>► Keep the seat unoccupied, close the front-passenger door and switch on the ignition.</li> <li>► Observe the PASSENGER AIR BAG indicator lamps in the center console and the multifunction display and check the following: <ul style="list-style-type: none"> <li>Seat unoccupied and ignition switched on: <ul style="list-style-type: none"> <li>• the PASSENGER AIR BAG OFF and PASSENGER AIR BAG ON indicator lamps must light up simultaneously for approximately six seconds</li> <li>• the PASSENGER AIR BAG OFF indicator lamp must then light up and remain lit. If the indicator lamp is on, OCS (Occupant Classification System) has disabled the front-passenger front air bag (&gt; page 47)</li> <li>• the <a href="#">Front Passenger Airbag Enabled See Operator's Manual</a> or <a href="#">Front Passenger Airbag Disabled See Oper-</a></li> </ul> </li> </ul> </li> </ul>









Display messages	Possible causes/consequences and ► Solutions
	<p><a href="#">ator's Manual</a> display messages must not be shown in the multifunction display.</p> <ul style="list-style-type: none"> <li>► Wait for a period of at least 60 seconds until the necessary system checks have been completed.</li> <li>► Make sure that the display messages do not appear in the multifunction display.</li> </ul> <p>If these conditions are fulfilled, the front-passenger seat can be occupied again. Whether the PASSENGER AIR BAG OFF or ON indicator lamp remains lit or goes out depends on how OCS classifies the occupant.</p> <p>If the conditions are not fulfilled, the system is not operating correctly.</p> <ul style="list-style-type: none"> <li>► Visit a qualified specialist workshop immediately.</li> </ul> <p>For further information about the Occupant Classification System, see (▷ page 47).</p>



**Lights**

**i** Vehicles with LED bulbs in the light clusters:  
 The display message for the corresponding light will only appear if all the LEDs have failed.



Display messages	Possible causes/consequences and ► Solutions
 Check Left Low Beam or Check Right Low Beam	The left or right-hand low-beam headlamp is defective. <ul style="list-style-type: none"> <li>► <b>Halogen headlamp:</b> replace the bulb (▷ page 109).</li> <li>► <b>LED headlamps:</b> consult a qualified specialist workshop.</li> </ul>
 Check Rear Left Turn Signal or Check Rear Right Turn Signal	The rear left-hand or rear right-hand turn signal is defective. <ul style="list-style-type: none"> <li>► <b>Tail lamps (vehicles with halogen headlamps):</b> replace the bulb (▷ page 109).</li> <li>► <b>Tail lamps (vehicles with LED headlamps):</b> visit a qualified specialist workshop.</li> </ul>
 Check Front Left Turn Signal or Check Front Right Turn Signal	The front left-hand or front right-hand turn signal is defective. <ul style="list-style-type: none"> <li>► <b>Halogen headlamp:</b> replace the bulb (▷ page 109).</li> <li>► <b>LED headlamps:</b> consult a qualified specialist workshop.</li> </ul>

Display messages	Possible causes/consequences and ► Solutions
 <p>Check Left Mirror Turn Signal or Check Right Mirror Turn Signal</p>	<p>The turn signal in the left-hand or right-hand exterior mirror is defective.</p> <p>► Visit a qualified specialist workshop.</p>
 <p>Check Center Brake Lamp</p>	<p>The high-mounted brake lamp is faulty.</p> <p>► Visit a qualified specialist workshop.</p>
 <p>Check Left Brake Lamp or Check Right Brake Lamp</p>	<p>The left or right-hand brake lamp is defective.</p> <p>► Visit a qualified specialist workshop.</p>
 <p>Check Left Tail and Brake Lamps or Check Right Tail and Brake Lamps</p>	<p>The left or right-hand tail lamp/brake lamp is defective.</p> <p>► Visit a qualified specialist workshop.</p>
 <p>Check Left High Beam or Check Right High Beam</p>	<p>The left or right-hand high beam is defective.</p> <p>► <b>Halogen headlamp:</b> replace the bulb (&gt; page 109).</p> <p>► <b>LED headlamps:</b> consult a qualified specialist workshop.</p>
 <p>License Plate Lamp</p>	<p>The left or right-hand license plate lamp is faulty.</p> <p>► Check whether you are permitted to replace the bulb yourself (&gt; page 109).</p> <p>or</p> <p>► Visit a qualified specialist workshop.</p>
 <p>Check Left Fog Lamp or Check Right Fog Lamp</p>	<p>The left or right-hand fog lamp is faulty.</p> <p>► Visit a qualified specialist workshop.</p>
 <p>Rear Fog Lamp</p>	<p>The rear fog lamp is faulty.</p> <p>► <b>Tail lamps (vehicles with halogen headlamps):</b> replace the bulb (&gt; page 109).</p> <p>► <b>Tail lamps (vehicles with LED headlamps):</b> visit a qualified specialist workshop.</p>





Display messages	Possible causes/consequences and ► Solutions
 <p>Check Front Left Parking Lamp or Check Front Right Parking Lamp</p>	<p>The front left or front right parking or standing lamp is defective.</p> <ul style="list-style-type: none"> <li>► Visit a qualified specialist workshop.</li> </ul>
 <p>Backup Light</p>	<p>The backup lamp is defective.</p> <ul style="list-style-type: none"> <li>► <b>Tail lamps (vehicles with halogen headlamps):</b> replace the bulb (► page 109).</li> <li>► <b>Tail lamps (vehicles with LED headlamps):</b> visit a qualified specialist workshop.</li> </ul>
 <p>Check Left Tail Lamp or Check Right Tail Lamp</p>	<p>The left or right-hand tail lamp is defective.</p> <ul style="list-style-type: none"> <li>► Visit a qualified specialist workshop.</li> </ul>
 <p>Check Front Left Sidemarkers Lamp or Check Front Right Sidemarkers Lamp</p>	<p>The front left-hand or front right-hand side marker lamp is faulty.</p> <ul style="list-style-type: none"> <li>► Visit a qualified specialist workshop.</li> </ul>
 <p>Check Rear Left Sidemarkers Lamp or Check Rear Right Sidemarkers Lamp</p>	<p>The rear left-hand or rear right-hand side marker lamp is faulty.</p> <ul style="list-style-type: none"> <li>► Visit a qualified specialist workshop.</li> </ul>
 <p>Check Left Daytime Running Light or Check Right Daytime Running Light</p>	<p>The left or right-hand daytime running lamp is faulty.</p> <ul style="list-style-type: none"> <li>► Visit a qualified specialist workshop.</li> </ul>
 <p>Active Headlamps Inoperative</p>	<p>The active light function is faulty.</p> <ul style="list-style-type: none"> <li>► Visit a qualified specialist workshop.</li> </ul>
 <p>Malfunction See Operator's Manual</p>	<p>The exterior lighting is defective.</p> <ul style="list-style-type: none"> <li>► Visit a qualified specialist workshop.</li> </ul>





Display messages	Possible causes/consequences and ► Solutions
 Active Headlamps Inoperative	The light sensor is defective. ► Visit a qualified specialist workshop.
 Switch Off Lights	The lights are still switched on when you leave the vehicle. A warning tone also sounds. ► Turn the light switch to <b>AUTO</b> .



## Engine



Display messages	Possible causes/consequences and ► Solutions
 Check Coolant Level See Operator's Manual	The coolant level is too low. <b>!</b> Avoid making long journeys with too little coolant in the engine cooling system. The engine will otherwise be damaged. ► Add coolant, observing the warning notes before doing so (► page 273). ► If coolant needs to be added more often than usual, have the engine coolant system checked at a qualified specialist workshop.
	The fan motor is faulty. ► At coolant temperatures below 248 °F (120 °C), drive to the nearest qualified specialist workshop. ► Avoid subjecting the engine to heavy loads, e.g. driving in mountainous terrain, and stop-and-go traffic.





Display messages	Possible causes/consequences and ► Solutions
 <p data-bbox="211 324 431 413">Coolant Too Hot Stop Vehicle Turn Engine Off</p>	<p data-bbox="471 275 760 333">The coolant is too hot. A warning tone also sounds.</p> <p data-bbox="481 351 632 381"> <b>WARNING</b></p> <p data-bbox="471 396 1131 476">Do not drive when your engine is overheated. This can cause some fluids which may have leaked into the engine compartment to catch fire.</p> <p data-bbox="471 491 1131 542">Steam from the overheated engine can also cause serious burns which can occur just by opening the hood.</p> <p data-bbox="471 557 711 578">There is a risk of injury.</p> <ul style="list-style-type: none"> <li data-bbox="471 593 1131 645">► Pull over and stop the vehicle safely and switch off the engine, paying attention to road and traffic conditions.</li> <li data-bbox="471 659 1037 680">► Secure the vehicle against rolling away (► page 152).</li> <li data-bbox="471 695 889 716">► Wait until the engine has cooled down.</li> <li data-bbox="471 731 1131 783">► Make sure that the air supply to the engine radiator is not blocked, e.g. by snow, slush or ice.</li> <li data-bbox="471 797 1131 876">► Do not start the engine again until the display message goes out and the coolant temperature is below 248 °F (120 °C). Otherwise, the engine could be damaged.</li> <li data-bbox="471 890 994 912">► Pay attention to the coolant temperature display.</li> <li data-bbox="471 926 1131 978">► If the temperature increases again, visit a qualified specialist workshop immediately.</li> </ul> <p data-bbox="471 992 1131 1044">Under normal operating conditions and with the specified coolant level, the coolant temperature may rise to 248 °F (120 °C).</p>
 <p data-bbox="211 1112 451 1170">See Operator's Manual</p>	<p data-bbox="471 1064 808 1085">The battery is not being charged.</p> <p data-bbox="471 1100 760 1121">A warning tone also sounds.</p> <p data-bbox="471 1136 681 1157">Possible causes are:</p> <ul style="list-style-type: none"> <li data-bbox="481 1171 711 1193">• a defective alternator</li> <li data-bbox="481 1207 672 1229">• a torn poly-V-belt</li> <li data-bbox="481 1243 817 1265">• a malfunction in the electronics</li> </ul> <p data-bbox="471 1279 1131 1313"> Do not continue driving. The engine could otherwise overheat.</p> <ul style="list-style-type: none"> <li data-bbox="471 1327 1131 1379">► Pull over and stop the vehicle safely and switch off the engine, paying attention to road and traffic conditions.</li> <li data-bbox="471 1394 1037 1415">► Secure the vehicle against rolling away (► page 152).</li> <li data-bbox="471 1430 898 1451">► Consult a qualified specialist workshop.</li> </ul>

Display messages	Possible causes/consequences and ► Solutions
 <p>Stop Vehicle See Operator's Manual</p>	<p>The battery is no longer being charged and the battery charge level is too low.</p> <p>A warning tone also sounds.</p> <ul style="list-style-type: none"> <li>► Pull over and stop the vehicle safely and switch off the engine, paying attention to road and traffic conditions.</li> <li>► Secure the vehicle against rolling away (▷ page 152).</li> <li>► Observe the instructions in the  See Operator's Manual display message.</li> <li>► Consult a qualified specialist workshop.</li> </ul>
 <p>Check Engine Oil When Next Refueling</p>	<p>The engine oil level has dropped to the minimum level.</p> <p>A warning tone also sounds.</p> <p><b>!</b> Avoid long journeys with too little engine oil. The engine will otherwise be damaged.</p> <ul style="list-style-type: none"> <li>► Check the oil level when next refueling, at the latest (▷ page 272).</li> <li>► If necessary, add engine oil (▷ page 272).</li> <li>► Have the engine checked at a qualified specialist workshop if engine oil needs to be added more often than usual.</li> </ul> <p>Information on approved engine oils can be obtained from any qualified specialist workshop or on the Internet at <a href="http://bevo.mercedes-benz.com">http://bevo.mercedes-benz.com</a>.</p>
 <p>Check Engine Oil Level (Add 1 quart)</p>	<p>The engine oil level has dropped to the minimum level.</p> <p><b>!</b> Avoid long journeys with too little engine oil. The engine will otherwise be damaged.</p> <ul style="list-style-type: none"> <li>► Check the oil level when next refueling, at the latest (▷ page 272).</li> <li>► If necessary, add engine oil (▷ page 272).</li> <li>► Have the engine checked at a qualified specialist workshop if engine oil needs to be added more often than usual.</li> </ul> <p>Information on approved engine oils can be obtained from any qualified specialist workshop or on the Internet at <a href="http://bevo.mercedes-benz.com">http://bevo.mercedes-benz.com</a>.</p>
 <p>Engine Oil Level Low Stop Vehicle Turn Engine Off</p>	<p>The engine oil level is too low. There is a risk of engine damage.</p> <ul style="list-style-type: none"> <li>► Pull over and stop the vehicle safely and switch off the engine, paying attention to road and traffic conditions.</li> <li>► Secure the vehicle against rolling away (▷ page 152).</li> <li>► Check the engine oil level (▷ page 272).</li> <li>► If necessary, add engine oil (▷ page 272).</li> </ul>

Display messages	Possible causes/consequences and ► Solutions
 Fuel Level Low	The fuel level has dropped into the reserve range. ► Refuel at the nearest gas station.
 Fuel Level Low	There is only a very small amount of fuel in the fuel tank. ► Refuel at the nearest gas station without fail.
 Gas Cap Loose	The fuel system pressure is too low. The fuel filler cap is not closed correctly or the fuel system is leaking. ► Check that the fuel filler cap is correctly closed. <b>If the fuel filler cap is not correctly closed:</b> ► Close the fuel filler cap. <b>If the fuel filler cap is correctly closed:</b> ► Visit a qualified specialist workshop.

Driving systems	
Display messages	Possible causes/consequences and ► Solutions
 Attention Assist: Take a Break!	Based on certain criteria, ATTENTION ASSIST has detected fatigue or a lack of concentration on the part of the driver. A warning tone also sounds. ► If necessary, take a break.  During long journeys, take regular breaks in good time so you get enough rest.
 Attention Assist Inoperative	ATTENTION ASSIST is inoperative. ► Visit a qualified specialist workshop.
 HOLD Off	The HOLD function is deactivated. The vehicle is skidding. A warning tone also sounds. ► Reactivate the HOLD function later (► page 170).  The HOLD function is deactivated. When the brake pedal is firmly depressed, an activation condition is not fulfilled. A warning tone also sounds. ► Check the activation conditions for the HOLD function (► page 170).

Display messages	Possible causes/consequences and ► Solutions
<p>Lane Keeping Assist Currently Unavailable See Operator's Manual</p>	<p>Lane Keeping Assist is deactivated and temporarily inoperative. Possible causes are:</p> <ul style="list-style-type: none"> <li>• the windshield in the camera's field of vision is dirty.</li> <li>• visibility is impaired due to heavy rain, snow or fog.</li> <li>• there have been no lane markings for an extended period.</li> <li>• the lane markings are worn, dark or covered, e.g. by dirt or snow.</li> </ul> <p>When the causes stated above no longer apply, the display message disappears.</p> <p>Lane Keeping Assist is operational again.</p> <p>If the display message does not disappear:</p> <ul style="list-style-type: none"> <li>► Pull over and stop the vehicle safely as soon as possible, paying attention to road and traffic conditions.</li> <li>► Secure the vehicle against rolling away (▷ page 152).</li> <li>► Clean the windshield.</li> </ul>
<p>Lane Keeping Assist Inoperative</p>	<p>Lane Keeping Assist is faulty.</p> <ul style="list-style-type: none"> <li>► Visit a qualified specialist workshop.</li> </ul>
<p>Blind Spot Assist Currently Unavailable See Operator's Manual</p>	<p>Blind Spot Assist is temporarily inoperative. Possible causes are:</p> <ul style="list-style-type: none"> <li>• function is impaired due to heavy rain or snow.</li> <li>• the radar sensor system is temporarily inoperative, e.g. due to electromagnetic radiation emitted by nearby TV or radio stations or other sources of electromagnetic radiation.</li> <li>• the radar sensor system is outside the operating temperature range.</li> </ul> <p>The yellow  indicator lamps also light up in the exterior mirrors.</p> <p>When the causes stated above no longer apply, the display message disappears.</p> <p>Blind Spot Assist is operational again.</p> <p>If the display message does not disappear:</p> <ul style="list-style-type: none"> <li>► Pull over and stop the vehicle safely as soon as possible, paying attention to road and traffic conditions.</li> <li>► Secure the vehicle against rolling away (▷ page 152).</li> <li>► Restart the engine.</li> </ul>
<p>Blind Spot Assist Inoperative</p>	<p>Blind Spot Assist is defective.</p> <p>The yellow  indicator lamps also light up in the exterior mirrors.</p> <ul style="list-style-type: none"> <li>► Visit a qualified specialist workshop.</li> </ul>

Display messages	Possible causes/consequences and ► Solutions
Park Assist Canceled	The driver's door is open and the driver's seat belt has not been fastened. ► Repeat the parking process with the seat belt fastened and the driver's door closed.
	You have inadvertently touched the multifunction steering wheel while steering intervention was active. ► While steering intervention is active, make sure that the multifunction steering wheel is not touched unintentionally.
	The vehicle has started to skid and ESP <sup>®</sup> has intervened. ► Use Active Parking Assist again later (► page 175).
Park Assist Inoperative	You have just carried out a large number of turning or parking maneuvers. Active Parking Assist will become available again after approximately ten minutes (► page 175). ► Pull over and stop the vehicle safely as soon as possible, paying attention to road and traffic conditions. ► Switch off and restart the engine. If the display message continues to be displayed: ► Visit a qualified specialist workshop.
	PARKTRONIC is defective. ► Visit a qualified specialist workshop.
Park Assist Finished	The vehicle is parked. A warning tone also sounds. The display message disappears automatically.
DISTRONIC PLUS Off	DISTRONIC PLUS has been deactivated (► page 163). If it was not deactivated by the driver, a warning tone also sounds.
DISTRONIC PLUS Now Available	DISTRONIC PLUS is operational again after having been temporarily unavailable. You can now reactivate DISTRONIC PLUS (► page 163).



Display messages	Possible causes/consequences and ► Solutions
DISTRONIC PLUS Currently Unavailable See Operator's Manual	<p>DISTRONIC PLUS is temporarily inoperative.</p> <p>Possible causes are:</p> <ul style="list-style-type: none"> <li>• function is impaired due to heavy rain or snow.</li> <li>• the radar sensor system is temporarily inoperative, e.g. due to electromagnetic radiation emitted by nearby TV or radio stations or other sources of electromagnetic radiation.</li> <li>• the system is outside the operating temperature range.</li> <li>• the on-board voltage is too low.</li> </ul> <p>A warning tone also sounds.</p> <p>When the causes stated above no longer apply, the display message disappears.</p> <p>DISTRONIC PLUS is operational again.</p> <p>If the display message does not disappear:</p> <ul style="list-style-type: none"> <li>► Pull over and stop the vehicle safely as soon as possible, paying attention to road and traffic conditions.</li> <li>► Secure the vehicle against rolling away (▷ page 152).</li> <li>► Restart the engine.</li> </ul>
DISTRONIC PLUS Inoperative	<p>DISTRONIC PLUS is defective. Adaptive Brake Assist may also have failed.</p> <p>A warning tone also sounds.</p> <ul style="list-style-type: none"> <li>► Visit a qualified specialist workshop.</li> </ul>
DISTRONIC PLUS Suspended	<p>You have depressed the accelerator pedal. DISTRONIC PLUS is no longer controlling the speed of the vehicle.</p> <ul style="list-style-type: none"> <li>► Remove your foot from the accelerator pedal.</li> </ul>
DISTRONIC PLUS - - - mph	<p>An activation condition for DISTRONIC PLUS is not fulfilled.</p> <ul style="list-style-type: none"> <li>► Check the activation conditions for DISTRONIC PLUS (▷ page 163).</li> </ul>
Cruise Control Inoperative	<p>Cruise control is malfunctioning.</p> <p>A warning tone also sounds.</p> <ul style="list-style-type: none"> <li>► Visit a qualified specialist workshop.</li> </ul>
Cruise Control - - - mph	<p>A condition for activating cruise control has not been fulfilled. You have tried to store a speed below 20 mph (30 km/h), for example.</p> <ul style="list-style-type: none"> <li>► If conditions permit, drive faster than 20 mph (30 km/h) and store the speed.</li> <li>► Check the activation conditions for cruise control (▷ page 161).</li> </ul>







Tires	
Display messages	Possible causes/consequences and ► Solutions
Check Tire Pressure Soon	<p>The tire pressure loss warning system has detected a significant loss in pressure. A warning tone also sounds. Possible causes:</p> <ul style="list-style-type: none"> <li>• you have changed the positions of the wheels and tires or installed new wheels and tires.</li> <li>• the tire pressure in one or more tires is not correct.</li> </ul> <p> <b>WARNING</b></p> <p>Tire pressures that are too low pose the following hazards:</p> <ul style="list-style-type: none"> <li>• they may burst, especially as the load and vehicle speed increase.</li> <li>• they may wear excessively and/or unevenly, which may greatly impair tire traction.</li> <li>• the driving characteristics, as well as steering and braking, may be greatly impaired.</li> </ul> <p>There is a risk of an accident.</p> <ul style="list-style-type: none"> <li>► Stop the vehicle without making any sudden steering or braking maneuvers. Pay attention to the traffic conditions as you do so.</li> <li>► Secure the vehicle against rolling away (▷ page 152).</li> <li>► Check the tires and, if necessary, follow the instructions for a flat tire (▷ page 284).</li> <li>► Check the tire pressures and, if necessary, correct the tire pressure.</li> <li>► Restart the tire pressure loss warning system when the tire pressure is correct (▷ page 309).</li> </ul>
Check Tire Pressure Then Restart Run Flat Indicator	<p>The tire pressure loss warning system generated a display message and has not been restarted since.</p> <ul style="list-style-type: none"> <li>► Set the correct tire pressure in all four tires.</li> <li>► Restart the tire pressure loss warning system (▷ page 309).</li> </ul>
Run Flat Indicator inoperative	<p>The tire pressure loss warning system is faulty.</p> <ul style="list-style-type: none"> <li>► Visit a qualified specialist workshop.</li> </ul>

Vehicle	
Display messages	Possible causes/consequences and ► Solutions
Depress Brake to Start Engine	<p>You have attempted to start the engine with the transmission in position <b>N</b> without depressing the brake pedal.</p> <p>► Depress the brake pedal.</p>
To Deselect P or N, Depress Brake and Start Engine	<p>You have attempted to shift the selector lever to position <b>R</b> or <b>D</b> without starting the engine.</p> <p>► Start the engine. ► Depress the brake pedal.</p> <p><b>i</b> It is only possible to move the selector lever from position <b>P</b> to the desired position if you depress the brake pedal. Only then can the parking lock be deactivated. If you do not depress the brake pedal, the DIRECT SELECT lever can still be moved but the parking lock remains engaged.</p> <p><b>i</b> At transmission fluid temperatures below -4 °F (-20 °C) you can only shift out of position <b>P</b> into another transmission position when the engine is running.</p>
Apply Brake to Shift from 'P'	<p>You have attempted to shift the selector lever to position <b>R</b>, <b>N</b> or <b>D</b> without depressing the brake pedal.</p> <p>► Depress the brake pedal.</p>
Transmission Not in P Risk of Vehicle Rolling Away	<p>The driver's door is open/not fully closed and the selector lever is in position <b>R</b>, <b>N</b> or <b>D</b>. A warning tone also sounds.</p> <p><b>⚠ WARNING</b></p> <p>The vehicle may roll away. There is a risk of an accident.</p> <p>► Shift the selector lever to position <b>P</b>. ► Secure the vehicle against rolling away (▷ page 152). ► Close the driver's door completely.</p>



Display messages	Possible causes/consequences and ► Solutions
Service Required Do Not Shift Gears Visit Dealer	<p>You cannot change the transmission position due to a malfunction. A warning tone also sounds.</p> <p>If transmission position <b>D</b> is selected:</p> <ul style="list-style-type: none"> <li>► Drive to a qualified specialist workshop without shifting the transmission from position <b>D</b>.</li> </ul> <p>If transmission position <b>R</b>, <b>N</b> or <b>P</b> is selected:</p> <ul style="list-style-type: none"> <li>► Secure the vehicle against rolling away (▷ page 152).</li> <li>► Notify a qualified specialist workshop or breakdown service.</li> </ul>
Only Shift to 'P' when Vehicle is Stationary	<p>The vehicle is moving.</p> <ul style="list-style-type: none"> <li>► Pull over and stop the vehicle safely as soon as possible, paying attention to road and traffic conditions.</li> <li>► Shift the selector lever to position <b>P</b>.</li> </ul>
Reversing Not Possible Service Required	<p>The automatic transmission is malfunctioning. You cannot back up.</p> <ul style="list-style-type: none"> <li>► Visit a qualified specialist workshop.</li> </ul>
Transmission Malfunction	<p>The automatic transmission is malfunctioning.</p> <ul style="list-style-type: none"> <li>► Visit a qualified specialist workshop.</li> </ul>
Transmission Malfunction Stop	<p>The automatic transmission is malfunctioning.</p> <ul style="list-style-type: none"> <li>► Pull over and stop the vehicle safely as soon as possible, paying attention to road and traffic conditions.</li> <li>► Secure the vehicle against rolling away (▷ page 152).</li> <li>► Consult a qualified specialist workshop.</li> </ul>
Stop Vehicle Shift to 'P' Leave Engine Running	<p>The automatic transmission has overheated.</p> <ul style="list-style-type: none"> <li>► Drive on carefully.</li> </ul> <p>The automatic transmission is available again when the display message goes out.</p> <p>If the display message continues to be displayed:</p> <ul style="list-style-type: none"> <li>► Pull over and stop the vehicle safely as soon as possible, paying attention to road and traffic conditions.</li> <li>► Secure the vehicle against rolling away (▷ page 152).</li> <li>► Wait until the automatic transmission has cooled down and the display message has disappeared.</li> </ul>

Display messages	Possible causes/consequences and ► Solutions
Auxiliary Battery Malfunction	<p>The auxiliary battery for the automatic transmission is no longer being charged.</p> <ul style="list-style-type: none"> <li>► Visit a qualified specialist workshop at the next opportunity.</li> <li>► Until then, set the selector lever to position <b>P</b> before you switch off the engine.</li> <li>► Before leaving the vehicle, apply the electric parking brake.</li> </ul>
4matic Currently Unavailable	<p>4MATIC has overheated. The vehicle is only driven by the front wheels.</p> <ul style="list-style-type: none"> <li>► Drive on. The airflow cools 4MATIC more quickly.</li> </ul> <p>When the display message goes out, 4MATIC is available again and the vehicle is driven by all four wheels.</p>
4matic Inoperative	<p>4MATIC is malfunctioning. The vehicle is only driven by the front wheels.</p> <ul style="list-style-type: none"> <li>► Visit a qualified specialist workshop.</li> </ul>
	<p>The tailgate is open.</p> <p><b>⚠ WARNING</b></p> <p>When the engine is running, exhaust gases can enter the vehicle interior if the tailgate is open.</p> <p>There is a risk of poisoning.</p> <ul style="list-style-type: none"> <li>► Close the tailgate.</li> </ul>
	<p>The hood is open.</p> <p>A warning tone also sounds.</p> <p><b>⚠ WARNING</b></p> <p>The open hood may block your view when the vehicle is in motion.</p> <p>There is a risk of an accident.</p> <ul style="list-style-type: none"> <li>► Pull over and stop the vehicle safely as soon as possible, paying attention to road and traffic conditions.</li> <li>► Secure the vehicle against rolling away (▷ page 152).</li> <li>► Close the hood.</li> </ul>
	<p>At least one door is open. A warning tone also sounds.</p> <ul style="list-style-type: none"> <li>► Close all the doors.</li> </ul>

Display messages	Possible causes/consequences and ► Solutions
 <p>Power Steering Malfunction See Operator's Manual</p>	<p>The power steering is malfunctioning. A warning tone also sounds.</p> <p> <b>WARNING</b></p> <p>You will need to use more force to steer. There is a risk of an accident.</p> <ul style="list-style-type: none"> <li>► Check whether you are able to apply the extra force required.</li> <li>► <b>If you are able to steer safely:</b> carefully drive on to a qualified specialist workshop.</li> <li>► <b>If you are unable to steer safely:</b> do not drive on. Contact the nearest qualified specialist workshop.</li> </ul>
 <p>Steering Malfunction See Operator's Manual</p>	<p>The electric steering lock is malfunctioning.</p> <p> <b>WARNING</b></p> <p>The steering may be locked by the electric steering lock. There is a risk of an accident.</p> <ul style="list-style-type: none"> <li>► Pull over and stop the vehicle safely as soon as possible, paying attention to road and traffic conditions.</li> <li>► Secure the vehicle against rolling away (► page 152).</li> <li>► Do not drive on and consult the nearest qualified specialist workshop.</li> </ul>
 <p>Before Starting the Engine, Turn Steering Wheel</p>	<p>The electric steering lock was unable to unlock the steering.</p> <ul style="list-style-type: none"> <li>► Remove the SmartKey from the ignition lock.</li> <li>► To unlock the steering, move the steering wheel slightly.</li> <li>► Insert the SmartKey into the ignition lock again.</li> </ul>
<p>Phone No Service</p>	<p>Your vehicle is outside the network provider's transmitter/receiver range.</p> <ul style="list-style-type: none"> <li>► Wait until the mobile phone operational readiness symbol appears in the multifunction display.</li> </ul>
 <p>Check Washer Fluid</p>	<p>The washer fluid level in the washer fluid reservoir has dropped below the minimum.</p> <ul style="list-style-type: none"> <li>► Add washer fluid (► page 273).</li> </ul>
<p>Wiper Malfunctioning</p>	<p>The windshield wipers are malfunctioning.</p> <ul style="list-style-type: none"> <li>► Visit a qualified specialist workshop.</li> </ul>
<p>Hazard Warning Flashers Malfunctioning</p>	<p>The hazard warning lamps are faulty.</p> <ul style="list-style-type: none"> <li>► Visit a qualified specialist workshop.</li> </ul>

## SmartKey

## Display messages

## Possible causes/consequences and ► Solutions



Key Does Not  
Belong to Vehicle

You have put the wrong SmartKey in the ignition lock.  
► Use the correct SmartKey.



Take Your Key from  
Ignition

The SmartKey is in the ignition lock.  
► Remove the SmartKey.



Obtain a New Key

The SmartKey needs to be replaced.  
► Visit a qualified specialist workshop.



Replace Key Battery

The SmartKey battery is discharged.  
► Change the battery (▷ page 74).



Don't Forget Your  
Key



The display message is shown for a maximum of 60 seconds and is only a reminder.  
You have opened the driver's door with the engine switched off. The SmartKey is not in the ignition lock.  
► Take the SmartKey with you when you leave the vehicle.



Key Not Detected  
(red display message)

The SmartKey is not in the vehicle.  
A warning tone also sounds.  
If the engine is switched off, you can no longer lock the vehicle centrally or start the engine.  
► Pull over and stop the vehicle safely as soon as possible, paying attention to road and traffic conditions.  
► Secure the vehicle against rolling away (▷ page 152).  
► Locate the SmartKey.

Because there is interference from a strong source of radio waves, the key is not detected whilst the engine is running.  
A warning tone also sounds.  
► Pull over and stop the vehicle safely as soon as possible, paying attention to road and traffic conditions.  
► Secure the vehicle against rolling away (▷ page 152).  
► Insert the SmartKey into the ignition lock and bring into key mode.

Display messages	Possible causes/consequences and ► Solutions
 <p>Key Not Detected (white display message)</p>	<p>The SmartKey is currently undetected.</p> <ul style="list-style-type: none"> <li>► Change the location of the SmartKey in the vehicle.</li> </ul> <p>If the SmartKey still cannot be detected:</p> <ul style="list-style-type: none"> <li>► Operate the vehicle with the SmartKey in the ignition lock.</li> </ul>
 <p>Remove 'Start' Button and Insert Key</p>	<p>The SmartKey is continually undetected. KEYLESS-GO is temporarily malfunctioning or is defective. A warning tone also sounds.</p> <ul style="list-style-type: none"> <li>► Insert the SmartKey into the ignition lock and turn it to the desired position.</li> <li>► Visit a qualified specialist workshop.</li> </ul>



## Warning and indicator lamps in the instrument cluster



### General notes

Some systems carry out a self-diagnosis when the ignition is switched on. Therefore, some indicator and warning lamps may light up or flash temporarily. This behavior is non-critical. These indicator and warning lamps only indicate a malfunction if they light up or flash after starting the engine or whilst driving.







### Safety



#### Seat belts

Problem	Possible causes/consequences and ► Solutions
 <p>After starting the engine, the red seat belt warning lamp lights up for 6 seconds.</p>	<p>The seat belt warning lamp reminds the driver and front passenger to fasten their seat belts.</p> <ul style="list-style-type: none"> <li>► Fasten your seat belt (▷ page 42).</li> </ul>
 <p>After starting the engine, the red seat belt warning lamp lights up. In addition, a warning tone sounds for up to 6 seconds.</p>	<p>The driver's seat belt is not fastened.</p> <ul style="list-style-type: none"> <li>► Fasten your seat belt (▷ page 42). The warning tone ceases.</li> </ul>



Problem	Possible causes/consequences and ► Solutions
 <p>The red seat belt warning lamp lights up after the engine starts, as soon as the driver's or the front-passenger door is closed.</p>	<p>The driver or front passenger has not fastened their seat belt.</p> <ul style="list-style-type: none"> <li>► Fasten your seat belt (▷ page 42). The warning lamp goes out.</li> </ul> <p>There are objects on the front-passenger seat.</p> <ul style="list-style-type: none"> <li>► Remove the objects from the front-passenger seat and stow them in a secure place. The warning lamp goes out.</li> </ul>
 <p>The red seat belt warning lamp flashes and an intermittent audible warning sounds.</p>	<p>The driver or front passenger has not fastened their seat belt. The vehicle is being driven faster than 15 mph (25 km/h) or has briefly been driven faster than 15 mph (25 km/h).</p> <ul style="list-style-type: none"> <li>► Fasten your seat belt (▷ page 42). The warning lamp goes out and the intermittent warning tone ceases.</li> </ul> <p>There are objects on the front-passenger seat. The vehicle is being driven faster than 15 mph (25 km/h) or has briefly been driven faster than 15 mph (25 km/h).</p> <ul style="list-style-type: none"> <li>► Remove the objects from the front-passenger seat and stow them in a secure place. The warning lamp goes out and the intermittent warning tone ceases.</li> </ul>









## Safety systems





Problem	Possible causes/consequences and ► Solutions
<p> (USA only)   (Canada only)</p> <p>The red brake system warning lamp comes on while the engine is running. A warning tone also sounds.</p>	<p> <b>WARNING</b></p> <p>The brake boosting effect is malfunctioning and the braking characteristics may be affected.  There is a risk of an accident.</p> <ul style="list-style-type: none"> <li>► Pull over and stop the vehicle safely as soon as possible, paying attention to road and traffic conditions. Do not continue driving under any circumstances.</li> <li>► Secure the vehicle against rolling away (▷ page 152).</li> <li>► Consult a qualified specialist workshop.</li> <li>► Observe the additional display messages in the multifunction display.</li> </ul>
<p> (USA only)   (Canada only)</p> <p>The red brake system warning lamp comes on while the engine is running. A warning tone also sounds.</p>	<p>There is not enough brake fluid in the brake fluid reservoir.</p> <p> <b>WARNING</b></p> <p>The braking effect may be impaired.  There is a risk of an accident.</p> <ul style="list-style-type: none"> <li>► Pull over and stop the vehicle safely as soon as possible, paying attention to road and traffic conditions. Do not continue driving under any circumstances.</li> <li>► Secure the vehicle against rolling away (▷ page 152).</li> <li>► Do not add brake fluid. Adding more will not remedy the malfunction.</li> <li>► Consult a qualified specialist workshop.</li> <li>► Observe the additional display messages in the multifunction display.</li> </ul>



Problem	Possible causes/consequences and ► Solutions
 <p>The yellow ABS warning lamp is lit while the engine is running.</p>	<p>ABS (Anti-lock Braking System) is deactivated due to a malfunction. Therefore, BAS (Brake Assist), COLLISION PREVENTION ASSIST PLUS, ESP® (Electronic Stability Program), the HOLD function and hill start assist are also deactivated, for example. ATTENTION ASSIST is deactivated.</p> <p> <b>WARNING</b></p> <p>The brake system continues to function normally, but without the functions listed above. The wheels could therefore lock if you brake hard, for example.</p> <p>The steerability and braking characteristics may be severely affected. The braking distance in an emergency braking situation can increase.</p> <p>If ESP® is not operational, ESP® is unable to stabilize the vehicle. There is an increased risk of skidding and an accident.</p> <ul style="list-style-type: none"> <li>► Observe the additional display messages in the multifunction display.</li> <li>► Drive on carefully.</li> <li>► Visit a qualified specialist workshop.</li> </ul> <p>If the ABS control unit is faulty, there is also a possibility that other systems, such as the navigation system or the automatic transmission, will not be available.</p>











Problem	Possible causes/consequences and ► Solutions
 <p>The yellow ABS warning lamp is lit while the engine is running.</p>	<p>ABS is temporarily unavailable. Therefore, BAS, COLLISION PREVENTION ASSIST PLUS, ESP<sup>®</sup>, EBD (electronic brake force distribution), the HOLD function and hill start assist are also deactivated, for example.</p> <p>Possible causes are:</p> <ul style="list-style-type: none"> <li>• self-diagnosis is not yet complete.</li> <li>• the on-board voltage may be insufficient.</li> </ul> <p>ATTENTION ASSIST is deactivated.</p> <p> <b>WARNING</b></p> <p>The brake system continues to function normally, but without the functions listed above. The front and rear wheels could therefore lock if you brake hard, for example.</p> <p>The steerability and braking characteristics may be severely affected. The braking distance in an emergency braking situation can increase.</p> <p>If ESP<sup>®</sup> is not operational, ESP<sup>®</sup> is unable to stabilize the vehicle. There is a risk of an accident.</p> <ul style="list-style-type: none"> <li>► Carefully drive a suitable distance, making slight steering movements at a speed above 12 mph (20 km/h). The functions mentioned above are available again when the warning lamp goes out.</li> </ul> <p>If the warning lamp is still on:</p> <ul style="list-style-type: none"> <li>► Observe the additional display messages in the multifunction display.</li> <li>► Drive on carefully.</li> <li>► Visit a qualified specialist workshop.</li> </ul>



Problem	Possible causes/consequences and ► Solutions
 <p>The yellow ABS warning lamp is lit while the engine is running. A warning tone also sounds.</p>	<p>EBD is malfunctioning. Therefore, ABS, BAS, COLLISION PREVENTION ASSIST PLUS, ESP<sup>®</sup>, the HOLD function and hill start assist for example, are also not available. ATTENTION ASSIST is deactivated.</p> <p> <b>WARNING</b></p> <p>The brake system continues to function normally, but without the functions listed above. The front and rear wheels could therefore lock if you brake hard, for example.</p> <p>The steerability and braking characteristics may be severely affected. The braking distance in an emergency braking situation can increase.</p> <p>If ESP<sup>®</sup> is not operational, ESP<sup>®</sup> is unable to stabilize the vehicle. There is an increased risk of skidding and an accident.</p> <ul style="list-style-type: none"> <li>► Observe the additional display messages in the multifunction display.</li> <li>► Drive on carefully.</li> <li>► Visit a qualified specialist workshop.</li> </ul>
<p> (USA only)</p> <p> (Canada only)</p> <p>  </p> <p>The red brake system warning lamp and the yellow ABS, ESP<sup>®</sup> and ESP<sup>®</sup> OFF warning lamps are lit while the drive system is running.</p>	<p>ABS and ESP<sup>®</sup> are malfunctioning. Therefore, BAS, COLLISION PREVENTION ASSIST PLUS, EBD, the HOLD function and hill start assist for example, are also not available. ATTENTION ASSIST is deactivated.</p> <p> <b>WARNING</b></p> <p>The brake system continues to function normally, but without the functions listed above. The front and rear wheels could therefore lock if you brake hard, for example.</p> <p>The steerability and braking characteristics may be severely affected. The braking distance in an emergency braking situation can increase.</p> <p>If ESP<sup>®</sup> is not operational, ESP<sup>®</sup> is unable to stabilize the vehicle. There is an increased risk of skidding and an accident.</p> <ul style="list-style-type: none"> <li>► Observe the additional display messages in the multifunction display.</li> <li>► Drive on carefully.</li> <li>► Visit a qualified specialist workshop.</li> </ul>

Problem	Possible causes/consequences and ► Solutions
 <p>The yellow ESP® warning lamp flashes while the vehicle is in motion.</p>	<p>ESP® or traction control has intervened because there is a risk of skidding or at least one wheel has started to spin. Cruise control or DISTRONIC PLUS is deactivated.</p> <ul style="list-style-type: none"> <li>► When pulling away, only depress the accelerator pedal as far as necessary.</li> <li>► Ease off the accelerator pedal while the vehicle is in motion.</li> <li>► Adapt your driving style to suit the road and weather conditions.</li> <li>► Do not deactivate ESP®.</li> </ul> <p>In rare cases (► page 65), it may be best to deactivate ESP®. Observe the important safety notes on ESP® (► page 64).</p>
 <p>The yellow ESP® OFF warning lamp is lit while the engine is running.</p>	<p>ESP® is deactivated. ESP® will not stabilize the vehicle if it starts to skid or if a wheel starts to spin.</p> <p> <b>WARNING</b></p> <p>If ESP® is switched off, ESP® is unable to stabilize the vehicle. There is an increased risk of skidding and an accident.</p> <ul style="list-style-type: none"> <li>► Reactivate ESP®.</li> </ul> <p>In rare cases (► page 65), it may be best to deactivate ESP®. Observe the important safety notes on ESP® (► page 64).</p> <ul style="list-style-type: none"> <li>► Adapt your driving style to suit the road and weather conditions.</li> </ul> <p>If ESP® cannot be activated:</p> <ul style="list-style-type: none"> <li>► Drive on carefully.</li> <li>► Have ESP® checked at a qualified specialist workshop.</li> </ul>
 <p>The yellow ESP® and ESP® OFF warning lamps are lit while the engine is running.</p>	<p>ESP®, BAS, COLLISION PREVENTION ASSIST PLUS, the HOLD function and hill start assist are not available due to a malfunction. ATTENTION ASSIST is deactivated.</p> <p> <b>WARNING</b></p> <p>The brake system continues to function normally, but without the functions listed above. The braking distance in an emergency braking situation can thus increase.</p> <p>If ESP® is not operational, ESP® is unable to stabilize the vehicle. There is an increased risk of skidding and an accident.</p> <ul style="list-style-type: none"> <li>► Observe the additional display messages in the multifunction display.</li> <li>► Drive on carefully.</li> <li>► Visit a qualified specialist workshop.</li> </ul>

Problem	Possible causes/consequences and ► Solutions
  <p>The yellow ESP<sup>®</sup> and ESP<sup>®</sup> OFF warning lamps are lit while the engine is running.</p>	<p>ESP<sup>®</sup>, BAS, the HOLD function and hill start assist are temporarily unavailable.            COLLISION PREVENTION ASSIST PLUS may also have failed.            ATTENTION ASSIST is deactivated.            Self-diagnosis is not yet complete.</p> <p> <b>WARNING</b></p> <p>The brake system continues to function normally, but without the functions listed above.            The braking distance in an emergency braking situation can thus increase.            If ESP<sup>®</sup> is not operational, ESP<sup>®</sup> is unable to stabilize the vehicle.            There is an increased risk of skidding and an accident.</p> <p>► Carefully drive a suitable distance, making slight steering movements at a speed above 12 mph (20 km/h).            The functions mentioned above are available again when the warning lamp goes out.</p> <p>If the warning lamp is still on:</p> <ul style="list-style-type: none"> <li>► Observe the additional display messages in the multifunction display.</li> <li>► Drive on carefully.</li> <li>► Visit a qualified specialist workshop.</li> </ul>

Problem	Possible causes/consequences and ► Solutions
<p> (USA only)   (Canada only)</p> <p>The red indicator lamp for the electric parking brake flashes or lights up and/or the yellow warning lamp for the electric parking brake lights up.</p>	<p>► Observe the additional display messages in the multifunction display.</p>
<p></p> <p>The red restraint system warning lamp is lit while the engine is running.</p>	<p>The restraint system is faulty.</p> <p> <b>WARNING</b></p> <p>The air bags or Emergency Tensioning Devices may either be triggered unintentionally or, in the event of an accident, may not be triggered.</p> <p>There is an increased risk of injury.</p> <p>► Observe the additional display messages in the multifunction display.</p> <p>► Drive on carefully.</p> <p>► Have the restraint system checked at a qualified specialist workshop immediately.</p> <p>For further information about the restraint system, see (► page 38).</p>

Engine	
Problem	Possible causes/consequences and ► Solutions
 <p>The yellow Check Engine warning lamp lights up while the engine is running.</p>	<p>There may be a malfunction, for example:</p> <ul style="list-style-type: none"> <li>• in the engine management</li> <li>• in the fuel injection system</li> <li>• in the exhaust system</li> <li>• in the ignition system</li> <li>• in the fuel system</li> </ul> <p>The emission limit values may be exceeded and the engine may be in emergency mode.</p> <p>► Have the vehicle checked as soon as possible at a qualified specialist workshop.</p> <p><b>i</b> In some states, you must immediately visit a qualified specialist workshop as soon as the yellow Check Engine warning lamp lights up. This is due to the legal requirements in effect in these states. If in doubt, check whether such legal regulations apply in the state in which you are currently driving.</p>
 <p>The yellow reserve fuel warning lamp lights up while the engine is running.</p>	<p>The fuel level has dropped into the reserve range.</p> <p>► Refuel at the nearest gas station.</p>
 <p>The yellow reserve fuel warning lamp flashes while the vehicle is in motion.</p> <p>In addition, the  Check Engine warning lamp may light up.</p>	<p>The fuel system pressure is too low. The fuel filler cap is not closed correctly or the fuel system is leaking.</p> <p>► Check that the fuel filler cap is correctly closed.</p> <p>► <b>If the fuel filler cap is not correctly closed:</b> close the fuel filler cap.</p> <p>► <b>If the fuel filler cap is closed:</b> visit a qualified specialist workshop.</p>
 <p>The red coolant warning lamp lights up while the engine is running and the coolant temperature gauge is at the start of the scale.</p>	<p>The temperature sensor for the coolant temperature gauge is defective.</p> <p>The coolant temperature is no longer being monitored. There is a risk of engine damage if the coolant temperature is too high.</p> <p>► Pull over and stop the vehicle safely and switch off the engine, paying attention to road and traffic conditions. Do not continue driving under any circumstances.</p> <p>► Secure the vehicle against rolling away (► page 152).</p> <p>► Consult a qualified specialist workshop.</p>

Problem	Possible causes/consequences and ► Solutions
 <p>The red coolant warning lamp comes on while the engine is running.</p>	<p>The coolant level is too low.</p> <p>If the coolant level is correct, the airflow to the engine radiator may be blocked or the electric engine radiator fan may be malfunctioning.</p> <p>The coolant is too hot and the engine is no longer being cooled sufficiently.</p> <ul style="list-style-type: none"> <li>► Observe the additional display messages in the multifunction display.</li> <li>► Pull over and stop the vehicle safely and switch off the engine, paying attention to road and traffic conditions.</li> <li>► Secure the vehicle against rolling away (► page 152).</li> <li>► Leave the vehicle and keep a safe distance from the vehicle until the engine has cooled down.</li> <li>► Check the coolant level and add coolant, observing the warning notes (► page 273).</li> <li>► If you need to add coolant more often than usual, have the engine coolant system checked.</li> <li>► Make sure that the air supply to the engine radiator is not blocked, e.g. by snow, slush or ice.</li> <li>► Do not start the engine again until the coolant temperature is below 248 °F (120 °C). Otherwise, the engine could be damaged.</li> <li>► Drive to the nearest qualified specialist workshop.</li> <li>► Avoid subjecting the engine to heavy loads, e.g. driving in mountainous terrain, and stop-and-go traffic.</li> </ul>
 <p>The red coolant warning lamp comes on while the engine is running. A warning tone also sounds.</p>	<p>The coolant temperature has exceeded 248 °F (120 °C). The airflow to the engine radiator may be blocked or the coolant level may be too low.</p> <p> <b>WARNING</b></p> <p>The engine is not being cooled sufficiently and may be damaged. Do not drive when your engine is overheated. This can cause some fluids which may have leaked into the engine compartment to catch fire.</p> <p>Steam from the overheated engine can also cause serious burns which can occur just by opening the hood.</p> <p>There is a risk of injury.</p> <ul style="list-style-type: none"> <li>► Observe the additional display messages in the multifunction display.</li> <li>► Pull over and stop the vehicle safely and switch off the engine, paying attention to road and traffic conditions.</li> <li>► Secure the vehicle against rolling away (► page 152).</li> </ul>

Problem	Possible causes/consequences and ► Solutions
	<ul style="list-style-type: none"> <li>▶ Leave the vehicle and keep a safe distance from the vehicle until the engine has cooled down.</li> <li>▶ Check the coolant level and add coolant, observing the warning notes (► page 273).</li> <li>▶ If you need to add coolant more often than usual, have the engine coolant system checked.</li> <li>▶ Make sure that the air supply to the engine radiator is not blocked, e.g. by snow, slush or ice.</li> <li>▶ At coolant temperatures below 248 °F (120 °C), drive to the nearest qualified specialist workshop.</li> <li>▶ Avoid subjecting the engine to heavy loads, e.g. driving in mountainous terrain, and stop-and-go traffic.</li> </ul>

### Driving systems

Problem	Possible causes/consequences and ► Solutions
 <p>The red distance warning lamp lights up while the vehicle is in motion. A warning tone also sounds.</p>	<p>You are approaching a vehicle or a stationary obstacle in your line of travel at too high a speed.</p> <ul style="list-style-type: none"> <li>▶ Be prepared to brake immediately.</li> <li>▶ Pay careful attention to the traffic situation. You may have to brake or take evasive action.</li> </ul> <p>For further information about the distance warning function of COLLISION PREVENTION ASSIST PLUS, see (► page 62).</p>



Useful information .....	248
Loading guidelines .....	248
Stowage areas .....	249
Features .....	259

### Useful information

- i** This Operator's Manual describes all models and all standard and optional equipment of your vehicle available at the time of publication of the Operator's Manual. Country-specific differences are possible. Please note that your vehicle may not be equipped with all features described. This also applies to safety-related systems and functions.
- i** Read the information on qualified specialist workshops (▷ page 24).

### Loading guidelines

#### WARNING

If objects, luggage or loads are not secured or not secured sufficiently, they could slip, tip over or be flung around and thereby hit vehicle occupants. There is a risk of injury, particularly in the event of sudden braking or a sudden change in direction.

Always store objects so that they cannot be flung around. Secure objects, luggage or loads against slipping or tipping before the journey.

#### WARNING

Combustion engines emit poisonous exhaust gases such as carbon monoxide. If the tailgate is open when the engine is running, particularly if the vehicle is moving, exhaust fumes could enter the passenger compartment. There is a risk of poisoning.

Turn off the engine before opening the tailgate. Never drive with the tailgate open.

#### WARNING

The exhaust tail pipe and tail pipe trim can become very hot. If you come into contact with these parts of the vehicle, you could burn yourself. There is a risk of injury.

Always be particularly careful around the exhaust tail pipe and the tail pipe trim. Allow

these components to cool down before touching them.

The handling characteristics of a laden vehicle are dependent on the distribution of the load within the vehicle. For this reason, you should observe the following notes when transporting a load:

- Never exceed the maximum permissible gross vehicle mass or the gross axle weight rating for the vehicle (including occupants). The values are specified on the vehicle identification plate on the B-pillar of the driver's door.
- The cargo compartment is the preferred place to carry objects.
- Position heavy loads as far forwards as possible and as low down in the cargo compartment as possible.
- The load must not protrude above the upper edge of the seat backrests.
- Always place the load against the rear or front seat backrests. Make sure that the seat backrests are securely locked into place.
- Always place the load behind unoccupied seats if possible.
- Use the cargo tie-down rings and the parcel nets to transport loads and luggage.
- Use cargo tie-down rings and fastening materials appropriate for the weight and size of the load.
- Hook in the cargo net when loading.
- The maximum load capacity of the stowage well under the cargo compartment floor is 55 lbs (25 kg).
- Secure the load with sufficiently strong and wear-resistant tie-downs. Pad sharp edges for protection.

- !** Do not position the load on one part of the folding cargo compartment floor only. The maximum load capacity of the folding cargo compartment floor is 220 lbs (100 kg). Distribute the weight evenly to avoid damaging the cargo compartment floor. Place a solid

board under the load if necessary. Please note that the load on the cargo compartment floor will be increased when the load is lashed down.

## Stowage areas

### Stowage spaces

#### Important safety notes

##### WARNING

If objects in the passenger compartment are stowed incorrectly, they can slide or be thrown around and hit vehicle occupants. There is a risk of injury, particularly in the event of sudden braking or a sudden change in direction.

- Always stow objects so that they cannot be thrown around in such situations.
- Always make sure that objects do not protrude from stowage spaces, parcel nets or stowage nets.
- Close the lockable stowage spaces while driving.
- Stow and secure objects that are heavy, hard, pointy, sharp-edged, fragile or too large in the cargo compartment.

Observe the loading guidelines (▷ page 248).

#### Stowage compartments in the front

##### Glove box



► **To open:** pull handle ① and open glove box flap ②.

► **To close:** fold glove box flap ② upwards until it engages.

There is a pen holder at the top of the glove box flap.

##### Eyeglasses compartment

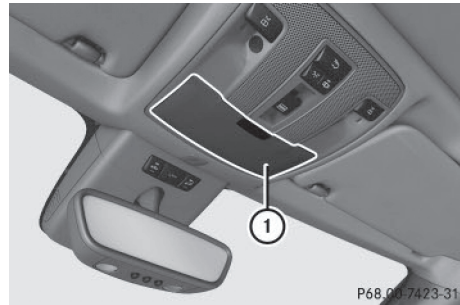

► **To open:** press marking ①.

Make sure that the eyeglasses compartment is always closed while the vehicle is in motion.

##### Stowage compartment in the front center console



► **To open:** press the marking on cover ①.

**i** Depending on the vehicle equipment, there may be an ashtray in the center console instead of a storage compartment.

### Stowage compartment in front of the armrest (vehicles with automatic transmission)



► **To open:** press the marking on cover ①.

❗ You can remove the non-slip mat and the insert for cleaning. When removing the insert you will have to overcome some slight resistance.

### Stowage compartment under the armrest

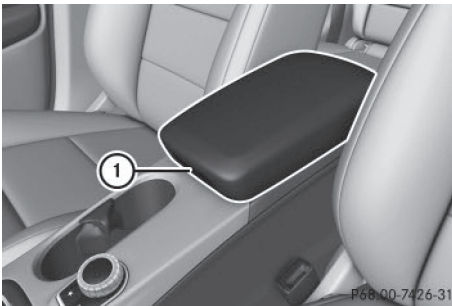

► **To open:** on vehicles with movable armrests, make sure that the armrest is in the rearmost position.

► Press button ① and fold the armrest up.

Depending on the vehicle equipment, the armrest can be moved backwards or forwards in a longitudinal direction.

Depending on the vehicle's equipment, the following may be in the stowage compartment: a multimedia connector unit with an SD card slot and 2 USB ports, e.g. for use with an iPod®, iPhone® or MP3 player; see the separate operating instructions.

### Stowage compartment under the driver's seat and front-passenger seat

#### ⚠ WARNING

If you exceed the maximum load for the stowage compartment, the cover may not be able to restrain the items. Items may be thrown out of the stowage compartment and hit vehicle occupants. There is a risk of injury, particularly in the event of sudden braking or a sudden change in direction.

Never exceed the maximum permissible load for the stowage compartment. Stow and secure heavy objects in the cargo compartment.

The maximum permissible load of the stowage compartment is 2.6 lbs (1.5 kg).

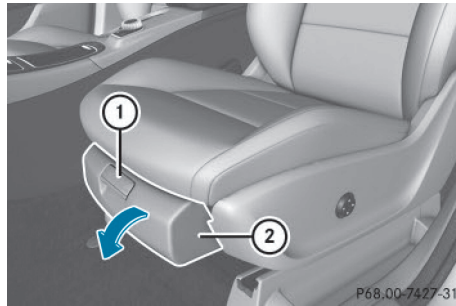

► **To open:** pull handle ① up and fold cover ② forwards.

### Stowage space in the rear

#### Stowage compartment in the rear center console

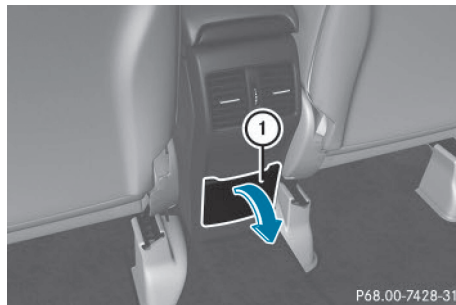

- ▶ **To open:** pull down the top of stowage compartment ① by the edge of the handle.

**i** Depending on the vehicle's equipment, there may be an open stowage space above the stowage compartment.

### Folding table

#### **⚠ WARNING**

If the folding table is folded out while the vehicle is in motion, passengers can be thrown against it, particularly in the event of an accident, heavy braking or a sudden change of direction. There is a risk of injury.

Fold the folding table away before each journey.

- !** Do not load the folding table with more than the maximum permissible load of 4.4 lbs (2 kg).



- ▶ **To fold out:** pull folding table ① up in the direction of the arrow to the desired position.
- ▶ **To fold away:** push folding table ① down onto the backrest.

### Parcel nets

Parcel nets are located:

- in the front-passenger footwell
- on the back of the driver's and the front-passenger seat

Observe the loading guidelines (▷ page 248) and the safety notes regarding stowage spaces (▷ page 249).

### Folding backrest on the front-passenger seat

#### **⚠ WARNING**

If the backrest of the front-passenger seat is folded forward, rear seat passengers can come in contact with parts of the seat mechanism, particularly in the event of an accident, heavy braking or a sudden change of direction. There is a risk of injury.

If a passenger travels in the vehicle while the front-passenger seat is folded forward, they must sit in the rear seat behind the driver.

The backrest of the front-passenger seat can be folded forwards to increase the cargo compartment capacity.

Once you no longer need the backrest on the front-passenger side to be used as a load surface, fold the backrest back into place.

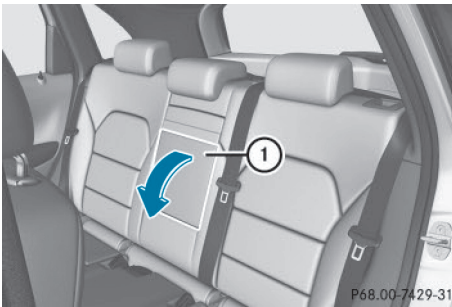

- ▶ **To fold forward:** gently push the backrest back.
- ▶ Pull release handle ① and fold the backrest fully onto the seat cushion until it engages.
- ▶ **To fold back:** gently push the backrest down and pull release handle ①.
- ▶ Fold the seat backrest back until it engages.

**Through-loading facility in the rear**

- ▶ **To open:** fold down seat armrest (1).
- ▶ Pull the center head restraint on the rear bench seat into the uppermost position (▷ page 94).

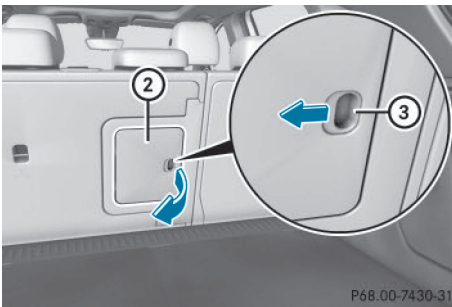

- ▶ Slide locking mechanism (3) in the direction of the arrow.
  - ▶ Swing flap (2) fully to the side. Flap (2) is held open by a magnet.
  - ▶ **To close:** swing flap (2) in the cargo compartment back until it engages.
  - ▶ Fold armrest (1) up fully if necessary.
- Observe the loading guidelines (▷ page 248).

**Cargo compartment enlargement****Important safety notes****⚠ WARNING**

If the rear bench seat/rear seat and seat backrest are not engaged they could fold for-

wards, e.g. when braking suddenly or in the event of an accident.

- The vehicle occupant would thereby be pushed into the seat belt by the rear bench seat/rear seat or by the seat backrest. The seat belt can no longer offer the intended level of protection and could even cause injuries.
- Objects or loads in the trunk/cargo compartment cannot be restrained by the seat backrest.

There is an increased risk of injury.

Before every trip, make sure that the seat backrests and the rear bench seat/rear seat are engaged.

- ⚠ Before folding the backrest in the rear compartment forwards, make sure that the rear compartment armrest and the cupholder are folded in. They may otherwise be damaged.

Observe the loading guidelines (▷ page 248). The left-hand and right-hand rear seat backrests can be folded forwards separately to increase the cargo compartment capacity.

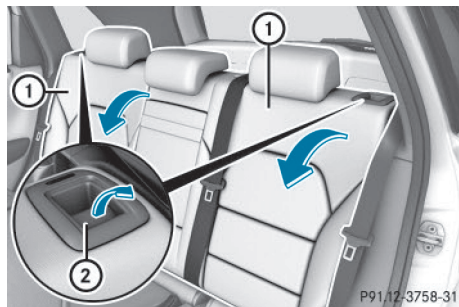
**Vehicles without the EASY-VARIO-PLUS system****Folding the rear seat backrests forward**

- ▶ Fully insert the backrest head restraints (▷ page 95).
- ▶ Move the driver's or front-passenger seat forward if necessary.

- ▶ Pull left-hand or right-hand release handle ② of the seat backrest forwards. Corresponding seat backrest ① is released.
- ▶ Fold backrest ① forwards.
- ▶ Move the driver's or front-passenger seat back if necessary.

### Folding the rear seat backrest back

**!** Make sure that the seat belt does not become trapped when folding the rear seat backrest back. Otherwise, it could be damaged.

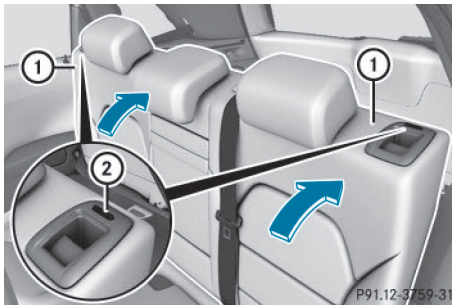

- ▶ Move the driver's or front-passenger seat forward if necessary.
- ▶ Fold seat backrest ① back until it engages. Red lock status indicator ② is no longer visible.
- ▶ Adjust the head restraints if necessary (> page 95).
- ▶ Move the driver's or front-passenger seat back if necessary.

### Vehicles with the EASY-VARIO-PLUS system

#### Folding the rear seat backrests forward

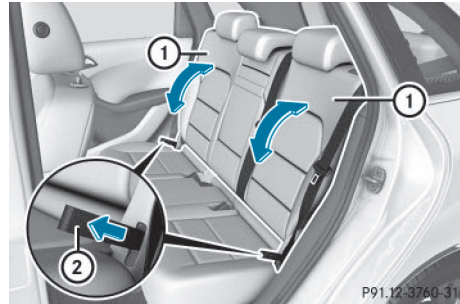

- ▶ Fully insert the backrest head restraints (> page 95).
- ▶ Move the rear seat as far back as possible (> page 254).
- ▶ Move the driver's or front-passenger seat forward if necessary.
- ▶ Pull right or left loop ② on the backrest in the direction of the arrow. Corresponding seat backrest ① is released.
- ▶ Fold down backrest ① fully.
- ▶ Move the driver's or front-passenger seat back if necessary.

#### Folding the rear seat backrest back

**!** Make sure that the seat belt does not become trapped when folding the rear seat backrest back. Otherwise, it could be damaged.

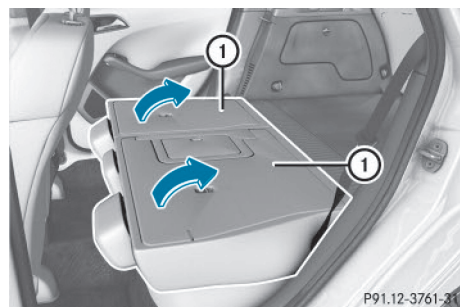

- ▶ Move the driver's or front-passenger seat forward if necessary.
- ▶ Swing backrest ① back.
- ▶ Adjust the backrest to the desired angle by pulling the loop (▷ page 254).
- ▶ Adjust the head restraints if necessary (▷ page 95).
- ▶ Move the driver's or front-passenger seat back if necessary.

#### Notes on using the cargo compartment

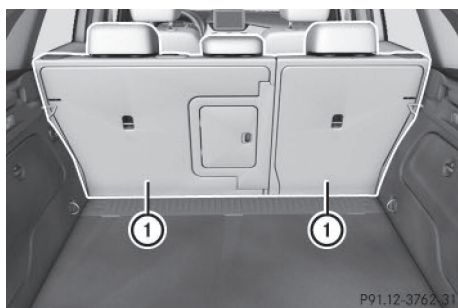

Making the best use of your cargo compartment:

- ▶ Set seat backrest ① to the load position (90° position) (▷ page 254). The load capacity is increased.
- ▶ Vehicles with a height-adjustable cargo compartment floor: move the cargo compartment floor to the upper position (▷ page 258). The load surface becomes flat.
- ▶ Move the rear bench seat as far forwards as possible (▷ page 254). The load area is increased.
- ▶ Fold the folding backrest on the front-passenger seat (▷ page 251) and the corresponding backrest in the rear forwards. The load area is lengthened.

#### Adjusting the angle of the rear seat backrests



You can set the angle of the seat backrests to one of 13 detent positions.

- ▶ Pull right or left release loop ② forwards in the direction of the arrow. Corresponding seat backrest ① is released.
- ▶ Pull backrest ① forward in the direction of the arrow, or push it back and let it engage.
- ▶ To ensure that the backrest has engaged, lean firmly against backrest ①.

The angle and fore/aft position of the left and right rear seats can be separately adjusted for each seat in order to make better use of the cargo compartment.

Depending on the angle of the backrest, therefore, the right and left rear seats can be pushed back varying distances until the backrest is resting against the cargo compartment cover.

If the backrest comes into contact with surrounding parts of the cargo compartment paneling, reduce the angle of the backrest.

#### Adjusting the seat fore-and-aft position

- ⚠ When moving the rear seats back, make sure there are no objects in the footwell or behind the seats. The rear seats and/or the objects could otherwise be damaged.



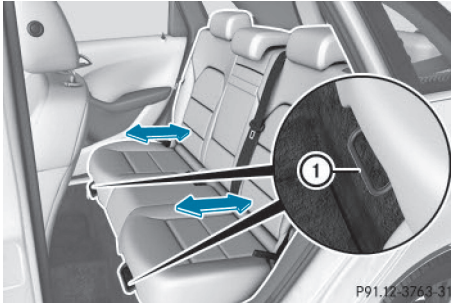

- ▶ Lift the left or right release handle and slide the corresponding seat forwards or backwards.
- ▶ Let go of the release handle again. Make sure that you hear the seat engage in position.

### Securing cargo

#### Cargo tie-down rings

##### General notes

Observe the following notes on securing loads:

- Observe the loading guidelines (> page 248).
- Secure the load using the cargo tie-down rings.
- Distribute the load on the cargo tie-down rings evenly.
- Do not use elastic straps or nets to secure a load, as these are only intended as an anti-slip protection for light loads.
- Do not route tie-downs across sharp edges or corners.
- Pad sharp edges for protection.

#### Cargo compartment

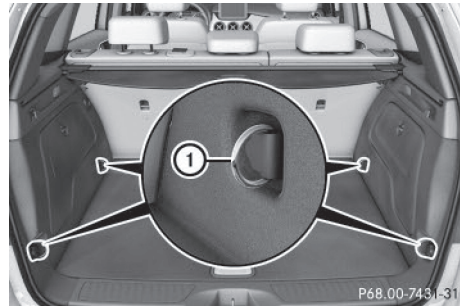

① Cargo tie-down rings

#### Bag hook

##### ⚠ WARNING

The bag hooks cannot restrain heavy objects or items of luggage. Objects or items of luggage could be flung around and thereby hit vehicle occupants when braking or abruptly changing directions. There is a risk of injury. Only hang light objects on the bag hooks. Never hang hard, sharp-edged or fragile objects on the bag hooks.

- ❗ The bag hook can bear a maximum load of 6.6lbs (3kg) and should not be used to secure a load.



① Bag hook

### Cargo compartment cover

#### Important safety notes

#### WARNING

On its own, the cargo compartment cover cannot secure or restrain heavy objects, items of luggage and heavy loads. You could be hit by an unsecured load during sudden changes in direction, braking or in the event of an accident. There is an increased risk of injury or even fatal injury.

Always store objects so that they cannot be flung around. Secure objects, luggage or loads against slipping or tipping over, e.g. by using tie downs, even if you are using the cargo compartment cover.

**!** When loading the vehicle, make sure that you do not stack the load in the cargo compartment higher than the lower edge of the side windows. Do not place heavy objects on top of the cargo compartment cover.

**!** When removing and installing the cargo compartment cover, ensure that its end caps do not scrape the light-colored parts of the vehicle.

The cargo compartment cover is located behind the rear bench seat backrest.

#### Extending/retracting the cargo compartment cover

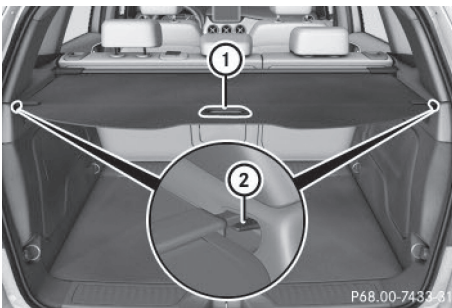

- ▶ **To extend:** pull the cargo compartment cover back by grab handle ① and clip it into retainers ② on the left and right.
- ▶ **To retract:** unhook the cargo compartment cover from retainers ② on the left and right and guide it forwards by grab handle ① until it is fully retracted.

#### Installing/removing the cargo compartment cover

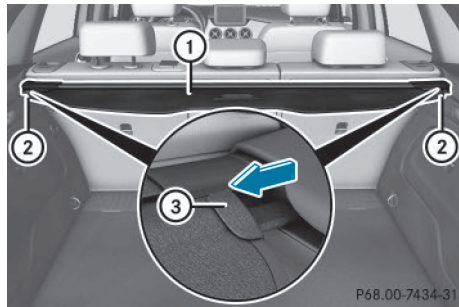

- ▶ **To remove:** make sure that the cargo compartment cover is rolled up.
- ▶ Push in the end cap of cargo compartment cover ① in the direction of the arrow on the right or left side using grip ③.
- ▶ Push cargo compartment cover ① into opposite anchorage ②.
- ▶ Remove cargo compartment cover ① upwards.
- ▶ **To install:** set cargo compartment cover ① on the right or left-hand side in anchorage ②.
- ▶ Push in the opposite end cap of cargo compartment cover ① and insert cargo compartment cover ① into opposite anchorage ②.

### Cargo net

#### Important safety notes

#### WARNING

On its own, the cargo net cannot secure or restrain heavy objects, items of luggage and

heavy loads. You could be hit by an unsecured load during sudden changes in direction, braking or in the event of an accident. There is an increased risk of injury or even fatal injury. Always store objects so that they cannot be flung around. Secure objects, luggage or loads against slipping or tipping over, e.g. by using tie downs, even if you are using the cargo net.

It is important to use a cargo net if you load the vehicle with small objects above the seat backrests. For safety reasons, always use a cargo net when transporting loads.

Damaged cargo nets can no longer fulfill their protective function and must be replaced. Visit a qualified specialist workshop.

### Attaching and tightening the cargo net

You have two options for hooking in the cargo net:

- with cargo compartment enlargement: the brackets are behind the B-pillar and the cargo tie-down rings to tension the net are on the sides of the rear-compartment foot-well.
- without cargo compartment enlargement: the brackets are behind the C-pillar and the cargo tie-down rings to tension the net are in the cargo compartment (▷ page 255).

The cargo net is located in the stowage space under the cargo compartment floor (▷ page 257).

- ▶ Open both Velcro fasteners and remove the cargo net.
- ▶ Unroll and unfold the cargo net. The joints on the upper and lower guide rod should engage audibly.

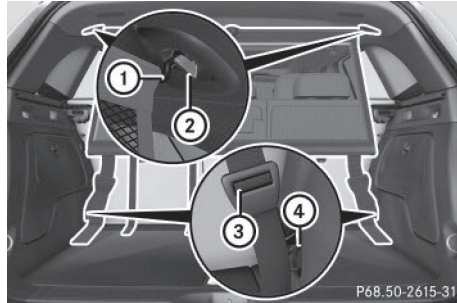

Example cargo net installed behind the C-pillar (without cargo compartment enlargement)

- ▶ **To attach and tighten:** insert guide rod ① into bracket ②.
- ▶ Attach belt hook ④ to the cargo tie-down ring and pull down on the loose end of the lashing strap until the cargo net is taut.
- ▶ After driving a short distance, check the tension of the cargo net and retighten it if necessary.
- ▶ **To loosen and detach:** pull belt clamp ③ up to reduce the tension in the lashing strap.
- ▶ Unhook belt hook ④ from the cargo tie-down ring.
- ▶ Detach guide rod ① from bracket ②.
- ▶ **To stow:** press the red button on the upper and lower guide rod.
- ▶ Fold the cargo net and roll it up.
- ▶ Close the two Velcro fasteners on the cargo net holder.

### Stowage well under the cargo compartment floor

#### Important safety notes

##### WARNING

If you drive when the cargo compartment floor is open, objects could be flung around, thus striking vehicle occupants. There is a risk of injury, particularly in the event of sudden braking or a sudden change in direction.

Always close the cargo compartment floor before a journey.

**!** The maximum load capacity of the stowage well under the cargo compartment floor is 55 lbs (25 kg).

There is a stowage area for TIREFIT, the vehicle tool kit, a folding box, etc. underneath the cargo compartment floor.

### Opening/closing the cargo compartment floor

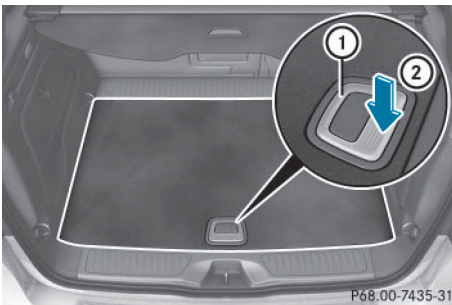

- ▶ **To open:** open the tailgate.
- ▶ Holding ribbing ②, press handle ① downwards. Handle ① folds up.
- ▶ Swing the cargo compartment floor upwards using handle ① until it rests against the cargo compartment cover.

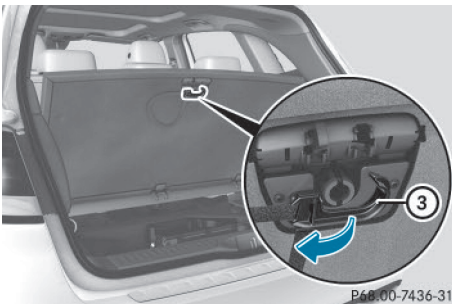

- ▶ Fold out hook ③ on the underside of the cargo compartment floor.



- ▶ Attach hook ③ to the cargo compartment's upper seal ④.
- ▶ **To close:** detach hook ③ from upper seal ④.
- ▶ Fasten hook ③ to the bracket on the underside of the cargo compartment floor.
- ▶ Fold the cargo compartment floor down.
- ▶ Press the cargo compartment floor down until it engages.

### Setting the height of the cargo compartment floor

The stowage well under the cargo compartment floor can be increased or decreased in size as necessary. To do this, you can lock the floor at two different heights. The upper catch gives a flat load surface when the rear bench seat is folded forward.

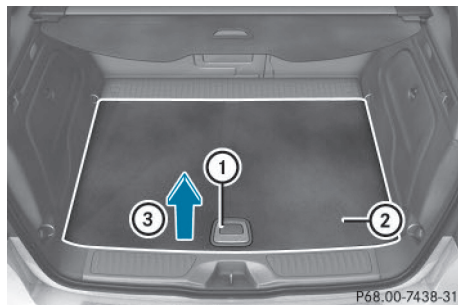

- ▶ **To raise:** using handle ①, lift up cargo compartment floor ② in the direction of arrow ③ and pull it upwards.
- ▶ Lower cargo compartment floor ② again. To do this, push the cargo compartment

floor away so that it engages in the guide on the upper level.

Cargo compartment floor ② engages in the upper position.

**i** Carry out this step using both hands.

- ▶ **To lower:** raise cargo compartment floor ② slightly using handle ① and pull it towards you.
- ▶ Lower cargo compartment floor ② again slowly. Whilst doing so, press the cargo compartment floor into the lower level. Cargo compartment floor ② engages in the lower position.

### Roof carrier

#### Important safety notes

##### **⚠ WARNING**

When you load the roof, the center of gravity of the vehicle rises and the driving characteristics change. If you exceed the maximum roof load, the driving characteristics, as well as steering and braking, will be greatly impaired. There is a risk of an accident.

Never exceed the maximum roof load and adjust your driving style.

- !** Mercedes-Benz recommends that you only use roof carriers that have been tested and approved for Mercedes-Benz vehicles. This helps to prevent damage to the vehicle.

Position the load on the roof rack in such a way that the vehicle will not sustain damage even when it is in motion.

Ensure that, depending on the vehicle's equipment, you can raise the panorama roof with power tilt/sliding panel fully and open the tailgate fully when the roof carrier is installed.

You will find information on the maximum roof load in the "Technical data" section (▷ page 341).

An incorrectly secured roof carrier or roof load may become detached from the vehicle. You must therefore ensure that you observe the roof carrier manufacturer's installation instructions.

#### Attaching the roof carrier

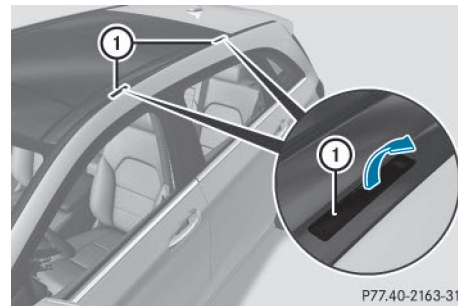

- ▶ Open covers ① carefully in the direction of the arrow.
- ▶ Fold covers ① upwards.
- ▶ Only secure the roof carrier to the anchorage points under covers ①.
- ▶ Observe the manufacturer's installation instructions.

### Features

#### Cup holder

#### Important safety notes

##### **⚠ WARNING**

The cup holder cannot hold a container secure whilst traveling. If you use a cup holder whilst traveling, the container may be flung around and liquid may be spilled. The vehicle occupants may come into contact with the liquid and if it is hot, they may be scalded. You may be distracted from the traffic conditions and you could lose control of the vehicle. There is a risk of an accident and injury.

Only use the cup holder when the vehicle is stationary. Only use the cup holder for con-

tainers of the right size. Always close the container, particularly if the liquid is hot.

#### **WARNING**

If objects in the passenger compartment are stowed incorrectly, they can slide or be thrown around and hit vehicle occupants. There is a risk of injury, particularly in the event of sudden braking or a sudden change in direction.

- Always stow objects so that they cannot be thrown around in such situations.
- Always make sure that objects do not protrude from stowage spaces, parcel nets or stowage nets.
- Close the lockable stowage spaces while driving.
- Stow and secure objects that are heavy, hard, pointy, sharp-edged, fragile or too large in the cargo compartment.

**!** Only use the cup holders for containers of the right size and which have lids. The drinks could otherwise spill.

Observe the loading guidelines (▷ page 248). The stowage compartments in the doors provide space for bottles:

- front: capacity up to 51 fl. oz. (1.5 l)
- rear: capacity up to 17 fl. oz. (0.5 l)

#### **Cup holder in the front-compartment center console**



The cup holder and the rubber mat underneath can be removed for cleaning. Clean them with clean, lukewarm water only.

- ▶ **To remove:** carefully pull in upper sections of cup holder ① on the driver's and front-passenger sides until they release.
- ▶ Lift the cup holder upwards ② until it can be removed.

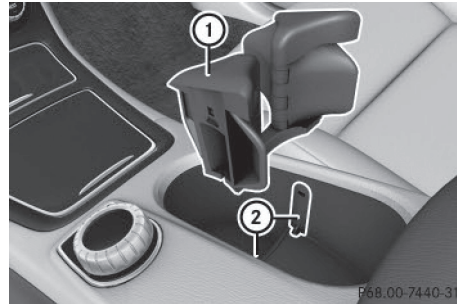

- ▶ **To install:** insert cup holder into lateral curved sections ② in the stowage compartment. Insert the cup holder so that the wedge of the upper section of cup holder ① faces forwards.
- ▶ Press the cup holder downwards until it engages on the right and left-hand sides.

#### **Cup holder in the rear seat armrest**

- !** Do not sit on or support your body weight on the rear seat armrest when it is folded down, as you could otherwise damage it.
- !** Close the cup holder before folding the rear seat armrest up. Otherwise, the cup holder could be damaged.

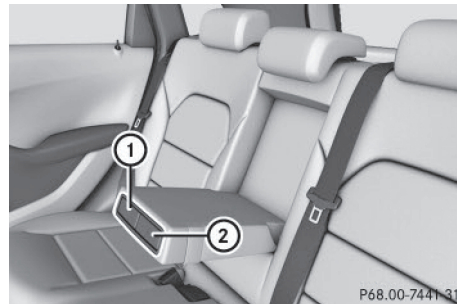

- ▶ Fold down the rear seat armrest.
- ▶ **To open:** press the front of cup holder ① or ②. Cup holder ① or ② extends automatically.
- ▶ **To close:** slide cup holder ① or ② back until it engages.

### Sun visors

#### Overview

#### WARNING

If the mirror cover of the vanity mirror is folded up when the vehicle is in motion, you could be blinded by incident light. There is a risk of an accident.

Always keep the mirror cover folded down while driving.

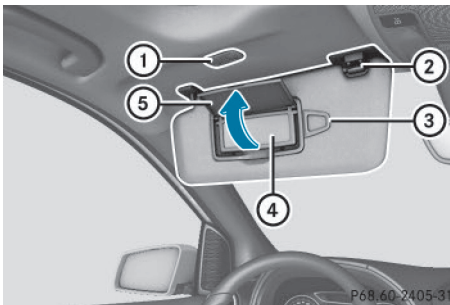

- ① Mirror light
- ② Bracket
- ③ Retaining clip, e.g. for a car park ticket
- ④ Vanity mirror
- ⑤ Mirror cover

#### Vanity mirror in the sun visor

Mirror light ① only functions if the sun visor is clipped into bracket ② and mirror cover ⑤ has been folded up.

### Glare from the side

- ▶ Fold down the sun visor.
- ▶ Pull the sun visor out of retainer ②.
- ▶ Swing the sun visor to the side.

### Ashtray

#### Front ashtray

**!** The stowage space under the ashtray is not heat resistant. Before placing lit cigarettes in the ashtray, make sure that the ashtray is properly engaged. Otherwise, the stowage space could be damaged.

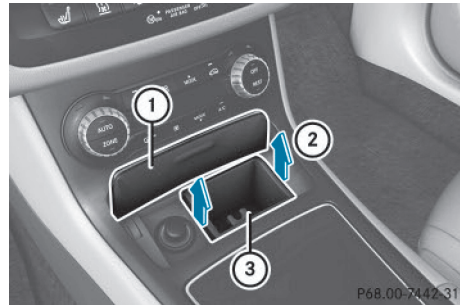

- ▶ **Vehicles with a stowage compartment cover:** press the lower section of cover ①. The stowage compartment opens.
- ▶ **To remove the insert:** lift insert ③ up ② and out.
- ▶ **To re-install the insert:** press insert ③ into the holder until it engages.

**i** If you remove the ashtray insert, you can use the resulting compartment for stowage.

### Rear-compartment ashtray

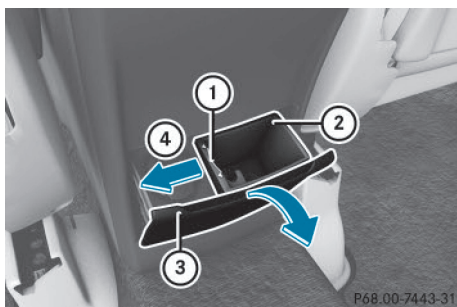

- ▶ **To open:** pull cover ③ out by its top edge.
- ▶ **To remove:** pull insert ② by recess ① in the direction of arrow ④ until it audibly releases.
- ▶ Lift insert ② up and out.
- ▶ **To install the insert:** install insert ② from above into the holder and press down until it engages.

### Cigarette lighter

#### WARNING

You can burn yourself if you touch the hot heating element or the socket of the cigarette lighter.

In addition, flammable materials can ignite if:

- the hot cigarette lighter falls
- a child holds the hot cigarette lighter to objects, for example

There is a risk of fire and injury.

Always hold the cigarette lighter by the knob. Always make sure that the cigarette lighter is out of reach of children. Never leave children unsupervised in the vehicle.

Your attention must always be focused on the traffic conditions. Only use the cigarette lighter when road and traffic conditions permit.

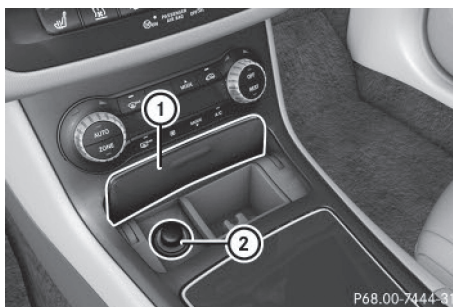

- ▶ Turn the SmartKey to position 2 in the ignition lock (▷ page 135).
- ▶ **Vehicles with a stowage compartment cover:** press the lower section of cover ①. The stowage compartment opens.
- ▶ Press in cigarette lighter ②. Cigarette lighter ② will pop out automatically when the heating element is red-hot.

### 12 V sockets

#### General notes

- ▶ Turn the SmartKey to position 1 in the ignition lock (▷ page 135).

The sockets can be used for accessories with a maximum draw of 180 W (15 A). Accessories include such items as chargers for mobile phones.

If you use the sockets for long periods when the engine is switched off, the battery may discharge.

An emergency cut-out ensures that the on-board voltage does not drop too low. If the on-board voltage is too low, the power to the sockets is automatically cut. This ensures that there is sufficient power to start the engine.



### Socket in the front-compartment center console



- ▶ **Vehicles with a stowage compartment cover:** press the lower section of cover ①. The stowage compartment opens.
- ▶ Lift up the cover of socket ②.

### Socket in the rear-compartment center console

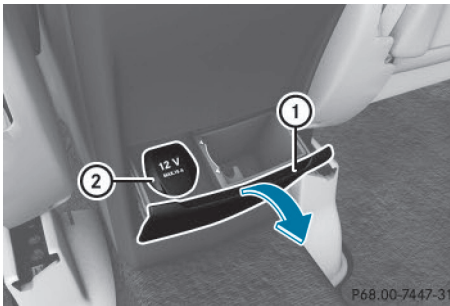

- ▶ Pull cover ① out by its top edge.
- ▶ Lift up the cover of socket ②.

### Socket in the cargo compartment



- ▶ Lift up the cover of socket ①.

### Garage door opener

#### General notes

The HomeLink® garage door opener integrated in the rear-view mirror allows you to operate up to three different door and gate systems.

Use the integrated garage door opener only on garage doors that:

- have safety stop and reverse features and
- meet current U.S. federal safety standards

Once programmed, the integrated garage door opener in the rear-view mirror will assume the function of the garage door system's remote control. Please also read the operating instructions for the garage door system.

When programming a garage door opener, park the vehicle outside the garage. Do not run the engine while programming.

Certain garage door drives are incompatible with the integrated garage door opener. If you have difficulty programming the integrated garage door opener, contact an authorized Mercedes-Benz Center.

Alternatively, you can call the following telephone assistance services:

- **USA:** Mercedes-Benz Customer Assistance Center at 1-800-FOR-MERCEDES
- **Canada:** Customer Service at 1-800-387-0100
- HomeLink® hotline 1-800-355-3515 (free of charge)

More information on HomeLink® and/or compatible products is also available online at <http://www.homelink.com>.

Notes on the declaration of conformity (▷ page 23).

USA: FCC ID: CB2HMIHL4

Canada: IC: 279B-HMIHL4

### Important safety notes

#### WARNING

When you operate or program the garage door with the integrated garage door opener, persons in the range of movement of the garage door can become trapped or struck by the garage door. There is a risk of injury.

When using the integrated garage door opener, always make sure that nobody is within the range of movement of the garage door.

#### WARNING

Combustion engines emit poisonous exhaust gases such as carbon monoxide. Inhaling these exhaust gases leads to poisoning. There is a risk of fatal injury. Therefore never leave the engine running in enclosed spaces without sufficient ventilation.

### Programming

#### Programming buttons

Pay attention to the "Important safety notes" (▷ page 264).

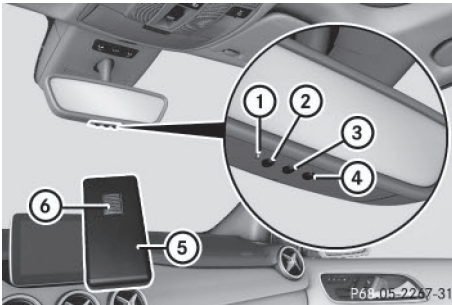

Garage door remote control (5) is not included with the integrated garage door opener.

- ▶ Turn the SmartKey to position 2 in the ignition lock (▷ page 135).
- ▶ Select one of buttons (2) to (4) to use to control the garage door drive.

- ▶ **To start programming mode:** press and hold one of buttons (2) to (4) on the integrated garage door opener.

The garage door opener is now in programming mode. After a short time, indicator lamp (1) lights up yellow.

Indicator lamp (1) lights up yellow as soon as button (2), (3) or (4) is programmed for the first time. If the selected button has already been programmed, indicator lamp (1) will only light up yellow after ten seconds have elapsed.

- ▶ Release button (2), (3) or (4). Indicator lamp (1) flashes yellow.
- ▶ **To program the remote control:** point garage door remote control (5) towards buttons (2) to (4) on the rear-view mirror at a distance of 2 to 8 inches (5 to 20 cm).
- ▶ Press and hold button (6) on remote control (5) until indicator lamp (1) lights up green. When indicator lamp (1) lights up green: programming is finished.

When indicator lamp (1) flashes green: programming was successful. The next step is to synchronize the rolling code (▷ page 264).

- ▶ Release button (6) on remote control (5) for the garage door drive system. If indicator lamp (1) lights up red: repeat the programming procedure for the corresponding button on the rear-view mirror. When doing so, vary the distance between remote control (5) and the rear-view mirror.

The required distance between remote control (5) and the integrated garage door opener depends on the garage door drive system. Several attempts might be necessary. You should test every position for at least 25 seconds before trying another position.

#### Synchronizing the rolling code

Pay attention to the "Important safety notes" (▷ page 264).

If the garage door system uses a rolling code, you will also have to synchronize the garage

door system with the integrated garage door opener in the rear-view mirror. To do this you will need to use the programming button on the door drive control panel. The programming button may be positioned at different locations depending on the manufacturer. It is usually located on the door drive unit on the garage ceiling.

Familiarize yourself with the garage door drive operating instructions, e.g. under "Programming of additional remote controls", before carrying out the following steps.

Your vehicle must be within reach of the garage door or gate opener drive. Make sure that neither your vehicle nor any persons/objects are present within the sweep of the door or gate.

- ▶ Turn the SmartKey to position **2** in the ignition lock (▷ page 135).
- ▶ Get out of the vehicle.
- ▶ Press the programming button on the door drive unit.  
Usually, you now have 30 seconds to initiate the next step.
- ▶ Get into the vehicle.
- ▶ Press previously programmed button ②, ③ or ④ on the integrated garage door opener until the door closes.  
The rolling code synchronization is then complete.

#### Notes on programming the remote control

Canadian radio frequency laws require a "break" (or interruption) of the transmission signals after broadcasting for a few seconds. Therefore, these signals may not last long enough for the integrated garage door opener. The signal is not recognized during programming. Comparable with Canadian law, some U.S. garage door openers also feature a "break".

Proceed as follows:

- if you live in Canada
  - if you have difficulties programming the garage door opener (regardless of where you live) when using the programming steps
- ▶ Press and hold one of buttons ② to ④ on the integrated garage door opener.  
After a short time, indicator lamp ① lights up yellow.
  - ▶ Release the button.  
Indicator lamp ① flashes yellow.
  - ▶ Press button ⑥ of garage door remote control ⑤ for two seconds, then release it for two seconds.
  - ▶ Press button ⑥ again for two seconds.
  - ▶ Repeat this sequence on button ⑥ of remote control ⑤ until indicator lamp ① lights up green.  
When indicator lamp ① lights up green: programming is finished.  
When indicator lamp ① flashes green: programming was successful. The next step is to synchronize the rolling code.
  - ▶ Release button ⑥ of remote control ⑤ of the garage door drive.  
If indicator lamp ① lights up red: repeat the programming process for the corresponding button on the rear-view mirror. When doing so, vary the distance between remote control ⑤ and the rear-view mirror.  
The required distance between remote control ⑤ and the integrated garage door opener depends on the garage door drive system. Several attempts might be necessary. You should test every position for at least 25 seconds before trying another position.

### Problems when programming

If you are experiencing problems programming the integrated garage door opener on the rear-view mirror, take note of the following instructions:

- Check the transmitter frequency used by garage door drive remote control ⑤ and whether it is supported. The transmitter frequency can usually be found on the back of the garage door drive remote control. The integrated garage door opener is compatible with devices that have units which operate in the frequency range of 280 to 433 MHz.
- Replace the batteries in garage door remote control ⑤. This increases the likelihood that garage door remote control ⑤ will transmit a strong and precise signal to the integrated garage door opener.
- When programming, hold remote control ⑤ at varying distances and angles from the button which you are programming. Try various angles at a distance between 2 and 12 inches (5 to 30 cm) or at the same angle but at varying distances.
- If another remote control is available for the same garage door drive, repeat the same programming steps with this remote control. Before performing these steps, make sure that new batteries have been installed in garage door drive remote control ⑤.
- Note that some remote controls only transmit for a limited amount of time (the indicator lamp on the remote control goes out). Press button ⑥ on remote control ⑤ again before transmission ends.
- Align the antenna cable of the garage door opener unit. This can improve signal reception/transmission.

### Opening/closing the garage door

After it has been programmed, the integrated garage door opener performs the function of the garage door system remote control.

Please also read the operating instructions for the garage door system.

- ▶ Turn the SmartKey to position **2** in the ignition lock (> page 135).
- ▶ Press button ②, ③ or ④ which you have programmed to operate the garage door.
  - Garage door system with a fixed code: indicator lamp ① lights up green.
  - Garage door system with a rolling code: indicator lamp ① flashes green.
 The transmitter will transmit a signal as long as the button is pressed. The transmission is halted after a maximum of ten seconds and indicator lamp ① lights up yellow.
- ▶ Press button ②, ③ or ④ again if necessary.

### Clearing the memory

Make sure that you clear the memory of the integrated garage door opener before selling the vehicle.

- ▶ Turn the SmartKey to position **2** in the ignition lock (> page 135).
- ▶ Press and hold buttons ② and ④.
  - The indicator lamp initially lights up yellow and then green.
- ▶ Release buttons ② and ④.
  - The memory of the integrated garage door opener in the rear-view mirror is cleared.

## Compass

### Calling up the compass

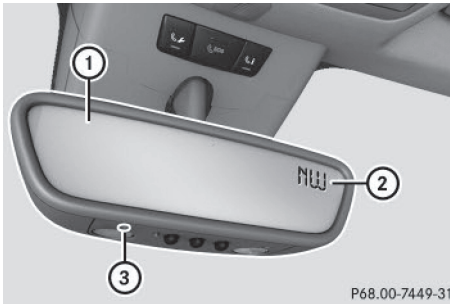

P68.00-7449-31

- ① Rear-view mirror
- ② Compass display
- ③ Opening

The compass displays in which compass direction the vehicle is currently traveling: **N**, **NE**, **E**, **SE**, **S**, **SW**, **W** or **NW**.

To receive a correct compass display reading, the magnetic field zone must be set and the compass calibrated.

### Setting the compass

- ▶ Set your location using the magnetic field zone maps (▷ page 268).
- ▶ Push a round pen into opening ③ for approximately three seconds.  
The magnetic field zone currently selected appears in compass display ②.
- ▶ **To select the magnetic field zone:** push a round pen into opening ③ until the desired magnetic field zone is selected.  
If, after a few seconds, the display in compass display ② changes direction, the magnetic field zone has been selected.

### Calibrating the compass

#### Notes

In order to calibrate the compass correctly, do the following:

- calibrate the compass in the open and not in the vicinity of steel structures or high-voltage transmission lines.
- switch off electrical consumers such as the climate control, windshield wipers or rear window defroster.
- close all doors and the tailgate.

#### Calibrating

- ▶ Make sure that there is sufficient space for you to drive in a circle without impeding traffic.
- ▶ Switch on the ignition.
- ▶ Push a round pen into opening ③ for approximately six seconds, until symbol **C** is shown in compass display ②.
- ▶ Drive your vehicle in a full circle at approximately 3 mph (5 km/h) to 6 mph (10 km/h).  
When the calibration has been successfully completed, the current direction is shown in compass display ②.

## Magnetic field zone maps

### North America

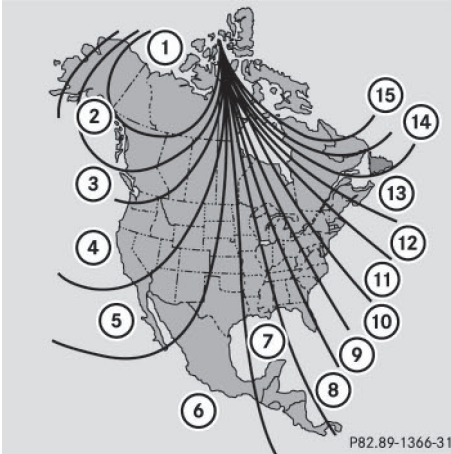

### South America

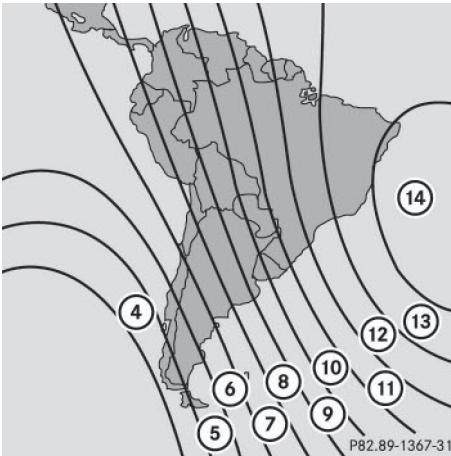

the driver's footwell. Install the floormats securely and as specified in order to ensure sufficient clearance for the pedals. Do not use loose floormats and do not place floormats on top of one another.

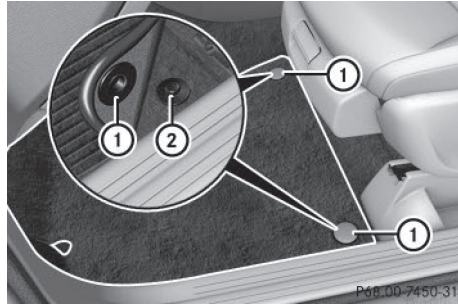

- ▶ Slide the seat backwards.
- ▶ **To install:** place the floormat in the footwell.
- ▶ Press safety catch knobs ① onto retainers ②.
- ▶ **To remove:** pull the floormat off retainers ②.
- ▶ Remove the floormat.

## Floormats

### ⚠ WARNING

Objects in the driver's footwell can restrict the pedal travel or obstruct a depressed pedal. The operating and road safety of the vehicle is jeopardized. There is a risk of an accident.

Make sure that all objects in the vehicle are stowed correctly, and that they cannot enter

Useful information .....	270
Engine compartment .....	270
ASSYST PLUS .....	274
Care .....	275

**Useful information**

- i** This Operator's Manual describes all models and all standard and optional equipment of your vehicle available at the time of publication of the Operator's Manual. Country-specific differences are possible. Please note that your vehicle may not be equipped with all features described. This also applies to safety-related systems and functions.
- i** Read the information on qualified specialist workshops (▷ page 24).

**Engine compartment****Hood****Important safety notes****⚠ WARNING**

If the hood is unlatched, it may open up when the vehicle is in motion and block your view. There is a risk of an accident.

Never unlatch the hood while driving. Before every trip, ensure that the hood is locked.

**⚠ WARNING**

When opening and closing the hood, it may suddenly fall into the closed position. There is a risk of injury to persons within range of movement of the hood.

Open and close the hood only when no one is within its range of movement.

**⚠ WARNING**

Opening the hood when the engine is overheated or when there is a fire in the engine compartment could expose you to hot gases or other service products. There is a risk of injury.

Let an overheated engine cool down before opening the hood. If there is a fire in the engine compartment, keep the hood closed and contact the fire department.

**⚠ WARNING**

The engine compartment contains moving components. Certain components, such as the radiator fan, may continue to run or start again suddenly when the ignition is off. There is a risk of injury.

If you need to do any work inside the engine compartment:

- switch off the ignition
- never reach into the area where there is a risk of danger from moving components, such as the fan rotation area
- remove jewelry and watches
- keep items of clothing and hair, for example, away from moving parts

**⚠ WARNING**

The ignition system and the fuel injection system work under high voltage. If you touch components which are under voltage, you could get an electric shock. There is a risk of injury.

Never touch components of the ignition system or fuel injection system when the ignition is switched on.

**Opening the hood****⚠ WARNING**

Certain components in the engine compartment, such as the engine, radiator and parts of the exhaust system, can become very hot. Working in the engine compartment poses a risk of injury.

Where possible, let the engine cool down and touch only the components described in the following.

**⚠ WARNING**

When the hood is open and the windshield wipers are set in motion, you can be injured by the wiper linkage. There is a risk of injury.

Always switch off the windshield wipers and the ignition before opening the hood.



- ❗ Make sure that the windshield wipers are not folded away from the windshield. You could otherwise damage the windshield wipers or the hood.



- ▶ Make sure that the windshield wipers are switched off.
- ▶ Pull release lever ① on the hood. The hood is released.



- ▶ Reach into the gap between the hood and the radiator trim and press hood catch lever ② to the left.
- ▶ Raise the hood.

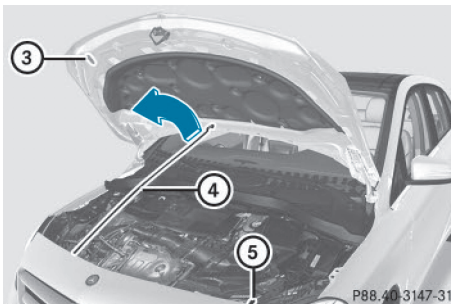

- ▶ Pull support strut ④ out of bracket ⑤.
- ▶ Lift up support strut ④ and insert it into yellow retaining clip ③.

### Closing the hood

- ▶ Raise the hood slightly and, at the same time, remove support strut ④ from yellow retaining clip ③.
- ▶ Swing support strut ④ down and press it into bracket ⑤ until it engages.
- ▶ Lower the hood and let it fall from a height of approximately 8 in (20 cm).
- ▶ Check that the hood has engaged properly. If the hood can be raised slightly, it is not properly engaged. Do not press the hood closed. Open the hood again and close it with a little more force.

### Engine oil

#### General notes

Depending on your driving style, the vehicle consumes up to 0.9 US qt (0.8 liters) of oil per 600 miles (1,000 km). The oil consumption may be higher than this when the vehicle is new or if you frequently drive at high engine speeds.

Depending on the engine, the oil dipstick may be in a different location.

When checking the oil level:

- park the vehicle on a level surface.
- the engine should be switched off for approximately five minutes if the engine is at normal operating temperature.
- if the engine is not at normal operating temperature, e.g. if the engine was only started briefly, wait about 30 minutes before carrying out the measurement.

### Checking the oil level using the oil dipstick

#### WARNING

Certain components in the engine compartment, such as the engine, radiator and parts of the exhaust system, can become very hot. Working in the engine compartment poses a risk of injury.

Where possible, let the engine cool down and touch only the components described in the following.

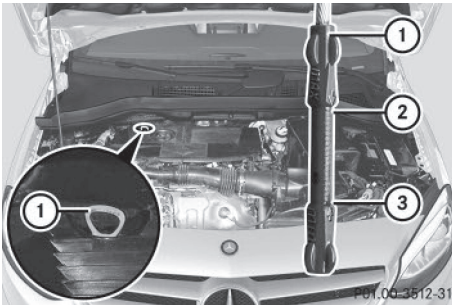

#### Example

- ▶ Pull oil dipstick ① out of the dipstick guide tube.
- ▶ Wipe off oil dipstick ①.
- ▶ Slowly slide oil dipstick ① into the guide tube to the stop, and take it out again. If the level is between MIN mark ③ and MAX mark ②, the oil level is correct.
- ▶ If the oil level has dropped to MIN mark ③ or below, add 1.1 US qt (1.0 liter) of engine oil.

### Adding engine oil

#### WARNING

Certain components in the engine compartment, such as the engine, radiator and parts of the exhaust system, can become very hot. Working in the engine compartment poses a risk of injury.

Where possible, let the engine cool down and touch only the components described in the following.

#### WARNING

If engine oil comes into contact with hot components in the engine compartment, it may ignite. There is a risk of fire and injury.

Make sure that engine oil is not spilled next to the filler neck. Let the engine cool down and thoroughly clean the engine oil off the components before starting the engine.

#### Environmental note

When adding oil, take care not to spill any. If oil enters the soil or waterways, it is harmful to the environment.

- ❗ Only use engine oils and oil filters that have been approved for vehicles with a service system. You can obtain a list of the engine oils and oil filters tested and approved in accordance with the Mercedes-Benz Specifications for Service Products at any Mercedes-Benz Service center.

Damage to the engine or exhaust system is caused by the following:

- using engine oils and oil filters that have not been specifically approved for the service system
  - replacing engine oil and oil filters after the interval for replacement specified by the service system has been exceeded
  - using engine oil additives.
- ❗ Do not add too much oil. adding too much engine oil can result in damage to the engine or to the catalytic converter. Have excess engine oil siphoned off.

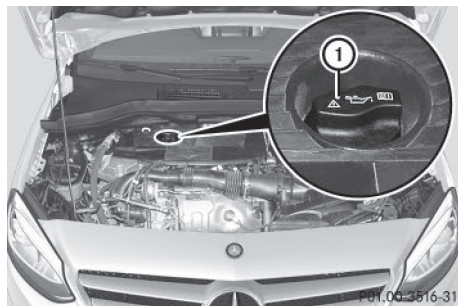

Example: engine oil cap

- ▶ Turn cap ① counter-clockwise and remove it.
- ▶ Add engine oil.  
If the oil level is at or below the MIN mark on the oil dipstick, add 1.1 US qt (1.0 l) of engine oil.
- ▶ Replace cap ① on the filler neck and turn clockwise.  
Ensure that the cap locks into place securely.
- ▶ Check the oil level again with the oil dipstick (▷ page 272).

Further information on engine oil (▷ page 337).

### Checking and adding other service products

#### Checking coolant level

##### WARNING

The engine cooling system is pressurized, particularly when the engine is warm. When opening the cap, you could be scalded by hot coolant spraying out. There is a risk of injury.

Let the engine cool down before opening the cap. Wear eye and hand protection when opening the cap. Open the cap slowly half a turn to allow pressure to escape.

- ❗ The coolant may only be checked and corrected when the engine is cool (coolant temperature below 104 °F (40 °C)). Checking the coolant when the coolant temperature is above 104 °F (40 °C) may result in damage to the engine or to the engine cooling system.

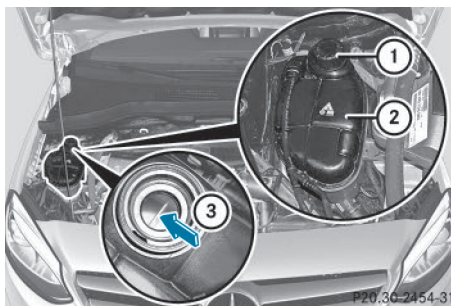

Example

- ▶ Park the vehicle on a level surface.  
Only check the coolant level when the vehicle is on a level surface and the engine has cooled down.
- ▶ Turn the SmartKey to position **2** in the ignition lock (▷ page 135).
- ▶ Check the coolant temperature display in the instrument cluster.  
The coolant temperature must be below 104 °F (40 °C).
- ▶ Turn the SmartKey to position **0** in the ignition lock (▷ page 135).
- ▶ Slowly turn cap ① half a turn counter-clockwise to allow excess pressure to escape.
- ▶ Turn cap ① further counter-clockwise and remove it.  
If the coolant is at the level of marker bar ③ in the filler neck when cold, there is enough coolant in coolant expansion tank ②.
- ▶ If necessary, add coolant that has been tested and approved by Mercedes-Benz.
- ▶ Replace cap ① and turn it clockwise as far as it will go.

For further information on coolant, see (▷ page 339).

#### Windshield washer system

##### WARNING

Certain components in the engine compartment, such as the engine, radiator and parts of the exhaust system, can become very hot.

Working in the engine compartment poses a risk of injury.

Where possible, let the engine cool down and touch only the components described in the following.

#### WARNING

Windshield washer concentrate could ignite if it comes into contact with hot engine components or the exhaust system. There is a risk of fire and injury.

Make sure that no windshield washer concentrate is spilled next to the filler neck.

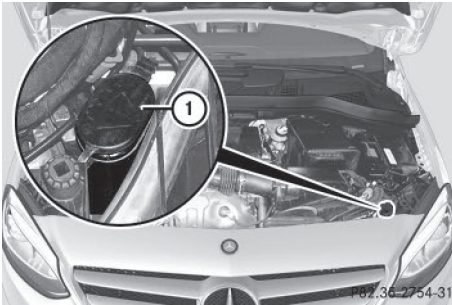

Example

- ▶ **To open:** pull cap ① upwards by the tab.
- ▶ Add the premixed washer fluid.
- ▶ **To close:** press cap ① onto the filler neck until it engages.

If the washer fluid level drops below the recommended minimum of 1 liter, a message appears in the multifunction display prompting you to add washer fluid (▷ page 233).

Further information on windshield washer fluid/antifreeze (▷ page 339).

## ASSYST PLUS

### Service message

The ASSYST PLUS service interval display informs you of the next service due date.

You can find information on the type of service and service intervals in the Maintenance Booklet.

You can obtain further information from an authorized Mercedes-Benz Center or at <http://www.mbusa.com> (USA only).

- i** The ASSYST PLUS service interval display does not show any information on the engine oil level. Observe the notes on the engine oil level (▷ page 271).

The multifunction display shows a service message for several seconds, e.g.:

- Service A in .. Days
- Service A Due
- Service A Exceeded by .. Days

Depending on the operating conditions of the vehicle, the remaining time or distance until the next service due date is displayed.

The letter **A** or **B**, possibly in connection with a number or another letter, indicates the type of service. **A** stands for a minor service and **B** for a major service.

You can obtain further information from an authorized Mercedes-Benz Center.

The ASSYST PLUS service interval display does not take into account any periods of time during which the battery is disconnected.

Maintaining the time-dependent service schedule:

- ▶ Note down the service due date displayed in the multifunction display before disconnecting the battery.





or

- ▶ After reconnecting the battery, subtract the battery disconnection periods from the service date shown on the display.

### Hiding a service message

- ▶ Press the **OK** or  button on the steering wheel.

### Displaying service messages

- ▶ Switch on the ignition.
- ▶ Press the  or  button to select the **Serv.** menu.
- ▶ Press the  or  button to select the **ASSYST PLUS** submenu and confirm by pressing the  button.  
The service due date appears in the multi-function display.

### Information about Service

#### Resetting the ASSYST PLUS service interval display

**!** If the ASSYST PLUS service interval display has been inadvertently reset, this setting can be corrected at a qualified specialist workshop.

Have service work carried out as described in the Maintenance Booklet. This may otherwise lead to increased wear and damage to the major assemblies or the vehicle.

A qualified specialist workshop, e.g. an authorized Mercedes-Benz Center, will reset the ASSYST PLUS service interval display after the service work has been carried out. You can also obtain further information on maintenance work, for example.

#### Special service requirements

The specified maintenance interval takes only the normal operation of the vehicle into account. Under arduous operating conditions or increased load on the vehicle, maintenance work must be carried out more frequently, for example:

- regular city driving with frequent intermediate stops
- if the vehicle is primarily used to travel short distances

- use in mountainous terrain or on poor road surfaces
- if the engine is often left idling for long periods

Under these or similar conditions, have, for example, the air filter, engine oil and oil filter replaced or changed more frequently. Under arduous operating conditions, the tires must be checked more often. Further information can be obtained at a qualified specialist workshop, e.g. an authorized Mercedes-Benz Center.

#### Driving abroad

An extensive Mercedes-Benz Service network is also available in other countries. You can obtain further information from any authorized Mercedes-Benz Center.

### Care

#### General notes

##### Environmental note

Dispose of empty packaging and cleaning cloths in an environmentally responsible manner.

**!** For cleaning your vehicle, do not use any of the following:

- dry, rough or hard cloths
- abrasive cleaning agents
- solvents
- cleaning agents containing solvents

Do not scrub.

Do not touch the surfaces or protective films with hard objects, e.g. a ring or ice scraper. You could otherwise scratch or damage the surfaces and protective film.

**!** Do not park the vehicle for an extended period straight after cleaning it, particularly after having cleaned the wheels with wheel cleaner. Wheel cleaners could cause increased corrosion of the brake discs and brake pads/linings. For this reason, you

should drive for a few minutes after cleaning. Braking heats the brake discs and the brake pads/linings, thus drying them. The vehicle can then be parked.

Regular care of your vehicle is a condition for retaining the quality in the long term.

Use care products and cleaning agents recommended and approved by Mercedes-Benz.

### Washing the vehicle and cleaning the paintwork

#### Automatic car wash

##### WARNING

Braking efficiency is reduced after washing the vehicle. There is a risk of an accident.

After the vehicle has been washed, brake carefully while paying attention to the traffic conditions until full braking power is restored.

**!** If DISTRONIC PLUS or the HOLD function is activated, the vehicle brakes automatically in certain situations.

To prevent damage to the vehicle, deactivate DISTRONIC PLUS and the HOLD function in the following or other similar situations:

- when towing the vehicle
- in the car wash

**!** Never clean your vehicle in a Touchless Automatic Car Wash as these use special cleaning agents. These cleaning agents can damage the paintwork or plastic parts.

**!** Make sure that the automatic transmission is in position **N** when washing your vehicle in a tow-through car wash. The vehicle could be damaged if the transmission is in another position.

**!** Make sure that:

- the side windows and the sliding sunroof are fully closed.
- the ventilation/heating is switched off (the OFF button has been pressed/the airflow control is set to position **0**).
- the windshield wiper switch is in position **0**.

Otherwise, the vehicle might be damaged.

You can wash the vehicle in an automatic car wash from the very start.

If the vehicle is very dirty, pre-wash it before cleaning it in an automatic car wash.

After using an automatic car wash, wipe off wax from the windshield and the wiper blades. This will prevent smears and reduce wiping noises caused by residue on the windshield.

#### Washing by hand

In some countries, washing by hand is only allowed at specially equipped washing bays. Observe the legal requirements in each country.

- ▶ Do not use hot water and do not wash the vehicle in direct sunlight.
- ▶ Use a soft sponge to clean.
- ▶ Use a mild cleaning agent, such as a car shampoo approved by Mercedes-Benz.
- ▶ Thoroughly hose down the vehicle with a gentle jet of water.
- ▶ Do not point the water jet directly towards the air inlet.
- ▶ Use plenty of water and rinse out the sponge frequently.
- ▶ Rinse the vehicle with clean water and dry thoroughly with a chamois.
- ▶ Do not let the cleaning agent dry on the paintwork.

Carefully remove all deposits of road salt as soon as possible when driving in winter.

## Power washers

### WARNING

The water jet from a circular jet nozzle (dirt blasters) can cause invisible exterior damage to the tires or chassis components. Components damaged in this way may fail unexpectedly. There is a risk of an accident.

Do not use power washers with circular jet nozzles to clean the vehicle. Have damaged tires or chassis components replaced immediately.

- !** Always maintain a distance of at least 11.8 in (30 cm) between the vehicle and the power washer nozzle. Information about the correct distance is available from the equipment manufacturer.

Move the power washer nozzle around when cleaning your vehicle.

Do not aim directly at any of the following:

- tires
- door gaps, roof gaps, joints, etc.
- electrical components
- battery
- connectors
- lights
- seals
- trim
- ventilation slots

Damaged seals or electrical components can lead to leaks or failures.

## Cleaning the paintwork

- !** Do not affix:

- stickers
  - films
  - magnetic plates or similar items
- to painted surfaces. You could otherwise damage the paintwork.

Scratches, corrosive deposits, areas affected by corrosion and damage caused by inadequate care cannot always be completely

repaired. In such cases, visit a qualified specialist workshop.

- ▶ Remove dirt immediately, where possible, while avoiding rubbing too hard.
- ▶ Soak insect remains with insect remover and rinse off the treated areas afterwards.
- ▶ Soak bird droppings with water and rinse off the treated areas afterwards.
- ▶ Remove coolant, brake fluid, tree resin, oils, fuels and greases by rubbing gently with a cloth soaked in petroleum ether or lighter fluid.
- ▶ Use tar remover to remove tar stains.
- ▶ Use silicone remover to remove wax.

If water no longer forms "beads" on the paint surface, use the paint care products recommended and approved by Mercedes-Benz. This is the case approximately every three to five months, depending on the climate conditions and the care product used.

If dirt has penetrated the paint surface or if the paint has become dull, the paint cleaner recommended and approved by Mercedes-Benz should be used.

Do not use these care products in the sun or on the hood while the hood is hot.

- ▶ Use a suitable touch-up stick, e.g. MB Touch-Up Stick, to repair slight damage to the paintwork quickly and provisionally.

## Matte finish care

- !** Never polish the vehicle or the light alloy wheels. Polishing causes the finish to shine.

- !** The following may cause the paint to become shiny and thus reduce the matte effect:

- Vigorous rubbing with unsuitable materials.
- Frequent use of car washes.
- Washing the vehicle in direct sunlight.

- !** Never use paint cleaner, buffing or polishing products, or gloss preserver, e.g.

wax. These products are only suitable for high-gloss surfaces. Their use on vehicles with matte finish leads to considerable surface damage (shiny, spotted areas).

Always have paintwork repairs carried out at a qualified specialist workshop.

- ❗ Do not use wash programs with a hot wax treatment under any circumstances.

Observe these notes if your vehicle has a clear matte finish. This will help you to avoid damage to the paintwork due to incorrect treatment.

These notes also apply to light alloy wheels with a clear matte finish.

The vehicle should preferably be washed by hand using a soft sponge, car shampoo and plenty of water.

Use only insect remover and car shampoo from the range of approved Mercedes-Benz care products.

### Cleaning the vehicle parts

#### Cleaning the wheels

##### WARNING

The water jet from a circular jet nozzle (dirt blasters) can cause invisible exterior damage to the tires or chassis components. Components damaged in this way may fail unexpectedly. There is a risk of an accident.

Do not use power washers with circular jet nozzles to clean the vehicle. Have damaged tires or chassis components replaced immediately.

- ❗ Do not use acidic wheel cleaning products to remove brake dust. This could damage wheel bolts and brake components.

- ❗ Do not park the vehicle for an extended period straight after cleaning it, particularly after having cleaned the wheels with wheel cleaner. Wheel cleaners could cause increased corrosion of the brake discs and brake pads/linings. For this reason, you

should drive for a few minutes after cleaning. Braking heats the brake discs and the brake pads/linings, thus drying them. The vehicle can then be parked.

#### Cleaning the windows

##### WARNING

You could become trapped by the windshield wipers if they start moving while cleaning the windshield or wiper blades. There is a risk of injury.

Always switch off the windshield wipers and the ignition before cleaning the windshield or wiper blades.

- ❗ Only fold the windshield wipers away from the windshield when vertical. Otherwise, you will damage the hood.
- ❗ Do not use dry cloths, abrasive products, solvents or cleaning agents containing solvents to clean the inside of the windows. Do not touch the insides of the windows with hard objects, e.g. an ice scraper or ring. There is otherwise a risk of damaging the windows.
- ❗ Clean the water drainage channels of the windshield and the rear window at regular intervals. Deposits such as leaves, petals and pollen may under certain circumstances prevent water from draining away. This can lead to corrosion damage and damage to electronic components.

- ▶ Clean the inside and outside of the windows with a damp cloth and a cleaning product that is recommended and approved by Mercedes-Benz.

#### Cleaning wiper blades

##### WARNING

You could become trapped by the windshield wipers if they start moving while cleaning the windshield or wiper blades. There is a risk of injury.



Always switch off the windshield wipers and the ignition before cleaning the windshield or wiper blades.

- ❗ Only fold the windshield wipers away from the windshield when vertical. Otherwise, you will damage the hood.
  - ❗ Do not pull the wiper blade. Otherwise, the wiper blade could be damaged.
  - ❗ Do not clean wiper blades too often and do not rub them too hard. Otherwise, the graphite coating could be damaged. This could cause wiper noise.
  - ❗ Hold the wiper arm securely when folding back. The windshield could be damaged if the wiper arm smacks against it suddenly.
- ▶ Fold the windshield wiper arms away from the windshield.
  - ▶ Carefully clean the wiper blades with a damp cloth.
  - ▶ Fold the windshield wiper arms back again before switching on the ignition.

### Cleaning the exterior lighting

- ❗ Only use cleaning agents or cleaning cloths which are suitable for plastic light lenses. Unsuitable cleaning agents or cleaning cloths could scratch or damage the plastic light lenses.
- ▶ Clean the plastic lenses of the exterior lights with a wet sponge and a mild cleaning agent, e.g. Mercedes-Benz car shampoo or cleaning cloths.

### Cleaning the mirror turn signals

- ❗ Only use cleaning agents or cleaning cloths that are suitable for plastic lenses. Unsuitable cleaning agents or cleaning cloths could scratch or damage the plastic lenses of the mirror turn signals.
- ▶ Clean the plastic lenses of the mirror turn signals in the exterior mirror housing using a wet sponge and mild cleaning agent, e.g.

Mercedes-Benz car shampoo or cleaning cloths.

### Cleaning the sensors

- ❗ If you clean the sensors with a power washer, make sure that you keep a distance of at least 11.8 in (30 cm) between the vehicle and the power washer nozzle. Information about the correct distance is available from the equipment manufacturer.

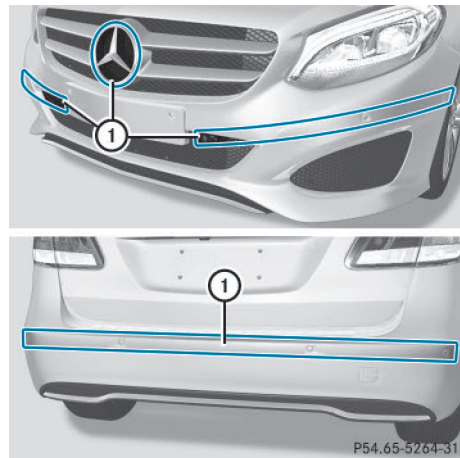

- ▶ Clean sensors ① of the driving systems with water, car shampoo and a soft cloth.

### Cleaning the rear view camera

- ❗ Do not clean the camera lens and the area around the rear view camera with a power washer.

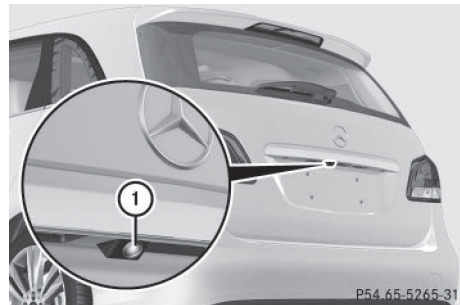

- ▶ Use clear water and a soft cloth to clean camera lens ①.

### Cleaning the exhaust pipes

#### WARNING

The exhaust tail pipe and tail pipe trim can become very hot. If you come into contact with these parts of the vehicle, you could burn yourself. There is a risk of injury.

Always be particularly careful around the exhaust tail pipe and the tail pipe trim. Allow these components to cool down before touching them.

- ❗ Do not clean the exhaust pipe with acid-based cleaning agents, such as bathroom cleaner or wheel cleaner.

Impurities combined with the effects of road grit and corrosive environmental factors may cause flash rust to form on the surface. You can restore the original shine of the exhaust pipe by cleaning it regularly, especially in winter and after washing.

- ▶ Clean the exhaust pipe with a care product tested and approved by Mercedes-Benz.

### Interior care

#### Cleaning the display

- ❗ For cleaning, do not use any of the following:
  - alcohol-based thinner or gasoline
  - abrasive cleaning agents
  - commercially-available household cleaning agents

These may damage the display surface. Do not put pressure on the display surface when cleaning. This could lead to irreparable damage to the display.

- ▶ Before cleaning the display, make sure that it is switched off and has cooled down.
- ▶ Clean the display surface using a commercially available microfiber cloth and TFT/LCD display cleaner.
- ▶ Dry the display surface using a dry microfiber cloth.

### Cleaning the plastic trim

#### WARNING

Care products and cleaning agents containing solvents cause surfaces in the cockpit to become porous. As a result, plastic parts may come loose in the event of air bag deployment. There is a risk of injury.

Do not use any care products and cleaning agents to clean the cockpit.

- ❗ Do not affix the following to plastic surfaces:
  - stickers
  - films
  - scented oil bottles or similar items
 You can otherwise damage the plastic.

- ❗ Do not allow cosmetics, insect repellent or sunscreen to come into contact with the plastic trim. This maintains the high-quality look of the surfaces.

- ▶ Wipe the plastic trim with a damp, lint-free cloth, e.g. a microfiber cloth.
- ▶ **Heavy soiling:** use care and cleaning products recommended and approved by Mercedes-Benz. The surface may change color temporarily. Wait until the surface is dry again.

### Cleaning the steering wheel and gear or selector lever

- ▶ Thoroughly wipe with a damp cloth or use leather care agents that have been recommended and approved by Mercedes-Benz.

## Cleaning genuine wood and trim elements

❗ Do not use solvent-based cleaning agents such as tar remover, wheel cleaners, polishes or waxes. There is otherwise a risk of damaging the surface.

❗ Do not use chrome polish on trim pieces. The trim pieces have a chrome look but are mostly made of anodized aluminum and can lose their shine if chrome polish is used. Use a damp, lint-free cloth instead when cleaning the trim pieces.

If the chrome-plated trim pieces are very dirty, you can use a chrome polish. If you are unsure as to whether the trim pieces are chrome-plated or not, consult an authorized Mercedes-Benz Center.

- ▶ Wipe the wooden trim and trim pieces with a damp, lint-free cloth, e.g. a microfiber cloth.
- ▶ **Heavy soiling:** use care and cleaning products recommended and approved by Mercedes-Benz.

## Cleaning the seat covers

### General notes

❗ Do not use microfiber cloths to clean genuine leather, artificial leather or DINAMICA covers. If used often, these can damage the cover.

Note that regular care is essential to ensure that the appearance and comfort of the covers is retained over time.

## Genuine leather seat covers

❗ To retain the natural appearance of the leather, observe the following cleaning instructions:

- Clean genuine leather covers carefully with a damp cloth and then wipe the covers down with a dry cloth.
- Make sure that the leather does not become soaked. It may otherwise become rough and cracked.
- Only use leather care agents that have been tested and approved by Mercedes-Benz. You can obtain these from a qualified specialist workshop.

Leather is a natural product.

It exhibits natural surface characteristics, for example:

- differences in the texture
- marks caused by growth and injury
- slight nuances of color

These are characteristics of leather and not material defects.

## Seat covers of other materials

❗ Observe the following when cleaning:

- clean artificial leather covers with a cloth moistened with a solution containing 1% detergent (e.g. dish washing liquid).
- clean cloth covers with a microfiber cloth moistened with a solution containing 1% detergent (e.g. dish washing liquid). Rub carefully and always wipe entire seat sections to avoid leaving visible lines. Leave the seat to dry afterwards. Cleaning results depend on the type of dirt and how long it has been there.
- clean DINAMICA covers with a damp cloth. Make sure that you wipe entire seat sections to avoid leaving visible lines.

### Cleaning the seat belts

---

 **WARNING**

Seat belts can become severely weakened if bleached or dyed. This could cause the seat belts to tear or fail, for instance, in the event of an accident. This poses an increased risk of injury or fatal injury.

Never bleach or dye the seat belts.

**!** Do not clean the seat belts using chemical cleaning agents. Do not dry the seat belts by heating at temperatures above 176 °F (80 °C) or in direct sunlight.

- ▶ Use clean, lukewarm water and soap solution.

### Cleaning the headliner and carpets

---

- ▶ **Headliner:** if it is very dirty, use a soft brush or dry shampoo.
- ▶ **Carpets:** use the carpet and textile cleaning agents recommended and approved by Mercedes-Benz.

Useful information .....	284
Where will I find...? .....	284
Flat tire .....	284
Battery (vehicle) .....	289
Jump-starting .....	293
Towing and tow-starting .....	295
Fuses .....	298

### Useful information

- i** This Operator's Manual describes all models and all standard and optional equipment of your vehicle available at the time of publication of the Operator's Manual. Country-specific differences are possible. Please note that your vehicle may not be equipped with all features described. This also applies to safety-related systems and functions.
- i** Read the information on qualified specialist workshops (▷ page 24).

### Where will I find...?

#### Vehicle tool kit

#### General notes

Vehicles with a TIREFIT kit: the TIREFIT kit is located in the stowage well under the cargo compartment floor.

Vehicles with a tire-change tool kit: the tire-change tool kit is in the stowage well under the cargo compartment floor.

For vehicles with an emergency spare wheel, see "Removing the emergency spare wheel" (▷ page 330).

- i** Apart from certain country-specific variations, the vehicles are not equipped with a tire-change tool kit. Some tools for changing a wheel are specific to the vehicle. For more information on which tire changing tools are required and approved to perform a wheel change on your vehicle, consult a qualified specialist workshop.

Tools required for changing a wheel may include, for example:

- Jack
- Wheel chock
- Lug wrench
- Alignment bolt

### Vehicles with a TIREFIT kit

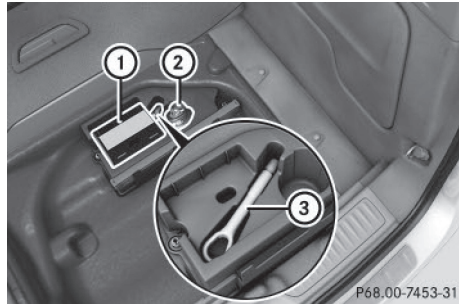

- ① Tire inflation compressor
- ② Tire sealant filler bottle
- ③ Towing eye

- ▶ Open the tailgate.
- ▶ Lift the cargo compartment floor upwards (▷ page 258).
- ▶ Use the TIREFIT kit (▷ page 286).

### Vehicles with a tire-change tool kit

- ▶ Open the tailgate.
- ▶ Lift the cargo compartment floor upwards (▷ page 258).
- ▶ Remove the tire-change tool kit.

The tire-change tool kit contains:

- Jack
- Lug wrench
- One pair of gloves
- Folding wheel chock

### Flat tire

#### Preparing the vehicle

Your vehicle may be equipped with:

- MOExtended tires (tires with run-flat properties) (▷ page 285)  
Vehicle preparation is not necessary on vehicles with MOExtended tires
- a TIREFIT kit (▷ page 284)
- an emergency spare wheel (only for certain countries) (▷ page 329)

Information on changing/mounting a wheel (▷ page 322).

- ▶ Stop the vehicle on solid, non-slippery and level ground, as far away as possible from traffic.
- ▶ Switch on the hazard warning lamps.
- ▶ Secure the vehicle against rolling away (▷ page 152).
- ▶ If possible, bring the front wheels into the straight-ahead position.
- ▶ Switch off the engine.
- ▶ **Vehicles without KEYLESS-GO:** remove the SmartKey from the ignition lock.
- ▶ **Vehicles with KEYLESS-GO start-function or KEYLESS-GO:** open the driver's door.  
The on-board electronics now have status **0**. This is the same as the SmartKey having been removed.
- ▶ **Vehicles with KEYLESS-GO start-function or KEYLESS-GO:** remove the Start/Stop button from the ignition lock (▷ page 135).
- ▶ All occupants must get out of the vehicle. Make sure that they are not endangered as they do so.
- ▶ Make sure that no one is near the danger area while a wheel is being changed. Anyone who is not directly assisting in the wheel change should, for example, stand behind the barrier.
- ▶ Get out of the vehicle. Pay attention to traffic conditions when doing so.
- ▶ Close the driver's door.

**i** Vehicles equipped with MOExtended tires are not equipped with a TIREFIT kit at the factory. It is therefore recommended that you additionally equip your vehicle with a TIREFIT kit if you mount tires that do not feature run-flat properties, e.g. winter tires. A TIREFIT kit can be obtained from a qualified specialist workshop.

## MOExtended tires (tires with run-flat properties)

### General notes

With MOExtended tires (tires with run flat characteristics), you can continue to drive your vehicle even if there is a total loss of pressure in one or more tires. The affected tire must not show any clearly visible damage.

You can recognize MOExtended tires by the MOExtended marking which appears on the sidewall of the tire. You will find this marking next to the tire size designation, the load-bearing capacity and the speed index (▷ page 316).

MOExtended tires may only be used in conjunction with an active tire pressure loss warning system.

### If a pressure loss warning message appears in the multifunction display:

- observe the instructions in the display messages (▷ page 229).
- check the tire for damage.
- if driving on, observe the following notes.

The driving distance possible in run-flat mode is approximately 50 miles (80 km) when the vehicle is partially laden and approximately 18 miles (30 km) when the vehicle is fully laden.

In addition to the vehicle load, the driving distance possible depends upon:

- vehicle speed
- road condition
- outside temperature

The driving distance possible in run-flat mode may be reduced by extreme driving conditions/maneuvers, or it can be increased through a moderate style of driving.

The driving distance possible in run-flat mode is counted from the moment the tire pressure loss warning appears in the multifunction display.

You must not exceed a maximum speed of 50 mph (80 km/h).

When replacing one or all tires, please observe the following specifications for your vehicle's tires:

- size
- type and
- the "MOExtended" mark

If a tire has gone flat and cannot be replaced with a MOExtended tire, a standard tire may be used as a temporary measure. Make sure that you use the proper size and type (summer or winter tire).

Vehicles equipped with MOExtended tires are not equipped with a TIREFIT kit at the factory. It is therefore recommended that you additionally equip your vehicle with a TIREFIT kit if you mount tires that do not feature run-flat properties, e.g. winter tires. A TIREFIT kit may be obtained from a qualified specialist workshop.

### Important safety notes

#### WARNING

When driving in emergency mode, the driving characteristics deteriorate, e.g. when cornering, accelerating quickly and when braking. There is a risk of an accident.

Do not exceed the stated maximum speed. Avoid abrupt steering and driving maneuvers, and driving over obstacles (curbs, potholes, off-road). This applies in particular to a laden vehicle.

Stop driving in emergency mode if:

- you hear banging noises.
- the vehicle starts to shake.
- you see smoke and smell rubber.
- ESP® is intervening constantly.
- there are tears in the sidewalls of the tire.

After driving in emergency mode, have the wheel rims checked at a qualified specialist workshop with regard to their further use. The defective tire must be replaced in every case.

### TIREFIT kit

#### Important safety notes

TIREFIT is a tire sealant.

You can use TIREFIT to seal punctures of up to 0.16 in (4 mm), particularly those in the tire tread. You can use TIREFIT at outside temperatures down to -4 °F (-20 °C).

#### WARNING

In the following situations, the tire sealant is unable to provide sufficient breakdown assistance, as it is unable to seal the tire properly:

- there are cuts or punctures in the tire larger than those mentioned above.
- the wheel rim is damaged.
- you have driven at very low tire pressures or on a flat tire.

There is a risk of an accident.

Do not drive the vehicle. Contact a qualified specialist workshop.

#### WARNING

The tire sealant is harmful and causes irritation. It must not come into contact with your skin, eyes or clothing or be swallowed. Do not inhale TIREFIT fumes. Keep tire sealant away from children. There is a risk of injury.

If you come into contact with the tire sealant, observe the following:

- Rinse off the tire sealant from your skin immediately with water.
- If the tire sealant comes into contact with your eyes, immediately rinse them thoroughly with clean water.
- If tire sealant is swallowed, immediately rinse your mouth out thoroughly and drink plenty of water. Do not induce vomiting, and seek medical attention immediately.
- Immediately change out of clothing which has come into contact with tire sealant.
- If an allergic reaction occurs, seek medical attention immediately.



**!** Do not operate the tire inflation compressor for longer than ten minutes at a time without a break. It may otherwise overheat.

The tire inflation compressor can be operated again once it has cooled down.

Comply with the manufacturer's safety instructions on the sticker on the tire inflation compressor.

### Using the TIREFIT kit

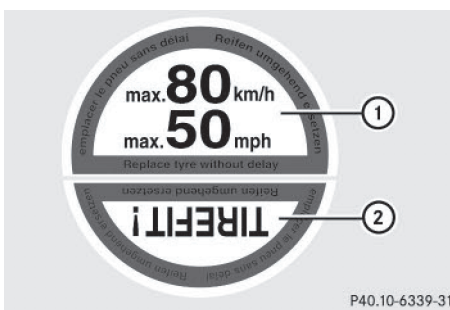

P40.10-6339-31

- ▶ Do not remove any foreign objects which have penetrated the tire, e.g. screws or nails.
- ▶ Remove the tire sealant bottle, the accompanying TIREFIT sticker and the tire inflation compressor from the stowage well underneath the cargo compartment floor (▷ page 284).
- ▶ Affix part ① of the TIREFIT sticker to the instrument cluster within the driver's field of vision.
- ▶ Affix part ② of the TIREFIT sticker near the valve on the wheel with the defective tire.

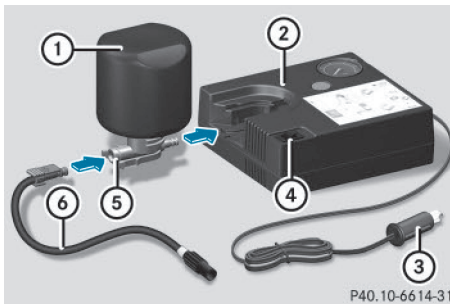

P40.10-6614-31

- ▶ Remove filler hose ⑥ and connector ③ from the bottom section of the tire inflation compressor housing ②.
- ▶ Slide the yellow filler hose connector into the mounting on yellow cap ⑤ of tire sealant bottle ① until the connector engages.
- ▶ With the sealing rings in front, slide yellow cap ⑤ of tire sealant bottle ① into the mounting of tire inflation compressor ② until the cap and both hooks engage.

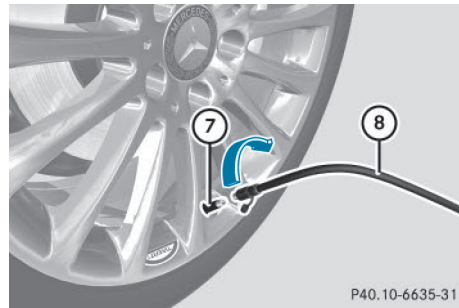

P40.10-6635-31

- ▶ Remove the cap from valve ⑦ on the faulty tire.
- ▶ Screw filler hose ⑧ onto valve ⑦.
- ▶ Insert connector ③ into a 12 V socket (▷ page 262) in your vehicle.
- ▶ Turn the SmartKey to position **1** in the ignition lock (▷ page 135).
- ▶ Press on/off switch ④ on the tire inflation compressor to **ON**.  
The tire inflation compressor is switched on. The tire is inflated.  
First, tire sealant is pumped into the tire. The pressure can briefly rise to approximately 500 kPa (5 bar/73 psi).  
**Do not switch off the tire inflation compressor during this phase.**
- ▶ Let the tire inflation compressor run for a maximum of ten minutes. The tire should then have attained a pressure of at least 200 kPa (2.0 bar/29 psi).

If a pressure of 200 kPa (2.0 bar/29 psi) has been attained after ten minutes, see "Tire pressure reached" (▷ page 288).

If a pressure of 200 kPa (2.0 bar/29 psi) has not been attained after ten minutes, see "Tire pressure not reached" (▷ page 288).

If tire sealant leaks out, allow it to dry. It can then be removed like a layer of film.

If your clothes are soiled with tire sealant, have them cleaned with perchloroethylene at a dry cleaner as soon as possible.

### Tire pressure not reached

If a tire pressure of 200 kPa (2.0 bar/29 psi) has not been achieved after ten minutes:

- ▶ Switch off the tire inflation compressor.
- ▶ Unscrew the filler hose from the valve of the faulty tire.
- ▶ Very slowly drive forwards or reverse approximately 30 ft (10 m).
- ▶ Pump up the tire again.

After a maximum of ten minutes, the tire pressure must be at least 200 kPa (2.0 bar/29 psi).

#### WARNING

If the required tire pressure is not reached after the specified time, the tire is too badly damaged. The tire sealant cannot repair the tire in this instance. Damaged tires and a tire pressure that is too low can significantly impair the vehicle's braking and driving characteristics. There is a risk of accident.

Do not continue driving. Contact a qualified specialist workshop.

### Tire pressure reached

#### WARNING

A tire temporarily sealed with tire sealant impairs the driving characteristics and is not suitable for higher speeds. There is a risk of accident.

You should therefore adapt your driving style accordingly and drive carefully. Do not exceed the specified maximum speed with a tire that has been repaired using tire sealant.

The maximum speed for a tire sealed with tire sealant is 50 mph (80 km/h). The upper part of the TIREFIT sticker must be affixed to the instrument cluster in the driver's field of vision.

 Residue from the tire sealant may come out of the filler hose after use. This could cause stains.

Therefore, place the filler hose in the plastic bag which contained the TIREFIT kit.

#### Environmental note

Have the used tire sealant bottle disposed of professionally, e.g. at a qualified specialist workshop.

If a tire pressure of 200 kPa (2.0 bar/29 psi) has been achieved after ten minutes:

- ▶ Switch off the tire inflation compressor.
- ▶ Unscrew the filler hose from the valve of the faulty tire.
- ▶ Stow the tire sealant bottle and the tire inflation compressor.
- ▶ **Pull away immediately.**
- ▶ Stop after driving for approximately ten minutes and check the tire pressure with the tire inflation compressor. The tire pressure must now be at least 130 kPa (1.3 bar/19 psi).

#### WARNING

If the required tire pressure is not reached after driving for a short period, the tire is too badly damaged. The tire sealant cannot repair the tire in this instance. Damaged tires and a tire pressure that is too low can significantly impair the vehicle's braking and driving characteristics. There is a risk of accident.

Do not continue driving. Contact a qualified specialist workshop.

 In cases such as the one mentioned above, contact an authorized Mercedes-Benz Center. Or call 1-800-FOR-MERCEdes (in the USA) or 1-800-387-0100 (in Canada).

- ▶ Correct the tire pressure if it is still at least 130 kPa (1.3 bar/19 psi). See the Tire and Loading Information placard on the driver's side B-pillar or the tire pressure table in the fuel filler flap for values.
- ▶ **To increase the tire pressure:** switch on the tire inflation compressor.

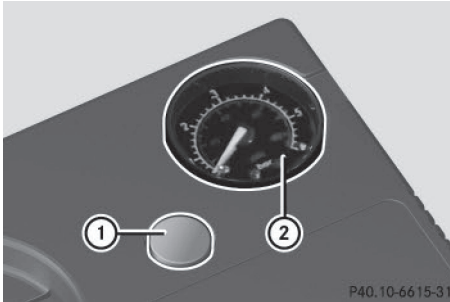

- ▶ **To reduce the tire pressure:** depress pressure release button ① next to pressure gauge ②.
- ▶ When the tire pressure is correct, unscrew the filler hose from the valve of the sealed tire.
- ▶ Screw the valve cap onto the tire valve of the sealed tire.

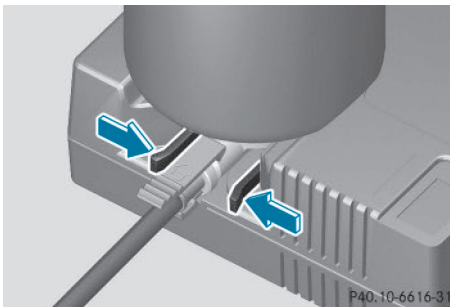

- ▶ To remove the tire sealant bottle from the tire inflation compressor, press together the locking tabs on the yellow cap.
- ▶ Pull the tire sealant bottle out of the tire inflation compressor. The filler hose remains attached to the tire sealant bottle.

- ▶ Drive to the nearest qualified specialist workshop and have the tire changed there.
- ▶ Have the tire sealant bottle and the filler hose replaced as soon as possible at a qualified specialist workshop.
- ▶ Have the tire sealant bottle replaced every four years at a qualified specialist workshop.

## Battery (vehicle)

### Important safety notes

Special tools and expert knowledge are required when working on the battery, e.g. removal and installation. You should therefore have all work involving the battery carried out at a qualified specialist workshop.

#### WARNING

Work carried out incorrectly on the battery can lead, for example, to a short circuit and thus damage the vehicle electronics. This can lead to function restrictions applying to safety-relevant systems, e.g. the lighting system, the ABS (anti-lock braking system) or the ESP® (Electronic Stability Program). The operating safety of your vehicle may be restricted. You could lose control of the vehicle, for example:

- when braking
- in the event of abrupt steering maneuvers and/or when the vehicle's speed is not adapted to the road conditions

There is a risk of an accident.

In the event of a short circuit or a similar incident, contact a qualified specialist workshop immediately. Do not drive any further. You should have all work involving the battery carried out at a qualified specialist workshop.

For further information about ABS and ESP®, see (▷ page 61) and (▷ page 64).

**⚠ WARNING**

Electrostatic build-up can lead to the creation of sparks, which could ignite the highly explosive gases of a battery. There is a risk of an explosion.

Before handling the battery, touch the vehicle body to remove any existing electrostatic build-up.

The highly flammable gas mixture forms when charging the battery as well as when jump-starting.

Always make sure that neither you nor the battery is electrostatically charged. A build-up of electrostatic charge can be caused, for example:

- by wearing clothing made from synthetic fibers
- due to friction between clothing and seats
- if you push or pull the battery across the carpet or other synthetic materials
- if you wipe the battery with a cloth

**⚠ WARNING**

During the charging process, a battery produces hydrogen gas. If a short circuit occurs or sparks are created, the hydrogen gas can ignite. There is a risk of an explosion.

- Make sure that the positive terminal of a connected battery does not come into contact with vehicle parts.
- Never place metal objects or tools on a battery.
- It is important that you observe the described order of the battery terminals when connecting and disconnecting a battery.
- When jump-starting, make sure that the battery poles with identical polarity are connected.
- It is particularly important to observe the described order when connecting and disconnecting the jumper cables.
- Never connect or disconnect the battery terminals while the engine is running.

**⚠ WARNING**

Battery acid is caustic. There is a risk of injury. Avoid contact with skin, eyes or clothing. Do not inhale any battery gases. Do not lean over the battery. Keep children away from batteries. Wash away battery acid immediately with plenty of clean water and seek medical attention.

**♻ Environmental note**

Batteries contain dangerous substances. It is against the law to dispose of them with the household rubbish. They must be collected separately and recycled to protect the environment.



Dispose of batteries in an environmentally friendly manner. Take discharged batteries to a qualified specialist workshop or a special collection point for used batteries.

- ❗ Have the battery checked regularly at a qualified specialist workshop. Observe the service intervals in the Maintenance Booklet or contact a qualified specialist workshop for more information.
- ❗ You should have all work involving the battery carried out at a qualified specialist workshop. In the exceptional case that it is necessary for you to disconnect the battery yourself, make sure that:
  - you switch off the engine and remove the key. On vehicles with KEYLESS-GO, ensure that the ignition is switched off. Check that all the indicator lamps in the instrument cluster are off. Otherwise, electronic components, such as the alternator, may be damaged.
  - you first remove the negative terminal clamp and then the positive terminal clamp. Never swap the terminal clamps.

Otherwise, the vehicle's electronic system may be damaged.

- in vehicles with automatic transmission, the transmission is locked in position **P** after disconnecting the battery. The vehicle is secured against rolling away. You can then no longer move the vehicle.

The battery and the cover of the positive terminal clamp must be installed securely during operation.

Comply with safety precautions and take protective measures when handling batteries.



Risk of explosion.



Fire, open flames and smoking are prohibited when handling the battery. Avoid creating sparks.



Battery acid is caustic. Avoid contact with skin, eyes or clothing.

Wear suitable protective clothing, especially gloves, apron and face-guard.

Rinse any acid spills immediately with clear water. Contact a physician if necessary.



Wear eye protection.



Keep children away.



Observe this Operator's Manual.

For safety reasons, Mercedes-Benz recommends that you only use batteries which have been tested and approved for your vehicle by Mercedes-Benz. These batteries provide increased impact protection to prevent vehicle occupants from suffering acid burns should the battery be damaged in the event of an accident.

In order for the battery to achieve the maximum possible service life, it must always be sufficiently charged.

Like other batteries, the vehicle battery may discharge over time if you do not use the vehicle. In this case, have the battery disconnected at a qualified specialist workshop. You can also charge the battery with a charger recommended by Mercedes-Benz. Contact a qualified specialist workshop for further information.

Have the battery condition of charge checked more frequently if you use the vehicle mainly for short trips or if you leave it standing idle for a lengthy period. Consult a qualified specialist workshop if you wish to leave your vehicle parked for a long period of time.

Only replace a battery with a battery that has been recommended by Mercedes-Benz.

**i** Remove the SmartKey if you park the vehicle and do not require any electrical consumers. The vehicle will then use very little energy, thus conserving battery power.

**i** If the power supply has been interrupted, e.g. if you reconnect the battery, you will have to:

- set the clock via Audio 20 or COMAND (see separate operating instructions)
- reset the function for folding the exterior mirrors in/out automatically, by folding the mirrors out once (▷ page 99).

### Charging the battery

#### WARNING

During charging and jump-starting, explosive gases can escape from the battery. There is a risk of an explosion.

Particularly avoid fire, open flames, creating sparks and smoking. Ensure there is sufficient ventilation while charging and jump-starting. Do not lean over a battery.

**⚠ WARNING**

Battery acid is caustic. There is a risk of injury. Avoid contact with skin, eyes or clothing. Do not inhale any battery gases. Do not lean over the battery. Keep children away from batteries. Wash away battery acid immediately with plenty of clean water and seek medical attention.

**⚠ WARNING**

A discharged battery can freeze at temperatures below freezing point. When jump-starting the vehicle or charging the battery, gases can escape from the battery. There is a risk of an explosion.

Allow the frozen battery to thaw out before charging it or jump-starting.

**!** Only use battery chargers with a maximum charging voltage of 14.8 V.

**!** Only charge the battery using the jump-starting connection point.

The jump-starting connection point is in the engine compartment (▷ page 293).

- ▶ Open the hood.
- ▶ Connect the battery charger to the positive terminal and ground point in the same order as when connecting the donor battery in the jump-starting procedure (▷ page 293).

If the indicator/warning lamps do not light up at low temperatures, it is very likely that the discharged battery has frozen. In this case you may neither jump-start the vehicle nor charge the battery. The service life of a thawed-out battery may be shorter. The starting characteristics can be impaired, particularly at low temperatures. Have the thawed-out battery checked at a qualified specialist workshop.

Only charge the installed battery with a battery charger which has been tested and approved by Mercedes-Benz. A battery charger unit specially adapted for Mercedes-Benz vehicles and tested and approved by

Mercedes-Benz is available as an accessory. It permits the charging of the battery in its installed position. Contact an authorized Mercedes-Benz Center for further information and availability. Read the battery charger's operating instructions before charging the battery.

## Jump-starting

For the jump-starting procedure, use only the jump-starting connection point, consisting of a positive terminal and a ground point, in the engine compartment.

### WARNING

Battery acid is caustic. There is a risk of injury.

Avoid contact with skin, eyes or clothing. Do not inhale any battery gases. Do not lean over the battery. Keep children away from batteries. Wash away battery acid immediately with plenty of clean water and seek medical attention.

### WARNING

During charging and jump-starting, explosive gases can escape from the battery. There is a risk of an explosion.

Particularly avoid fire, open flames, creating sparks and smoking. Ensure there is sufficient ventilation while charging and jump-starting. Do not lean over a battery.

### WARNING

During the charging process, a battery produces hydrogen gas. If a short circuit occurs or sparks are created, the hydrogen gas can ignite. There is a risk of an explosion.

- Make sure that the positive terminal of a connected battery does not come into contact with vehicle parts.
- Never place metal objects or tools on a battery.
- It is important that you observe the described order of the battery terminals when connecting and disconnecting a battery.
- When jump-starting, make sure that the battery poles with identical polarity are connected.
- It is particularly important to observe the described order when connecting and disconnecting the jumper cables.
- Never connect or disconnect the battery terminals while the engine is running.

### WARNING

A discharged battery can freeze at temperatures below freezing point. When jump-starting the vehicle or charging the battery, gases can escape from the battery. There is a risk of an explosion. Allow the frozen battery to thaw out before charging it or jump-starting.

**!** Avoid repeated and lengthy starting attempts. Otherwise, the catalytic converter could be damaged by the non-combusted fuel.

If the indicator/warning lamps do not light up at low temperatures, it is very likely that the discharged battery has frozen. In this case you may neither jump-start the vehicle nor charge the battery. Let the battery thaw first. The service life of a thawed-out battery may be shorter. The starting characteristics can be impaired, particularly at low temperatures. Have the thawed-out battery checked at a qualified specialist workshop.

Do not start the vehicle using a rapid charging device. If your vehicle's battery is discharged, the engine can be jump-started from another vehicle or from a second battery using jumper cables. Observe the following points:

- The battery is not accessible in all vehicles. If the other vehicle's battery is not accessible, jump-start the vehicle using a second battery or a jump-starting device.
- You may only jump-start the vehicle when the engine and exhaust system are cold.
- Do not start the engine if the battery is frozen. Let the battery thaw first.
- Only jump-start from batteries with a 12 V voltage rating.
- Only use jump leads that are not damaged and have a sufficient cross-section and insulated terminal clamps.
- Make sure that the two vehicles do not touch.

Make sure that:

- the jumper cables are not damaged.
- when the jumper cables are connected to the battery, uninsulated sections of the terminal clamp do not come into contact with other metal sections.
- the jumper cables cannot come into contact with parts which can move when the engine is running, such as the V-belt pulley or the fan.
- ▶ Secure the vehicle by applying the electric parking brake.
- ▶ Shift the transmission to position **P**.
- ▶ Turn the SmartKey to position **0** in the ignition lock and remove it.
- ▶ Switch off all electrical consumers, e.g. rear window defroster, lighting, etc.
- ▶ Open the hood.

### Roadside Assistance

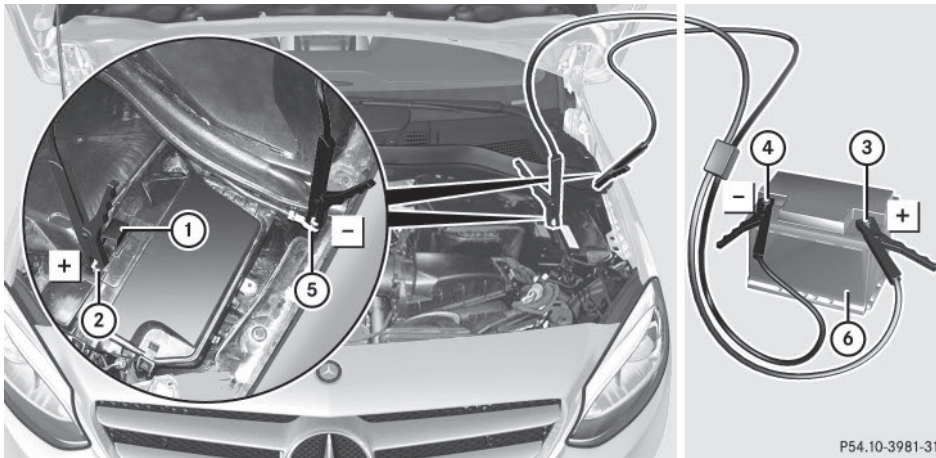

Position number ⑥ identifies the charged battery of the other vehicle or an equivalent jump-starting device.

- ▶ Press together cover ① of positive clamp ② and slide it back.
- ▶ Connect positive terminal ② on your vehicle to positive terminal ③ of donor battery ⑥ using the jumper cable, beginning with your own battery.



- ▶ Start the engine of the donor vehicle and run it at idling speed.
  - ▶ Connect negative terminal ④ of donor battery ⑥ to ground point ⑤ of your vehicle using the jumper cable, connecting the jumper cable to battery of other vehicle ⑥ first.
  - ▶ If the battery is fully discharged, leave the battery that is being used to jump-start connected for a few minutes before attempting to start. This charges the battery slightly.
  - ▶ Start the engine.
  - ▶ Before disconnecting the jumper cables, let the engine run for several minutes.
  - ▶ First, remove the jumper cables from ground point ⑤ and negative terminal ④, then from positive clamp ② and positive terminal ③. Begin each time at the contacts on your own vehicle first.
  - ▶ Close cover ① of positive terminal ② after removing the jumper cables.
  - ▶ Close the hood.
  - ▶ Have the battery checked at a qualified specialist workshop.
- i** Jump-starting is not considered to be a normal operating condition.
- i** Jumper cables and further information regarding jump-starting can be obtained at any qualified specialist workshop.

## Towing and tow-starting

### Important safety notes

#### WARNING

Functions relevant to safety are restricted or no longer available if:

- the engine is not running.
- the brake system or the power steering is malfunctioning.
- there is a malfunction in the voltage supply or the vehicle's electrical system.

If your vehicle is being towed, much more force may be necessary to steer or brake. There is a risk of an accident.

In such cases, use a tow bar. Before towing, make sure that the steering moves freely.

#### WARNING

You can no longer steer the vehicle if the steering wheel lock has been engaged. There is a risk of an accident.

Always switch off the ignition when towing the vehicle with a tow cable or a tow bar.

#### WARNING

When towing or tow-starting another vehicle and its weight is greater than the permissible gross weight of your vehicle, the:

- the towing eye could detach itself
- the vehicle/trailer combination could roll-over.

There is a risk of an accident.

When towing or tow-starting another vehicle, its weight should not be greater than the permissible gross weight of your vehicle.

Details on the permissible gross vehicle weight of your vehicle can be found on the vehicle identification plate (▷ page 334).

**!** When COLLISION PREVENTION ASSIST PLUS, DISTRONIC PLUS or the HOLD function is activated, the vehicle brakes automatically in certain situations. To avoid damage to the vehicle, deactivate these systems in the following or similar situations:

- when towing the vehicle
- in the car wash

**!** Make sure that the electric parking brake is released. If the electric parking brake is faulty, visit a qualified specialist workshop.

**!** Only secure the tow rope or tow bar at the towing eyes. Otherwise, the vehicle could be damaged.

**!** Do not use the towing eyes for recovery purposes as this could damage the vehicle. If in doubt, recover the vehicle with a crane.

**!** When towing, pull away slowly and smoothly. If the tractive power is too high, the vehicles could be damaged.

**!** The vehicle can be towed a maximum of 30 miles (50km). The towing speed of 30 mph (50km/h) must not be exceeded. If the vehicle has to be towed more than 30 miles (50km), the front axle must be raised or the entire vehicle raised and transported.

**!** Do not tow with sling-type equipment. This could damage the vehicle.

**!** When towing vehicles with KEYLESS-GO, use the key instead of the Start/Stop button. Otherwise, the automatic transmission may shift to position **P** when the driver's or front-passenger door are opened, which could lead to damage to the transmission.

**!** Vehicles with automatic transmission must not be started by tow-starting. This could otherwise damage the transmission.

It is better to have the vehicle transported than to have it towed away.

If the vehicle can no longer be driven because of an accident or breakdown, you have the following options:

- transporting the vehicle  
As a rule, you should have the vehicle transported.
- towing the vehicle with a tow rope or tow bar  
Only tow the vehicle in exceptional cases.

When towing a vehicle, the transmission must be in position **N**.

The battery must be connected and charged. Otherwise, you:

- cannot turn the SmartKey to position **2** in the ignition lock
- cannot release the electric parking brake
- cannot shift the transmission to position **N**

**i** The function of the electric parking brake and the parking lock is dependent on the on-board voltage.

If the on-board voltage is low or there is a system malfunction, it is possible that:

- the electric parking brake may not be applied in certain circumstances, or
- the transmission may not be shifted to **P**

**i** Switch off non-essential consumers, e.g. the radio.

**i** Disarm the automatic locking feature (▷ page 205). You could otherwise be locked out when pushing or towing the vehicle.

### Installing/removing the towing eye

#### Installing the towing eye

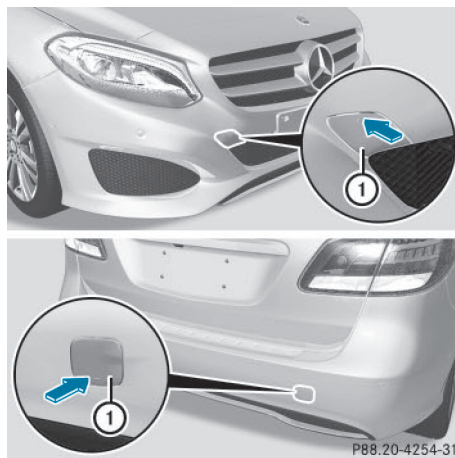

Example: towing eye mounting covers

- ▶ Remove the towing eye from the stowage space.  
The towing eye is located with the vehicle tool kit under the luggage compartment floor (▷ page 284).  
Vehicles with the TIREFIT kit: the towing eye is beneath the tire inflation compressor.
- ▶ Press the mark on cover ① inwards in the direction of the arrow.
- ▶ Take cover ① off the opening.
- ▶ Screw in the towing eye clockwise to the stop.

### Removing the towing eye

- ▶ Unscrew and remove the towing eye.
- ▶ Attach cover ① to the bumper and press until it engages.
- ▶ Place the towing eye in the stowage well (▷ page 284) beneath the cargo compartment floor in the cargo compartment.
- ▶ Vehicles with the TIREFIT kit: put back the tire inflation compressor.

### Towing the vehicle with the front axle raised

When towing your vehicle with the rear axle raised, it is important that you observe the safety instructions (▷ page 295).

**Only vehicles without 4MATIC can be towed with the front axle raised.**

**!** Vehicles with 4MATIC must not be towed with either the front or the rear axle raised, as doing so will damage the transmission.

Vehicles with 4MATIC may either be towed away with both axles on the ground or be loaded up and transported.

**!** The ignition must be switched off if the vehicle is being towed with the front axle raised. Otherwise, ESP® may intervene and damage the brake system.

- ▶ **On vehicles with KEYLESS-GO or the KEYLESS-GO start function:** you must use the SmartKey instead of the Start/Stop button (▷ page 136).
- ▶ Make sure that the vehicle is stationary.
- ▶ Turn the SmartKey to position **2** in the ignition lock.
- ▶ When the vehicle is stationary, depress the brake pedal and keep it depressed.
- ▶ Shift the automatic transmission to position **P**.
- ▶ Release the brake pedal.
- ▶ Release the electric parking brake.
- ▶ Switch off the automatic locking (▷ page 205).
- ▶ Switch on the hazard warning lamps (▷ page 107).
- ▶ Turn the SmartKey in the ignition lock to position **0** and leave the SmartKey in the ignition lock.

### Towing a vehicle with both axles on the ground

It is important that you observe the safety instructions when towing away your vehicle (▷ page 295).

- ▶ **On vehicles with KEYLESS-GO or the KEYLESS-GO start function:** you must use the SmartKey instead of the Start/Stop button (▷ page 136).

The automatic transmission automatically shifts to position **P** when you open the driver's or front-passenger door or when you remove the SmartKey from the ignition lock. In order to ensure that the automatic transmission stays in position **N** when towing the vehicle, you must observe the following points:

- ▶ Make sure that the vehicle is stationary.
- ▶ Turn the SmartKey to position **2** in the ignition lock.

- ▶ Depress and hold the brake pedal.
- ▶ Shift the automatic transmission to position **N**.
- ▶ Leave the SmartKey in position **2** in the ignition lock.
- ▶ Release the brake pedal.
- ▶ Release the electric parking brake.
- ▶ Switch on the hazard warning lamps (▷ page 107).

**i** In order to signal a change of direction when towing the vehicle with the hazard warning lamps switched on, use the combination switch as usual. In this case, only the indicator lamps for the direction of travel flash. After resetting the combination switch, the hazard warning lamp starts flashing again.

### Transporting the vehicle

**!** You may only secure the vehicle by the wheels, not by parts of the vehicle such as axle or steering components. Otherwise, the vehicle could be damaged.

- ▶ Turn the SmartKey to position **2** in the ignition lock (▷ page 135).
- ▶ Shift the transmission to position **N**.

### As soon as the vehicle has been loaded:

- ▶ Prevent the vehicle from rolling away by applying the electric parking brake.
- ▶ Shift the transmission to position **P**.
- ▶ Turn the SmartKey to position **0** in the ignition lock and remove it.
- ▶ Secure the vehicle.

The towing eye can be used to pull the vehicle onto a trailer or transporter for transporting purposes.

### Notes on 4MATIC vehicles

**!** Vehicles with 4MATIC must not be towed with either the front or the rear axle raised, as doing so will damage the transmission.

Vehicles with 4MATIC may only either be towed away with both axles on the ground or be loaded up and transported.

If the vehicle's transmission, front, or rear axle is damaged, have the vehicle transported on a truck or trailer.

### In the event of damage to the electrical system:

If the battery is defective, the automatic transmission will be locked in position **P**. To shift the automatic transmission to position **N**, you must provide power to the vehicle's electrical system in the same way as when jump-starting (▷ page 293).

Have the vehicle transported on a transporter or trailer.

### Tow-starting (emergency engine starting)

**!** Vehicles with automatic transmission must not be tow-started. You could otherwise damage the automatic transmission.

**i** You can find information on "Jump-starting" under (▷ page 293).

## Fuses

### Important safety notes

#### WARNING

If you manipulate or bridge a faulty fuse or if you replace it with a fuse with a higher amperage, the electric cables could be overloaded. This could result in a fire. There is a risk of an accident and injury.

Always replace faulty fuses with the specified new fuses having the correct amperage.

Blown fuses must be replaced with fuses of the same rating, which you can recognize by the color and value. The fuse ratings are listed in the fuse allocation chart.

If a newly inserted fuse also blows, have the cause traced and rectified at a qualified specialist workshop, e.g. an authorized Mercedes-Benz Center.

**!** Only use fuses that have been approved for Mercedes-Benz vehicles and which have the correct fuse rating for the system concerned. Only use fuses marked with an "S". Otherwise, components or systems could be damaged.

The fuses in your vehicle serve to close down faulty circuits. If a fuse blows, all the components on the circuit and their functions stop operating.

Blown fuses must be replaced with fuses of the same rating, which you can recognize by the color and value. The fuse ratings are listed in the fuse allocation chart.

If a newly inserted fuse also blows, have the cause traced and rectified at a qualified specialist workshop, e.g. an authorized Mercedes-Benz Center.

#### Before changing a fuse

- ▶ Secure the vehicle against rolling away (> page 152).
- ▶ Switch off all electrical consumers.
- ▶ **Vehicles without KEYLESS-GO:** remove the SmartKey from the ignition lock.
- ▶ **Vehicles with KEYLESS-GO start-function or KEYLESS-GO:** open the driver's door.  
The on-board electronics now have status **0**. This is the same as the SmartKey having been removed.

The fuses are located in various fuse boxes:

- Fuse box in the engine compartment on the left-hand side of the vehicle, when viewed in the direction of travel

- Fuse box in the front-passenger footwell

The fuse allocation chart is on the fuse box in the front-passenger footwell (> page 300).

#### Fuse box in the engine compartment

##### **⚠ WARNING**

When the hood is open and the windshield wipers are set in motion, you can be injured by the wiper linkage. There is a risk of injury.

Always switch off the windshield wipers and the ignition before opening the hood.

- !** Make sure that no moisture can enter the fuse box when the cover is open.

- !** When closing the cover, make sure that it is lying correctly on the fuse box. Moisture seeping in or dirt could otherwise impair the operation of the fuses.

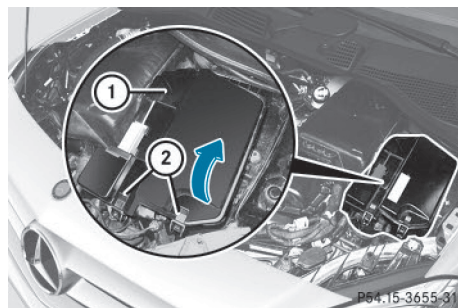

- ▶ Open the hood.
- ▶ Use a dry cloth to remove any moisture from the fuse box.
- ▶ **To open:** open clamps ②.
- ▶ Fold up cover ① in the direction of the arrow and remove it.

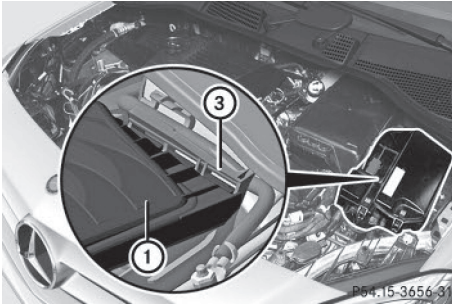

- ▶ **To close:** check whether the seal is lying correctly in cover ①.
- ▶ Insert cover ① at the back into openings ③ on the fuse box.
- ▶ Fold down cover ①.
- ▶ Hook clamps ② into the fuse box and close.
- ▶ Close the hood.

#### Fuse box in the front-passenger footwell

- ❗ Make sure that no moisture can enter the fuse box when the cover is open.
- ❗ When closing the cover, make sure that it is lying correctly on the fuse box. Moisture seeping in or dirt could otherwise impair the operation of the fuses.



- ▶ **To open:** open the front-passenger door.
- ▶ Remove the floormat.
- ▶ Fold out perforated floor covering ① in the direction of the arrow.

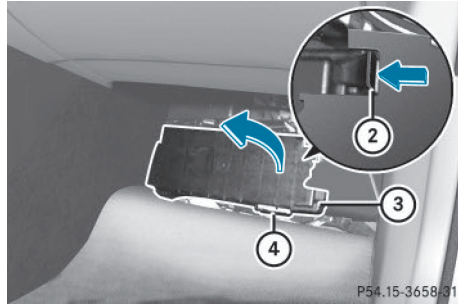

- ▶ To release cover ③, press retaining clamp ②.
- ▶ Fold out cover ③ in the direction of the arrow to the catch.
- ▶ Remove cover ③ forwards.
- ❗ Fuse allocation chart ④ is located on the lower right-hand side of cover ③.
- ▶ **To close:** insert cover ③ on the left-hand side of the fuse box into the retainer. Cover ③ engages in the retainers.
- ▶ Fold down cover ③ until clamps ② lock audibly.
- ▶ Fold back perforated floor covering ①.
- ▶ Install the floor mats.

Useful information .....	302
Important safety notes .....	302
Operation .....	302
Winter operation .....	304
Tire pressure .....	305
Loading the vehicle .....	310
All about wheels and tires .....	314
Changing a wheel .....	322
Wheel and tire combinations .....	326
Emergency spare wheel .....	329

### Useful information

- i** This Operator's Manual describes all models and all standard and optional equipment of your vehicle available at the time of publication of the Operator's Manual. Country-specific differences are possible. Please note that your vehicle may not be equipped with all features described. This also applies to safety-related systems and functions.
- i** Read the information on qualified specialist workshops (▷ page 24).

### Important safety notes

#### WARNING

If wheels and tires of the wrong size are used, the wheel brakes or suspension components may be damaged. There is a risk of an accident.

Always replace wheels and tires with those that fulfill the specifications of the original part.

When replacing wheels, make sure to use the correct:

- designation
- model

When replacing tires, make sure to use the correct:

- designation
- manufacturer
- model

#### WARNING

A flat tire severely impairs the driving, steering and braking characteristics of the vehicle. There is a risk of accident.

Tires without run-flat characteristics:

- do not drive with a flat tire.
- immediately replace the flat tire with your emergency spare wheel or spare wheel, or consult a qualified specialist workshop.

Tires with run-flat characteristics:

- pay attention to the information and warning notices on MOExtended tires (tires with run-flat characteristics).

Accessories that are not approved for your vehicle by Mercedes-Benz or are not being used correctly can impair the operating safety.

Before purchasing and using non-approved accessories, visit a qualified specialist workshop and inquire about:

- suitability
- legal stipulations
- factory recommendations

Information on the sizes and types of wheels and tires for your vehicle can be found under "Wheel/tire combinations" (▷ page 326).

Information on tire pressure can be found:

- on the vehicle's Tire and Loading Information placard on the B-pillar (▷ page 310)
- on the tire pressure label on the fuel filler flap (▷ page 151)
- under "Tire pressure" (▷ page 305)

### Operation

#### Information on driving

Check the tire pressure when the vehicle is heavily laden and adjust prior to a trip.

While driving, pay attention to vibrations, noises and unusual handling characteristics, e.g. pulling to one side. This may indicate that the wheels or tires are damaged. If you suspect that a tire is defective, reduce your speed immediately. Stop the vehicle as soon as possible to check the wheels and tires for damage. Hidden tire damage could also be causing the unusual handling characteristics. If you find no signs of damage, have the tires and wheels checked at a qualified specialist workshop.

When parking your vehicle, make sure that the tires do not get deformed by the curb or



other obstacles. If it is necessary to drive over curbs, speed humps or similar elevations, try to do so slowly and at an obtuse angle. Otherwise, the tires, particularly the sidewalls, may be damaged.

### Regular checking of wheels and tires

#### WARNING

Damaged tires can cause tire inflation pressure loss. As a result, you could lose control of your vehicle. There is a risk of accident.

Check the tires regularly for signs of damage and replace any damaged tires immediately.

Regularly check the wheels and tires of your vehicle for damage at least once a month, as well as after driving off-road or on rough roads. Damaged wheels can cause a loss of tire pressure. Pay particular attention to damage such as:

- cuts in the tires
- punctures
- tears in the tires
- bulges on tires
- deformation or severe corrosion on wheels

Regularly check the tire tread depth and the condition of the tread across the whole width of the tire (▷ page 303). If necessary, turn the front wheels to full lock in order to inspect the inner side of the tire surface.

All wheels must have a valve cap to protect the valve against dirt and moisture. Do not mount anything onto the valve other than the standard valve cap or other valve caps approved by Mercedes-Benz for your vehicle. Do not use any other valve caps or systems, e.g. tire pressure monitoring systems.

Regularly check the pressure of all the tires particularly prior to long trips. Adjust the tire pressure as necessary (▷ page 305).

Observe the notes on the emergency spare wheel (▷ page 329).

The service life of tires depends, among other things, on the following factors:

- Driving style
- Tire pressure
- Distance covered

### Notes on tire tread

#### WARNING

Insufficient tire tread will reduce tire traction. The tire is no longer able to dissipate water. This means that on wet road surfaces, the risk of hydroplaning increases, in particular where speed is not adapted to suit the driving conditions. There is a risk of accident.

If the tire pressure is too high or too low, tires may exhibit different levels of wear at different locations on the tire tread. Thus, you should regularly check the tread depth and the condition of the tread across the entire width of all tires.

Minimum tire tread depth for:

- Summer tires:  $\frac{1}{8}$  in (3 mm)
- M+S tires:  $\frac{1}{6}$  in (4 mm)

For safety reasons, replace the tires before the legally prescribed limit for the minimum tire tread depth is reached.

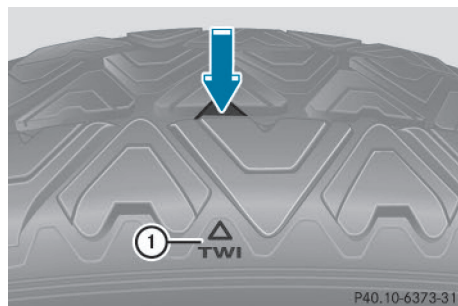

Marking ① shows where the bar indicator (arrow) for tread wear is integrated into the tire tread.

Treadwear indicators (TWI) are required by law. Six indicators are positioned on the tire tread. They are visible once a tread depth of

approximately  $\frac{1}{16}$  in (1.6 mm) has been reached. If this is the case, the tire is so worn that it must be replaced.

### Selecting, mounting and replacing tires

- Only mount tires and wheels of the same type and make.  
Exception: it is permissible to install a different type or make in the event of a flat tire. Observe here the "MOExtended tires (tires with run-flat characteristics)" section (▷ page 285).
- Only mount tires of the correct size onto the wheels.
- Break in new tires at moderate speeds for the first 60 miles (100 km). They only reach their full performance after this distance.
- Do not drive with tires which have too little tread depth, as this significantly reduces the traction on wet roads (hydroplaning).
- Replace the tires after six years at the latest, regardless of wear.

Observe the notes on the emergency spare wheel (▷ page 329).

### MOExtended tires (tires with run-flat properties)

With MOExtended tires (tires with run flat characteristics), you can continue to drive your vehicle even if there is a total loss of pressure in one or more tires.

MOExtended tires may only be used in conjunction with an active tire pressure loss warning system and only on wheels specifically tested by Mercedes-Benz.

Notes on driving with MOExtended tires with a flat tire (▷ page 285).

Vehicles equipped with MOExtended tires are not equipped with a TIREFIT kit at the factory. It is therefore recommended that you additionally equip your vehicle with a TIREFIT kit if you mount tires that do not feature run-flat

properties, e.g. winter tires. A TIREFIT kit may be obtained from a qualified specialist workshop.

### Winter operation

#### General notes

Have your vehicle winter-proofed at a qualified specialist workshop at the onset of winter.

Observe the notes in the "Changing a wheel" section (▷ page 322).

#### Driving with summer tires

At temperatures below 45 °F (+7 °C), summer tires lose elasticity and therefore traction and braking power. Change the tires on your vehicle to M+S tires. Using summer tires at very cold temperatures could cause cracks to form, thereby damaging the tires permanently. Mercedes-Benz cannot accept responsibility for this type of damage.

#### WARNING

Damaged tires can cause tire inflation pressure loss. As a result, you could lose control of your vehicle. There is a risk of accident.

Check the tires regularly for signs of damage and replace any damaged tires immediately.

#### M+S tires

#### WARNING

M+S tires with a tire tread depth of less than  $\frac{1}{8}$  in (4 mm) are not suitable for use in winter and do not provide sufficient traction. There is a risk of an accident.

M+S tires with a tread depth of less than  $\frac{1}{8}$  in (4 mm) must be replaced immediately.

At temperatures below 45 °F (+7 °C), use winter tires or all-season tires. Both types of tire are identified by the M+S marking.

Only winter tires bearing the  snowflake symbol in addition to the M+S marking provide the best possible grip in wintry road conditions. Only these tires will allow driving safety systems such as ABS and ESP® to function optimally in winter. These tires have been developed specifically for driving in snow.

Use M+S tires of the same make and tread on all wheels to maintain safe handling characteristics.

Always observe the maximum permissible speed specified for the M+S tires you have mounted.

When you have mounted the M+S tires:

- ▶ Check the tire pressures (▷ page 305).
- ▶ Restart the tire pressure loss warning system (Canada). (▷ page 309)

Information about driving with an emergency spare wheel (▷ page 329).

### Snow chains

#### WARNING

If snow chains are mounted on the rear wheels, the snow chains could cause abrasion to the vehicle body or to chassis components. This could cause damage to the vehicle or the tires. There is a risk of an accident.

To avoid hazardous situations:

- never mount snow chains on the rear wheels
- only mount snow chains in pairs on the front wheels.

**I** On some tire sizes there is not enough space for snow chains. To avoid damage to the vehicle or tires, observe the "Wheel and tire combinations" section under "Tires and wheels".

For safety reasons, Mercedes-Benz recommends that you only use snow chains that have been specially approved for your vehicle by Mercedes-Benz, or are of a corresponding

standard of quality. For more information, please contact a qualified specialist workshop.

If you intend to mount snow chains, please bear the following points in mind:

- Snow chains may not be mounted on all wheel/tire combinations. Permissible wheel-tire combinations (▷ page 326).
- Only use snow chains when driving on roads completely covered by snow. Remove the snow chains as soon as possible when you come to a road that is not snow-covered.
- Local regulations may restrict the use of snow chains. Observe the appropriate regulations if you wish to mount snow chains.
- Do not exceed the maximum permissible speed of 30 mph (50 km/h).
- When snow chains are installed, never use Active Parking Assist (▷ page 175).

You may wish to deactivate ESP® when pulling away with snow chains installed (▷ page 64). You can thereby allow the wheels to spin in a controlled manner, achieving an increased driving force (cutting action).

Information about driving with an emergency spare wheel (▷ page 329).

### Tire pressure

#### Tire pressure specifications

#### Important safety notes

#### WARNING

Underinflated or overinflated tires pose the following risks:

- the tires may burst, especially as the load and vehicle speed increase.
- the tires may wear excessively and/or unevenly, which may greatly impair tire traction.
- the driving characteristics, as well as steering and braking, may be greatly impaired.

There is a risk of an accident.

Follow recommended tire inflation pressures and check the pressure of all the tires including the spare wheel:

- monthly, at least
- if the load changes
- before beginning a long journey
- under different operating conditions, e.g. off-road driving

If necessary, correct the tire pressure.

**i** The specifications on the sample Tire and Loading Information placard and tire pressure tables are examples. Tire pressure specifications are vehicle-specific and may deviate from the data shown here. The tire pressure specifications that are valid for your vehicle can be found on the Tire and Loading Information placard and tire pressure table on the vehicle.

### General notes

The recommended tire pressures for the tires mounted at the factory can be found on the labels described here.

**Operation with the emergency spare wheel** (▷ page 329).

Further information on tire pressures can be obtained at a qualified specialist workshop.

### Tire and Loading Information placard

**TIRE AND LOADING INFORMATION**  
RENSEIGNEMENTS SUR LES PNEUS ET LE CHARGEMENT

SEATING CAPACITY / NOMBRE DE PLACES: TOTAL 7, FRONT 2, MIDDLE 3, REAR 2

The combined weight of occupants and cargo should never exceed 1000 kg or 2200 lbs. The weight distribution is also important. For more information, see the owner's manual.

TIRE / PNEU	SIZE / DIMENSIONS	COLD TIRE PRESSURE / PRESSION DES PNEUS A FROID
FRONT / AVANT	255/40 ZR18 99Y XL	200 kPa, 29 PSI
REAR / ARRIERE	285/35 ZR18 101Y XL	200 kPa, 29 PSI
SPARE / DE SECOURS	175/55-18 95P	420 kPa, 60 PSI

SEE OWNER'S MANUAL FOR ADDITIONAL INFORMATION. VOIR LE MANUEL DE L'USAGER POUR PLUS DE RENSEIGNEMENTS.

P40.00-2223-31

**1** Recommended tire pressures

The Tire and Loading Information placard is on the B-pillar on the driver's side (▷ page 310).

The Tire and Loading Information placard contains the recommended tire pressures for cold tires. The recommended tire pressures are valid for the maximum permissible load and up to the maximum permissible vehicle speed.

### Tire pressure table

The tire pressure table is on the inside of the fuel filler flap.

**COLD TIRE PRESSURE**

normal load

maximum load

Warm tires up to: + 4 psi

A 212 584 00 15

P40.00-2229-31

Example: tire pressure table for all tires permitted for this vehicle by the factory

The tire pressure table contains the recommended pressures for cold tires for various operating conditions, i.e. differing load and speed conditions.

**LUFTDRUCK PRESSURE PRESSION PRESSION**

für kalte Reifen für cold tires des pneus froids de l'infado

100 kPa = 1 bar

Tire Size	Partially Laden (kPa/PSI)	Fully Laden (kPa/PSI)
195/55 R16	200/29	250/36
215/45 R17	200/29	250/36
215/40 R18	200/29	250/36

Warme Reifen: Warm tires up to: + 30 kPa / + 4 psi

Pneus échauffés jusqu'à: Neumáticos calientes hasta:

A 109 584 50 17

P40.00-2228-31

Example: tire pressure table with tire dimensions

If a tire size precedes a tire pressure, the tire pressure information following is only valid for that tire size. The load conditions "partially laden" and "fully laden" are defined in the table for different numbers of occupants and amounts of luggage. The actual number of seats may differ.

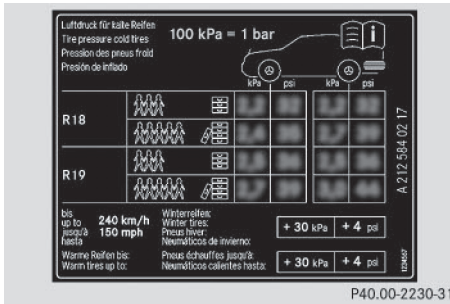

Some tire pressure tables show only the rim diameters instead of the full tire size, e.g. **R18**. Rim diameter is part of the tire size and can be found on the tire sidewall (▷ page 316).

If the tire pressures have been set to the lower values for lighter loads and/or lower road speeds, the pressures should be reset to the higher values:

- if you want to drive with an increased load and/or
- if you want to drive at higher road speeds

**i** The tire pressures for increased loads and/or higher road speeds, shown in the tire pressure table, may have a negative effect on driving comfort.

If the tire pressure is not set correctly, this can lead to an excessive build up of heat and a sudden loss of pressure.

For more information, contact a qualified specialist workshop.

### Important notes on tire pressure

#### **⚠ WARNING**

If the tire pressure drops repeatedly, the wheel, valve or tire may be damaged. Tire pressure that is too low may result in a tire blow-out. There is a risk of an accident.

- Check the tire for foreign objects.
- Check whether the wheel is losing air or the valve is leaking.

If you are unable to rectify the damage, contact a qualified specialist workshop.

#### **⚠ WARNING**

If you fit unsuitable accessories onto tire valves, the tire valves may be overloaded and malfunction, which can cause tire pressure loss. Due to their design, retrofitted tire pressure monitors keep the tire valve open. This can also result in tire pressure loss. There is a risk of an accident.

Only screw the standard valve cap or other valve caps approved by Mercedes-Benz for your vehicle onto the tire valve.

Use a suitable pressure gauge to check the tire pressure. The outer appearance of a tire does not permit any reliable conclusion about the tire pressure. On vehicles equipped with the electronic tire pressure monitor, the tire pressure can be checked in the on-board computer.

The tire temperature and pressure increase when the vehicle is in motion. This is dependent on the driving speed and the load.

Therefore, you should only correct tire pressures when the tires are cold.

The tires are cold:

- if the vehicle has been parked with the tires out of direct sunlight for at least three hours and
- if the vehicle has not been driven further than 1 mile (1.6 km)

The tire temperature changes depending on the outside temperature, the vehicle speed and the tire load. If the tire temperature changes by 18 °F (10 °C), the tire pressure changes by approximately 10 kPa (0.1 bar/ 1.5 psi). Take this into account when checking the pressure of warm tires. Only correct the tire pressure if it is too low for the current operating conditions. If you check the tire pressure when the tires are warm, the resulting value will be higher than if the tires were cold. This is normal. Do not reduce the tire

pressure to the value specified for cold tires. The tire pressure would otherwise be too low. Observe the recommended tire pressures for cold tires:

- on the Tire and Loading Information placard on the B-pillar on the driver's side
- in the tire pressure table on the inside of the fuel filler flap (▷ page 151)

### Underinflated or overinflated tires

#### Underinflated tires

##### WARNING

Tires with pressure that is too low can overheat and burst as a consequence. In addition, they also suffer from excessive and/or irregular wear, which can severely impair the braking properties and the driving characteristics. There is a risk of an accident.

Avoid tire pressures that are too low in all the tires, including the spare wheel.

Underinflated tires may:

- overheat, leading to tire defects
- adversely affect handling
- wear excessively and/or unevenly
- have an adverse effect on fuel consumption

#### Overinflated tires

##### WARNING

Tires with excessively high pressure can burst because they are damaged more easily by road debris, potholes etc. In addition, they also suffer from irregular wear, which can severely impair the braking properties and the driving characteristics. There is a risk of an accident.

Avoid tire pressures that are too high in all the tires, including the spare wheel.

Overinflated tires may:

- increase the braking distance
- adversely affect handling

- wear excessively and/or unevenly
- have an adverse effect on ride comfort
- be more susceptible to damage

### Maximum tire pressures

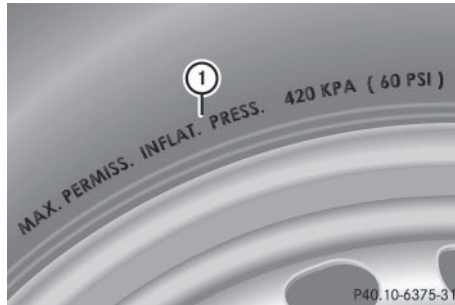

- ① Example: maximum permissible tire pressure

Never exceed the maximum permissible tire inflation pressure. Always observe the recommended tire pressure for your vehicle when adjusting the tire pressure (▷ page 305).

- i** The actual values for tires are vehicle-specific and may deviate from the values in the illustration.

### Checking the tire pressures

#### Important safety notes

Observe the notes on tire pressure (▷ page 305).

Information on air pressure for the tires on your vehicle can be found:

- on the vehicle's Tire and Loading Information placard on the B-pillar
- on the tire pressure label on the fuel filler flap (▷ page 151)
- in the "Tire pressure" section

### Checking tire pressures manually

To determine and set the correct tire pressure, proceed as follows:

- ▶ Remove the valve cap of the tire that is to be checked.
- ▶ Press the tire pressure gauge securely onto the valve.
- ▶ Read the tire pressure and compare it to the recommended value on the Tire and Loading Information placard or the tire pressure table (▷ page 305).
- ▶ If the tire pressure is too low, increase the tire pressure to the recommended value.
- ▶ If the tire pressure is too high, release air. To do so, press down the metal pin in the valve, using the tip of a pen for example. Then check the tire pressure again using the tire pressure checker.
- ▶ Screw the valve cap onto the valve.
- ▶ Repeat these steps for the other tires.

### Tire pressure loss warning system

#### General notes

While the vehicle is in motion, the tire pressure loss warning system monitors the set tire pressure using the rotational speed of the wheels. This enables the system to detect significant pressure loss in a tire. If the speed of rotation of a wheel changes as a result of a loss of pressure, a corresponding warning message will appear in the multifunction display.

You can recognize the tire pressure loss warning in the multifunction display in the [Serv.](#) menu, by the [Run Flat Indicator Active Press 'OK' to Restart](#) message. Further information on displaying this message can be found under "Restarting the tire pressure loss warning system" (▷ page 309).

### Important safety notes

The tire pressure warning system does not warn you of an incorrectly set tire pressure. Observe the notes on the recommended tire pressure (▷ page 305).

The tire pressure loss warning does not replace the need to regularly check the tire pressure. An even loss of pressure on several tires at the same time cannot be detected by the tire pressure loss warning system.

The tire pressure monitor is not able to warn you of a sudden loss of pressure, e.g. if the tire is penetrated by a foreign object. In the event of a sudden loss of pressure, bring the vehicle to a halt by braking carefully. Avoid abrupt steering maneuvers.

The function of the tire pressure loss warning system is limited or delayed if:

- snow chains are mounted on your vehicle's tires.
- road conditions are wintry.
- you are driving on sand or gravel.
- you adopt a very sporty driving style (cornering at high speeds or driving with high rates of acceleration).
- you are driving with a heavy load (in the vehicle or on the roof).





### Restarting the tire pressure loss warning system

Restart the tire pressure loss warning system if you have:





- changed the tire pressure
  - changed the wheels or tires
  - mounted new wheels or tires
- ▶ Before restarting, make sure that the tire pressures are set properly on all four tires for the respective operating conditions.

The recommended tire pressure can be found on the Tire and Loading Information placard on the B-pillar. Additionally, a tire pressure table is attached to the fuel filler flap. The tire pressure loss warning system can only give reliable warnings if you have

set the correct tire pressure. If an incorrect tire pressure is set, these incorrect values will be monitored.





- ▶ Also observe the notes in the section on tire pressures (▷ page 305).
- ▶ Make sure that the SmartKey is in position 2 in the ignition lock (▷ page 135).
- ▶ Press  or  on the steering wheel to select the **Serv.** menu.
- ▶ Press the  or  button to select **Tire Pressure**.
- ▶ Press the  button.  
The **Run Flat Indicator active Restart with OK** message appears in the multifunction display.

#### If you wish to confirm the restart:

- ▶ Press the  button.  
The **Tire Pressure Now OK?** message appears in the multifunction display.
- ▶ Press the  or  button to select **Yes**.
- ▶ Press the  button.  
The **Run Flat Indicator restarted** message appears in the multifunction display.

After a teach-in period, the tire pressure loss warning system will monitor the set tire pressures of all four tires.

#### If you wish to cancel the restart:

- ▶ Press the  button.
- or
- ▶ If the **Tire Pressure Now OK?** message appears, press the  or  button to select **Cancel**.
- ▶ Press the  button.  
The tire pressure values stored at the last restart will continue to be monitored.

## Loading the vehicle

### Instruction labels for tires and loads

#### **WARNING**

Overloaded tires can overheat, causing a blowout. Overloaded tires can also impair the steering and driving characteristics and lead to brake failure. There is a risk of accident.

Observe the load rating of the tires. The load rating must be at least half of the GAWR of your vehicle. Never overload the tires by exceeding the maximum load.

Two instruction labels on your vehicle show the maximum possible load.

- (1) The Tire and Loading Information placard is on the B-pillar on the driver's side. The Tire and Loading Information placard shows the maximum permissible number of occupants and the maximum permissible vehicle load. It also contains details of the tire sizes and corresponding pressures for tires mounted at the factory.
- (2) The vehicle identification plate is on the B-pillar on the driver's side. The vehicle identification plate informs you of the gross vehicle weight rating. It is made up of the vehicle weight, all vehicle occupants, the fuel and the cargo. You can also find information about the maximum gross axle weight rating on the front and rear axle.

The maximum gross axle weight rating is the maximum weight that can be carried by one axle (front or rear axle). Never exceed the maximum load or the maximum gross axle weight rating for the front or rear axle.



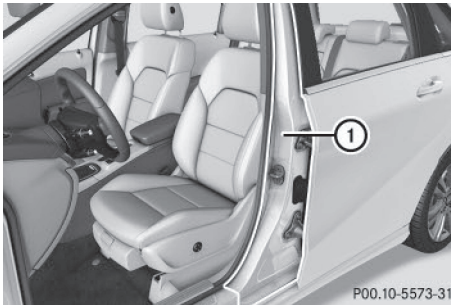

① B-pillar, driver's side

### Maximum permissible gross vehicle weight rating

TIRE RENSEIGNEMENT SUR LES PNEUS ET LE CHARGEMENT		TIRE LOADING INFORMATION	
SEATING CAPACITY / NOMBRE DE PLACES	TOTAL	FRONT / AVANT	MIDDLE / MILIEU
The combined weight of occupants and cargo should never exceed XXX kg or XXX lbs. / Le poids total des occupants et du chargement ne doit jamais dépasser XXX kg ou XXX lbs.			
TIRE PNEU	SIZE DIMENSIONS	COLD TIRE PRESSURE / PRESSION DES PNEUS A FROID	SEE OWNER'S MANUAL FOR ADDITIONAL INFORMATION / VOIR LE MANUEL DE L'USAGER POUR PLUS DE RENSEIGNEMENTS
FRONT AVANT	255/40 ZR18 99Y XL	200 KPA, 29 PSI	
REAR ARRIERE	285/35 ZR18 101Y XL	200 KPA, 29 PSI	
SPARE DE SECOURS	175/55-18 95P	420 KPA, 60 PSI	

P40.00-2224-31

- Specification for maximum gross vehicle weight ① is listed in the Tire and Loading Information placard: "The combined weight of occupants and cargo should never exceed XXX kilograms or XXX lbs."

The gross weight of all vehicle occupants, load and luggage must not exceed the specified value.

- ① The specifications shown on the Tire and Loading Information placard in the illustration are examples. The maximum permissible gross vehicle weight rating is vehicle-specific and may differ from that in the illustration. You can find the valid maximum permissible gross vehicle weight rating for your vehicle on the Tire and Loading Information placard.

### Number of seats

TIRE RENSEIGNEMENT SUR LES PNEUS ET LE CHARGEMENT		TIRE LOADING INFORMATION	
SEATING CAPACITY / NOMBRE DE PLACES	TOTAL	FRONT / AVANT	MIDDLE / MILIEU
The combined weight of occupants and cargo should never exceed XXX kg or XXX lbs. / Le poids total des occupants et du chargement ne doit jamais dépasser XXX kg ou XXX lbs.			
TIRE PNEU	SIZE DIMENSIONS	COLD TIRE PRESSURE / PRESSION DES PNEUS A FROID	SEE OWNER'S MANUAL FOR ADDITIONAL INFORMATION / VOIR LE MANUEL DE L'USAGER POUR PLUS DE RENSEIGNEMENTS
FRONT AVANT	255/40 ZR18 99Y XL	200 KPA, 29 PSI	
REAR ARRIERE	285/35 ZR18 101Y XL	200 KPA, 29 PSI	
SPARE DE SECOURS	175/55-18 95P	420 KPA, 60 PSI	

P40.00-2225-31

Maximum number of seats ① indicates the maximum number of occupants allowed to travel in the vehicle. This information can be found on the Tire and Loading Information placard.

- ① The specifications shown on the Tire and Loading Information placard in the illustration are examples. The number of seats is vehicle-specific and can differ from the details shown. The number of seats in your vehicle can be found on the Tire and Loading Information placard.

### Determining the correct load limit

#### Step-by-step instructions

The following steps have been developed as required of all manufacturers under Title 49, Code of U.S. Federal Regulations, Part 575 pursuant to the "National Traffic and Motor Vehicle Safety Act of 1966".

- **Step 1:** Locate the statement "The combined weight of occupants and cargo should never exceed XXX kg or XXX lbs." on your vehicle's Tire and Loading Information placard.
- **Step 2:** Determine the combined weight of the driver and passengers that will be riding in your vehicle.
- **Step 3:** Subtract the combined weight of the driver and passengers from XXX kilograms or XXX lbs.

- ▶ **Step 4:** The resulting figure equals the available amount of cargo and luggage load capacity. For example, if the "XXX" amount equals 1400 lbs and there will be five 150-lb passengers in your vehicle, the amount of available cargo and luggage load capacity is 650 lbs ( $1400 - 750 (5 \times 150) = 650$  lbs).
- ▶ **Step 5:** Determine the combined weight of luggage and cargo being loaded on the vehicle. That weight may not safely exceed the available cargo and luggage load capacity calculated in step 4.

**Example: steps 1 to 3**

The following table shows examples on how to calculate total and cargo load capacities with varying seating configurations and number and size of occupants. The following examples use a load limit of 1500 lbs (680 kg). **This is for illustration purposes only.** Make sure you are using the actual load limit for your vehicle stated on your vehicle's Tire and Loading Information placard (▷ page 310).

The greater the combined weight of the occupants, the lower the maximum luggage load.

**Step 1**

	Example 1	Example 2	Example 3
<b>Combined maximum weight of occupants and cargo (data from the Tire and Loading Information placard)</b>	1500 lbs (680 kg)	1500 lbs (680 kg)	1500 lbs (680 kg)

**Step 2**

	Example 1	Example 2	Example 3
<b>Number of people in the vehicle (driver and occupants)</b>	5	3	1
<b>Distribution of the occupants</b>	Front: 2 Rear: 3	Front: 1 Rear: 2	Front: 1
<b>Weight of the occupants</b>	Occupant 1: 150 lbs (68 kg) Occupant 2: 180 lbs (82 kg) Occupant 3: 160 lbs (73 kg) Occupant 4: 140 lbs (63 kg) Occupant 5: 120 lbs (54 kg)	Occupant 1: 200 lbs (91 kg) Occupant 2: 190 lbs (86 kg) Occupant 3: 150 lbs (68 kg)	Occupant 1: 150 lbs (68 kg)
<b>Gross weight of all occupants</b>	750 lbs (340 kg)	540 lbs (245 kg)	150 lbs (68 kg)

## Step 3

	Example 1	Example 2	Example 3
<b>Permissible load (maximum gross vehicle weight rating from the Tire and Loading Information placard minus the gross weight of all occupants)</b>	1500 lbs (680 kg) - 750 lbs (340 kg) = 750 lbs (340 kg)	1500 lbs (680 kg) - 540 lbs (245 kg) = =960 lbs (435 kg)	1500 lbs (680 kg) - 150 lbs (68 kg) = 1350 lbs (612 kg)

## Vehicle identification plate

Even if you have calculated the total cargo carefully, you should still make sure that the gross vehicle weight rating and the gross axle weight rating are not exceeded. Details can be found on the vehicle identification plate on the B-pillar on the driver's side of the vehicle (▷ page 310).

**Permissible Gross Vehicle Weight Rating (GVWR):** the gross weight of the vehicle, all passengers, load and trailer load/noseweight (if applicable) must not exceed the permissible gross vehicle weight.

**Gross Axle Weight Rating (GAWR):** the maximum permissible weight that can be carried by one axle (front or rear axle).

To ensure that your vehicle does not exceed the maximum permissible values (gross vehicle weight and maximum gross axle weight rating), have your loaded vehicle (including driver, occupants, cargo, and full trailer load if applicable) weighed on a suitable vehicle weighbridge.

## All about wheels and tires

## Uniform Tire Quality Grading Standards

## Overview of Tire Quality Grading Standards

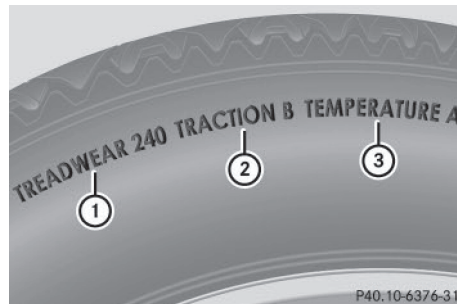

Uniform Tire Quality Grading Standards are U.S. government specifications. Their purpose is to provide drivers with uniform reliable information on tire performance data. Tire manufacturers have to grade tires using three performance factors: ① tread wear grade, ② traction grade and ③ temperature grade. These regulations do not apply to Canada. Nevertheless, all tires sold in North America are provided with the corresponding quality grading markings on the sidewall of the tire. Quality grades can be found, where applicable, on the tire sidewall between tread shoulder and maximum section width.

Example:

- **Treadwear grade:** 200
- **Traction grade:** AA
- **Temperature grade:** A

All passenger car tires must conform to the statutory safety requirements in addition to these grades.

- i** The actual values for tires are vehicle-specific and may deviate from the values in the illustration.

### Treadwear

The treadwear grade is a comparative rating based on the wear rate of the tire when tested under controlled conditions on a specified U.S. government course. For example, a tire graded 150 would wear one and one-half times as well on the government course as a tire graded 100.

The relative performance of tires depends upon the actual conditions of their use, however, and may depart significantly from the norm due to variations in driving habits, service practices and differences in road characteristics and climate.

### Traction

#### WARNING

The traction grade assigned to this tire is based on straight-ahead braking traction tests, and does not include acceleration, cornering, hydroplaning, or peak traction characteristics.

- L** Avoid wheelspin. This can lead to damage to the drive train.

The traction grades – from highest to lowest – are AA, A, B and C. Those grades represent the tire's ability to stop on wet pavement as measured under controlled conditions on specified government test surfaces of asphalt and concrete. A tire marked C may have poor traction performance.

The safe speed on a wet, snow covered or icy road is always lower than on dry road surfaces.

You should pay special attention to road conditions when temperatures are around freezing point.

Mercedes-Benz recommends a minimum tread depth of  $\frac{1}{8}$  in (4 mm) on all four winter tires. Observe the legally required minimum tire tread depth (> page 303). Winter tires can reduce the braking distance on snow-covered surfaces in comparison with summer tires.

The braking distance is still much further than on surfaces that are not icy or covered with snow. Take appropriate care when driving.

Further information on winter tires (M+S tires) (> page 304).

### Temperature

#### WARNING

The temperature grade for this tire is established for a tire that is properly inflated and not overloaded. Excessive speed, underinflation, or excessive loading, either separately or in combination, can cause excessive heat build-up and possible tire failure.

The temperature grades are A (the highest), B, and C, representing the tire's resistance to the generation of heat and its ability to dissipate heat when tested under controlled conditions on a specified indoor laboratory test wheel. Sustained high temperature can cause the material of the tire to degenerate and reduce tire life, and excessive temperature can lead to sudden tire failure. The grade C corresponds to a level of performance which all passenger car tires must meet under the Federal Motor Vehicle Safety Standard No. 109. Grades B and A represent higher levels of performance on the laboratory test wheel than the minimum required by law.

## Tire labeling

### Overview

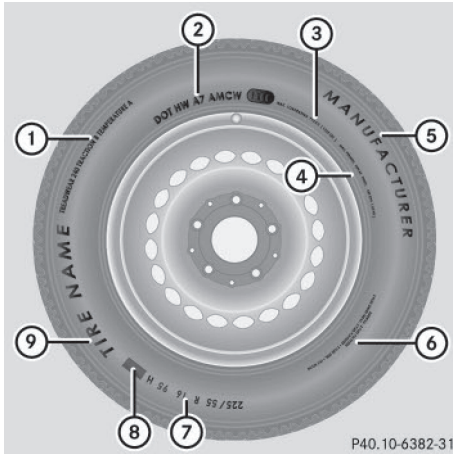

- ① Uniform Tire Quality Grading Standards (▷ page 320)
- ② Department of Transportation, Tire Identification Number (▷ page 319)
- ③ Maximum load rating (▷ page 318)
- ④ Maximum tire pressures (▷ page 308)
- ⑤ Manufacturer
- ⑥ Tire material (▷ page 319)
- ⑦ Tire size designation, load-bearing capacity and speed rating (▷ page 316)
- ⑧ Load index (▷ page 318)
- ⑨ Tire name

The markings described above are on the tire in addition to the tire name (sales designation) and the manufacturer's name.

- ⓘ Tire data is vehicle-specific and may deviate from the data in the example.

### Tire size designation, load-bearing capacity and speed rating

#### ⚠ WARNING

Exceeding the stated tire load-bearing capacity and the approved maximum speed could lead to tire damage or the tire bursting. There is a risk of accident.

Therefore, only use tire types and sizes approved for your vehicle model. Observe the tire load rating and speed rating required for your vehicle.

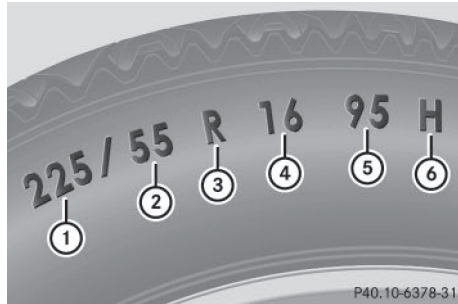

- ① Tire width
- ② Nominal aspect ratio in %
- ③ Tire code
- ④ Rim diameter
- ⑤ Load bearing index
- ⑥ Speed rating

**General:** depending on the manufacturer's standards, the size imprinted in the tire wall may not contain any letters or may contain one letter that precedes the size description. If there is no letter preceding the size description (as shown above): these are passenger vehicle tires according to European manufacturing standards.

If "P" precedes the size description: these are passenger vehicle tires according to U.S. manufacturing standards.

If "LT" precedes the size description: these are light truck tires according to U.S. manufacturing standards.

If "T" precedes the size description: compact emergency wheels with high tire pressure that are only designed for temporary use in an emergency.

**Tire width:** tire width ① shows the nominal tire width in millimeters.

**Aspect ratio:** aspect ratio ② is the size ratio between the tire height and tire width and is shown in percent. The aspect ratio is calcu-

lated by dividing the tire width by the tire height.

**Tire code:** tire code ③ specifies the tire type. "R" represents radial tires; "D" represents diagonal tires; "B" represents diagonal radial tires.

Optionally, tires with a maximum speed of over 149 mph (240 km/h) may have "ZR" in the size description, depending on the manufacturer (e.g. 245/40 ZR 18).

**Rim diameter:** rim diameter ④ is the diameter of the bead seat, not the diameter of the rim flange. The rim diameter is specified in inches (in).

**Load-bearing index:** load-bearing index ⑤ is a numerical code that specifies the maximum load-bearing capacity of a tire.

Do not overload the tires by exceeding the specified load limit. The maximum permissible load can be found on the vehicle's Tire and Loading Information placard on the B-pillar on the driver's side (▷ page 310).

Example:

Load-bearing index 91 indicates a maximum load of 1,356 lb (615 kg) that the tires can bear. For further information on the maximum tire load in kilograms and lbs, see (▷ page 318).

For further information on the load bearing index, see "Load index" (▷ page 318).

**Speed rating:** speed rating ⑥ specifies the approved maximum speed of the tire.

**i** Tire data is vehicle-specific and may deviate from the data in the example.

Regardless of the speed rating, always observe the speed limits. Drive carefully and adapt your driving style to the traffic conditions.

### Summer tires

Index	Speed rating
Q	up to 100 mph (160 km/h)
R	up to 106 mph (170 km/h)

Index	Speed rating
S	up to 112 mph (180 km/h)
T	up to 118 mph (190 km/h)
H	up to 130 mph (210 km/h)
V	up to 149 mph (240 km/h)
W	up to 168 mph (270 km/h)
Y	up to 186 mph (300 km/h)
ZR...Y	up to 186 mph (300 km/h)
ZR...(..Y)	over 186 mph (300 km/h)
ZR	over 149 mph (240 km/h)

- Optionally, tires with a maximum speed of over 149 mph (240 km/h) may have "ZR" in the size description, depending on the manufacturer (e.g. 245/40 ZR18).

The service specification is made up of load-bearing index ⑤ and speed rating ⑥.

- If the size description of your tire includes "ZR" and there are no service specifications, ask the tire manufacturer in order to find out the maximum speed.

If a service specification is available, the maximum speed is limited according to the speed rating in the service specification.

Example: 245/40 ZR18 97 Y. In this example, "97 Y" is the service specification. The letter "Y" represents the speed rating. The maximum speed of the tire is limited to 186 mph (300 km/h).

- The size description for all tires with maximum speeds of over 186 mph (300 km/h) must include "ZR" **and** the service specification must be given in parentheses. Example: 275/40 ZR 18 (99 Y). Speed rating "(Y)" indicates that the maximum speed of the tire is over 186 mph (300 km/h). Ask the tire manufacturer about the maximum speed.

### All-weather tires and winter tires

Index	Speed rating
Q M+S <sup>1</sup>	up to 100 mph (160 km/h)
T M+S <sup>1</sup>	up to 118 mph (190 km/h)
H M+S <sup>1</sup>	up to 130 mph (210 km/h)
V M+S <sup>1</sup>	up to 149 mph (240 km/h)

**i** Not all tires with the M+S marking provide the driving characteristics of winter tires. In addition to the M+S marking, winter tires also have the  snowflake symbol on the tire wall. Tires with this marking fulfill the requirements of the Rubber Manufacturers Association (RMA) and the Rubber Association of Canada (RAC) regarding the tire traction on snow. They have been especially developed for driving on snow.

An electronic speed limiter prevents your vehicle from exceeding a speed of 130 mph (210 km/h).

The speed rating of tires mounted at the factory may be higher than the maximum speed that the electronic speed limiter permits.

Make sure that your tires have the required speed rating, e.g. when buying new tires. The required speed rating for your vehicle can be found in the "Tires" section (▷ page 326).

Further information about reading tire data can be obtained from any qualified specialist workshop.

### Load index



In addition to the load-bearing index, load index **①** may be imprinted after the letters that identify speed rating on the sidewall of the tire. Speed rating (▷ page 316).

- If no specification is given: no text (as in the example above), represents a standard load (SL) tire
- XL or Extra Load: represents a reinforced tire
- Light Load: represents a light load tire
- C, D, E: represents a load range that depends on the maximum load that the tire can carry at a certain pressure

**i** Tire data is vehicle-specific and may deviate from the data in the example.

### Maximum load rating

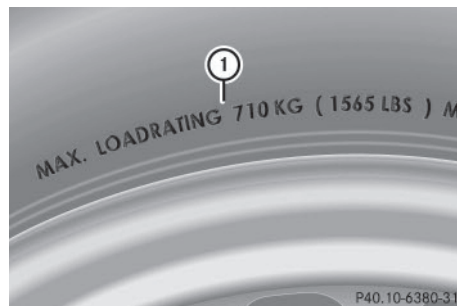

Maximum tire load **①** is the maximum permissible weight for which the tire is approved. Do not overload the tires by exceeding the specified load limit. The maximum permissi-

<sup>1</sup> Or M+S  for winter tires.



ble load can be found on the vehicle's Tire and Loading Information placard on the B-pillar on the driver's side (▷ page 310).

- i** The actual values for tires are vehicle-specific and may deviate from the values in the illustration.

### DOT, Tire Identification Number (TIN)

US tire regulations stipulate that every tire manufacturer or retreader must imprint a TIN in or on the sidewall of each tire produced.

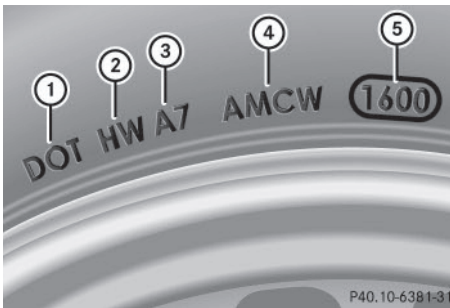

The TIN is a unique identification number. The TIN enables the tire manufacturers or retreaders to inform purchasers of recalls and other safety-relevant matters. It makes it possible for the purchaser to easily identify the affected tires.

The TIN is made up of manufacturer identification code (2), tire size (3), tire type code (4) and manufacturing date (5).

**DOT (Department of Transportation):** tire symbol (1) marks that the tire complies with the requirements of the U.S. Department of Transportation.

**Manufacturer identification code:** manufacturer identification code (2) provides details on the tire manufacturer. New tires have a code with two symbols. Retreaded tires have a code with four symbols.

For further information about retreaded tires, see (▷ page 302).

**Tire size:** identifier (3) describes the tire size.

**Tire type code:** tire type code (4) can be used by the manufacturer as a code to describe specific characteristics of the tire.

**Date of manufacture:** date of manufacture (5) provides information about the age of a tire. The first and second positions represent the week of manufacture, starting with "01" for the first calendar week. Positions three and four represent the year of manufacture. For example, a tire that is marked with "3208", was manufactured in week 32 in 2008.

- i** Tire data is vehicle-specific and may deviate from the data in the example.

### Tire characteristics

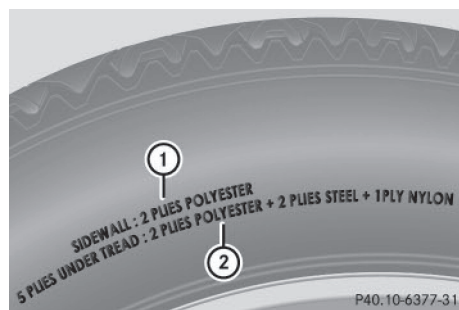

This information describes the type of tire cord and the number of layers in sidewall (1) and under tire tread (2).

- i** Tire data is vehicle-specific and may deviate from the data in the example.

### Definition of terms for tires and loading

#### Tire ply composition and material used

Describes the number of plies or the number of layers of rubber-coated fabric in the tire tread and sidewall. These are made of steel, nylon, polyester and other materials.

#### Bar

Metric unit for tire pressure. 14.5038 pounds per square inch (psi) and 100 kilopascals (kPa) are the equivalent of 1 bar.

**DOT (Department of Transportation)**

DOT-marked tires fulfill the requirements of the U S Department of Transportation.

**Normal occupant weight**

The number of occupants for which the vehicle is designed multiplied by 68 kilograms (150 lbs).

**Uniform Tire Quality Grading Standards**

A uniform standard to grade the quality of tires with regards to tread quality, tire traction and temperature characteristics. The quality grading assessment is made by the manufacturer following specifications from the U.S. government. The ratings are molded into the sidewall of the tire.

**Recommended tire pressures**

The recommended tire pressure applies to the tires mounted at the factory.

The Tire and Loading Information placard contains the recommended tire pressures for cold tires on a fully loaded vehicle and for the maximum permissible vehicle speed.

The tire pressure table contains the recommended pressures for cold tires for various operating conditions, i.e. differing load and speed conditions.

**Increased vehicle weight due to optional equipment**

The combined weight of all standard and optional equipment available for the vehicle, regardless of whether it is actually installed on the vehicle or not.

**Rim**

This is the part of the wheel on which the tire is mounted.

**GAWR (Gross Axle Weight Rating)**

The GAWR is the maximum gross axle weight rating. The actual load on an axle must never exceed the gross axle weight rating. The gross axle weight rating can be found on the vehicle identification plate on the B-pillar on the driver's side.

**Speed rating**

The speed rating is part of the tire identification. It specifies the speed range for which the tire is approved.

**GVW (Gross Vehicle Weight)**

The gross vehicle weight includes the weight of the vehicle including fuel, tools, the spare wheel, accessories installed, occupants, luggage and the drawbar noseweight, if applicable. The gross vehicle weight must not exceed the gross vehicle weight rating GVWR as specified on the vehicle identification plate on the B-pillar on the driver's side.

**GVWR (Gross Vehicle Weight Rating)**

The GVWR is the maximum permissible gross weight of a fully loaded vehicle (the weight of the vehicle including all accessories, occupants, fuel, luggage and the drawbar noseweight, if applicable). The gross vehicle weight rating is specified on the vehicle identification plate on the B-pillar on the driver's side.

**Maximum loaded vehicle weight**

The maximum weight is the sum of:

- the curb weight of the vehicle
- the weight of the accessories
- the load limit
- the weight of the factory installed optional equipment

**Kilopascal (kPa)**

Metric unit for tire pressure. 6.9 kPa corresponds to 1 psi. Another unit for tire pressure is bar. 100 kilopascals (kPa) are the equivalent of 1 bar.

**Load index**

In addition to the load-bearing index, the load index may also be imprinted on the sidewall of the tire. This specifies the load-bearing capacity more precisely.

**Curb weight**

The weight of a vehicle with standard equipment including the maximum capacity of fuel, oil and coolant. It also includes the air-conditioning system and optional equipment if these are installed in the vehicle, but does not include passengers or luggage.

**Maximum load rating**

The maximum load rating is the maximum permissible weight in kilograms or lbs for which a tire is approved.

**Maximum permissible tire pressure**

Maximum permissible tire pressure for one tire.

**Maximum load on one tire**

Maximum load on one tire. This is calculated by dividing the maximum axle load of one axle by two.

**PSI (pounds per square inch)**

A standard unit of measure for tire pressure.

**Aspect ratio**

Relationship between tire height and tire width in percent.

**Tire pressure**

This is pressure inside the tire applying an outward force to each square inch of the tire's surface. The tire pressure is specified in pounds per square inch (psi), in kilopascal (kPa) or in bar. The tire pressure should only be corrected when the tires are cold.

**Cold tire pressure**

The tires are cold:

- if the vehicle has been parked without direct sunlight on the tires for at least three hours and
- if the vehicle has not been driven further than 1 mile (1.6 km)

**Tread**

The part of the tire that comes into contact with the road.

**Bead**

The tire bead ensures that the tire sits securely on the wheel. There are several steel wires in the bead to prevent the tire from coming loose from the wheel rim.

**Sidewall**

The part of the tire between the tread and the bead.

**Weight of optional extras**

The combined weight of those optional extras that weigh more than the replaced standard parts and more than 2.3 kg (5 lbs). These optional extras, such as high-performance brakes, level control, a roof rack or a high-performance battery, are not included in the curb weight and the weight of the accessories.

**TIN (Tire Identification Number)**

This is a unique identifier which can be used by a tire manufacturer to identify tires, for example for a product recall, and thus identify the purchasers. The TIN is made up of the manufacturer's identity code, tire size, tire type code and the manufacturing date.

**Load bearing index**

The load bearing index (also load index) is a code that contains the maximum load bearing capacity of a tire.

**Traction**

Traction is the result of friction between the tires and the road surface.

**Treadwear indicators**

Narrow bars (tread wear bars) that are distributed over the tire tread. If the tire tread is level with the bars, the wear limit of  $\frac{1}{16}$  in (1.6 mm) has been reached.

**Occupant distribution**

The distribution of occupants in a vehicle at their designated seating positions.

**Total load limit**

Nominal load and luggage load plus 68 kg (150 lbs) multiplied by the number of seats in the vehicle.

**Changing a wheel****Flat tire**

The "Breakdown assistance" section (▷ page 284) contains information and notes on how to deal with a flat tire. Information on driving with MOExtended tires in the event of a flat tire can be found under "MOExtended tires (tires with run-flat characteristics)" (▷ page 285).

**Rotating the wheels** **WARNING**

Interchanging the front and rear wheels may severely impair the driving characteristics if the wheels or tires have different dimensions. The wheel brakes or suspension components may also be damaged. There is a risk of accident.

Rotate front and rear wheels only if the wheels and tires are of the same dimensions.

Observe the instructions and safety notes in the "Changing a wheel" section (▷ page 322).

The wear patterns on the front and rear tires differ, depending on the operating conditions. Rotate the wheels before a clear wear pattern has formed on the tires. Front tires typically wear more on the shoulders and the rear tires in the center.

If your vehicle's tire configuration allows, you can rotate the wheels according to the intervals in the tire manufacturer's warranty book in your vehicle documents. If no warranty book is available, the tires should be rotated

every 3,000 to 6,000 miles (5,000 to 10,000 km), or earlier if tire wear requires. Ensure the direction of rotation is maintained.

Clean the contact surfaces of the wheel and the brake disc thoroughly every time a wheel is rotated. Check the tire pressure and, if necessary, restart the tire pressure loss warning system.

**Direction of rotation**

Tires with a specified direction of rotation have additional benefits, e.g. if there is a risk of hydroplaning. These advantages can only be gained if the tires are installed corresponding to the direction of rotation.

An arrow on the sidewall of the tire indicates its correct direction of rotation.

**Storing wheels**

Store wheels that are not being used in a cool, dry and preferably dark place. Protect the tires from oil, grease, gasoline and diesel.

**Mounting a wheel****Preparing the vehicle**

- ▶ Stop the vehicle on solid, non-slippery and level ground.
- ▶ Apply the electric parking brake manually.
- ▶ Bring the front wheels into the straight-ahead position.
- ▶ Shift the transmission to position **P**.
- ▶ Switch off the engine.
- ▶ **Vehicles without KEYLESS-GO:** remove the SmartKey from the ignition lock.
- ▶ **Vehicles with KEYLESS-GO start-function or KEYLESS-GO:** open the driver's door.

The on-board electronics now have status **0**. This is the same as the SmartKey having been removed.

- ▶ **Vehicles with KEYLESS-GO start-function or KEYLESS-GO:** remove the Start/Stop button from the ignition lock (▷ page 135).
- ▶ If included in the vehicle equipment, remove the tire-change tool kit from the vehicle.
- ▶ Safeguard the vehicle against rolling away (▷ page 152).

### Securing the vehicle to prevent it from rolling away

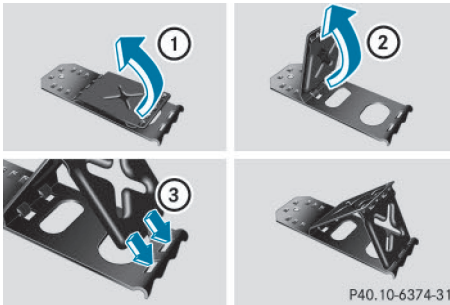

If your vehicle is equipped with a wheel chock, it can be found in the tire-change tool kit (▷ page 284).

The folding wheel chock is an additional safety measure to prevent the vehicle from rolling away, for example when changing a wheel.

- ▶ Fold both plates upwards ①.
- ▶ Fold out lower plate ②.
- ▶ Guide the lugs on the lower plate fully into the openings in base plate ③.

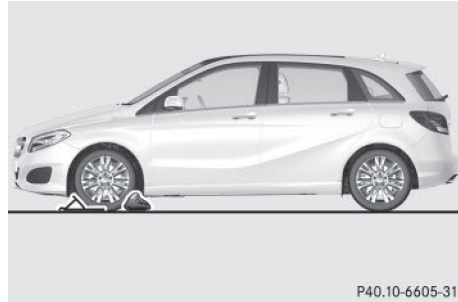

P40.10-6605-31

Securing the vehicle on level ground

- ▶ **On level ground:** place chocks or other suitable items under the front and rear of the wheel that is diagonally opposite the wheel you wish to change.

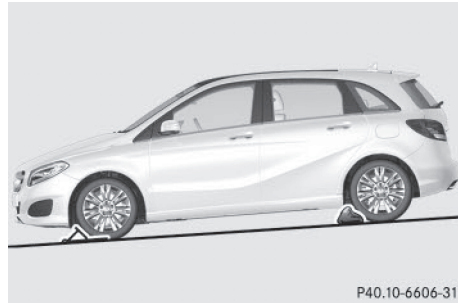

P40.10-6606-31

Securing the vehicle on slight downhill gradients

- ▶ **On light downhill gradients:** place chocks or other suitable items in front of the wheels of the front and rear axle.

### Raising the vehicle

#### **WARNING**

If you do not position the jack correctly at the appropriate jacking point of the vehicle, the jack could tip over with the vehicle raised. There is a risk of injury.

Only position the jack at the appropriate jacking point of the vehicle. The base of the jack must be positioned vertically, directly under the jacking point of the vehicle.

- ▶ **!** The jack is designed exclusively for jacking up the vehicle at the jacking points. Otherwise, your vehicle could be damaged.

**Observe the following when raising the vehicle:**

- To raise the vehicle, only use the vehicle-specific jack that has been tested and approved by Mercedes-Benz. If used incorrectly, the jack could tip over with the vehicle raised.
- The jack is designed only to raise and hold the vehicle for a short time while a wheel is being changed. It is not suited for performing maintenance work under the vehicle.
- Avoid changing the wheel on uphill and downhill slopes.
- Before raising the vehicle, secure it from rolling away by applying the parking brake and inserting wheel chocks. Do not disengage the parking brake while the vehicle is raised.
- The jack must be placed on a firm, flat and non-slip surface. On a loose surface, a large, flat, load-bearing underlay must be used. On a slippery surface, a non-slip underlay must be used, e.g. rubber mats.
- Do not use wooden blocks or similar objects as a jack underlay. Otherwise, the jack will not be able to achieve its load-bearing capacity due to the restricted height.
- Make sure that the distance between the underside of the tires and the ground does not exceed 1.2 in (3 cm).
- Never place your hands and feet under the raised vehicle.
- Do not lie under the vehicle.
- Do not start the engine when the vehicle is raised.
- Never open or close a door or the tailgate when the vehicle is raised.
- Make sure that no persons are present in the vehicle when the vehicle is raised.

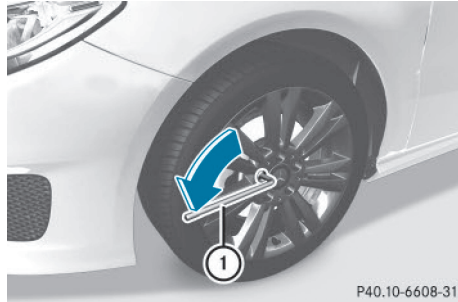

- ▶ Using lug wrench ①, loosen the bolts on the wheel you wish to change by about one full turn. Do not unscrew the bolts completely.

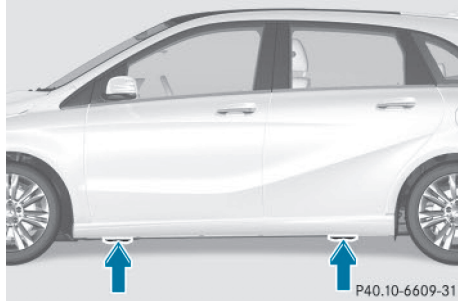

**Jacking points**

The jacking points are located just behind the front wheel housings and just in front of the rear wheel housings (arrows).

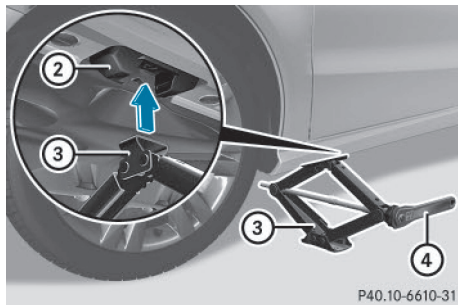

- ▶ Take ratchet wrench ④ out of the vehicle tool kit and place it on the hexagon nut of jack ③ so that the letters **AUF** are visible.
- ▶ Position jack ③ at jacking point ②.

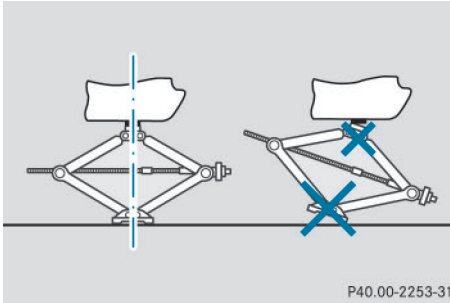

P40.00-2253-31

- ▶ Make sure the foot of the jack is directly beneath the jacking point.
- ▶ Turn ratchet wrench ④ until jack ③ sits completely on jacking point ② and the base of the jack lies evenly on the ground.
- ▶ Turn ratchet wrench ④ until the tire is raised a maximum of 1.2 in (3 cm) from the ground.

### Removing a wheel

- ❗ Do not place wheel bolts in sand or on a dirty surface. The bolt and wheel hub threads could otherwise be damaged when you screw them in.
- ▶ Unscrew the wheel bolts.
- ▶ Remove the wheel.

### Mounting a new wheel

#### ⚠ WARNING

Oiled or greased wheel bolts or damaged wheel bolts/hub threads can cause the wheel bolts to come loose. As a result, you could lose a wheel while driving. There is a risk of accident.

Never oil or grease wheel bolts. In the event of damage to the threads, contact a qualified specialist workshop immediately. Have the damaged wheel bolts or hub threads replaced/renewed. Do not continue driving.

#### ⚠ WARNING

If you tighten the wheel bolts or wheel nuts when the vehicle is raised, the jack could tip over. There is a risk of injury.

Only tighten the wheel bolts or wheel nuts when the vehicle is on the ground.

Always pay attention to the instructions and safety notes in the "Changing a wheel" section (▷ page 322).

Only use wheel bolts that have been designed for the wheel and the vehicle. For safety reasons, Mercedes-Benz recommends that you only use wheel bolts which have been approved for Mercedes-Benz vehicles and the respective wheel.

- ❗ To prevent damage to the paintwork, hold the wheel securely against the wheel hub while screwing in the first wheel bolt.



P40.10-6611-31

- ▶ Clean the wheel and wheel hub contact surfaces.
- ▶ Place the new wheel on the wheel hub and push it on.
- ▶ Tighten the wheel bolts until they are finger-tight.

### Lowering the vehicle

#### ⚠ WARNING

The wheels could work loose if the wheel nuts and bolts are not tightened to the specified tightening torque. There is a risk of accident.

Have the tightening torque immediately checked at a qualified specialist workshop after a wheel is changed.

- ▶ Place the ratchet wrench onto the hexagon nut of the jack so that the letters **AB** are visible.
- ▶ Turn the ratchet wrench until the vehicle is once again standing firmly on the ground.
- ▶ Place the jack to one side.

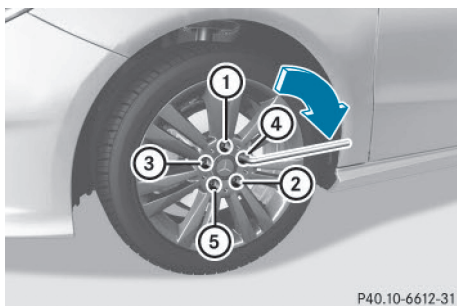

- ▶ Tighten the wheel bolts evenly in a cross-wise pattern in the sequence indicated (① to ⑤). The specified tightening torque is **96 lb-ft (130 Nm)**.
- ▶ Turn the jack back to its initial position.
- ▶ Stow the jack and the rest of the vehicle tools in the vehicle again.
- ▶ Check the tire pressure of the newly mounted wheel and adjust it if necessary. Observe the recommended tire pressure (> page 305).

When you are driving with the emergency spare wheel mounted, the tire pressure monitor cannot function reliably. Only restart the tire pressure monitor when the defective wheel has been replaced with a new wheel.

### Wheel and tire combinations

#### General notes

- ❗ For safety reasons, Mercedes-Benz recommends that you only use tires and wheels which have been approved by

Mercedes-Benz specifically for your vehicle.

These tires have been specially adapted for use with the control systems, such as ABS or ESP®, and are marked as follows:

- MO = Mercedes-Benz Original
- MOE = Mercedes-Benz Original Extended (tires featuring run-flat characteristics)
- MO1 = Mercedes-Benz Original (only certain AMG tires)

Mercedes-Benz Original Extended tires may only be used on wheels that have been specifically approved by Mercedes-Benz.

Only use tires, wheels or accessories tested and approved by Mercedes-Benz. Certain characteristics, e.g. handling, vehicle noise emissions or fuel consumption, may otherwise be adversely affected. In addition, when driving with a load, tire dimension variations could cause the tires to come into contact with the bodywork and axle components. This could result in damage to the tires or the vehicle.

Mercedes-Benz accepts no liability for damage resulting from the use of tires, wheels or accessories other than those tested and approved.

Information on tires, wheels and approved combinations can be obtained from any qualified specialist workshop.

Overview of abbreviations used in the following tire tables:

- BA: both axles
- FA: front axle
- RA: rear axle

The recommended pressures for various operating conditions can be found:

- on the Tire and Loading Information placard with the recommended tire pressures on the B-pillar on the driver's side
- in the tire pressure table on the inside of the fuel filler flap



Observe the notes on recommended tire pressures under various operating conditions (▷ page 305).

Check tire pressures regularly, and only when the tires are cold. Comply with the maintenance recommendations of the tire manufacturer in the vehicle document wallet.

Notes on the vehicle equipment – always equip the vehicle with:

- tires of the same size on a given axle (left/right)
- the same type of tires at a given time (summer tires, winter tires, MOExtended tires)  
Exception: it is permissible to install a different type or make in the event of a flat tire. Observe the "MOExtended tires (tires with run-flat characteristics)" section (▷ page 285).

Vehicles equipped with MOExtended tires are not equipped with a TIREFIT kit at the factory. It is therefore recommended that you additionally equip your vehicle with a TIREFIT kit if you mount tires that do not feature run-flat properties, e.g. winter tires. A TIREFIT kit may be obtained from a qualified specialist workshop.

**i** On the following pages, you can find information on approved wheel rims and tire sizes for equipping your vehicle with winter tires. Winter tires are not available at the factory as standard equipment or optional extras.

If you would like to equip your vehicle with approved winter tires, you may also, in certain circumstances, require rims of the appropriate size. The size of the approved winter tires may deviate from that of the standard tires. This is dependent on the model and the equipment installed at the factory.

The tires and wheel rims, as well as further information, can be obtained at a qualified specialist workshop.

**i** Not all wheel and tire combinations are available at the factory for all countries.

**Tires****B 250****Summer tires****R 18**

Tires	Wheels
BA: 225/40 R18 92 W XL <sup>2,3</sup>	BA: 7.5 J x 18 H2 Wheel offset: 2.05 in (52 mm)

**All-weather tires****R 17**

Tires	Wheels
BA: 225/45 R17 91 H M+S <sup>2,3</sup>	BA: 7.5 J x 17 H2 Wheel offset: 2.07 in (52.5 mm)

**Winter tires****R 17**

Tires	Wheels
BA: 205/50 R17 93 H XL M+S  <sup>2</sup>	BA: 6.5 J x 17 H2 Wheel offset: 1.93 in (49 mm)

**R 18**

Tires	Wheels
BA: 225/40 R18 92 H XL M+S  <sup>3</sup>	BA: 7.5 J x 18 H2 Wheel offset: 2.05 in (52 mm)

**B 250 4MATIC****Summer tires****R 18**

Tires	Wheels
BA: 225/40 R18 92 W XL <sup>2,3</sup>	BA: 7.5 J x 18 H2 Wheel offset: 2.05 in (52 mm)

<sup>2</sup> Also available as MOExtended tires.

<sup>3</sup> Use of snow chains not permitted. Observe the notes in the "Snow chains" section.

**All-weather tires****R 17**

Tires	Wheels
BA: 225/45 R17 91 H M+S <sup>2,3</sup>	BA: 7.5 J x 17 H2 Wheel offset: 2.07 in (52.5 mm)

**Winter tires****R 17**

Tires	Wheels
BA: 205/50 R17 93 H XL M+S  <sup>2</sup>	BA: 6.5 J x 17 H2 Wheel offset: 1.93 in (49 mm)

**R 18**

Tires	Wheels
BA: 225/40 R18 92 H XL M+S  <sup>3</sup>	BA: 7.5 J x 18 H2 Wheel offset: 2.05 in (52 mm)

**Emergency spare wheel****Important safety notes** **WARNING**

The wheel or tire size as well as the tire type of the spare wheel or emergency spare wheel and the wheel to be replaced may differ. Mounting an emergency spare wheel may severely impair the driving characteristics. There is a risk of an accident.

To avoid hazardous situations:

- adapt your driving style accordingly and drive carefully.
- never mount more than one spare wheel or emergency spare wheel that differs in size.
- only use a spare wheel or emergency spare wheel of a different size briefly.
- do not switch ESP<sup>®</sup> off.
- have a spare wheel or emergency spare wheel of a different size replaced at the

nearest qualified specialist workshop. Observe that the wheel and tire dimensions as well as the tire type must be correct.

When using an emergency spare wheel or spare wheel of a different size, you must not exceed the maximum speed of 50 mph (80 km/h).

Snow chains must not be mounted on emergency spare wheels.

**General notes**

Apart from some country-specific variants, the vehicles are not equipped with an emergency spare wheel. Emergency spare wheels are specific to the vehicle. For more information on which emergency spare wheels are approved for your vehicle, consult a qualified specialist workshop.

<sup>2</sup> Also available as MOExtended tires.

<sup>3</sup> Use of snow chains not permitted. Observe the notes in the "Snow chains" section.

You should regularly check the pressure of the emergency spare wheel, particularly prior to long trips, and correct the pressure as necessary (▷ page 305). The value on the wheel is valid. In addition, the emergency spare wheel tire pressure can be found under "Technical data" (▷ page 331).

An emergency spare wheel may also be mounted against the direction of rotation. Observe the time restriction on use as well as the speed limitation specified on the emergency spare wheel.

Replace the tires after six years at the latest, regardless of wear. This also applies to the emergency spare wheel.

When you are driving with the emergency spare wheel mounted, the tire pressure loss warning system cannot function reliably. Only restart the tire pressure loss warning system when the defective wheel has been replaced with a new wheel.

- ▶ Remove emergency spare wheel bag ① with the "Minispare" emergency spare wheel.
- ▶ Open emergency spare wheel bag ① and remove the "Minispare" emergency spare wheel.

Observe the instructions and safety notes in the "Changing a wheel" section (▷ page 322).

#### Removing the emergency spare wheel

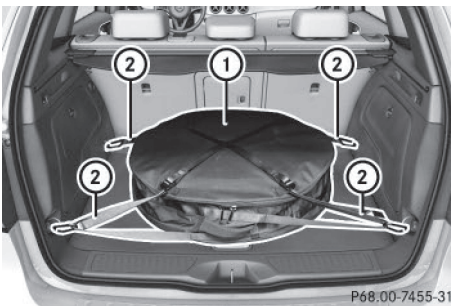

Vehicles with the "Minispare" emergency spare wheel:

The "Minispare" emergency spare wheel is secured in emergency spare wheel bag ① in the cargo compartment.

- ▶ Open the tailgate.
- ▶ Release securing straps ② on emergency spare wheel bag ①.

**Technical data****All models**

<b>"Minispare" emergency spare wheel</b>	
<b>Tires</b>	<b>Wheels</b>
T 125/80 R17 99 M Tire pressure: 420 kPa (4.2 bar/61 psi)	3.5 B x 17 H2 Wheel offset: 0.77 in (19.5 mm)



<b>Useful information .....</b>	<b>334</b>
<b>Information regarding technical data .....</b>	<b>334</b>
<b>Identification plates .....</b>	<b>334</b>
<b>Service products and filling capacities .....</b>	<b>335</b>
<b>Vehicle data .....</b>	<b>341</b>

## Useful information

- i** This Operator's Manual describes all models and all standard and optional equipment of your vehicle available at the time of publication of the Operator's Manual. Country-specific differences are possible. Please note that your vehicle may not be equipped with all features described. This also applies to safety-related systems and functions.
- i** Read the information on qualified specialist workshops (► page 24).

## Information regarding technical data

- i** The data stated here specifically refers to a vehicle with standard equipment. Consult an authorized Mercedes-Benz Center for the data for all vehicle variants and trim levels.

## Identification plates

## Vehicle identification plate with vehicle identification number (VIN)



- Open the driver's door. You will see vehicle identification plate ①.

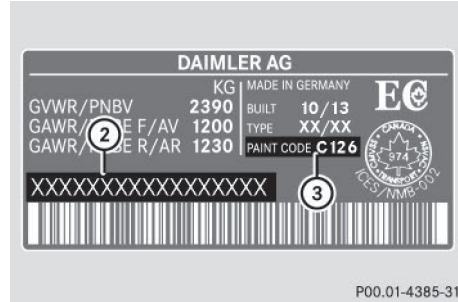

- ② VIN
- ③ Paint code

- i** The data shown on the vehicle identification plate is used only as an example. This data is different for every vehicle and can deviate from the data shown here. You can find the data applicable to your vehicle on the vehicle identification plate.

## Vehicle identification number (VIN)

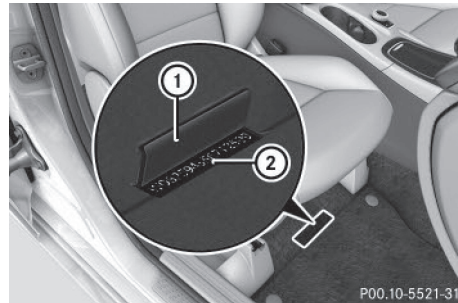

- Slide the right-hand front seat to its rearmost position.
- Fold floor covering ① upwards. You will see VIN ②.

The VIN can also be found on the vehicle identification plate (► page 334).

The VIN can also be found at the lower edge of the windshield (► page 335).



### Engine number

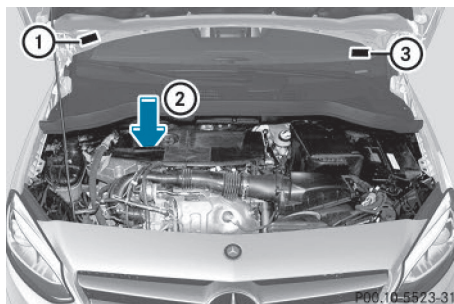

- ① Emissions control information plate
- ② Engine number (stamped into the crankcase)
- ③ VIN (on the lower edge of the windshield)

### Service products and filling capacities

#### Important safety notes

##### **WARNING**

Service products may be poisonous and hazardous to health. There is a risk of injury.

Comply with instructions on the use, storage and disposal of service products on the labels of the respective original containers. Always store service products sealed in their original containers. Always keep service products out of the reach of children.

##### **Environmental note**

Dispose of service products in an environmentally responsible manner.

Service products include the following:

- Fuels
- Lubricants (e.g. engine oil, transmission oil)
- Coolant
- Brake fluid
- Windshield washer fluid
- Climate control system refrigerant

Components and service products must be matched. Only use products recommended

by Mercedes-Benz. Damage which is caused by the use of products which have not been recommended is not covered by the Mercedes-Benz warranty or goodwill gestures. They are listed in this Mercedes-Benz Operator's Manual in the appropriate section. Information on tested and approved products can be obtained at an authorized Mercedes-Benz Center or on the Internet at <http://bevo.mercedes-benz.com>.

You can recognize service products approved by Mercedes-Benz by the following inscription on the containers:

- MB-Freigabe (e.g. MB-Freigabe 229.51)
- MB Approval (e.g. MB Approval 229.51)

Other designations or recommendations indicate a level of quality or a specification in accordance with an MB Sheet Number (e.g. MB 229.5). They have not necessarily been approved by Mercedes-Benz.

Other identifications, for example:

- 0 W-30
- 5 W-30
- 5 W-40

### Fuel

#### Important safety notes

##### **WARNING**

Fuel is highly flammable. If you handle fuel incorrectly, there is a risk of fire and explosion.

You must avoid fire, open flames, creating sparks and smoking. Switch off the engine and, if applicable, the auxiliary heating before refueling.

##### **WARNING**

Fuel is poisonous and hazardous to health. There is a risk of injury.

You must make sure that fuel does not come into contact with your skin, eyes or clothing

and that it is not swallowed. Do not inhale fuel vapors. Keep fuel away from children.

If you or others come into contact with fuel, observe the following:

- Wash away fuel from skin immediately using soap and water.
- If fuel comes into contact with your eyes, immediately rinse them thoroughly with clean water. Seek medical assistance without delay.
- If fuel is swallowed, seek medical assistance without delay. Do not induce vomiting.
- Immediately change out of clothing which has come into contact with fuel.

### Tank capacity

Model	Total capacity
Models with 4MATIC	14.8 US gal (56.0 l)
All models	13.2 US gal (50.0 l)

Model	Of which reserve
All models	Approx. 1.6 US gal (6.0 l)

### Gasoline

#### Fuel grade

**!** Do not use diesel to refuel vehicles with a gasoline engine. Do not switch on the ignition if you accidentally refuel with the wrong fuel. Otherwise, the fuel will enter the fuel system. Even small amounts of the wrong fuel could result in damage to the fuel system and the engine. Notify a qualified specialist workshop and have the fuel tank and fuel lines drained completely.

**!** Only refuel using unleaded premium grade gasoline with at least 91 AKI/95 RON.

**!** Only use the fuel recommended. Operating the vehicle with other fuels can lead to engine failure.

**!** Do not use the following:

- E85 (gasoline with 85% ethanol)
- E100 (100% ethanol)
- M15 (gasoline with 15% methanol)
- M30 (gasoline with 30% methanol)
- M85 (gasoline with 85% methanol)
- M100 (100% methanol)
- Gasoline with metalliferous additives
- Diesel

Do not mix such fuels with the fuel recommended for your vehicle. Do not use additives. Otherwise, engine damage may occur. This does not include cleaning additives for the removal and prevention of residue build-up. Gasoline may only be mixed with cleaning additives recommended by Mercedes-Benz; see "Additives". You can obtain further information from any authorized Mercedes-Benz Center.

**!** To ensure the longevity and full performance of the engine, only premium-grade unleaded gasoline must be used.

If standard unleaded gasoline is unavailable and you have to refuel with unleaded gasoline of a lower grade, observe the following precautions:

- Only fill the fuel tank to half full with regular unleaded gasoline and fill the rest with premium-grade unleaded gasoline as soon as possible.
- Do not drive at the maximum speed.
- Avoid sudden acceleration and engine speeds over 3,000 rpm.

You will usually find information about the fuel grade on the pump. If you cannot find the label on the pump, ask the staff for assistance.

**i** For further information, consult a qualified specialist workshop or visit <http://www.mbusa.com> (USA only).

**i** E10 fuel contains up to 10% bioethanol. Your vehicle is E10-compatible. You can refuel your vehicle using E10 fuel.

**B 250, B 250 4MATIC:** as a temporary measure, if the recommended fuel is not available, you may also use regular unleaded gasoline with an octane rating of 88 AKI/93 RON.

**All other models:** as a temporary measure, if the recommended fuel is not available, you may also use regular unleaded gasoline with an octane rating of 87 AKI/91 RON. This may reduce engine performance and increase fuel consumption. Avoid driving at full throttle and sudden acceleration. Never refuel using fuel with a lower AKI.

Information on refueling (▷ page 151).

### Additives

**!** Operating the engine with fuel additives added later can lead to engine failure. Do not mix fuel additives with fuel. This does not include additives for the removal and prevention of residue buildup. Gasoline must only be mixed with additives recommended by Mercedes-Benz. Comply with the instructions for use on the product label. More information about recommended additives can be obtained from any authorized Mercedes-Benz Center.

Mercedes-Benz recommends that you use branded fuels that have additives.

The quality of the fuel available in some countries may not be sufficient. Residue could build up in the injection system as a result. In such cases, and in consultation with an authorized Mercedes-Benz Center, the gasoline may be mixed with the cleaning additive recommended by Mercedes-Benz. You must observe the notes and mixing ratios specified on the container.

## Fuel consumption information

### 🌱 Environmental note

CO<sub>2</sub> (carbon dioxide) is the gas which scientists believe to be principally responsible for global warming (the greenhouse effect). Your vehicle's CO<sub>2</sub> emissions are directly related to fuel consumption and therefore depend on:

- efficient use of the fuel by the engine
- driving style
- other non-technical factors, such as environmental influences, road conditions or traffic flow

You can minimize your vehicle's CO<sub>2</sub> emissions by driving carefully and having it serviced regularly.

The vehicle will use more fuel than usual in the following situations:

- at very low outside temperatures
- in city traffic
- on short journeys
- in mountainous terrain

### Engine oil

#### General notes

**!** Never use engine oil or an oil filter of a specification other than is necessary to fulfill the prescribed service intervals. Do not change the engine oil or oil filter in order to achieve longer replacement intervals than those prescribed. You could otherwise cause engine damage or damage to the exhaust gas aftertreatment.

Follow the instructions in the service interval display regarding the oil change. Otherwise, you may damage the engine and the exhaust gas aftertreatment.

When handling engine oil, observe the important safety notes on service products (▷ page 335).

The engine oils are matched to the performance of Mercedes-Benz engines and service

intervals. You should therefore only use engine oils and oil filters that are approved for vehicles with maintenance systems.

For a list of approved engine oils and oil filters, consult an authorized Mercedes-Benz Center. Or visit the website <http://bevo.mercedes-benz.com>.

The table shows which engine oils have been approved for your vehicle.

Model	MB Approval
All models	229.5

- i** MB approval is indicated on the oil containers.

### Filling capacities

The following values refer to an oil change including the oil filter.

Model	Capacity
All models	5.9 US qt (5.6 l)

### Additives

- !** Do not use any additives in the engine oil. This could damage the engine.

### Engine oil viscosity

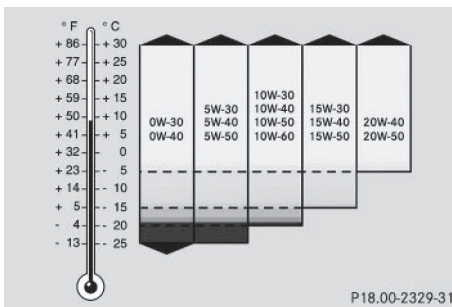

Viscosity describes the flow characteristics of a fluid. If an engine oil has a high viscosity, this means that it is thick; a low viscosity means that it is thin.

Select an engine oil with an SAE classification (viscosity) suitable for the prevailing outside temperatures. The table shows you which SAE classifications are to be used. The low-temperature characteristics of engine oils can deteriorate significantly, e.g. as a result of aging, soot and fuel deposits. It is therefore strongly recommended that you carry out regular oil changes using an approved engine oil with the appropriate SAE classification.

### Brake fluid

#### **!** WARNING

The brake fluid constantly absorbs moisture from the air. This lowers the boiling point of the brake fluid. If the boiling point of the brake fluid is too low, vapor pockets may form in the brake system when the brakes are applied hard. This would impair braking efficiency. There is a risk of an accident.

You should have the brake fluid renewed at the specified intervals.

When handling brake fluid, observe the important safety notes on service products (> page 335).

The brake fluid change intervals can be found in the Maintenance Booklet.

Only use brake fluid approved by Mercedes-Benz according to MB Approval 331.0.

Information about approved brake fluid can be obtained at any qualified specialist workshop or on the Internet at <http://bevo.mercedes-benz.com>.

- i** Have the brake fluid regularly replaced at a qualified specialist workshop and the replacement confirmed in the Maintenance Booklet.

## Coolant

### Important safety notes

#### WARNING

If antifreeze comes into contact with hot components in the engine compartment, it may ignite. There is a risk of fire and injury.

Let the engine cool down before you add antifreeze. Make sure that antifreeze is not spilled next to the filler neck. Thoroughly clean the antifreeze from components before starting the engine.

**!** Only add coolant that has been premixed with the desired antifreeze protection. You could otherwise damage the engine.

Further information on coolants can be found in the Mercedes-Benz Specifications for Service Products, MB BeVo 310.1, e.g. on the Internet at

<http://bevo.mercedes-benz.com>. Or contact a qualified specialist workshop.

**!** Always use a suitable coolant mixture, even in countries where high temperatures prevail.

Otherwise, the engine cooling system is not sufficiently protected from corrosion and overheating.

**i** Have the coolant regularly replaced at a qualified specialist workshop and the replacement confirmed in the Maintenance Booklet.

Comply with the important safety precautions for service products when handling coolant (▷ page 335).

The coolant is a mixture of water and antifreeze/corrosion inhibitor. It performs the following tasks:

- corrosion protection
- antifreeze protection
- raising the boiling point

If the coolant has antifreeze protection down to -35 °F (-37 °C), the boiling point of the cool-

ant during operation is approximately 266 °F (130 °C).

The antifreeze/corrosion inhibitor concentration in the engine cooling system should:

- be at least 50%. This will protect the engine cooling system against freezing down to approximately -35 °F (-37 °C).
- not exceed 55% (antifreeze protection down to -49 °F [-45 °C]). Otherwise, heat will not be dissipated as effectively.

Mercedes-Benz recommends coolant or antifreeze/corrosion inhibitor concentrate in accordance with

MB Specifications for Service Products 310.1 .

**i** When the vehicle is first delivered, it is filled with a coolant mixture that ensures adequate antifreeze and corrosion protection.

**i** The coolant is checked with every maintenance interval at a qualified specialist workshop.

### Filling capacities

Model	Capacity
All models	Approx. 8.2 US qt (7.8 l)

### Windshield washer system and headlamp cleaning system

### Important safety notes

#### WARNING

Windshield washer concentrate could ignite if it comes into contact with hot engine components or the exhaust system. There is a risk of fire and injury.

Make sure that no windshield washer concentrate is spilled next to the filler neck.

**!** Do not add distilled or de-ionized water to the washer fluid container. Otherwise, the level sensor may be damaged.

**!** Only MB SummerFit and MB WinterFit washer fluid should be mixed together. The spray nozzles may otherwise become blocked.

When handling washer fluid, observe the important safety notes on service products (> page 335).

At temperatures above freezing:

- Fill the washer fluid reservoir with a mixture of water and windshield washer fluid, e.g. MB SummerFit.

Add 1 part MB SummerFit to 100 parts water.

At temperatures below freezing:

- Fill the washer fluid reservoir with a mixture of water and washer fluid, e.g. MB WinterFit.

For the correct mixing ratio refer to the information on the antifreeze reservoir.

- i** Add windshield washer fluid, e.g. MB SummerFit or MB WinterFit, to the washer fluid all year round.

### Climate control system refrigerant

#### Important safety notes

The climate control system of your vehicle is filled with refrigerant R-134a.

The instruction label regarding the refrigerant type used can be found on the left, on the underside of the hood.

**!** Only the refrigerant R-134a and the PAG oil approved by Mercedes-Benz may be used. The approved PAG oil may not be mixed with any other PAG oil that is not approved for R-134a refrigerant. Otherwise, the climate control system may be damaged.

Service work, such as topping up refrigerant or replacing components, may only be carried

out by a qualified specialist workshop. All applicable regulations must be adhered to, SAE standard J639 included.

Always have work on the climate control system carried out at a qualified specialist workshop.

#### Refrigerant instruction label

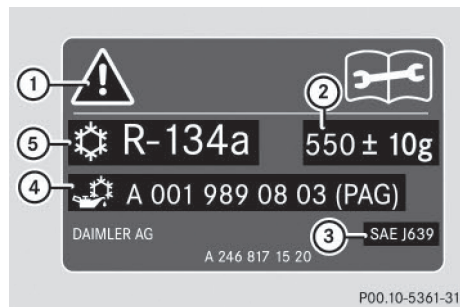

Example: refrigerant instruction label

- ① Warning symbol
- ② Refrigerant filling capacity
- ③ Applicable standards
- ④ PAG oil part number
- ⑤ Type of refrigerant

Warning symbol ① advises you about:

- possible dangers
- having service work carried out at a qualified specialist workshop

#### Filling capacities

Missing values were not available at time of going to print.

All models	Capacity
Refrigerant	
PAG oil	

**Vehicle data**

**General notes**

Please note that for the specified vehicle data:

- the heights specified may vary as a result of:
  - tires
  - load
  - condition of the suspension
  - optional equipment
- optional equipment reduces the maximum payload.

**Dimensions and weights**



Model	① Maximum headroom	② Opening height
All models	73.8 in (1874 mm)	78.0 in (1981 mm)

Missing values were not available at time of going to print.

All models	
Vehicle length	173.0 in (4393 mm)
Vehicle width including exterior mirrors	79.1 in (2010 mm)

All models	
Vehicle height	61.3 in (1558 mm)
Wheelbase	106.3 in (2699 mm)
Turning radius	36.1 ft (11.0 m)
Maximum trunk load (B 250)	220.5 lb (100 kg)
Maximum trunk load (B 250 4MATIC)	
Maximum roof load (B 250)	165 lb (75.0 kg)
Maximum roof load (B 250 4MATIC)	







