



#### Digital – in the vehicle

Familiarize yourself with the contents of the Operator's Manual directly via the vehicle's multimedia system (menu item "Vehicle information"). Start with the quick guide or broaden your knowledge with practical tips.



#### Vehicle document wallet

Here you can find comprehensive information about operating your vehicle and about services and guarantees in printed form.



#### Digital – on the Internet

You can find the Operator's Manual on the Mercedes-Benz homepage.



#### Digital – as an app

The Mercedes-Benz Guides app is available free-of-charge in familiar app stores.

CLA

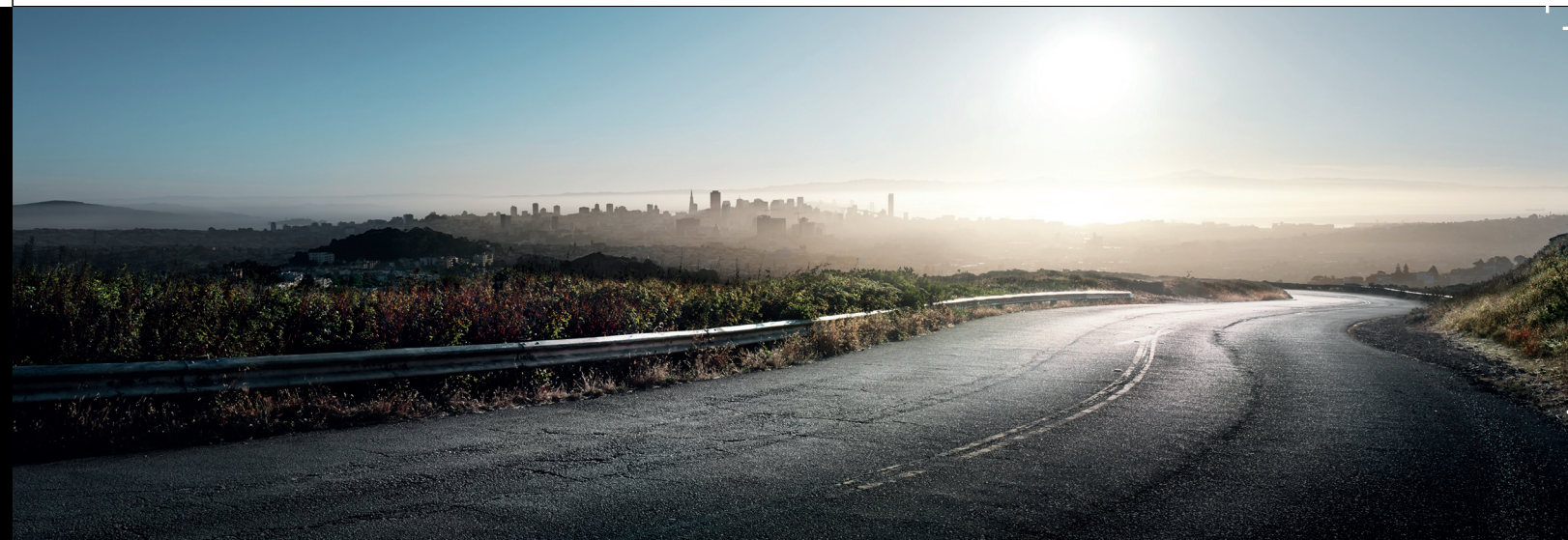

1185848100

Order no. P118 0067 13 Part no. 118 584 81 00  
Edition NA2019-05b



Apple® iOS



Android™

Mercedes-Benz

## CLA

Operator's Manual

Mercedes-Benz



## Front passenger airbag warning

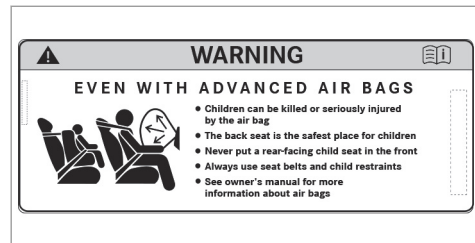

Example

**⚠ WARNING** Risk of injury or fatal injuries if the front-passenger airbag is enabled

If the front-passenger front airbag is enabled, a child on the front-passenger seat may be struck by the front-passenger airbag during an accident.

NEVER use a rearward-facing child restraint system on a seat with an ENABLED FRONT AIRBAG, DEATH or SERIOUS INJURY to the CHILD can occur.

Observe the chapter "Children in the vehicle".

## Publication details

### Internet

Further information about Mercedes-Benz vehicles and about Daimler AG can be found on the following websites:

<http://www.mbusa.com> (USA only)

<http://www.mercedes-benz.ca> (Canada only)

### Documentation team

©Daimler AG: not to be reprinted, translated or otherwise reproduced, in whole or in part, without written permission from Daimler AG.

### Vehicle manufacturer

Daimler AG

Mercedesstrasse 137

70327 Stuttgart

Germany

As at 07.01.18



## Welcome to the world of Mercedes-Benz

Before you first drive off, read this Operator's Manual carefully and familiarize yourself with your vehicle. For your own safety and a longer operating lifespan, follow the instructions and warning notices in this Operator's Manual. Disregarding them may lead to damage to the vehicle or personal injury.

Vehicle damage resulting from the disregard of the instructions is not covered by the Mercedes-Benz Limited Warranty.

The equipment or model designation of your vehicle may vary according to:

- Model
- Order
- National version
- Availability

Mercedes-Benz reserves the right to introduce changes in the following areas:

- Design
- Equipment
- Technical features

The equipment in your vehicle may therefore differ from that shown in the descriptions and illustrations.

The following are integral parts of the vehicle:

- Digital Operator's Manual
- Printed Operator's Manual
- Maintenance Booklet
- Equipment-dependent supplements

Keep these documents in the vehicle at all times. If you sell the vehicle, always pass all of the documents on to the new owner.

Mercedes-Benz USA, LLC

Mercedes-Benz Canada, Inc.

A Daimler Company

1185848100



<b>Symbols</b> .....	5	Correct use of the vehicle .....	27	<b>Seats and stowing</b> .....	88
<b>At a glance</b> .....	6	Problems with your vehicle .....	27	Notes on the correct driver's seat position .....	88
Cockpit .....	6	Reporting safety defects .....	27	Seats .....	89
Warning and indicator lamps .....	10	Limited Warranty .....	28	Steering wheel .....	94
Warning and indicator lamps .....	12	QR code for rescue card .....	28	Easy entry and exit feature .....	95
Overhead control panel .....	14	Data storage .....	28	Operating the memory function .....	96
Door control panel and seat adjustment .....	16	Copyright .....	31	Stowage areas .....	98
Emergencies and breakdowns .....	18	<b>Occupant safety</b> .....	33	Cup holder .....	105
<b>Digital Operator's Manual</b> .....	20	Restraint system .....	33	Ashtray and cigarette lighter .....	106
Calling up the Digital Operator's Manual .....	20	Seat belts .....	35	Sockets .....	107
<b>General notes</b> .....	21	Airbags .....	40	Wireless charging of the mobile phone and connection with the exterior antenna ..	109
Protecting the environment .....	21	PRE-SAFE® system .....	47	Installing/removing the floor mats .....	111
Genuine Mercedes-Benz parts .....	21	Safely transporting children in the vehicle .....	48	<b>Light and visibility</b> .....	113
Operator's Manual .....	22	Notes on pets in the vehicle .....	63	Exterior lighting .....	113
Service and vehicle operation .....	23	<b>Opening and closing</b> .....	64	Interior lighting .....	118
Operating safety .....	24	SmartKey .....	64	Windshield wiper and windshield washer system .....	119
Declaration of conformity for wireless vehicle components .....	25	Doors .....	69	Mirrors .....	121
Diagnostics connection .....	26	Trunk .....	73	Operating the sun visors .....	124
Qualified specialist workshop .....	26	Side windows .....	76		
		Sliding sunroof .....	80		
		Anti-theft protection .....	85		

<b>Climate control</b> .....	<b>125</b>
Overview of climate control systems .....	125
Operating the climate control system .....	125

<b>Driving and parking</b> .....	<b>129</b>
Driving .....	129
DYNAMIC SELECT switch .....	137
Automatic transmission .....	140
Function of 4MATIC .....	145
Refueling .....	145
Parking .....	148
Driving and driving safety systems .....	157
Vehicle towing instructions .....	207

<b>Instrument Display and on-board computer</b> .....	<b>208</b>
Instrument Display overview .....	208
Overview of the buttons on the steering wheel .....	209
Operating the on-board computer .....	210
Adjusting the design of the Instrument Display .....	211
Showing display content on the instrument cluster .....	212

Overview of displays on the multifunction display .....	213
Adjusting the instrument lighting .....	214
Menus and submenus .....	214
Head-up Display .....	220

<b>Voice Control System</b> .....	<b>222</b>
Notes on operating safety .....	222
Operation .....	222
Using the Voice Control System effectively .....	225
Essential voice commands .....	226

<b>MBUX multimedia system</b> .....	<b>240</b>
Overview and operation .....	240
System settings .....	276
Navigation .....	286
Telephone .....	326
Online and Internet functions .....	353
Media .....	360
Radio .....	367
Sound .....	375

<b>Maintenance and care</b> .....	<b>379</b>
ASSYST PLUS service interval display .....	379
Engine compartment .....	380
Cleaning and care .....	385

<b>Breakdown assistance</b> .....	<b>395</b>
Emergency .....	395
Flat tire .....	397
Battery (vehicle) .....	402
Tow starting or towing away .....	408
Electrical fuses .....	413

<b>Wheels and tires</b> .....	<b>417</b>
Notes on noise or unusual handling characteristics .....	417
Notes on regularly inspecting wheels and tires .....	417
Notes on snow chains .....	418
Tire pressure .....	419
Loading the vehicle .....	426
Tire labeling .....	430
Definition of terms for tires and loading .....	435
Changing a wheel .....	438

## 4 Contents

---

<b>Technical data</b> .....	<b>447</b>
Notes on technical data .....	447
Vehicle electronics .....	447
Vehicle identification plate, VIN and engine number .....	449
Operating fluids .....	450
Vehicle data .....	457

<b>Display messages and warning/indicator lamps</b> .....	<b>459</b>
Display messages .....	459
Warning and indicator lamps .....	504

<b>Index</b> .....	<b>518</b>
--------------------	------------



In this Operator's Manual, you will find the following symbols:

 **DANGER** Danger due to not observing the warning notices

Warning notices draw your attention to hazards that may endanger your health or life, or the health or life of others.

 Observe the warning notices.

 **ENVIRONMENTAL NOTE** Environmental damage due to failure to observe environmental notes

Environmental notes include information on environmentally responsible behavior or environmentally responsible disposal.

 Observe environmental notes.

 **NOTE** Damage to property due to failure to observe notes on material damage

Notes on material damage inform you of risks which may lead to your vehicle being damaged.

 Observe notes on material damage.

 Useful instructions or further information that could be helpful to you.

 Instruction

(→ page) Further information on a topic

**Display** Information on the multifunction display/media display

 Highest menu level, which is to be selected in the multimedia system

 Corresponding submenus, which are to be selected in the multimedia system

\* Marks a cause

6 At a glance - Cockpit

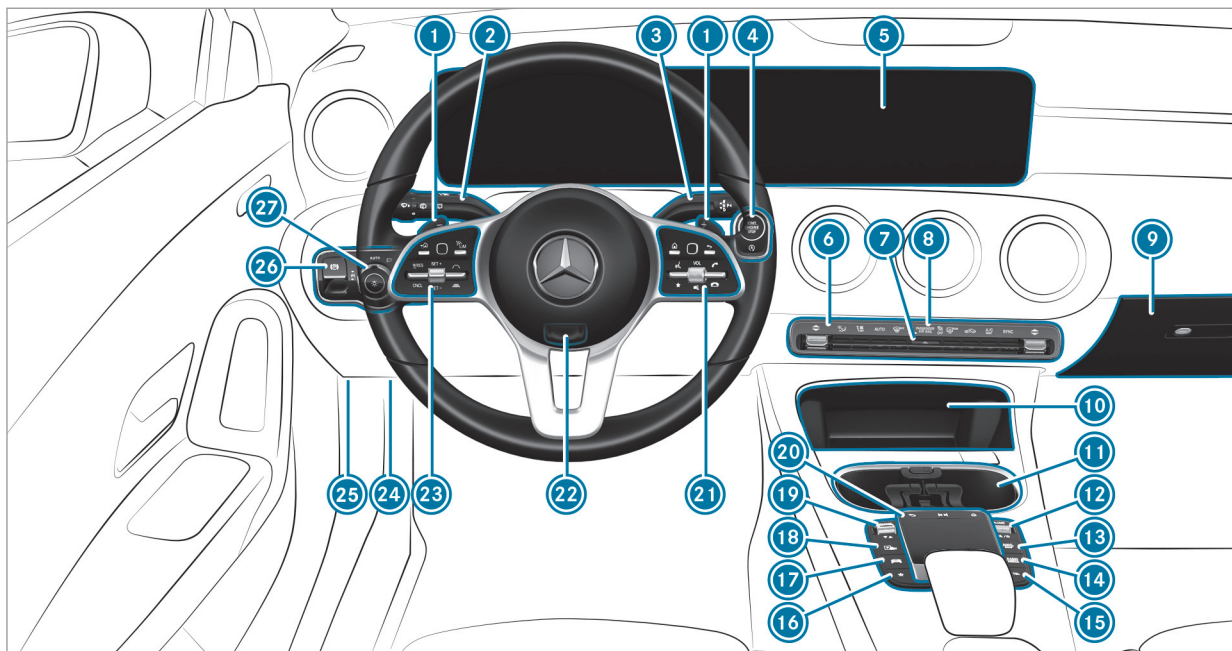

Left-hand-drive vehicles

① Steering wheel paddle shifters	→	142	⑭ Calls up the radio	→	368
② Combination switch	→	114	Calls up media	→	363
③ DIRECT SELECT lever	→	140	⑮ Calls up the telephone	→	327
④ Start/stop button	→	130	⑯ Calls up favorites	→	261
⑤ Media display	→	244	⑰ Calls up vehicle functions	→	253
⑥ Climate control systems	→	125	⑱ Active Parking Assist	→	193
⑦ Hazard warning lamps	→	115	⑲ DYNAMIC SELECT switch	→	138
⑧ PASSENGER AIR BAG indicator lamp	→	45	⑳ Touchpad	→	244
⑨ Glove box	→	99	㉑ Control panel for the MBUX multimedia system (steering wheel)	→	209
⑩ Stowage compartment	→	99	㉒ Adjusts the steering wheel	→	94
⑪ Cup holder	→	105	㉓ Control panel for:		
⑫ Control knob			On-board computer	→	209
Adjusts the volume and switches the sound on/off	→	240	Cruise control	→	169
Switches the MBUX multimedia system on/off	→	240	Active Distance Assist DISTRONIC	→	172
⑬ Calls up navigation	→	286	㉔ Diagnostics connection	→	26
			㉕ Unlocks the hood	→	380

## 8 At a glance - Cockpit

---

26 Electric parking brake



154

27 Light switch



113







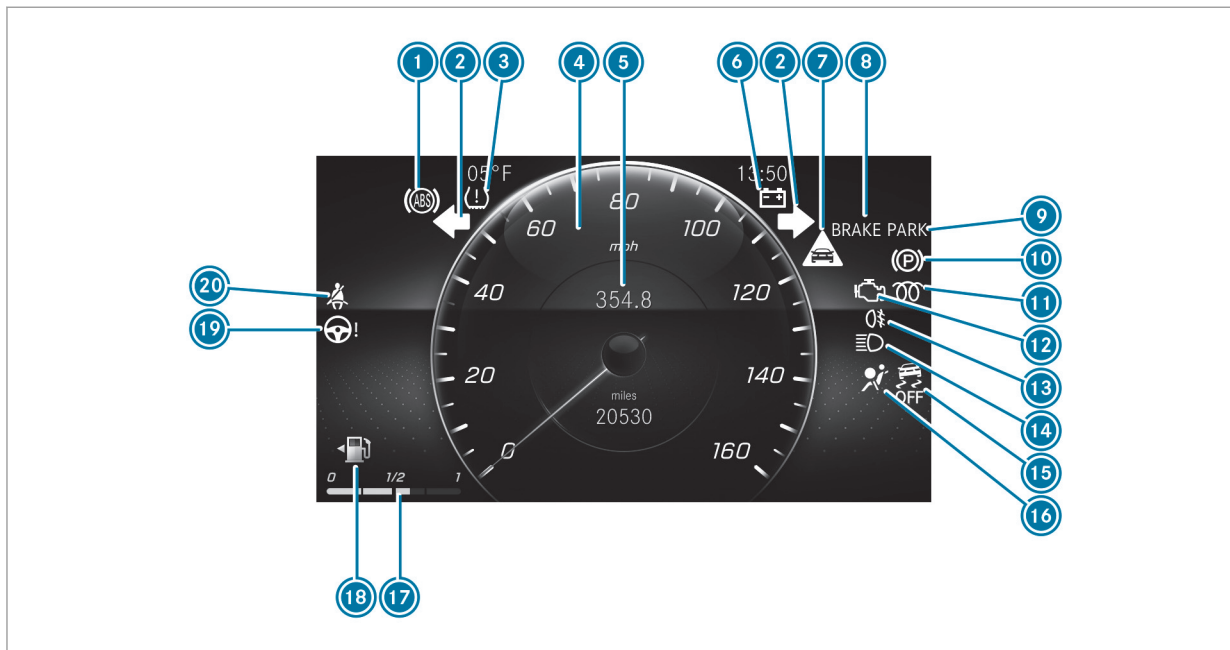



















10 At a glance - Warning and indicator lamps



Instrument Display (standard)

1		ABS malfunction	→	505
2		Turn signal lights	→	114
3		Tire pressure monitor	→	515
4		Speedometer	→	208
5		Multifunction display	→	213
6		Electrical malfunction	→	512
7		Distance warning	→	511
8		Brakes (red)	→	505
		USA only		
		Canada only		
9		Electric parking brake applied (red)	→	505
		USA only		
		Canada only		
10		Electric parking brake (yellow)	→	505





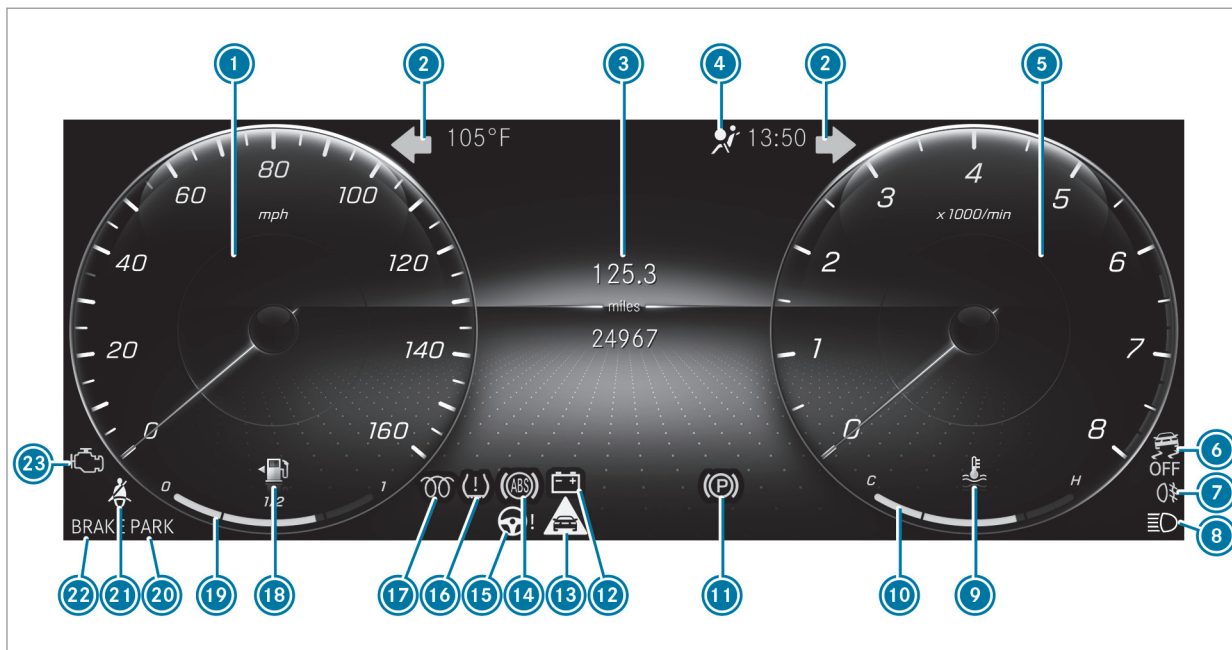

















11		This indicator lamp has no function		
12		Check Engine	→	512
13		Rear fog light	→	114
14		High beam	→	114
		Low beam	→	113
		Parking lights	→	113
15		ESP® OFF	→	505
		ESP®	→	505
16		Restraint system	→	505
17		Fuel level indicator		
18		Fuel reserve with fuel filler cap location indicator	→	512
19		Electric power steering malfunction	→	516
20		Seat belt not fastened	→	510

## 12 At a glance - Warning and indicator lamps









Instrument Display in the Widescreen Cockpit

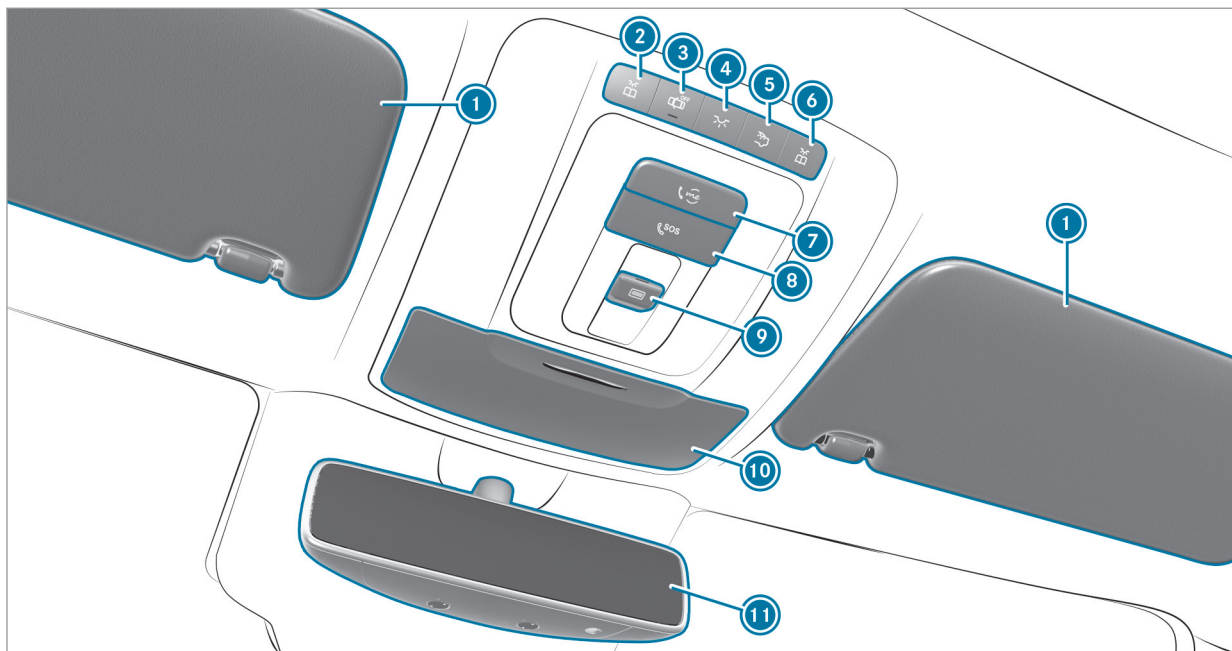

1		Speedometer	→	208	14		ABS malfunction	→	505	
2			Turn signal lights	→	114	15		Electric power steering malfunction	→	516
3		Multifunction display	→	213	16		Tire pressure monitor	→	515	
4		Restraint system	→	505	17		This indicator lamp has no function			
5		Tachometer	→	208	18		Fuel reserve with fuel filler cap location indicator	→	512	
6		ESP® OFF	→	505	19		Fuel level indicator			
		ESP®	→	505	20		Electric parking brake applied (red)	→	505	
7		Rear fog light	→	114		<b>PARK</b>	USA only			
8		High beam	→	114			Canada only			
		Low beam	→	113	21		Seat belt not fastened	→	510	
		Parking lights	→	113	22		Brakes (red)	→	505	
9		Coolant too hot/cold	→	512		<b>BRAKE</b>	USA only			
10		Coolant temperature display	→	208			Canada only			
11		Electric parking brake (yellow)	→	505	23		Check Engine	→	512	
12		Electrical malfunction	→	512						
13		Distance warning	→	511						

14 At a glance - Overhead control panel







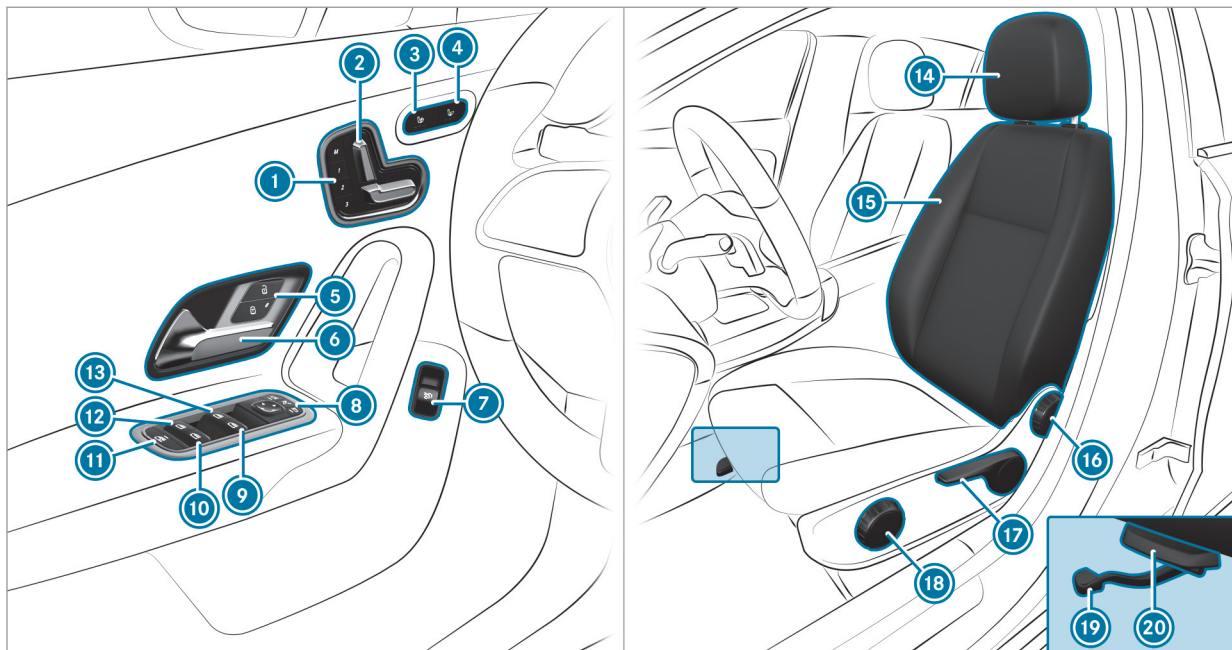

1	Sun visors	→	124
2	 Switches the left-hand reading lamp on/off	→	118
3	 Switches automatic light control on/off	→	118
4	 Switches the front interior lighting on/off	→	118
5	 Switches the rear interior lighting on/off	→	118
6	 Switches the right-hand reading lamp on/off	→	118

7	Service call button (Mercedes me connect)		
8	SOS emergency call system (Mercedes-Benz emergency call system)		
9	 Opens/closes the panoramic sliding sunroof	→	80
	Opens/closes the roller sunblinds	→	80
10	Eyeglasses compartment	→	100
11	Inside rearview mirror	→	122

16 At a glance - Door control panel and seat adjustment





① Operates the memory function	→	96	⑪ Child safety lock for the rear side windows	→	62
② Adjusts the seats electrically	→	89	⑫  Opens/closes the rear left side window	→	76
③ Switches the seat heating on/off	→	92	⑬  Opens/closes the left side window	→	76
④ Switches the seat ventilation on/off	→	93	⑭ Adjusts the head restraints	→	90
⑤   Locks/unlocks the vehicle	→	69	⑮ Seat adjustment using the multimedia system	→	92
⑥ Opens the door	→	69	⑯ Adjusts the seat backrest inclination	→	89
⑦ Opens the trunk lid	→	73	⑰ Adjusts the seat height	→	89
⑧ Operates the outside mirrors	→	121	⑱ Adjusts the seat cushion inclination	→	89
⑨  Opens/closes the right side window	→	76	⑲ Sets the seat fore-and-aft adjustment	→	89
⑩  Opens/closes the rear right side window	→	76	⑳ Adjusts the seat cushion length	→	89

18 At a glance - Emergencies and breakdowns

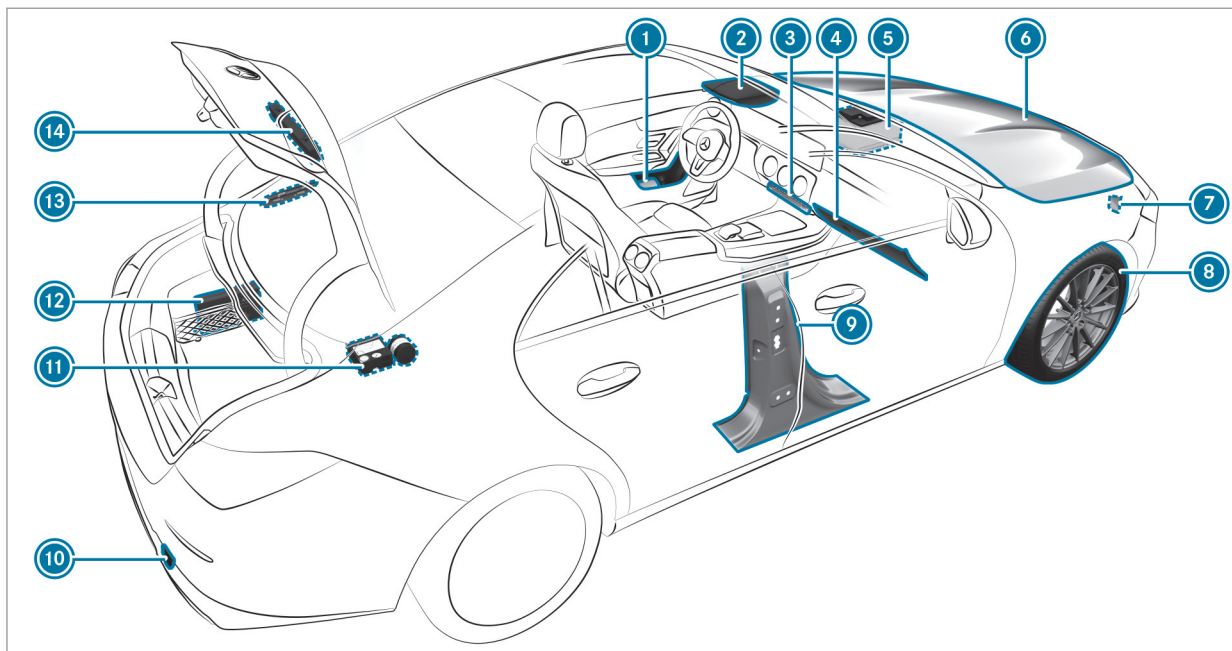

① Safety vests	→	395	⑨ QR code for accessing the rescue card	→	28
② Buttons for the SOS emergency call system and breakdown assistance			⑩ Tow-starting and towing away	→	409
③ Hazard warning lamps	→	115	⑪ TIREFIT kit	→	398
④ Glove box	→	99	⑫ First-aid kit (soft sided)	→	396
⑤ Starting assistance	→	406	⑬ Fuel filler flap with instruction labels for tire pressure, fuel type and QR code for accessing the rescue card	→	145
⑥ Checking and adding operating fluids	→	450	⑭ Warning triangle	→	396
⑦ Tow-starting and towing away	→	409			
⑧ Flat tire	→	397			

## Calling up the Digital Operator's Manual

Multimedia system:

→ [Home] » Info » Operator's Manual  
» [Info]



The Digital Operator's Manual describes the function and operation of:

- the vehicle
- the multimedia system

► Select one of the following menu items in the Digital Operator's Manual:

- **Search:** search for keywords in order to find quick answers to questions about the operation of the vehicle.
- **Quick start:** find the first steps towards setting up your vehicle.
- **Tips:** find information that prepares you for certain everyday situations with your vehicle.
- **Messages:** receive additional information about the messages in the instrument display.
- **Bookmarks:** gain access to your personally saved bookmarks.
- **Language:** select the language for the Digital Operator's Manual.

Some sections in the Digital Operator's Manual, e.g. warning notes, can be opened and closed.

### Additional methods of calling up the Digital Operator's Manual:

**Direct access:** open the required content in the Digital Operator's Manual by pressing and holding an entry on the tab bar in the multimedia system:

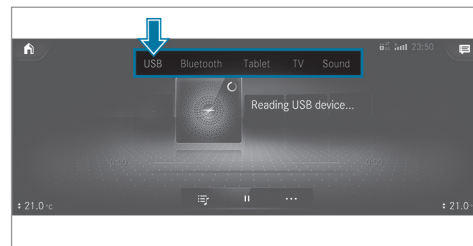

**Instrument Display:** call up brief information as display messages in the instrument cluster.

**Voice Control System:** call up via the voice control system

**Global search:** call up search results for contents of the Digital Operator's Manual in the home screen

For safety reasons, the Digital Operator's Manual is deactivated while driving.

**i** The Operator's Manual can also be found in the Mercedes-Benz Guides app in all common app stores.

## Protecting the environment

 **ENVIRONMENTAL NOTE** Environmental damage due to operating conditions and personal driving style

The pollutant emission of your vehicle is directly related to the way you operate your vehicle.

Help to protect the environment by operating your vehicle in an environmentally responsible manner. Please observe the following recommendations on operating conditions and personal driving style.

### Operating conditions:

- ▶ Make sure that the tire pressure is correct.
- ▶ Do not carry any unnecessary weight (e.g. roof luggage racks once you no longer need them).
- ▶ Adhere to the service intervals. A regularly serviced vehicle will contribute to environmental protection.

- ▶ Always have maintenance work carried out at a qualified specialist workshop.

### Personal driving style:

- ▶ Do not depress the accelerator pedal when starting the engine.
- ▶ Do not warm up the engine while the vehicle is stationary.
- ▶ Drive carefully and maintain a suitable distance from the vehicle in front.
- ▶ Avoid frequent, sudden acceleration and braking.
- ▶ Change gear in good time and use each gear only up to  $\frac{2}{3}$  of its maximum engine speed.
- ▶ Switch off the engine in stationary traffic, e.g. by using the ECO start/stop function.
- ▶ Drive fuel-efficiently. Observe the ECO display for a fuel-efficient driving style.

### Environmental issues and recommendations:

It is recommended that you re-use or recycle materials instead of just disposing of them.

The relevant environmental guidelines and regulations serve to protect the environment and must be strictly observed.

## Genuine Mercedes-Benz parts

 **ENVIRONMENTAL NOTE** Environmental damage caused by not using recycled/reconditioned components

Daimler AG offers recycled/reconditioned components and parts with the same quality as new parts. The same entitlement from the Limited Warranty is valid as for new parts.

- ▶ Use recycled/reconditioned components and parts from Daimler AG.

**!** **NOTE** Impairment of the operating efficiency of the restraint systems from installing accessory parts or from repairs or welding

Airbags and Emergency Tensioning Devices, as well as control units and sensors for the restraint systems, may be installed in the following areas of your vehicle:

- Doors
- Door pillars
- Door sills
- Seats
- Cockpit
- Instrument cluster
- Center console
- Lateral roof frame

- ▶ Do not install accessory parts such as audio systems in these areas.
- ▶ Do not carry out repairs or welding.

▶ Have aftermarket installation of accessories carried out at a qualified specialist workshop.

You could jeopardize the operating safety of your vehicle if you use parts, tires and wheels as well as accessories relevant to safety which have not been approved by Mercedes-Benz. Safety-relevant systems, e.g. the brake system, may malfunction. Only use Mercedes-Benz Genuine Parts or parts of equal quality. Only use tires, wheels and accessories that have been specifically approved for your vehicle model.

Mercedes-Benz Genuine Parts are subject to strict quality control. Each part has been specially developed, manufactured or selected for Mercedes-Benz vehicles and fine-tuned for them. Therefore, only Mercedes-Benz Genuine Parts should be used.

More than 300,000 different Mercedes-Benz Genuine Parts are available for Mercedes-Benz models.

All authorized Mercedes-Benz Centers maintain a supply of Mercedes-Benz Genuine Parts for

necessary service and repair work. In addition, strategically located parts delivery centers provide for quick and reliable parts service.

Always specify the vehicle identification number (VIN) (→ page 449) when ordering Mercedes-Benz Genuine Parts.

### Operator's Manual

This Operator's Manual describes all models and all standard and optional equipment available for your vehicle at the time of this Operator's Manual going to press. Country-specific differences are possible. Note that your vehicle may not be equipped with all features described. This is also the case for systems and functions relevant to safety. Therefore, the equipment on your vehicle may differ from that in the descriptions and illustrations.

The original purchase agreement for your vehicle contains a list of all of the systems in your vehicle.

Should you have any questions concerning equipment and operation, please consult an authorized Mercedes-Benz Center.

The Operator's Manual and Maintenance Booklet are important documents and should be kept in the vehicle.

### Service and vehicle operation

#### Vehicle operation outside the USA or Canada

When you are abroad with your vehicle, observe the following points:

- service points or replacement parts may not be available immediately.
- unleaded fuel may not be available for vehicles with a catalytic converter. Leaded fuel may cause damage to the catalytic converter.
- the fuel may have an extremely low octane number. Unsuitable fuel can cause engine damage.

Some Mercedes-Benz models are available in Europe through our European Delivery Program. For more information, please consult an authorized Mercedes-Benz service center, or write to one of the following address:

#### **in the USA:**

Mercedes-Benz USA, LLC  
European Delivery Department  
One Mercedes-Benz Drive  
Sandy Springs, GA 30328

#### **in Canada:**

Mercedes-Benz Canada, Inc.  
European Delivery Department  
98 Vanderhoof Avenue  
Toronto, Ontario M4G 4C9

#### Maintenance

Your customer advisor confirms the service in the service report.

#### Roadside Assistance

The Mercedes-Benz Roadside Assistance Program offers technical help in the case of a breakdown. Your calls to the toll-free Roadside Assistance Hotline are answered by our agents 24 hours a day, 365 days a year.

1-800-FOR-MERCEdes (1-800-367-6372) (USA)

1-800-387-0100 (Canada)

You can find further information in the Mercedes-Benz Roadside Assistance Program brochure (USA) or the "Roadside Assistance" section in the maintenance and warranty information booklet (Canada). You will find both in the vehicle document wallet.

#### Change of address or change of ownership

In the event of a change of address, please send us the "Notification of address change" in the Service and Guarantee booklet or simply call the Mercedes-Benz Customer Assistance Center (USA) on the hotline number 1-800-FOR-MERCEdes (1-800-367-6372) or Customer Service (Canada) on 1-800-387-0100. We can then reach you in a timely fashion, if necessary.

If you sell your Mercedes, please leave all literature in the vehicle so that it is available to the next owner. If you have purchased a used vehicle, please send us the "Notice of Purchase of Used Car" in the Service and Guarantee booklet or simply call the Mercedes-Benz Customer

Assistance Center (USA) at the hotline number 1-800-FOR-MERcedes (1-800-367-6372) or Customer Service (Canada) at 1-800-387-0100.

### Possible danger due to substances hazardous to health

In compliance with Proposition 65 ("Prop65"), the following detachable label has been added to each vehicle sold in California:

	<b>WARNING</b>	
<p>Operating, servicing and maintaining a passenger vehicle, pickup truck, van or off-road motor vehicle can expose you to chemicals including engine exhaust, carbon monoxide, phthalates, and lead, which are known to the State of California to cause cancer and birth defects or other reproductive harm. To minimize exposure, avoid breathing exhaust, do not idle the engine except as necessary, service your vehicle in a well-ventilated area and wear gloves or wash your hands frequently when servicing your vehicle. For more information go to <a href="http://www.P65Warnings.ca.gov/passenger-vehicle">www.P65Warnings.ca.gov/passenger-vehicle</a></p> <p style="text-align: center;"><small>A 000 817 82 02</small></p>		

### Operating safety

**⚠ WARNING** Risk of accident due to malfunctions or system failures

If you do not have the prescribed service/maintenance work or any required repairs carried out, this could result in malfunctions or system failures.

- ▶ Always have the prescribed service/maintenance work as well any required repairs carried out at a qualified specialist workshop.

**⚠ WARNING** Risk of accident and injury as a result of incorrect modifications to electronic component parts

Modification to electronic components, their software or wiring could impair their function and/or the function of other networked component parts. In particular, systems relevant to safety could also be affected.

As a result, they may no longer function as intended and/or endanger the operating safety of the vehicle.

- ▶ Never tamper with the wiring and electronic component parts or their software.
- ▶ You should have all work on electrical and electronic components carried out at a qualified specialist workshop.

Observe the "On-board electronics" section in "Technical data".

**⚠ WARNING** Risk of fire due to flammable materials on hot parts of the exhaust system

Flammable material such as leaves, grass or twigs may ignite if they come into contact with hot parts of the exhaust system.

- ▶ When driving on unpaved roads or off-road, regularly check the vehicle underside.



- ▶ Remove trapped plants or other flammable material.
- ▶ If there is damage, consult a qualified specialist workshop immediately.

#### **!** NOTE Damage to the vehicle

In the following situations, in particular, there is a risk of damage to the vehicle:

- The vehicle becomes grounded, e.g. on a high curb or an unpaved road
- The vehicle is driven too fast over an obstacle, e.g. a curb, speed bump or pothole
- A heavy object strikes the underbody or chassis components

In situations such as this, the body, the underbody, chassis components, wheels or tires could be damaged without the damage being visible. Components damaged in this way can unexpectedly fail or, in the case of an accident, may not absorb the loads that arise as intended.

If the underbody paneling is damaged, flammable materials such as leaves, grass or twigs can collect between the underbody and the underbody paneling. These materials may ignite if they come into contact with hot parts on the exhaust system.

- ▶ Have the vehicle checked and repaired immediately at a qualified specialist workshop.
- or
- ▶ If driving safety is impaired while continuing your journey, pull over and stop the vehicle immediately in accordance with the traffic conditions, and contact a qualified specialist workshop.

#### Declaration of conformity for wireless vehicle components

**USA:** "The wireless devices of this vehicle comply with Part 15 of the FCC Rules. Operation is subject to the following two conditions: 1) These devices may not cause harmful interference, and 2) These devices must accept any interference

received, including interference that may cause undesired operation. Changes or modifications not expressly approved by the party responsible for compliance could void the user's authority to operate the equipment."

**Canada:** "The wireless devices of this vehicle comply with Industry Canada license-exempt RSS standard(s). Operation is subject to the following two conditions: (1) These devices may not cause interference, and (2) These devices must accept any interference, including interference that may cause undesired operation of the device."

**USA:** "Wireless charging system for mobile devices (model: WM12 Wireless Mobile Interface): this device complies with Part 18 of the FCC Rules."

The name and address of the responsible party is:

peiker acustic GmbH  
Max-Planck-Str. 28-32  
61381 Friedrichsdorf  
Germany

### Diagnostics connection

The diagnostics connection is only intended for the connection of diagnostic devices at a qualified specialist workshop.

**⚠ WARNING** Risk of accident due to connecting devices to the diagnostics connection

If you connect equipment to a diagnostics connection in the vehicle, it may affect the operation of vehicle systems.

As a result, the operating safety of the vehicle could be affected.

- ▶ Only connect equipment to a diagnostics connection in the vehicle which is approved for your vehicle by Mercedes-Benz.

**⚠ WARNING** Risk of accident due to objects in the driver's footwell

Objects in the driver's footwell may impede pedal travel or block a depressed pedal.

This jeopardizes the operating and road safety of the vehicle.

- ▶ Stow all objects in the vehicle securely so that they cannot get into the driver's footwell.
- ▶ Always install the floor mats securely and as prescribed in order to ensure that there is always sufficient room for the pedals.
- ▶ Do not use loose floor mats and do not place floor mats on top of one another.

**! NOTE** Battery discharging from using devices connected to the diagnostics connection

Using devices at the diagnostics connection drains the battery.

- ▶ Check the charge level of the battery.
- ▶ If the charge level is low, charge the battery, e.g. by driving a considerable distance.

Connecting equipment to the diagnostics connection can lead to emissions monitoring information being reset, for example. This may lead to the vehicle failing to meet the requirements of the next emissions inspection during the main inspection.

### Qualified specialist workshop

An authorized Mercedes-Benz Center is a qualified specialist workshop. It has the necessary special skills, tools and qualifications to correctly carry out the work required on your vehicle. This particularly applies to safety-relevant works.

For the following, always have your vehicle checked at an authorized Mercedes-Benz Center:

- safety-relevant works
- service and maintenance work
- repair work
- modifications as well as installations and conversions
- work on electronic components

Mercedes-Benz recommends a Mercedes-Benz service center.

### Correct use of the vehicle

If you remove any warning stickers, you or others could fail to recognize certain dangers. Leave warning stickers in position.

Observe the following information in particular when driving your vehicle:

- the safety notes in this manual
- technical data for the vehicle
- traffic rules and regulations
- laws and safety standards pertaining to motor vehicles

### Problems with your vehicle

If you should experience a problem with your vehicle, particularly one that you believe may affect its safe operation, we urge you to contact an authorized Mercedes-Benz Center immediately to have the problem diagnosed and rectified. If the problem is not resolved to your satis-

faction, please discuss the problem again with an authorized Mercedes-Benz Center or, if necessary, contact us at one of the following addresses:

#### In the USA:

Mercedes-Benz USA, LLC  
Customer Assistance Center  
One Mercedes-Benz Drive  
Sandy Springs, GA 30328

#### In Canada:

Mercedes-Benz Canada, Inc.  
Customer Relations Department  
98 Vanderhoof Avenue  
Toronto, Ontario M4G 4C9

### Reporting safety defects

#### USA only:

The following text is published as required of manufacturers under Title 49, Code of U.S. Federal Regulations, Part 575 pursuant to the

"National Traffic and Motor Vehicle Safety Act of 1966".

If you believe that your vehicle has a defect which could cause a crash or could cause injury or death, you should immediately inform the National Highway Traffic Safety Administration (NHTSA) in addition to notifying Mercedes-Benz USA, LLC.

If NHTSA receives similar complaints, it may open an investigation, and if it finds that a safety defect exists in a group of vehicles, it may order a recall and remedy campaign. However, NHTSA cannot become involved in individual problems between you, your dealer, or Mercedes-Benz USA, LLC.

To contact NHTSA, you may call the Vehicle Safety Hotline toll-free at 1-888-327-4236 (TTY: 1-800-424-9153) (inside the USA); go to <http://www.safercar.gov>; or write to: Administrator, NHTSA, 400 Seventh Street, SW., Washington, DC 20590, USA.

Further information on vehicle safety can be found at: <http://www.safercar.gov>

### Limited Warranty

**!** **NOTE** Damage to the vehicle arising from violation of these operating instructions.

Damage to the vehicle can arise from violation of these operating instructions.

This damage is not covered either by the Mercedes-Benz implied warranty or by the New- or Used-Vehicle Warranty.

- ▶ Follow the instructions in these operating instructions on proper operation of your vehicle as well as on possible vehicle damage.

### QR code for rescue card

The QR code is secured in the fuel filler flap and on the opposite side on the B-pillar. In the event of an accident, rescue services can use the QR code to quickly find the appropriate rescue card for your vehicle. The current rescue card contains the most important information about your

vehicle in a compact form, e.g. the routing of the electric lines.

Further information can be obtained at <http://www.mercedes-benz.de/qr-code>.

### Data storage

#### Electronic control units

Electronic control units are installed in your vehicle. Some of these are necessary for the safe operation of your vehicle, while some assist you when driving (driver assistance systems). In addition, your vehicle provides comfort and entertainment functions, which are also made possible by electronic control units.

Electronic control units contain data memories which can temporarily or permanently store technical information about the vehicle's operating state, component loads, maintenance requirements and technical events or malfunctions.

In general, this information documents the state of a component part, a module, a system or the surroundings such as:

- operating status of system components (e.g. fill levels, battery status, tire pressure)
- status messages concerning the vehicle or its individual components (e.g. number of wheel revolutions/speed, longitudinal acceleration, lateral acceleration, display of fastened seat belts)
- malfunctions or faults in important system components (e.g. lights, brakes)
- information on events leading to vehicle damage
- system reactions in special driving situations (e.g. airbag deployment, intervention of stability control systems)
- ambient conditions (e.g. temperature, rain sensor)

In addition to providing the actual control unit function, this data assists the manufacturer in detecting and rectifying malfunctions and optimizing vehicle functions. The majority of this

data is temporary and is only processed in the vehicle itself. Only a small portion of the data is stored in the event or malfunction memory.

When your vehicle is serviced, technical data from the vehicle can be read out by service network employees (e.g. workshops, manufacturers) or third parties (e.g. breakdown services). Services include repair services, maintenance processes, warranty claims and quality assurance measures, for example. The read out is performed via the legally prescribed port for the diagnostics connection in the vehicle. The respective service network locations or third parties collect, process and use the data. They document technical statuses of the vehicle, assist in finding malfunctions and improving quality and are transmitted to the manufacturer, if necessary. Furthermore, the manufacturer is subject to product liability. For this, the manufacturer requires technical data from vehicles.

Fault memories in the vehicle can be reset by a service outlet as part of repair or maintenance work.

Depending on the selected equipment, you can import data into the vehicle's comfort and information functions yourself.

This includes, for example:

- multimedia data such as music, films or photos for playback in an integrated multimedia system
- address book data for use in connection with an integrated hands-free system or an integrated navigation system
- entered navigation destinations
- data about the use of Internet services

This data can be saved locally in the vehicle or it is located on a device which you have connected to the vehicle (e.g. smartphone, USB flash drive or MP3 player). If this data is stored in the vehicle, you can delete it at any time. This data is sent to third parties only at your request, particularly when you use online services in accordance with the settings that you have selected.

You can store or change convenience settings/individualization in the vehicle at any time.

Depending on the equipment, this includes, for example:

- settings for the seat and steering wheel positions
- suspension and climate control settings
- customizations such as interior lighting

If your vehicle is accordingly equipped, you can connect your smartphone or another mobile end device to the vehicle. You can control this by means of the control elements integrated in the vehicle. Images and audio from the smartphone can be output via the multimedia system. Certain information is simultaneously transferred to your smartphone.

Depending on the type of integration, this can include:

- general vehicle data
- position data

This allows you to use selected apps on your smartphone, such as navigation or music playback. There is no further interaction between the smartphone and the vehicle; in particular, vehicle data is not directly accessible. Which type of

further data processing occurs is determined by the provider of the specific app used. Which settings you can make, if any, depends on the specific app and the operating system of your smartphone.

### Online services

---

#### Wireless network connection

If your vehicle has a wireless network connection, it enables data to be exchanged between your vehicle and additional systems. The wireless network connection is enabled via the vehicle's transmission and reception unit or via connected mobile end devices (e.g. smartphones). Online functions can be used via the wireless network connection. This includes online services and applications/apps provided by the manufacturer or other providers.

#### Manufacturer's services

Regarding online services of the manufacturer, the individual functions are described by the manufacturer in a suitable place (e.g. Operator's Manual, website of the manufacturer) along with the relevant data protection information. Per-

sonal data may be used for the provision of online services. Data is exchanged via a secure connection, e.g. the manufacturer's designated IT systems. Personal data is collected, processed and used via the provision of services exclusively on the basis of legal permissions or with prior consent.

The services and functions (sometimes subject to a fee) can usually be activated or deactivated. In some cases, this also applies to the entire vehicle's data connection. This excludes, in particular, legally prescribed functions and services.

#### Third party services

If it is possible to use online services from other providers, these services are subject to the data protection and terms of use of the responsible provider. The manufacturer has no influence on the content exchanged.

Please inquire, therefore, about the type, scope and purpose of the collection and use of personal data as part of third party services from their respective provider.

### MBUX multimedia system/Mercedes me connect

---

If the vehicle is equipped with the MBUX multimedia system or Mercedes me connect, additional data about the vehicle's operation, the use of the vehicle in certain situations, and the location of the vehicle may be compiled by the MBUX multimedia system or Mercedes me connect.

For additional information, please refer to the "MBUX multimedia system" section and/or the Mercedes me connect Terms and Conditions.

### Event data recorders

---

#### USA only:

This vehicle is equipped with an event data recorder (EDR). The main purpose of an EDR is to record, in certain crash or near crash-like situations, such as an airbag deployment or hitting a road obstacle, data that will assist in understanding how a vehicle's systems performed. The EDR is designed to record data related to

vehicle dynamics and safety systems for a short period of time, typically 30 seconds or less.

The EDR in this vehicle is designed to record such data as:

- How various systems in your vehicle were operating
- Whether or not the driver and front passenger seat belts were buckled/fastened
- How far (if at all) the driver was depressing the accelerator and/or brake pedal and
- How fast the vehicle was traveling

This data can help provide a better understanding of the circumstances in which accidents and injuries occur. NOTE: EDR data is recorded by your vehicle only if a non-trivial crash situation occurs; no data is recorded by the EDR under normal driving conditions and no personal data (e.g. name, gender, age and accident location) is recorded. However, other parties, such as law enforcement, could combine EDR data with the type of personally identifying data routinely acquired during a crash investigation.

Access to the vehicle and/or the EDR is needed to read data that is recorded by the EDR, and special equipment is required. In addition to the vehicle manufacturer, other parties that have the special equipment, such as law enforcement, can read the information by accessing the vehicle or the EDR.

EDR data may be used in civil and criminal matters as a tool in accident reconstruction, accident claims and vehicle safety. Since the Crash Data Retrieval (CDR) tool that is used to extract data from the EDR is commercially available, Mercedes-Benz USA, LLC ("MBUSA") expressly disclaims any and all liability arising from the extraction of this information by unauthorized Mercedes-Benz personnel.

MBUSA will not share EDR data with others without the consent of the vehicle owner or, if the vehicle is leased, without the consent of the lessee. Exceptions to this representation include responses to subpoenas by law enforcement; by federal, state or local government; in connection with or arising out of litigation involving MBUSA or its subsidiaries and affiliates; or, as required by law.

Warning: the EDR is a component of the Restraint System Module. Tampering with, altering, modifying or removing the EDR component may result in a malfunction of the Restraint System Module and other systems.

State laws or regulations regarding EDRs that conflict with federal regulation are pre-empted. This means that in the event of such conflict, the federal regulation governs. As of December 2016, 17 states have enacted laws relating to EDRs.

### Copyright

#### Free and open source software

Information on free and open source software licenses for your vehicle's software can be found on the data storage medium in your vehicle document wallet and on the Internet together with updates:

<http://www.mercedes-benz.com/opensource>

### Registered trademarks

- Bluetooth® is a registered trademark of Bluetooth SIG Inc.
- DTS™ is a registered trademark of DTS, Inc.
- Dolby® and MLP™ are registered trademarks of DOLBY Laboratories.
- BabySmart™, ESP® and PRE-SAFE® are registered trademarks of Daimler AG.
- HomeLink® is a registered trademark of Johnson Controls.
- iPod® and iTunes® are registered trademarks of Apple Inc.
- Burmester® is a registered trademark of Burmester Audiosysteme GmbH.
- Microsoft® and Windows Media® are registered trademarks of Microsoft Corporation.
- SIRIUS® is a registered trademark of Sirius XM Radio Inc.
- HD Radio™ is a registered trademark of iBiquity Digital Corporation.
- Gracenote® is a registered trademark of Gracenote, Inc.
- ZAGATSurvey® and related brands are registered trademarks of ZagatSurvey, LLC.



## Restraint system

### Protection by the restraint system

The restraint system includes the following components:

- Seat belt system
- Airbags
- Child restraint system
- Child seat securing systems

The restraint system can help prevent the vehicle occupants from coming into contact with parts of the vehicle interior in the event of an accident. In the event of an accident, the restraint system can also reduce the forces to which the vehicle occupants are subjected.

A seat belt can only provide the best level of protection if it is worn correctly. Depending on the detected accident situation, Emergency Tensioning Devices and/or airbags supplement the protection offered by a correctly worn seat belt. Emergency Tensioning Devices and/or airbags are not deployed in every accident.

In order for the restraint system to provide the intended level of protection, each vehicle occupant must observe the following information:

- Fasten seat belts correctly.
- Sit in an almost upright seat position with their back against the seat backrest.
- Sit with their feet resting on the floor, if possible.
- Always secure persons under 5 ft (1.50 m) tall in an additional restraint system suitable for Mercedes-Benz vehicles.

However, no system available today can completely eliminate injuries and fatalities in every accident situation. In particular, the seat belt and airbag generally do not protect against objects penetrating the vehicle from the outside. It is also not possible to completely rule out the risk of injury caused by the airbag deploying.

### Limited protection from the restraint system

**▲ WARNING** Risk of injury or death from modifications to the restraint system

The restraint system can no longer function correctly after alterations have been made.

The restraint system may then not protect the vehicle occupants as intended by failing in an accident or triggering unexpectedly, for example

- ▶ Never alter the parts of the restraint system.
- ▶ Never tamper with the wiring or any electronic component parts or their software.

If it is necessary to adjust the vehicle to accommodate a person with disabilities, contact an authorized Mercedes-Benz Center for details.



USA only: contact our Customer Assistance Center at 1-800-FOR-MERCEDES (1-800-367-6372) for details.

### Restraint system functionality

When the ignition is switched on, a self-test is performed, during which the  restraint system warning lamp lights up. It goes out no later than a few seconds after the vehicle is started. The components of the restraint system are then functional.

### Malfunctioning restraint system

A malfunction has occurred in the restraint system if:

- The  restraint system warning lamp does not light up when the ignition is switched on
- The  restraint system warning lamp lights up continuously or repeatedly during a journey

**⚠ WARNING** Risk of injury due to malfunctions in the restraint system

If the restraint system is malfunctioning, restraint system components may be trig-

gered unintentionally or may not deploy as intended during an accident. This may affect the Emergency Tensioning Devices or airbags, for example.

- ▶ Have the restraint system checked and repaired immediately at a qualified specialist workshop.

### Function of the restraint system in an accident

How the restraint system works is determined by the severity of the impact detected and the type of accident anticipated:

- Frontal impact
- Rear impact
- Side impact
- Rollover

The activation thresholds for the components of the restraint system are determined based on the evaluation of the sensor values measured at various points in the vehicle. This process is pre-emptive in nature. The triggering/deployment of

the components of the restraint system must take place in good time at the start of the collision.

Factors which can only be seen and measured after a collision has occurred do not play a decisive role in the deployment of an airbag. Nor do they provide an indication of airbag deployment.

The vehicle may be deformed significantly without an airbag being deployed. This is the case if only parts which are relatively easily deformed are affected and the rate of vehicle deceleration is not high. Conversely, an airbag may be deployed even though the vehicle suffers only minor deformation. If very rigid vehicle parts such as longitudinal members are hit, for example, this may result in sufficiently high levels of vehicle deceleration.

**The components of the restraint system can be activated or deployed independently of each other:**

Component	Detected deployment situation
Emergency Tensioning Devices	Frontal impact, rear impact, side impact, rollover
Driver's airbag, front passenger front airbag	Frontal impact
Knee airbag	Frontal impact
Side airbag	Side impact
Window curtain airbag	Side impact, rollover, frontal impact

The front passenger front airbag can only be deployed in an accident if the PASSENGER AIR BAG OFF indicator lamp is off. If the front passenger seat is occupied, make sure, both before and during the journey, that the status of

the front passenger front airbag is correct (→ page 45).

**⚠ WARNING** Risk of burns from hot air bag components

The air bag parts are hot after an air bag has been deployed.

- ▶ Do not touch the air bag parts.
- ▶ Have a deployed air bag replaced at a qualified specialist workshop as soon as possible.

Mercedes-Benz recommends that you have the vehicle towed to a qualified specialist workshop after an accident. Take this into account, particularly if an Emergency Tensioning Device is triggered or an airbag deployed.

If the Emergency Tensioning Devices are triggered or an airbag is deployed, you will hear a bang, and a small amount of powder may also be released:

- The bang will not generally affect your hearing.

- In general, the powder released is not hazardous to health but may cause short-term breathing difficulties to persons suffering from asthma or other pulmonary conditions. Provided it is safe to do so, leave the vehicle immediately or open the window in order to prevent breathing difficulties.

Airbags and pyrotechnic Emergency Tensioning Devices contain perchlorate material, which may require special handling or environmental protection measures. National guidelines regarding waste disposal must be observed. In California, see <http://www.dtsc.ca.gov/HazardousWaste/Perchlorate/index.cfm>.

## Seat belts

### Protection provided by the seat belt

Always fasten your seat belt correctly before starting a journey. A seat belt can only provide the best level of protection if it is worn correctly.

**▲ WARNING** Risk of injury or death due to incorrectly fastened seat belt

If the seat belt is not worn correctly, it cannot perform its intended protective function. In addition, an incorrectly fastened seat belt can also cause injuries, for example, in the event of an accident or when braking or changing direction suddenly.

- ▶ Always ensure that all vehicle occupants have their seat belts fastened correctly and are sitting properly.

Always observe the instructions about the correct driver's seat position and adjusting the seats (→ page 88).

In order for the correctly worn seat belt to provide the intended level of protection, each vehicle occupant must observe the following information:

- The seat belt must not be twisted and must fit tightly and snugly across the body.

- The seat belt must be routed across the center of the shoulder and as low down across the hips as possible.
- The shoulder section of the seat belt should not touch your neck nor be routed under your arm or behind your back.
- Avoid wearing bulky clothing, e.g. a winter coat.
- Push the lap belt down as far as possible across your hips and pull tight with the shoulder section of the belt. Never route the lap belt across your abdomen.

Pregnant women must also take particular care with this.

- Never route the seat belt across sharp, pointed, abrasive or fragile objects.
- Only one person may use each seat belt at any one time. Infants and children must never travel sitting on the lap of a vehicle occupant.
- Never secure objects with a seat belt if the seat belt is being used by one of the vehicle's occupants. Always observe the instruc-

tions for loading the vehicle when securing objects, luggage or loads (→ page 98).

Also ensure that no objects, e.g. a cushion, are ever placed between a person and the seat.

The seat belts on the following seats are equipped with a special seatbelt retractor:

- Co-driver seat
- Rear seats

Activate or deactivate the special seatbelt retractor of the seat belt (→ page 54).

If children are traveling in the vehicle, be sure to observe the instructions and safety notes on "Children in the vehicle" (→ page 49).

### Limitations of the protection provided by the seat belt

#### **⚠ WARNING** Risk of injury or death due to incorrect seat position

The seat belt does not offer the intended level of protection if you have not moved the seat backrest to an almost vertical position.

When braking or in the event of an accident, you could slide underneath the seat belt and sustain abdominal or neck injuries, for example.

- ▶ Adjust the seat properly before beginning your journey.
- ▶ Always ensure that the seat backrest is in an almost vertical position and that the shoulder section of your seat belt is routed across the center of your shoulder.

#### **⚠ WARNING** Risk of injury or death when additional restraint systems are not used for persons with a smaller build

Persons under 5 ft (1.50 m) tall cannot wear the seat belt correctly without a suitable additional restraint system.

If the seat belt is not worn correctly, it cannot perform its intended protective function. In addition, an incorrectly fastened seat belt can also cause injuries, for example, in the event of an accident or when braking or changing direction suddenly.

- ▶ Always secure persons under 5 ft (1.50 m) tall in a suitable restraint system.

#### **⚠ WARNING** Risk of injury or death due to damaged or modified seat belts

Seat belts cannot provide protection in the following situations:

- The seat belt is damaged, has been modified, is extremely dirty, bleached or dyed

- The seat belt buckle is damaged or extremely dirty
- Modifications have been made to the Emergency Tensioning Device, seat belt anchorage or seat belt retractor

Seat belts may sustain non-visible damage in an accident, e.g. due to glass splinters.

Modified or damaged seat belts could tear or fail in the event of an accident, for example.

Modified Emergency Tensioning Devices may be deployed unintentionally or not function as intended.

- ▶ Never modify the seat belts, Emergency Tensioning Devices, seat belt anchorages or seat belt retractors.
- ▶ Make sure that the seat belts are not damaged, are not worn and are clean.
- ▶ Always have the seat belts checked immediately after an accident at a qualified specialist workshop.

Only use seat belts that have been approved for your vehicle by Mercedes-Benz.

The sport seat is designed for the standard three-point seat belt. If you install a different multipoint seat belt, e.g. sport or racing seat belt, the restraint system cannot provide the intended level of protection.

Depending on the type of seat, there may be openings in the seat backrest. These openings have no function.

**⚠ WARNING** Risk of injury or fatal injury due to modified seat belt systems

If you feed seat belts through the opening in the seat backrest, the seat backrest may be damaged or may even break in the event of an accident.

- ▶ Only use the standard three-point seat belt.
- ▶ Never modify the seat belt system.

**⚠ WARNING** Risk of injury or death from deployed pyrotechnic Emergency Tensioning Devices

Pyrotechnic Emergency Tensioning Devices that have been deployed are no longer operational and are unable to perform their intended protective function.

- ▶ Therefore, have deployed pyrotechnic Emergency Tensioning Devices immediately replaced at a qualified specialist workshop.

Mercedes-Benz recommends that you have the vehicle towed to a qualified specialist workshop after an accident.

**! NOTE** Damage caused by trapping the seat belt

If an unused seat belt is not fully retracted, it may become trapped in the door or in the seat mechanism.

- ▶ Always ensure that an unused seat belt is fully retracted.

### Fastening seat belts

If the seat belt is pulled quickly or sharply, the seat belt retractor locks. The seat belt strap cannot be pulled out any further.



- ▶ Always engage seat belt tongue ② of the seat belt into seat belt buckle ① of the corresponding seat.

### Vehicles with automatic front passenger front airbag shutoff:

**!** **NOTE** Deployment of the Emergency Tensioning Device and side air bag when the front passenger seat is unoccupied

If the seat belt tongue is engaged in the seat belt buckle of the unoccupied front passenger seat, the Emergency Tensioning Device and the side air bag may also deploy in the event of an accident along with other systems.

▶ Only one person should use each seat belt at any one time.

### Vehicles without automatic front passenger front airbag shutoff:

**!** **NOTE** Deployment of the Emergency Tensioning Device when the front-passenger seat is unoccupied

If the seat belt tongue is engaged in the seat belt buckle of the unoccupied front-passenger seat, the Emergency Tensioning

Device may also deploy in the event of an accident along with other systems.

▶ Only one person should use each seat belt at any one time.

### Seat belt adjustment function

**Vehicles with PRE-SAFE®:** If the front seat belt is not pulled tight across your body, the seat belt adjustment may automatically apply a certain tightening force. Do not hold the seat belt tightly while it is adjusting.

You can activate and deactivate the seat belt adjustment function using the multimedia system (→ page 39).

### Releasing seat belts

▶ Press the release button in the seat belt buckle and guide the seat belt back with the seat belt tongue.

### Activating/deactivating seat belt adjustment via the multimedia system

Multimedia system:

➔  ➔ Settings ➔ Vehicle

▶ Activate or deactivate **Belt Adjustment**.

### Seat belt warning function for the driver and front passenger

The  seat belt warning lamp in the Instrument Display is a reminder that all vehicle occupants must wear their seat belts correctly.

The  seat belt warning lamp lights up for six seconds every time the vehicle is started.

In addition, a warning tone may sound.

When the driver's and front passenger's doors are closed and the driver and front passenger have fastened their seat belts, the seat belt warning goes out.

In the following cases, the seat belt warning lights up during a journey if:

- The vehicle speed exceeds 15 mph (25 km/h) and the driver's or front passenger seat belt is not fastened.
- The driver or front passenger unfastens their seat belt while the vehicle is in motion.

## Airbags

### Overview of airbags

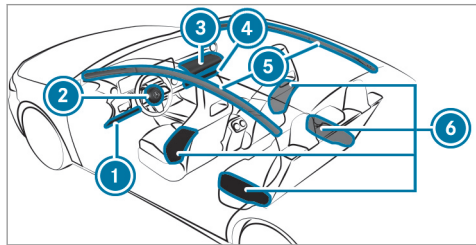

- ① Driver's knee bag
- ② Driver's airbag

- ③ Front passenger front airbag
- ④ Front passenger knee airbag
- ⑤ Window curtain airbag
- ⑥ Side airbag

The installation location of an airbag can be recognized by the AIRBAG marking.

When enabled, an airbag can provide additional protection for the respective vehicle occupant.

### Potential protection from each airbag:

AIRBAG	Potential protection for:
Knee airbag	Thigh, knee and lower leg
Driver's airbag, front passenger front airbag	Head and ribcage
Window curtain airbag	Head
Side airbag	Ribcage and pelvis

**Mercedes-AMG vehicles:** observe the notes in the Supplement. Otherwise, you may not recognize dangers.

**⚠ WARNING** Risk of injury or fatal injuries if the front-passenger airbag is enabled

If the front-passenger front airbag is enabled, a child on the front-passenger seat may be struck by the front-passenger airbag during an accident.

NEVER use a rearward-facing child restraint system on a seat with an ENABLED FRONT AIRBAG, DEATH or SERIOUS INJURY to the CHILD can occur.

When installing a child restraint system on the front passenger seat, observe the vehicle-specific information (→ page 59). Also, always observe the notes on rearward-facing or forward-facing child restraint systems on the front passenger seat.

**Vehicles with automatic front passenger front airbag shutoff:**



The front passenger front airbag can only be deployed in an accident if the PASSENGER AIR BAG OFF indicator lamp is off. If the front passenger seat is occupied, make sure, both before and during the journey, that the status of the front passenger front airbag is correct (→ page 45).

**!** **NOTE** Important points to remember if the front passenger seat is unoccupied

In an accident, the components of the restraint system may deploy unnecessarily on the front passenger side if:

- There are heavy objects on the front passenger seat.
  - The seat belt tongue is engaged in the seat belt buckle of the front passenger seat and the front passenger seat is unoccupied.
- ▶ Stow objects in a suitable place.
- ▶ Only one person should use each seat belt at any one time.

Depending on the detected accident situation, the window curtain airbag on the front passenger side may deploy. The airbag is deployed regardless of whether the front passenger seat is occupied.

### Protection by the airbags

Depending on the accident situation, an airbag may supplement the protection offered by a correctly fastened seat belt.

**!** **WARNING** Risk of injury or death due to incorrect seat position

If you deviate from the correct seat position, the airbag cannot perform its intended protective function and deployment may even cause further injuries.

In order to avoid risks, each vehicle occupant must always make sure of the following:

- Fasten seat belts correctly. Pregnant women must take particular care to

ensure that the lap belt never lies across the abdomen.

- Adopt the correct seat position and keep as far away as possible from the airbags.
  - Observe the following information.
- ▶ Always make sure that there are no objects between the airbag and vehicle occupant.

To avoid the risks resulting from the deployment of an airbag, each vehicle occupant must observe the following information in particular:

- Before starting your journey, adjust your seat correctly; the driver's seat and front passenger seat should be moved as far back as possible.

When doing so, always observe the information on the correct driver's seat position (→ page 88).

- Only hold the steering wheel by the steering wheel rim. This allows the airbag to be fully deployed.

## 42 Occupant safety

- Always lean against the seat backrest when the vehicle is in motion. Do not lean forwards or against the door or side window. You may otherwise be in the deployment area of the airbags.
- Always keep your feet on the floor. Do not put your feet on the cockpit, for example. Your feet may otherwise be in the deployment area of the airbag.
- If children are traveling in the vehicle, observe the additional notes (→ page 49).
- Always stow and secure objects correctly.

Objects in the vehicle interior may prevent an airbag from functioning correctly. Each vehicle occupant must always make sure of the following in particular:

- There are no people, animals or objects between the vehicle occupants and an airbag.
- There are no objects between the seat, door and door pillar (B-pillar).
- There are no hard objects, e.g. coat hangers, hanging on the grab handles or coat hooks.

- There are no accessory parts, such as mobile navigation devices, mobile phones or cup holders, attached to the vehicle within the deployment area of an airbag, e.g. on the cockpit, on the door, on the side window or on the side wall trim.

In addition, no connecting cables, tensioning straps or retaining straps must be routed or attached to the vehicle within the deployment area of an airbag. Always comply with the accessory manufacturer's installation instructions and, in particular, the notes on suitable places for installation.

- There are no heavy, sharp-edged or fragile objects in the pockets of your clothing. Store such objects in a suitable place.

### Limited protection from airbags

**⚠ WARNING** Risk of injury due to modifications to the airbag cover

If you modify the cover of an airbag or affix objects such as stickers to it, the airbag may no longer function correctly.

- ▶ Never modify the cover of an airbag and do not affix objects to it.

The installation location of an airbag is identified by the AIRBAG symbol (→ page 40).

**⚠ WARNING** Risk of injury or death due to the use of unsuitable seat covers

Unsuitable seat covers can obstruct or prevent the deployment of air bags integrated into the seats.

Consequently, the air bags cannot protect vehicle occupants as they are designed to do. In addition, operation of the automatic front passenger air bag shutoff may be restricted.

- ▶ You should only use seat covers that have been approved for the corresponding seats by Mercedes-Benz.

**▲ WARNING** Risk of injury due to malfunctions of the sensors in the door paneling

Sensors to control the airbags are located in the doors. Modifications or work not performed correctly to the doors or door paneling, as well as damaged doors, can lead to the function of the sensors being impaired. The airbags might therefore not function properly any more.

Consequently, the airbags cannot protect vehicle occupants as they are designed to do.

- ▶ Never modify the doors or parts of the doors.
- ▶ Always have work on the doors or door paneling carried out at a qualified specialist workshop.

**▲ WARNING** Risk of injury due to deployed airbag

A deployed airbag no longer has a protective function and cannot protect as intended in the event of an accident.

- ▶ Have the vehicle towed to a qualified specialist workshop in order to have the deployed airbag replaced.

Have deployed airbags replaced immediately.

### Status of the front passenger front airbag

#### Function of the automatic front passenger front airbag shutoff

The automatic front passenger front airbag shutoff is able to detect whether the front passenger seat is occupied by a person or a child restraint system. The front passenger front airbag and front passenger knee airbag are enabled or disabled accordingly.

When installing a child restraint system on the front passenger seat, always make sure of the following:

- Ensure that the child restraint system is positioned correctly (→ page 48).
- Always observe the child restraint system manufacturer's installation instructions.

- Never place objects, e.g. cushions, under or behind the child restraint system.
- Fully retract the seat cushion length adjustment.
- The entire base of the child restraint system must always rest on the seat cushion of the front passenger seat.
- The backrest of the forward-facing child restraint system must lie as flat as possible against the backrest of the front passenger seat.
- The child restraint system must not touch the roof or be put under strain by the head restraints. Adjust the seat backrest inclination and the head restraint setting accordingly.

**▲ WARNING** Risk of injury or death due to objects between the sitting surface and the child restraint system

Objects between the sitting surface and the child restraint system could affect the function of the automatic front passenger airbag shutoff.

This could result in the front passenger airbag not functioning as intended during an accident.

- ▶ Do not place any objects between the sitting surface and the child restraint system.
- ▶ The entire base of the child restraint system must always rest on the sitting surface of the front passenger seat.
- ▶ The backrest of the forward-facing child restraint system must, as far as possible, be resting on the seat backrest of the front passenger seat.
- ▶ Always comply with the child restraint system manufacturer's installation instructions.

A person on the front passenger seat must observe the following information:

- Fasten seat belts correctly (→ page 35).
- Sit in an almost upright seat position with their back against the seat backrest.

- Sit with their feet resting on the floor, if possible.

The front passenger front airbag may otherwise be disabled by mistake, for example in the following situations:

- The front passenger transfers their weight by supporting themselves on a vehicle armrest.
- The front passenger sits in such a way that their weight is raised from the sitting surface.

**⚠ WARNING** Risk of injury or death due to deactivated front passenger airbag

If the PASSENGER AIR BAG OFF indicator lamp is lit, the front passenger airbag is disabled. It will not be deployed in the event of an accident and cannot perform its intended protective function.

A person in the front passenger seat could then, for example, come into contact with the vehicle interior, especially if the person is sitting too close to the cockpit.

If the front passenger seat is occupied, always ensure that:

- The classification of the person in the front passenger seat is correct and the front passenger airbag is enabled or disabled in accordance with the person in the front passenger seat.
- The front passenger seat has been moved as far back as possible.
- The person is seated correctly.

▶ Ensure, both before and during the journey, that the status of the front passenger airbag is correct.

If the front passenger seat is occupied, the classification of the person or child restraint system on the front passenger seat takes place after the front passenger front airbag shutoff self-test. The PASSENGER AIR BAG indicator lamps display the status of the front passenger front airbag.

Always observe the notes on the function of the PASSENGER AIR BAG indicator lamps (→ page 45).

### Function of the PASSENGER AIR BAG indicator lamps

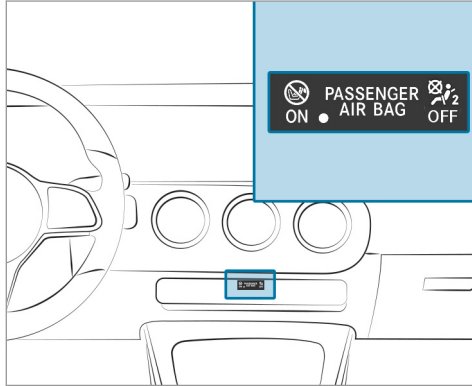

### Self-test of automatic front passenger front airbag shutoff

When the ignition is switched on, a self-test is performed during which the two PASSENGER AIR BAG ON and OFF indicator lamps light up simultaneously.

The status of the front passenger front airbag is displayed after the self-test:

- PASSENGER AIR BAG ON lights up for 60 seconds, subsequently both indicator lamps are off (PASSENGER AIR BAG ON and OFF): the front passenger front airbag is able to deploy in the event of an accident.
- PASSENGER AIR BAG OFF lights up continuously: the front passenger front airbag is disabled. It will then not be deployed in the event of an accident.

If the PASSENGER AIR BAG ON indicator lamp is off, only the PASSENGER AIR BAG OFF indicator lamp shows the status of the front passenger front airbag. The PASSENGER AIR BAG OFF indicator lamp may be lit continuously or be off.

If the PASSENGER AIR BAG OFF indicator lamp and the  restraint system warning lamp light up simultaneously, the front passenger seat may not be used. Also in this case, do not install a child restraint system on the front passenger seat. Have automatic front passenger front airbag shutoff checked and repaired immediately at a qualified specialist workshop.

### Status display

If the front passenger seat is occupied, ensure, both before and during the journey, that the status of the front passenger front airbag is correct for the current situation.

**After installing a rearward-facing child restraint system on the front passenger seat:** PASSENGER AIR BAG OFF must be lit continuously.

**⚠ WARNING** Risk of injury or death from using a rearward-facing child restraint system when the front passenger front airbag is enabled

If you secure a child in a rearward-facing child restraint system on the front passenger seat and the PASSENGER AIR BAG OFF indicator lamp is off, the front passenger airbag can deploy in the event of an accident.

The child could be struck by the airbag.

Always ensure that the front passenger airbag is deactivated. The PASSENGER AIR BAG OFF indicator lamp must be lit.

NEVER use a rearward-facing child restraint system on a seat protected by an ENABLED FRONT AIRBAG in front of it, DEATH or SERIOUS INJURY to the CHILD can occur.

When installing a child restraint system on the front passenger seat, observe the vehicle-specific information (→ page 59).

Depending on the child restraint system and the stature of the child, the PASSENGER AIR BAG OFF indicator lamp may be off. In this case, do not install the rearward-facing child restraint system on the front passenger seat.

Instead, install the rearward-facing child restraint system on a suitable rear seat.

**After installing a forward-facing child restraint system on the front passenger**

**seat:** depending on the child restraint system and the stature of the child, PASSENGER AIR BAG OFF may be lit continuously or be off. Always observe the following information.

**⚠ WARNING** Risk of injury or death due to incorrect positioning of the forward-facing child restraint system

If you secure a child in a forward-facing child restraint system on the front passenger seat and you position the front passenger seat too close to the dashboard, in the event of an accident, the child could:

- come into contact with parts of the vehicle interior if the PASSENGER AIR BAG OFF indicator lamp is lit, for example
  - be struck by the airbag if the PASSENGER AIR BAG OFF indicator lamp is off
- ▶ Always move the front passenger seat as far back as possible and fully retract the seat cushion length adjustment. Always make sure that the shoulder belt strap is correctly routed from the seat belt outlet on the vehicle to the shoulder belt guide on the child restraint system. The shoulder belt strap must be routed forwards and downwards from

the seat belt outlet. If necessary, adjust the front passenger seat accordingly.

- ▶ Always observe the child restraint system manufacturer's installation instructions.

When installing a child restraint system on the front passenger seat, observe the vehicle-specific information (→ page 59).

**If a person is sitting on the front passenger seat:** PASSENGER AIR BAG OFF may be lit continuously or be off, depending on the person's stature.

A person on the front passenger seat must always observe the following information:

- If the front passenger seat is occupied by an adult or a person with a stature corresponding to that of an adult, the PASSENGER AIR BAG OFF indicator lamp must be off. This indicates that the front passenger front airbag is enabled.

If the PASSENGER AIR BAG OFF indicator lamp is lit continuously, an adult or person

with a build corresponding to that of an adult should not use the front passenger seat.

Instead, they should use a rear seat.

- If the front passenger seat is occupied by a person of smaller stature (e.g. a teenager or small adult), the PASSENGER AIR BAG OFF indicator lamp either lights up continuously or remains off, depending on the result of the classification.
  - If the PASSENGER AIR BAG OFF indicator lamp is off: move the front passenger seat as far back as possible, or the person of smaller stature should use a rear seat.
  - If the PASSENGER AIR BAG OFF indicator lamp is lit continuously: the person of smaller stature should not use the front passenger seat.

**⚠ WARNING** Risk of injury or death when the PASSENGER AIR BAG OFF indicator lamp is lit

If the PASSENGER AIR BAG OFF indicator lamp remains lit after the system self-test, the front passenger air bag is deactivated. It will not be deployed in the event of an accident. In this case, the front passenger air bag cannot perform its intended protective function, e.g. when a person is seated in the front passenger seat.

That person could, for example, come into contact with the vehicle interior, especially if the person is sitting too close to the cockpit.

If the front passenger seat is occupied, always ensure that:

- The classification of the person in the front passenger seat is correct and the front passenger air bag is enabled or deactivated in accordance with the person in the front passenger seat.

- The person is seated properly with a correctly fastened seat belt.
- The front passenger seat has been moved as far back as possible.

Be sure to also observe the following further related subjects:

- Child restraint system on the front passenger seat (→ page 59).

#### PRE-SAFE® system

#### PRE-SAFE® (anticipatory occupant protection)

PRE-SAFE® is able to detect certain critical driving situations and implement pre-emptive measures to protect the vehicle occupants.

PRE-SAFE® can implement the following measures independently of each other:

- Tightening the seat belts on the driver's seat and front passenger seat.
- Closing the side windows.

- **Vehicles with sliding sunroof:** Closing the sliding sunroof.
- **Vehicles with memory function:** Moving the front passenger seat to a more favorable seat position.
- **PRE-SAFE® Sound:** provided that the multimedia system is switched on, generates a brief noise signal to stimulate the innate protective mechanism of a person's hearing.

**!** **NOTE** Damage caused by objects in the footwell or behind the seat

The automatic adjustment of the seat position may result in damage to the seat and/or the object.

- ▶ Stow objects in a suitable place.

### Reversing the PRE-SAFE® system measures

If an accident did not occur, the pre-emptive measures that were taken are reversed.

You will need to perform certain settings yourself.

- ▶ If the seat belt pre-tensioning is not reduced, move the seat backrest back slightly. The locking mechanism releases.

### Function of PRE-SAFE® PLUS (anticipatory occupant protection plus)

PRE-SAFE® PLUS can detect certain impacts, particularly an imminent rear impact, and take pre-emptive measures to protect the vehicle occupants. These measures cannot necessarily prevent an imminent impact.

PRE-SAFE® PLUS can implement the following measures independently of each other:

- Tightening the seat belts on the driver's seat and front passenger seat.
- Increasing brake pressure when the vehicle is stationary. This brake application is canceled automatically when the vehicle pulls away.

If an accident did not occur, the pre-emptive measures that were taken are reversed.

### System limitations

The system will not initiate any action in the following situations:

- when backing up

The system will not initiate any braking application in the following situations:

- whilst driving  
or
- when entering or exiting a parking space while using Active Parking Assist

### Safely transporting children in the vehicle

#### Always observe when children are traveling in the vehicle

- ⓘ Also strictly observe the safety notes for the specific situation. In this way you can recognize potential risks and avoid dangers if children are traveling in the vehicle (→ page 49).



**Be diligent**

Bear in mind that neglecting to secure a child in the child restraint system may have serious consequences. Always be diligent in securing a child carefully before every journey.

To improve protection for children younger than 12 years old or under 5 ft (1.50 m) in height, Mercedes-Benz recommends you observe the following information:

- Always secure the child in a child restraint system suitable for this Mercedes-Benz vehicle.
- The child restraint system must be appropriate to the age, weight and size of the child.
- The vehicle seat must be suitable for installing a child restraint system.

Accident statistics show that children secured in the rear seats are generally safer than children secured in the front seats. For this reason, Mercedes-Benz strongly advises that you install a child restraint system on a rear seat.

**Generic term "child restraint system"**

The generic term child restraint system is used in this Operator's Manual. A child restraint system is, for example:

- a baby car seat
- a rearward-facing child seat
- a forward-facing child seat
- a child booster seat with a backrest and seat belt guide

Mercedes-Benz recommends using a child booster seat with a backrest.

The child restraint system must be appropriate to the age, weight and size of the child.

**Observing laws and legal requirements**

Always observe the legal requirements when using a child restraint system in the vehicle.

**Observing standards for child restraint systems**

All child restraint systems must meet the following standards:

- U.S. Federal Motor Vehicle Safety Standards 213 and 225
- Canadian Motor Vehicle Safety Standards 213 and 210.2

Confirmation that the child restraint system complies with the standards can be found on an instruction label on the child restraint system. This confirmation can also be found in the installation instructions that are included with the child restraint system.

**Detecting risks, avoiding danger****Securing systems for child restraint systems in the vehicle**

Only use the following securing systems for child restraint systems:

- the LATCH-type (ISOFIX) mounting brackets
- the vehicle's seat belt system

- the Top Tether anchorages

Installing a LATCH-type (ISOFIX) child restraint system is preferred.

Simply attaching to the securing rings on the vehicle can reduce the risk of installing the child restraint system incorrectly.

When securing a child with the integrated seat belt of the LATCH-type (ISOFIX) child restraint system, always comply with the permissible gross weight for the child and child restraint system (→ page 55).

A booster seat may be necessary to achieve proper seat belt positioning for children over 40 lbs (18 kg) in weight or until they reach a height where a three-point seat belt can be installed properly without a booster seat.

Mercedes-Benz recommends a suitable child booster seat with a backrest and seat belt guide.

#### **Advantage of a rearward-facing child restraint system**

It is preferable to transport a baby or a small child in a suitable rearward-facing child restraint system. In this case, the child sits in the oppo-

site direction to the direction of travel and faces backwards.

Babies and small children have comparatively weak neck muscles in relation to the size and weight of their head. The risk of injury to the cervical spine during an accident can be reduced in a rearward-facing child restraint system.

#### **Always secure a child restraint system correctly**

**⚠ WARNING** Risk of injury or death caused by incorrect installation of the child restraint system

If the child restraint system is incorrectly installed on a suitable seating position, it cannot perform its intended protective function.

The child cannot be restrained in the event of an accident, heavy braking or a sudden change of direction.

- ▶ Always comply with the manufacturer's installation instructions for the child restraint system and its correct use.

- ▶ Make sure that the entire base of the child restraint system always rests on the sitting surface of the seat.
- ▶ Never place objects under or behind the child restraint system, e.g. cushions.
- ▶ Always use child restraint systems with the original cover designed for them.
- ▶ Always replace damaged covers with genuine covers.

**⚠ WARNING** Risk of injury or death from unsecured child restraint systems in the vehicle

If the child restraint system is not correctly installed or secured, it could release in the event of an accident, sudden braking or a sudden change in direction.

The child restraint system could be flung around and hit vehicle occupants.

- ▶ Always install child restraint systems correctly, even when not in use.

- ▶ Always comply with the child restraint system manufacturer's installation instructions.

- Always observe the child restraint system manufacturer's installation and operating instructions as well as the vehicle-specific information:
  - Install the LATCH-type (ISOFIX) child restraint system on the rear seat (→ page 55).
  - Secure the child restraint system with the seat belt on the rear seat (→ page 58).
  - Secure the child restraint system with the seat belt on the front passenger seat (→ page 60). Observe the specific instructions for the rearward-facing and forward-facing child restraint systems (→ page 59).

If the front passenger seat is occupied, ensure, both before and during the journey, that the status of the front passenger front airbag is correct for the current situation (→ page 45).

- Observe the warning labels in the vehicle interior and on the child restraint system.
- Also secure Top Tether if present.

#### Do not modify the child restraint system

##### **⚠ WARNING** Risk of injury due to modifications to the child restraint system

The child restraint system may no longer function as it is supposed to if you make modifications or attach objects to it, e.g. toys or unsuitable accessories. This poses an increased risk of injury!

Never modify the child restraint system. Only attach accessories which the manufacturer of the child restraint system has authorized especially for this child restraint system.

#### Only use child restraint systems which are in proper working condition

##### **⚠ WARNING** Risk of injury or death caused by the use of damaged child restraint systems

Child restraint systems or their retaining systems that have been subjected to a load in an accident may then not be able to perform their intended protective function.

The child cannot be restrained in the event of an accident, heavy braking or a sudden change of direction.

- ▶ Always replace child restraint systems immediately that have been damaged or involved in an accident.
- ▶ Have the securing systems for the child restraint systems checked at a qualified specialist workshop before installing a child restraint system again.

### Avoiding direct sunlight

**⚠ WARNING** Risk of burns when the child seat is exposed to direct sunlight

If the child restraint system is exposed to direct sunlight or heat, parts could heat up. Children could suffer burns from these parts, particularly on metallic parts of the child restraint system.

- ▶ Always make sure that the child restraint system is not exposed to direct sunlight.
- ▶ Protect it with a blanket, for example.
- ▶ If the child restraint system has been exposed to direct sunlight, allow it to cool before securing a child into it.
- ▶ Never leave children unattended in the vehicle.

### Observe when stopping or parking

**⚠ WARNING** Risk of accident and injury due to children left unattended in the vehicle

If children are left unattended in the vehicle, they could:

- Open doors, thereby endangering other persons or road users.
- Get out and be struck by oncoming traffic.
- Operate vehicle equipment and become trapped, for example.

In addition, the children could also set the vehicle in motion, for example by:

- Releasing the parking brake.
- Changing the transmission position.

- Starting the vehicle.
- ▶ Never leave children unattended in the vehicle.
- ▶ When leaving the vehicle, always take the key with you and lock the vehicle.
- ▶ Keep the vehicle key out of reach of children.

**⚠ WARNING** Risk of fatal injury due to exposure to extreme heat or cold in the vehicle

If people – particularly children – are exposed to extreme temperatures over an extended period of time, there is a risk of serious or even fatal injury.

- ▶ Never leave anyone – particularly children – unattended in the vehicle.
- ▶ Never leave animals in the vehicle unattended.

## Overview of suitable seats in the vehicle for installing a child restraint system

### Securing systems for child restraint systems

Vehicle seat		
<b>Left/right rear seat</b>	<p>Preferred securing system:</p>  LATCH-type (ISOFIX) child seat securing system	<p>Alternative securing system:</p> <ul style="list-style-type: none"> <li>• Vehicle seat belt</li> </ul>
<b>Front passenger seat</b>	<p>Securing system:</p> <ul style="list-style-type: none"> <li>• Vehicle seat belt</li> </ul>	<p>Be sure to observe:</p> <ul style="list-style-type: none"> <li>• If the front passenger seat is occupied, ensure, both before and during the journey, that the status of the front passenger front airbag is correct for the current situation (→ page 45).</li> <li>• Notes on automatic front passenger front airbag shutoff (→ page 43).</li> </ul>

## Vehicle seat

### Center rear seat

Securing system:

- Vehicle seat belt



Also secure Top Tether if present  
(→ page 57)

### Activating/deactivating the seat belt's child special seat belt retractor

**⚠ WARNING** Risk of injury or death if a seat belt is unfastened while the vehicle is in motion

If the seat belt is released while the vehicle is in motion, the child restraint system is no longer correctly secured. The child seat safety feature is deactivated and the seat belt is drawn in a bit by the inertia reel.

It is therefore not possible to engage the seat belt again.

- ▶ Pull over and stop the vehicle safely as soon as possible, paying attention to road and traffic conditions.
- ▶ Activate the child seat safety feature again and correctly secure the child restraint system.

When enabled, the special seat belt retractor ensures that the seat belts of the front passenger seat and rear seats do not slacken once the child restraint system is secured.

The seat belts on the following seats are equipped with a special seat belt retractor:

- Front passenger seat
- Rear seats

- ▶ **To install a child restraint system:** when installing a child restraint system, always observe the manufacturer's installation and operating instructions as well as the information in this Operator's Manual.
- ▶ Pull the seat belt smoothly from the seat belt outlet.
- ▶ Engage the seat belt tongue in the seat belt buckle.
- ▶ **To activate the special seat belt retractor:** pull the seat belt out fully and let the inertia reel retract it again. When the special seat belt retractor is activated, you should hear a ratcheting sound.
- ▶ Push the child restraint system down until the seat belt sits tightly.

- ▶ **To deactivate the special seat belt retractor:** press the release button of the seat belt buckle.
- ▶ Hold the seat belt tongue and guide back to the seat belt outlet.

### Installing the LATCH-type (ISOFIX) child restraint system on the rear seat

#### Installing the LATCH-type (ISOFIX) child restraint system on the rear seat

**⚠ WARNING** Risk of injury if the rear bench seat/rear seat and seat backrest are not engaged

If the rear bench seat/rear seat and seat backrest are not engaged they could fold forwards, e.g. when braking suddenly or in the event of an accident.

- If this is the case, the vehicle occupant would be forced into the seat belt by the rear bench seat/rear seat or by the seat backrest. The seat belt cannot protect as

intended and could result in additional injury.

- Objects or loads in the trunk/cargo compartment cannot be restrained by the seat backrest.
- ▶ Make sure that the seat backrest and the rear bench seat/rear seat are engaged before every trip.

If the rear seat backrest is not engaged and locked in place, the red lock verification indicator will be visible.

**⚠ WARNING** Risk of injury or death if the permissible gross mass of the child and child restraint system is exceeded

For LATCH-type (ISOFIX) child restraint systems in which the child is secured using the integrated seat belt in the child restraint system, the permissible gross mass of the child and child restraint system is 73 lb (33 kg).

If the child and the child restraint system together weigh more than 73 lb (33 kg), the

LATCH-type (ISOFIX) child restraint system with integrated seat belt does not offer sufficient protection. An excessive load may be placed on the LATCH-type (ISOFIX) child seat attachments and the child may not be restrained in the event of an accident, for example.

- ▶ If the child and the child restraint system together weigh more than 73 lb (33 kg), use only a LATCH-type (ISOFIX) child restraint system that secures the child with the vehicle seat belt.
- ▶ Also secure the child restraint system with the Top Tether belt, if available.

Always comply with the information about the mass of the child restraint system:

- in the manufacturer's installation and operating instructions for the child restraint system used
- on a label on the child restraint system, if present

Regularly check that the permissible gross mass of the child and child restraint system is still complied with.

When you are installing a child restraint system, observe the following:

- ✓ Always observe the correct use of the seats and consider their suitability for attaching a child restraint system.
- ✓ Always comply with the manufacturer's installation and operating instructions for the child restraint system used.
- ✓ Make sure that the child's feet do not touch the front seat. If necessary, move the front seat forward slightly.



When installing a LATCH-type (ISOFIX) child restraint system, observe the following:

- ✓ **When you are using a Group 0/0+ baby car seat and a Group I rearward-facing child restraint system on a rear seat:** adjust the front seat so that the seat does not touch the child restraint system.

- ✓ **When you are using a Group I forward-facing child restraint system:** remove the head restraint from the respective seat, if possible. In addition, the seat backrest of the child restraint system must, as far as possible, lie flat against the backrest of the vehicle seat.

After the child restraint system has been removed, replace the head restraints again immediately and adjust them correctly.

- ✓ For certain child restraint systems in weight group 2 or 3, there may be limitations for the maximum size setting, e.g. due to possible contact with the roof.
- ✓ The child restraint system must not be tensioned between the roof and the seat cushion and/or be installed facing the wrong direction. Where possible, adjust the seat cushion inclination accordingly.
- ✓ The child restraint system must not be put under strain by the head restraints. Adjust the head restraints accordingly.

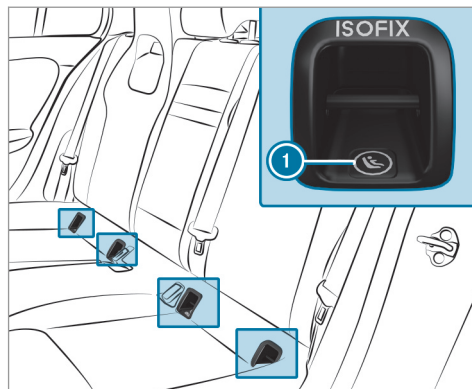

#### 1 LATCH-type (ISOFIX) mounting bracket

Before every trip, make sure that the LATCH-type (ISOFIX) child restraint system is engaged correctly in both mounting brackets in the vehicle.



**!** **NOTE** Be careful not to damage the seat belt for the center seat when installing the child restraint system

- ▶ Make sure that the seat belt is not trapped.

- ▶ Attach the LATCH-type (ISOFIX) child restraint system to both mounting brackets in the vehicle.

### Securing a Top Tether

**!** **WARNING** Risk of injury or death if the rear seat backrests are not locked after installing Top Tether belts

If the rear seat backrests are not locked, they could fold forwards in the event of an accident or during braking or sudden changes of direction.

As a result, child restraint systems cannot perform their intended protective function. Rear seat backrests that are not locked can

also cause additional injuries, e.g. in the event of an accident.

- ▶ Always lock rear seat backrests after installing Top Tether belts.
- ▶ Observe the lock verification indicator.

If the rear seat backrest is not engaged and locked in place, the red lock verification indicator will be visible.



If the child restraint system is equipped with a Top Tether belt:

The risk of injury can be reduced by a Top Tether. The Top Tether belt facilitates an additional connection between the child restraint system attached with LATCH-type (ISOFIX) and the vehicle.

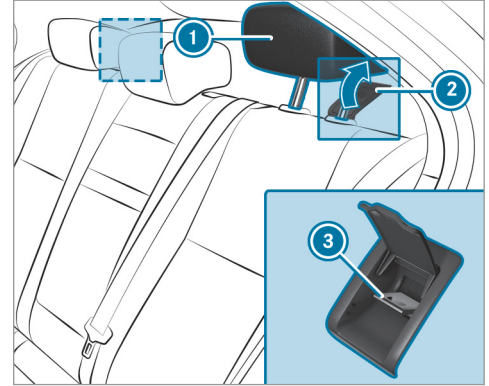

- ▶ If necessary, slide head restraint ① upwards (→ page 91).
- ▶ Fold up cover ② of Top Tether anchorage ③.
- ▶ Install the LATCH-type (ISOFIX) child restraint system with Top Tether. Always comply with the child restraint system manufacturer's installation instructions when doing so.

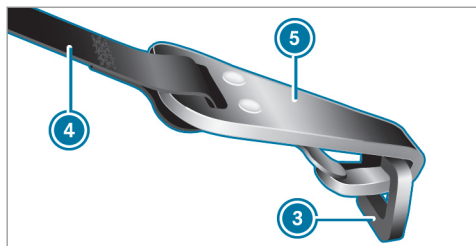

- ▶ Guide Top Tether belt ④ under head restraint ① between the two head restraint bars.
- ▶ Hook Top Tether hook ⑤ of Top Tether belt ④ into Top Tether anchorage ③ without twisting.
- ▶ Tension Top Tether belt ④. Always comply with the child restraint system manufacturer's installation instructions when doing so.
- ▶ Fold down cover ② of Top Tether anchorage ③.
- ▶ If necessary, slide head restraint ① downwards (→ page 91). Make sure that you do

not interfere with the correct routing of Top Tether belt ④.

### Securing the child restraint system with the seat belt

#### Securing the child restraint system with the seat belt on the rear seat

**⚠ WARNING** Risk of injury if the rear bench seat/rear seat and seat backrest are not engaged

If the rear bench seat/rear seat and seat backrest are not engaged they could fold forwards, e.g. when braking suddenly or in the event of an accident.

- If this is the case, the vehicle occupant would be forced into the seat belt by the rear bench seat/rear seat or by the seat backrest. The seat belt cannot protect as intended and could result in additional injury.

- Objects or loads in the trunk/cargo compartment cannot be restrained by the seat backrest.

▶ Make sure that the seat backrest and the rear bench seat/rear seat are engaged before every trip.

If the rear seat backrest is not engaged and locked in place, the red lock verification indicator will be visible.

When installing a belt-secured child restraint system, observe the following:

- ✓ Always comply with the manufacturer's installation and operating instructions for the child restraint system used.
- ✓ **When you are using a Group 0/0+ baby car seat and a Group I rearward-facing child restraint system on a rear seat:** adjust the front seat so that the seat does not touch the child restraint system.
- ✓ **When you are using a Group I forward-facing child restraint system:** remove the head restraint from the respective seat, if possible.

After the child restraint system has been removed, replace the head restraints again immediately and adjust them correctly.

- ☑ The backrest of the forward-facing child restraint system must, as far as possible, be resting on the seat backrest of the rear seat.
- ☑ For certain child restraint systems of weight category II or III there may be limitations for the maximum size setting, e.g. due to possible contact with the roof.
- ☑ The child restraint system must not be tensioned between the roof and the seat cushion and/or be installed facing the wrong direction. Where possible, adjust the seat cushion inclination accordingly.
- ☑ The child restraint system must not be put under strain by the head restraints. Adjust the head restraints accordingly.
- ☑ Make sure that the child's feet do not touch the front seat. If necessary, move the front seat forward slightly.

The seat belts on the following seats are equipped with a special seat belt retractor:

- Front passenger seat
- Rear seats

When enabled, the special seat belt retractor ensures that the seat belts of the front passenger seat and rear seats do not slacken once the child restraint system is secured (→ page 54).

- ▶ Install the child restraint system. The entire base of the child restraint system must always rest on the sitting surface of the rear seat.
- ▶ Always make sure that the shoulder belt strap is correctly routed from the seat belt outlet of the vehicle to the shoulder belt guide on the child restraint system. The shoulder belt strap must be routed forwards and downwards from the seat belt outlet.

### Notes on rearward-facing and forward-facing child restraint systems on the front passenger seat

**⚠ WARNING** Risk of injury or death from using a rearward-facing child restraint system when the front passenger front airbag is enabled

If you secure a child in a rearward-facing child restraint system on the front passenger seat and the PASSENGER AIR BAG OFF indicator lamp is off, the front passenger airbag can deploy in the event of an accident.

The child could be struck by the airbag.

Always ensure that the front passenger airbag is deactivated. The PASSENGER AIR BAG OFF indicator lamp must be lit.

NEVER use a rearward-facing child restraint system on a seat protected by an ENABLED FRONT AIRBAG in front of it, DEATH or SERIOUS INJURY to the CHILD can occur.

Observe the specific instructions for the rearward-facing and forward-facing child restraint systems (→ page 60).

Always observe the status of the front passenger front airbag on the PASSENGER AIR BAG OFF indicator lamp:

- When using a rearward-facing child restraint system on the front passenger seat, the front passenger front airbag must always be disabled. This is only the case if the PASSENGER AIR BAG OFF indicator lamp is lit continuously (→ page 45).
- If the PASSENGER AIR BAG OFF indicator lamp is off, the front passenger front airbag is enabled. The front passenger front airbag may deploy during an accident.

### Securing the child restraint system with the seat belt on the front passenger seat

When installing a belt-secured child restraint system on the front passenger seat, always observe the following:

- ☑ Observe the child restraint system manufacturer's installation and operating instructions.
- ☑ When using a forward-facing child restraint system in Group I: remove the head restraint from the respective seat, if possible.  
After the child restraint system has been removed, replace the head restraints again immediately and adjust them correctly.
- ☑ The backrest of the forward-facing child restraint system must lie as flat as possible against the backrest of the front passenger seat.
- ☑ For certain child restraint systems of weight category II or III there may be limitations for the maximum size setting, e.g. due to possible contact with the roof.

- ☑ The child restraint system must not be tensioned between the roof and the seat cushion and/or be installed facing the wrong direction. Adjust the seat backrest inclination accordingly.
- ☑ The child restraint system must not be put under strain by the head restraints. Adjust the head restraints accordingly.
- ☑ Never place objects under or behind the child restraint system, e.g. cushions.

The seat belt on the front passenger side is equipped with a special seat belt retractor.

When enabled, the special seat belt retractor function ensures that the seat belt does not slacken once the child restraint system is secured (→ page 54).

- ▶ Set the front passenger seat as far back as possible and move the seat into the highest position.
- ▶ Fully retract the seat cushion length adjustment.
- ▶ Adjust the seat cushion inclination so that the front edge of the seat cushion is in the

highest position and the rear edge of the seat cushion is in the lowest position.

- ▶ Set the seat backrest to an almost vertical position.
- ▶ Install the child restraint system. The entire base of the child restraint system must always rest on the seat cushion of the front passenger seat.
- ▶ Always make sure that the shoulder belt strap is correctly routed from the seat belt outlet of the vehicle to the shoulder belt guide on the child restraint system. The shoulder belt strap must be routed forwards and downwards from the seat belt outlet.
- ▶ If necessary, adjust the front passenger seat accordingly.

### Child safety locks

#### Activating/deactivating the child safety lock for the rear doors

**▲ WARNING** Risk of accident and injury due to children left unattended in the vehicle

If children are left unattended in the vehicle, they could:

- Open doors, thereby endangering other persons or road users.
- Get out and be struck by oncoming traffic.
- Operate vehicle equipment and become trapped, for example.

In addition, the children could also set the vehicle in motion, for example by:

- Releasing the parking brake.
- Changing the transmission position.
- Starting the vehicle.

- ▶ Never leave children unattended in the vehicle.
- ▶ When leaving the vehicle, always take the key with you and lock the vehicle.
- ▶ Keep the vehicle key out of reach of children.

**▲ WARNING** Risk of fatal injury due to exposure to extreme heat or cold in the vehicle

If people – particularly children – are exposed to extreme temperatures over an extended period of time, there is a risk of serious or even fatal injury.

- ▶ Never leave anyone – particularly children – unattended in the vehicle.
- ▶ Never leave animals in the vehicle unattended.

**⚠ WARNING** Risk of accident and injury due to children left unattended in the vehicle

If children are traveling in the vehicle, they could, in particular:

- Open doors, thereby endangering other persons or road users
- Get out and be struck by oncoming traffic
- Operate vehicle equipment and become trapped, for example

- ▶ Always activate the child safety locks installed if children are traveling in the vehicle.
- ▶ Never leave children unattended in the vehicle.
- ▶ When leaving the vehicle, always take the SmartKey with you and lock the vehicle.

There are child safety locks for the rear doors and the rear side windows.

The child safety lock on the rear doors secures each door separately. The doors can no longer be opened from the inside.

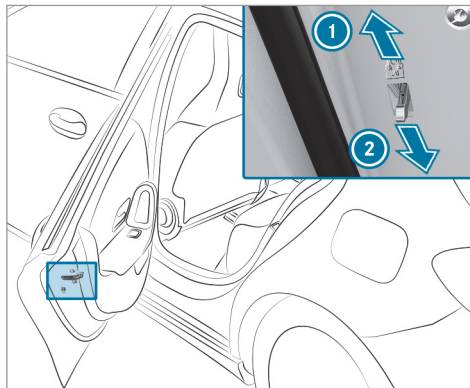

- ▶ Press the lever in direction ① (activate) or ② (deactivate).
- ▶ Make sure that the child safety locks are working properly.

### Activating/deactivating the child safety lock for the rear side windows

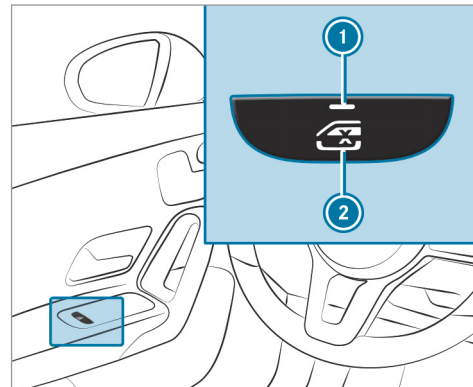

- ▶ **To activate/deactivate:** press button ②.

The rear side window can be opened or closed in the following cases:

- With indicator lamp ① lit: via the switch on the driver's door.

- With indicator lamp  off: via the switch on the corresponding rear door or driver's door.

### Notes on pets in the vehicle

 **WARNING** Risk of accident and injury due to animals left unsecured or unattended in the vehicle

If you leave animals in the vehicle unattended or unsecured, they could possibly press down buttons or switches.

Thereby an animal may:

- activate vehicle equipment and become trapped, for example
- switch systems on or off and endanger other road users

Unsecured animals may be thrown around in the vehicle in the event of an accident or sudden steering and braking maneuver and injure vehicle occupants in the process.

- ▶ Never leave animals in the vehicle unattended.
- ▶ Always correctly secure animals while driving, for example using a suitable animal carrier.

## SmartKey

### Overview of SmartKey functions

**⚠ WARNING** Risk of accident and injury due to children left unattended in the vehicle

If children are left unattended in the vehicle, they could:

- Open doors, thereby endangering other persons or road users.
- Get out and be struck by oncoming traffic.
- Operate vehicle equipment and become trapped, for example.

In addition, the children could also set the vehicle in motion, for example by:

- Releasing the parking brake.
- Changing the transmission position.
- Starting the vehicle.

▶ Never leave children unattended in the vehicle.

- ▶ When leaving the vehicle, always take the key with you and lock the vehicle.
- ▶ Keep the vehicle key out of reach of children.

**! NOTE** Damage to the key caused by magnetic fields

- ▶ Keep the key away from strong magnetic fields.

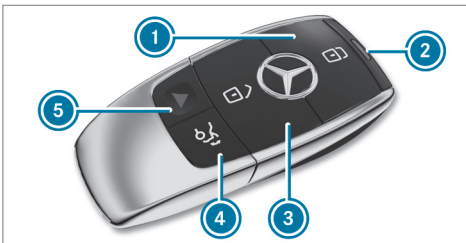

- ① Locks
- ② Battery check lamp
- ③ Unlocks

- ④ Opens the trunk lid
- ⑤ Panic alarm

ⓘ The SmartKey may vary from the one shown in the diagram, depending on the vehicle equipment.

The SmartKey locks and unlocks the following components:



- The doors
- The trunk lid
- The fuel filler flap

The indicator lamp in the door trim on the driver's side flashes when the vehicle is locked from outside. The indicator lamp goes out if the vehicle is locked from inside or while the vehicle is in motion.

If the vehicle is not opened within approximately 40 seconds after unlocking, it locks again. Anti-theft protection is activated again.

Do not keep the SmartKey together with electronic devices or metal objects. This can affect the SmartKey's functionality.



- ❗ If battery check lamp ❷ does not light up after pressing the  or  button, the battery is discharged.

Change the SmartKey battery (→ page 66).

### Activating/deactivating the acoustic locking verification signal

Multimedia system:

→  » Settings » Vehicle

- ▶ Activate or deactivate [Acoustic Lock](#).

### Activating/deactivating the panic alarm

#### Requirements:

- The ignition is switched off.
- ❗ The panic alarm function is only available in certain countries.





- ▶ **To activate:** press button ❶ for approximately one second. A visual and audible alarm is triggered.
- ▶ **To deactivate:** briefly press button ❶ again.
- or
- ▶ Press the start/stop button on the cockpit (the SmartKey is inside the vehicle).

### Changing the unlocking settings

Possible unlocking functions of the SmartKey:

- Central unlocking
- Unlocking the driver's door and fuel filler flap

- ▶ **To switch between settings:** press the  and  buttons simultaneously for approximately six seconds until the battery check lamp flashes twice.

If the unlocking function for the driver's door and fuel filler flap has been selected:

- Pressing the  button a second time centrally unlocks the vehicle
- **Vehicles with KEYLESS-GO:** if you touch the inner surface of the door handle on the driver's door, only the driver's door and fuel filler flap are unlocked.

### Deactivating the key functions

If you do not use the vehicle or a SmartKey for an extended period of time, you can reduce the energy consumption of the respective SmartKey. To do so, deactivate the key functions.

- ▶ **To deactivate:** press the  button on the SmartKey twice in quick succession. The battery check lamp of the SmartKey flashes twice briefly and lights up once.

▶ **To activate:** press any button on the SmartKey.

① When the vehicle is started with the SmartKey in the marked space of the center console, the key functions are automatically activated (→ page 130).

### Removing/inserting the emergency key

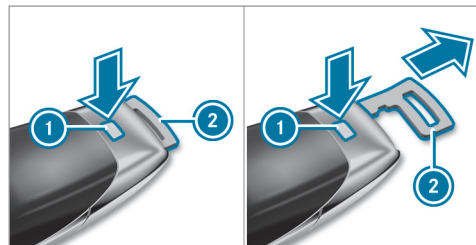

- ▶ **To remove:** press release knob ①. Emergency key ② is pushed out slightly.
- ▶ Pull out emergency key ② until it engages in the intermediate position.

① You can use the intermediate position of emergency key ② to attach the SmartKey to a key ring.

▶ Press release knob ① again and fully remove emergency key ②.

▶ **To insert:** press release knob ①.

▶ Insert emergency key ② to the intermediate position or fully until it engages.

### Replacing the SmartKey battery

**⚠ DANGER** Serious damage to health caused by swallowing batteries

Batteries contain toxic and corrosive substances. Swallowing batteries may cause serious damage to health.

There is a risk of fatal injury.

- ▶ Keep batteries out of the reach of children.
- ▶ If batteries are swallowed, seek medical attention immediately.

**🔥 ENVIRONMENTAL NOTE** Environmental damage caused by improper disposal of batteries



Batteries contain pollutants. It is illegal to dispose of them with the household rubbish.



Dispose of batteries in an environmentally responsible manner. Take discharged batteries to a qualified specialist workshop or to a collection point for used batteries.

#### Requirements:

- You require a CR 2032 3 V cell battery.

Mercedes-Benz recommends that you have the battery replaced at a qualified specialist workshop.

- ▶ Remove the emergency key (→ page 66).

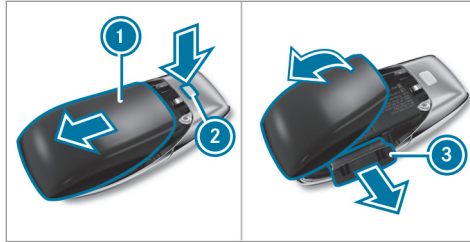

- ▶ Press release button ② down fully and slide cover ① in the direction of the arrow.
- ▶ Fold out cover ① in the direction of the arrow and remove.
- ▶ Remove battery compartment ③ and take out the discharged battery.
- ▶ Insert the new battery into battery compartment ③. Observe the positive pole marking in the battery compartment and on the battery when doing this.

- ▶ Push in battery compartment ③.
- ▶ Re-attach cover ① and push it until it engages.

### Problems with the SmartKey

Problem	Possible causes/consequences and ▶ Solutions
<p>You can no longer lock or unlock the vehicle.</p>	<p>Possible causes are:</p> <ul style="list-style-type: none"> <li>• The SmartKey battery is discharged or nearly discharged.</li> <li>• There is interference from a powerful radio signal source.</li> <li>• The SmartKey is defective.</li> </ul> <ul style="list-style-type: none"> <li>▶ Check the battery using the battery check lamp and replace if necessary (→ page 66).</li> <li>▶ Use the emergency key to lock or unlock (→ page 66).</li> </ul>

Problem	Possible causes/consequences and ► Solutions
	<ul style="list-style-type: none"><li>► Have the SmartKey checked at a qualified specialist workshop.</li></ul>
You have lost a SmartKey.	<ul style="list-style-type: none"><li>► Have the SmartKey deactivated at a qualified specialist workshop.</li><li>► If necessary, have the mechanical lock changed as well.</li></ul>

## Doors

## Unlocking and opening doors from the inside

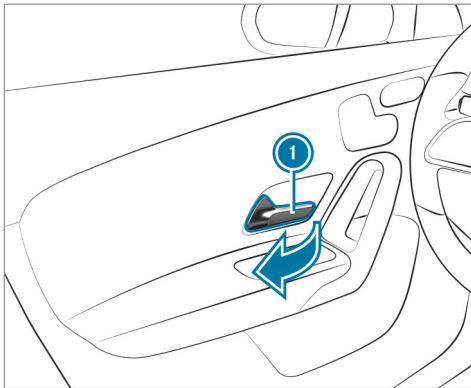

- ▶ **To unlock and open a front door:** pull door handle ①.
- ▶ **To unlock a rear door:** pull the rear door handle.
- ▶ **To open a rear door:** pull the rear door handle again.

## Centrally locking and unlocking the vehicle from the inside

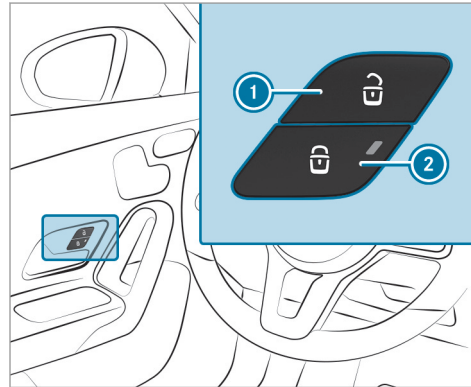

▶ **To unlock:** press button ①.

▶ **To lock:** press button ②.

The indicator lamp in the button on the driver's or front passenger door lights up.

This does not lock or unlock the fuel filler flap.

The vehicle is not unlocked:

- If you have locked the vehicle using the SmartKey.
- If you have locked the vehicle using KEY-LESS-GO.

## Locking/unlocking the vehicle with KEY-LESS-GO

## Requirements:

- The SmartKey is outside the vehicle.
- The distance between the SmartKey and the vehicle does not exceed 3 ft (1 m).
- The driver's door and the door at which the door handle is used are closed.

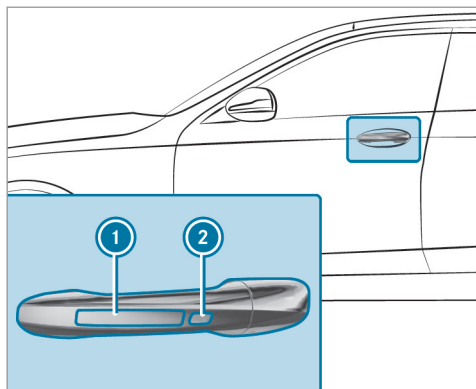

▶ **To unlock the vehicle:** touch the inner surface of the door handle.

▶ **To lock the vehicle:** touch sensor surface ① or ②.

▶ **Convenience closing:** touch recessed sensor surface ② until the closing process has been completed.

① Further information on convenience closing (→ page 78).

If you open the trunk lid from outside, the trunk lid is automatically unlocked.

## Problems with KEYLESS-GO

Problem	Possible causes/consequences and ▶ Solutions
<p>You can no longer lock or unlock the vehicle using KEYLESS-GO.</p>	<p>Possible causes are:</p> <ul style="list-style-type: none"> <li>• The key functions have been deactivated (→ page 65).</li> <li>• The SmartKey battery is discharged or nearly discharged.</li> <li>• There is interference from a powerful radio signal source.</li> </ul>

Problem	Possible causes/consequences and ► Solutions
	<ul style="list-style-type: none"> <li>• The SmartKey is faulty.</li> <li>► Activate the SmartKey functions (→ page 65).</li> <li>► Check the battery using the battery check lamp and replace if necessary (→ page 66).</li> <li>► Use the emergency key to unlock or lock the vehicle (→ page 66).</li> <li>► Have the vehicle and SmartKey checked at a qualified specialist workshop.</li> </ul>

### Activating/deactivating the automatic locking feature

The vehicle is locked automatically when the ignition is switched on and the wheels are turning faster than walking pace.

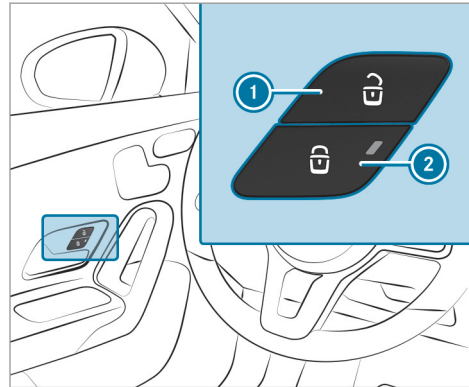

- **To activate:** press and hold button ② for approximately five seconds until an acoustic signal sounds.
- **To deactivate:** press and hold button ① for approximately five seconds until an acoustic signal sounds.

When the vehicle is locked automatically, the indicator lamp in button ② lights up.

In the following situations, there is a danger of being locked out when the function is activated:

- While the vehicle is being tow started/pushed.
- If the vehicle is being tested on the roller dynamometer.

### Locking/unlocking the vehicle with the emergency key

#### Locking/unlocking the driver's door with the emergency key

- ❗ If you wish to lock the vehicle entirely using the emergency key, first press the button for locking from the inside while the driver's door is open. Then proceed to lock the driver's door using the emergency key.

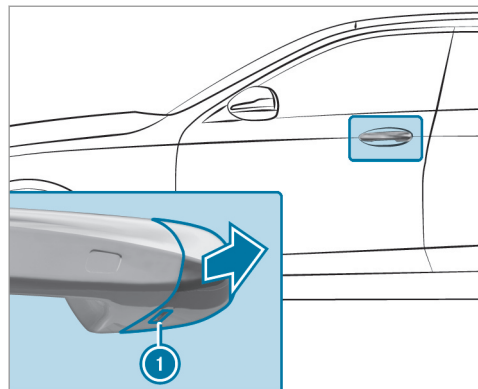

- ▶ Insert the emergency key as far as it will go into opening ① in the cover.
- ▶ Pull and hold the door handle.
- ▶ Pull the cover on the emergency key as straight as possible away from the vehicle until it releases.
- ▶ Release the door handle.

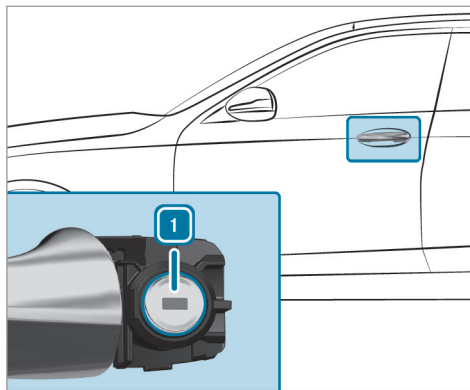

- ▶ **To unlock:** turn the emergency key counter-clockwise to position ①.
- ▶ **To lock:** turn the emergency key clockwise to position ①.
- ▶ Carefully press the cover onto the lock cylinder until it engages and is seated firmly.

#### Locking the front passenger door and rear doors with the emergency key

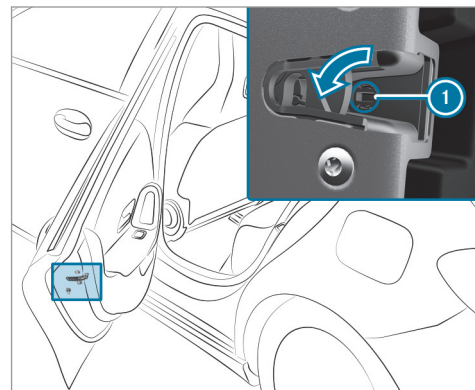



- ▶ Insert a suitable object, e.g. the emergency key, into opening ① on the door lock.
- ▶ **To lock the left-hand side of the vehicle:** turn the emergency key counter-clockwise as far as it will go.
- ▶ **To lock the right-hand side of the vehicle:** turn the emergency key clockwise as far as it will go.

If the locked door is then closed, it can no longer be opened from outside.

## Trunk

### Opening the trunk lid

#### **⚠ DANGER** Risk of exhaust gas poisoning

Combustion engines emit poisonous exhaust gases such as carbon monoxide. Exhaust gases can enter the vehicle interior if the trunk lid is open when the engine is running, especially if the vehicle is in motion.

- ▶ Always switch off the engine before opening the trunk lid.

- ▶ Never drive with the trunk lid open.

**!** **NOTE** Damage to the trunk lid by obstacles above the vehicle

The trunk lid swings upwards when it is opened.

- ▶ Therefore, make sure that there is sufficient clearance above the trunk lid.

**You have the following options for opening the trunk lid:**

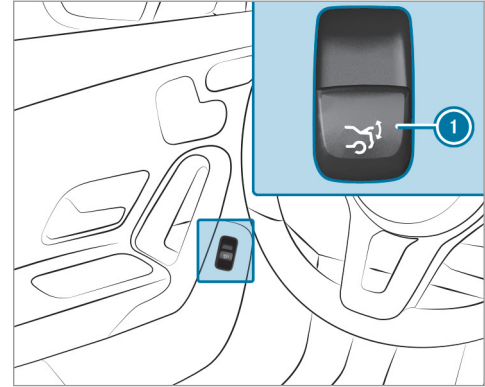

- ▶ Pull trunk lid remote operating switch ①.
- ▶ Press and hold the  button on the SmartKey.

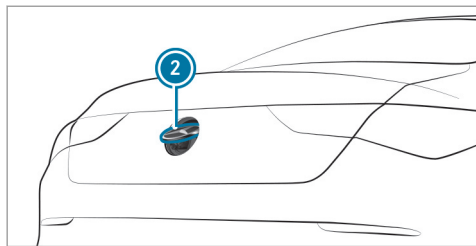

▶ With the trunk lid unlocked, press the top of Mercedes star ②.

① To open, pull on the folded-out Mercedes star when the rear view camera is active.

▶ **Vehicles with HANDS-FREE ACCESS:** Make a kicking movement with your foot below the bumper (→ page 74).

### Closing the trunk lid

**⚠ WARNING** Risk of injury from unsecured items in the vehicle

If objects, luggage or loads are not secured or not secured sufficiently, they could slip, tip over or be thrown around and thereby hit vehicle occupants.

There is a risk of injury, particularly in the event of sudden braking or a sudden change in direction.

- ▶ Always stow objects in such a way that they cannot be thrown around.
- ▶ Before the journey, secure objects, luggage or loads against slipping or tipping over.

Comply with the loading guidelines when you are loading the vehicle.

**You have the following options for closing the trunk lid:**

- ▶ Pull the trunk lid down using the handle recess and push it closed.

### HANDS-FREE ACCESS function

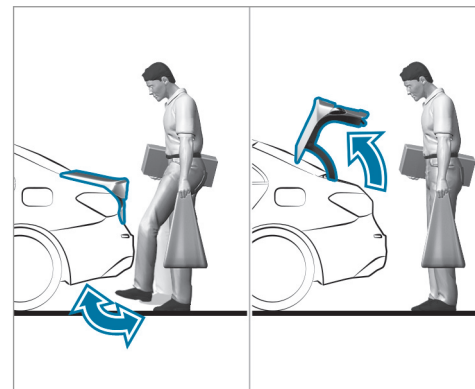

With HANDS-FREE ACCESS you can open the trunk lid by performing a kicking movement under the bumper.

Observe the notes when opening the trunk lid (→ page 73).

**⚠ WARNING** Risk of burns caused by a hot exhaust system

The vehicle exhaust system can become very hot. If you use HANDS-FREE ACCESS, you could burn yourself by touching the exhaust system.

- ▶ Always ensure that you only make a kicking movement within the detection range of the sensors.

**! NOTE** Damage to the vehicle caused by unintentionally opening the trunk lid

- When using an automatic car wash
- When using a high pressure cleaner
- ▶ Deactivate KEYLESS-GO or make sure that the SmartKey located is at least 10 ft (3 m) away from the vehicle in such situations.

When making the kicking movement, make sure that your feet are firmly on the ground, otherwise you could lose your balance, e.g. on ice.

Requirements:

- The SmartKey is behind the vehicle.
- Stand at least 12 in (30 cm) away from the vehicle while performing the kicking movement.
- Do not come into contact with the bumper while making the kicking movement.
- Do not carry out the kicking movement too slowly.
- The kicking movement must be towards the vehicle and back again.

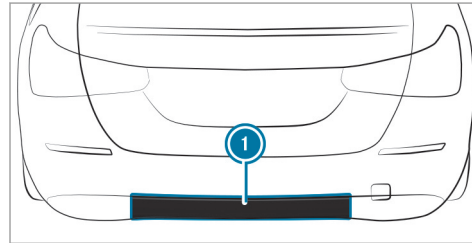

① Detection range of the sensors

If several consecutive kicking movements are not successful, wait ten seconds.

**System limits**

The system may be impaired or may not function in the following cases:

- The area around the sensor is dirty, e.g. due to road salt or snow.
- The kicking movement is made using a prosthetic leg.

The trunk lid could be opened unintentionally, in the following situations:

- If a person's arms or legs are moving in the sensor detection range, e.g. when polishing the vehicle or picking up objects.
- If objects are moved or placed behind the vehicle, e.g. tensioning straps or luggage.
- If clamping straps, tarps or other coverings are pulled over the bumper.
- If a protective mat with a length reaching over the trunk sill down into the detection range of the sensors is used.
- If the protective mat is not secured correctly.

Deactivate the SmartKey functions (→ page 65) or do not carry the SmartKey about your person in such situations.

### Unlocking the trunk with the emergency release from inside

#### Requirements

- The 12-V-vehicle battery is connected and charged.

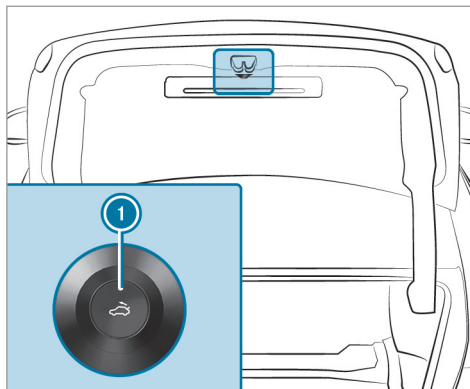

- ▶ Press emergency release button ① briefly. The trunk lid unlocks and opens.

### Side windows

#### Opening and closing the side windows

**⚠ WARNING** Risk of entrapment when opening a side window

When opening a side window, parts of the body could be drawn in or become trapped between the side window and window frame.

- ▶ When opening, make sure that nobody is touching the side window.
- ▶ If someone is trapped, release the button immediately or pull it in order to close the side window again.

**⚠ WARNING** Risk of becoming trapped when closing a side window

When closing a side window, body parts could be trapped in the closing area in the process.

- ▶ When closing, make sure that no body parts are in the closing area.

- ▶ If someone is trapped, release the button immediately or press the button in order to reopen the side window.

**⚠ WARNING** Risk of becoming trapped when children operate the side windows

Children could become trapped if they operate the side windows, particularly when unattended.

- ▶ Activate the child safety lock for the rear side windows.
- ▶ When leaving the vehicle, always take the SmartKey with you and lock the vehicle.
- ▶ Never leave children unattended in the vehicle.

**Requirements:**

- The power supply or the ignition is switched on.

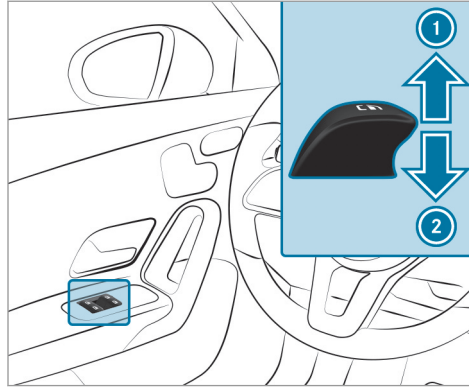

- ① Closes
- ② Opens

The buttons on the driver's door take precedence.

- ▶ **To start automatic operation:** press the  button beyond the point of resistance or pull and release it.

- ▶ **To interrupt automatic operation:** press or pull the  button again.

When the vehicle is switched off, the side windows can continue being operated.

The function is available for around five minutes or until a front door is opened.

**Automatic reversing feature of the side windows**

If an object blocks a side window during the closing process, the side window opens again automatically. The automatic reversing feature is only an aid and is not a substitute for your attentiveness.

- ▶ During the closing process, make sure that no body parts are in the closing area.

**⚠ WARNING** Risk of becoming trapped despite there being reversing protection on the side window

The reversing function does not react:

- To soft, light and thin objects, e.g. fingers
- During resetting

This means that the reverse function cannot prevent someone from becoming trapped in these situations.

- ▶ When closing, make sure that no body parts are in the closing area.
- ▶ If someone becomes trapped, press the  button to open the side window again.

### Convenience opening (ventilating the vehicle before starting a journey)

**⚠ WARNING** Risk of entrapment when opening a side window

When opening a side window, parts of the body could be drawn in or become trapped between the side window and window frame.



- ▶ When opening, make sure that nobody is touching the side window.
- ▶ Release the button immediately if somebody becomes trapped.

- ▶ Press and hold the  button on the SmartKey.

The following functions are performed:

- The vehicle is unlocked.
- The side windows are opened.
- The panoramic sliding sunroof is opened.
- The seat ventilation of the driver's seat is switched on.

If the roller sunblinds of the panoramic sliding sunroof are closed, the roller sunblinds are opened first.

- ▶ **To interrupt convenience opening:** release the  button.
- ▶ **To continue convenience opening:** press and hold the  button again.

### Convenience closing (closing the vehicle from outside)

**⚠ WARNING** Risk of entrapment caused by inadvertent convenience closing

When the convenience closing feature is operating, parts of the body could become trapped in the closing area of the side window and the sliding sunroof.

- ▶ Observe the complete closing procedure when using convenience closing.
- ▶ When closing, make sure that no body parts are in the closing area.

- ▶ Press and hold the  button on the SmartKey.

The following functions are performed:

- The vehicle is locked.
- The side windows are closed.
- The panoramic sliding sunroof is closed.

- ▶ **To interrupt convenience closing:** release the  button.

▶ **To close the roller sunblinds:** press and hold the  button again.

ⓘ Convenience closing can also be operated with KEYLESS-GO (→ page 69).

### Problems with the side windows

**⚠ WARNING** Risk of becoming trapped or fatally injured if reversing protection is not activated

If you close a side window again immediately after it has been blocked, the side window

will close with increased or maximum force. The reversing feature will then not be active.

Parts of the body could become trapped in the closing area in the process.

- ▶ Make sure that no parts of the body are in the closing area.
- ▶ To stop the closing process, release the button or press the button again to re-open the side window.

Problem	Possible causes/consequences and ▶ Solutions
A side window cannot be closed and you cannot see the cause.	<ul style="list-style-type: none"> <li>▶ Check to see whether any objects are in the window guide.</li> <li>▶ Adjust the side windows.</li> </ul> <p><b>Adjusting the side windows</b></p> <p>If a side window is obstructed during closing and reopens again immediately:</p>

Problem	Possible causes/consequences and ► Solutions
	<ul style="list-style-type: none"> <li>► Immediately after this, pull the corresponding button again until the side window has closed, and hold the button for at least one more second (re-adjustment). The side window is closed without the automatic reversing feature.</li> </ul> <p>If the side window is obstructed again and reopens again immediately:</p> <ul style="list-style-type: none"> <li>► Immediately after this, pull the corresponding button again until the side window has closed, and hold the button for at least one more second (follow-up adjustment). The side window is closed without the automatic reversing feature.</li> </ul>
<p>The side windows cannot be opened or closed using the convenience opening feature.</p>	<p>The SmartKey battery is discharged or nearly discharged.</p> <ul style="list-style-type: none"> <li>► Check the battery using the battery check lamp and replace if necessary (→ page 66).</li> </ul>

### Sliding sunroof

#### Opening and closing the sliding sunroof

- ❗ The term "sliding sunroof" also refers to the panoramic sliding sunroof.

**⚠ WARNING** Risk of becoming trapped while opening and closing the sliding sunroof

During opening and closing, parts of the body could get caught in the sweep of the sliding sunroof.

- When opening or closing, make sure that no body parts are in the sweep.

- Release the button immediately if somebody becomes trapped.

or

- Press the button in any direction during the automatic opening/closing process. The opening/closing process is stopped.



- ⚠ WARNING** Risk of becoming trapped if the sliding sunroof is operated by children

Children operating the sliding sunroof could get caught in the moving parts, particularly if unattended.

- ▶ Never leave children unattended in the vehicle.
- ▶ When leaving the vehicle, always take the key with you and lock the vehicle.

- ⚠ WARNING** Risk of becoming trapped while opening and closing the roller sun blind

When opening or closing, make sure that no body parts become trapped between the roller sun blind and frame or the sliding sunroof.

- ▶ When opening or closing, make sure that no body parts are in the sweep of the roller sun blind.

- ▶ Release the button immediately if somebody becomes trapped.

or

- ▶ Press the button in any direction during the automatic opening/closing process. The opening/closing process is stopped.

- ! NOTE** Malfunction caused by snow and ice

Snow and ice may lead to a malfunction of the sliding sunroof.

- ▶ Only open the sliding sunroof if it is free of snow and ice.

- ! NOTE** Damage caused by protruding objects

Objects that protrude from the sliding sunroof may damage the sealing strips.

- ▶ Do not allow anything to protrude from the sliding sunroof.

- ! NOTE** Important points to remember when a roof rack is installed

When a roof rack is installed, raising or opening the sliding sunroof may be limited.

- ▶ Check whether the sliding sunroof can be raised or opened when a roof rack is installed.
- ▶ If in doubt, do not raise or open the sliding sunroof.

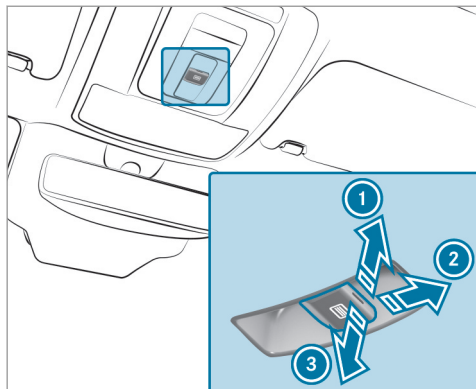



- ① Raises
- ② Opens
- ③ Closes/lowers

Use the  button to operate the panoramic sliding sunroof and the roller sunblind.

- The panoramic sliding sunroof can be operated only when the roller sunblind is open.

- The roller sunblind can be operated only when the panoramic sliding sunroof is closed.

- ▶ **To start automatic operation:** press the  button beyond the point of resistance or pull and release it.
- ▶ **To interrupt automatic operation:** briefly press the  button in any direction. The opening/closing process will be stopped.

#### **Vehicles with a panoramic sliding sunroof:**

The automatic raising feature is available only when the sliding sunroof is closed or raised.

#### **Automatic reversing feature of the sliding sunroof**

If an object is obstructing the sliding sunroof during the closing process, the sliding sunroof will open again automatically. The automatic reversing feature is only an aid and is not a substitute for your attentiveness.

- ▶ During the closing process, make sure that no body parts are in the closing area.

**⚠ WARNING** Risk of entrapment even with the reversing function active

The reversing feature does not react in particular:

- To soft, light and thin objects, e.g. fingers
- Over the last 1/8 in (4 mm) of the closing path
- During resetting

This means that the reverse function cannot prevent someone from becoming trapped in these situations.

- ▶ When closing, make sure that no body parts are in the closing area.
- ▶ Release the button immediately if somebody becomes trapped.

or

- ▶ Briefly press the button in any direction during automatic operation. The closing process is stopped.

### Automatic reversing feature of the roller sunblind

If an object is obstructing the roller sunblind during the closing process, the roller sunblind will open again automatically. The automatic reversing feature is only an aid and is not a substitute for your attentiveness.

- ▶ When closing the roller sunblind, make sure that no body parts are in the range of movement.

#### **⚠ WARNING** Risk of becoming trapped despite reversing feature

In particular, the reversing feature does not react to soft, light and thin objects, e.g. fingers.

This means that the reversing feature cannot prevent entrapment in these situations.

- ▶ When closing the roller sunblind, make sure that no body parts are in the range of movement.
- ▶ Release the button immediately if somebody becomes trapped.

or

- ▶ Press the button in any direction during the automatic closing process. The closing process is stopped.

### Automatic functions of the sliding sunroof

- ① The term "sliding sunroof" also refers to the panoramic sliding sunroof.

By pushing or pulling the  button, you can interrupt the automatic functions: "Rain closing function when driving" and "Automatic lowering".

**Rain closing function when driving**  
**Vehicles with a panoramic sliding sunroof:** If it starts to rain, the raised sliding sunroof is automatically lowered while the vehicle is in motion.

**Automatic lowering function**  
**Vehicles with a panoramic sliding sunroof:** If the sliding sunroof is raised at the rear, it is

automatically lowered slightly at higher speeds. At low speeds, it is raised again automatically.

#### **⚠ WARNING** Risk of entrapment by automatic lowering of the sliding sunroof



At high speeds the raised sliding sunroof automatically lowers slightly at the rear.

This could trap you or other persons.

- ▶ Make sure that nobody reaches into the sweep of the sliding sunroof whilst the vehicle is in motion.
- ▶ If somebody becomes trapped, briefly push the sliding sunroof button forwards or backwards. The sliding sunroof lifts during opening.

### Problems with the sliding sunroof

- ① The term "sliding sunroof" also refers to the panoramic sliding sunroof.

Problem	Possible causes/consequences and ► Solutions
The sliding sunroof cannot be closed and you cannot see the cause.	<p><b>▲ WARNING</b> Risk of becoming trapped or fatal injury by closing the sliding sunroof again</p> <p>If you close the sliding sunroof again immediately after it has been blocked or reset, the sliding sunroof closes with increased force.</p> <p>Parts of the body could become trapped in the closing area in the process.</p> <ul style="list-style-type: none"><li>▶ Make sure that no parts of the body are in the closing area.</li><li>▶ Release the button immediately if somebody becomes trapped.</li></ul> <p>or</p> <ul style="list-style-type: none"><li>▶ Press the button in any direction during the automatic closing process. The closing process is stopped.</li></ul> <p>If the sliding sunroof is obstructed during closing and reopens again slightly:</p> <ul style="list-style-type: none"><li>▶ Immediately after automatic reversing, pull and hold the  button down again to the point of resistance until the sliding sunroof is closed. The sliding sunroof will be closed with increased force.</li></ul> <p>If the sliding sunroof is obstructed again and reopens again slightly:</p> <ul style="list-style-type: none"><li>▶ Repeat the previous step. The sliding sunroof will be closed again with increased force.</li></ul>
<b>Vehicles with a panoramic sliding sunroof:</b> The sliding sunroof or the	<ul style="list-style-type: none"><li>▶ Pull and hold the  button little by little until the sliding sunroof is fully closed.</li></ul>

Problem	Possible causes/consequences and ► Solutions
roller sunblind does not operate smoothly.	<ul style="list-style-type: none"> <li>► Pull and hold the  button little by little until the roller sunblind is fully closed.</li> <li>► Use automatic operation to fully open and then close the sliding sunroof.</li> </ul>

## Anti-theft protection

### Function of the immobilizer

The immobilizer prevents your vehicle from being started without the correct SmartKey.

The immobilizer is automatically activated when the ignition is switched off and deactivated when the ignition is switched on.

When leaving the vehicle, always take the SmartKey with you and lock the vehicle. Anyone can start the engine if a valid SmartKey has been left inside the vehicle.

- i** In the event the engine cannot be started (yet the vehicle's starter battery is charged), the system is not operational. Contact an authorized Mercedes-Benz Center or call 1-800-FOR-MERCEDES (in the USA) or 1-800-387-0100 (in Canada).

## ATA (anti-theft alarm system)

### Function of the ATA system

If the ATA system is armed, a visual and audible alarm is triggered in the following situations:

- when a door is opened
- when the trunk lid is opened
- when the hood is opened
- when the interior motion sensor is triggered (→ page 87)
- when the tow-away alarm is triggered (→ page 86)

The ATA system is armed automatically after approximately ten seconds in the following situations:

- after locking the vehicle with the SmartKey
- after locking the vehicle using KEYLESS-GO

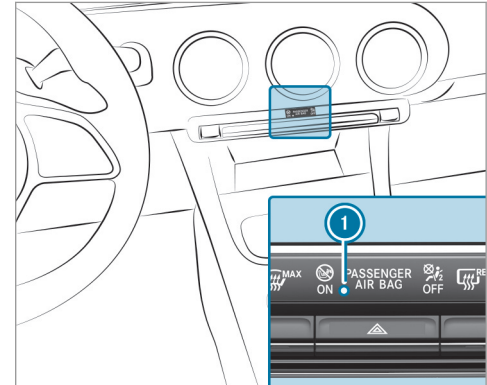

Indicator lamp **1** flashes when the ATA system is armed.

The ATA system is deactivated automatically in the following situations:

- after unlocking the vehicle with the SmartKey
- after unlocking the vehicle using KEYLESS-GO
- after pressing the start/stop button with the SmartKey in the stowage compartment (→ page 130)

- ① When the Mercedes-Benz emergency call system is active and the alarm stays on for more than 30 seconds, a message is automatically sent to the Customer Assistance Center (→ page 351).
- ① In the case of severe battery discharging, the anti-theft alarm system is automatically deactivated to facilitate the next engine start.

#### Deactivating the ATA

▶ Press the ,  or  button on the SmartKey.

or

▶ Press the start/stop button with the SmartKey in the stowage compartment (→ page 130)

#### Deactivating the alarm using KEYLESS-GO:

▶ Grasp the outside door handle with the SmartKey outside the vehicle.

#### Function of the tow-away alarm

① This function may not be available in all countries.

An audible and visual alarm is triggered if an alteration to your vehicle's angle of inclination is detected while the tow-away alarm is armed.



The tow-away alarm is automatically armed after about 60 seconds:

- after locking the vehicle with the SmartKey
- after locking the vehicle using KEYLESS-GO

The tow-away alarm is only armed when the following components are closed:

- the doors
- the trunk lid

The tow-away alarm is automatically deactivated:

- after pressing the  or  button on the SmartKey
- after pressing the start/stop button with the SmartKey in the stowage compartment (→ page 130)
- after unlocking the vehicle using KEYLESS-GO
- when using HANDS-FREE ACCESS

Information on detecting damage on a parked vehicle (→ page 156).

#### Arming/disarming the tow-away alarm

Multimedia system:

- ▶   ▶ Settings
- ▶ Schnellzugriff (Quick access)

▶ Activate or deactivate **Tow-away Protection**.

The tow-away alarm is armed again in the following cases:

- The vehicle is unlocked again.

- A door is opened.
  - The vehicle is locked again.
- i** If quick access is unavailable, select the **Vehicle** submenu in the **Settings** main menu to arm or disarm the tow-away alarm.

### Function of the interior motion sensor

- i** This function may not be available in all countries.

When the interior motion sensor is activated, a visual and audible alarm is triggered if movement is detected in the vehicle interior.



The interior motion sensor is activated automatically after approximately ten seconds:

- after locking the vehicle with the SmartKey
- after locking the vehicle using KEYLESS-GO

The interior motion sensor is only activated when the following components are closed:

- the doors
- the trunk lid

The interior motion sensor is automatically deactivated:

- after pressing the  or  button on the SmartKey
- after pressing the start/stop button with the SmartKey in the stowage compartment (→ page 130)
- after unlocking the vehicle using KEYLESS-GO
- when using HANDS-FREE ACCESS

The following situations can lead to a false alarm:

- moving objects such as mascots in the vehicle interior
- when the side window is open
- when the panoramic sliding sunroof is open

### Activating/deactivating the interior motion sensor

Multimedia system:

-   **Settings**  
 **Schnellzugriff** (Quick access)

-  Activate or deactivate **Interior Motion Sensor**.

The interior motion sensor is activated again in the following cases:

- The vehicle is unlocked again.
- A door is opened.
- The vehicle is locked again.

- i** If quick access is unavailable, select the **Vehicle** menu under **Settings** to activate or deactivate the interior motion sensor.

### Notes on the correct driver's seat position

**⚠ WARNING** Risk of injury from adjusting the vehicle settings while the vehicle is in motion

You could lose control of the vehicle in the following situations:

- if you adjust the driver's seat, the head restraint, the steering wheel or the mirror while the vehicle is in motion
- if you fasten your seat belt while the vehicle is in motion

► Before starting the engine: adjust the driver's seat, the head restraint, the steering wheel or the mirror and fasten your seat belt.

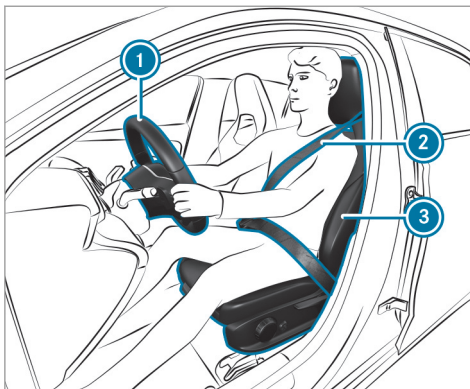

Ensure the following when adjusting steering wheel ①, seat belt ② and driver's seat ③:

- you are as far away from the driver's airbag as possible
- you are sitting in an upright position
- your thighs are slightly supported by the seat cushion

- your legs are not fully extended and you can depress the pedals properly
- the back of your head is supported at eye level by the center of the head restraint
- you can hold the steering wheel with your arms slightly bent
- you can move your legs freely
- you can see all the displays on the instrument cluster clearly
- you have a good overview of the traffic conditions
- your seat belt is pulled snugly against your body and is routed across the center of your shoulder and across your hips in the pelvic area



## Seats

### Adjusting the front seat mechanically (with Seat Comfort Package)

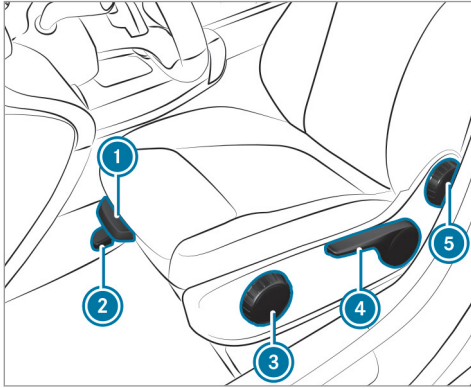

- ▶ **To adjust the seat cushion length:** lift the lever ① and slide the front section of the seat cushion forwards or backwards.

- ▶ **To adjust the seat fore-and-aft position:** lift lever ② and slide the seat into the desired position.
- ▶ Make sure that the seat is engaged in position.
- ▶ **To adjust the seat cushion inclination:** turn the handwheel ③ forwards and backwards until the desired position has been reached.
- ▶ **To adjust the seat height:** push or pull lever ④ until the desired position has been reached.
- ▶ **To adjust the seat backrest inclination:** turn handwheel ⑤ forwards and backwards until the desired position has been reached.

### Adjusting the front seat electrically

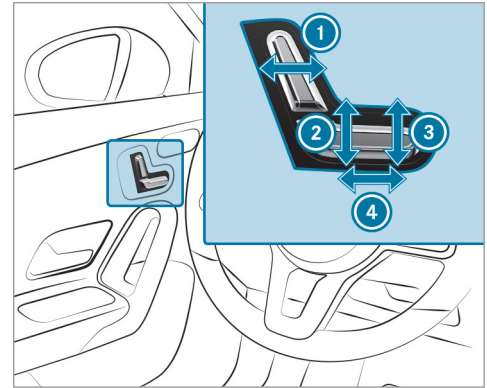

- ① Seat backrest inclination
  - ② Seat height
  - ③ Seat cushion inclination
  - ④ Seat fore-and-aft position
- ▶ Save the settings with the memory function (→ page 96).

### Adjusting the 4-way lumbar support

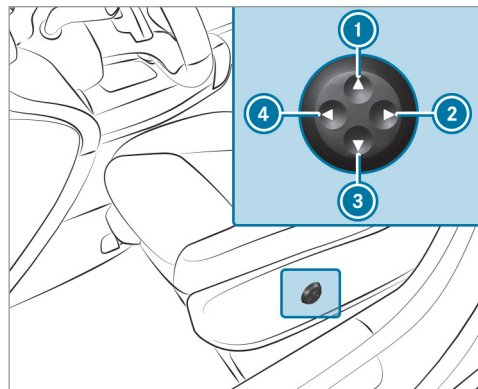

- ① Raise
- ② Soften
- ③ Lower
- ④ Harden

▶ Using buttons ① to ④, adjust the contour of the backrest individually to suit your back.

### Head restraints

#### Adjusting the front seat head restraints mechanically

**⚠ WARNING** Risk of injury from adjusting the vehicle settings while the vehicle is in motion

You could lose control of the vehicle in the following situations:

- if you adjust the driver's seat, the head restraint, the steering wheel or the mirror while the vehicle is in motion
  - if you fasten your seat belt while the vehicle is in motion
- ▶ Before starting the engine: adjust the driver's seat, the head restraint, the steering wheel or the mirror and fasten your seat belt.

**⚠ WARNING** Risk of injury due to head restraints which are not installed or are adjusted incorrectly

If head restraints are not installed or are adjusted incorrectly, the head restraints cannot provide protection as intended.

There is an increased risk of injury in the head and neck area, e.g. in the event of an accident or when braking.

- ▶ Always drive with the head restraints installed.
- ▶ Before driving off, make sure for every vehicle occupant that the center of the head restraint supports the back of the head at about eye level.

Do not interchange the head restraints of the front and rear seats. Otherwise, you will not be able to adjust the height and angle of the head restraints correctly.

Adjust the head restraint fore-and-aft position so that it is as close as possible to the back of your head.

For vehicles with sports seats, it is not possible to adjust the front head restraints.

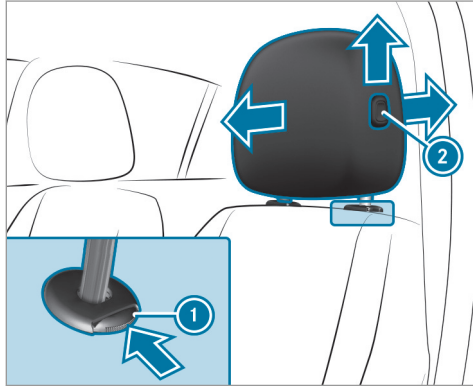

- ▶ **To raise:** pull the head restraint up.
- ▶ **To lower:** press release knob ① in the direction of the arrow and push the head restraint down.
- ▶ **To move forwards:** press release knob ② and pull the head restraint forwards.

- ▶ **To move backwards:** press release knob ② and push the head restraint backwards.

### Adjusting the head restraints of the rear seats mechanically

For vehicles with sports seats, it is not possible to adjust the outer head restraints.

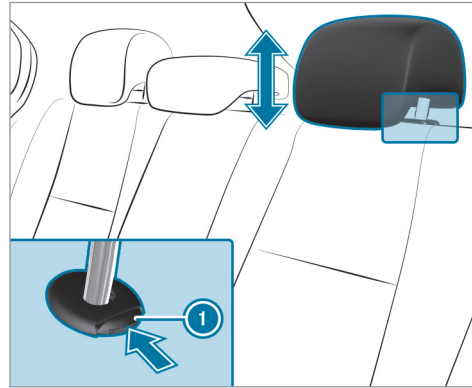



- ▶ **To raise:** pull the head restraint up.

- ▶ **To lower:** press release knob ① in the direction of the arrow and push the head restraint down.

### Installing/removing the rear seat head restraints

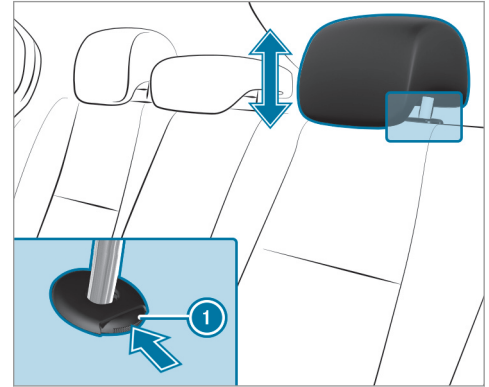
#### Removal



- ▶ Release the rear seat backrest and fold it forwards slightly (→ page 100).
- ▶ Pull the head restraint upwards as far as it will go.
- ▶ Push release knob  in the direction of the arrow and pull out the head restraint.

### Installing

- ▶ Insert the head restraint such that the notches on the bar are on the left when viewed in the direction of travel.
- ▶ Push the head restraint down until it engages.
- ▶ Fold the rear seat backrest back until it engages.

### Configuring the seat settings

Multimedia system:

 ▶ Comfort ▶ Seat Comfort

#### Adjusting the seat contour in the lumbar region of the seat backrest (lumbar)

- ▶ Select Lumbar.

- ▶ Select the settings  for the desired seat.
- ▶ Adjust the air cushions.

#### Adjusting the backrest side bolsters

- ▶ Select Side Bolsters.
- ▶ Adjust the air cushion for the desired seat.

**Mercedes-AMG vehicles:** observe the notes in the Supplement. Otherwise, you may not recognize dangers.

### Selecting the massage program for the front seats

Multimedia system:

 ▶ Comfort ▶ Massage

- ▶ Select a seat.
- ▶ Select Wave Massage or Pulsating Massage. The selected program will start.
- ▶ **To set the massage intensity:** switch High Intensity on or off .

### Resetting seat settings

Multimedia system:

 ▶ Comfort ▶ Seat Comfort

- ▶ Select Reset.
- ▶ Select  for the desired seat. The settings for the selected seat are reset.

### Switching the seat heating on/off

**⚠ WARNING** Risk of burns due to repeatedly switching on the seat heating

Repeatedly switching on the seat heating can cause the seat cushion and seat backrest padding to become very hot.

The health of persons with limited temperature sensitivity or a limited ability to react to high temperatures may be affected or they may even suffer burn-like injuries.

- ▶ Do not repeatedly switch on the seat heating.

To protect against overheating, the seat heating may be temporarily deactivated after it is switched on repeatedly.

**!** **NOTE** Damage to the seats caused by objects or documents when the seat heater is switched on

When the seat heater is switched on, overheating can occur due to objects or documents placed on the seats e.g. seat cushions or child seats. This could cause damage to the seat surface.

▶ Make sure that no objects or documents are on the seats when the seat heater is switched on.

#### Requirements:

- The power supply is switched on.

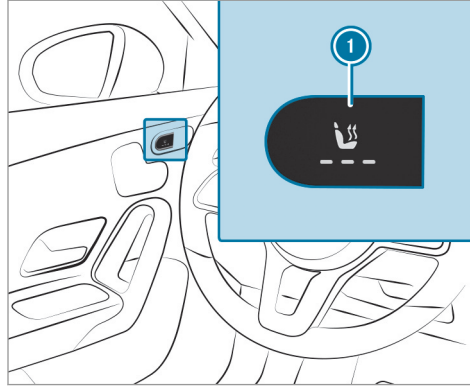

▶ **To switch on/increase the level:** press button ① repeatedly until the desired heating level is set.  
Depending on the heating level, up to three indicator lamps will light up.

▶ **To switch off/reduce the level:** press button ① repeatedly until the desired heating level is set.  
If all indicator lamps are off, the seat heating is switched off.

① The seat heating will automatically switch down from the three heating levels after 8, 10 and 20 minutes until the seat heating switches off.

#### Switching the seat ventilation on/off

##### Requirements:

- The power supply is switched on.

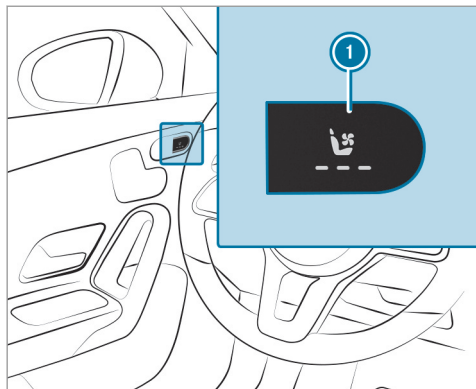

- ▶ **To switch on/increase the level:** press button ① repeatedly until the desired ventilation level is set.  
Depending on the ventilation level, up to three indicator lamps will light up.

- ▶ **To switch off/reduce the level:** press button ① repeatedly until the desired ventilation level is set.  
If all indicator lamps are off, the seat ventilation is switched off.

### Steering wheel

#### Adjusting the steering wheel manually

- ⚠ **WARNING** Risk of injury from adjusting the vehicle settings while the vehicle is in motion

You could lose control of the vehicle in the following situations:

- if you adjust the driver's seat, the head restraint, the steering wheel or the mirror while the vehicle is in motion
- if you fasten your seat belt while the vehicle is in motion
- ▶ Before starting the engine: adjust the driver's seat, the head restraint, the

steering wheel or the mirror and fasten your seat belt.

- ⚠ **WARNING** Risk of entrapment for children when adjusting the steering wheel

Children could injure themselves if they adjust the steering wheel.

- ▶ Never leave children unattended in the vehicle.
- ▶ When leaving the vehicle, always take the SmartKey with you and lock the vehicle.

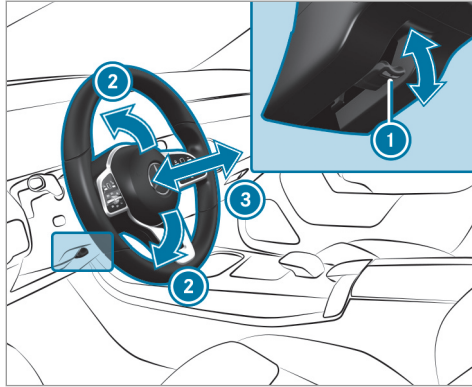

- ▶ Push release lever ① down as far as it will go. The steering column is unlocked.
- ▶ Adjust height ② and distance ③ to the steering wheel.
- ▶ Push release lever ① up as far as it will go. The steering column is locked.
- ▶ Check and make sure that the steering column is locked by moving the steering wheel.

### Switching the steering wheel heater on/off

#### Requirements:

- The ignition is switched on.

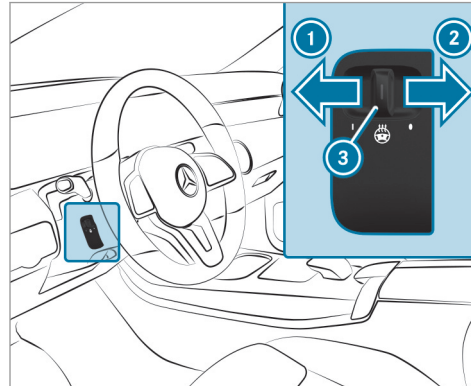

- ▶ Push the switch to position ① or ②. If indicator lamp ③ lights up, the steering wheel heater is switched on.

When you switch the ignition off, the steering wheel heater will switch off.

### Easy entry and exit feature

#### Using the easy entry and exit feature

**⚠ WARNING** Risk of accident when driving off while adjusting the easy exit feature

- If you drive off while the easy entry and exit feature is making adjustments, you could lose control of the vehicle.

- ▶ Always wait until the adjustment process is complete before driving off.

**⚠ WARNING** Risk of becoming trapped while adjusting the easy entry and exit feature

When the easy entry and exit feature adjusts the driver's seat, you and other vehicle occupants – particularly children – could become trapped.

- ▶ During the adjustment process of the easy entry and exit feature, make sure that no one has any body parts in the sweep of the seat.

If there is a risk of becoming trapped by the driver's seat:

- ▶ Press the seat adjustment switch.
- ▶ The adjustment process is stopped.

You can stop the adjustment process by pressing one of the memory function position switches.

**⚠ WARNING** Risk of becoming trapped during activation of the easy entry and exit feature by children

If children activate the easy entry and exit feature, they can become trapped, particularly when unattended.

- ▶ Never leave children unattended in the vehicle.
- ▶ When leaving the vehicle, always take the SmartKey with you and lock the vehicle.

When the easy entry and exit feature is active, the driver's seat will move backwards and the backrest will be moved to a steeper position when:

- You switch the ignition off with the driver's door open
- You open the driver's door with the ignition switched off

**i** The driver's seat will move backwards only if it is not already in the rearmost position. The seat backrest will move forwards only if it is not already in the foremost position.

The driver's seat will move back to the last drive position when:

- You switch the ignition on with the driver's door closed
- You close the driver's door with the ignition switched on

The last drive position will be stored when:

- You switch the ignition off
- You call up the seat settings via the memory function

- You save the seat setting using the memory function

### Setting the easy entry and exit feature

Multimedia system:

▶  ▶ Settings ▶ Fahrzeug (Vehicle)

▶ Easy Entry/Exit

▶ Activate or deactivate the function.

### Operating the memory function

**⚠ WARNING** Risk of an accident if the memory function is used while driving

If you use the memory function on the driver's side while driving, you could lose control of the vehicle as a result of the adjustments being made.

- ▶ Only use the memory function on the driver's side when the vehicle is stationary.



**⚠ WARNING** Risk of entrapment when setting the seat with the memory function

When the memory function adjusts the seat or steering wheel, you and other vehicle occupants – particularly children – could become trapped.

- ▶ During the setting procedure of the memory function, ensure that no body parts are in the sweep of the seat or the steering wheel.
- ▶ If somebody becomes trapped, immediately release the memory function position button. The adjustment process is stopped.

**⚠ WARNING** Risk of entrapment if the memory function is activated by children

Children could become trapped if they activate the memory function, particularly when unattended.

- ▶ Never leave children unattended in the vehicle.

- ▶ When leaving the vehicle, always take the SmartKey with you and lock the vehicle.

The memory function can be used when the ignition is switched off.

**Storing**

Seat adjustments for up to three people can be stored and called up using the memory function.

The following systems can be selected:

- Seat, backrest and head restraint
- Outside mirrors
- Head-up Display

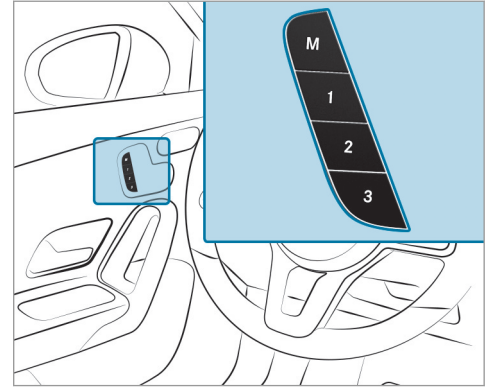

- ▶ Set the seat, the Head-up Display and the outside mirror to the desired position.
- ▶ Press memory button M together with one of preset position buttons 1, 2 or 3. An acoustic signal sounds. The settings are stored.

- ▶ **To call up:** press and briefly hold memory position switch 1, 2 or 3.  
After releasing the button, the front seat, Head-up Display and outside mirrors are moved into the stored position.

## Stowage areas

### Notes on loading the vehicle

#### **⚠ DANGER** Risk of exhaust gas poisoning

Combustion engines emit poisonous exhaust gases such as carbon monoxide. Exhaust gases can enter the vehicle interior if the trunk lid is open when the engine is running, especially if the vehicle is in motion.

- ▶ Always switch off the engine before opening the trunk lid.
- ▶ Never drive with the trunk lid open.

#### **⚠ WARNING** Risk of injury from unsecured items in the vehicle

If objects, luggage or loads are not secured or not secured sufficiently, they could slip, tip over or be thrown around and thereby hit vehicle occupants.

There is a risk of injury, particularly in the event of sudden braking or a sudden change in direction.

- ▶ Always stow objects in such a way that they cannot be thrown around.
- ▶ Before the journey, secure objects, luggage or loads against slipping or tipping over.

#### **⚠ WARNING** Risk of injury due to objects being stowed incorrectly

If you do not adequately stow objects in the vehicle interior, they could slip or be tossed around and thereby strike vehicle occupants. In addition, cup holders, open stowage spaces and mobile phone brackets cannot

always restrain the objects they contain in the event of an accident.

There is a risk of injury, particularly in the event of sudden braking or a sudden change in direction.

- ▶ Always stow objects in such a way that they cannot be tossed about in these or similar situations.
- ▶ Always make sure that objects do not project from stowage spaces, parcel nets or stowage nets.
- ▶ Close the lockable stowage spaces before starting a journey.
- ▶ Always stow and secure objects that are heavy, hard, pointed, sharp-edged, fragile or too large in the trunk.

#### **⚠ WARNING** Risk of burning from the tailpipe or tailpipe trim

The tailpipe and tailpipe trim can become very hot. If you come into contact with these car parts, you could burn yourself.

- ▶ Always be particularly careful when in the vicinity of the tailpipe and tailpipe trims and supervise children very closely when in this area.
- ▶ Before any contact, allow the car parts to cool down.

The driving characteristics of your vehicle are dependent on the distribution of the load within the vehicle. You should bear the following in mind when loading the vehicle:

- never exceed the permissible gross mass or the gross axle weight rating for the vehicle (including occupants). The values are specified on the vehicle identification plate on the vehicle's B-pillar.
- the load must not protrude above the upper edge of the seat backrests.
- always place the load behind unoccupied seats if possible.
- secure the load using the tie-down eyes and distribute the load evenly.

### Stowage spaces in the vehicle interior

#### Overview of the front stowage compartments

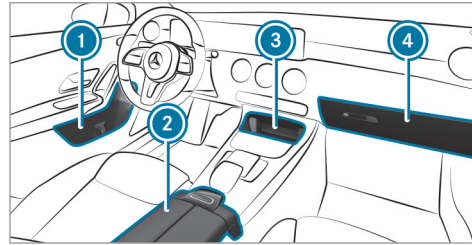

- ① Stowage space in the doors
- ② Stowage compartment in the armrest with a multimedia and USB connection
- ③ Stowage compartment in the front center console with a USB connection
- ④ Glove box

### Locking and unlocking the glove box

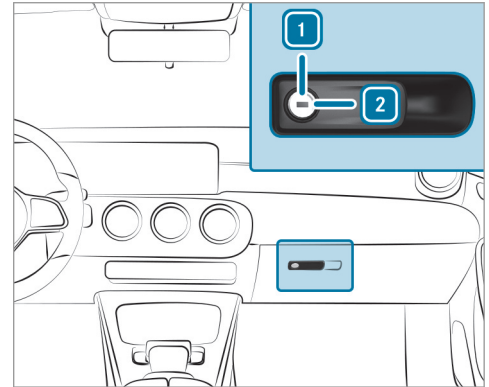

- ▶ Turn the emergency key a quarter turn clockwise **2** (to lock) or counter-clockwise **1** (to unlock).

### Storage compartment for customer literature

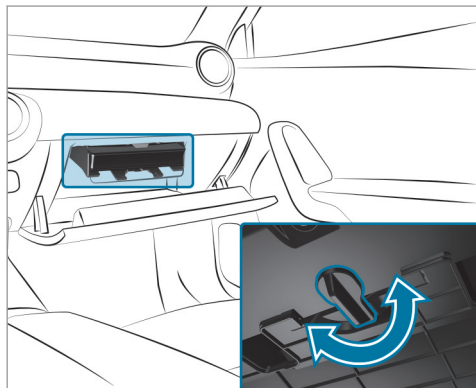

► **To open:** turn the handle to the left or right.

### Opening the eyeglasses compartment

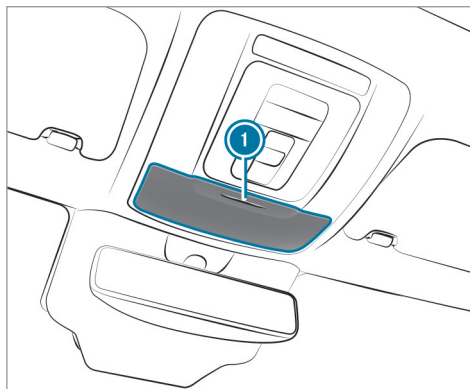

► Press button ①.

### Through-loading feature in the rear bench seat

#### Folding the rear seat backrest forwards

**⚠ WARNING** Risk of injury if the rear bench seat/rear seat and seat backrest are not engaged

If the rear bench seat/rear seat and seat backrest are not engaged they could fold forwards, e.g. when braking suddenly or in the event of an accident.

- If this is the case, the vehicle occupant would be forced into the seat belt by the rear bench seat/rear seat or by the seat backrest. The seat belt cannot protect as intended and could result in additional injury.
- Objects or loads in the trunk/cargo compartment cannot be restrained by the seat backrest.

► Make sure that the seat backrest and the rear bench seat/rear seat are engaged before every trip.

If the seat backrests are not engaged and locked in place, the lock verification indicator will be red.

The center and outer seat backrests can be folded forwards separately.

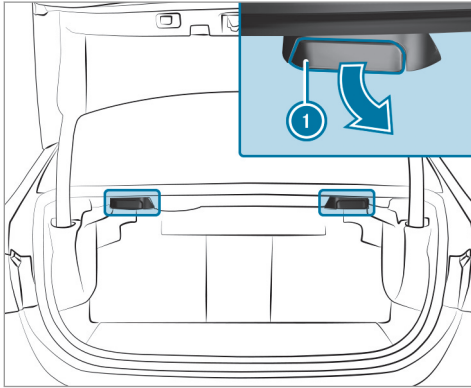

▶ **Vehicles with a memory function:** If at least one section of the rear seat backrest is folded forwards, the corresponding front seat

will move forwards slightly, if necessary, to avoid a collision.

▶ If necessary, fully insert the rear seat backrest head restraints.

▶ **Left and right seat backrests:** pull left or right release handle (1) and fold the corresponding seat backrest forwards.

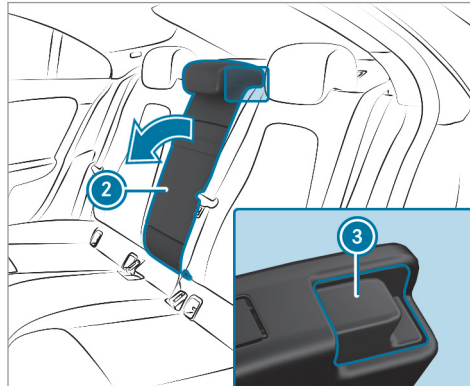

▶ **Center seat backrest:** pull release catch (3) of seat backrest (2) forwards.

▶ Fold seat backrest (2) forwards.

▶ If necessary, reset the driver's or front passenger seat.

### Folding the rear seat backrest back

**!** **NOTE** Damage to the seat belt

The seat belt could become trapped and thus damaged when folding back the seat backrest.

▶ Make sure that the seat belt is not trapped when folding back the seat backrest.

▶ Move the driver's or front passenger seat forwards, if necessary.

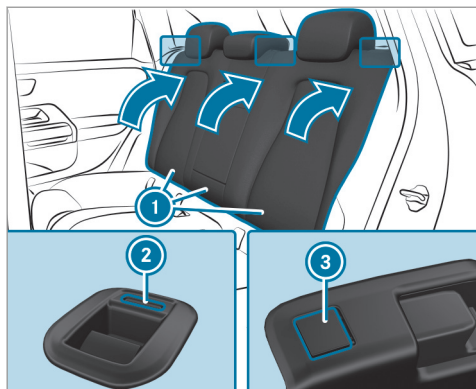

- ▶ Fold corresponding seat backrest ① back until it engages.

**Left and right seat backrest:** if the seat backrest is not engaged and locked, red lock verification indicator ② will be visible.

**Center seat backrest:** if the seat backrest is not engaged and locked, red lock verification indicator ③ will be visible.

### Locking the release catch of the center rear seat backrest

#### Requirements:

- The left and center seat backrests are engaged and joined together.

You can lock the center seat backrest release catch if you want to secure the trunk against unauthorized access. The center seat backrest can then be folded forwards only together with the left seat backrest.

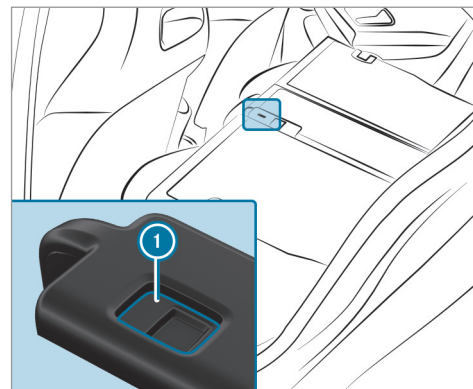

- ▶ Fold the center and left seat backrests forwards.
- ▶ **To lock:** slide catch ① upwards. The release catch of the center seat backrest will be locked.
- ▶ **To unlock:** slide catch ① downwards.

### Overview of the tie-down eyes

Observe the notes on loading the vehicle (→ page 98).

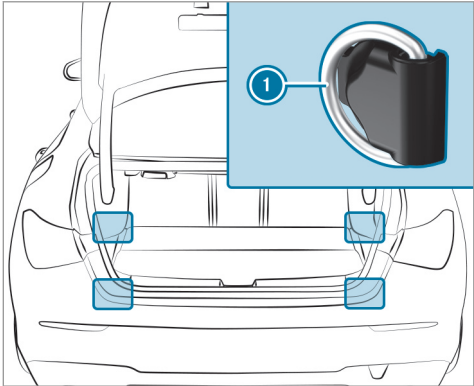

① Tie-down eyes (vehicles with through-loading feature in the rear bench seat)

### Opening or closing the stowage space under the trunk floor

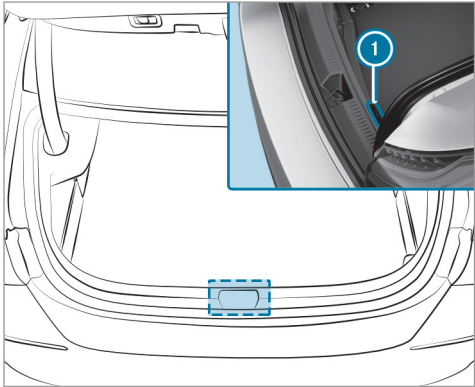

- ▶ **To open:** lift the trunk floor at contact ① and swing it upwards.
- ▶ **To close:** fold the trunk floor downwards.

### Attaching the roof carrier

**⚠ WARNING** Risk of injury if the maximum roof load is exceeded

When you load the roof, the center of gravity of the vehicle rises and the usual driving characteristics as well as the steering and braking characteristics change. During cornering, the vehicle tilts more strongly and may react more sluggishly to steering movements.

If you exceed the maximum roof load, the driving characteristics, as well as the steering and braking characteristics, will be greatly impaired.

▶ Always comply with the maximum roof load and adjust your driving style.

You will find information on the maximum roof load in the "Technical data" section.

**!** **NOTE** Vehicle damage from non-approved roof racks

The vehicle could be damaged by roof racks which have not been tested and approved by Mercedes-Benz.

- ▶ Only use roof racks tested and approved by Mercedes-Benz.
- ▶ Depending on the vehicle equipment, ensure that when the roof rack is installed:
  - The sliding sunroof can be fully raised.
  - The trunk lid can be fully opened.
- ▶ Position the load on the roof rack in such a way that the vehicle will not sustain damage even when it is in motion.

**!** **NOTE** Damage to the panoramic sliding sunroof when a roof rack is fitted

The panoramic sliding sunroof may be damaged by the roof rack if you attempt to open it when the roof rack is fitted.

- ▶ Do not open the panoramic sliding sunroof if a roof rack is fitted.

In order to allow ventilation of the vehicle interior, you can raise the panoramic sliding sunroof.

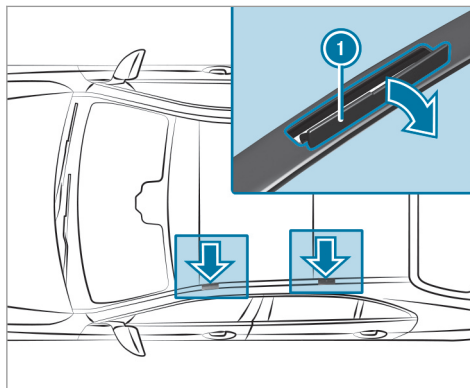

**!** **NOTE** Damage to the covers

The covers may be damaged and scratched when being opened.

- ▶ Do not use metallic or hard objects.

- ▶ Carefully fold the covers ① upwards in the direction of the arrow.
- ▶ Secure the roof rack to the anchorage points under covers ①.
- ▶ Comply with the roof rack manufacturer's installation instructions.
- ▶ Secure the load on the roof rack.



### Cup holder

#### Installing the cup holder in or removing it from the center console (automatic transmission)

**⚠ WARNING** - Risk of accident or injury when using the cup holder while the vehicle is moving

The cup holder cannot secure containers while the vehicle is moving.

If you use a cup holder while the vehicle is moving, the container may be flung around and liquids may be spilled. The vehicle occupants may come into contact with the liquid and if it is hot, they could be scalded. You could be distracted from traffic conditions and you may lose control of the vehicle.

- ▶ Only use the cup holder when the vehicle is stationary.
- ▶ Only use the cup holder for containers of the right size.
- ▶ Close the container, particularly if the liquid is hot.

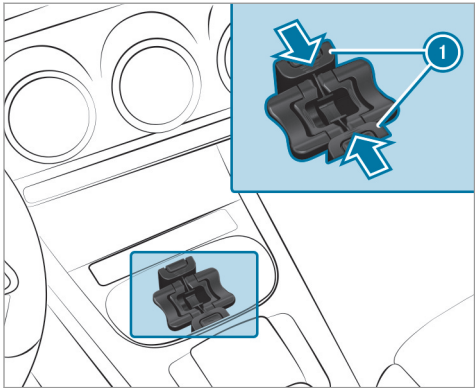

Cup holder in the stowage compartment without cover

- ▶ **To remove:** slide snap-in brackets ① of the cup holder inwards until they are unlocked.
- ▶ Move the cup holder upwards out of the stowage compartment.

① The cup holder and the rubber mat beneath it can be removed for cleaning, e.g. with clean, lukewarm water.

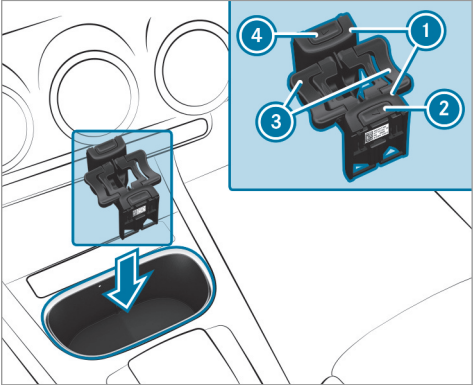

Cup holder in the stowage compartment without cover

- ▶ **To install:** if necessary, open the stowage compartment cover and insert the cup holder, as shown, into the stowage compartment.

ment with the imprint facing the vehicle interior.

- ▶ Slide the cup holder onto the bars in the stowage compartment.
  - ▶ Slide snap-in brackets ① outwards until they engage.
  - ▶ Press button ② and/or ④. Wings ③ fold upwards.
- ① The cup holder wings can be folded downwards and locked. The cup holder's holding function will then not be available.

### Opening or closing the cup holder in the rear armrest

**!** **NOTE** Damage to the rear armrest due to body weight

When folded out, the rear armrest can be damaged due to body weight.

- ▶ Do not sit or support yourself on the rear seat armrest.

**!** **NOTE** Damage to the cup holder

When the rear armrest is folded back the cup holder could become damaged.

- ▶ Only fold the rear armrest back when the cup holder is closed.

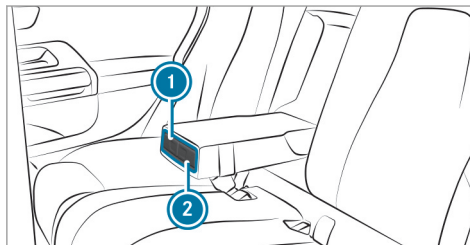

- ▶ **To open:** press cup holder ① or ②. Cup holder ① or ② extends automatically.
- ▶ **To close:** push cup holder ① or ② back until it engages.

### Ashtray and cigarette lighter

#### Using the ashtray

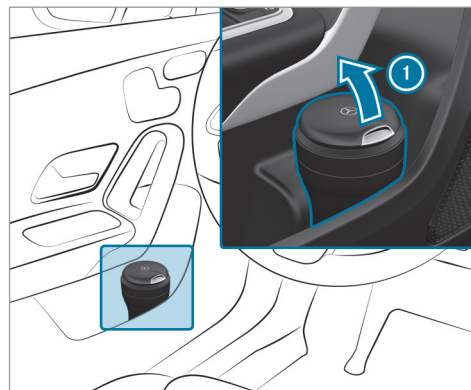

- ▶ **While driving:** place the closed ashtray in the front door stowage compartment while driving.
- ▶ Check that it is secure.
- ▶ Comply with the notes on loading the vehicle (→ page 98).

▶ **To open:** fold lid ① upwards.

① Twist the top part of the ashtray to remove it for cleaning, e.g. with clean, lukewarm water, or for emptying.

### Using the cigarette lighter in the front center console

**⚠ WARNING** - Risk of fire and injury from hot cigarette lighter

You can burn yourself if you touch the hot heating element or the socket of the cigarette lighter.

In addition, flammable materials may ignite if:

- you drop the hot cigarette lighter
- a child holds the hot cigarette lighter to objects, for example

▶ Always hold the cigarette lighter by the knob.

▶ Always make sure that the cigarette lighter is out of reach of children.

▶ Never leave children unattended in the vehicle.

#### Requirements:

- The ignition is switched on.

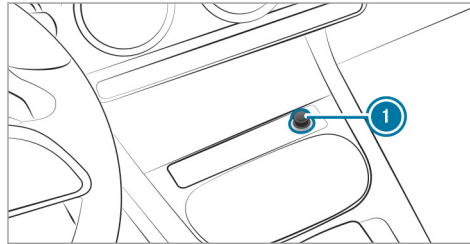

▶ Press in cigarette lighter ①.  
The cigarette lighter will pop out automatically when the heating element is red-hot.

### Sockets

#### Using the 12 V socket in the front center console

#### Requirements:

- Only devices up to a maximum of 180 W (15 A) are permissible.

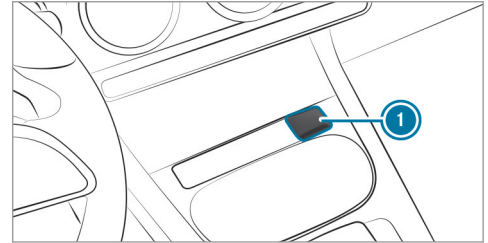

▶ Lift up socket cap ①.

▶ Insert the plug of the device.

**12 V socket in the stowage compartment with cover:** if you have connected a device to the 12 V socket, leave the cover of the stowage compartment open.

### Using the 115 V socket in the rear passenger compartment

**⚠ DANGER** Risk of fatal injury due to damaged connecting cables or sockets

If a suitable device is connected, the 115 V socket will be carrying a high voltage. If the connecting cable or the 115 V socket is pulled out of the trim or is damaged or wet, you could receive an electric shock.

- ▶ Only use dry and damage-free connecting cables.
- ▶ When the ignition is switched off, ensure that the 115 V socket is dry.
- ▶ If the 115 V socket is damaged or gets pulled out of the paneling, immediately have the socket checked or replaced at a qualified specialized workshop.
- ▶ Never plug the connecting cable into a 115 V socket that is damaged or has been pulled out of the trim.

**⚠ DANGER** Risk of fatal injury due to incorrect handling of the socket

You could receive an electric shock:

- if you reach into the socket.
- if you insert unsuitable devices or objects into the socket.

- ▶ Do not reach into the socket.
- ▶ Only connect suitable devices to the socket.

#### Requirements:

- Devices are equipped with a suitable plug which conforms to the standards specific to the country you are in.
- A device up to a maximum of 150 W is used.
- Do not use multiple socket outlets.

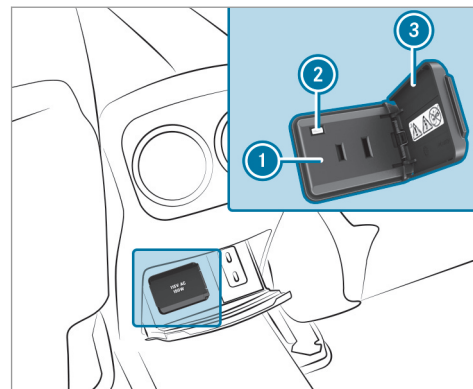

- ▶ Open flap ③.
- ▶ Insert the plug of the device into 115 V socket ①.  
When the on-board electrical system voltage is sufficient, indicator lamp ② lights up.

### Using the 12 V socket in the trunk

#### Requirements:

- Only connect devices up to a maximum of 180 W (15 A).

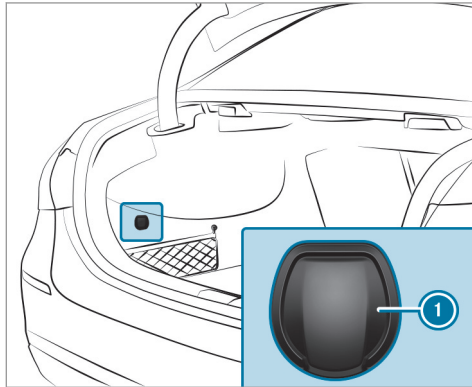

- ▶ Lift up cap ① of the socket and insert the plug of the device.

### USB port in the rear passenger compartment

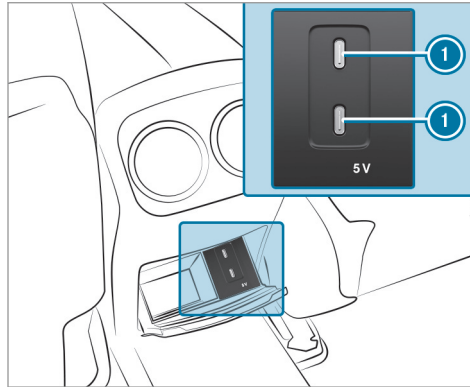

If the ignition is switched on you can charge a USB device, e.g. a mobile phone, at USB ports ① using a suitable charging cable.

### Wireless charging of the mobile phone and connection with the exterior antenna

#### Notes on wirelessly charging the mobile phone

**⚠ WARNING** Risk of injury due to objects being stowed incorrectly

If objects in the vehicle interior are stowed incorrectly, they can slide or be thrown around and hit vehicle occupants. In addition, cup holders, open stowage spaces and mobile phone receptacles cannot always retain all objects they contain.

There is a risk of injury, particularly in the event of sudden braking or a sudden change in direction.

- ▶ Always stow objects so that they cannot be thrown around in such situations.
- ▶ Always make sure that objects do not protrude from stowage spaces, luggage nets or stowage nets.

- ▶ Close the lockable stowage spaces before starting a journey.
- ▶ Always stow and secure heavy, hard, pointed, sharp-edged, fragile or bulky objects in the trunk/load compartment.

Observe the notes on loading the vehicle.

**⚠ WARNING** Risk of fire from placing objects in the mobile phone stowage compartment

If you place objects in the mobile phone stowage compartment, they may heat up excessively and even catch fire.

- ▶ Do not place additional objects, especially those made of metal, in the mobile phone stowage compartment.

**! NOTE** Damage to objects caused by placing them in the mobile phone stowage compartment

If objects are placed in the mobile phone stowage compartment, they may be damaged by electromagnetic fields.

- ▶ Do not place credit cards, storage media or other objects sensitive to electromagnetic fields in the mobile phone stowage compartment.

**! NOTE** Damage to the mobile phone stowage compartment caused by liquids

If liquids enter the mobile phone stowage compartment, the compartment may be damaged.

- ▶ Ensure that no liquids enter the mobile phone stowage compartment.

- The charging function and wireless connection of the mobile phone to the vehicle's exterior antenna are only available if the ignition is switched on.
- Small mobile phones may not be able to be charged in every position of the mobile phone stowage compartment.
- Large mobile phones which do not rest flat in the mobile phone stowage compartment may not be able to be charged or connected with the vehicle's exterior antenna.
- The mobile phone may heat up during the charging process. This depends on the applications (apps) currently open in the background.
- To ensure more efficient charging and connection with the vehicle's exterior antenna, remove the protective cover from the mobile phone. Protective covers which are necessary for wireless charging are excluded.
- Depending on the vehicle equipment, the mobile phone is connected to the vehicle's exterior antenna via the charging module.

## Wireless charging of the mobile phone

### Requirements:

- The mobile phone is suitable for wireless charging. You can find a list of compatible mobile phones at:  
<http://www.mercedes-benz.com/connect>

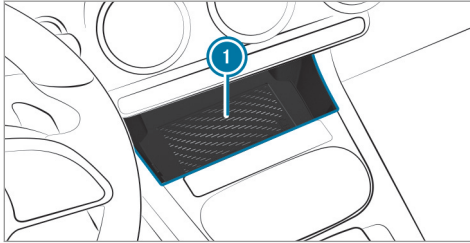

- Place the mobile phone as close to the center of the marked surface on mat ① as possible with the display facing upwards. When a message is shown in the multimedia system, the mobile phone is being charged. Malfunctions during the charging process are shown in the media display.

- The mat can be removed for cleaning, e.g. using clean, lukewarm water.

### Stowage compartment without cover

Make sure the mobile phone is properly stored and secured to prevent it from falling out while you are driving.

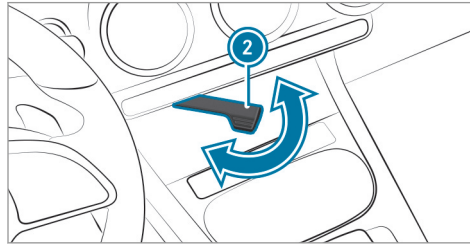

- To secure the mobile phone: swing lever ② out.

## Installing/removing the floor mats

**⚠ WARNING** Risk of accident due to objects in the driver's footwell

Objects in the driver's footwell may impede pedal travel or block a depressed pedal.

This jeopardizes the operating and road safety of the vehicle.

- Stow all objects in the vehicle securely so that they cannot get into the driver's footwell.
- Always install the floor mats securely and as prescribed in order to ensure that there is always sufficient room for the pedals.
- Do not use loose floor mats and do not place floor mats on top of one another.

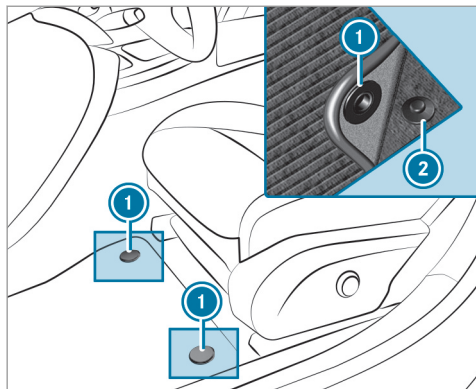

- ▶ **To install:** slide the corresponding seat backwards and lay the floor mat in the footwell.
- ▶ Press studs ① onto holders ②.
- ▶ Adjust the corresponding seat.
- ▶ **To remove:** pull the floor mat off holders ②.
- ▶ Remove the floor mat.



## Exterior lighting

### Information about lighting systems and your responsibility

The various lighting systems of the vehicle are only aids. The driver of the vehicle is responsible for correct vehicle illumination in accordance with the prevailing light and visibility conditions, legal requirements and traffic situation.

## Light switch

### Operating the light switch

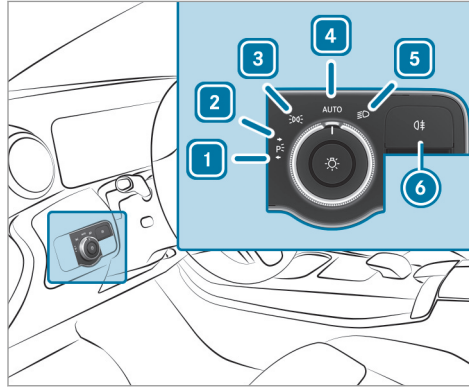

- 1 Left-hand standing lights
- 2 Right-hand standing lights
- 3 Parking lights and license plate lamp
- 4 **AUTO** Automatic driving lights (preferred light switch position)

- 5 Low beam/high beam
- 6 Switches the rear fog lights on/off

When low beam is activated, the indicator lamp for the parking lights is deactivated and replaced by the low beam indicator lamp.

- ▶ Always park your vehicle safely and in a well-lit area, in accordance with the relevant legal stipulations.

**!** **NOTE** Battery discharging by operating the standing lights

Operating the standing lights over a period of hours puts a strain on the battery.

- ▶ Where possible, switch on the right or left parking light.

In the case of severe battery discharging, the standing lights or parking lights are automatically switched off to facilitate the next engine start.

The exterior lighting (except standing and parking lights) switches off automatically when the driver's door is opened.

## 114 Light and visibility

- Observe the notes on surround lighting (→ page 117).

### Automatic driving lights function

The parking lights, low beam and daytime running lamps are switched on automatically depending on the ignition status and the ambient light.

**⚠ WARNING** Risk of accident when the low beam is switched off in poor visibility

When the light switch is set to **AUTO**, the low beam may not be switched on automatically if there is fog, snow or other causes of poor visibility such as spray.

- ▶ In such cases, turn the light switch to .

The automatic driving lights are only an aid. You are responsible for vehicle lighting.

### Switching the rear fog lights on or off

#### Requirements:

- The light switch is in the  or **AUTO** position.

- ▶ Press the  button.

Please observe the country-specific laws on the use of rear fog lamps.

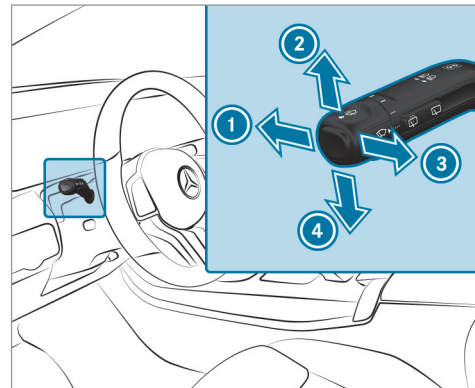

### Operating the combination switch for the lights



- 1 High-beam headlamps
- 2 Turn signal indicator, right
- 3 High-beam flasher
- 4 Turn signal indicator, left

- ▶ Use the combination switch to activate the desired function.

### High-beam headlamps

- ▶ **To switch on:** turn the light switch to the  or **AUTO** position.
- ▶ Press the combination switch in the direction of arrow ①. When the high beam is activated, the  indicator lamp for low beam will be deactivated and replaced by the  indicator lamp for high beam.
- ▶ **To switch off:** press the combination switch in the direction of arrow ① or pull in the direction of arrow ③.

### High-beam flasher

- ▶ Pull the combination switch in the direction of arrow ③.

### Turn signal lights

- ▶ **To indicate briefly:** press the combination switch briefly to the point of resistance in the direction of arrow ② or ④. The corresponding turn signal indicator will flash three times.

- ▶ **To indicate permanently:** press the combination switch beyond the point of resistance in the direction of arrow ② or ④.

### Activating/deactivating the hazard warning lights

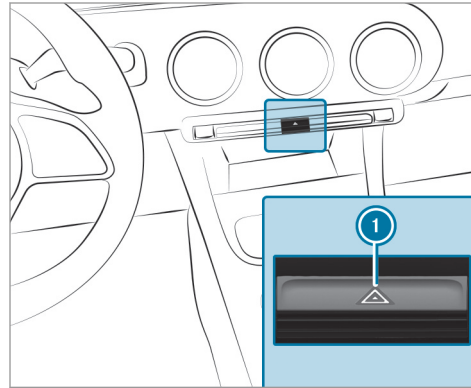

- ▶ Press button ①.

The hazard warning lights will switch on automatically if:

- The airbag has been deployed.

### Cornering light

#### Cornering light function

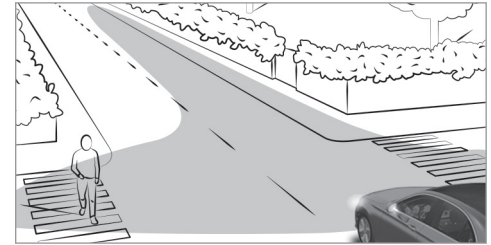

The cornering light improves the illumination of the roadway over a wide angle in the turning direction, enabling better visibility on tight bends, for example. It can be activated only when the low beam is switched on.

The function is active in the following cases:

- at speeds below 25 mph (40 km/h) when the turn signal indicator is switched on or the steering wheel is turned
- at speeds between 25 mph (40 km/h) and 45 mph (70 km/h) when the steering wheel is turned

**Traffic circle and intersection function:** the cornering light will be activated on both sides based on an evaluation of the current GPS position of the vehicle. It will remain active until after the vehicle has left the traffic circle or the intersection.

## Adaptive Highbeam Assist

### Adaptive Highbeam Assist function

**⚠ WARNING** Risk of accident despite Adaptive Highbeam Assist

Adaptive Highbeam Assist does not recognize the following road users:

- Road users without lights, e.g. pedestrians
- Road users with poor lighting, e.g. cyclists
- Road users whose lighting is obstructed, e.g. by a barrier

On very rare occasions, Adaptive Highbeam Assist may fail to recognize other road users with their own lighting, or may recognize them too late.

In these or similar situations, the automatic high beam is not deactivated or is activated despite the presence of other road users.

▶ Always observe the traffic carefully and switch off the high beam in good time.

Adaptive Highbeam Assist cannot take into account road, weather or traffic conditions.

Detection may be restricted in the following cases:

- In poor visibility, e.g. fog, heavy rain or snow
- If there is dirt on the sensors or the sensors are obscured

Adaptive Highbeam Assist is only an aid. You are responsible for adjusting the vehicle's lighting to the prevailing light, visibility and traffic conditions.

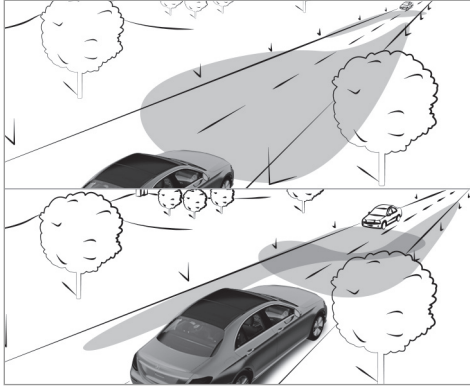

The Adaptive Highbeam Assist automatically switches between the following types of light:

- Low-beam headlamps
- High-beam headlamps

At speeds above 19 mph (30 km/h):

- If no other road users are detected, the high beam will be switched on automatically.

The high beam switches off automatically in the following cases:

- At speeds below 16 mph (25 km/h).
- If other road users are detected.
- If street lighting is sufficient.

At speeds above approximately 31 mph (50 km/h):

- The headlamp range of the low beam is regulated automatically based on the distance to other road users.

The system's optical sensor is located behind the windshield near the overhead control panel.

#### Switching Adaptive Highbeam Assist on/off

- ▶ **To switch on:** turn the light switch to the **AUTO** position.
- ▶ Switch on the high beam using the combination switch.  
When the high beam is switched on automatically in the dark, the  indicator lamp on the multifunction display comes on.
- ▶ **To switch off:** switch off the high beam using the combination switch.

#### Setting the exterior lighting switch-off delay time

##### Requirements:

- The light switch is in the **AUTO** position.

Multimedia system:

- ▶  ▶ Settings ▶ Light
- ▶▶ Exterior Lighting Delay

The exterior lighting is activated for the configured time when the vehicle is parked.

- ▶ Set the switch-off delay time.

#### Switching the surround lighting on/off

Multimedia system:

- ▶  ▶ Settings ▶ Light
- ▶▶ Locator Lighting

When **Locator Lighting** is active, the exterior lighting lights up for 40 seconds after the vehicle is unlocked. When you start the vehicle, the surround lighting is deactivated and the automatic driving lights are activated.





- ▶ Activate or deactivate the function.

## Interior lighting

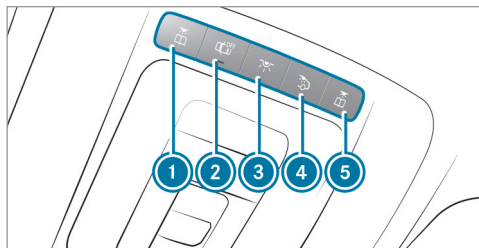
### Adjusting the interior lighting

#### Front overhead control panel



- ①  Front left reading lamp
- ②  Automatic interior lighting control
- ③  Front interior lighting
- ④  Rear interior lighting
- ⑤  Front right reading lamp

▶ **To switch on or off:** press button ① - ⑤ accordingly.

#### Control panel in the grab handle

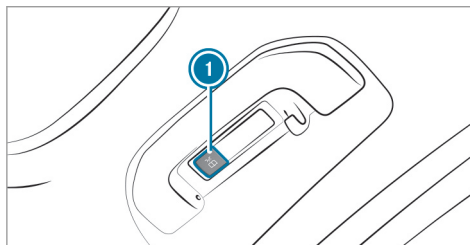

- ①  Rear reading lamp

▶ **To switch on or off:** press button ①.

### Adjusting the ambient lighting

Multimedia system:

➔  ▶ **Comfort** ▶ **Ambient Lighting**

#### Setting the color

- ▶ Select **Color**.
- ▶ Set the desired color.
- ① There are 64 colors available.

#### Adjusting the brightness

- ▶ Select **Brightness**.
- ▶ Adjust the brightness.

#### Activating the brightness for zones

- ▶ Select **Brightness**.
- ▶ Select **Brightness Zones**.
- ▶ Activate or deactivate the function. The **ACCENT**, **AMBIANCE** and **VENTS** zones can be set separately.

#### Activating multi-color lighting

- ▶ Select **Color**.
- ▶ Select **Multi-color**. There are ten preset color combinations available.
- ▶ Select a color combination.

#### Activating multi-color animation

- ▶ Select **Color**.
- ▶ Select **Multi-color Animation**. The chosen color combination will change at predefined intervals.

### Activating welcome lighting

- ▶ Select **Color**.
- ▶ Select **Welcome**.  
When the vehicle is unlocked, a special ambient lighting sequence will run.

### Activating dependency on air conditioning settings

- ▶ Select **Color**.
- ▶ Select **Climate**.  
If changes are made to the temperature setting in the vehicle, the color of the ambient lighting will change briefly.

### Switching the interior lighting switch-off delay time on/off

Multimedia system:

-  ▶ Settings ▶ Light
- ▶▶ Interior Lighting Delay

- ▶ Switch the lighting switch-off delay time on or off.  
When this function is active, the interior lighting is lit up for short time after the vehicle has been locked.

### Windshield wiper and windshield washer system

#### Switching the windshield wipers on/off

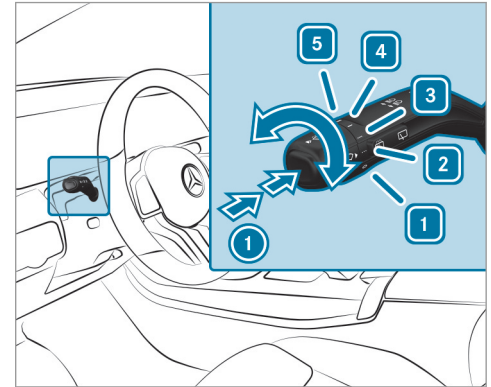



- 1** **0** Windshield wipers off
- 2** **...** Automatic wiping, normal
- 3** **....** Automatic wiping, frequent

4  Continuous wiping, slow

5  Continuous wiping, fast

▶ Turn the combination switch to the correct position 1 - 5.

▶ **Single wipe/washing:** push the button on the combination switch in the direction of arrow 1.

-  Single wipe
-  Wipes with washer fluid

### Changing the windshield wiper blades

**⚠ WARNING** Risk of becoming trapped if the windshield wipers are switched on while wiper blades are being replaced

If the windshield wipers begin to move while you are changing the wiper blades, you can be trapped by the wiper arm.

▶ Always switch off the windshield wipers and the ignition before changing the wiper blades.

### Moving the wiper arms to the change position

- ▶ Switch the ignition on and switch off again immediately.
- ▶ Within around 15 seconds, press the  button on the combination switch for approximately three seconds (→ page 119). The wiper arms will move into the change position.

### Removing the wiper blades

- ▶ Fold the wiper arms away from the windshield.

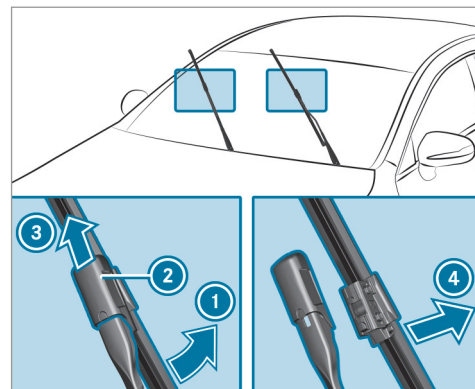

- ▶ Hold the wiper arm with one hand. With the other hand, turn the wiper blade in the direction of arrow 1 away from the wiper arm as far as it will go.
- ▶ Slide catch 2 in the direction of arrow 3 until it engages in the removal position.
- ▶ Remove the wiper blade from the wiper arm in the direction of arrow 4.



## Installing the wiper blades

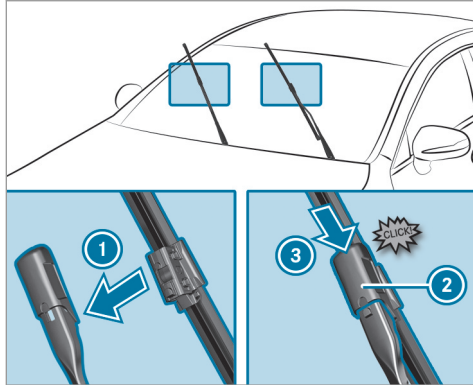

- ▶ Insert the new wiper blade into the wiper arm in the direction of arrow ①.
- ▶ Slide catch ② in the direction of arrow ③ until it engages in the locking position.
- ▶ Make sure that the wiper blade sits correctly.
- ▶ Fold the wiper arms back onto the windshield.

- ▶ Switch on the ignition.
- ▶ Press the  button on the combination switch (→ page 119). The wiper arms will move into the original position.
- ▶ Switch the ignition off.

## Maintenance display

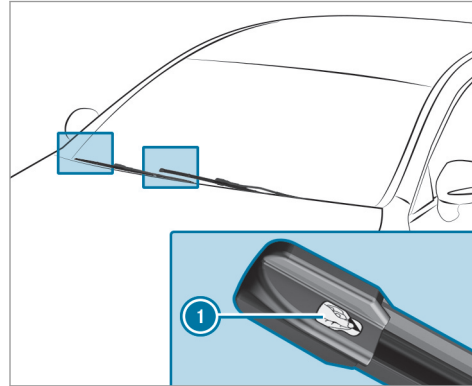

- ▶ Remove protective film ① from the maintenance display on the tip of the newly installed wiper blades.

If the color of the maintenance display changes from black to yellow, the wiper blades should be replaced.

- ① The time taken until the color changes varies depending on the usage conditions.

## Mirrors

### Operating the outside mirrors

**⚠ WARNING** Risk of injury from adjusting the vehicle settings while the vehicle is in motion

You could lose control of the vehicle in the following situations:

- if you adjust the driver's seat, the head restraint, the steering wheel or the mirror while the vehicle is in motion
- if you fasten your seat belt while the vehicle is in motion

- ▶ Before starting the engine: adjust the driver's seat, the head restraint, the steering wheel or the mirror and fasten your seat belt.

**⚠ WARNING** Risk of accident due to misjudgment of distances when using the passenger mirror

The outside mirror on the front-passenger side reflects objects on a smaller scale. The objects in view are in fact closer than they appear.

As a result, you may misjudge the distance between you and the road user driving behind you, for example, when changing lanes.

- ▶ Therefore, always look over your shoulder in order to ensure that you are aware of the actual distance between you and the road users driving behind you.

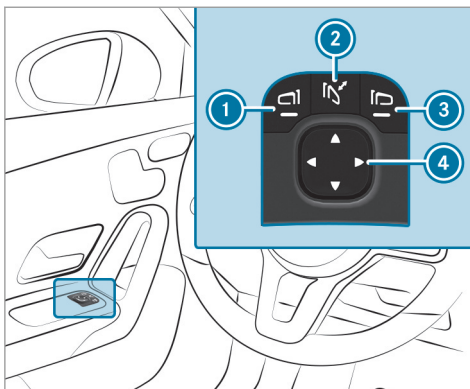

- ▶ **To fold in or out:** briefly press button ②.
- ▶ **To set:** press button ① or ③ to select the outside mirror to be adjusted.
- ▶ Press button ④ to adjust the position of the mirror glass.

**i** If the battery has been disconnected or completely discharged, you will have to reset the

outside mirrors. Only then will the automatic mirror folding function work properly.

- ▶ **To adjust:** briefly press button ②.  
An outside mirror that has been pushed out of position can be engaged in position again as follows:

- ▶ **Vehicles without electrically folding outside mirrors:** Manually move the outside mirror into the correct position.
- ▶ **Vehicles with electrically folding outside mirrors:** Press and hold button ②.  
You will hear a click and the mirror will audibly engage in position. The outside mirror will now be set to the correct position.

### Automatic anti-glare mirrors function

**⚠ WARNING** Risk of burns and poisoning due to the anti-glare mirror electrolyte

Electrolyte may escape if the glass in an automatic anti-glare mirror breaks.

The electrolyte is harmful and causes irritation. It must not come into contact with your

skin, eyes, respiratory organs or clothing or be swallowed.

- If you come into contact with electrolyte, observe the following:
- Rinse the electrolyte from your skin and seek medical attention immediately.
  - If electrolyte comes into contact with your eyes, rinse them thoroughly with clean water and seek medical attention immediately.
  - If the electrolyte is swallowed, immediately rinse your mouth out thoroughly. Do not induce vomiting. Seek medical attention immediately.
  - Immediately change out of clothing which has come into contact with electrolyte.
  - If an allergic reaction occurs, seek medical attention immediately.

The inside rearview mirror and the outside mirror on the driver's side automatically go into

anti-glare mode if light from a headlamp hits the sensor on the inside rearview mirror.

#### System limitations

The system does not go into anti-glare mode in the following situations:

- the engine is switched off
- reverse gear is engaged
- the interior lighting is switched on

#### Front-passenger outside mirror parking position function

The parking position makes parking easier.

In the following situations, the front-passenger outside mirror will swivel downwards in the direction of the rear wheel on the front passenger's side:

- the parking position is stored (→ page 124)
- the front-passenger mirror is selected
- reverse gear is engaged

The front-passenger outside mirror will move back to its original position in the following situations:

- you shift the transmission to another transmission position
- you are traveling at speeds greater than 9 mph (15 km/h)
- you press the button for the outside mirror on the driver's side

### Storing the parking position of the front-passenger outside mirror using reverse gear

#### Storing

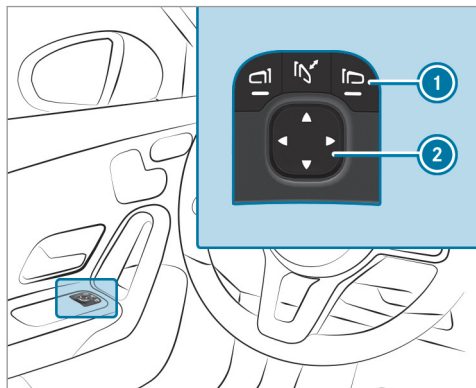

- ▶ Press button ① to select the front-passenger outside mirror.
- ▶ Engage reverse gear.
- ▶ Move the passenger outside mirror into the desired parking position using button ②.

#### Calling up

- ▶ Press button ① to select the front-passenger outside mirror.
- ▶ Engage reverse gear.  
The front-passenger outside mirror will move to the stored parking position.

### Activating/deactivating the automatic mirror folding function

Multimedia system:

- ▶ ▶ Settings ▶ Vehicle
- ▶ Switch Automatic Folding on or off.

### Operating the sun visors

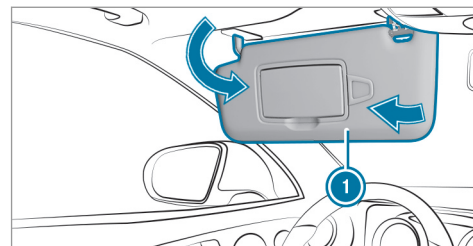

- ▶ **Glare from the front:** fold sun visor ① down.
- ▶ **Glare from the side:** swing sun visor ① to the side.

## Overview of climate control systems

### Notes on climate control

An interior air filter in combination with the pre-filter in the engine compartment must always be used so that the air conditioning system, pollution level monitoring and the air filtration work correctly. Make sure that the filter is installed correctly and the filter housing in the engine compartment is closed correctly using the cap and always tightly sealed when in operation. Use filters recommended and approved by Mercedes-Benz. Always have service work carried out at a qualified specialist workshop.

### Control panel overview for 3-zone automatic climate control

The indicator lamps in the buttons **AUTO**, **MAX**, **REAR**, **A/C REST** and **SYNC** indicate that the corresponding function is activated.

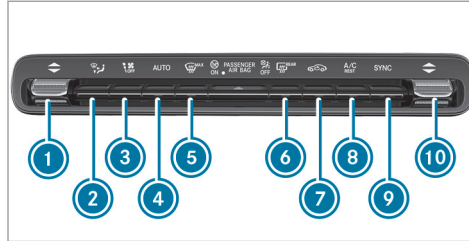

- ① Sets the temperature on the driver's side
- ② Sets the air distribution
- ③ Sets the airflow or switches off climate control
- ④ **AUTO** Sets climate control to automatic mode (→ page 126)
- ⑤ Defrosts the windshield
- ⑥ Switches the rear window heater on/off
- ⑦ Switches air-recirculation mode on/off (→ page 127)
- ⑧ Switches the A/C function on/off (→ page 125)

Switches residual heat on/off (→ page 127)

- ⑨ **SYNC** Activates or deactivates synchronization (→ page 127)
- ⑩ Sets the front passenger side temperature

## Operating the climate control system

### Switching climate control on/off

- ▶ **To switch on:** set the airflow to level 1 or higher using the button.
  - ▶ **To switch off:** set the airflow to level 0 using the button.
- ⓘ If climate control is switched off, the windows may fog up more quickly. Switch off climate control only briefly.

### Switching the A/C function on or off via the control panel

The A/C function heats, cools and dehumidifies the vehicle's interior air.

- ▶ Press the / button.

Switch off the A/C function only briefly; otherwise, the windows may fog up more quickly.

Condensation may drip from the underside of the vehicle when cooling mode is active. This is not a sign that there is a malfunction.

### Calling up the air conditioning menu

#### Calling up the air conditioning menu using the multimedia system

- ▶ Select one of the temperature displays at the lower edge of the media display.

#### Calling up the air conditioning menu using the button on the control panel

- ▶ Press the **MENU** button on the control panel.
- ⓘ The button on the control panel is not available on all equipment variants. In this case, the air conditioning menu can only be called up using the multimedia system.

### Activating/deactivating the A/C function via the multimedia system

The A/C function heats, cools and dehumidifies the vehicle's interior air.

- ▶ Call up the air conditioning menu (→ page 126).
- ▶ Select **First Row of Seats**.
- ▶ Select **A/C**.  
Depending on the previous status, the function is activated or deactivated.

### Setting climate control to automatic mode









In automatic mode, the set temperature is controlled and maintained at a constant level by the air supply.

- ▶ Press the **AUTO** button.
- ▶ **To switch to manual mode:** press the  or **AUTO** button.



In automatic mode, you can choose between five different air quantities using the  button. Automatic mode is retained.

### Overview of air distribution settings

The symbols on the display indicate which vents the airflow is being directed through:

-  Defroster and side air vents
-  Center and side air vents
-  Footwell and side air vents
-  Center, side and footwell vents
-  Defroster, footwell and side air vents
-  All vents
-  Defroster, middle and side air vents
-  Automatic air distribution

### Setting the air distribution

- ▶ Call up the air conditioning menu (→ page 126).
- ▶ Select **First Row of Seats** or **Second Row of Seats**.
- ▶ **To set the air distribution:** select ,  or .
- ▶ Set the airflow.

- ⓘ Several air distribution options can be selected at the same time, for example to set the temperature/air conditioning for the windshield and the footwells simultaneously. The  climate control for the windshield can only be selected for the first seat row.

### Activating/deactivating the climate control synchronization function via the control panel

Climate control can be set centrally using the synchronization function. The temperature and air distribution setting for the driver side is adopted automatically for the front passenger side.

- ▶ Press the  button.

The synchronization function is deactivated if the settings for one of the other climate zones are changed.



### Activating/deactivating the climate control synchronization function using the multimedia system

Climate control can be set centrally using the synchronization function. The driver's settings for temperature, air quantity and air distribution are adopted automatically for all climate zones.

- ▶ Call up the air conditioning menu (→ page 126).
- ▶ Select **First Row of Seats**.
- ▶ Select **SYNC**.  
Depending on the previous status, the function is activated or deactivated.

### Removing condensation from the windows

#### Windows fogged up on the inside

- ▶ Press the  button.
- ▶ If the windows continue to fog up: press the  button.

#### Windows fogged up on the outside

- ▶ Switch on the windshield wipers.

- ▶ Press the  button.

### Switching air-recirculation mode on/off

- ▶ Press the  button.  
The interior air will be recirculated.

Air-recirculation mode automatically switches to fresh air mode after some time.

- ⓘ If air-recirculation mode is switched on, the windows may fog up more quickly. Switch on air-recirculation mode only briefly.

### Switching the residual heat on/off (Canada)

#### Requirements:

- The vehicle is parked.

It is possible to make use of the residual heat from the engine to continue heating or ventilating the front compartment of the vehicle for approximately 30 minutes, depending on the temperature set.

- ▶ **To switch on:** press the  button.

Residual heat is switched off automatically.

## Air vents

### Adjusting the front air vents

**⚠ WARNING** - Danger of burns or frostbite due to being too close to the air vents

Very hot or very cold air can flow from the air vents.

This could result in burns or frostbite in the immediate vicinity of the air vents.

- ▶ Make sure that all vehicle occupants always maintain a sufficient distance to the air vents.
- ▶ If necessary, direct the airflow to another area of the vehicle interior.

To guarantee the flow of fresh air through the air vents into the vehicle interior, comply with the following:

- Always keep the vents and the ventilation grille in the vehicle interior free.
- Keep the air inlet free of deposits (→ page 385).

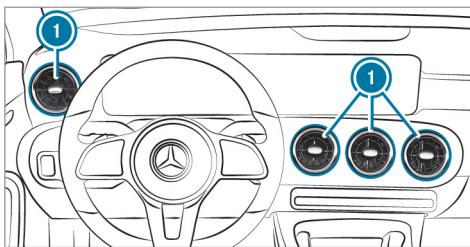

- ▶ **To open or close:** hold air vent ❶ in the center and turn it to the left (open) or right (closed) as far as it will go.
- ▶ **To adjust the air direction:** hold air vent ❶ in the center and move it up or down or to the left or right.

### Adjusting the rear air vents

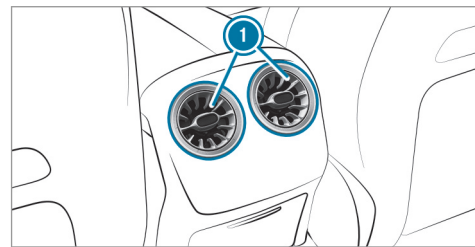

- ▶ **To open or close:** hold air vent ❶ in the center and turn it to the left (open) or right (closed) as far as it will go.
- ▶ **To adjust the air direction:** hold air vent ❶ in the center and move it up or down or to the left or right.



## Driving

### Notes on Mercedes-AMG vehicles

Observe the notes on the following topics in the Supplement, as you may otherwise fail to recognize dangers:

- **Mercedes-AMG CLA 45 4MATIC and CLA 45 S 4MATIC:** front axle locking differential
- AMG Performance exhaust system
- RACE START
- AMG adaptive sport suspension system

### Switching the power supply or ignition on without starting the engine

**⚠ DANGER** Risk of fatal injuries due to exhaust gases

Combustion engines emit poisonous exhaust gases such as carbon monoxide. Inhaling these exhaust gases is hazardous to health and can lead to poisoning.

▶ Never leave the engine running in an enclosed space without sufficient ventilation.

**⚠ WARNING** Risk of fire caused by flammable material on the exhaust system

Flammable materials brought in by either animals or environmental influences may ignite if they come into contact with hot parts of the engine or exhaust system.

▶ Therefore, check regularly that there are no flammable materials in the engine compartment or on the exhaust system.

**⚠ WARNING** Risk of accident and injury due to children left unattended in the vehicle

If children are left unattended in the vehicle, they could:

- Open doors, thereby endangering other persons or road users.

- Get out and be struck by oncoming traffic.
- Operate vehicle equipment and become trapped, for example.

In addition, the children could also set the vehicle in motion, for example by:

- Releasing the parking brake.
- Changing the transmission position.
- Starting the vehicle.

- ▶ Never leave children unattended in the vehicle.
- ▶ When leaving the vehicle, always take the key with you and lock the vehicle.
- ▶ Keep the vehicle key out of reach of children.

#### Requirements:

- the SmartKey is in the vehicle and is recognized.
- **Vehicles with automatic transmission:** The brake pedal is not depressed.

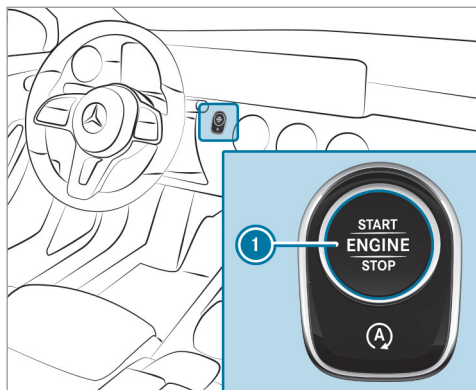

- ▶ **To switch on the power supply:** press button ① once. You can activate the windshield wipers, for example.

The power supply is switched off again if the following conditions are met:

- You open the driver's door.
- You press button ① twice more.

- ▶ **To switch on the ignition:** press button ① twice. The indicator lamps in the instrument cluster light up.

The ignition is switched off again if one of the following conditions is met:

- **Vehicles with automatic transmission:** You do not start the vehicle within 15 minutes.
- **Vehicles with automatic transmission:** The transmission is in position **P** or the electric parking brake has been applied.
- You press button ① once.

### Starting the vehicle

#### Starting the vehicle with the start/stop button

##### Requirements:

- The SmartKey is in the vehicle and is recognized.
- ▶ Shift the transmission to position **P** or **N**.

- ▶ Depress the brake pedal and press button ① once.
- ▶ If the vehicle does not start: switch off non-essential consumers and press button ① once.
- ▶ If the vehicle still does not start and the [Place the Key in the Marked Space See Operator's Manual](#) display message also appears in the multifunction display: start the vehicle in emergency operation mode.

You can switch off the engine while driving by pressing button ① for about three seconds or by pressing button ① three times within a second. Be sure to observe the safety notes under "Driving tips".

#### Starting the vehicle with SmartKey in the marked space (emergency operation mode)

If the vehicle does not start and the [Place the Key in the Marked Space See Operator's Manual](#) message appears in the multifunction display, you can start the vehicle in emergency operation mode.

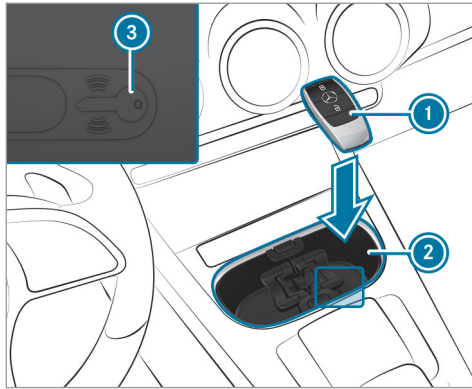

Marked space (example with cup holder without cover)

- ▶ Open the cover of marked space ② if necessary.
- ▶ Make sure that marked space ② is empty.
- ▶ Remove SmartKey ① from the key ring.

- ▶ Place SmartKey ① in marked space ② on the symbol ③.  
The vehicle will start after a short time.

If you remove SmartKey ① from marked space ② the engine continues running. For further engine starts however, SmartKey ① must be located in marked space ② on symbol ③ during the entire journey.

- ▶ Have SmartKey ① checked at a qualified specialist workshop.

#### If the vehicle does not start:

- ▶ Place SmartKey ① in marked space ② and leave it there.
- ▶ Depress the brake pedal and start the vehicle using the start/stop button.
- ① You can also switch on the power supply or the ignition with the start/stop button.

### Starting the vehicle via Remote Online services

#### Cooling or heating the vehicle interior before commencing your journey

① This function is not available in all countries. If you start the vehicle via your smartphone, the previously selected air conditioning adjustment is active.

Ensure the following before starting the engine:

- the legal stipulations in the area where your vehicle is parked allow engine starting via smartphone.
- it is safe to start and run the engine where your vehicle is parked.
- the fuel tank is sufficiently filled.
- the starter battery is sufficiently charged.
- ① You can also set the temperature with your smartphone. Information on Mercedes me connect and other services: <http://www.mercedes.me>  
This function is not available for all models.

### Charging the battery before commencing your journey

 This function is not available in all countries.

If the vehicle battery is discharged, you receive a message on your smartphone. You can then start the vehicle with the smartphone to charge the battery. The vehicle is automatically switched off after ten minutes.

Ensure the following before starting the engine:

- The legal stipulations in the area where your vehicle is parked allow engine starting via smartphone.
- It is safe to start and run the engine where your vehicle is parked.
- The fuel tank is sufficiently filled.

### Starting the vehicle (Remote Online)

 **WARNING** Risk of crushing or entrapment due to unintentional starting of the engine

Limbs could be crushed or trapped if the engine is started unintentionally during service or maintenance work.

 Always secure the engine against unintentional starting before carrying out maintenance or repair work.

#### Requirements:

- Park position  is selected.
- The anti-theft alarm system is not activated.
- The panic alarm is not activated.
- The hazard warning lights are switched off.
- The hood is closed.
- The doors are closed and locked.
- The windows and sliding sunroof are closed.

 Start the vehicle using the smartphone: After every vehicle start, the engine runs for ten minutes.

You can carry out a maximum of two consecutive starting attempts. The vehicle must be started once with the SmartKey before trying to start the vehicle again with the smartphone. You can stop the vehicle again at any time.

 Further information can be found in the smartphone app.

### Securing the engine against starting before carrying out maintenance or repair work:

 Switch on the hazard warning lights.

or

 Unlock the doors.



or

 Open a side window or the sliding sunroof.

### Breaking-in notes

**Mercedes-AMG vehicles:** observe the notes in the Supplement. Otherwise, you may not recognize dangers.

To preserve the engine during the first 1,000 miles (1,500 km):

- Drive at varying road speeds and engine speeds.
- Drive the vehicle in drive program  or .
- Change gear before the tachometer needle is  $\frac{2}{3}$  of the way to the red area of the tachometer.

- Do not shift down a gear manually in order to brake.
- Avoid overstraining the vehicle, e.g. driving at full throttle.
- **Vehicles with automatic transmission:** Do not depress the accelerator pedal beyond the pressure point (kickdown).
- Only increase the engine speed gradually and accelerate the vehicle to full speed after 1,000 miles (1,500 km).

This also applies when the engine or parts of the drivetrain have been replaced.

Please also observe the following breaking-in notes:

- In certain driving and driving safety systems, the sensors adjust automatically while a certain distance is being driven after the vehicle has been delivered or after repairs. Full system effectiveness is not reached until the end of this teach-in process.
- Brakepads, brake discs and tires that are either new or have been replaced only achieve optimum braking effect and grip after

several hundred kilometers of driving. Compensate for the reduced braking effect by applying greater force to the brake pedal.

### Notes on driving

#### **⚠ WARNING** Risk of accident due to objects in the driver's footwell

Objects in the driver's footwell may impede pedal travel or block a depressed pedal.

This jeopardizes the operating and road safety of the vehicle.

- ▶ Stow all objects in the vehicle securely so that they cannot get into the driver's footwell.
- ▶ Always install the floor mats securely and as prescribed in order to ensure that there is always sufficient room for the pedals.
- ▶ Do not use loose floor mats and do not place floor mats on top of one another.

#### **⚠ WARNING** Risk of accident due to unsuitable footwear

Operation of the pedals may be restricted due to unsuitable footwear such as:

- Shoes with platform soles
- Shoes with high heels
- Slippers

▶ When driving always wear suitable shoes in order to be able to operate the pedals safely.

#### **⚠ WARNING** Risk of accident when switching off the ignition when driving

If you switch off the ignition while driving, safety functions are restricted or no longer available. This may affect the power steering system and the brake force boosting, for example.

You will then need to use considerably more force to steer and brake.

- ▶ Do not switch off the ignition while driving.

**⚠ DANGER** Risk of fatal injuries due to exhaust gases

Combustion engines emit poisonous exhaust gases such as carbon monoxide. Inhaling these exhaust gases is hazardous to health and can lead to poisoning.

- ▶ Never leave the engine running in an enclosed space without sufficient ventilation.

**⚠ WARNING** Risk of skidding and of an accident due to shifting down on slippery road surfaces

If you shift down on slippery road surfaces to increase the engine braking effect, the drive wheels may lose traction.

- ▶ Do not shift down on slippery road surfaces to increase the engine braking effect.

**⚠ DANGER** Risk of fatal injury due to poisonous exhaust gases

If the tailpipe is blocked or sufficient ventilation is not possible, poisonous exhaust gases such as carbon monoxide may enter the vehicle. This is the case if the vehicle gets stuck in snow, for example.

- ▶ Keep the tailpipe and the area around the vehicle free from snow when the engine or the stationary heater are running.
- ▶ Open a window on the windward side of the vehicle to ensure an adequate supply of fresh air.

**⚠ WARNING** Risk of accident and injury due to being under the influence of alcohol and drugs while driving

Driving when under the influence of alcohol and/or drugs is an extremely dangerous combination. Even small quantities of alcohol or drugs may affect your reflexes, perception and judgment.

The probability of a serious or even fatal accident greatly increases if you drive when under the influence of alcohol or drugs.

- ▶ Do not drink alcohol or take drugs while driving, and do not allow anyone to drive who has been drinking alcohol or taking drugs.

**⚠ WARNING** Risk of accident due to the brake system overheating

If you leave your foot on the brake pedal when driving, the brake system may overheat.

This increases the braking distance and the brake system may even fail.

- ▶ Never use the brake pedal as a footrest.
- ▶ Do not depress the brake pedal and the accelerator pedal at the same time while driving.

**!** **NOTE** Wearing out the brake linings by continuously depressing the brake pedal

- ▶ Do not depress the brake pedal continuously whilst driving.
- ▶ To use the braking effect of the engine, shift to a lower gear in good time.

**!** **NOTE** Damage to the drivetrain and engine when pulling away

- ▶ Do not warm up the engine while the vehicle is stationary. Pull away immediately.
- ▶ Avoid high engine speeds and driving at full throttle until the engine has reached its operating temperature.

**!** **NOTE** Damage to the catalytic converter due to non-combusted fuel

The engine is not running smoothly and is misfiring.  
Non-combusted fuel may get into the catalytic converter.

- ▶ Only depress the accelerator pedal slightly.
- ▶ Have the cause rectified immediately at a qualified specialist workshop.

Limited braking effect on salt-treated roads:

- Due to salt build-up on the brake discs and brakepads, the braking distance can increase considerably or result in braking only on one side
- Maintain a much greater safe distance to the vehicle in front

To prevent salt build-up:

- Brake occasionally while paying attention to the traffic conditions
- Carefully depress the brake pedal at the end of the journey and when starting the next journey

## ECO start/stop function

### Operation of the ECO start/stop function

**Mercedes-AMG vehicles:** observe the notes in the Supplement. Otherwise, you may not recognize dangers.

The engine is switched off automatically in the following situations if all vehicle conditions for an automatic engine stop are met:

- **Vehicles with automatic transmission:**  
You brake the vehicle to a standstill in transmission position **[D]** or **[N]**.

### Vehicles with automatic transmission:

If you switch on the HOLD function in transmission position **[D]** or **[N]**, the engine will automatically stop in the following situations:

- You stop behind a vehicle that is pulling away.
- You stop at a stop sign when there is no vehicle in front of you.
- You turn the steering wheel hard at a low speed.

- ❗ In transmission position **R**, the engine is not switched off automatically even when the HOLD function is switched on.

The engine is restarted automatically if:

- **Vehicles with automatic transmission:** In transmission position **D**, you release the brake pedal when the HOLD function is not active.
- **Vehicles with automatic transmission:** You shift into transmission position **D** or **R**.
- You depress the accelerator pedal.
- You change the vehicle level.
- An automatic engine start is necessary.

ECO start/stop function symbols in the multifunction display:

- The **A** symbol (green) appears when the vehicle is at a standstill: the engine was switched off by the ECO start/stop function.
- The **A** symbol (yellow) appears when the vehicle is at a standstill: not all vehicle conditions for an engine stop have been met.

- Neither the **A** nor **A** symbol appears when the vehicle is at a standstill: an intelligent stop inhibitor was detected, e.g. a stop sign.
- The **A** symbol (yellow) appears: the ECO start/stop function is deactivated or there is a malfunction.
- ❗ If, in spite of an intelligent stop inhibitor, the engine should be switched off by the ECO start/stop function, you have the following options:
  - Switch on the HOLD function in transmission position **D** or **N**.
  - Engage transmission position **P**.

If the engine was switched off by the ECO start/stop function and you leave the vehicle, a warning tone sounds and the engine is not restarted. The **Vehicle Operational Switch the Ignition Off Before Exiting** display message also appears in the multifunction display. If you do not switch off the ignition, the ignition is automatically switched off after three minutes.

### Deactivating or activating the ECO start/stop function

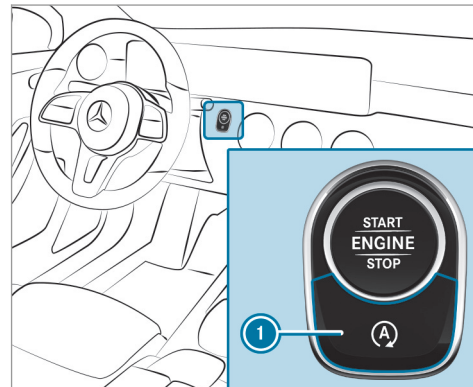

- ▶ Press button **1**.  
A display appears in the instrument cluster when switching the ECO start/stop function off/on.
- ❗ A continuous display appears in the instrument cluster while the ECO start/stop function is deactivated.



## ECO display function

The ECO display summarizes your driving characteristics from the start of the journey to its completion and assists you in achieving the most economical driving style.

You can influence consumption if you:

- drive with particular care
- drive the vehicle in drive program **E**
- observe the gearshift recommendations

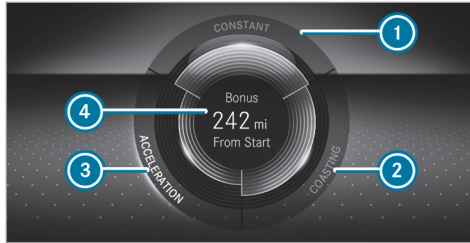

The lettering in the segment will light up brightly, the outer edge will light up and the segment will fill up where the following driving style is adopted:

- ① steady speed
- ② gentle deceleration and rolling
- ③ moderate acceleration

The lettering in the segment will be gray, the outer edge will be dark and the segment will empty where the following driving style is adopted:

- ① fluctuations in speed
- ② heavy braking
- ③ sporty acceleration

The ECO display will show you when you have driven economically:

- the three segments fill up completely at the same time
- the edge around all three segments lights up

The additional range achieved as a result of your driving style in comparison with a driver with a

very sporty driving style is shown in the center of display ④. The range displayed does not indicate a fixed reduction in consumption.

## DYNAMIC SELECT switch

### Function of the DYNAMIC SELECT switch

**Mercedes-AMG vehicles:** observe the notes in the Supplement. Otherwise, you may not recognize dangers.

Use the DYNAMIC SELECT switch to change between the following drive programs:

**I** (Individual): individual settings

**S** (Sport): sporty driving style

**C** (Comfort): comfortable and economical driving style

**E** (Eco): particularly economical driving style

- ① The drive program selected appears in the multifunction display of the on-board computer.

Depending on the drive program, the following systems change their characteristics:

- Drive
  - Engine and transmission management
  - Active Distance Assist DISTRONIC
- ESP®
- **Vehicles with adaptive damping adjustment:** suspension
- Electric power steering

### Notes on the roof load display

Certain drive programs and ESP® settings are unsuitable for transporting a roof load.

When setting or selecting these drive programs, a crossed-through vehicle with a roof load is shown as a warning. When this symbol is shown, the selected drive program is not suitable for transporting a load on the roof.

The following drive programs are affected:

- **Sport** drive program

- **Individual** drive program with the Sport ESP® setting

**i** The symbol is also shown in the following situations:

- Within the themes if a corresponding drive program is saved  
For more information on themes see (→ page 257).
- Within the reset display if the previously active drive program is unsuitable for the transport of a roof load  
For further information on the reset display, see (→ page 139).

### Selecting the drive program

**i** Depending on the equipment, the vehicle is equipped with either a switch or a button.

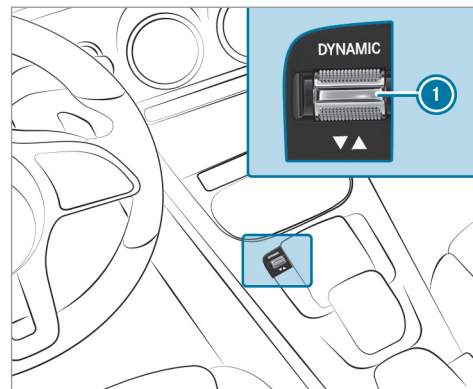

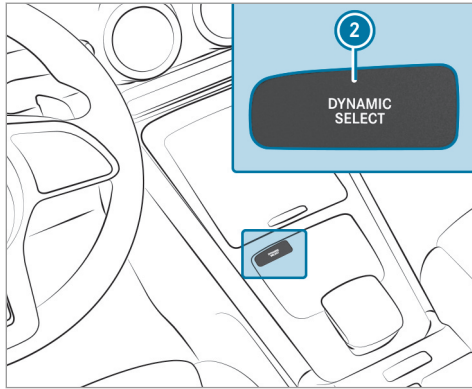

- ▶ Press DYNAMIC SELECT switch ① forwards or backwards.  
The drive program selected appears in the multifunction display.

or

- ▶ Press DYNAMIC SELECT button ②.  
The DYNAMIC SELECT menu appears in the multifunction display.

- ▶ Press DYNAMIC SELECT button ② again.  
The chosen drive program appears.

### Configuring DYNAMIC SELECT (multimedia system)

Multimedia system:

- ▶ Home ▶ Settings ▶ Vehicle
- ▶▶ DYNAMIC SELECT

#### Setting drive program I

- ▶ Select [Individual Config.](#)
- ▶ Select and set a category.

#### Switching the reset display on/off

- ▶ Switch [Request at Start](#) on or off.

**Function on:** the next time the vehicle is started a prompt appears asking whether the drive program last active should be restored. If the ECO start/stop function was deactivated, an additional prompt appears asking if the function should remain deactivated.

- ① The prompt appears only if the previously active settings deviate from the standard settings.

**Function off:** the next time the vehicle is started the **Comfort** drive program is set automatically. The ECO start/stop function is activated automatically.

- ① This function must be activated for each user profile separately. Only when this function is activated will the drive program and Eco start/stop setting for the previous journey be saved for the respective user profile.

### Displaying vehicle data

Multimedia system:

- ▶ Home ▶ Info

- ▶ Select [Vehicle](#).  
The vehicle data is displayed.

## Displaying engine data

Multimedia system:



- ▶ Select **Engine**.  
The engine data is displayed.

ⓘ The values for engine output and engine torque may deviate from the nominal values. Items that can influence this are, for example:

- Sea level
- Fuel grade
- Outside temperature

## Calling up fuel consumption indicator

Multimedia system:



- ▶ Select **Consumption**.  
The current and average fuel consumption is displayed.

## Automatic transmission

### DIRECT SELECT lever

#### Function of the DIRECT SELECT lever

**⚠ WARNING** Risk of accident due to incorrect gearshifting

If the engine speed is higher than the idle speed and you engage the transmission position **D** or **R**, the vehicle may accelerate sharply.

- ▶ If you engage the transmission position **D** or **R** always depress the brake pedal firmly and do not accelerate at the same time.

**⚠ WARNING** Risk of accident and injury due to children left unattended in the vehicle

If children are left unattended in the vehicle, they could:

- Open doors, thereby endangering other persons or road users.
- Get out and be struck by oncoming traffic.
- Operate vehicle equipment and become trapped, for example.

In addition, the children could also set the vehicle in motion, for example by:

- Releasing the parking brake.
- Changing the transmission position.
- Starting the vehicle.

- ▶ Never leave children unattended in the vehicle.
- ▶ When leaving the vehicle, always take the key with you and lock the vehicle.

- ▶ Keep the vehicle key out of reach of children.

Use the DIRECT SELECT lever to shift the transmission position. The current transmission position is displayed in the multifunction display.

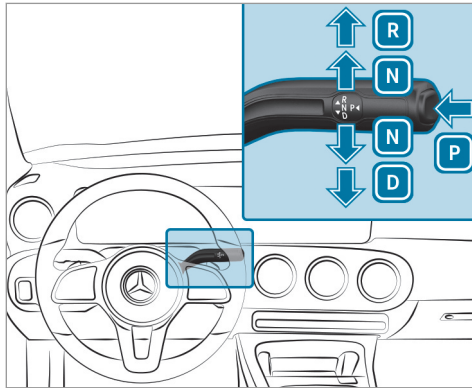

- P** Park position
- R** Reverse gear

- N** Neutral
- D** Drive position

#### Engaging reverse gear R

- ▶ Depress the brake pedal and push the DIRECT SELECT lever upwards past the first point of resistance. The transmission position display shows **R** in the multifunction display.

#### Engaging neutral N

- ▶ Depress the brake pedal and push the DIRECT SELECT lever up or down to the first point of resistance. The transmission position display shows **N** in the multifunction display.

Subsequently releasing the brake pedal will allow you to move the vehicle freely, e.g. to push it or tow it away.

**Proceed as follows if you want the automatic transmission to remain in neutral **N** even if the ignition is switched off:**

- ▶ Start the vehicle.

- ▶ Depress the brake pedal and engage neutral **N**.
- ▶ Release the brake pedal.
- ▶ Switch the ignition off.
- ⓘ If you then exit the vehicle leaving the SmartKey in the vehicle, the automatic transmission remains in neutral **N**.

#### Engaging park position P

- ▶ Observe the notes on parking the vehicle (→ page 148).
- ▶ Depress the brake pedal until the vehicle is stationary.
- ▶ When the vehicle is stationary, press button **P**. Park position is only engaged when the transmission position display **P** is shown in the multifunction display. If no transmission position display **P** appears, secure the vehicle to prevent it from rolling away.

Park position **P** is engaged automatically if one of the following conditions is met:

- You switch off the ignition when the vehicle is stationary and the transmission is in position **D** or **R**.
  - You open the driver's door when the vehicle is stationary or when driving at a very low speed and the transmission is in position **D** or **R**.
- i** To maneuver with an open driver's door, open the driver's door while stationary and engage transmission position **D** or **R** again.
- i** At very low outside temperatures from approx. -4 °F (-20 °C) you may not be able to shift the transmission from **P** to another transmission position when the engine is switched off. If this is the case, only change the transmission position while the engine is running.

### Engaging drive position D

- ▶ Depress the brake pedal and push the DIRECT SELECT lever down past the first point of resistance. The transmission position display shows **D** in the multifunction display.

When the automatic transmission is in transmission position **D**, it shifts the gears automatically. This depends on the following factors:

- The selected drive program
- The position of the accelerator pedal
- The driving speed

### Manual gearshifting

**▲ WARNING** Risk of skidding and of an accident due to shifting down on slippery road surfaces

If you shift down on slippery road surfaces to increase the engine braking effect, the drive wheels may lose traction.

- ▶ Do not shift down on slippery road surfaces to increase the engine braking effect.

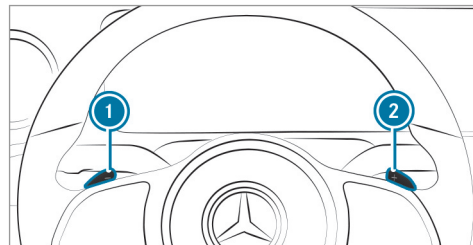

When the automatic transmission is shifted to position **D**, you can manually shift it with the steering wheel paddle shifter. If permitted, the automatic transmission shifts to the next gear up or down depending on the steering wheel paddle shifter being pulled.

You have two options to manually shift the automatic transmission:

- Temporary setting
- Permanent setting

The gears shift automatically when manual gearshifting is deactivated.

#### Temporary setting:

- ▶ **To activate:** pull steering wheel paddle shifter ① or ②.  
Manual gearshifting is activated for a short time. The current gear is displayed in the multifunction display.
- ① How long the manual gearshifting stays activated is dependent on the driving style.
- ▶ **To shift up:** pull steering wheel paddle shifter ②.
- ▶ **To shift down:** pull steering wheel paddle shifter ①.  
If you pull and hold the steering wheel paddle shifter ①, the transmission shifts to the lowest possible gear.
- ▶ **To deactivate:** pull steering wheel paddle shifter ② and hold it in place.  
The transmission position **D** appears in the multifunction display.

#### Permanent setting:

- ▶ Change to drive program **IP** (→ page 138).
- ▶ Select the **Manual** drive program (→ page 139).

**Mercedes-AMG vehicles:** observe the notes in the Supplement. Otherwise, you may not recognize dangers.

#### Gearshift recommendation

**Mercedes-AMG vehicles:** observe the notes in the Supplement. Otherwise, you may not recognize dangers.

The gearshift recommendation assists you in adopting an economical driving style.

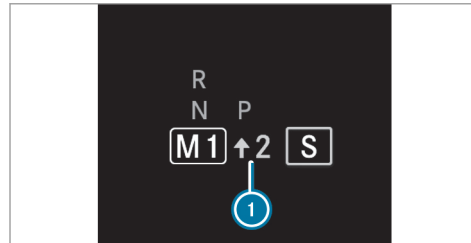

- ▶ If gearshift recommendation message ① is shown on the multifunction display, shift to the recommended gear.

#### Using kickdown

**Mercedes-AMG vehicles:** observe the notes in the Supplement. Otherwise, you may fail to recognize dangers.

- ▶ **Maximum acceleration:** depress the accelerator pedal beyond the pressure point.

The automatic transmission shifts up to the next gear when the maximum engine speed is reached to protect the engine from overrevving.

#### Glide mode function

**Mercedes-AMG vehicles:** observe the notes in the Supplement. Otherwise, you may fail to recognize dangers.

With an anticipatory driving style, Glide mode helps you to reduce fuel consumption.

## 144 Driving and parking

Glide mode is characterized by the following:

- The combustion engine is disconnected from the drivetrain and the engine continues to run in neutral.
- The transmission position **D** is displayed in green in the multifunction display.

Glide mode is activated if the following conditions are met:

- Drive program **E** is selected.
- The speed is within a suitable range.
- The road's course is suitable, e.g. no steep uphill or downhill inclines or tight bends.

- You are no longer depressing the accelerator or brake pedal.

**i** Glide mode can also be activated if you have selected the "Eco" setting for the drive in the drive program **I**.

Glide mode is deactivated again if one of the conditions is no longer met.

### Vehicles with Active Distance Assist

**DISTRONIC:** when Active Distance Assist DISTRONIC is active, the glide mode function is not available.

Glide mode can also be prevented by the following parameters:

- Incline

- Downhill gradient
- Temperature
- Height
- Speed
- Operating status of the engine
- Traffic situation

**i** Glide mode can be ended by pressing the right-hand steering wheel paddle shifter (→ page 142).

## Problems with the transmission

Problem	Possible causes/consequences and ► Solutions
The transmission has a faulty gearshift.	The transmission is losing oil. ► Have the transmission checked at a qualified specialist workshop immediately.
The acceleration characteristics are deteriorating.	The transmission is in emergency operation mode.



Problem	Possible causes/consequences and ► Solutions
The transmission no longer shifts gear.	<ul style="list-style-type: none"> <li>► Pull over and stop the vehicle safely as soon as possible, paying attention to road and traffic conditions.</li> <li>► Switch the transmission to position <b>P</b>.</li> <li>► Switch off the engine.</li> <li>► Wait at least ten seconds before restarting the engine.</li> <li>► Switch the transmission to position <b>D</b>.</li> <li>► Have the transmission checked at a qualified specialist workshop immediately.</li> </ul>

### Function of 4MATIC

4MATIC ensures that all four wheels are driven when needed. Together with ESP® and 4ETS, 4MATIC improves the traction of your vehicle whenever a driven wheel spins due to insufficient traction.

If you fail to adapt your driving style, 4MATIC can neither reduce the risk of an accident nor override the laws of physics. 4MATIC cannot take account of road, weather and traffic conditions. 4MATIC is only an aid. You are responsible especially for maintaining a safe distance from the

vehicle in front, for vehicle speed, for braking in good time and for staying in lane.

- ⓘ In wintry road conditions, the maximum effect of 4MATIC can be achieved only if you use winter tires (M+S tires), with snow chains if necessary.

### Refueling

#### Refueling the vehicle

**▲ WARNING** Risk of fire or explosion from fuel

Fuels are highly flammable.

- Fire, open flames, smoking and creation of sparks must be avoided.
- Switch off the ignition and, if available, the stationary heater, before and while refueling the vehicle.

**⚠ WARNING** Risk of injury from fuels

Fuels are poisonous and hazardous to your health.

- ▶ Do not swallow fuel or let it come into contact with skin, eyes or clothing.
- ▶ Do not inhale fuel vapor.
- ▶ Keep children away from fuel.
- ▶ Keep doors and windows closed during the refueling process.

If you or other people come into contact with fuel, observe the following:

- ▶ Immediately rinse fuel off your skin with soap and water.
- ▶ If fuel comes into contact with your eyes, immediately rinse them thoroughly with clean water. Seek medical attention immediately.
- ▶ If you swallow fuel, seek medical attention immediately. Do not induce vomiting.

- ▶ Change immediately out of clothing that has come into contact with fuel.

**⚠ WARNING** Risk of fire or explosion from electrostatic charge

Electrostatic charge can create sparks and thereby ignite fuel vapors.

- ▶ Before opening the fuel filler cap or taking hold of the pump nozzle, touch the metallic body of the vehicle. This discharges any electrostatic charge that may have built up.
- ▶ Do not get into the vehicle again during the refueling process. Otherwise, electrostatic charge could build up again.

**! NOTE** Damage caused by the wrong fuel

Vehicles with a gasoline engine:

Even small amounts of the wrong fuel could result in damage to the fuel system, the engine and the emission control system.

- ▶ The RON requirement is located in the fuel filler flap.
- ▶ Only refuel with low-sulfur unleaded fuel.

This fuel may contain up to 10% ethanol. Your vehicle is suitable for use with E10 fuel.

Never refuel using any of the following fuels:

- Diesel
- Gasoline with more than 10% ethanol by volume, e.g. E15, E85, E100
- Gasoline with more than 3% methanol by volume, e.g. M15, M30, M85, M100
- Gasoline with additives containing metal

If you accidentally refuel with the wrong fuel:

- ▶ Do not switch the ignition on.
- ▶ Consult a qualified specialist workshop.

**!** **NOTE** Do not use diesel to refuel vehicles with a gasoline engine.

If you accidentally refuel with the wrong fuel:

- Do not switch the ignition on. Otherwise fuel can enter the engine.

Even small amounts of the wrong fuel could result in damage to the fuel system and the engine. The repair costs are high.

- ▶ Consult a qualified specialist workshop.
- ▶ Have the fuel tank and fuel lines drained completely.

**!** **NOTE** Damage to the fuel system caused by overfilled fuel tanks.

- ▶ Only fill the tank until the pump nozzle switches off.

If you have added too much fuel because of a defective filling pump, for instance:

- ▶ Do not switch the ignition on.
- ▶ Consult a qualified specialist workshop.

**!** **NOTE** Fuel may spray out when you remove the fuel pump nozzle.

- ▶ Only fill the fuel tank until the pump nozzle switches off.

#### Requirements

- The vehicle or the fuel filler flap is unlocked (→ page 65).
- i** Do not get into the vehicle again during the refueling process. Otherwise, electrostatic charge could build up again.

Observe the notes on operating fluids (→ page 450).

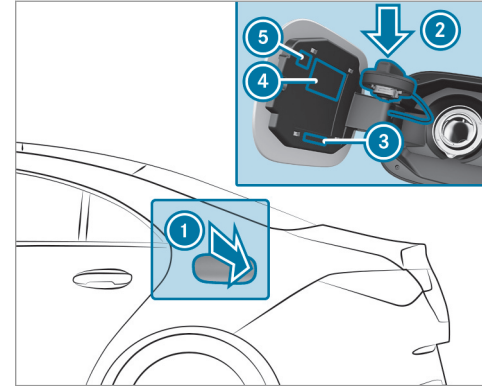

- Fuel filler flap
- Bracket for the fuel filler cap
- Fuel type
- Tire pressure table
- QR code for rescue card

- ▶ Press on the back area of fuel filler flap **1**.
- ▶ Turn the fuel filler cap counter-clockwise and remove it.

- ▶ Insert the fuel filler cap into bracket ②.
- ▶ Completely insert the pump nozzle into the tank filler neck, hook in place and refuel.
- ▶ Only fill the fuel tank until the pump nozzle switches off.
- ▶ Replace the cap on the filler neck and turn clockwise until it engages audibly.
- ▶ Close the fuel filler flap.

## Parking

### Parking the vehicle

**⚠ WARNING** Risk of accident and injury caused by an insufficiently secured vehicle rolling away.

If the vehicle is not securely parked sufficiently, it can roll away in an uncontrolled way even at a slight downhill gradient.

- ▶ Ensure that the parked vehicle is always properly secured against rolling away as follows:

- On uphill or downhill gradients, turn the front wheels so that the vehicle rolls towards the curb if it starts moving.
- Apply the parking brake.
- Vehicles with automatic transmission: shift the transmission to position **P**.
- Vehicles with manual transmission: engage first **1** or reverse gear **R**.

**⚠ WARNING** Risk of fire caused by hot exhaust system parts

Flammable material such as leaves, grass or twigs may ignite if they come into contact with hot parts of the exhaust system or exhaust gas flow.

- ▶ Park the vehicle so that no flammable material can come into contact with hot vehicle components.
- ▶ In particular, do not park on dry grassland or harvested grain fields.

**⚠ WARNING** Risk of accident and injury due to children left unattended in the vehicle

If children are left unattended in the vehicle, they could:

- Open doors, thereby endangering other persons or road users.
- Get out and be struck by oncoming traffic.
- Operate vehicle equipment and become trapped, for example.

In addition, the children could also set the vehicle in motion, for example by:

- Releasing the parking brake.
- Changing the transmission position.
- Starting the vehicle.
- ▶ Never leave children unattended in the vehicle.
- ▶ When leaving the vehicle, always take the key with you and lock the vehicle.

- ▶ Keep the vehicle key out of reach of children.

**!** **NOTE** Damage to the vehicle due to it rolling away

- ▶ Always secure the vehicle against rolling away.

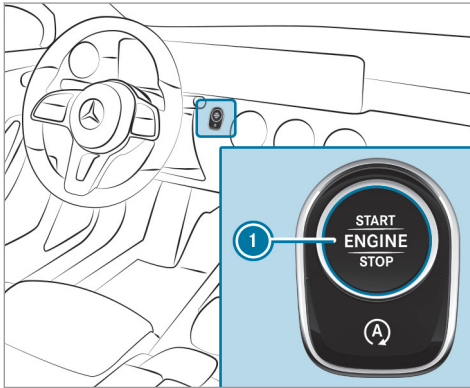

- ▶ Bring the vehicle to a standstill by applying the brake pedal.
  - ▶ On uphill or downhill gradients, turn the front wheels so that the vehicle rolls towards the curb if it starts moving.
  - ▶ Apply the electric parking brake.
  - ▶ **Vehicles with automatic transmission:** Engage transmission position **P** in a stationary vehicle with the brake pedal applied (→ page 141).
  - ▶ Switch off the engine and the ignition by pressing button **1**.
  - ▶ Release the service brake slowly.
  - ▶ Get out of the vehicle and lock it.
- i** When you park the vehicle, you can still operate the side windows and the panoramic sliding sunroof for approximately five minutes if the driver's door is closed.

## Garage door opener

### Programming buttons for the garage door opener

**!** **DANGER** Risk of fatal injuries due to exhaust gases

Combustion engines emit poisonous exhaust gases such as carbon monoxide. Inhaling these exhaust gases is hazardous to health and can lead to poisoning.

- ▶ Never leave the engine running in an enclosed space without sufficient ventilation.

**!** **WARNING** Risk of injury when opening or closing a door with the garage door opener

When you operate or program the door with the integrated garage door opener, people in the range of movement of the door may become trapped or struck by the door.

- ▶ When using the integrated garage door opener, always make sure that nobody

is within the range of movement of the door.

Only operate the following doors using the garage door opener:

- Doors with a safety stop and reversing feature.
- Doors which conform to the current U.S. safety standards.

**Requirements:**

- The vehicle has been parked outside the garage or outside the range of movement of the door.
  - The engine is switched off.
  - The ignition is switched on.
- i** The garage door opener function is always available when the ignition is switched on.

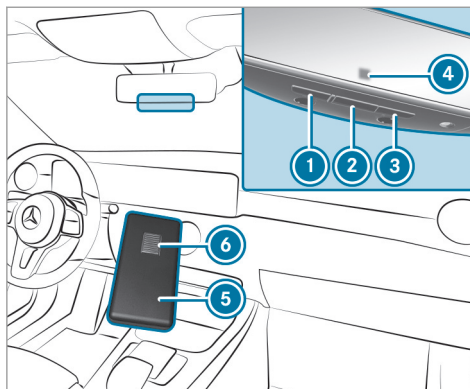

- ▶ Check if the transmitter frequency of the remote control has the frequency range of 280 to 868 MHz.

Radio equipment approval number:

- NZLMUAHL5 (USA)
- 4112A-MUAHL5 (Canada)

- ▶ Press and hold button ①, ② or ③ that you wish to program. Indicator lamp ④ flashes yellow.

**i** It can take up to 20 seconds before the indicator lamp flashes yellow.

- ▶ Release the previously pressed button. Indicator lamp ④ continues to flash yellow.

- ▶ Point remote control ⑤ from a distance of 1 in (1 cm) to 3 in (8 cm) towards buttons ①, ② or ③.

- ▶ Press and hold button ⑥ of remote control ⑤ until one of the following signals appears:

- Indicator lamp ④ lights up green continuously. Programming is complete.
- Indicator lamp ④ flashes green. Programming was successful. Additionally, synchronization of the rolling code with the door system must also be carried out.

- ▶ If indicator lamp ④ does not light up or flash green: repeat the procedure.

- ▶ Release all of the buttons.

- ❗ The remote control for the door drive is not included in the scope of delivery of the garage door opener.

### Synchronizing the rolling code

#### Requirements:

- The door system uses a rolling code.
- The vehicle must be within range of the garage door or door drive.
- The vehicle as well as persons and objects, are located outside the range of movement of the door.

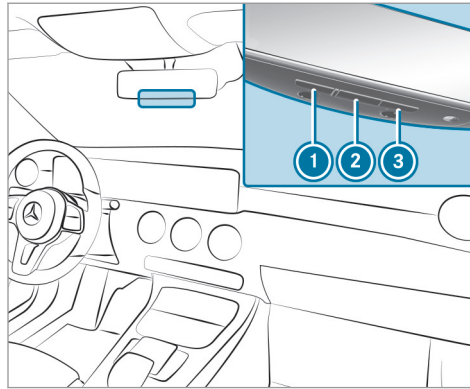

- ▶ Press the programming button on the door drive unit. Initiate the next step within approximately 30 seconds.
- ▶ Press previously programmed button ①, ② or ③ repeatedly until the door closes. When the door closes, programming is completed.

- ❗ Please also read the operating instructions for the door drive.

### Troubleshooting when programming the remote control

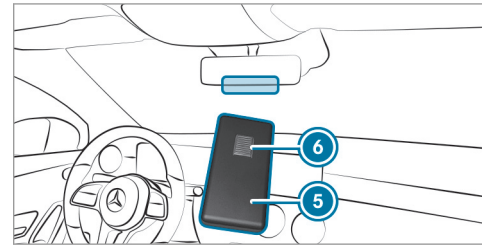

- ▶ Check if the transmitter frequency of remote control ⑤ is supported.
- ▶ Replace the batteries in remote control ⑤.
- ▶ Hold remote control ⑤ at various angles at a distance between 1 in (1 cm) to 3 in (8 cm) in front of the inside rearview mirror. You should test every position for at least 25 seconds before trying another position.

- ▶ Hold remote control ⑤ at the same angles at various distances in front of the inside rearview mirror. You should test every position for at least 25 seconds before trying another position.
- ▶ Note that some remote controls transmit only for a limited period, press button ⑥ on remote control ⑤ again before transmission ends.
- ▶ Align the antenna line of the door opener unit with the remote control.

① Support and additional information on programming:

- On the toll free HomeLink® Hotline on 1-800-355-3515.
- On the Internet at <http://www.homelink.com/mercedes>.

### Opening/closing a garage door

#### Requirements:

- The corresponding button is programmed to operate the door.

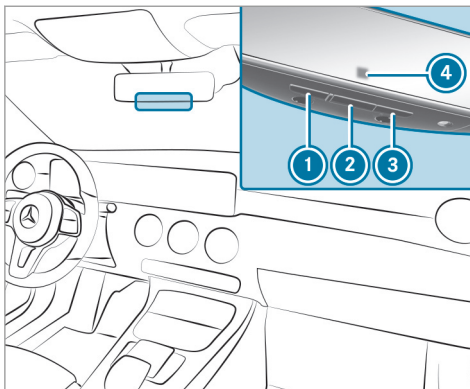

- ▶ Press and hold buttons ①, ② or ③ until the door opens or closes.
- ▶ If indicator lamp ④ flashes yellow after approximately 20 seconds: press and hold the previously pressed button again until the door opens or closes.

### Clearing the garage door opener memory

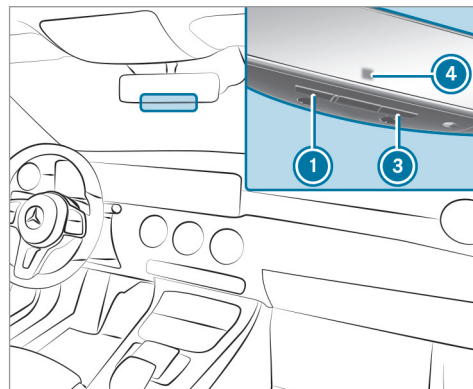

- ▶ Press and hold buttons ① and ③. Indicator lamp ④ lights up yellow.
- ▶ If indicator lamp ④ flashes green: release buttons ① and ③. The entire memory has been deleted.

### Radio equipment approval numbers for the garage door opener



## Radio equipment approval numbers



Brazil

Este equipamento opera em caráter secundário, isto é, não tem direito à proteção contra interferência prejudicial, mesmo de estações do mesmo tipo, e não pode causar interferência a sistemas operando em caráter primário.

Para maiores informações acessar [www.anatel.gov.br](http://www.anatel.gov.br)

## Radio equipment approval numbers

Country	Radio type approval number
Egypt	TAC.2511151293.WIR
Andorra	CE
Australia	R-NZ
Barbados	MED1578
Chile	2488/DFRS20576/F-74
European Union	CE
Gibraltar	CE
Iceland	CE
Jordan	TRC/LPD/2015/299
Canada	IC: 4112A-MUAHL5
Kuwait	CE
Liechtenstein	CE

Country	Radio type approval number
Mexico	RCPGEMU15-0448
Monaco	CE
New Zealand	R-NZ
Norway	CE
Russian Federation	Not required
Saudi Arabia	TA 10525
Switzerland	CE
South Africa	 TA-2015/1386
Turkey	Not required

Country	Radio type approval number
United Arab Emirates	ER41849/15 Dealer No: DA35176/14
United States	FCC ID: NZLNUAHL5

Further information on the declaration of conformity for wireless vehicle components (→ page 25).

### Electric parking brake

#### Electric parking brake function (applying automatically)

**⚠ WARNING** Risk of accident and injury due to children left unattended in the vehicle

If children are left unattended in the vehicle, they could:

- Open doors, thereby endangering other persons or road users.
- Get out and be struck by oncoming traffic.
- Operate vehicle equipment and become trapped, for example.

In addition, the children could also set the vehicle in motion, for example by:

- Releasing the parking brake.
- Changing the transmission position.
- Starting the vehicle.

- ▶ Never leave children unattended in the vehicle.
- ▶ When leaving the vehicle, always take the key with you and lock the vehicle.
- ▶ Keep the vehicle key out of reach of children.

The electric parking brake is applied if the transmission is in position **P** and one of the following conditions is fulfilled:

- The engine is switched off.
- The seat belt tongue is not inserted in the seat belt buckle of the driver's seat and the driver's door is opened.

**i** To prevent application: pull the handle of the electric parking brake.

In the following situations, the electric parking brake is also applied:

- Active Distance Assist DISTRONIC is bringing the vehicle to a standstill.
- The HOLD function is keeping the vehicle stationary.

- Active Parking Assist is keeping the vehicle stationary.

This is the case if one of the following conditions is also fulfilled:

- The engine is switched off.
- The seat belt tongue is not inserted in the seat belt buckle of the driver's seat and the driver's door is opened.
- There is a system malfunction.
- The power supply is insufficient.
- The vehicle is stationary for a lengthy period.

When the electric parking brake is applied, the red **PARK** (USA) or **(P)** (Canada) indicator lamp appears in the instrument cluster.

The electric parking brake is not automatically applied if the engine is switched off by the ECO start/stop function.

### Electric parking brake function (releasing automatically)

The electric parking brake is released when the following conditions are fulfilled:

- The driver's door is closed.
- The engine is running.
- **Vehicles with automatic transmission:** The transmission is in position **D** or **R** and you depress the accelerator pedal or you shift from transmission position **P** to **D** or **R**.
- If the transmission is in position **R**, the trunk lid must be closed.

If the seat belt tongue is not inserted into the seat belt buckle of the driver's seat, the following conditions must be fulfilled:

- The driver's door is closed.
- **Vehicles with automatic transmission:** You move the transmission out of transmission position **P** or you have previously driven faster than 2 mph (3 km/h).

When the electric parking brake is released, the red **PARK** (USA) or **(P)** (Canada) indicator lamp in the instrument cluster goes out.

### Applying/releasing the electric parking brake manually

#### Applying

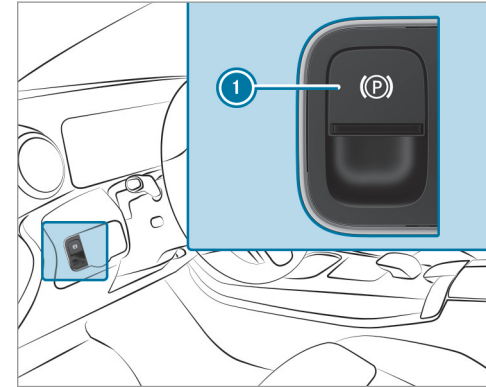

▶ Push handle ①.  
The red **PARK** (USA) or **(P)** (Canada) indicator lamp appears in the instrument cluster.

① The electric parking brake is only securely applied if the indicator lamp is lit continuously.

### Releasing

▶ Switch on the ignition.

▶ Pull handle ①.  
The red **PARK** (USA) or **(P)** (Canada) indicator lamp in the instrument cluster goes out.

### Emergency braking

▶ Press and hold handle ①.  
When the vehicle has been braked to a standstill, the electric parking brake is applied. The red **PARK** (USA) or **(P)** (Canada) indicator lamp appears in the instrument cluster.

### Information on detecting damage on a parked vehicle

If a collision is detected when the tow-away alarm is armed on a locked vehicle, you will receive a notification in the multimedia system when you switch on the ignition.

You will receive information about the following points:

- The area of the vehicle that may have been damaged.
- The force of the impact.

The following situations can lead to inadvertent activation:

- The parked vehicle is moved, e.g. in a two-story garage.
- ① Disarm the tow-away alarm in order to prevent inadvertent activation. If you disarm the tow-away alarm, damage detection will also be deactivated.
- ① In the case of severe battery discharging, the function for detecting damage on a

parked vehicle is automatically deactivated to facilitate the next engine start.

### System limitations

Detection may be restricted in the following situations:

- The vehicle is damaged without impact, e.g. if an outside mirror is torn off or the paint is damaged by a key.
- Impact occurs at low speed.
- The electric parking brake is not applied.

### Notes on parking the vehicle for an extended period

If you leave the vehicle parked for longer than four weeks, the disconnected battery may be damaged by deep discharge.

If you leave the vehicle parked for longer than six weeks, it may suffer disuse damage.

① Further information can be obtained at a qualified specialist workshop.

### Standby mode (extension of the starter battery's period out of use)

#### Standby mode function

**i** This function is not available for all models. If standby mode is activated, the vehicle can be parked for an extended period of time without losing power.

Standby mode is characterized by the following:

- The starter battery is preserved.
- The maximum non-operational time appears in the media display.
- The connection to online services is interrupted.
- The ATA (anti-theft alarm system) is not available.
- The interior motion sensor and tow-away alarm functions are not available.
- The function for detecting damage on a parked vehicle is not available.

If the following conditions are fulfilled, standby mode can be activated or deactivated using the multimedia system:

- The engine is switched off.
- The ignition is switched on.

Exceeding the vehicle's displayed non-operational time may cause inconvenience, i.e. it cannot be guaranteed that the starter battery will reliably start the engine.

The starter battery must be charged first in the following situations:

- The vehicle's non-operational time must be extended.
- The **Battery Charge Insufficient for Standby Mode** message appears in the media display.

**i** Standby mode is automatically deactivated when the ignition is switched on.

#### Activating/deactivating standby mode (parking the vehicle for an extended period)

##### Requirements:

- The engine is switched off.

Multimedia system:

 **Settings** **» Fahrzeug** (Vehicle)

- ▶ Activate or deactivate **Standby Mode**. When you activate the function, a prompt appears.
- ▶ Select **Yes**. Standby mode is activated.

### Driving and driving safety systems

#### Driving systems and your responsibility

Your vehicle is equipped with driving systems which assist you in driving, parking and maneuvering the vehicle. The driving systems are aids and do not relieve you of your responsibility pertaining to road traffic law. Pay attention to the traffic conditions at all times and intervene when necessary. Be aware of the limitations regarding the safe use of these systems.

#### Information about radar sensors

Some driving and driving safety systems use radar sensors to monitor the area in front of,

behind or next to the vehicle (depending on the vehicle's equipment).

Depending on the vehicle's equipment, the radar sensors are integrated behind the bumpers and/or behind the Mercedes star. Keep these parts free of dirt, ice and slush (→ page 391). The sensors must not be covered, for example by cycle racks, overhanging loads, stickers, foil or foils to protect against stone chipping. In the event of damage to the bumpers or radiator grill, or following a collision impacting the bumpers or radiator grill, have the function of the radar sensors checked at a qualified specialist workshop. The driving systems and driving safety systems may no longer function properly in such cases.

### Overview of driving systems and driving safety systems

In this section, you will find information about the following driving systems and driving safety systems:

- 360° Camera (→ page 189)
- ABS (Anti-lock Braking System) (→ page 158)

- Active Distance Assist DISTRONIC (→ page 170)
- Adaptive Brake Lights (→ page 168)
- Active Brake Assist (→ page 162)
- Active Lane Keeping Assist (→ page 205)
- ATTENTION ASSIST (→ page 198)
- BAS (Brake Assist System) (→ page 159)
- Hill Start Assist (→ page 179)
- Suspension with adaptive damping adjustment (→ page 181)
- EBD (Electronic Brakeforce Distribution) (→ page 162)
- ESP® (Electronic Stability Program) (→ page 159)
- Active Speed Limit Assist (→ page 174)
- HOLD function (→ page 179)
- STEER CONTROL (→ page 162)
- Active Steering Assist (→ page 175)
- Active Parking Assist (→ page 192)
- Parking Assist PARKTRONIC (→ page 181)
- Rear view camera (→ page 186)

- Cruise control (→ page 168)
- Blind Spot Assist and Active Blind Spot Assist with exit warning (→ page 202)
- Traffic Sign Assist (→ page 200)

### Function of ABS (Anti-lock Braking System)

ABS regulates the brake pressure in critical driving situations:

- During braking, e.g. at full brake application or insufficient tire traction, the wheels are prevented from locking.
- Vehicle steerability while braking is ensured.

If ABS intervenes when braking, you will feel a pulsing in the brake pedal. The pulsating brake pedal can be an indication of hazardous road conditions and can serve as a reminder to take extra care while driving.

### System limitations

- ABS is active from speeds of approx. 5 mph (8 km/h).
- ABS may be impaired or may not function if a malfunction has occurred and the yel-

low  ABS warning lamp lights up continuously in the instrument cluster after the engine is started.

### Function of BAS (Brake Assist System)

**⚠ WARNING** Risk of an accident caused by a malfunction in BAS (Brake Assist System)

If BAS is malfunctioning, the braking distance in an emergency braking situation is increased.

▶ Depress the brake pedal with full force in emergency braking situations. ABS prevents the wheels from locking.

BAS supports your emergency braking situation with additional brake force.

If you depress the brake pedal quickly, BAS is activated:

- BAS automatically boosts the brake pressure.
- BAS can shorten the braking distance.

- ABS prevents the wheels from locking. The brakes will function as usual once you release the brake pedal. BAS is deactivated.

### Functions of ESP® (Electronic Stability Program)

**⚠ WARNING** Risk of skidding if ESP® is malfunctioning

If ESP® is malfunctioning, ESP® cannot carry out vehicle stabilization. In addition, other driving safety systems are switched off.

- ▶ Drive on carefully.
- ▶ Have ESP® checked at a qualified specialist workshop.

**⚠ WARNING** Risk of skidding if ESP® is deactivated

If you deactivate ESP®, ESP® cannot carry out vehicle stabilization.

▶ ESP® should only be deactivated in the following situations.

**Mercedes-AMG vehicles:** always observe the notes in the Supplement. Otherwise, you may fail to recognize dangers.

ESP® can monitor and improve driving stability and traction in the following situations, within physical limits:

- When pulling away on a wet or slippery roadway.
- When braking.
- In strong side winds when you are driving faster than 50 mph (80 km/h).

If the vehicle deviates from the direction desired by the driver, ESP® can stabilize the vehicle by intervening in the following ways:

- One or more wheels are braked.
- The engine output is adapted according to the situation.

ESP® is deactivated if the  ESP® OFF warning lamp lights up continuously in the instrument cluster.

Observe the following points when ESP® is deactivated:

- Driving stability will no longer be improved.
- Crosswind Assist is no longer active.
- The drive wheels could spin.
- ETS/4ETS traction control is still active.

 When ESP® is deactivated, you are still assisted by ESP® when braking.

If the  ESP® warning lamp flashes in the instrument cluster, one or several vehicle wheels has reached its grip limit:

- Adapt the driving style to suit the prevailing road and weather conditions.

- Do not deactivate ESP® under any circumstances.
- Only depress the accelerator pedal as far as is necessary.

It may be best to deactivate ESP® in the following situations:

- When using snow chains.
- In deep snow.
- On sand or gravel.

 Spinning the wheels results in a cutting action, which enhances traction.

If the  ESP® warning lamp lights up continuously, ESP® is not available due to a malfunction.

Observe the following information:

- Warning and indicator lamps (→ page 504)

- Display messages (→ page 459)

### ETS/4ETS (Electronic Traction System)

ETS/4ETS traction control is part of ESP® and makes it possible to pull away and accelerate on a slippery roadway.

ETS/4ETS can improve the vehicle's traction by intervening in the following ways:

- The drive wheels are braked individually if they spin.
- More drive torque is transferred to the wheel or wheels with traction.

### Influence of drive programs on ESP®

The drive programs enable ESP® to adapt to different weather and road conditions as well as the driver's preferred driving style. You can select the drive programs using the DYNAMIC SELECT switch (→ page 138).



## ESP® characteristics per drive program

Drive program	ESP® mode	Characteristics
<input type="checkbox"/> <b>C</b> (Comfort) <input type="checkbox"/> <b>E</b> (Economy)	ESP® Comfort	<p>These drive programs provide the ideal balance between traction and stability.</p> <p>Select drive program <input type="checkbox"/> <b>E</b> or <input type="checkbox"/> <b>C</b> in difficult road conditions, such as snow or ice, or when the road is wet from rain.</p>
<input type="checkbox"/> <b>S</b> (Sport)	ESP® Sport	<p>This drive program continues to offer stability but with a sporty setup which allows the enthusiastic driver a more active driving style.</p> <p>Select drive program <input type="checkbox"/> <b>S</b> in good road conditions, for example on a dry roadway and clear stretches of road.</p>

### Activating/deactivating ESP® (Electronic Stability Program)

Multimedia system:

 **Settings** **Quick Access**

-  ESP® can only be activated/deactivated using quick access when at least one other function is available in quick access. ESP®

can otherwise be found in the [Assistance](#) menu.

**Mercedes-AMG vehicles:** observe the notes in the Supplement. Otherwise, you may not recognize dangers.

- ▶ Select **ESP**.  
A prompt appears.

- ▶ Select **On** or  **Off**.

ESP® is deactivated if the  ESP® OFF warning lamp lights up continuously in the instrument cluster.

Observe the information on warning lamps and display messages which may be shown in the instrument cluster.

### Function of ESP® Crosswind Assist

ESP® Crosswind Assist detects sudden gusts of side wind and helps the driver to keep the vehicle in the lane:

- ESP® Crosswind Assist is active at vehicle speeds between 50 mph (80 km/h) and 125 mph (200 km/h) when driving straight ahead or cornering slightly.
- The vehicle is stabilized by means of individual brake application on one side.

### Function of EBD (electronic brake force distribution)

EBD is characterized by the following:

- Monitoring and regulating the brake pressure on the rear wheels.
- Improved driving stability when braking, especially on bends.

### Function of STEER CONTROL

STEER CONTROL helps you by transmitting a noticeable steering force to the steering wheel in the direction required for vehicle stabilization.

This steering recommendation is given particularly in the following situations:

- Both right wheels or both left wheels are on a wet or slippery road surface when you brake
- The vehicle starts to skid

#### System limitations

STEER CONTROL may be impaired or may not function in the following situations:

- ESP® is deactivated
- ESP® is malfunctioning
- The steering is malfunctioning

If ESP® is malfunctioning, you will be assisted further by the electric power steering.

### Function of Active Brake Assist

Active Brake Assist consists of the following functions:

- Distance warning function
- Autonomous braking function
- Situation-dependent braking assistance
- **Vehicles with Driving Assistance Package:** Evasive Steering Assist

Active Brake Assist can help you to minimize the risk of a collision with vehicles, cyclists or pedestrians, or reduce the effects of such a collision.

If Active Brake Assist has detected a risk of collision, a warning tone sounds and the  distance warning lamp lights up in the instrument cluster.

If you do not react to the warning, autonomous braking can be initiated in critical situations.

In especially critical situations, Active Brake Assist can initiate autonomous braking directly. In this case, the warning lamp and warning tone

occur simultaneously with the braking application.

If you apply the brake yourself in a critical situation or apply the brake during autonomous braking, situation-dependent braking assistance occurs. The brake pressure increases up to maximum full-stop braking if necessary.



If autonomous braking or situation-dependent braking assistance has occurred, display ⓘ appears in the multifunction display and then automatically goes out after a short time.

If the autonomous braking function or the situation-dependent braking assistance is triggered, additional preventive measures for occupant protection (PRE-SAFE®) may also be initiated.

**⚠ WARNING** Risk of an accident caused by limited detection performance of Active Brake Assist

Active Brake Assist cannot always clearly identify objects and complex traffic situations.

In such cases, Active Brake Assist might:

- Give a warning or brake without reason
  - Not give a warning or not brake
- ▶ Always pay careful attention to the traffic situation; do not rely on Active Brake Assist alone. Active Brake Assist is only an aid. The driver is responsible for maintaining a suitable distance to the

vehicle in front, vehicle speed and for braking in good time.

- ▶ Be prepared to brake or swerve if necessary.

Also observe the system limitations of Active Brake Assist.

**The individual subfunctions are available in the following speed ranges:**

The distance warning function issues a warning in the following situations:

- From approximately 4 mph (7 km/h), if your vehicle is critically close to a vehicle or pedestrian, you will hear an intermittent warning tone and the ⓘ distance warning lamp lights up in the instrument cluster.

Brake immediately or take evasive action, provided it is safe to do so and the traffic situation allows this.

The distance warning function can aid you in the following situations with an intermittent warning tone and a warning lamp:

	Vehicles traveling in front	Stationary vehicles	Crossing vehicles	Moving pedestrians	Stationary pedestrians	Crossing cyclists	Cyclists traveling in front	Stationary cyclists
Vehicles without Driving Assistance Package	Up to approx. 155 mph (250 km/h)	Up to approx. 50 mph (80 km/h)	No reaction	Up to approx. 50 mph (80 km/h)	No reaction	Up to approx. 37 mph (60 km/h)	Up to approx. 50 mph (80 km/h)	No reaction
Vehicles with Driving Assistance Package	Up to approx. 155 mph (250 km/h)	Up to approx. 62 mph (100 km/h)	Up to approx. 43 mph (70 km/h)	Up to approx. 50 mph (80 km/h)	Up to approx. 43 mph (70 km/h)	Up to approx. 43 mph (70 km/h)	Up to approx. 50 mph (80 km/h)	Up to approx. 43 mph (70 km/h)

The autonomous braking function may intervene at speeds starting from approximately 4 mph (7 km/h) in the following situations:

	Vehicles traveling in front	Stationary vehicles	Crossing vehicles	Moving pedestrians	Stationary pedestrians	Crossing cyclists	Cyclists traveling in front	Stationary cyclists
Vehicles without Driving Assistance Package	Up to approx. 124 mph (200 km/h)	Up to approx. 31 mph (50 km/h)	No reaction	Up to approx. 37 mph (60 km/h)	No reaction	Up to approx. 37 mph (60 km/h)	Up to approx. 50 mph (80 km/h)	No reaction
Vehicles with Driving Assistance Package	Up to approx. 155 mph (250 km/h)	Up to approx. 62 mph (100 km/h)	Up to approx. 43 mph (70 km/h)	Up to approx. 43 mph (70 km/h)	Up to approx. 43 mph (70 km/h)	Up to approx. 43 mph (70 km/h)	Up to approx. 50 mph (80 km/h)	Up to approx. 43 mph (70 km/h)

Situation-dependent braking assistance may intervene at speeds starting from approximately 4 mph (7 km/h) in the following situations:

	Vehicles traveling in front	Stationary vehicles	Crossing vehicles	Moving pedestrians	Stationary pedestrians	Crossing cyclists	Cyclists traveling in front	Stationary cyclists
Vehicles without Driving Assistance Package	Up to approx. 155 mph (250 km/h)	Up to approx. 50 mph (80 km/h)	No reaction	Up to approx. 37 mph (60 km/h)	No reaction	Up to approx. 37 mph (60 km/h)	Up to approx. 50 mph (80 km/h)	No reaction
Vehicles with Driving Assistance Package	Up to approx. 155 mph (250 km/h)	Up to approx. 62 mph (100 km/h)	Up to approx. 43 mph (70 km/h)	Up to approx. 43 mph (70 km/h)	Up to approx. 43 mph (70 km/h)	Up to approx. 43 mph (70 km/h)	Up to approx. 50 mph (80 km/h)	Up to approx. 43 mph (70 km/h)

### Canceling a brake application of Active Brake Assist

You can cancel a brake application of Active Brake Assist at any time by:

- Fully depressing the accelerator pedal or with kickdown.
- Releasing the brake pedal.

Active Brake Assist may cancel the brake application when one of the following conditions is fulfilled:

- You maneuver to avoid the obstacle.
- There is no longer a risk of collision.
- An obstacle is no longer detected in front of your vehicle.

### Evasive Steering Assist (only vehicles with Driving Assistance Package)

Evasive Steering Assist has the following characteristics:

- The ability to detect stationary or moving pedestrians.
- Assistance through power-assisted steering if it detects a swerving maneuver.

- Activation by an abrupt steering movement during a swerving maneuver.
- Assistance during swerving and straightening of the vehicle.
- Reaction from a speed of approximately 12 mph (20 km/h) up to a speed of approximately 43 mph (70 km/h).

You can prevent the assistance at any time by actively steering.

**⚠ WARNING** Risk of an accident despite Evasive Steering Assist

Evasive Steering Assist cannot always clearly identify objects and complex traffic situations.

In addition, the steering support of Evasive Steering Assist is generally not sufficient to avoid a collision.

In such cases Evasive Steering Assist can:

- give an unnecessary warning or provide assistance

- not give a warning or not provide assistance
- ▶ Always pay careful attention to the traffic situation; do not rely on Evasive Steering Assist alone.
- ▶ Be ready to brake and take evasive action if necessary.
- ▶ Prevent the assistance by actively steering in non-critical driving situations.
- ▶ Drive at an appropriate speed if pedestrians are close to the path of your vehicle.

#### System limits

Full system performance is not available for a few seconds after switching on the ignition or after driving off.

The system may be impaired or may not function in the following situations:

- In snow, rain, fog, heavy spray, if there is glare, in direct sunlight or in greatly varying ambient light.

- If the sensors are dirty, fogged up, damaged or covered.
- If the sensors are impaired due to interference from other radar sources, e.g. strong radar reflections in parking garages.
- If a loss of tire pressure or a defective tire has been detected and displayed.
- In complex traffic situations where objects cannot always be clearly identified.
- If pedestrians or vehicles move quickly into the sensor detection range.
- If pedestrians are hidden by other objects.
- If the typical outline of a pedestrian cannot be distinguished from the background.
- If a pedestrian is not detected as such, e.g. due to special clothing or other objects.
- On bends with a tight radius.

#### Setting Active Brake Assist

##### Requirements:

- The ignition is switched on.

Multimedia system:

→  ▶ Settings ▶ Assistance  
▶ Active Brake Assist

The following settings are available:

- Early
- Medium
- Late



▶ Select a setting.  
The setting is retained when the engine is next started.

### Deactivating Active Brake Assist

 It is recommended that you always leave Active Brake Assist activated.

▶ Select **Off**.  
The distance warning function, the autonomous braking function and the Evasive Steering Assist are deactivated.

When the vehicle is next started, the middle setting is automatically selected.

 If Active Brake Assist is deactivated, the  symbol appears in the status bar of the multifunction display.

### Function of Adaptive Brake Lights

Adaptive Brake Lights warn following traffic in an emergency braking situation with the following actions:

- By flashing the brake lamps
- By activating the hazard warning lights

If the vehicle is braked sharply from speeds above 31 mph (50 km/h), the brake lamps flash rapidly. This provides traffic traveling behind you with an even more noticeable warning.

If the vehicle is traveling at speeds of more than 43 mph (70 km/h) at the beginning of the brake application, the hazard warning lights switch on once the vehicle is stationary. When you pull away again, the hazard warning lights will switch off automatically at approximately 6 mph (10 km/h). You can also switch off the hazard warning lights using the hazard warning button.

### Speed control cruise control

#### Function of cruise control

Cruise control regulates the speed to the value selected by the driver.

If you accelerate to overtake, for example, the stored speed is not deleted. If you remove your foot from the accelerator pedal after overtaking, cruise control will resume speed regulation back to the stored speed.

Cruise control is operated using the corresponding steering wheel buttons. You can store any speed above 15 mph (20 km/h) up to the maximum speed.

If you fail to adapt your driving style, cruise control can neither reduce the risk of an accident nor override the laws of physics. It cannot take into account road, weather or traffic conditions. Cruise control is only an aid. The driver is responsible for the distance to the vehicle in front, for vehicle speed, for braking in good time and for staying in lane.

#### Displays on the multifunction display

The status of cruise control and the stored speed are shown in the multifunction display.



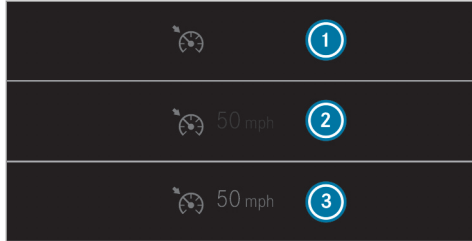

- ① Cruise control is selected
  - ② Speed is saved, cruise control is deactivated
  - ③ Speed is saved, cruise control is activated
- ⓘ The segments between the stored speed and the end of the segment display light up in the speedometer.

### System limits

Cruise control may be unable to maintain the stored speed on uphill gradients. The stored speed is resumed when the gradient evens out.

Change into a lower gear in good time on long and steep downhill gradients. Take particular note of this when driving a laden vehicle. By

doing so, you will make use of the engine's braking effect. This relieves the load on the brake system and prevents the brakes from overheating and wearing too quickly.

Do not use cruise control in the following situations:

- In traffic situations which require frequent changes of speed, e.g. in heavy traffic, on winding roads.
- On slippery roads. Accelerating can cause the drive wheels to lose traction and the vehicle could then skid.
- If you are driving when visibility is poor.

### Operating cruise control

**⚠ WARNING** Risk of accident due to stored speed

If you call up the stored speed and this is lower than your current speed, the vehicle decelerates.

- ▶ Take into account the traffic situation before calling up the stored speed.

### Requirements:

- ESP<sup>®</sup> must be activated, but not intervening.
- The driven speed is at least 15 mph (20 km/h).
- The transmission is in position **D**.

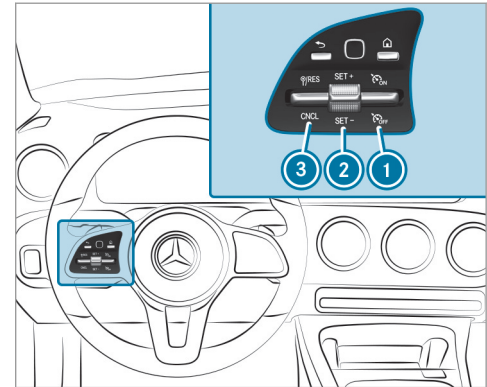

- ▶ **To activate cruise control:** press rocker switch ① up.

▶ **To activate cruise control:** press rocker switch ② up (SET+) or down (SET-). The current speed is stored and maintained by the vehicle.

or

▶ Press rocker switch ③ up (RES). The last stored speed is called up and maintained by the vehicle.

If the last stored speed has previously been deleted, the currently driven speed is stored.

① When you switch off the vehicle, the last speed stored is cleared.

▶ **To increase/reduce speed:** press rocker switch ② up (SET+) or down (SET-) to the pressure point. The stored speed is increased or reduced by 1 mph (1 km/h).

or

▶ Press rocker switch ② up (SET+) or down (SET-) beyond the pressure point. The stored speed is increased or reduced by 5 mph (10 km/h).

or

▶ Accelerate the vehicle to the desired speed.

▶ Press rocker switch ② up (SET+). If cruise control is activated and Traffic Sign Assist has detected a speed restriction sign with a maximum permissible speed and this is displayed in the instrument cluster, you can choose between the following options:

▶ **To adopt the detected speed:** press rocker switch ③ up (RES). The maximum permissible speed shown by the traffic sign is stored and the vehicle maintains this speed.

▶ **To deactivate cruise control:** press rocker switch ③ down (CNCL).

▶ **To switch off cruise control:** press rocker switch ① down.

① If you brake, deactivate ESP® or if ESP® intervenes, cruise control is deactivated.

## Active Distance Assist DISTRONIC

### Function of Active Distance Assist DISTRONIC

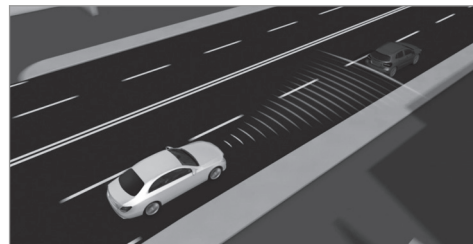

Active Distance Assist DISTRONIC maintains the set speed on free-flowing roads. If vehicles in front are detected, the set distance is maintained, if necessary, until the vehicle comes to a halt. The vehicle accelerates or brakes depending on the distance to the vehicle in front and the set speed. The speed and distance to the vehicle in front are set and saved on the steering wheel on vehicles without the Driving Assistance Package, in the range between 15 mph (20 km/h) and 120 mph (200 km/h) and, on

vehicles with the Driving Assistance Package, in the range between 15 mph (20 km/h) and 130 mph (210 km/h).

Other features of Active Distance Assist DISTRONIC:

- Adjusts the driving style depending on the selected drive program (fuel-saving, comfortable or dynamic) (→ page 137)
- **Vehicles with Driving Assistance Package:** reacts to stationary vehicles detected in urban speed ranges (except bicycles and motorcycles).
- Initiates acceleration to the stored speed if the turn signal indicator is switched on to change to the overtaking lane.
- **Vehicles with Driving Assistance Package:** takes one-sided overtaking restrictions into account on highways or on multi-lane roads with separate roadways (country-dependent).

Active Distance Assist DISTRONIC is only an aid. The driver is responsible for keeping a safe dis-

tance to the vehicle in front, for vehicle speed and for braking in good time.

#### System limits

The system may be impaired or may not function in the following situations:

- In snow, rain, fog, heavy spray, if there is glare, in direct sunlight or in greatly varying ambient light.
- The windshield in the area of the camera is dirty, fogged up, damaged or covered.
- If the radar sensors are dirty or covered.
- In parking garages or on roads with steep uphill or downhill gradients.
- If there are narrow vehicles in front, such as bicycles or motorcycles.

In addition, on slippery roads, braking or accelerating can cause one or several wheels to lose traction and the vehicle could then skid.

Do not use Active Distance Assist DISTRONIC in these situations.

**⚠ WARNING** Risk of accident from acceleration or braking by Active Distance Assist DISTRONIC

Active Distance Assist DISTRONIC may accelerate or brake in the following cases, for example:

- If the vehicle pulls away using Active Distance Assist DISTRONIC.
  - If the stored speed is called up and is considerably faster or slower than the currently driven speed.
  - If Active Distance Assist DISTRONIC no longer detects a vehicle in front or does not react to relevant objects.
- ▶ Always carefully observe the traffic conditions and be ready to brake at all times.
- ▶ Take into account the traffic situation before calling up the stored speed.

**⚠ WARNING** Risk of accident due to insufficient deceleration by Active Distance Assist DISTRONIC

Active Distance Assist DISTRONIC brakes your vehicle with up to 50% of the maximum possible deceleration. If this deceleration is not sufficient, Active Distance Assist DISTRONIC alerts you with a visual and acoustic warning.

- ▶ In these cases, adjust your speed and keep a sufficient distance.
- ▶ Brake the vehicle yourself and/or take evasive action.

**⚠ WARNING** Risk of accident if detection function of Active Distance Assist DISTRONIC is impaired

Active Distance Assist DISTRONIC does not react or has a limited reaction:

- when driving on a different lane or when changing lanes

- to pedestrians, animals, bicycles or stationary vehicles, or unexpected obstacles
- to complex traffic conditions
- to oncoming vehicles and crossing traffic

As a result, Active Distance Assist DISTRONIC may neither give warnings nor intervene in such situations.

- ▶ Always observe the traffic conditions carefully and react accordingly.

### Operating Active Distance Assist DISTRONIC

#### Requirements:

- The vehicle has been started.
- The electric parking brake is released.
- ESP® is activated and is not intervening.
- The transmission is in position **D**.
- All the doors are closed.
- Check of the radar sensor system has been successfully completed (vehicle traveling faster than 12 mph (20 km/h)).

- Parking Assist PARKTRONIC is not being used to park the vehicle or to exit from a parking space.
- The vehicle does not skid.

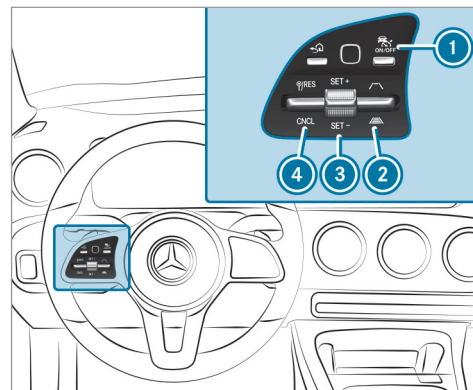

▶ **To activate/deactivate Active Distance Assist DISTRONIC:** press button ①.

▶ **To activate Active Distance Assist DISTRONIC:** press rocker switch ③ up (SET)

+) or down (SET-), or press rocker switch ④ up (RES). Remove your foot from the accelerator pedal.  
The current speed is stored and maintained by the vehicle.

or

▶ **To activate Active Distance Assist DISTRONIC with a stored speed:** press rocker switch ④ up (RES). Remove your foot from the accelerator pedal.

ⓘ If rocker switch ④ is pressed up (RES) again after activation with a stored speed, Active Distance Assist DISTRONIC is activated with the speed restriction displayed in the instrument cluster.

▶ **To accept the displayed speed restriction when Active Distance Assist DISTRONIC is active:** press rocker switch ④ up (RES). The speed limit displayed in the instrument cluster is adopted as the stored speed. The vehicle adapts its speed to that of the vehicle in front, but only up to the stored speed.

▶ **To pull away with Active Distance Assist DISTRONIC:** remove your foot from the

brake pedal and activate Active Distance Assist DISTRONIC.

▶ Press rocker switch ④ up (RES).

or

▶ Depress the accelerator pedal briefly and firmly.  
The functions of Active Distance Assist DISTRONIC continue to be carried out.

**⚠ WARNING** Risk of accident due to Active Distance Assist DISTRONIC still being activated when you leave the driver's seat

If you leave the driver's seat while the vehicle is being braked by Active Distance Assist DISTRONIC only, the vehicle can roll away.

▶ Always deactivate Active Distance Assist DISTRONIC and secure the vehicle to prevent it from rolling away before you leave the driver's seat.

▶ **To deactivate Active Distance Assist DISTRONIC:** press rocker switch ④ down (CNCL).

▶ **To increase/reduce speed:** press rocker switch ③ up (SET+) or down (SET-) to the pressure point.  
The stored speed is increased or reduced by 1 mph (1 km/h).

or

▶ Press and hold rocker switch ③ up (SET+) or down (SET-) to the pressure point.  
The stored speed is increased or reduced in increments of 1 mph (1 km/h).

or

▶ Press rocker switch ③ up (SET+) or down (SET-) beyond the pressure point.  
The stored speed is increased or reduced by 5 mph (10 km/h).

or

▶ Press and hold rocker switch ③ up (SET+) or down (SET-) beyond the pressure point.  
The stored speed is increased or reduced in increments of 5 mph (10 km/h).

▶ **To increase or reduce the specified distance from the vehicle in front:** press rocker switch ② up or down.

### Function of Active Speed Limit Assist

- ① The following function is country-dependent and only available in conjunction with the Driving Assistance Package.

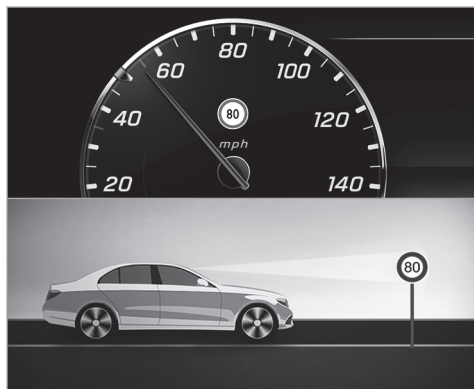

If a change in the speed limit is detected and Active Distance Assist DISTRONIC is activated, Active Distance Assist DISTRONIC adapts this new speed as the stored speed.

The driven speed is adjusted when the vehicle is level with the traffic sign at the latest. In the case of signs indicating entry into an urban area, the speed is adapted according to the speed permitted within the urban area. The speed limit display in the Instrument Display is always updated when the vehicle is level with the traffic sign.

If there is no speed restriction on an unlimited stretch of road (e.g. on a freeway), the recommended speed is automatically adopted as the stored speed. The system uses the speed stored on an unlimited stretch of road as the recommended speed. If you do not alter the stored speed on an unlimited stretch of road, the recommended speed is 80 mph (130 km/h).

If Active Distance Assist DISTRONIC has been put into passive mode by pressing the accelerator pedal, only speed limits which are higher than the set speed are adopted.

Active Speed Limit Assist is only an aid. The driver is responsible for keeping a safe distance to the vehicle in front, for vehicle speed and for braking in good time. The maximum permissible speed also depends on factors such as the road surface and traffic conditions.

### System limits

Temporary speed restrictions (e.g. for a certain time or due to weather conditions) cannot be properly detected by the system. The maximum permissible speed applying to a vehicle with a trailer is not detected by the system. In these situations you must adjust your speed yourself.

**⚠ WARNING** Risk of accident due to Active Speed Limit Assist adapting the vehicle's speed

The speed adopted by Active Speed Limit Assist may be too high or incorrect in some individual cases, such as:

- In the wet or in fog
  - When towing a trailer
- ▶ Ensure that the driven speed complies with traffic regulations.
- ▶ Adjust the driving speed to suit current traffic and weather conditions.

## Active Steering Assist

### Function of Active Steering Assist



**i** The following function is country-dependent and only available in conjunction with the Driving Assistance Package.

Active Steering Assist is only available up to a speed of 130 mph (210 km/h). The system helps you to stay in the center of the lane by means of moderate steering interventions. Depending on the speed driven, Active Steering Assist uses the vehicles ahead and lane markings as a reference.

**i** Depending on the country, in the lower speed range Active Steering Assist can use the surrounding traffic as a reference. If necessary, Active Steering Assist can then also provide assistance with a driving style outside the center of the lane.

When the system is actively steering, the  symbol is shown in green in the multifunction display.

If the detection of lane markings and vehicles ahead is impaired, Active Steering Assist switches to passive mode. The system provides

no support in this case. During the transition from active to passive status, the  symbol is shown as enlarged and flashing. Once the system is passive, the  symbol is shown as grey in the multifunction display.

### Steering and touch detection

The driver is required to keep their hands on the steering wheel at all times and be able to intervene at any time to correct the course of the vehicle and keep it in lane. The driver must expect a change from active to passive mode or vice versa at any time.

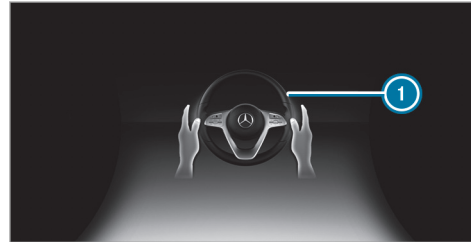

If the driver has not steered the vehicle for a considerable period of time or has removed their

hands from the steering wheel, an optical warning is given first. Display **1** appears in the multifunction display. If the driver still does not steer the vehicle, or gives no confirmation to the system, a warning tone sounds in addition to the visual warning message.

The warning is not issued, or is stopped, when the driver gives confirmation to the system:

- The driver steers the vehicle.
- The driver presses a steering wheel button or operates Touch Control.

If Active Steering Assist detects that a system limit has been reached, a visual and acoustic warning is issued.

Active Steering Assist is only an aid. The driver is responsible for the distance to the vehicle in front, for vehicle speed, for braking in good time and for staying in lane. Before changing lanes, the driver must make sure that the neighboring lane is free (glance over the shoulder).

### System limits

Active Steering Assist has a limited steering torque for lateral guidance. In some cases, the

steering intervention is not sufficient to keep the vehicle in the lane or to drive through exits.

The system may be impaired or may not function in the following instances:

- There is poor visibility, e.g. due to snow, rain, fog, heavy spray, greatly varying ambient light or strong shadows on the roadway.
- There is glare, e.g. from oncoming traffic, direct sunlight or reflections.
- Insufficient road illumination.
- The windshield is dirty, fogged up, damaged or covered in the vicinity of the camera, e.g. by a sticker.
- No, or several, unclear lane markings are present for one lane, or the markings change quickly, e.g. in a construction area or intersections.
- The lane markings are worn away, dark or covered up, e.g. by dirt or snow.
- The distance to the vehicle in front is too small and the lane markings thus cannot be detected.
- The road is narrow and winding.

- There are obstacles on the lane or projecting out into the lane, such as object markers.

The system does not provide assistance in the following conditions:

- On tight bends and when turning.
- When crossing intersections.
- At traffic circles or toll stations.
- When actively changing lane without switching on the turn signal indicator.
- When the tire pressure is too low.

Depending on the selected vehicle settings, Active Steering Assist may be unavailable. Observe the status display of Active Steering Assist in the multifunction display (→ page 177).

**⚠ WARNING** Risk of accident if Active Steering Assist unexpectedly stops functioning

If the system limitations of Active Steering Assist are reached there is no guarantee that

the system will remain active or will keep the vehicle in lane.

- ▶ Always keep your hands on the steering wheel and observe the traffic carefully.
- ▶ Always steer the vehicle paying attention to traffic conditions.

**⚠ WARNING** Risk of accident if Active Steering Assist unexpectedly intervenes

A malfunction in the detection of lane markings and objects can occur.

This could cause unexpected steering intervention.

- ▶ Steer according to traffic conditions.



### Activating/deactivating Active Steering Assist

#### Requirements:

- ESP® is activated, but is not intervening.
- Active Distance Assist DISTRONIC is activated.



Multimedia system:

- ➔  ➔ Settings
- ➔ Schnellzugriff (Quick access)
- ▶ Select  Steering Assist.

### Function of Active Emergency Stop Assist

If the driver continually ignores the visual or acoustic warning to put their hands on the steering wheel, the **Beginning Emergency Stop** message appears in the multifunction display. If the driver still does not respond, Active Distance Assist DISTRONIC reduces the speed. The vehicle is decelerated in stages to a standstill.

Depending on the country, at speeds below 40 mph (60 km/h) the hazard warning lights switch on automatically.

When the vehicle is stationary, the following actions are carried out:

- The vehicle is secured with the electric parking brake
  - Active Distance Assist DISTRONIC is ended
  - The vehicle is unlocked
- if possible, an emergency call is placed to the Mercedes-Benz emergency call center

The driver can cancel the deceleration at any time by performing one of the following actions:

- Steering
- Braking or accelerating
- Pressing a steering-wheel button
- Operating Touch Control
- Activating or deactivating Active Distance Assist DISTRONIC

### Overview of Active Distance Assist DISTRONIC displays in the instrument cluster

The assistance graphic and the status display show the status of the following functions in the instrument cluster:

- Active Distance Assist DISTRONIC
- Route-based speed adaptation
- Active Steering Assist

### Assistance graphic

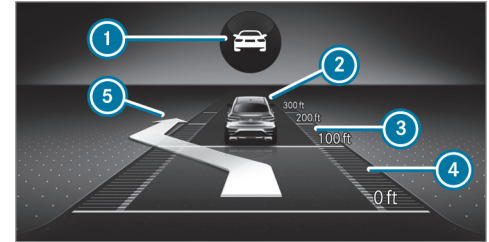

- ① Route-based speed adaptation (type of route event)
- ② Vehicle in front
- ③ Distance indicator
- ④ Set specified distance
- ⑤ Active Lane Change Assist lane change display

### Active Distance Assist DISTRONIC status display and route-based speed adaptation

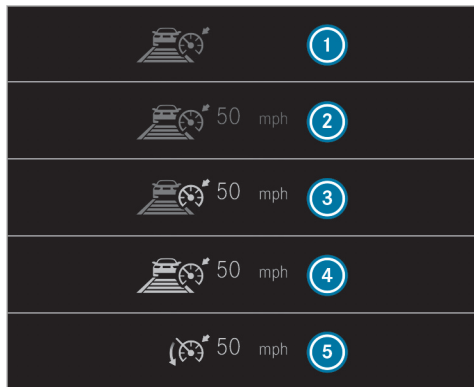

- ① Active Distance Assist DISTRONIC selected, set specified distance (number of segments below the vehicle)
- ② Active Distance Assist DISTRONIC deactivated, speed stored

- ③ Active Distance Assist DISTRONIC active, speed stored, no vehicle detected (bright vehicle symbol)
  - ④ Active Distance Assist DISTRONIC active, speed stored, vehicle detected (green vehicle symbol)
  - ⑤ Active Distance Assist DISTRONIC and route-based speed adaptation active, speed stored
- ⓘ On highways or high-speed major roads, the green vehicle symbol is displayed cyclically when the vehicle is ready to pull away.
- ⓘ If you depress the accelerator pedal beyond the setting of the Active Distance Assist DISTRONIC, the system is switched to passive mode. The **Suspended** message appears in the multifunction display.

### Speedometer

The stored speed is highlighted on the speedometer. If the speed of the vehicle in front or the speed adjustment is less than the stored speed due to the route event ahead, the segments in the speedometer light up. Deactivation of Active Distance Assist DISTRONIC, as well as alterations to the speed due to manual or automatic

adoption of the speed limit, are displayed in the control feedback of the multifunction display on a single line.

### Active Steering Assist status display

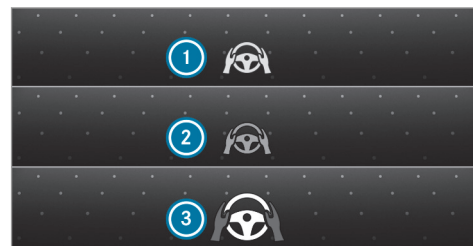



- ① Gray steering wheel: Active Steering Assist switched on and passive
- ② Green steering wheel: Active Steering Assist switched on and active
- ③ Flashing steering wheel: prompt to the driver to actively confirm or transition from active to passive status, system limits detected

During the transition from active to passive status, symbol ③ is shown as enlarged and flash-

ing. Once the system is passive, symbol  is shown in gray in the multifunction display.

### Function of Hill Start Assist

Hill Start Assist holds the vehicle for a short time when pulling away on a hill under the following conditions:

- **Vehicles with automatic transmission:**  
The transmission is in position  or .
- The electric parking brake is released.

This gives you enough time to move your foot from the brake pedal to the accelerator pedal and depress it before the vehicle begins to roll away.

 **WARNING** Risk of accident and injury due to the vehicle rolling away

After a short time, Hill Start Assist no longer holds the vehicle and it can roll away.

- ▶ Therefore, swiftly move your foot from the brake pedal to the accelerator

 pedal. Never attempt to leave the vehicle if it is being held by Hill Start Assist.

### HOLD function

#### HOLD function

The HOLD function holds the vehicle at a standstill without requiring you to depress the brake pedal, e.g. while waiting in traffic.

The HOLD function is only an aid. The responsibility for the vehicle safely standing still remains with the driver.

#### System limitations

The HOLD function is only intended to provide assistance when driving and is not a sufficient means of safeguarding the vehicle against rolling away when stationary.

- The incline must not be greater than 30%.

### Activating/deactivating the HOLD function

 **WARNING** Risk of an accident due to the HOLD function being activated when you leave the vehicle

If you leave the vehicle while only the HOLD function is braking the vehicle, the vehicle can roll away in the following situations:

- If there is a malfunction in the system or in the power supply.
  - If the HOLD function is deactivated by depressing the accelerator pedal or brake pedal, e.g. by a vehicle occupant.
- ▶ Always deactivate the HOLD function and secure the vehicle against rolling away before leaving the vehicle.

**NOTE** Damage from automatic braking

If one of the following functions is switched on, the vehicle brakes automatically in certain situations:

- Active Brake Assist
- Active Distance Assist DISTRONIC
- HOLD function
- Active Parking Assist

To avoid damage to the vehicle, deactivate these systems in the following or similar situations:

- ▶ During towing
- ▶ In a car wash

**Requirements:**

- The vehicle is stationary.
- The driver's door is closed or the seat belt on the driver's side is fastened.
- The engine is running or has been automatically switched off by the ECO start/stop function.

- The electric parking brake is released.
- Active Distance Assist DISTRONIC is deactivated.
- The transmission is in position **D**, **R** or **N**.

**Activating the HOLD function**

- ▶ Depress the brake pedal and after a short time quickly depress further until the **HOLD** display appears in the multifunction display.
- ▶ Release the brake pedal.

**Deactivating the HOLD function**

- ▶ Depress the accelerator pedal to pull away.
- or
- ▶ Depress the brake pedal until the **HOLD** display disappears from the multifunction display.

The HOLD function is deactivated in the following situations:

- Active Distance Assist DISTRONIC is activated.
- The transmission is switched to position **P**.

- The vehicle is secured with the electric parking brake.

In the following situations, the vehicle is held by the transmission position **P** or by the electric parking brake:

- The seat belt is unfastened and the driver's door is opened.
- The vehicle is switched off.
- There is a malfunction in the system or the power supply is insufficient.

**Start-off assist****Function of the start-off assist**

The start-off assist enables optimal vehicle acceleration from a standstill. For this, a suitably high-grip road surface is required, the tires and vehicle must also be in good condition.

Do not activate the start-off assist on public roads.

Be sure to observe the safety notes and information on ESP®.

### Activating the start-off assist

**⚠ WARNING** Risk of skidding and having an accident from wheels spinning

When you use start-off assist, individual wheels could spin and you could lose control of the vehicle.

If ESP® is deactivated, there is a risk of skidding and accident!

- ▶ Make sure that no persons or obstacles are in the close vicinity of your vehicle.

- ▶ Deactivate ESP® (→ page 161).
- ▶ Move the steering wheel to the straight-ahead position.
- ▶ Depress the brake pedal firmly with your left foot and keep it depressed.
- ▶ Engage the **D** drive position (→ page 142).
- ▶ Select the sportiest available drive program **S<sup>+</sup>** or **S** (→ page 138).
- ▶ Rapidly depress the accelerator pedal fully.

- ▶ Take your foot off the brake, but keep the accelerator pedal depressed. The vehicle pulls away at maximum acceleration.
- ▶ Switch on ESP® once the acceleration procedure is complete. ESP® will otherwise not be able to stabilize the vehicle if the vehicle starts to skid or a wheel starts to spin.

### Canceling start-off assist

- ▶ Remove your foot from the accelerator pedal.
- ▶ Reactivate the ESP®.

### Function of adaptive damping adjustment

Suspension with adaptive damping adjustment continuously adjusts the characteristics of the suspension dampers to the current operating and driving conditions.

The damping is tuned individually for each wheel and is affected by the following factors:

- The road surface conditions
- Vehicle load
- The drive program selected

- The driving style

The drive program can be adjusted using the DYNAMIC SELECT switch.

### Parking Assist PARKTRONIC

#### Function of Parking Assist PARKTRONIC

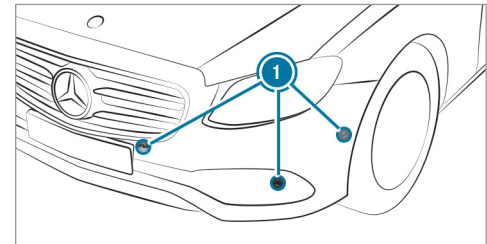

Parking Assist PARKTRONIC is an electronic parking assistance system with ultrasound. It monitors the area around your vehicle using multiple sensors ① on the front bumper and on the rear bumper. Parking Assist PARKTRONIC shows you the distance between your vehicle and a detected obstacle visually and audibly.

Parking Assist PARKTRONIC is only an aid. It is not a substitute for your attention to the surroundings. The responsibility for safe maneuvering and parking remains with you. Make sure that there are no persons, animals or objects in the maneuvering area while maneuvering and parking in/exiting parking spaces.

In the standard setting, an intermittent warning tone sounds from a distance of approximately 1.0 ft (0.3 m) to an obstacle in front and approximately 3.3 ft (1.0 m) to an obstacle behind. A continuous tone sounds from a distance of approximately 0.7 ft (0.2 m). Using the **Warn Early All Around** setting in the multimedia system, the warning tones for front and side impact protection can be set to sound at a greater distance of approximately 3.3 ft (1.0 m) in front and 2.0 ft (0.6 m) on the sides (→ page 186).

**i** The **Warn Early All Around** setting is always active at the rear of the vehicle.

If Parking Assist PARKTRONIC is deactivated, Active Parking Assist is unavailable.

### Parking Assist PARKTRONIC display in the multimedia system

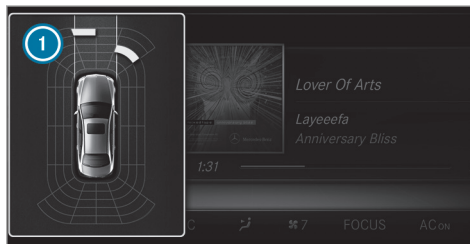

Vehicles with Active Parking Assist without a 360° Camera

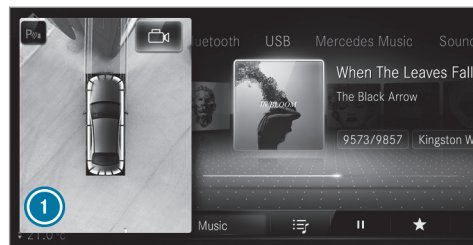

Vehicles with Active Parking Assist and a 360° Camera

If Active Parking Assist is deactivated and an obstacle is detected in the path of the vehicle, a pop-up window for Parking Assist PARKTRONIC **1** appears in the multimedia system at speeds below 6 mph (10 km/h).

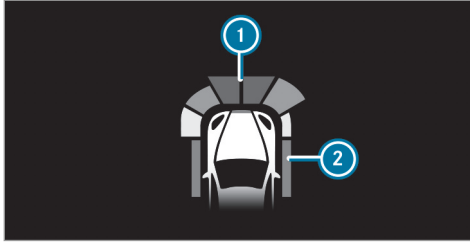

Display of Active Parking Assist PARKTRONIC in the head-up display

Optionally, obstacles detected by Active Parking Assist PARKTRONIC from a distance of approximately 3.3 ft (1.0 m) in front ① and 2.0 ft (0.6 m) on the sides ② can also be displayed in the head-up display.

#### System limits

Parking Assist PARKTRONIC does not necessarily take into account the following obstacles:

- Obstacles below the detection range, e.g. persons, animals or objects.

- Obstacles above the detection range, e.g. overhanging loads, overhangs or loading ramps of trucks.

The sensors must be free of dirt, ice and slush. Otherwise, they may not function correctly. Clean the sensors regularly, taking care not to scratch or damage them.

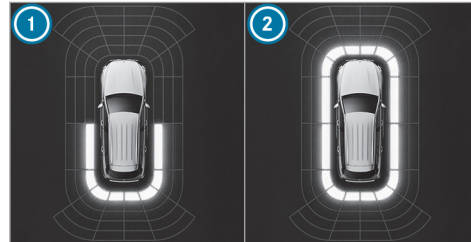

#### Problems with Parking Assist PARKTRONIC

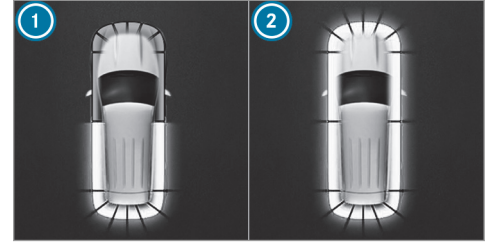

Vehicles without 360° Camera



Vehicles with 360° Camera

Problem	Possible causes/consequences and ► Solutions
Rear segments ① or all-round segments ② light up red. The  symbol appears in the multifunction display.	Parking Assist PARKTRONIC is malfunctioning and has been deactivated due to signal interference. <ul style="list-style-type: none"> <li>► Start the vehicle again.</li> <li>► Check if Parking Assist PARKTRONIC is working at a different location.</li> </ul>
Rear segments ① or all-round segments ② light up red. At the same time, a warning tone sounds for approximately 2 seconds every time the vehicle is started. The  symbol appears in the multifunction display.	The sensors are dirty. <ul style="list-style-type: none"> <li>► Clean the sensors and observe the notes on care of vehicle parts (→ page 391).</li> </ul> Parking Assist PARKTRONIC has been deactivated due to a malfunction. <ul style="list-style-type: none"> <li>► Start the vehicle again.</li> <li>► If the problem persists, consult a qualified specialist workshop.</li> </ul>

### Function of the passive side impact protection

Passive side impact protection is an additional Parking Assist PARKTRONIC function which warns the driver about obstacles at the side of the vehicle. A warning is issued when obstacles are detected between the front and rear detection range. In order for an object on the side to be detected, the sensors in the front and rear bumper must first detect the object while you are driving past it.

During the parking procedure or maneuvering, objects are detected as the vehicle drives past. If you steer in the direction of a detected obstacle and there is a risk of a lateral collision, a warning is issued. The segments on the sides light up yellow or red, depending on the distance to the obstacle.

### Segment color depending on distance

Color	Lateral distance
Yellow	Approx. 1.0 - 2.0 ft (30 - 60 cm)
Red	Approx. < 1.0 ft (30 cm)

In order for lateral front or rear segments to be displayed, the vehicle must first travel a distance



of at least half of the vehicle length. Once the vehicle has traveled the length of the vehicle, all of the lateral front and rear segments can be displayed.

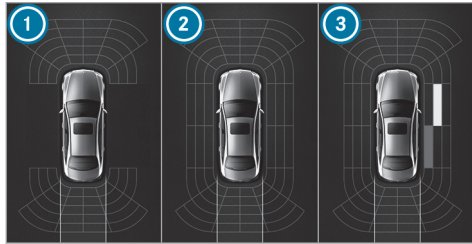

Vehicles without 360° Camera

- ① Parking Assist PARKTRONIC is only operational at the front and rear
- ② Parking Assist PARKTRONIC is operational and can also warn the driver about obstacles at the side of the vehicle
- ③ Obstacle detected at the front right (yellow) and rear (red)

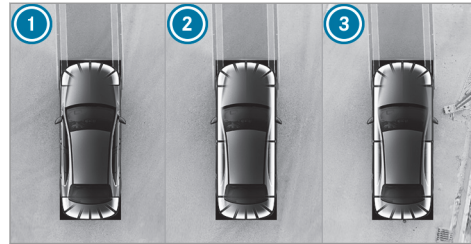

Vehicles with 360° Camera

- ① Parking Assist PARKTRONIC is only operational at the front and rear
- ② Parking Assist PARKTRONIC is operational and can also warn the driver about obstacles at the side of the vehicle
- ③ Obstacle detected at the front right (red)

Saved obstacles on the sides are deleted in the following situations, for example:

- You park the vehicle and switch off the ignition.
- You open the doors.

After the engine is restarted, obstacles must be detected again before a new warning can be issued.

### System limits

The system limits for Parking Assist PARKTRONIC apply for passive side impact protection.

The following objects are not detected, for example:

- Pedestrians who approach the vehicle from the side
- Objects placed next to the vehicle

### Activating/deactivating Parking Assist PARKTRONIC

**!** **NOTE** Risk of an accident from objects at close range

Parking Assist PARKTRONIC may not detect certain objects at close range.

- ▶ When parking or maneuvering the vehicle, pay particular attention to any objects which are above or below the sensors, e.g. flower pots or drawbars.

The vehicle or other objects could otherwise be damaged.

If the  symbol is shown in the multifunction display, Parking Assist PARKTRONIC is not active.

Multimedia system:

→ [Settings](#) → [Quick Access](#)  
→ [PARKTRONIC](#)

- ▶ Activate or deactivate the function.
- ⓘ Parking Assist PARKTRONIC is automatically activated when the vehicle is started.

### Adjusting the warning tones of Parking Assist PARKTRONIC

Multimedia system:

→  → [Settings](#) → [Assistance](#)  
→ [Camera & Parking](#) → [Set Warning Tones](#)

### Adjusting the volume of the warning tones

- ▶ Select [Warning Tone Volume](#).
- ▶ Set a value.

### Adjusting the pitch of the warning tones

- ▶ Select [Warning Tone Pitch](#).
- ▶ Set a value.

### Specifying the starting point for the warning tones

You can specify whether the Parking Assist PARKTRONIC warning tones should commence when the vehicle is further away from an obstacle.

- ▶ Select [Warn Early All Around](#).
- ▶ Activate or deactivate the function.

### Activating/deactivating audio fadeout

You can specify whether the volume of a media source in the multimedia system is to be reduced when Parking Assist PARKTRONIC sounds a warning tone.

- ▶ Select [Audio Fadeout During Warning Tones](#).
- ▶ Activate or deactivate the function.

## Reversing camera

### Function of the rear view camera

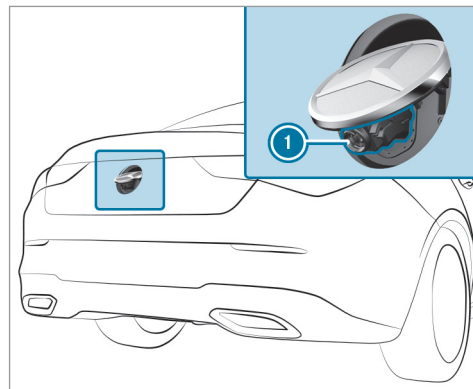

When you engage reverse gear, the image from rear view camera ① is shown in the media display. Dynamic guide lines show the path the vehicle will take with the steering wheel in its current position. This helps you to orient yourself and to avoid obstacles when backing up.

The rear view camera is only an aid. It is not a substitute for your attention to the surroundings. The responsibility for safe maneuvering and parking remains with you. Make sure that there are no persons, animals or objects etc., in the maneuvering area while maneuvering and parking.

Depending on the vehicle equipment, you can select from the following views:

- Normal view
- Wide-angle view

The area behind the vehicle is displayed as a mirror image, as in the inside rearview mirror.

#### Vehicles without Active Parking Assist

The following camera views are available in the multimedia system:

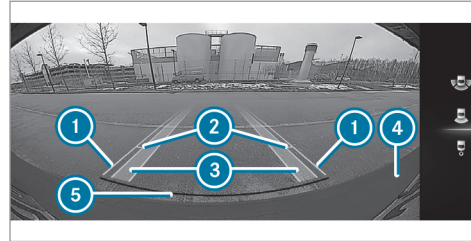

#### Normal view

- ① Yellow guide line, vehicle width (driven surface) depending on the current steering wheel angle (dynamic)
- ② Yellow guide line at a distance of approximately 3.3 ft (1.0 m) from the rear area
- ③ Yellow lane marking the course the tires will take at the current steering wheel angle (dynamic)
- ④ Bumper
- ⑤ Red guide line at a distance of approximately 1.0 in (0.3 m) from the rear area

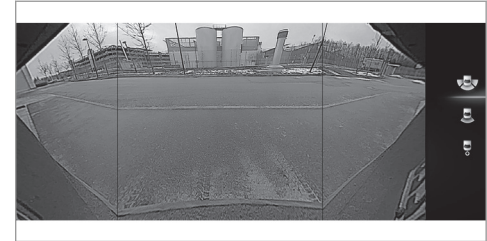

#### Wide-angle view

#### Vehicles with Active Parking Assist

The following camera views are available in the multimedia system:

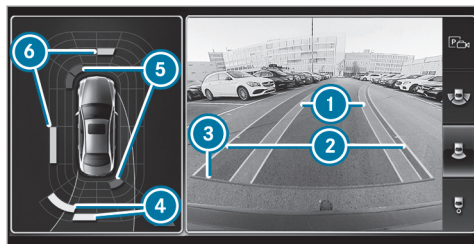

## Normal view

- ① Yellow lane marking the course the tires will take at the current steering wheel angle (dynamic)
- ② Yellow guide line, vehicle width (driven surface) depending on the current steering wheel angle (dynamic)
- ③ Red guide line at a distance of approximately 1.0 in (0.3 m) from the rear area
- ④ Yellow warning display of Parking Assist PARKTRONIC: obstacles are at a distance of between approximately 2.0 ft (0.6 m) and 3.3 ft (1.0 m)

- ⑤ Red warning display of Parking Assist PARKTRONIC: obstacles are very close (approximately 1.0 ft (0.3 m) or less)
- ④ Orange warning display of Parking Assist PARKTRONIC: obstacles are a medium distance away (between approximately 1.0 ft (0.3 m) and 2.0 ft (0.6 m))
- ⓘ If the entire system fails, the internal segments of the warning display are shown in red and the  symbol appears in the multifunction display in the instrument cluster. If the system fails at the rear, the rear segments are shown in red when backing up and are hidden when driving forwards. When Active Parking Assist is active, lane markings ① are displayed in green. If Parking Assist PARKTRONIC is deactivated, the warning display fades out.



## Wide-angle view

## System failure



If there is no operational readiness, a message appears in the multimedia system.

### System limits

The rear view camera will not function or will only partially function in the following situations:

- The trunk lid is open.
- There is heavy rain, snow or fog.
- The ambient light conditions are poor, e.g. at night.
- The camera lens is obstructed, dirty or fogged up. Observe the notes on cleaning the rear view camera (→ page 391).
- The camera or rear of your vehicle is damaged. In this case, have the camera and its position and setting checked at a qualified specialist workshop.

- i** Do not use the rear view camera in these types of situation. You could otherwise injure others or collide with objects when parking the vehicle.

The field of vision and other functions of the rear view camera may be restricted due to additional

accessories on the rear of the vehicle (e.g. license plate bracket or bicycle rack).

- i** The contrast of the display may be impaired by direct sunlight or by other light sources, e.g. when driving out of a garage. In this case, pay particular attention.
- i** Have the display repaired or replaced if, for example, pixel errors considerably restrict its use.

### 360° camera

#### Function of the 360° Camera

The 360° Camera is a system that consists of four cameras. The cameras cover the immediate vehicle surroundings. The system assists you, e.g. when parking or at exits with reduced visibility.

The 360° Camera is only an aid. It is not a substitute for your attention to the surroundings. The responsibility for safe maneuvering and parking remains with you. Make sure that there are no persons, animals or objects etc., in the maneuvering area while maneuvering and parking.

The system evaluates images from the following cameras:

- Rear view camera
- Front camera
- Two side cameras in the outside mirrors

#### Views of the 360° Camera

You can select from different views:

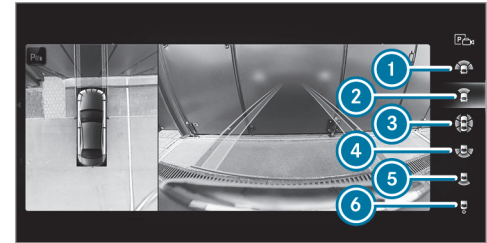

- 1** Wide-angle view, front
- 2** Top view with image from the front camera
- 3** Top view with images from the side cameras in the outside mirrors
- 4** Wide-angle view, rear

- ⑤ Top view with image from the rear view camera
- ⑥ Top view with trailer view (vehicles with a trailer hitch)

### Top view



- ① Lane indicating the route the vehicle will take at the current steering wheel angle
- ② Yellow warning display of Parking Assist PARKTRONIC: obstacles at a distance of approximately 3.3 ft (1.0 m) or less
- ③ Your vehicle from above

If the distance to the object lessens, the color of warning display ② changes:

- From approx. 3.3 ft (1.0 m): yellow
- From approx. 2.0 ft (0.6 m): orange
- From approx. 1.0 ft (0.3 m): red

When Parking Assist PARKTRONIC is operational and no object is detected, the segments of the warning display are shown in gray.

- ① If the entire system fails, the segments of the warning display are shown in red and the  symbol appears in the multifunction display in the instrument cluster.

If the system fails at the rear, the display of the segments changes as follows:

- The rear segments are shown in red when backing up.
- The rear segments are hidden when driving forwards.

If Parking Assist PARKTRONIC is deactivated, the warning display fades out.

### Guide lines

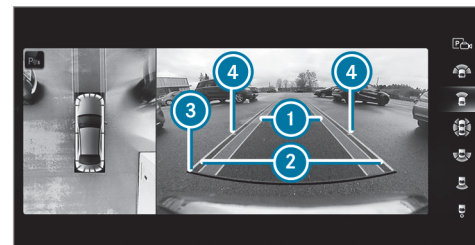

- ① Yellow lane marking the course the tires will take at the current steering wheel angle (dynamic)
- ② Yellow guide line, vehicle width (driven surface) depending on the current steering wheel angle (dynamic)
- ③ Red guide line at a distance of approximately 12 in (0.3 m) from the rear area
- ④ Mark at a distance of approx. 3.3 ft (1.0 m)
- ① When Active Parking Assist is active, lane markings ① are displayed in green.

The guide lines in the media display show the distances to your vehicle. The distances apply to road level.

### Side view of the mirror cameras

The sides of the vehicle can be seen in this view.

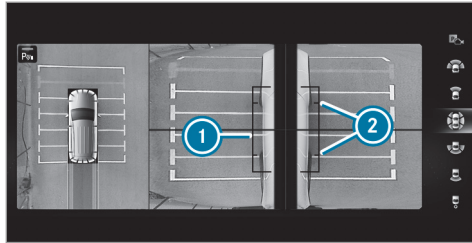

- ① Guide line of external vehicle dimensions with outside mirrors folded out
- ② Marker of the wheel contact points

### System failure

If there is no operational readiness, the following message appears in the multimedia system:

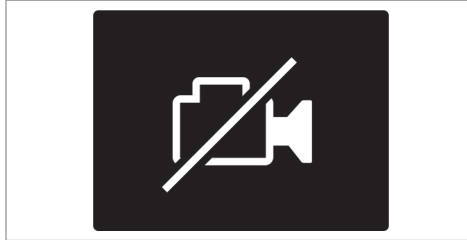

### System limits

The 360° Camera will not function or will only partially function in the following situations:

- The doors are open.
- The side mirrors are folded in.
- The trunk lid is open.
- There is heavy rain, snow or fog.
- The ambient light conditions are poor, e.g. at night.
- The camera lens is obstructed, dirty or fogged up.
- If cameras or vehicle components in which the cameras are installed are damaged. In

this event, have the cameras, their positions and their setting checked at a qualified specialist workshop.

- ① Do not use the 360° Camera under such circumstances. You could otherwise injure others or collide with objects when parking the vehicle.

If the vehicle is carrying a heavy load, leaving the standard height can result in inaccuracies in the guide lines and in the display of the generated images, depending on technical conditions.

The field of vision and other functions of the camera system may be restricted due to additional attachments on the vehicle (e.g. license plate bracket, bicycle rack).

- ① The contrast of the display may be impaired by abrupt direct sunlight or by other light sources, e.g. when driving out of a garage. In this case, pay particular attention.
- ① Have the display repaired or replaced if, for example, pixel errors considerably restrict its use.

See the notes on cleaning the 360° Camera (→ page 391).

### Selecting a view for the 360° Camera

- ▶ Engage reverse gear.
- ▶ Select the desired view in the multimedia system (→ page 189).

### Opening the camera cover of the rear view camera

Multimedia system:

→  ▶ Settings ▶ Assistance

▶ Camera & Parking

- ▶ Select **Open Camera Cover**.

 The camera cover closes automatically after some time or after an ignition cycle.

### Setting the camera as a favorite

You can call up the camera view directly in the multimedia system by setting it as a favorite.

- ▶ Press the  button on the touchpad. The main functions are displayed.
- ▶ Navigate downwards twice. The Favorites menu appears.
- ▶ Select **New Favorite**.
- ▶ Select **Vehicle**.
- ▶ Select **Camera**.

### Active Parking Assist

#### Function of Active Parking Assist

Active Parking Assist is an electronic parking assistance system which uses ultrasound and is automatically activated during forward travel. The system is operational at speeds below approximately 22 mph (35 km/h).

If all requirements are met, the  display appears in the multifunction display. The system then independently locates and measures parallel and perpendicular parking spaces on both sides of the vehicle.

When Active Parking Assist has detected parking spaces, the  display appears in the multifunction display. The arrows show on which side of the road detected parking spaces are located. They are then shown in the media display. The parking space and, if necessary, the parking direction can be selected as desired. Active Parking Assist calculates a suitable vehicle path, switches on the turn signal indicator and assists you in parking and exiting the parking space.

**Vehicles with automatic transmission:** Active Parking Assist supports with changing gear, accelerating, braking and steering the vehicle.

Active Parking Assist is only an aid. It is not a substitute for your attention to the surroundings. The responsibility for safe maneuvering and parking remains with you. Make sure that no persons, animals or objects etc. are in the maneuvering range.

Active Parking Assist is canceled if, among other things, one of the following actions is carried out:

- Parking Assist PARKTRONIC is deactivated.
- Active Parking Assist is deactivated.
- You begin steering.
- You apply the parking brake.
- **Vehicles with automatic transmission:** You engage transmission position .
- ESP® intervenes.
- You open the doors or the trunk lid while driving.



### System limits

Objects located above or below the detection range of Active Parking Assist are not detected when the parking space is being measured. These are also not taken into account when the parking maneuver is calculated, e.g. overhanging loads, overhangs or loading ramps of trucks or the boundaries of parking spaces. In some circumstances, Active Parking Assist may therefore guide you into the parking space prematurely.

**⚠ WARNING** Risk of accident due to objects located above or below the detection range of Active Parking Assist

If there are objects above or below the detection range, the following situations may arise:

- Active Parking Assist may steer too early.
- **Vehicles with automatic transmission:** The vehicle may not stop in front of these objects.

This could cause a collision.

▶ In these situations, do not use Active Parking Assist.

Snowfall or heavy rain may lead to a parking space being measured inaccurately. Parking spaces that are partially occupied by trailer drawbars might not be identified as such or be measured incorrectly. Only use Active Parking Assist on level, high-grip ground.

Do not use Active Parking Assist in the following situations:

- In extreme weather conditions such as ice, packed snow or in heavy rain.
- When transporting a load that protrudes beyond the vehicle.
- If the parking space is on a steep downhill or uphill gradient.
- When snow chains are installed.

Active Parking Assist may also display parking spaces that are not suitable for parking, e.g. the following:

- Parking spaces where parking is prohibited.
- Parking spaces on unsuitable surfaces.

Active Parking Assist will not assist you with parking spaces at right angles to the direction of travel in the following situations:

- If two parking spaces are located immediately next to each other.
- If the parking space is immediately next to a low obstacle such as a curb.

Active Parking Assist will not assist you with parking spaces parallel or at right angles to the direction of travel in the following situations:

- If the parking space is on a curb.
- If the parking space is bordered by an obstacle, e.g. a tree, a post or a trailer.

### Parking with Active Parking Assist

**i** Depending on the vehicle's equipment, the button may also be located at a different position in the center console.

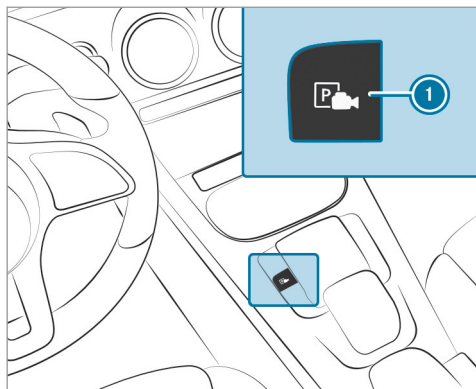

- ▶ Press button ①.

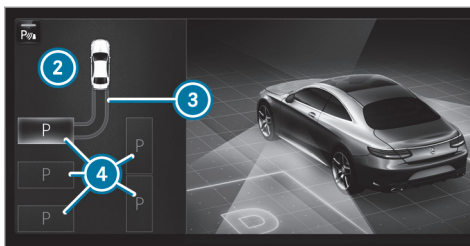

The media display shows the view of Active Parking Assist. Area ② displays detected parking spaces ④ and vehicle path ③.

- ① Vehicle path ③ shown on the media display may differ from the actual vehicle path.
- ▶ If you have driven past a parking space: bring the vehicle to a standstill.
- ▶ Select desired parking space ④.
- ▶ Where necessary, select the parking direction: forwards or reverse. Vehicle path ③ is shown, depending on selected parking space ④ and the parking direction.

- ▶ Confirm selected parking space ④.

① The turn signal indicator is switched on automatically when the parking procedure begins. The turn signal indicator is switched off automatically when you switch to **D**.

You are responsible for selecting the turn signal indicator in accordance with the traffic conditions. If necessary, select the turn signal indicator accordingly.

**⚠ WARNING** Risk of accident due to vehicle swinging out while parking or pulling out of a parking space

While parking or exiting a parking space, the vehicle swings out and can drive onto areas of the oncoming lane.

This could cause you to collide with objects or other road users.

- ▶ Pay attention to objects and other road users.
- ▶ Where necessary, stop the vehicle or cancel the parking procedure with Active Parking Assist.

- ▶ If, for example, the **Please Engage Reverse Gear** message appears in the media display: select the corresponding transmission position.

**Vehicles with automatic transmission:**

The vehicle drives into the selected parking space.

On completion of the parking procedure, the **Parking Assist Finished, Take Control of Vehicle** display message appears. Further maneuvering may still be necessary.

- ▶ After completion of the parking procedure, safeguard the vehicle against rolling away. When required by legal requirements or local conditions: turn the wheels towards the curb.

- ⓘ You can stop the vehicle and change the transmission position during the parking procedure. The system then calculates a new vehicle path. The parking procedure can then be continued. If no new vehicle path is available, the transmission position will be changed again. If the vehicle has not yet reached the parking space, the parking pro-

cedure will be canceled, should a gear be changed.

**Exiting a parking space with Active Parking Assist**

**Requirements:**

- The vehicle has been parked with Active Parking Assist.
- ⓘ Depending on the vehicle's equipment, the button may also be located at a different position in the center console.

Please note that you are responsible for the vehicle and surroundings during the entire parking procedure.

- ▶ Start the vehicle.

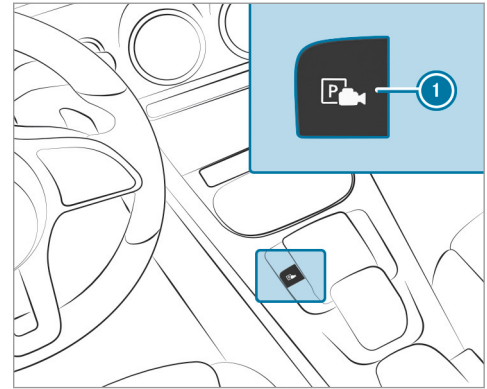

- ▶ Press button ①. The media display shows the view of Active Parking Assist.

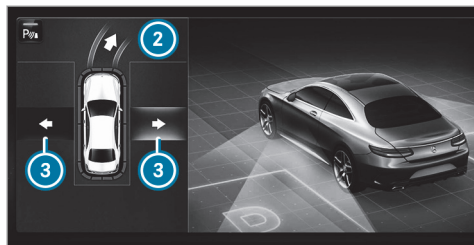

► If the vehicle has been parked at right angles to the direction of travel: in area ②, select direction of travel ③.

① The vehicle path shown on the media display may differ from the actual vehicle path.

► Confirm direction of exit ③ to drive out of the parking space.

① The turn signal indicator is switched on automatically when the exiting procedure begins.

You are responsible for selecting the turn signal indicator in accordance with the traffic conditions. If necessary, select the turn signal indicator accordingly.

**⚠ WARNING** Risk of accident due to vehicle swinging out while parking or pulling out of a parking space

While parking or exiting a parking space, the vehicle swings out and can drive onto areas of the oncoming lane.

This could cause you to collide with objects or other road users.

- Pay attention to objects and other road users.
- Where necessary, stop the vehicle or cancel the parking procedure with Active Parking Assist.

► If, for example, the **Please Engage Forward Gear** message appears in the media display: select the corresponding transmission position. The vehicle moves out of the parking space. The turn signal indicator is switched off automatically.

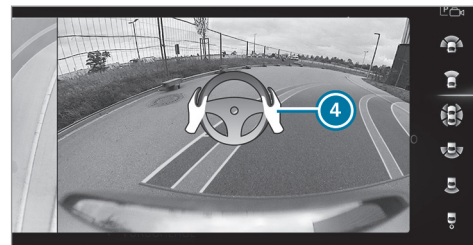

The image shows an example of a vehicle with a 360° Camera.

After the exiting procedure has been completed, the **Parking Assist Finished, Take Control of Vehicle** message appears in the media display. A warning tone and display ④ in the media display prompt you to take over control of the vehicle. You have to accelerate, brake, steer and change gear yourself again.

#### Function of Drive Away Assist

Drive Away Assist can reduce the severity of an impact when pulling away. If an obstacle is detected in the direction of travel, the vehicle's speed is briefly reduced to approx. 1 mph

(2 km/h). If a critical situation is detected, the following symbol appears in the media display:



**⚠ WARNING** Risk of accident caused by limited detection performance of Drive Away Assist

Drive Away Assist cannot always clearly identify objects and traffic situations.

In such cases, Drive Away Assist might:

- Warn you without reason and limit the vehicle speed.
- Not warn you or not limit the vehicle speed.

- ▶ Always pay careful attention to the traffic situation; do not rely on Drive Away Assist alone.
- ▶ Be prepared to brake or swerve as necessary, provided the traffic situation

permits and that it is safe to take evasive action.

Drive Away Assist is only an aid. It is not a substitute for your attention to the surroundings. The responsibility for safe maneuvering and parking remains with you. Make sure that no persons, animals or objects etc. are in the maneuvering range.

A risk of a collision may arise in the following situations, for example:

- If the driver mixes up the accelerator and brake pedals.
- If the wrong gear is selected.

The Drive Away Assist function is active under the following conditions:

- If Parking Assist PARKTRONIC is activated.
- Every time the gear is changed to **R** or **D** when the vehicle is at a standstill.
- If the detected obstacle is less than approx. 3.3 ft (1.0 m) away.
- If the maneuvering assistance function is activated in the multimedia system.

### System limits

The performance of Drive Away Assist is limited on inclines.

### Function of Cross Traffic Alert

- ① Also read the instructions on Blind Spot Assist (→ page 202).



**Vehicles with Blind Spot Assist:** the Cross Traffic Alert function can warn drivers of any crossing traffic when backing up out of a parking space. The radar sensors in the bumper also monitor the area adjacent to the vehicle. If a critical situation is detected, symbol ① appears in the media display. If the driver does not respond

to the warning, the vehicle's brakes can be applied automatically.

If the radar sensors are obstructed by vehicles or other objects, detection is not possible.

The Cross Traffic Alert function is active under the following conditions:

- If Blind Spot Assist is activated.
- If the vehicle is backing up at walking pace.
- If the maneuvering assistance function is activated in the multimedia system.

### System limitations

The Cross Traffic Alert function is not available on inclines.

### Activating/deactivating maneuvering assistance

Multimedia system:

→  ► Settings ► Assistance  
► Camera & Parking

- ▶ Switch [Maneuvering Assistance](#) on or off.
- ⓘ Maneuvering assistance must be active for the function of Drive Away Assist

(→ page 196) and Cross Traffic Alert  
(→ page 197).

## ATTENTION ASSIST

### Function of ATTENTION ASSIST

ATTENTION ASSIST assists you on long, monotonous journeys, e.g. on highways and trunk roads. If ATTENTION ASSIST detects indicators of fatigue or increasing lapses in concentration on the part of the driver, it suggests taking a break.

ATTENTION ASSIST is only an aid. It cannot always detect fatigue or lapses in concentration in time. The system is not a substitute for a well-rested and attentive driver. On long journeys, take regular breaks in good time that allow for adequate recuperation.

You can choose between two settings:

- **Standard:** normal system sensitivity.
- **Sensitive:** higher system sensitivity. The driver is warned earlier and the attention level detected by ATTENTION ASSIST is adapted accordingly.

If drowsiness or increasing lapses in concentration are detected, the **ATTENTION ASSIST: Take a Break!** warning appears in the instrument display. You can acknowledge the message and take a break where necessary. If you do not take a break and ATTENTION ASSIST continues to detect increasing lapses in concentration, you will be warned again after a minimum of 15 minutes.



You can have the following status information for ATTENTION ASSIST displayed in the assistance menu of the on-board computer:

- The length of the journey since the last break.

- The attention level determined by ATTENTION ASSIST:
  - the fuller the circle, the higher the attentional level determined
  - as your attention wanes, the circle in the center of the display becomes smaller

If ATTENTION ASSIST is unable to calculate the attention level and cannot issue a warning, the **System Suspended** message appears.

If a warning is given in the Instrument Display, the multimedia system offers to search for a rest area. You can select a rest area and start navigation to this rest area. This function can be activated and deactivated in the multimedia system.

If ATTENTION ASSIST is deactivated, the  symbol appears in the assistance graphic in the Instrument Display when the engine is running. ATTENTION ASSIST is activated automatically when the engine is re-started. The last selected sensitivity level remains stored.

### System limits

ATTENTION ASSIST is active in the 37 mph (60 km/h) to 124 mph (200 km/h) speed range.

The functionality of ATTENTION ASSIST is restricted, and warnings may be delayed or not occur at all in the following situations:

- If you have been driving for less than approximately 30 minutes.
- If the road condition is poor (uneven road surface or potholes).
- If there is a strong side wind.
- If you adopt a sporty driving style (high cornering speeds or high rates of acceleration).
- If the Steering Assist function of Active Distance Assist DISTRONIC is active.
- If the time has been set incorrectly.
- In active driving situations, if you change lanes and vary your speed frequently.

The ATTENTION ASSIST tiredness or alertness assessment is deleted and restarted when continuing the journey in the following situations:

- If you switch off the engine.
- If you unfasten your seat belt and open the driver's door (e.g. changing drivers or taking a break).

### Setting ATTENTION ASSIST



Multimedia system:

  **» Settings » Assistance**  
**» Attention Assist**

### Setting options

 Select **Standard**, **Sensitive** or **Off**.

### Suggesting a rest area

-  Select **Suggest Rest Area**.
-  Activate or deactivate the function. If ATTENTION ASSIST detects fatigue or increasing lack of attention, it suggests a rest area in the vicinity.
-  Select the suggested rest area. You are guided to the selected rest area.

## Traffic Sign Assist

### Function of Traffic Sign Assist

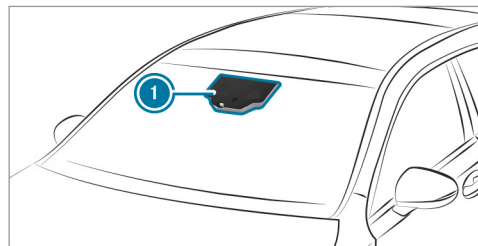

Traffic Sign Assist detects traffic signs with multifunction camera ①. It assists you by displaying detected speed limits and overtaking restrictions in the instrument cluster and optionally in the Head-up Display or central display.

Since Traffic Sign Assist also uses the data stored in the navigation system, it can update the display in the following situations without detecting traffic signs:

- When the vehicle changes roads, e.g. a freeway entry or exit.

- When a village or city boundary which is stored in the digital map is crossed.

The camera also detects traffic signs with a restriction indicated by an additional sign (e.g. in wet conditions).

Traffic Sign Assist is only an aid. The driver is responsible for keeping a safe distance to the vehicle in front, for vehicle speed and for braking in good time.

### Warning when the maximum permissible speed is exceeded

The system can warn you if you unintentionally exceed the maximum permissible speed. To do this, you can specify in the multimedia system by how much the maximum permissible speed can be exceeded before a warning is issued. You can specify whether the warning is to be just a visual warning or an acoustic one as well.

## Display in the Instrument Display

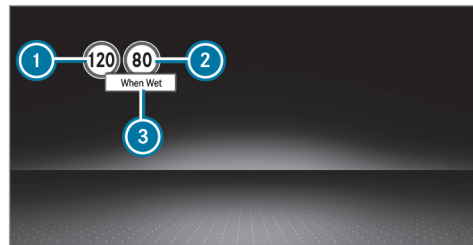

Instrument Display in the Widescreen Cockpit

- ① Permissible speed
- ② Permissible speed when there is a restriction
- ③ Additional sign with restriction



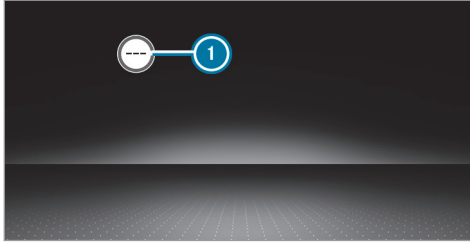

Traffic Sign Assist is not available in all countries. If it is unavailable, display  is shown in the speedometer.

### System limitations

The system may be impaired or may not function in the following situations:

- If there is poor visibility, e.g. due to insufficient illumination of the road, if there are highly variable shade conditions or in rain, snow, fog or heavy spray.
- If there is glare, e.g. from oncoming traffic, direct sunlight or reflections.
- If the windshield in the area of the multifunction camera is dirty, or if the camera is fogged up, damaged or covered.
- If the traffic signs are hard to detect, e.g. due to dirt or snow, or because they are covered or due to insufficient lighting.
- If the information in the navigation system's digital map is incorrect or out-of-date.
- If the signs are ambiguous, e.g. traffic signs on construction sites or in adjacent lanes.
- If you turn sharply, when passing traffic signs outside the camera's field of vision.

### Setting Traffic Sign Assist

#### Requirements:

- **For automatic adoption of speed limits:** Active Distance Assist DISTRONIC is activated.

Multimedia system:

- ▶  ▶ Settings ▶ Assistance
- ▶▶ Traffic Sign Assist

### Activating/deactivating automatic adoption of speed limits

- ▶ Select **Limit Adoption**.
- ▶ Activate or deactivate the function. The speed limits detected by Traffic Sign Assist are automatically adopted by Active Distance Assist DISTRONIC.

 If one of the following systems is activated, the speed detected can be manually adopted as the speed limit:

- Active Distance Assist DISTRONIC
- Cruise control
- Variable limiter

Further information (→ page 172).

### Displaying detected traffic signs in the media display

- ▶ Select **Display in Central Display**.
- ▶ Activate or deactivate the function.

### Adjusting the type of warning

- ▶ Select **Visual & Audible**, **Visual** or **None**.

### Adjusting the warning threshold

This value determines the speed at which a warning is issued when exceeded.

- ▶ Select **Warning Threshold**.
- ▶ Set the desired speed.

### Blind Spot Assist and Active Blind Spot Assist with exit warning

#### Function of Blind Spot Assist and Active Blind Spot Assist with exit warning

Blind Spot Assist and Active Blind Spot Assist use two lateral, rear-facing radar sensors to monitor the area up to 130 ft (40 m) behind your vehicle and 10 ft (3 m) directly next to your vehicle.

If a vehicle is detected at speeds above approximately 8 mph (12 km/h) and this vehicle subsequently enters the monitoring range directly next to your vehicle, the warning lamp in the outside mirror lights up red.

If a vehicle is detected close to the side of your vehicle, the red warning lamp in the outside mirror flashes. If you switch on the turn signal indicator in the corresponding direction, a warning tone sounds once. If the turn signal indicator remains switched on, all other detected vehicles are indicated only by the flashing of the red warning lamp.

If you overtake a vehicle quickly, no warning is given.

#### **WARNING** Risk of accident despite Blind Spot Assist

Blind Spot Assist does not react to vehicles approaching and overtaking you at a greatly different speed.

As a result, Blind Spot Assist cannot warn drivers in this situation.

- ▶ Always pay careful attention to the traffic situation and maintain a safe distance at the side of the vehicle.

Blind Spot Assist and Active Blind Spot Assist are only aids. They may fail to detect some vehi-

cles and are no substitute for attentive driving. Always ensure that there is sufficient distance to the side for other road users and obstacles.

### Exit warning

The exit warning is an additional function of Blind Spot Assist and can warn vehicle occupants about approaching vehicles when leaving the vehicle when stationary.

#### **WARNING** Risk of accident despite exit warning

The exit warning reacts neither to stationary objects nor to vehicles approaching you at a greatly different speed.

As a result, the exit warning cannot warn drivers in these situations.

- ▶ Always pay particular attention to the traffic situation when opening the doors and make sure there is sufficient clearance.

If there is a vehicle in the monitoring range, this is indicated in the outside mirror. If a vehicle occupant opens the door on the side with the

warning, a warning tone sounds and the warning lamp in the outside mirror starts to flash.

This additional function is only available when Blind Spot Assist is activated and up to a maximum of three minutes after the ignition has been switched off. The exit warning is no longer available once the warning lamp in the outside mirror flashes three times.

The exit warning is only an aid and not a substitute for the attention of vehicle occupants. The responsibility for opening and closing the doors and for leaving the vehicle remains with the vehicle occupants.

### System limits

Blind Spot Assist and Active Blind Spot Assist may be limited in the following situations:

- if there is dirt on the sensors or the sensors are obscured
- in poor visibility, e.g. due to fog, heavy rain or snow
- if there are narrow vehicles, e.g. bicycles or motorbikes
- if the road has very wide or narrow lanes

- if vehicles are not driving in the middle of their lane

Warnings may be issued in error when driving close to crash barriers or similar solid lane borders. Always make sure that there is sufficient distance to the side for other traffic or obstacles.

Warnings may be interrupted when driving alongside long vehicles, for example trucks, for a prolonged time.

Blind Spot Assist is not operational when reverse gear is engaged.

The exit warning may be limited in the following situations:

- when the sensors are covered by adjacent vehicles in narrow parking spaces
- when people approach the vehicle
- in the event of stationary or slowly moving objects

### Function of brake application (Active Blind Spot Assist)

- ① The brake application function is only available for vehicles with a Driving Assistance Package.

If Active Blind Spot Assist detects a risk of a side impact in the monitoring range, a course-correcting brake application is carried out. This is designed to help you avoid a collision.

The course-correcting brake application is available in the speed range between approximately 20 mph (30 km/h) and 125 mph (200 km/h).

**⚠ WARNING** Risk of accident despite brake application of Active Blind Spot Assist

A course-correcting brake application cannot always prevent a collision.

- ▶ Always steer, brake or accelerate yourself, especially if Active Blind Spot Assist warns you or makes a course-correcting brake application.

- ▶ Always maintain a safe distance at the sides.

**⚠ WARNING** Risk of accident despite Active Blind Spot Assist

Active Blind Spot Assist does not react to the following:

- If vehicles overtake too closely on the side, placing them in the blind spot area
- Vehicles approaching and overtaking you at a greatly different speed

As a result, Active Blind Spot Assist may neither give warnings nor intervene in such situations.

- ▶ Always pay careful attention to the traffic situation and maintain a safe distance at the side of the vehicle.

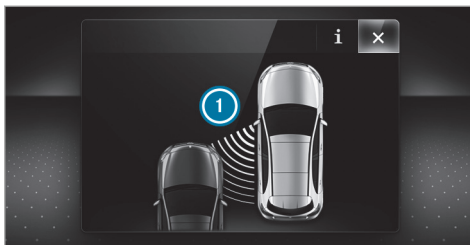

If a course-correcting brake application occurs, the red warning lamp flashes in the outside mirror and a warning tone sounds. In addition, a display ⓘ indicating the danger of a side collision appears in the multifunction display.

In rare cases, the system may make an inappropriate brake application. This brake application may be interrupted at any time if you steer slightly in the opposite direction or accelerate.

### System limits

Either a course-correcting brake application appropriate to the driving situation, or none at all, may occur in the following situations:

- Vehicles or obstacles, e.g. crash barriers, are located on both sides of your vehicle.
- A vehicle approaches too closely on the side.
- You have adopted a sporty driving style with high cornering speeds.
- You brake or accelerate significantly.
- A driving safety system intervenes, e.g. ESP® or Active Brake Assist.
- ESP® is deactivated.
- A loss of tire pressure or a defective tire is detected.

### Activating/deactivating Blind Spot Assist or Active Blind Spot Assist

Multimedia system:

▶ ▶ Settings ▶ Assistance

▶ Activate or deactivate **Blind Spot Assist**.

## Active Lane Keeping Assist

### Function of Active Lane Keeping Assist

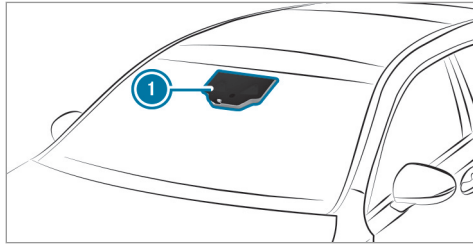

Active Lane Keeping Assist monitors the area in front of your vehicle by means of multifunction camera ①. It serves to protect you against unintentionally leaving your lane. You will be warned by vibration pulses in the steering wheel and guided by a course-correcting brake application back into your lane.

You are warned by vibration pulses in the steering wheel in the following circumstances:

- Active Lane Keeping Assist detects a lane marking.

- A front wheel drives over this lane marking.

You will also be guided back into your lane by means of a course-correcting brake application if the following conditions are met:

- Active Lane Keeping Assist detects lane markings on both edges of the lane.
- A front wheel drives over a solid lane marking.

You can activate or deactivate the Active Lane Keeping Assist warning.

Active Lane Keeping Assist can neither reduce the risk of an accident if you fail to adapt your driving style nor override the laws of physics. It cannot take into account road, weather or traffic conditions. Active Lane Keeping Assist is only an aid. You are responsible for the distance to the vehicle in front, for vehicle speed, for braking in good time and for staying in your lane.

Active Lane Keeping Assist can bring the vehicle back into the lane with a lane-correcting brake application. In the case of a broken lane marking being detected, a brake application will only be

made if a vehicle has been detected in the adjacent lane. Oncoming traffic can be detected.

**Vehicles with Driving Assistance Package or Driving Assistance Plus Package:** overtaking vehicles and vehicles in adjacent lanes can also be detected.

Active Lane Keeping Assist is available in the speed range between 37 mph (60 km/h) and 124 mph (200 km/h).



If a lane-correcting brake application occurs, display ① appears in the multifunction display.

### Sensitivity of Active Lane Keeping Assist

- ① The availability of the following function is country-dependent.

A lane-correcting brake application also occurs in the **Sensitive** setting in the following situations:

- Active Lane Keeping Assist detects a solid lane marking.
- A front wheel drives over this lane marking.

### System limits

No lane-correcting brake application occurs in the following situations:

- You clearly and actively steer, brake or accelerate.
- You have switched on the turn signal indicator (situation-dependent).
- A driving safety system intervenes, such as ESP®, Active Brake Assist or Active Blind Spot Assist.
- You have adopted a sporty driving style with high cornering speeds or high rates of acceleration.

- When ESP® is deactivated.
- If a loss of tire pressure or a faulty tire has been detected and displayed.

The system may be impaired or may not function in the following situations:

- If there is poor visibility, e.g. due to insufficient illumination of the road, if there are highly variable shade conditions or in rain, snow, fog or heavy spray.
- If there is glare, e.g. from oncoming traffic, the sun or reflections.
- If the windshield in the area of the multifunction camera is dirty, or if the camera is fogged up, damaged or covered.
- If there are no lane markings, or several unclear lane markings are present for one lane, e.g. around roadworks.
- If the lane markings are worn, dark or covered.
- If the distance to the vehicle in front is too short and thus the lane markings cannot be detected.

- If the lane markings change quickly, e.g. lanes branch off, cross one another or merge.
- If the roadway is very narrow and winding.

### Vehicles with Driving Assistance Package:

Active Lane Keeping Assist uses radar sensors to monitor several areas around the vehicle. If the radar sensors in the rear bumper are dirty or covered with snow, the system may be impaired or may not function. If an obstacle in the lane in which you are driving has been detected, no lane-correcting brake application occurs.

### Activating/deactivating Active Lane Keeping Assist

Multimedia system:

-  **Settings**
- **Schnellzugriff** (Quick access)
- **Active Lane Keeping Assist**
- ▶ Activate or deactivate the function.

### Setting Active Lane Keeping Assist

Multimedia system:

-  → Settings → Assistance
- Active Lane Keeping Assist

### Setting the sensitivity

-  The availability of this function is dependent on the country.
- ▶ Select **Standard**, **Sensitive** or **Off**.

### Activating/deactivating the haptic warning

- ▶ Select **Warning**.
- ▶ Activate or deactivate the function.

## Vehicle towing instructions

The vehicle is not suitable for the use of tow bar systems that are used for flat towing or dinghy towing, for example. Attaching and using tow bar systems can lead to damage on the vehicle. When you are towing a vehicle with tow bar systems, safe driving characteristics cannot be guaranteed for the towing vehicle or the towed vehicle. The vehicle-trailer combination may swerve from side to side. Comply with the per-

mitted towing methods (→ page 408) and the instructions for towing with both axles on the ground (→ page 409).

### Instrument Display overview

**Mercedes-AMG vehicles:** be sure to observe the information in the Supplement. Otherwise, you may not recognize dangers.

**⚠ WARNING** Risk of accident due to an instrument display malfunction

If the Instrument Display has failed or malfunctioned, you may not recognize function restrictions applying to safety relevant systems.

The operating safety of your vehicle may be impaired.

- ▶ Drive on carefully.
- ▶ Have the vehicle checked immediately at a qualified specialist workshop.

If the operating safety of your vehicle is impaired, park the vehicle safely as soon as possible. Contact a qualified specialist workshop.

### Instrument Display (standard)



- ① Speedometer (example)
- ② Multifunction display
- ③ Fuel level and fuel filler cap location indicator

Further content can be shown on multifunction display ②:

- Assistant display
- Telephone
- Navigation
- Trip
- Radio

- Media
- Vehicle dynamics
- Styles
- Maintenance

### Instrument Display in the Widescreen Cockpit

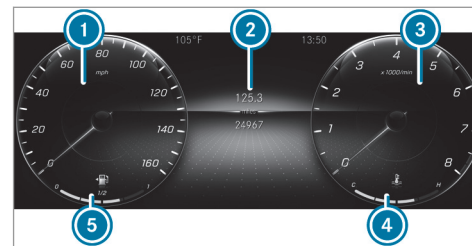

- ① Speedometer (example)
- ② Multifunction display
- ③ Tachometer (example)
- ④ Coolant temperature display
- ⑤ Fuel level and fuel filler cap location indicator



❶ In addition to multifunction display ❷, further content can be shown on displays ❶ and ❸ (→ page 212).

The segments on speedometer ❶ indicate the system status for the following:

- Cruise control(→ page 168)
- Active Distance Assist DISTRONIC(→ page 170)

**!** **NOTE** Engine damage due to excessively high engine speeds

The engine will be damaged if you drive with the engine in the overrevving range.

- ▶ Do not drive with the engine in the overrevving range.

The fuel supply will be interrupted to protect the engine when the red mark on the tachometer (overrevving range) is reached.

**Vehicles with Widescreen Cockpit:** during normal operating conditions, the coolant temperature display may rise to the red mark.

**!** **WARNING** Danger of burns when opening the hood



If you open the hood when the engine has overheated or during a fire in the engine compartment, you could come into contact with hot gases or other escaping operating fluids.

- ▶ Before opening the hood, allow the engine to cool down.
- ▶ In the event of a fire in the engine compartment, keep the hood closed and call the fire service.

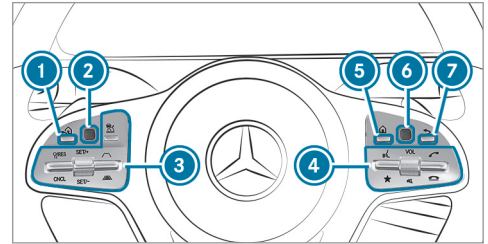
## Overview of the buttons on the steering wheel



- ❶ Back/Home button (press and hold), on-board computer
- ❷ Touch Control, on-board computer
- ❸ Control panel for cruise control or Active Distance Assist DISTRONIC
- ❹ Control panel for MBUX multimedia system:
  - Voice Control System
  - Displays favorites
  - VOL:** control knob, adjusts the volume or switches the sound off (press)
  - Makes/accepts a call

-  Rejects/ends a call
- ⑤  Calls up the home screen
- ⑥ Touch Control multimedia system
- ⑦  Back button (press and hold)

### Operating the on-board computer

**⚠ WARNING** Risk of distraction from information systems and communications equipment

If you operate information and communication equipment integrated in the vehicle when driving, you will be distracted from the traffic situation. This could also cause you to lose control of the vehicle.

- ▶ Only operate this equipment when the traffic situation permits.
- ▶ If you cannot be sure of this, stop the vehicle whilst paying attention to road and traffic conditions and operate the equipment with the vehicle stationary.

Observe the legal requirements for the country in which you are currently driving when you operate the on-board computer.

① The on-board computer displays appear on the multifunction display (→ page 213).

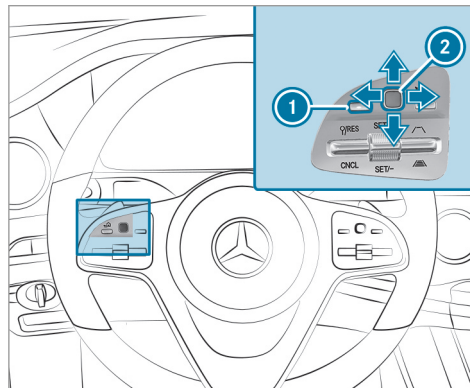

The on-board computer can be operated using left-hand Touch Control ② and the left-hand back/home button ①.

When the on-board computer is being operated, different acoustic signals will sound as operating feedback, e.g. when the end of a list is reached or when you are scrolling through a list.

The following menus are available:

- Assistance
- Phone
- Navigation
- Trip
- Radio
- Media
- Designs & Disp.
- Service

The menus can be called up from the menu bar on the multifunction display.

▶ **To call up the menu bar:** press back button on the left ① until the menu bar is displayed.

① **Vehicles without Active Distance Assist DISTRONIC:** press the  button to call up the menu bar of the on-board computer.



**i** The illustration shows the instrument display in the Widescreen Cockpit.

- ▶ **To scroll in the menu bar:** swipe left or right on left-hand Touch Control ②.
- ▶ **To call up a menu or confirm a selection:** press left-hand Touch Control ②.
- ▶ **To scroll through displays or lists on the menu:** swipe upwards or downwards on left-hand Touch Control ②.
- ▶ **To call up a submenu or confirm a selection:** press left-hand Touch Control ②.
- ▶ **To exit a submenu:** press back button on the left ①.

### Selecting the Head-up Display

- ▶ **If the Head-up Display is switched on:** swipe upwards on left-hand Touch Control ②.
  - ▶ Swipe upwards on the left-hand Touch Control ② to switch to the Head-up Display.
- or
- ▶ **If the Head-up Display is switched off:** press left-hand Touch Control ②.

### Full menu display

**Vehicles with an instrument display in the Widescreen Cockpit:** the following menus can be shown in full on the instrument display:

- Assistance
  - Trip
  - Navigation
- ▶ In the corresponding menu, use left-hand Touch Control ② to scroll to the end of the list.
  - ▶ Press left-hand Touch Control ②. The selected menu will be displayed in full.

### Adjusting the design of the Instrument Display

On-board computer:

↳ Designs & Disp.

### Setting the design

- ▶ Swipe upwards or downwards on the left-hand Touch Control.
- ▶ Press the left-hand Touch Control. The Instrument Display is shown in the selected design.

The following designs can be selected, depending on the vehicle equipment:

- Classic
- Sport
- Progressive
- Understated
- Standard Displays

### Showing display content on the instrument cluster

**Vehicles with an Instrument Display in the Widescreen Cockpit:** additional display content can be shown on the instrument cluster.

- ▶ **To select display content:** swipe to the right on the left-hand Touch Control.
- ▶ Swipe upwards or downwards on the left-hand Touch Control to select the required display content. When the display content is selected, it will briefly be highlighted.

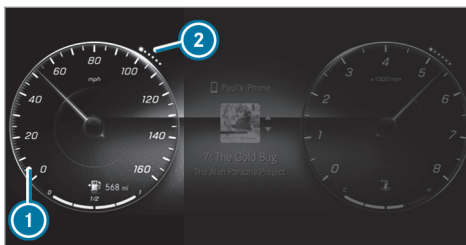

- ① Display content, left (example: speedometer)
- ② The index points show the selected display content.

Display content selection, left:

- Speedometer
- Time/date
- Trip computer [From Start](#) and [From Reset](#)
- Range
- Audio

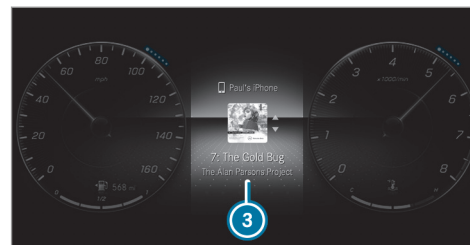

- ③ Display content, center (example: media)

Display content selection, center:

- Assistance graphic
- Telephone
- Navigation
- Trip
- Radio
- Media
- Styles and display
- Maintenance

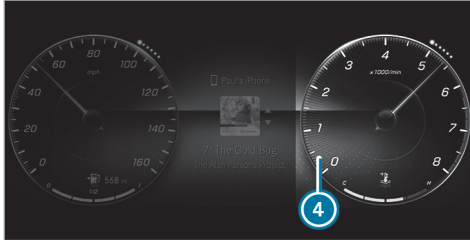

④ Display content, right (example: tachometer)

Display content selection, right:

- Tachometer
- Average fuel consumption
- ECO display
- Navigation
- G-Meter
- Assistance graphic

### Overview of displays on the multifunction display

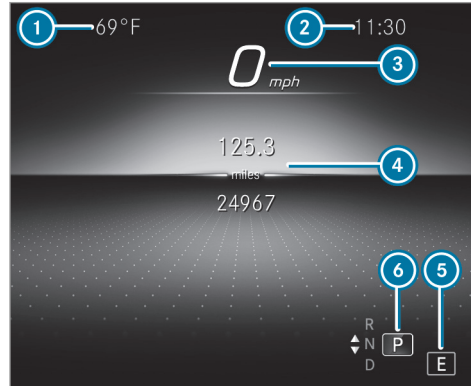

- ① Outside temperature
- ② Time
- ③ Digital speedometer
- ④ Display section
- ⑤ Drive program
- ⑥ Transmission position

① **Vehicles with standard Instrument Display:** the position of the displays differs from those shown here.

Further displays on the multifunction display:

- † Gearshift recommendation (→ page 143)
- Active Parking Assist activated (→ page 193)
- Parking Assist PARKTRONIC deactivated (→ page 185)
- Cruise control (→ page 168)
- Active Distance Assist DISTRONIC (→ page 170)
- Active Brake Assist (→ page 167)
- Active Steering Assist (→ page 175)
- Active Lane Keeping Assist (→ page 205)
- ECO start/stop function (→ page 135)
- HOLD function (→ page 179)
- Adaptive Highbeam Assist (→ page 116)

**Vehicles with Traffic Sign Assist:** Detected instructions and traffic signs (→ page 200).

### Adjusting the instrument lighting

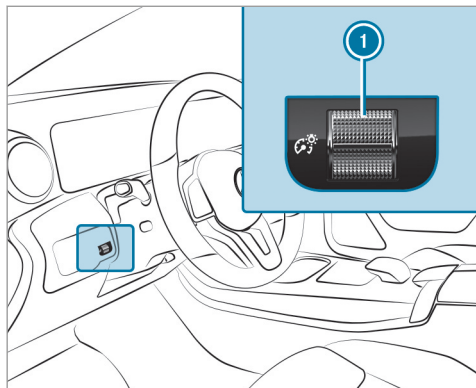

- ▶ Turn brightness control ① up or down. The lighting of the Instrument Display and in the control elements of the vehicle interior is adjusted.

### Menus and submenus

#### Functions on the service menu of the on-board computer

On-board computer:

↳ Service

- ▶ **To select the function:** swipe upwards or downwards on the left-hand Touch Control.
- ▶ Press the left-hand Touch Control.

Functions on the **Service** menu:

- Message memory (→ page 459)
- **Tires:**
  - Restarting the tire pressure loss warning system (→ page 425)
  - Checking tire pressure with the tire pressure monitor (→ page 423)
  - Restarting the tire pressure monitor (→ page 424)
- **ASSYST PLUS:** calls up the service due date (→ page 379)
- **Coolant:** coolant temperature display
- **Engine Oil Level:** engine oil level

- **Consumption Info:** fuel life cycle consumption

#### Calling up the assistant display

On-board computer:

↳ Assistance

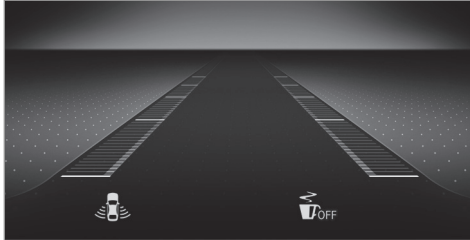

The following displays are available on the assistant display menu:

- Assistant display
- Attention level (→ page 198)
- **Vehicles with an Instrument Display in the Widescreen Cockpit:** full-screen menu display
- ▶ **To switch between the displays:** swipe upwards or downwards on the left-hand Touch Control.



**i** The illustration shows the Instrument Display in the Widescreen Cockpit.

Status displays on the assistant display:

-  ATTENTION ASSIST: deactivated
- Light lane markings: Active Lane Keeping Assist enabled
- Green lane markings: Active Lane Keeping Assist active
-  Gray radar waves next to vehicle: Blind Spot Assist or Active Blind Spot Assist enabled

-  Green radar waves next to vehicle: Blind Spot Assist or Active Blind Spot Assist active
- Active Distance Assist DISTRONIC displays (→ page 170)

### Calling up displays on the trip menu

On-board computer:

→ Trip

**To select a display:** swipe upwards or downwards on the left-hand Touch Control.

Trip menu in the standard cockpit:

- Speedometer
- Digital speedometer
- Tachometer
- Range and current fuel consumption
- ECO display (→ page 137)
- Trip computer [From Start](#) and [From Reset](#)

Trip menu in the widescreen cockpit:

- Standard display

- Digital speedometer
- Current fuel consumption
- ECO display (→ page 137)
- Trip computer [From Start](#) and [From Reset](#)
- Full-surface menu display

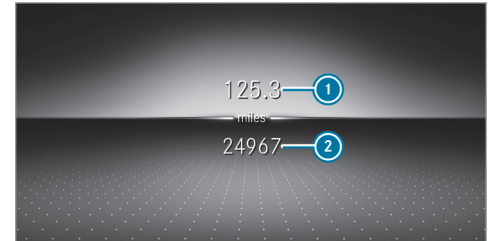

Example: standard display

- ① Trip distance
- ② Total distance

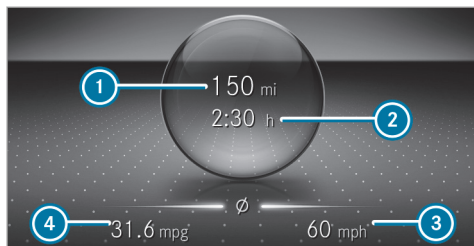

Example: trip computer

- ① Total distance
- ② Driving time
- ③ Average speed
- ④ Average fuel consumption

① The illustrations show the Instrument Display in the Widescreen Cockpit.

### Resetting values on the trip menu of the on-board computer

On-board computer:



You can reset the values of the following functions:

- Trip distance
- Trip computer [From Start](#) and [From Reset](#)
- ECO display(→ page 137)

- ▶ **To select the function to be reset:** swipe upwards or downwards on the left-hand Touch Control.
- ▶ Press the left-hand Touch Control.
- ▶ Select [Yes](#) .
- ▶ Press the left-hand Touch Control.

If you press and hold the left-hand Touch Control, the values of the function will be reset immediately.

### Calling up navigation instructions on the on-board computer

On-board computer:



The following displays are available in the navigation menu:

- Navigation view
- Map view
- Full-surface map view

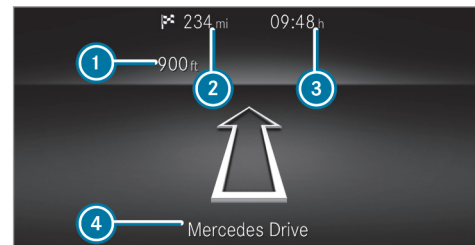

Example: no change of direction announced

- ① Distance to the next change of direction
- ② Distance to the next destination



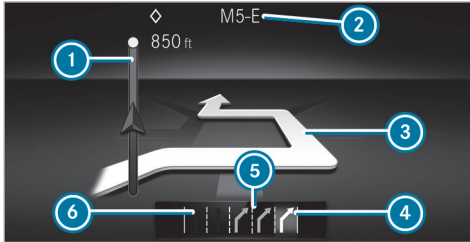

- ③ Estimated arrival time at next destination
- ④ Current road



Example: change of direction announced

- ① Distance to the change of direction
- ② Road to which the change of direction leads
- ③ Change-of-direction symbol
- ④ Recommended lane (white)
- ⑤ Possible lane
- ⑥ Lane not recommended (dark gray)

Further possible displays on the **Navigation** menu:

- **Direction of Travel:** display of direction of travel and road currently being traveled on.
- **New Route...** or **Calculating Route...:** a new route is being calculated.
- **Road Not Mapped:** the road is unknown, e.g. for newly built roads.
- **No Route:** no route could be calculated to the selected destination.
- **Off Map:** the map for the current location is not available.
- **Area of Destination Reached:** when an intermediate destination is reached, the intermediate destination flag will be displayed with the number of the intermediate destination . After this, route guidance will continue. Once the destination is reached, the checkered flag  will be displayed. Route guidance will now be complete.

▶ **To exit the menu:** press the back button on the left.

#### Vehicles with the MBUX multimedia system:

You can also start navigation to one of the recent destinations on the **Navigation** menu:

- ▶ Press the left-hand Touch Control.
- ▶ **To select a destination:** swipe upwards or downwards on the left-hand Touch Control.
- ▶ Press the left-hand Touch Control. Route guidance will start.  
If route guidance has already been activated, a request will appear asking whether you wish to end the current route guidance.
- ▶ Select **Yes**.
- ▶ Press the left-hand Touch Control. Route guidance will start.

### Selecting radio stations using the on-board computer

On-board computer:

→ Radio

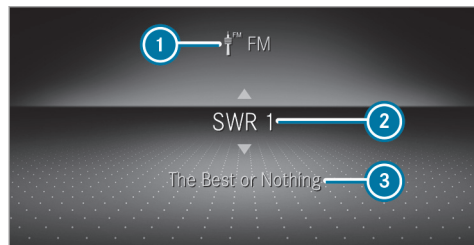

- ① Frequency range
- ② Station
- ③ Name of track

① The illustration shows the Instrument Display in the Widescreen Cockpit.

When you select a station from the memory presets, the preset will appear next to the station name. When you select a saved station in the

frequency range, an asterisk will appear next to the station name.

▶ **To select a radio station:** swipe upwards or downwards on the left-hand Touch Control.

### Selecting the frequency range or memory preset

- ▶ Press the left-hand Touch Control.
- ▶ Swipe upwards or downwards on the left-hand Touch Control.
- ▶ Press the left-hand Touch Control.

### Media playback using the on-board computer

On-board computer:

→ Media

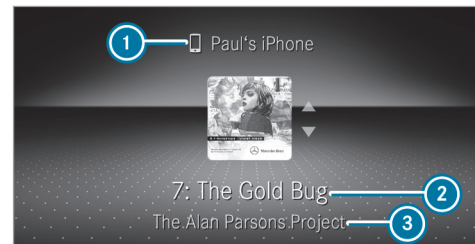

- ① Media source
- ② Track number and current track
- ③ Name of artist (example)

① The illustration shows the Instrument Display in the Widescreen Cockpit.

▶ **To change tracks on an active media source:** swipe upwards or downwards on the left-hand Touch Control.

### Changing a media source

- ▶ Press the left-hand Touch Control.
- ▶ **To select a media source:** swipe upwards or downwards on the left-hand Touch Control.
- ▶ Press the left-hand Touch Control.

### Dialing telephone numbers using the on-board computer

**⚠ WARNING** Risk of distraction from information systems and communications equipment

If you operate information and communication equipment integrated in the vehicle when driving, you will be distracted from the traffic situation. This could also cause you to lose control of the vehicle.

- ▶ Only operate this equipment when the traffic situation permits.
- ▶ If you cannot be sure of this, stop the vehicle whilst paying attention to road

and traffic conditions and operate the equipment with the vehicle stationary.

When using the phone, you must observe the legal requirements for the country in which you are currently driving.

#### Requirements:

- The mobile phone is connected to the multimedia system.

On-board computer:

↳ [Phone](#)

The most recent telephone calls (dialed, received and missed calls) are displayed on the [Phone](#) menu.

- ▶ **To select an entry:** swipe upwards or downwards on the left-hand Touch Control.
- ▶ Press the left-hand Touch Control.  
**If there is only one telephone number saved to an entry:** the telephone number will be selected.
- ▶ **If there are multiple telephone numbers saved to an entry:** swipe upwards or down-

wards on the left-hand touch control to select the desired telephone number.



- ▶ Press the left-hand Touch Control.  
The telephone number will be dialed.



The following displays may appear instead of the telephone numbers dialed:

- **Please Wait:** the application is starting. If a Bluetooth® connection to the mobile phone is not established, the menu for authorizing and connecting a mobile phone will be displayed on the multimedia system (→ page 329).
- **Updating Data...:** the call list is being updated.
- **Importing Contacts:** contacts are being imported from the mobile phone or a storage medium.

#### Accepting/rejecting an incoming call

**Vehicles with head-up display:** when you receive a call, the [Incoming Call](#) message will appear on the head-up display.

- ▶ Swipe upwards or downwards on the left-hand Touch Control and select  (accept) or  (reject).
- ▶ Press the left-hand Touch Control.

You may accept/reject the call using the  or  button on the steering wheel.

### Setting the Head-up Display using the on-board computer

On-board computer:

#### → HEAD-UP DISPLAY

The following Head-up Display settings can be selected:

- Position
  - Brightness
  - Displays
- ▶ **To select a setting:** swipe upwards or downwards on the left-hand Touch Control.
  - ▶ Press the left-hand Touch Control.
  - ▶ **To adjust the position:** swipe upwards or downwards on the left-hand Touch Control.

- ▶ **To adjust the brightness:** swipe to the left or right on the left-hand Touch Control.
- ▶ Press the left-hand Touch Control.

### Selecting what the Head-up Display shows

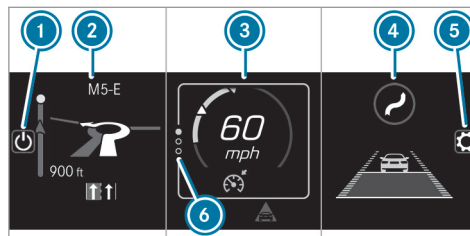

(Example)

- ① To switch the Head-up Display on/off
- ② Left display area  
Navigation system  
Average consumption  
G-Meter
- ③ Central display area  
Set speed in the driver assistance system (e.g. cruise control)

Warnings from driver assistance systems (e.g. distance warning)

- ④ Right display area  
Traffic Sign Assist  
Assistance graphic
- ⑤ To select the settings
- ⑥ Index points

Non-required display areas ② to ④ can be hidden.

- ⓘ In audio mode, the station name or track will be shown temporarily when the audio source is being actively operated.

- ▶ **To select a display:** swipe upwards or downwards on the left-hand Touch Control.
- ▶ Press the left-hand Touch Control.

### Head-up Display

#### Function of the Head-up Display

The Head-up Display projects important information in the driver's field of vision, e.g. current speed.

Depending on the vehicle's equipment, different content can be shown in the three areas of the Head-up Display.

### System limits

The visibility of the displays will be affected by the following conditions:

- Seat position
- Image position
- Ambient light
- Wet roadway
- Objects on the display cover
- Polarization in sunglasses

 In extreme sunlight, sections of the display may appear washed out. You can correct this by deactivating and reactivating the Head-up Display.

### Switching the Head-up Display on/off

Multimedia system:

   Settings  Quick Access

- ▶ Select HUD.  
The Head-up Display is activated.

### Notes on operating safety

**⚠ WARNING** Risk of distraction from information systems and communications equipment

If you operate information and communication equipment integrated in the vehicle when driving, you will be distracted from the traffic situation. This could also cause you to lose control of the vehicle.

- ▶ Only operate this equipment when the traffic situation permits.
- ▶ If you cannot be sure of this, stop the vehicle whilst paying attention to road and traffic conditions and operate the equipment with the vehicle stationary.

**⚠ WARNING** Risk of an accident from operating mobile communication equipment while the vehicle is in motion

Mobile communications devices distract the driver from the traffic situation. This could

also cause the driver to lose control of the vehicle.

- ▶ As the driver, only operate mobile communications devices when the vehicle is stationary.
- ▶ As a vehicle occupant, only use mobile communications devices in the areas intended for this purpose, e.g. in the rear passenger compartment.

For your own safety, always observe the following points when operating mobile communications equipment and especially your voice control system:

- Observe the legal requirements for the country in which you are driving.
- While driving, only operate mobile communications equipment and your voice control system when the traffic conditions permit it. You may otherwise be distracted from the traffic conditions and cause an accident, injuring yourself and others.
- If you use the voice control system in an emergency your voice can change and your

telephone call, e.g. an emergency call, can thereby be unnecessarily delayed.



- Familiarize yourself with the voice control system functions before starting the journey.

### Operation

#### Overview of operating the multifunction steering wheel

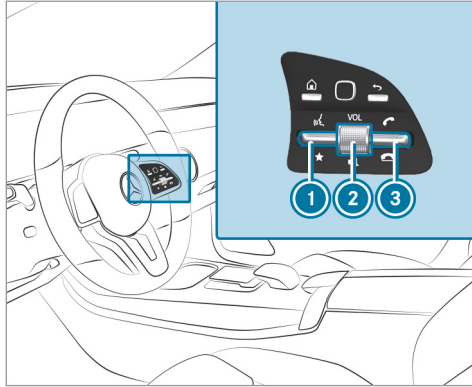
The Voice Control System is operational approximately thirty seconds after the ignition is switched on.



- 1 Press the rocker switch up:  starts the dialog
- 2 Press the control knob:  switches the sound off or on (ends the dialog)  
Turn the control knob up/down: increases/decreases the volume
- 3 Press the rocker switch down:  rejects/rejects a call (ends the dialog)



### Conducting a dialog

For the dialog with the Voice Control System, you can use complete sentences of colloquial language as voice commands, such as, for example, "Please show me the list of the last calls" or "How warm is it outside?". It is not necessary to first change to the relevant application such as "Telephone" or "Vehicle function".

- ▶ **To activate or continue dialog by using a keyword:** say "Hello Mercedes" to activate the Voice Control System. Voice activation must be switched on in the multimedia system (→ page 224). For this, it is not necessary to press up the  rocker switch on the multifunction steering wheel. Voice activation can also be directly combined with a voice command, e.g. "Hi Mercedes, how fast can I drive?".

or

- ▶ Press the  rocker switch up on the multifunction steering wheel.  
You can say a voice command after an acoustic signal.

- ▶ **To correct an entry:** say the Correction voice command.
- ▶ **To select an entry from the selection list:** say the line number or the contents.
- ▶ **To browse the selection list:** say the Next or Back voice command.
- ▶ **To interrupt the dialog:** say the Pause voice command.  
The dialog can be continued with the "Hello Mercedes" voice command or by pressing up the  rocker switch on the multifunction steering wheel.
- ▶ **To jump to the preceding dialog:** say the Back voice command.
- ▶ **To jump back to the top dialog level:** say the Home voice command.
- ▶ **To cancel the dialog:** say the Close voice command or press the  or  button on the multifunction steering wheel.

▶ **To interrupt a voice output:** speak in the middle of a voice dialog when the system is still answering.

The voice output is shortened and the conclusion is reached more quickly.

ⓘ The **Speak During Voice Output** option must be switched on in the multimedia system for this (→ page 224).

### Overview of operable functions in the Voice Control System

You can use the Voice Control System to operate the following functions depending on the vehicle equipment:

- Telephone
- Text messages
- Navigation
- Address book
- Radio
- Media
- Vehicle functions
- Weather

Full functionality is only available for you with activation of online voice control (→ page 224).

### Notes on the language setting

You can change the language of the Voice Control System via the system language settings. If the set system language is not supported by the Voice Control System, English will be selected.

The Voice Control System is available in English, French, Portuguese and Spanish.

### Setting the Voice Control System (multimedia system)

Requirements:

- **For online voice control:** your vehicle is connected with your Mercedes me user account (→ page 349).
- There is an Internet connection (→ page 353).
- **For online use of contacts:** online voice control is activated.

Multimedia system:

➔  ▶ Settings ▶ System  
▶ LINGUATRONIC

### Switching voice activation of the Voice Control System on/off

▶ Select **Voice Activation "Hey Mercedes"**. Depending on the previous status, the function is activated or deactivated.

When the function is active, the "Hi Mercedes" voice command can activate the dialog.

### Switching on voice interruption

▶ Select **Speak During Voice Output**. If the function is active, a command can be interjected during voice output of the system.

### Activating/deactivating online voice control

▶ Activate **Online Voice Control**.

ⓘ Online voice control is activated at the factory.



- ▶ Select [Online Voice Control Subscr..](#)  
You will be connected with the Mercedes me portal.
- ▶ Activate online voice control in the Mercedes me portal.

### Activating contacts for online use

- ▶ Select [Contacts for Online Use](#).  
When the function is active, contacts will be found more easily and accurately using voice input. The quality of the enunciation of contact names by the system will also be improved.



### Using the Voice Control System effectively

#### Voice Control System audible help functions

Using the corresponding voice commands you receive the following information and assistance in the following cases:

- **For optimal operation:** say the Voice control tutorial voice command or call up the Digital Operator's Manual with Could you go to the Voice Control System tutorial please?,

for example. The full extent of the Digital Operator's Manual is available when the vehicle is stationary. Here you can also find explanatory videos which introduce you to the functions of the Voice Control System.

- **Current application:** on the multifunction steering wheel, press the  rocker switch up and say the Help voice command. You will receive suggestions and information about operation of the Voice Control System for the current application.
- **Continued dialog:** say the Help voice command during a voice dialog. For every step of the dialog you receive matching information.
- **Specific function:** say the voice command for the desired function, e.g. with "Hello Mercedes, I need help with the radio" or after pressing the  rocker switch on the multifunction steering wheel up, say the Help for the telephone voice command, for example.

### Notes on optimal use of the Voice Control System

Notes on how to improve recognition:

- Activate online voice control (→ page 224).
- Only operate the Voice Control System from the driver's seat.
- Say the voice commands coherently and clearly, but do not exaggerate the words.
- Avoid loud noises that cause interference while making a voice command entry, e.g. the entertainment in the rear passenger compartment.
- **For telephone or address book entries:**
  - Only create sensible address book entries in the system/mobile phone, e.g. enter surname and first name in the correct field.
  - Do not use any abbreviations, unnecessary spaces or special characters.
- **For radio station names:** say the Read out station list voice command and say the desired station name in the way the voice output reads aloud to you.

- ❗ To improve recognition, depending on the outside temperature, either the blowers for ventilation or heating are reduced when the Voice Control System is started.

### Notes on online voice control

Online voice control improves recognition and makes additional results available as a result of external information, e.g. information about POIs and about the weather. We therefore recommend that you activate online voice control.

You will need a Mercedes me user account for this. If you do not yet have a user account you have to create one and connect it with your vehicle (→ page 255).

### Switch voice commands

Voice command	Colloquial example	Function
Switch to navigation	I would like to go to navigation	Switches to navigation
Switch to address book	I would like to switch to the address book	Switches to the address book

Then call up your Mercedes me user account. The Mercedes me services are shown and can be activated (→ page 256).

In addition, online voice control must be activated (→ page 224).

### Essential voice commands

#### Notes on the voice commands

Aside from the exact voice commands (see the "Voice command" column in the following tables) to call up specific functions, in most cases the Voice Control System also understands a great many paraphrases from daily usage. Examples of these are listed in the "Colloquial examples" col-

umn. For some languages however these examples are only available to a limited extent.

- ❗ Content in angled brackets, e.g. <POI> or <contact>, is a placeholder which has to be completed by you with the desired term. The voice command: Set <POI> as intermediate destination could, for example, be completed with: Set Mercedes-Benz Arena as intermediate destination.

### Overview of switch voice commands

Switch voice commands can be used to open certain applications.

Voice command	Colloquial example	Function
Switch to telephone	I would like to switch to the phone	Switches to the telephone
Switch to messages	Can you switch to messages please?	Switches to the text message application.
Switch to radio	I would like to switch to the radio	Switches to radio
Switch to media	I would like to switch to the media application	Switches to media
Switch to comfort	I would like to go to the comfort application	Switches to the comfort settings
Switch to vehicle info	I would like to go to the vehicle application	Switches to vehicle information
Switch to settings	I would like to go to the settings menu	Switches to the menu with the setting options

**i** It is not necessary to first call up a menu in order to operate a function it contains with the Voice Control System. You can operate the function directly using voice input, e.g. call a contact or enter a destination for navigation.

You can find further information in the overview tables for voice commands.

### **Overview of navigation voice commands**

Using the navigation voice commands you can enter POIs and conventional addresses or navigate to your own contacts. You can also carry out important navigation settings directly. The

following list offers just a small selection of the possible navigation commands. You will receive

additional suggestions if you say Help for navigation.

### Navigation voice commands

Voice command	Colloquial example	Function
Navigate to <address>	Navigate to Canal Street, New York	Starts route guidance to the desired address.
Navigate to <contact>	Drive/bring me to the contact address of John Doe	Starts route guidance to a contact from the address book.

Voice command	Colloquial example	Function
Navigate to <3 word address>	<p>The example is for the English language: Drive to Parade.Help.Bleat</p>	<p>Starts route guidance to a 3 word address from what3words. The example mentioned navigates you to the Empire State Building. Observe the following information:</p> <ul style="list-style-type: none"> <li>• 3 word addresses are language dependent.</li> <li>• Searching for a destination using 3 word addresses is not possible in all countries and in all languages. Additional information on 3 word addresses from what3words can be found in the Navigation section under "Entering the destination as a 3 word address".</li> </ul> <p>The Empire State Building, for example, has the following 3 word addresses:</p> <ul style="list-style-type: none"> <li>• English: <b>parade.help.bleat</b></li> <li>• French: <b>commun.verbe.bisquer</b></li> <li>• Spanish: <b>suertes.diga.pesca</b></li> </ul>
Home	I would like to go home/I want to drive to my home address	Starts route guidance to the home address.
Work	I would like to navigate to work	Starts route guidance to work.
Enter POI	Take me to a POI	Enters a POI, e.g. Brandenburg Gate.
Navigate to <POI>	Navigate to "McDonald's"	Starts route guidance to a POI.

Voice command	Colloquial example	Function
Navigate to the online POI <POI>	Navigate to online POI "McDonald's"	Searches online for a POI and starts route guidance.
Start route guidance	Begin route guidance/Can you start route guidance?	Starts route guidance to a destination.
Cancel route guidance	Can you quit route guidance?	Cancels route guidance.
Restart route guidance	I would like to resume route guidance	Continues route guidance after a break.
Set <address> as intermediate destination	Set "9 Euclid Avenue in Cleveland" as an intermediate destination	Selects an intermediate destination for the route.
Set <contact> as intermediate destination	Set "John Doe" as intermediate destination	Selects an intermediate destination from the contacts for the route.
Set <POI> as intermediate destination	Set "Trump Tower" as an intermediate destination	Selects a POI as an intermediate destination for the route.
Enter address in <country>	I would like to enter a new address in "France"	Selects a destination in another country.
Enter ZIP code	Start route guidance to a new ZIP code	Enters a ZIP code.
Last destinations	Show the previous destinations	Selects a destination from the previous destinations.

Voice command	Colloquial example	Function
Show alternative routes	Search for alternative routes	Shows one of the alternative routes calculated.
Driving recommendations on	Switch on driving recommendations	Switches on voice output for route guidance.
Driving recommendations off	Mute the driving instructions	Switches off voice output for route guidance.
Show traffic map	Switch on traffic jam info	Displays traffic information on the map.
Hide traffic map	Switch off the traffic jam messages	Hides the traffic information.
POI icons on	Show me point of interest icons on the map please	Displays the POI symbols on the map.
Hide POI icons	I would like to hide all POI symbols	Hides the POI symbols.

### Overview of telephone voice commands

You can use the telephone voice commands to make phone calls or search through the address

book. The following list offers just a small selection of the possible telephone commands. You

will receive additional suggestions if you say Help for phone.

**Telephone voice commands**

<b>Voice command</b>	<b>Colloquial example</b>	<b>Function</b>
Call <telephone number>	I would like you to dial 0171xxxxxxx	Makes a telephone call by entering the telephone number directly.
Call <contact>	Call Jane Doe on her mobile	Makes a telephone call directly by entering a name from the address book.
Call Mercedes-Benz emergency call center	Could you call the Mercedes-Benz emergency center?	Triggers an emergency call to the Mercedes-Benz emergency call center.
Call Mercedes me	I'd like you to call the MB breakdown assistance please	Places a call with Mercedes-Benz breakdown assistance.
Latest calls	Show me the list of missed calls	Shows the list of missed calls.
Previous calls	Show me the last calls	The list shows all outgoing, incoming and missed calls.
Incoming calls	Show me the calls received	Shows the list of incoming calls.
Outgoing calls	Show me the list of outgoing calls	Shows the list of outgoing calls.
Search for <contact>	Could you open the contact "John Doe"?	Opens the contact data of a contact in the address book.



Voice command	Colloquial example	Function
Redial	Redial/Call last phone number	Makes a call to the last telephone number dialed.
Change phone	Could you please switch to the second phone?	Changes the primary telephone

### Overview of media player voice commands

Media player voice commands can also be used when the media player application runs in the

background and another application is visible in the foreground. The following list offers just a small selection of the possible media player

voice commands. You will receive additional suggestions if you say Help for media or Help for player.

### Media player voice commands

Voice command	Colloquial example	Function
Play <track/albums/artists/composers/music genres>	Play "Yellow Submarine"	The names of all available tracks, albums, artists, composers or genres are accepted during the search. In the case of a clear search result the track found is played back immediately.
Play track <track>	Play song "So What"	The available tracks are played back.
Play album <album>	Play album "A Night at the Opera"	The available albums are played back.
Play artist <artist>	I want to listen to the artist "Madonna"	The available artists are played back.

Voice command	Colloquial example	Function
Play composer <composer>	I'd like to hear the composer "Ludwig van Beethoven"	The available composers are played back.
Play music genre <music genre>	I'd like to hear the music genre "Rock"	The available music genres are played back.
Search for track <track>	I would like to search for the song "Sailing"	The names of all available tracks are accepted during the search. A selection list appears from which you can select the desired music. If you wish to play all the tracks in a selection list, say "Play all tracks".
Search for album <album>	Search for album "A Night at the Opera"	The names of all available albums are accepted during the search. A selection list appears from which you can select the desired music. If you wish to play all the tracks in a selection list, say "Play all tracks".
Search for artist <artist>	I would like to search for the artist "Elton John"	The names of all available artists are accepted during the search. A selection list appears from which you can select the desired music. If you wish to play all the tracks in a selection list, say "Play all tracks".
Search for composer <composer>	Search for composer "Beethoven"	The names of all available composers are accepted during the search. A selection list appears from which you can select the desired music. If you wish to play all the tracks in a selection list, say "Play all tracks".
Search for music genre <music genre>	Search for music genre "Pop"	The names of all available music genres are accepted during the search. A selection list appears from which you can select the desired music. If you wish to play all the tracks in a selection list, say "Play all tracks".

Voice command	Colloquial example	Function
Next track	Start the next song/video clip/film	Plays back the next track.
Previous track	Play the last song/track/clip again	Plays back the previous track.
Repeat this track	I'd like to listen to this track again	The current track is played back from the beginning.
Play similar music	I'd like to hear similar music	Plays back similar tracks.
Play random music	Play me a random track	Plays back random tracks.
Random playback on	Turn random playback on	Switches to random mode.
Random track list off	Switch off shuffle mode	Switches off random mode.
What am I listening to?	Which music is currently playing?	The information about the track currently playing is read aloud.

### Overview of message voice commands

Messages can be created, edited and listened to using the message voice commands. The follow-

ing list offers just a small selection of the possible message commands. You will receive additional suggestions if you say Help for messaging.

**Message voice commands**

Voice command	Colloquial example	Function
Text message to <Name>	I would like to write a new text to John Doe's mobile number	Creates a text message. All address book names are available.
Text message to <Name> <Text>	Write a new text message to Ms. Anne Harvey, business: "When is the next meeting?"	To write a text message to the person mentioned. The content of the text can be spoken immediately if online voice control has been activated.
Read out new text messages	Read out all new texts	Reads out new text messages.
Read out the last text message from <Name>	Read out last text message from "John, private"	Reads out the last text message from the person mentioned.

**Overview of vehicle voice commands**

You can use the vehicle voice commands to directly call up the corresponding menus for the vehicle settings and operate vehicle functions.

The following list offers just a small selection of the possible vehicle voice commands. You will receive additional suggestions if you say Help for vehicle settings or Help for vehicle functions.

- ① If no seat or side is mentioned for commands that relate to a seat or side of vehicle

then all actions are carried out automatically for the driver's seat.

**Vehicle voice commands**

Voice command	Colloquial example	Function
Temperature colder	I would like to reduce the temperature	Lowers the temperature of the air conditioning system.
Air recirculation on	I would like to activate the air circulation	Switches on air recirculation mode for the air conditioning system.
Automatic climate control driver on	I would like to switch on the automatic climate control for the driver's seat	Switches on automatic climate control for the driver's or front passenger side.
Ambient light blue	Switch ambient light to blue	Switches the ambiance light, e.g. to blue.
Wave massage driver on	I would like to switch on the wave massage for the driver's seat	Switches on the wave massage for the driver's or front passenger seat.
Massage driver's seat off	Switch the driver's side massage off	Switches off the massage function for the driver's or front passenger seat.
Seat heating driver on	I would like to switch on the seat heating for the driver's seat	Switches on the seat heating for the driver's or front passenger seat.
Seat heating front passenger level 2	Seat heating front-passenger on level 2	Sets the seat heating for the driver's or front passenger seat to level 2.

Voice command	Colloquial example	Function
Current speed limit	I would like to hear the speed limit	Calls up the current speed limit.
Outside temperature	I would like to find out what the temperature outside is like	Calls up the outside temperature.
Average consumption	I would like to know the average fuel consumption	Calls up average consumption.
Vehicle data	Can you please display the vehicle data menu?	Calls up the vehicle data.
Range	Tell me the current range	Calls up the current range data.
Assistance menu	Show me the driver assistance settings	Displays the assistance settings.
Climate control menu	Jump to the climate control menu	Displays the climate control settings.
Light menu	Switch to the light settings	Displays the light settings.
Seats menu	I would like to switch to seat menu	Displays the seat adjustment settings.

Voice command	Colloquial example	Function
Massage menu	Could you please switch to the massage seat menu?	Displays the massage settings.
Next service	Tell me my next service appointment	Calls up the next service due date.

## Overview and operation

### Overview of the MBUX multimedia system

**⚠ WARNING** Risk of distraction from information systems and communications equipment

If you operate information and communication equipment integrated in the vehicle when driving, you will be distracted from the traffic situation. This could also cause you to lose control of the vehicle.

- ▶ Only operate this equipment when the traffic situation permits.
- ▶ If you cannot be sure of this, stop the vehicle whilst paying attention to road and traffic conditions and operate the equipment with the vehicle stationary.

You must observe the legal requirements for the country in which you are currently driving when operating the multimedia system.

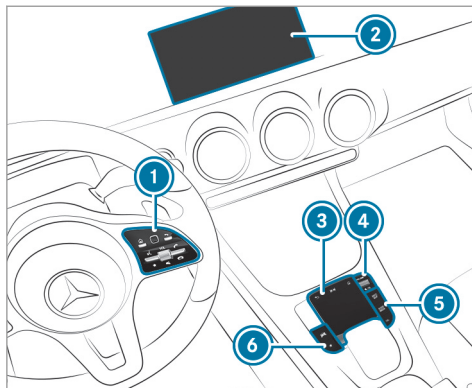

- ① Touch Control and control panel for the MBUX multimedia system  
Operating Touch Control (→ page 244)
- ② Media display with touch functionality  
Home screen overview (→ page 242)  
Operating the touchscreen (→ page 245)
- ③ Touchpad  
Operating the touchpad (→ page 246)

- ④ Control knob  
Press and hold: switches the multimedia system or media display on or off  
Press briefly: switches the mute function on/off  
Turn: adjusts the volume
- ⑤ Buttons for navigation, radio/media and telephone  
Calling up applications (→ page 253)
- ⑥ Buttons for vehicle functions/system settings and favorites/themes  
Calling up applications (→ page 253)



You can operate the MBUX multimedia system with the following central control elements:

- Touch Control ① and touchpad ③  
The operation for both control elements is achieved by cursor control.
- Media display ②
- ⓘ Alternatively, you can conduct a dialog with the Voice Control System (→ page 223).



Numerous application, online services, services and apps are available for you. You can call



these up using the home screen or using buttons 5 and 6 next to the touchpad.

You can conveniently call up and add favorites using the  rocker switch on the steering wheel or using the  button next to the touchpad. Quick-access in the home screen and in the applications serve to select functions more quickly.

If you use the learn function of the multimedia system, you will receive suggestions during operation of the most probable navigation destinations, radio stations and contacts. The configuration of the suggestions takes place in your profile. You can compile your profile from various vehicle settings and settings of the multimedia system. You can create themes for various driving situations in the home screen as well as

using the  rocker switch or the  button.

The Notifications Center collects incoming notifications, e.g. about an available software update. Depending on the type of notification it offers various actions. You can call up the Notifications Center on the home screen and in the application menus.

With the global search in the vehicle you can search on-board across many categories as well as online in the Internet. You can use the global search in the home screen and in the notifications.

#### Protection against theft

This device is equipped with technical provisions to protect it against theft. Further information on

protection against theft can be obtained from an authorized Mercedes-Benz Center.

#### Notes on the media display

Observe the notes on caring for the interior (→ page 392).

**Automatic temperature-controlled switch-off feature:** if the temperature is too high, the brightness is initially reduced automatically. The media display may then switch off completely for a while.

-  If you are wearing polarized sunglasses, it may be difficult to read the multimedia system display.

## Home screen overview

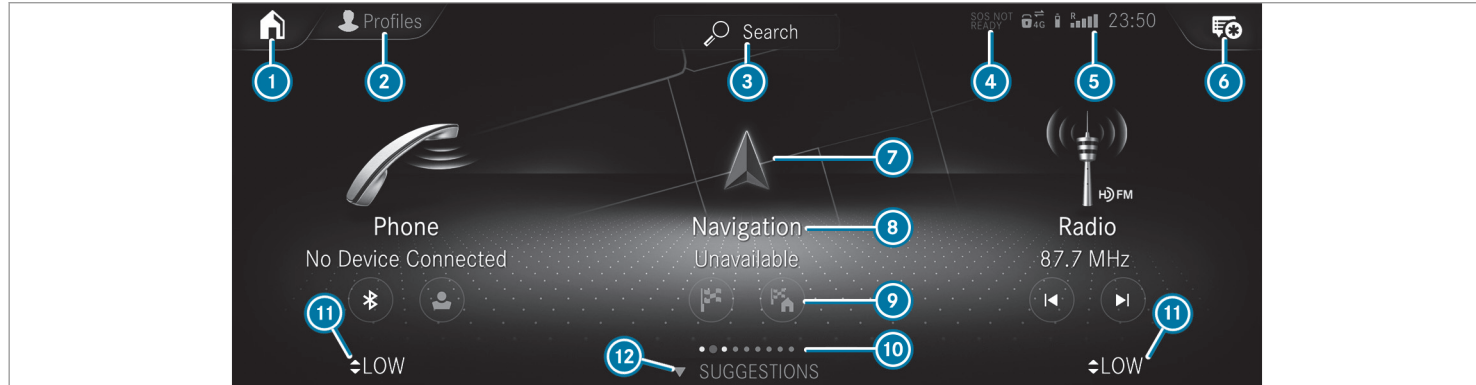

- ① On the home screen: displays the first three applications  
In other displays: calls up the home screen
- ② Calls up the profile
- ③ Calls up the global search

- ④ SOS NOT READY display only when the Mercedes-Benz emergency call system is not available
- ⑤ Displays, for example network display, battery status of the mobile phone connected,

signal strength of the mobile phone network, time

- ⑥ Calls up the Notifications Center  
The star indicates new notifications.
- ⑦ Calls up an application using the symbol

- ⑧ Name of the application, beneath the current selection or information
- ⑨ Quick-access (in the example: calls up destination entry, enters the destination address for home)
- ⑩ Number of applications and currently selected display area
- ⑪ Calls up the air conditioning menu (→ page 126)
- ⑫ Calls up **SUGGESTIONS**, **THEMES** and **FAVORITES**

### Central control elements overview

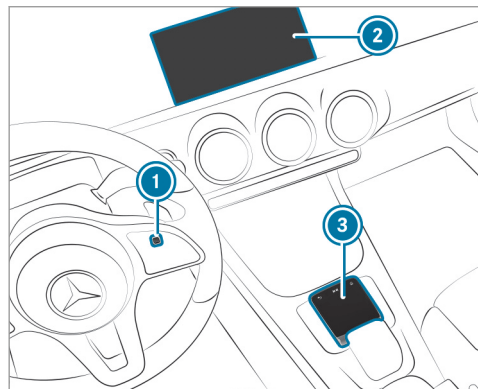

- ① Touch Control
- ② Media display with touch functionality
- ③ Touchpad



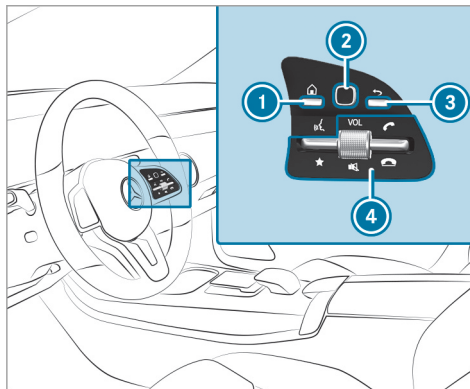

### Touch Control

#### Operating Touch Control (MBUX multimedia system)



- ①  button  
Shows the home screen and calls up applications

Shows suggestions, themes and favorites: when the home screen is shown, swipe down on Touch Control ②.

- ② Touch Control
- ③  button  
Press briefly: returns to the previous display
- ④ Control panel for MBUX multimedia system:
  -  rocker switch  
Press down briefly: shows favorites
  - Press down and hold: adds favorites and themes
  - Control knob  
Turn: adjusts the volume VOL
  - Press: switches off the sound 
  -  rocker switch  
Press up: makes or accepts a call
  -  rocker switch  
Press down: rejects or ends a call

You can navigate in menus and lists via the touch-sensitive surface of Touch Control ② by using a **single-finger swipe**.

- ▶ **To select the menu item or entry:** swipe up, down, left or right.
- ▶ Press Touch Control .
- ▶ **To enter a character:** enter a character using the keyboard.
- ▶ **To move the digital map:** swipe in any direction.

### Setting the sensitivity for the Touch Control

Multimedia system:

- ▶  ▶ Settings ▶ System
- ▶ ▶ Controls ▶ Touch Control Sensitivity
- ▶ Select **Fast**, **Medium** or **Slow**.

### Setting acoustic operating feedback for the Touch Control

Multimedia system:

- ▶  ▶ Settings ▶ System
- ▶ ▶ Controls

The function is supported by the selection in a list.

- ▶ Select **Acoustic Operating Feedback**.

- ▶ Set **Normal**, **Loud** or **Off**.  
If the function is activated you will hear a clicking sound when scrolling in a list. When the beginning or end of the list is reached you will hear another clicking sound.

## Touchscreen

### Operating the touchscreen

#### Tapping

- ▶ **To select a menu item or entry:** tap on a symbol or an entry.
- ▶ **To increase the map scale:** tap twice quickly with one finger.
- ▶ **To reduce the map scale:** tap with two fingers.
- ▶ **To enter characters with the keypad:** tap on a button.

#### Single-finger swipe

- ▶ **To navigate in menus:** swipe up, down, left or right.

- ▶ **To move the digital map:** swipe in any direction.
- ▶ **To use handwriting to enter characters:** write the character with one finger on the touchscreen.

#### Two-finger swipe

- ▶ **To zoom in and out of the map:** move two fingers together or apart.
- ▶ **To enlarge or reduce the size of a section of a website:** move two fingers together or apart.
- ▶ **To turn the map:** turn counter-clockwise or clockwise using two fingers.

#### Touching, holding and moving

- ▶ **To move the map:** touch the touchscreen and move your finger in any direction.
- ▶ **To set the volume on a scale:** touch the touchscreen and move the finger to the left or right.

## Touching and holding

- ▶ **To save the destination in the map:** touch the touchscreen and hold until a message is shown.
- ▶ **To call up a global menu in the applications:** touch the touchscreen and hold until the **OPTIONS** menu appears.

## Setting acoustic operation feedback for the touchscreen

Multimedia system:

-  ▶ Settings ▶ System
- ▶▶ Controls



The function is supported by the selection in a list.

- ▶ Select **Acoustic Operating Feedback**.
- ▶ Set **Normal**, **Loud** or **Off**.  
If the function is activated you will hear a clicking sound when scrolling in a list. When the beginning or end of the list is reached you will hear another clicking sound.

## Touchpad

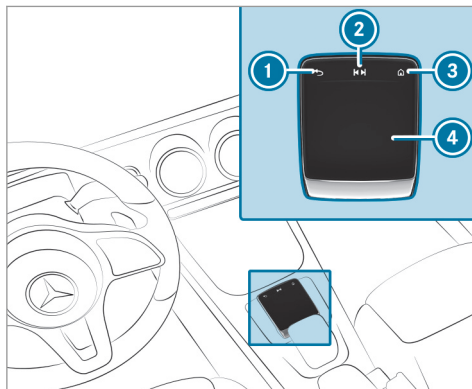
### Operating the touchpad



- ①  button  
Pressing briefly: returns to the previous display
- ②  button

Pressing: calls up the control menu of the last active audio source

Swiping to the left of right across :  
selects the previous or next radio station/  
music track

- ③  button  
Pressing: shows the home screen and calls up applications
- ④ Touchpad
- ① Calls up suggestions, themes and favorites: when the home screen is shown, swipe down on touchpad ④.

You can navigate in menus and lists via the touch-sensitive surface of touchpad ④ by using a **single-finger swipe**.

- ▶ **To select the menu item or entry:** swipe up, down, left or right.
  - ▶ Press touchpad ④.
  - ▶ **To enter a character:** enter a character using the keyboard.
- or
- ▶ Write a character on the touchpad.

- ▶ **To move the digital map:** swipe in any direction.

#### Use the following functions with a two-finger swipe:

- ▶ **To call up the Notifications Center:** swipe down with two fingers.
- ▶ **To close the Notifications Center:** swipe up with two fingers.
- ▶ **To call up the control menu of the last active audio source:** swipe up with two fingers.
- ▶ **To zoom in and out of the map:** move two fingers together or apart.
- ▶ **To enlarge or reduce the size of a section of a website:** move two fingers together or apart.

#### Setting the sensitivity for the touchpad

Multimedia system:

- ▶  ▶ Settings ▶ System
- ▶▶ Controls ▶▶ Touchpad Sensitivity
- ▶ Select **Fast**, **Medium** or **Slow**.

- ▶ **To set the pressure sensitivity:** switch **Touchpad Tap** on or off.  
If the function is switched on, a tap on the touchpad is enough to select a menu item.

#### Switching the read-aloud function for handwriting recognition on/off

##### Requirements:

- The multimedia system is equipped with a voice control system.
- The read-aloud function is available for the selected system language.

Multimedia system:

- ▶  ▶ Settings ▶ System ▶ Audio
- ▶▶ System Feedback
- ▶ Switch **Read Out Handwriting Recognition** on or off.  
If the function is activated, characters are read aloud as they are written on the touchpad.

#### Activating/deactivating haptic operating feedback for the touchpad

Multimedia system:

- ▶  ▶ Settings ▶ System
- ▶▶ Controls

The function supports you when making entries on the touchpad and when selecting menus.

- ▶ Switch **Haptic Operating Feedback** on or off.  
When the function is activated, a tactile feedback in the form of a vibration is effected when the touchpad is operated.

#### Setting acoustic operating feedback for the touchpad

Multimedia system:

- ▶  ▶ Settings ▶ System
- ▶▶ Controls

The function is supported by the selection in a list.

- ▶ Select **Acoustic Operating Feedback**.
- ▶ Set **Normal**, **Loud** or **Off**.  
If the function is activated you will hear a clicking sound when scrolling in a list. When

the beginning or end of the list is reached you will hear another clicking sound.

### Selecting a station and track using the touchpad

▶ Swipe to the left or right over the  button.

Radio: the previous or next station is set.

Media source: the previous or next track is selected.

or

▶ **To show the control menu:** press the  button on the touchpad.

or

▶ Swipe upwards using two fingers on the touchpad.

The control menu appears for the audio source that was last selected.

▶ Swipe left or right using one finger.

Radio: the previous or next station is set.

Media source: the previous or next track is selected.

▶ **To hide the control menu:** swipe down on the touchpad using two fingers.

### MBUX in-car assistant

#### Notes on lasers and laser classification

 **WARNING** Risk of injury from laser radiation from the camera

This product uses a laser system. If the housing is opened or damaged, invisible laser beams can escape in an uncontrolled manner.

Laser radiation can damage your retina.

▶ Do not open the housing.

▶ Always have maintenance work and repairs carried out by a qualified specialist workshop.

This product complies with the requirements of the FDA 21 CFR 1040.10 and 1040.11 with exception of the variations according to the FDA Laser Notice No. 50 from 24. June 2007.

#### Overview of the MBUX in-car assistant

If the vehicle is equipped with the MBUX in-car assistant, selected functions of the multimedia system can be operated contact-free. In addition, the reading light or search light can be switched on or off contact-free.

The MBUX in-car assistant can differentiate between driver and front passenger interactions.

The MBUX in-car assistant recognizes certain hand positions (poses).



**The MBUX in-car assistant supports the following interactions:**

Interaction area	Interaction	Description
In front of the media display/above the touch-pad	Proximity to the control element	<p>The MBUX in-car assistant recognizes the approach of the hand towards a control element.</p> <p>Depending on the active application, the display will be adjusted in the media display. Some functions differentiate between driver and front passenger.</p> <p>No specific hand position is required.</p>
Above the center console	Defined poses	<p>With defined poses a function is triggered depending on the application active.</p>
Below the inside rearview mirror	Brief up and down movements	<p>With brief vertical up and down movements below the inside rearview mirror the reading light for the driver or the front passenger is switched on and off.</p>
Front passenger seat	Stretching out the hand above the front passenger seat	<p>By stretching out the hand above the front passenger seat the search light is switched on. If the hand is withdrawn from this area, the search light is switched off again.</p>

## Operating functions by proximity of the hand to the touchscreen and touchpad

### Requirements:

- One of the following applications appears in the media display:
  - Seat settings with displays for the driver and front passenger seat, e.g. [Seat Comfort](#)
  - Home screen
  - Radio menu or media menu
  - Map in the navigation
  - Active Parking Assist
- Recognition occurs as the hand approaches to approximately (10 cm) from the touchpad or the touchscreen.

### Seat adjustments by the driver or front passenger

In the seat settings menu, the MBUX in-car assistant detects proximity to various control elements of the multimedia system. In addition, the MBUX in-car assistant detects from which seat the action emanates.

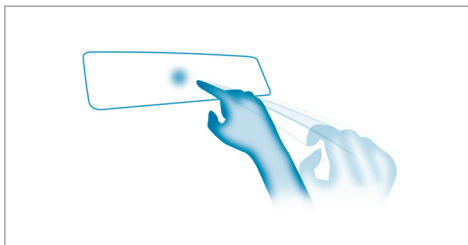

Hand approaching the touchscreen



Hand approaching the touchpad

- ▶ With the seat setting display active, move the hand towards the touchscreen or touchpad. The seat of the person operating, driver's seat or front passenger seat, is enlarged in the media display.

The appropriate control elements are pre-selected automatically.

- ▶ Depending on the function, the person operating can either switch the function on or off directly or make other settings.

### Highlighting an application on the home screen

The MBUX in-car assistant detects in which area the hand is in front of the touchscreen. The display of objects shown is adjusted to improve orientation.

- ▶ Move a hand towards the touchscreen. The symbol for the application is enlarged. The quick-access applications will be highlighted.
- ▶ Continue operation, e.g. select a quick-access application.

**i** Further information about the home screen (→ page 242).

### Activating cover change in the radio menu and media menu

The MBUX in-car assistant reduces the number of operating steps.

- ▶ Move a hand towards the touchscreen or touchpad.  
The current information, e.g. about the radio station, track and artist are hidden. Cover change is activated.
  - ▶ Continue operation and select a cover.
  - ▶ As the hand is moved away from the touchscreen or touchpad, the current information is shown again.
- ⓘ Further information on the radio menu (→ page 368) and the media menu (→ page 363).

### Showing the navigation menu on the map

The MBUX in-car assistant shows the navigation menu.

- ▶ Move a hand towards the touchscreen or touchpad.  
The navigation menu is shown.
- ▶ Continue operation and select a symbol.

- ▶ As the hand is moved away from the touchscreen or touchpad, the media display hides the navigation menu.

ⓘ Further information on the navigation menu (→ page 286).

### Showing operating symbols in the Active Parking Assist camera image (only from driver's seat)

The MBUX in-car assistant facilitates quick-access for the driver to various camera views.

- ▶ With the Active Parking Assist display active, move the hand in the direction of the touchscreen.  
The camera operation symbols are displayed.
  - ▶ Continue operation and display the desired front, rear, left and right camera views.
- ⓘ Further information on Active Parking Assist functions (→ page 192).

### Operating functions using poses

#### Requirements:

- **To call up favorites:** there is at least one favorite.

- The area for recognition of the favorite's pose is above the center console at the height of the climate control vents and the media display. The hand should have a distance of at least (10 cm) from the media display.
- The pose is held for a brief time.

#### Calling up favorites

A pose calls up a favorite.

The driver and front passenger can connect two different favorites with the V pose.

- ⓘ If a favorite has not yet been saved and connected with the MBUX in-car assistant, the multimedia system will assist you.



Carrying out the V pose

- ▶ Position the hand above the center console and in the direction of the media display. The back of the hand is facing upwards. In doing so the index and middle finger are extended with the other fingers bent inwards. The favorite is called up.

### Switching the reading light for the driver and front passenger on/off

#### Requirements:

- The function is available when it is dark.
- The gesture is carried out in the interaction area (under the inside rearview mirror).

Briefly moving the hand up and down under the inside rearview mirror switches the reading light specifically for the driver or front passenger on or off.



Carrying out operation of the reading light

- ▶ Move the hand up and down vertically under the reading light. The reading light is switched on or off.

### Settings for the MBUX in-car assistant

Multimedia system:





➔  ➔ Settings ➔ System  
➔ Interior Assistant

- ▶ **To switch on full functionality of the MBUX in-car assistant:** select **On**. The option is activated ●.
- ▶ **To activate additional functions for reading and search lights:** select **Including Reading Light**. When the option is switched on, the display button is activated. The functions for the reading and search lights are activated in addition to the proximity functions.
- ▶ **To switch off the MBUX in-car assistant:** select **Off**. The option is activated ●.

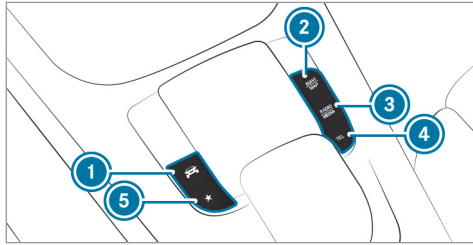
## Main functions

### Calling up applications



- 1  button  
Calls up vehicle functions
- 2  button  
Calls up navigation
- 3  button  
Calls up radio or media
- 4  button  
Calls up the telephone
- 5  button

Press briefly: calls up favorites  
(→ page 261)

Press and hold: adds a favorite  
(→ page 261) or creates a new theme  
(→ page 257)

**Alternatively in the home screen:** when you start the vehicle the home screen is shown in the media display.

- ▶ Select the application by swiping and tapping.

or



- ▶ **In any display:** press the  button on the Touch Control or on the touchpad.

or

- ▶ Tap on the  symbol on the touchscreen. The applications are displayed.
- ▶ Select the application by swiping and tapping.

### Changing the arrangement of applications on the home screen

- ▶ Call up the home screen.

- ▶ Touch and hold an application on the touchscreen until symbols appear.
- ▶ Tap on  or  and move the application in the menu.
- ▶ Tap on .

## Profile

### Notes on profiles

**⚠ WARNING** Risk of becoming trapped during adjustment of the driver's seat after calling up a driver profile

Selecting a profile may trigger an adjustment of the driver's seat to the position saved under the profile. You or other vehicle occupants could be injured in the process.

- ▶ Make sure that when the position of driver's seat is being adjusted using the multimedia system, no people or body parts are in the seat's range of movement.

If there is a risk of someone becoming trapped, stop the adjustment process immediately:

- ▶ a) Tap the warning message on the media display.

or

- ▶ b) Press a memory position button or a seat adjustment switch on the driver's door.  
The adjustment process is stopped.

The driver's seat is equipped with an anti-entrapment feature.

If the driver's door is open, the driver's seat will **not** be set after calling up the driver's profile.

### Overview of profiles

Using the multimedia system up to seven profiles can be created in the vehicle.

Profiles store your personal vehicle settings and settings for the multimedia system.

If the vehicle is used by several drivers, the driver can select their profile before the journey, without changing the settings of other drivers.

You can select the profile:

- when entering (→ page 256)
- using the home screen (→ page 242)

The profile settings are activated as soon as a profile is selected.

**i** If you call up your profile when driving then the driver's seat position will not be adjusted.

You can cancel the setting process with the following actions:

- Tap on the [Positioning Seat and Steering Wheel... Please tap to cancel.](#) warning on the media display.
- Press one of the seat operating buttons in the driver's door.

### Profile content

Depending on the vehicle equipment, the following settings can be stored in your profile, for example:

- Driver's seat memory
- Radio (including station list)

- Last destinations
  - Climate control
  - Ambient lighting
  - DYNAMIC SELECT I (individual)
  - Instrument Display, Head-up Display and style (display style of the multimedia system)
  - Themes, suggestions and favorites
- i** Settings for driver assistance systems cannot be saved in the profile.

### Mercedes me connect profile

If you use a profile from Mercedes me connect, the following online functions are available, for example:

- You can configure the settings in the vehicle using the Mercedes me app and the Mercedes me portal.
- You can synchronize your profile on Mercedes me connect with the profile in the vehicle (→ page 256).
- You can add a personal profile photo that is shown in the vehicle.

- You can take your profile and some of your settings with you in new vehicles.

### Requirements for using Mercedes me connect profiles:

For the vehicle owner:

- You have a Mercedes me user account.
- The vehicle has been connected with the user account.
- The personalization service is activated.

For additional users of the vehicle:

- You have a Mercedes me user account.
- The vehicle owner has invited you to connect your user account on Mercedes me with that of his vehicle.
- You have accepted the invitation.

### Creating a new profile

Multimedia system:

   Profiles

- ▶ Select  **Create Profile.**
- ▶ Select an avatar.

▶ Enter the name and confirm with .

▶ Select **Continue** .

▶ **To save the current settings in a profile:** select **Current Settings.**

▶ Select **Save.**

or

▶ **To adopt the factory settings:** select **Factory Settings.**

▶ Select **Save.**

ⓘ Further information on setting a user profile (→ page 255).

▶ Activate Bluetooth® and select **Connect Phone**, to connect a mobile phone with the user profile (→ page 329).

You can also set up a user profile without registering a mobile phone.

▶ Select **Finish.**  
The user profile is saved.

### Selecting profile options

Multimedia system:

   Profiles

▶ Select  for a profile.

▶ **To edit a profile:** select **Edit Profile.**

▶ Select an avatar.

▶ Change the name, if necessary.

▶ Select **Save.**

▶ **To configure suggestions:** select **Suggestion Settings** (→ page 260).

▶ **To reset favorites or themes:** select **Reset Favorite to Factory Settings** or **Reset Themes to Factory Settings.**

▶ Select **Yes.**

▶ **To reset a profile:** select **Reset Profile to Factory Settings.**

▶ Select **Yes.**

▶ **To delete a profile:** select **Delete Profile.**

▶ Select **Yes.**

ⓘ The guest profile cannot be deleted.

### Protecting profile content

To protect your profile content and settings you can create a PIN in the Mercedes me portal for your profile. When PIN protection is active, you have to enter the PIN to select your profile.

- ▶ Select [Protect Content](#).
- ▶ Select [Mercedes me portal](#).  
The browser opens and you are transferred to the Mercedes me portal.

### Selecting a profile

Multimedia system:



- ⓘ You can cancel the setting process with the following actions:
  - Tap on the [Positioning Seat and Steering Wheel... Please tap to cancel](#) warning on the media display.
  - Press one of the seat operating buttons in the driver's door.
- ▶ Select a profile.
- ▶ Press the  button to confirm the message.  
The profile is loaded and activated.

- ⓘ Alternatively, the profile can already be selected when the vehicle is entered (→ page 256).

### Synchronizing a profile

#### Requirements:

- You have a Mercedes me user account.
- The vehicle is connected with your Mercedes me user account.
- The personalization service is activated on Mercedes me connect.

Multimedia system:



▶ [General Settings](#)

Synchronization enables the following:

- You can configure the vehicle settings using the Mercedes me app.
- The profile on Mercedes me connect and the profile in the vehicle are aligned (profile management).

- ▶ Activate [Synchronize Profiles Automatically](#).  
The profiles in the vehicle are automatically synchronized with the profiles on Mercedes me connect when the ignition is switched on and off.

or

- ▶ Select [Synchronize Profiles Now](#).  
After selecting this option, the profiles in the vehicle are synchronized with the profiles on Mercedes me connect.

- ⓘ During synchronization the profile list and the profile functions are blocked.
- ⓘ **Note on data protection:** if you do not wish to share your data with Mercedes me, make sure that the automatic synchronization is switched off and do not select [Synchronize Profiles Now](#).

### Showing the profile selection when entering

#### Requirements:

- At least one profile has been created.



Multimedia system:



If the option is activated, you can see a profile as soon as you get in.

- ▶ Select **General Settings**.
- ▶ Activate **Show Profile Selection When Getting In**.  
When the vehicle is started, the media display shows the active profile.

## Themes

### Overview of themes

You can configure the vehicle settings according to your preferences and save as a theme. A theme can be called up any time via the home screen. There is then no need to make the desired settings again.

There are pre-defined themes available, e.g. Journey, Efficiency and Lounge.

### Example for the use of themes

For recurring driving situations, such as long drives on the freeway, you can save your preferred settings in a theme in the vehicle.

You can save the following settings in a theme, for example:

- Displays (e.g. navigation map or tachometer)
- Preferred radio station
- Favored drive program

These settings are saved under the name you wish when setting up a theme (→ page 257). On the next freeway journey you can select this theme and thereby restore your settings.

### Content of a theme

Depending on vehicle equipment the following settings can be saved in a theme:

- Setting of the Instrument Display (→ page 208)
- Setting of the Head-up Display (→ page 220)
- Setting of the ambient lighting (→ page 118)
- Active audio source, e.g. radio or USB

- Starting screen for the media display
- Visual style (→ page 276)
- DYNAMIC SELECT drive program (→ page 138)
- Eco start/stop setting (→ page 136)
- Navigation system settings

 A theme contains the currently active settings in the vehicle.

### Calling up themes

Multimedia system:



- ▶ When the home screen is shown, swipe up until **THEMES** appears.
- ▶ Select a theme.

### Creating new themes





#### Requirements:

- The settings which are to be saved in the theme are active.





The overview shows the settings which can be saved in a theme (→ page 257).

Multimedia system:







→  ► THEMES

- ▶ Select  **Create Theme**.  
The settings which are saved in the theme are shown.
- ▶ Select **Continue** .
- ▶ Select additional settings which are to be saved in the theme.
  - Select **Audio**, to save the active audio settings in the theme.
  - Select **Navigation** (Navigation), to save the active navigation settings in the theme.
- ▶ Select **Continue** .
- ▶ Select an entry screen.
- ▶ Select **Continue** .
- ▶ Select an image.
- ▶ Enter the names into the entry field and confirm with .
- ▶ **To save a theme:** select **Save**.

**When the maximum number that can be saved is reached:**

- ▶ Select .
- ▶ Select a theme that should be overwritten. The settings which are saved in the theme are shown.
- ▶ Select **Continue** .
- ▶ Select additional settings which are to be saved in the theme.
  - Select **Audio**, to save the active audio settings in the theme.
  - Select **Navigation** (Navigation), to save the active navigation settings in the theme.
- ▶ Select **Continue** .
- ▶ Select an entry screen.
- ▶ Select **Continue** .
- ▶ Select an image.
- ▶ Enter the names into the entry field and confirm with .
- ▶ **To save a theme:** select **Save**.

**Creating using the  rocker switch or button**

- ▶ Press and hold the bottom section of the  rocker switch on the steering wheel.  
or
- ▶ Press and hold the  button next to the touchpad.
- ▶ Select  **Create Theme**.  
The settings which are saved in the theme are shown.
- ▶ Select **Continue** .
- ▶ Select additional settings which are to be saved in the theme.
  - Select **Audio**, to save the active audio settings in the theme.
  - Select **Navigation** (Navigation), to save the active navigation settings in the theme.
- ▶ Select **Continue** .
- ▶ Select an image.
- ▶ Enter the names into the entry field and confirm with .
- ▶ **To save a theme:** select **Save**.

### Modifying themes

Multimedia system:



- ▶ When the home screen is shown, swipe up until **THEMES** appears.
- ▶ Press on a theme until the **OPTIONS** menu is shown.
- ▶ Select **OK**.
- ▶ Select an image.
- ▶ Enter the name.
- ▶ Select **OK**.
- ▶ **To save a theme:** select **Save** ✓.

### Moving themes

Multimedia system:



- ▶ When the home screen is shown, swipe up until **THEMES** appears.
- ▶ Press on a theme until the **OPTIONS** menu is shown.
- ▶ Select **Move**.
- ▶ Tap on **◀** or **▶**.

- ▶ Tap on **✔**.

### Moving the themes menu in the home screen

- ▶ Select **Home**.
- ▶ Swipe upwards and select **Set New Order**.
- ▶ Select **Themes**.
- ▶ Tap on **▲** or **▼**.
- ▶ Tap on **✔**.

### Deleting themes

Multimedia system:



- ▶ When the home screen is shown, swipe up until **THEMES** appears.
- ▶ Press on a theme until the **OPTIONS** menu is shown.
- ▶ Select **Delete**.
- ▶ Select **Yes**.

### Showing information about themes

Multimedia system:



- ▶ When the home screen is shown, swipe up until **THEMES** appears.
- ▶ Press on a theme until the **OPTIONS** menu is shown.
- ▶ Select **Operator's Manual**.

### Suggestions

#### Suggestions overview

The vehicle can learn the habits of the driver. Based on previously used functions, the most likely navigation destinations, media sources, radio stations or contacts are offered under **SUGGESTIONS**.

Suggestions are shown when the following requirements are fulfilled:

- A profile has been created (→ page 255).
- A profile has been selected.
- You have accepted data recording.

- From the beginning of usage, the multimedia system must analyze the user habits. When sufficient data is collected then the suggestions are available.

If the requirements mentioned are not fulfilled, a preview with a description of the function appears in the **SUGGESTIONS** menu.

You can configure data recording (→ page 260) or delete the suggestions recorded (→ page 261).

### Calling up suggestions

#### Requirements:

- A profile has been created and is selected (→ page 256).
- ▶ Tap on  in the media display. The home screen is shown.
  - ▶ Swipe up until the **SUGGESTIONS** menu is shown.
  - ▶ Select a navigation destination, a media source, a radio station or a contact. If route guidance is already active, you cannot start a new route guidance or set an

intermediate destination for the existing route.

### Configuring suggestions

Multimedia system:

→    Profiles

- ▶ Select  for a profile.
- ▶ Select **Suggestion Settings**.
- ▶ **To switch suggestions display on/off:** switch **Allow Destination Suggestions**, **Allow Music Suggestions** and **Allow Contact Suggestions** on or off. If an option is switched on, suggestions for navigation destinations, media sources, radio stations or contacts are shown. If the option is switched off, no suggestions are shown.
- ▶ **To deactivate the learn function for one day:** activate **24h Learning Deact..** For 24 hours no new actions will be trained and no data recorded for the active profile. Suggestions will continue to be shown. The remaining time is shown next to **24h Learning Deact..**

Before the time runs out, a message is shown that the multimedia system will continue the learn function shortly.

Example: if the option is switched on and a route to a new destination has been calculated, this destination would not be taken into account for the learn function.

- ▶ **To reset the suggestion history:** select **Reset Suggestion History**.

 This process cannot be reversed.

- ▶ Select **Yes**.
- ▶ **To protect settings with a PIN:** switch on **PIN Protection**.

If PIN protection is switched on, you must enter the Mercedes me PIN to set the suggestions. This PIN will be set in the Mercedes me portal for the personalization service to protect your personal settings.

### Renaming suggestions

Only navigation destinations can be renamed.

- ▶ Tap on the  symbol in the media display. The home screen is shown.

- ▶ Swipe up until the **SUGGESTIONS** menu is shown.
- ▶ Highlight a navigation destination and press until the **OPTIONS** menu is shown.
- ▶ Select **Rename**.
- ▶ Enter the name.
- ▶ **To confirm the entry:** select **Yes**.

#### Deleting a suggestion

- ▶ Tap on  in the media display. The home screen is shown.
- ▶ Swipe up until the **SUGGESTIONS** menu is shown.
- ▶ Highlight a suggestion and press until the **OPTIONS** menu is shown.
- ▶ Select **Delete**.  
The query as to whether the suggestion is deleted temporarily or permanently appears.
- ▶ **If the suggestion should be shown again at a later time:** select **Not Now**.
- ▶ **If the suggestion should not be shown again:** select **Never**.

## Favorites

### Overview of favorites

Favorites offer you quick access to frequently used applications. It is possible to create 20 favorites in total.



You can select favorites from categories or you add favorites directly from an application.

### Calling up favorites

#### In the media display



- ▶ Tap on . The home screen is shown.
- ▶ Swipe up until **FAVORITES** is shown.

#### On the steering wheel or the touchpad

- ▶ Press the  rocker switch on the steering wheel down.
- or
- ▶ Press the  button next to the touchpad.

## Adding favorites

### Selecting favorites from categories

- ▶ Tap on  in the media display. The home screen is shown.
- ▶ Swipe up until **FAVORITES** is shown.
- ▶ Select  **Create Favorite**. The categories are displayed.
- ▶ Select the category. The favorites are displayed.
- ▶ Select a favorite. The favorite is stored at the next available position.
- ▶ **All positions in the favorites are taken:** confirm the message shown with **OK**. A list shows all the favorites.
- ▶ Select a favorite which should be overwritten.

### Adding a favorite from an application

Examples of adding from an application are:

- Saving a contact.
- Storing a radio station.

- Adding a media source.
- Saving a navigation destination.
- Adding an ENERGIZING comfort program (if available).

▶ **To save a contact as a global favorite:** select a contact (→ page 334). The details are displayed.

▶ Press on a telephone number until the **OPTIONS** menu is shown.

▶ Select **Save as Favorite**. The contact is added as a favorite.

▶ **To store a radio station as a global favorite:** set a radio station (→ page 369).

▶ Press on the radio station until the **OPTIONS** menu is shown.

▶ Select **Save as Favorite**. The radio station is added as a favorite.

### Renaming favorites

▶ Tap on  in the media display. The home screen is shown.

▶ Swipe up until **FAVORITES** is shown.

▶ Press on a favorite until the **OPTIONS** menu is shown.

▶ Select **Rename**.

▶ Enter the name.

▶ Select **OK**.

### Moving favorites

#### Moving favorites in the favorites menu

▶ Tap on  in the media display. The home screen is shown.

▶ Swipe up until **FAVORITES** is shown.

▶ Press on a favorite until the **OPTIONS** menu is shown.

▶ Select **Move**.

▶ Move the favorite to the new position.

▶ Tap on .

#### Moving the favorites menu in the personalization

▶ Tap on  in the media display. The home screen is shown.

▶ Swipe up until **Set New Order** is shown.

▶ Select **Set New Order**.

▶ Move **Favorites** to the new position.

▶ Tap on .

▶ **To close the menu:** select **Close**.

### Deleting favorites

▶ Tap on  in the media display. The home screen is shown.

▶ Swipe up until **FAVORITES** is shown.

▶ Press on a favorite until the **OPTIONS** menu is shown.

▶ Select **Delete**.

▶ Select **Yes**.

### Notifications Center

#### Overview of the Notifications Center

The following communications are collected in the Notifications Center:

- Communications which are generated by the vehicle or from multimedia system.
- Communications which are received through the use of services.

The following notification types are available for you:

- Navigable destinations and routes
- Messages (text messages)
- System information, e.g. **Important Software Update Available**
- Other notifications, e.g. from additional online services that can be subscribed to

The  Notifications Center can be found on the home screen, in menus and at the top right of the navigation map (→ page 242).

A star in the  symbol informs you of new notifications.

Notifications are normally briefly shown as they are received. This occurs for nearly every application that you are currently using. If you take no action, these are stored for future access in the Notifications Center.

The notifications are sorted chronologically. The most recent notifications are at the top.

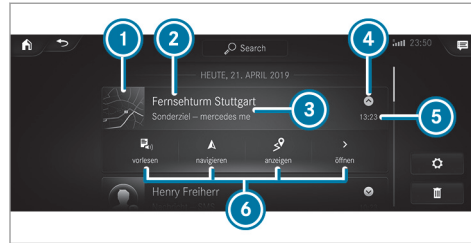

A notification shows the following information:

- Symbol or image **1** for the application
- Title **2**, which contains the name, a telephone number or a navigation destination, for example
- The service and additional information **3**
- A time stamp **5**
- If several actions are available, symbol **4** to open or close the notification.

Depending on the type of notification, up to four different actions **6** are available.

Examples of actions include:

- Read aloud
- Placing a call
- Reply
- Calling up a web page
- Navigation

Some notifications, e.g. a navigation destination, are stored longer. Therefore, it is not necessary to carry out available actions directly on the receipt of the notifications. A route guidance can be started at a later time.



 You can start a global search in the Notifications Center (→ page 265).

### Calling up notifications

#### Opening the Notifications Center

 **On the touchpad:** swipe down with two fingers.

or

 **On the touchscreen:** tap on the  symbol for the Notifications Center.

or

▶ **On the Touch Control and on the touchpad:** mark the  symbol for the Notifications Center by swiping.

▶ Press on the control element.

### Selecting a notification

▶ Swipe up or down.

▶ Tap or press on the control element.

### Calling up old notifications

If notifications have not been called up after four hours, these are stored in the archive.

▶ Swipe upwards and select [Archive](#).

▶ Select the notification.

### Closing the Notifications Center

▶ **On the touchpad:** swipe up with two fingers.

### Selecting actions for a notification

The following options are available:

- Select the action directly in an application after a notification is received and shown.
- Select the action later after calling up in the Notifications Center.

▶ **An action is available:** select the action.

▶ **Several actions are available:** if the notification is not open, select the  symbol.

▶ Select the action.

The notification is still available.

▶ If [Additional information](#) is available, select the action. Additional information is shown in a window as text, image or text and image.

▶ **To close the window:** select [OK](#).

### Editing notifications

▶ Call up the Notifications Center (→ page 263).

▶ **To make settings:** select .

ⓘ If no settings can be made, a message appears.

▶ Select the service.

▶ Switch the options on or off.

The following options are available:

- [Allow Notifications](#)
- [Display in Notification Center](#)

- [Show Notifications](#)
- [Acoustic Notifications](#)

When [Allow Notifications](#) is switched on, the other options cannot be selected.

▶ **To delete:** touch a message on the touchscreen and slide to the left or right.

or

▶ Select the recycle bin.

▶ Select [Delete](#) or [Delete All](#). [Delete](#) deletes a single notification.

[Delete All](#) deletes all notifications currently shown.

▶ With  you will exit delete mode.

## Global search

### Global search overview

You can use the global search in the home screen and in the notifications.

The global search provides search results for the following categories and their sub-categories:

- Navigation



- Media
- Telephone, social media
- User interface and Digital Operator's Manual
- Internet

This enables you to search for cities, roads and tourist attractions with the navigation system, for example.

**i** You can also search for 3 word addresses (→ page 293).

When you enter a 3 word address in the global search, separate each of the words with a space or a full stop.

During the entry process the most likely suggestions are shown beneath the search field. When you enter "S", "Stuttgart", "Steak" and "Sandra" are shown, for example. If you select "Stuttgart", you receive the suggestions "Starbucks", "Steak" and "City railway", for example.

The search results in the list are shown, sorted according to category. Next to the category is the number of results. You will be shown the best results from each category. Additional

results can be found after selecting the respective category.

If you confirm an entry with **OK**, all categories and the number of results will be shown in a summary. After selecting a category you can select the search results within the category. When you select a search result the detailed view opens. In the detailed view you can choose whether and which actions you want to carry out with the respective search result. For example, you can start route guidance or place a call to somebody. The actions are named correspondingly.

The search can be carried out with the following input methods:

- Entering characters using the on-screen keypad
- Entering characters with handwriting recognition
- Dictation function

### Using the global search

Multimedia system:



▶ Select  Search.

or

▶ Call up the notifications (→ page 263).

▶ Select Search.

▶ Enter the search term into the search field. During the entry process the three most likely suggestions are offered beneath the search field.

In the list on the right, the top two search results are shown for each category.

**i** Use the character input function. Alternatively, you can use the  dictation function for the search.

▶ **To accept a suggestion:** select the suggestion.

The three most likely suggestions are offered.

▶ Continue the search or accept a suggestion.

- ▶ **To accept the second search result:** select the search result.  
An action starts or a list is shown.
- ▶ Select a search result or an action in the list.
- ▶ **To show all categories:** select **OK**.
- ▶ **To show search results for a category:** select a category.
- ▶ **To show details:** select a search result.
- ▶ **To start an action:** select an action.  
After selection of an action, a track is played back or the route to a destination is calculated, for example.

### Switching the sound on/off

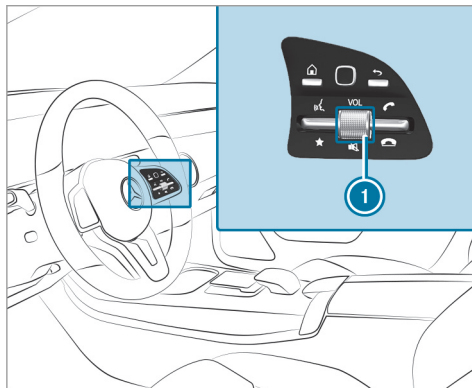

On the multifunction steering wheel

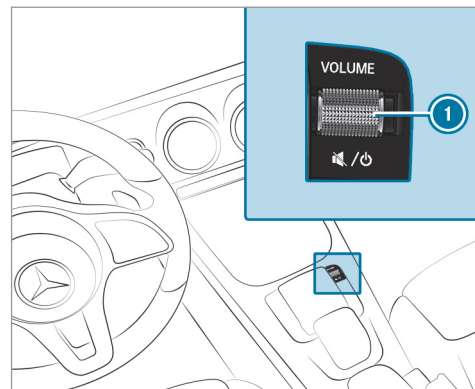

On the multimedia system

- ▶ **To mute:** press volume control ①.  
The  symbol appears in the status line of the media display.  
You will also hear traffic announcements and navigation announcements even when the sound is muted.

- ▶ **To switch on:** turn volume control ① or change the media source.

## Adjusting the volume

### Adjusting with the control knob

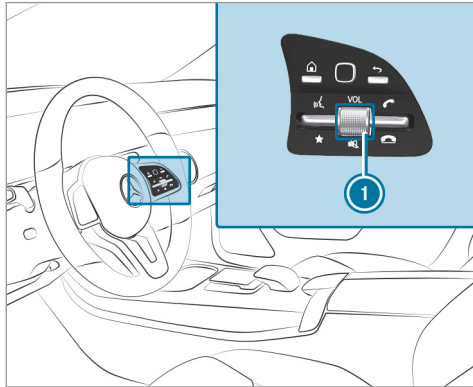

On the multifunction steering wheel

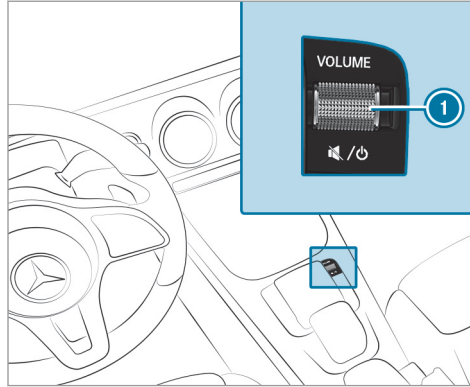

On the multimedia system

- ▶ Turn volume control ①.  
The volume of the current radio or media source is set. The volume of other audio sources can be adjusted separately.
- Adjust the volume in the following situations:
- during a traffic announcement
  - during a navigation announcement

The volume of the current media source changes in accordance with the volume of the navigation announcement.

- during a telephone call
- when entering or exiting a parking space while using Active Parking Assist

### Setting in the menu

- ▶ Press the  button on the Touch Control or on the touchpad.
- ▶ Select **Settings**.
- ▶ Select **System**.
- ▶ Select **Audio**.
- ▶ Select a volume setting.
- ▶ Set the volume.

## Entering characters

### Using the character input function

**⚠ WARNING** Risk of distraction from information systems and communications equipment

If you operate information and communication equipment integrated in the vehicle when driving, you will be distracted from the traffic situation. This could also cause you to lose control of the vehicle.

- ▶ Only operate this equipment when the traffic situation permits.
- ▶ If you cannot be sure of this, stop the vehicle whilst paying attention to road and traffic conditions and operate the equipment with the vehicle stationary.

You must observe the legal requirements for the country in which you are currently driving when operating the multimedia system.

### Requirements:

- **For the handwriting recognition read-aloud function:** the multimedia system is equipped with a voice control system.
- The read-aloud function is available for the selected system language.
- The handwriting recognition read-aloud function is activated.

Character entry can be carried out with these control elements:

- Touch Control
- Touchscreen (media display)
- Touchpad

Character input can be started with a control element and resumed with another.

▶ When the keypad is shown, enter the characters on the control element by swiping and pressing or by tapping (touchscreen).

or

▶ Write the characters on the touchpad or the touchscreen.

Character input on the touchpad is supported by the following functions:

- The handwriting recognition supports character entry with character suggestions.
- If the read aloud function is activated for handwriting recognition then the entered characters are read aloud.

Examples of character entry:

- Renaming a favorite
- Entering a destination address in the navigation system
- Entering a web address

### Entering characters on the touchpad

#### Requirements:

- If you wish to have the character input read aloud: the read aloud function of the handwriting recognition is switched on (→ page 247).
- An online connection is required for some functions.



#### Using the keyboard

- ① Input line
- ② Shows suggestions during input (if available)
- ③ Deletes an entry
- ④ Deletes  
Pressing or pressing briefly deletes the last character entered
- ⑤ Accepts an entry
- ⑥ Switches to handwriting input
- ⑦ Enters a space
- ⑧ Changes the keyboard language
- ⑨ Switches to special characters
- ⑩ Switches to digits and additional special characters  
ABC Switches to letters (level 2)
- ⑪ Pressing or pressing briefly switches between upper-case and lower-case letters  
Pressing and holding switches to upper-case letters permanently



If available, the  symbol allows you to change to voice input.

**i** When **Touchpad Tap** is switched on , tapping is sufficient to select a character or an option (→ page 247).

▶ Call up the character entry to rename a favorite, for example (→ page 262).

▶ Select the character by swiping and pressing. The character is entered in input line **1**. Suggestions are shown in **2**.

▶ **To select a suggestion:** select one of the entries.

▶ If available, display additional suggestions with  or .

▶ Resume character input.

▶ **To enter an alternative character:** press and hold a character.

▶ Select the character.

▶ **To end character input:** press the  button.

**i** The available editing functions depend on the editing task, the language set and the character level.

**i** Entry using the keyboard can also be completed using the Touch Control.

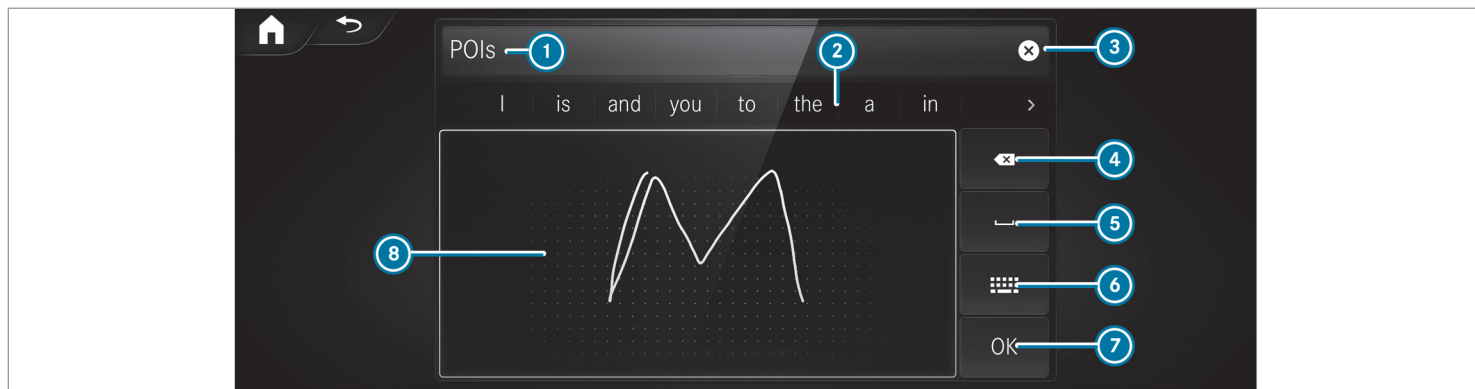

### Using handwriting input

- ① Input line
- ② Shows suggestions during input
- ③ Deletes an entry



If available, the  symbol allows you to change to voice input.

- ④ Deletes  
Pressing or pressing briefly deletes the last character entered  
Pressing and holding deletes the entry

- ① When **Touchpad Tap** is switched on , tapping is sufficient to select an option (→ page 247).

- ⑤ Enters a space
- ⑥ Switches to input using the keyboard
- ⑦ Accepts an entry
- ⑧ Writes characters on the drawing surface

- ▶ Call up the character entry to rename a favorite, for example (→ page 262).
- ▶ When the keyboard is displayed, select .

- ▶ Write the character on the touchpad with a finger.  
The character is entered in input line ①.  
Suggestions are shown in ②.
- ▶ **To select a suggestion:** select one of the entries.
- ▶ If available, display additional suggestions with  or .

- ▶ Resume character input. The letters can be written next to each other or above each other.
- ▶ **To end character input:** press the  button.

### Entering characters on the touchscreen

#### Requirements:

- If you wish to have the character input read aloud: the read aloud function of the handwriting recognition is switched on (→ page 247).
- An online connection is required for some functions.







#### Using the keyboard

- ① Input line
- ② Shows suggestions during input (if available)
- ③ Deletes an entry
- ④ Deletes  
Pressing or pressing briefly deletes the last character entered
- ⑤ Accepts an entry
- ⑥ Switches to handwriting input
- ⑦ Enters a space
- ⑧ Changes the keyboard language
- ⑨ Switches to special characters
- ⑩ Switches to digits and additional special characters  
ABC Switches to letters (level 2)
- ⑪ Pressing or pressing briefly switches between upper-case and lower-case letters  
Pressing and holding switches to upper-case letters permanently

If available, the  symbol allows you to change to voice input.

- ▶ Call up the character entry to rename a favorite, for example (→ page 262). The keyboard is shown.
- ▶ Press briefly on a character key. The character is entered in input line ①. Suggestions are shown in ②.

- ▶ **To select a suggestion:** select one of the entries.
- ▶ If available, display additional suggestions with  or .
- ▶ Resume character input.
- ▶ **To enter an alternative character:** press and hold a character.

- ▶ Select the character.
- ▶ **To end character input:** press the  button.
- ① The available editing functions depend on the editing task, the language set and the character level.

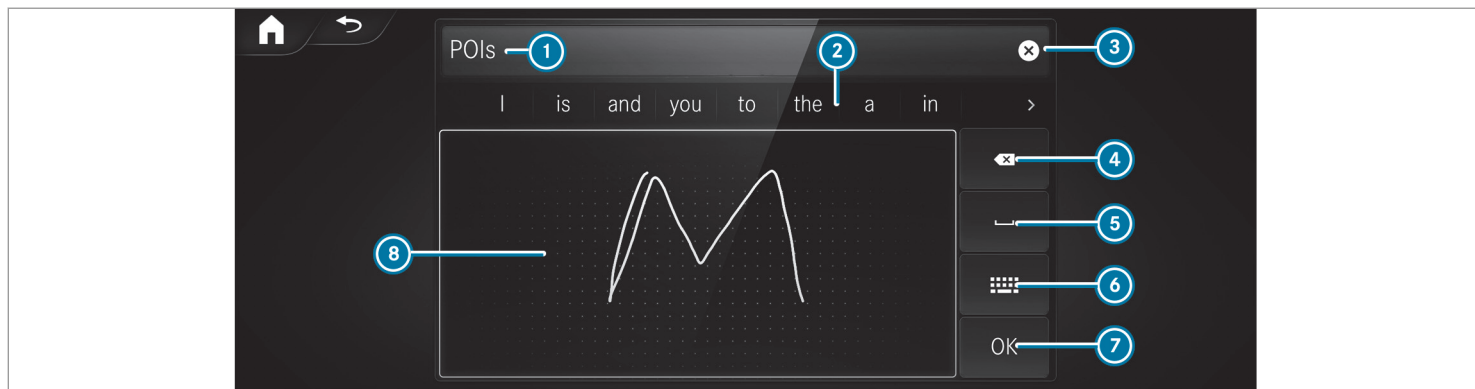

### Using handwriting input

- ① Input line
- ② Shows suggestions during input
- ③ Deletes an entry

If available, the  symbol allows you to change to voice input.



- ▶ Call up the character entry to rename a favorite, for example (→ page 262).

- ④ Deletes  
Pressing or pressing briefly deletes the last character entered  
Pressing and holding deletes the entry

- ▶ When the keyboard is displayed, select .

- ⑤ Enters a space
- ⑥ Switches to input using the keyboard
- ⑦ Accepts an entry
- ⑧ Writes characters on the drawing surface

- ▶ Write the character with one finger on the touchscreen.  
The character is entered in input line ①.  
Suggestions are shown in ②.

- ▶ **To select a suggestion:** select one of the entries.
- ▶ If available, display additional suggestions with  or .
- ▶ Resume character input. The letters can be written next to each other or above each other.
- ▶ **To end character input:** press the  button.

### Setting the keyboard for character entry

Multimedia system:

- ▶  **Settings** ▶ **System** ▶ **Controls**
- ▶ **Keyboards and Handwriting**
- ▶ Confirm **Select keyboards**.
- ▶ Select the keyboard language in the list.

## System settings

### Display

#### Configuring display settings

Multimedia system:

- ▶  ▶ **Settings** ▶ **System**
- ▶▶ **Designs & Display**

#### Setting the design

- ▶ Select **Designs**.
- ▶ Select **Classic**, **Sport** or **Progressive**.  
The multimedia system display changes depending on the style selected. If you revert to the factory settings, the **Classic** style is set.
- ▶ **To adjust the ambient lighting to a style:** select **Ambient Lighting Adjustment**.  
This function adjusts the ambient lighting for the selected display style.

#### Setting the display brightness

- ▶ Select **Display Brightness**.
- ▶ Select a brightness value.

#### Switching the display off/on

- ▶ **Off:** select **Display Off**.
- ▶ **On:** press a button, , for example.

#### Selecting the display design

- ▶ Select **Day/Night Design**.
- ▶ Select **Automatic**, **Day Design** or **Night Design**.

#### Switching the temperature display on/off

- ▶ Select **Temperature Display**.
- ▶ Select **Outside Temp.** or **Coolant Temp.**.  
The selected temperature is displayed in the instrument cluster.

## Time and date

### Setting the time and date automatically

Multimedia system:

→  » Settings » System  
» Time and Date

- ▶ Deactivate **Manual Time Adjustment**.  
The time and date are set automatically for the selected time zone and summer time option.
- ⓘ The correct time is required for the following functions:
  - Route guidance with time-dependent traffic guidance.
  - Calculation of expected time of arrival.

### Setting the time zone

#### Requirements:

- **For the manual time zone:** **Automatic Time Zone** is switched off.

Multimedia system:

→  » Settings » System  
» Time and Date

### Setting the time zone manually

- ▶ Select **Time Zone:**.  
The list of countries is displayed.
- ⓘ If there are several time zones available in a country, these will be shown after the country is selected.
- ▶ Select a country and, if required, a time zone.  
The time zone set is displayed after **Time Zone:**.

### Setting the time zone automatically

- ▶ Activate **Automatic Time Zone**.

### Setting the time and date format

Multimedia system:

→  » Settings » System  
» Time and Date » Set Format

- ▶ Set the date and time format •.

### Setting the time and date manually

#### Requirements:

- The **Manual Time Adjustment** function is switched on.
- **For setting the date manually:** no GPS is installed in the vehicle.

Multimedia system:

→  » Settings » System  
» Time and Date

### Setting the time (without time zone)

- ▶ Select **Set Time**.
- ▶ Set a time.

### Setting the time (with time zone)

- ▶ Select **Set Time**.

If a time zone is set the time is set automatically using the time zone. The time can be adjusted by a maximum of plus or minus 60 minutes.

- ▶ Adjust the time using the slide control.

### Setting the date

- ▶ Select [Set Date](#).
- ▶ Set a date.
- ⓘ In vehicles with GPS, a date cannot be set even with active manual time adjustments. The date is then set automatically through the selected time zone.

### Connectivity

#### Switching transmission of the vehicle position on/off

Multimedia system:

→  ▶ [Settings](#) ▶ [System](#)  
▶ [Wi-Fi & Bluetooth](#)

- ▶ Select [Transmit Vehicle Position](#).
- ▶ Activate or deactivate the function.

### Bluetooth®

#### Information about Bluetooth®

Bluetooth® technology is a standard for short-range wireless data transfer up to approximately 32.8 ft (10 m).

You can use Bluetooth® to connect your mobile phone to the multimedia system and use the following functions, for example:

- Hands-free system with access to the following options:
  - [Contacts](#) (→ page 334)
  - [Call lists](#) (→ page 337)
- [Internet connection](#) (→ page 353)
- [Listening to music via Bluetooth® audio](#) (→ page 364)
- [Transferring business cards \(vCards\) into the vehicle](#)

Bluetooth® is a registered trademark of Bluetooth Special Interest Group (SIG) Inc.

- ⓘ [Internet connection via Bluetooth®](#) is not available in all countries.

### Activating/deactivating Bluetooth®

Multimedia system:

→  ▶ [Settings](#) ▶ [System](#)  
▶ [Wi-Fi & Bluetooth](#)

- ▶ **To switch on Bluetooth®:** select [Connect via Bluetooth](#).
- ▶ Activate [Bluetooth](#).
- ▶ **To switch off Bluetooth®:** select [Settings](#).
- ▶ Deactivate [Bluetooth](#).

### Wi-Fi

#### Wi-Fi connection overview

You can use Wi-Fi to establish a connection with a Wi-Fi network and to access the Internet or other network devices.

The following connection options are available:

- [Wi-Fi connection](#)
  - The Wi-Fi connection to a Wi-Fi-capable device, e.g. the customer's mobile phone or a tablet PC is established.
- [Multimedia system as a Wi-Fi hotspot](#)

Using this function, a tablet PC or notebook can be connected, for example. The connected device can use the data tariff of the vehicle. A maximum of three devices can be connected with the hotspot at the same time.

- ❗ The use of the vehicle data tariff by external devices is not available in all countries.

To establish a connection, you can use the following methods:

- WPS PIN  
The connection to a secure Wi-Fi network is made via a PIN.
- WPS PBC  
The connection to a secure Wi-Fi network is made by pressing a button (push button).
- Security key  
The connection to a secure Wi-Fi network is made via a security key.

### Setting up Wi-Fi

#### Requirements:

- The device to be connected supports one of the three means of connection described.

Multimedia system:

→  ▶ Settings ▶ System  
▶ Wi-Fi & Bluetooth

#### Switching on Wi-Fi

- ▶ Select **Wi-Fi**.  
The Wi-Fi is switched on and you can connect the multimedia system with external hotspots.

#### Switching off Wi-Fi

- ▶ Select **Settings**.
- ▶ Deactivate **Wi-Fi**.  
If **Wi-Fi** is deactivated, communication via Wi-Fi to all devices is interrupted. This also means that a connection to the communication module cannot be established. Then some functions such as dynamic route guidance with Live Traffic Information are not available.

#### Connecting the multimedia system with a new device via Wi-Fi

This function is available if a communication module is not installed.

The type of connection established must be selected on the multimedia system and on the device to be connected.

- ❗ The connection procedure may differ depending on the device. Follow the instructions that are shown in the display. Further information (see the manufacturer's operating instructions).
- ▶ Select **Connect via Wi-Fi**.
- ▶ Select **Add Hotspot**.

#### Connecting using a security key

- ▶ Select the options  of the desired Wi-Fi network.
- ▶ Select **Connect Using Security Key**.
- ▶ Have the security key displayed on the device to be connected (see the manufacturer's operating instructions).
- ▶ Enter this security key on the multimedia system.
- ▶ Confirm the entry with **ok**.
- ❗ All devices support a security key as a means of connection.

**Connecting using a WPS PIN**

- ▶ Select the options  of the desired Wi-Fi network.
- ▶ Select [Connect via WPS PIN Input](#).  
The multimedia system generates an eight-digit PIN.
- ▶ Enter this PIN on the device to be connected.
- ▶ Confirm the entry.

**Connecting using a button**

- ▶ Select the options  of the desired Wi-Fi network.
- ▶ Select [Connect via WPS PBC](#).
- ▶ Select "Connect via WPS PBC" in the options on the device to be connected (see the manufacturer's operating instructions).
- ▶ Press the WPS button on the device to be connected.
- ▶ Select [Continue](#) in the multimedia system.

**Activating automatic connection**

- ▶ Select [Connect via Wi-Fi](#).

- ▶ Select the options  of the desired Wi-Fi network.
- ▶ Activate [Permanent Internet Connection](#).

**Connecting with a known Wi-Fi**

- ▶ Select [Connect via Wi-Fi](#).
- ▶ Select a Wi-Fi network.  
The connection is established again.

**Setting up a Wi-Fi hotspot**

Multimedia system:

- ▶   ▶ [Settings](#) ▶ [System](#)
- ▶▶ [Wi-Fi & Bluetooth](#)

**Configuring the multimedia system as a Wi-Fi hotspot**

The type of connection established depends on the device to be connected. The function must be supported by the multimedia system and by the device to be connected. The type of connection established must be selected on the multimedia system and on the device to be connected.

- ▶ Select [Vehicle Hotspot](#).
- ▶ Select [Connect Device to Vehicle Hotspot](#).

**Connecting using WPS PIN generation**

- ▶ Select [Connect via WPS PIN Generation](#).
- ▶ Enter the PIN shown in the media display on the device to be connected and confirm.

**Connecting using WPS PIN entry**

- ▶ Select [Connect via WPS PIN Input](#).
- ▶ Enter the PIN that is shown on the external device's display on the multimedia system.

**Connecting using a button**

- ▶ Select [Connect via WPS PBC](#).
- ▶ Press the push button on the device to be connected (see the manufacturer's operating instructions).
- ▶ Select [Continue](#).

**Connecting using a security key**

- ▶ Select [Connect Device to Vehicle Hotspot](#).  
A security key is displayed.
- ▶ Select the vehicle from the device to be connected. The vehicle is displayed with the [MB Hotspot XXXXX](#) network name.



- ▶ Enter the security key which is shown in the media display on the device to be connected.
- ▶ Confirm the entry.

### Connecting using NFC

- ▶ Select [Connect via NFC](#).
- ▶ Activate NFC on the mobile device (see the manufacturer's operating instructions).
- ▶ Bring the mobile device into the NFC area of the vehicle (→ page 331).
- ▶ Select [Finished](#).  
The mobile device is now connected to the multimedia system hotspot via NFC.

### Generating a new security key

- ▶ Select [Vehicle Hotspot](#).
- ▶ Select [Generate Security Key](#).  
A connection will be established with the newly created security key.
- ▶ **To save a security key:** select [Save](#).  
When a new security key is saved, all existing Wi-Fi connections are then disconnected. If the Wi-Fi connections are being re-established, the new security key must be entered.

## Managing MBUX Touch devices

### Requirements:

- The MBUX Touch app is installed on the external device (e.g. tablet or smartphone).
- Wi-Fi is activated (→ page 279) and the multimedia system is configured as a Wi-Fi hotspot (→ page 280).

Multimedia system:

→  ▶ [Settings](#) ▶ [System](#)  
▶ [MBUX Touch](#)

### Connecting and authorizing a new device

- ▶ Select [Authorize a New Device](#).
- ▶ Select [Add new device to list](#).
- ▶ Enter the security key in the external device. The [Please start MBUX Touch on your device and follow the instructions](#) message appears.
- ▶ Select [Continue](#).
- ▶ The connection request from the new device [Accept](#).

- ▶ Enter the PIN shown on the external device. The device is authorized.

### Authorizing a connected device

- ▶ Select [Authorize a New Device](#).
- ▶ [Continue Using Connected Devices](#)  
The [Please start MBUX Touch on your device and follow the instructions](#) message appears.
- ▶ Select [Continue](#).
- ▶ The connection request from the device [Accept](#).
- ▶ Enter the PIN shown on the external device. The device is authorized.

### De-authorizing the device

- ▶ Select [De-authorize device](#).
- ▶ Select an authorized device from the list. A prompt will appear asking whether you would like to de-authorize the selected device.
- ▶ Select [Continue](#).
- ▶ Select [Yes](#).  
The device is de-authorized.

## Activating/deactivating child safety lock

Multimedia system:

↳ System ▶▶ Parental Control

### Locking an external device

- ▶ Select an external device.
- ▶ Select **Lock**.  
The device connected via the MBUX Touch app is locked or unlocked.

## System language

### Notes on the system language

This function allows you to determine the language for the menu displays and the navigation announcements. The selected language affects the characters available for entry. The navigation announcements are not available in all languages. If a language is not available, the navigation announcements will be in English.

## Setting the system language

Multimedia system:

↳  ▶▶ Settings ▶▶ System  
▶▶ Language

- ▶ Set the language.
- ⓘ If you are using Arabic map data, the text information can also be shown in Arabic on the navigation map. To do so, select العربية as the language from the language list. Navigation announcements are then also made in Arabic.

## Setting the distance unit

Multimedia system:

↳  ▶▶ Settings ▶▶ System ▶▶ Units

- ▶ Select **km** or **mi**.
- ▶ In the multifunction display of the Instrument Display, switch the **Additional Speedometer** display on.

## Data import and export

### Data import/export function

The following functions are possible:

- Transferring data from one system or vehicle to another system or vehicle.
- Creating a backup copy of your personal data and loading it again.
- Protecting your personal data against unwanted export with PIN protection.
- ⓘ Please note that the NTFS file system is not supported. The FAT32 file system is recommended.

### Importing/exporting data

**!** **NOTE** Loss of data due to premature removal

- ▶ Do not remove the data storage medium when data is being exported.

Mercedes-Benz is not liable for any loss of data.

**Requirements:**

- The vehicle is stationary
- The ignition is switched on.
- A USB device is connected.

Multimedia system:

→  » Settings » System  
 » System Backup

- ▶ Select [Import Data](#) or [Export Data](#).

**Importing**

- ▶ Select a data storage medium.  
A prompt appears asking whether you really wish to overwrite the current data. If data originates from another vehicle, this is recognized during data reading.
- ▶ Confirm the prompt.

The files are imported. The multimedia system is restarted once the data has been imported.

- ⓘ Current vehicle settings can be edited after the import.

**Exporting**

If PIN protection is activated, your PIN is requested.

- ▶ Enter the four-digit PIN.
- ▶ Select a data storage medium.  
A prompt appears asking whether you really wish to carry out the export.
- ▶ Confirm the prompt.  
The data is exported. The data export may take several minutes.
- ⓘ After successful export, the data is saved in the "MyMercedesBackup" directory which can be found on the storage medium.

**Activating/deactivating PIN protection****Requirements:**

- **To unlock the PIN:** there is an Internet connection.
- A Mercedes me account exists at <http://www.mercedes.me>.
- An individual user profile is active (→ page 256).

Multimedia system:

→  » Settings » System  
 » PIN Protection

**Setting the PIN**

- ▶ Select [Set PIN](#).
- ▶ Enter a four-digit PIN.
- ▶ Enter the four-digit PIN again.  
If both PINs match, PIN protection is active.

**Changing the PIN**

- ▶ Select [Change Settings](#).
- ▶ Enter the current PIN.
- ▶ Select [Change PIN](#).
- ▶ Set a new PIN.

**Activating PIN protection for data export**

- ▶ Select [Protect Data Export](#).  
Activate or deactivate the function.

**Unblocking the PIN via the Mercedes me portal**

If the PIN has been entered incorrectly three times, the PIN will be blocked. You can have a

single-use password sent to you via the Mercedes me connect online portal to reset the PIN protection.

- ▶ Select **Unlock PIN**.
- ▶ Enter the single-use password. PIN protection is reset, and you can set a new PIN.

## Software update

### Information on software updates

A software update consists of three steps:

- Downloading or copying of the data required for installation
- Installation of the update
- Activation of the update by restarting the system

The multimedia system provides a message when an update is available.

Depending on the source, you can perform various updates:

### Software updates

Source of the update	Update type
Internet	Navigation map, system updates, Digital Operator's Manual
External storage medium, e.g. USB flash drive	Navigation maps

- ⓘ Installation can take several minutes and cancellation is not possible. If you do not install the software updates then the status of your vehicle will not be up-to-date. During the installation, individual functions or control elements are not available or only available to a limited degree.

### Advantages of updating software

Software updates ensure your vehicle's technology is always up-to-date.

In order to improve the quality of our services you will receive future updates for your multimedia system, the Mercedes me connect services

and your vehicle's communication module.

These will conveniently be sent to you via the mobile phone connection in your vehicle and, in many cases, installed automatically. You can monitor the status of your updates at any time on the Mercedes me portal and find information about potential innovations.

Your advantages at a glance:

- conveniently receive software updates via the mobile phone network
- improves the quality and availability of Mercedes me connect services
- keeps your multimedia system and communication module up-to-date

Further information about software updates can be found at <http://me.mercedes-benz.com>

### Performing a software update

#### Requirements:

- **For online updates:** an Internet connection is established (→ page 353).

- **For automatic online updates:** your vehicle has a permanently installed communication module.

Multimedia system:

→  » Settings » System  
» Software Update

#### Automatically

- ▶ Activate [Automatic Online Update](#).  
The updates will be downloaded and installed automatically.  
The current status of the updates is displayed.

#### Manually

- ▶ Deactivate [Automatic Online Update](#).
- ▶ Select an update from the list and start the update.

#### Activating the software update

- ▶ Restart the system.  
The modifications from the software update will be active.

#### Function of important system updates

Important system updates may be necessary for the security of your multimedia system's data. Install these updates, or else the security of your multimedia system cannot be ensured.

- ⓘ If automatic software updates are activated, the system updates will be downloaded automatically (→ page 284).

As soon as an update is available for download, a corresponding message appears on the media display.

You have the following selection options:

- [Accept and Install](#)  
The update will be downloaded in the background.
- [Information](#)  
Information about the pending system update is displayed.
- [Later](#)  
The update can be downloaded manually at a later time (→ page 284).

#### Deep system updates

Deep system updates access vehicle or system settings and can therefore only be carried out when the vehicle is stationary and the ignition is switched off.

If the download of a deep system update is completed and the update is ready for installation, you will be informed of this after the next ignition cycle, for example.

- ⓘ Park the vehicle safely in a suitable location before starting the installation.

Requirements for the installation:

- The ignition is switched off.
- Notes and warnings have been read and accepted.
- The electric parking brake is applied.

If all requirements are met, the update will be installed. The multimedia system cannot be operated while the update is being installed and vehicle functions are restricted.

If errors should occur during the installation, the multimedia system automatically attempts to restore the previous version. If restoration of the

previous version is not possible, a symbol appears on the media display. Please consult a qualified specialist workshop to resolve the problem.

### Resetting the multimedia system (reset function)

Multimedia system:

 **Settings** **System** **Reset**

Personal data is deleted, for example:

- Station presets
- Connected mobile phones
- Individual user profiles

 The guest profile is reset when the settings are restored to the factory settings.

A prompt appears again asking whether you really wish to reset.

 Select **Yes**.



The multimedia system is reset to the factory settings. If you have set a PIN for your system, this will also be reset.

### Navigation

#### Switching navigation on

Multimedia system:

 **Navigation** (Navigation)

 Alternatively: press the  button. The map appears. The current vehicle position is shown. The navigation menu is shown.

The navigation menu is hidden if route guidance is active.



#### Showing/hiding the navigation menu

 **Navigation**

If route guidance is not active the map appears. The navigation menu is shown.

The navigation menu is hidden if route guidance is active.

 **To show:** tap on the touchscreen.  
or

 Press the Touch Control or the touchpad.  
 **To hide:** the navigation menu is hidden automatically.

## Navigation overview

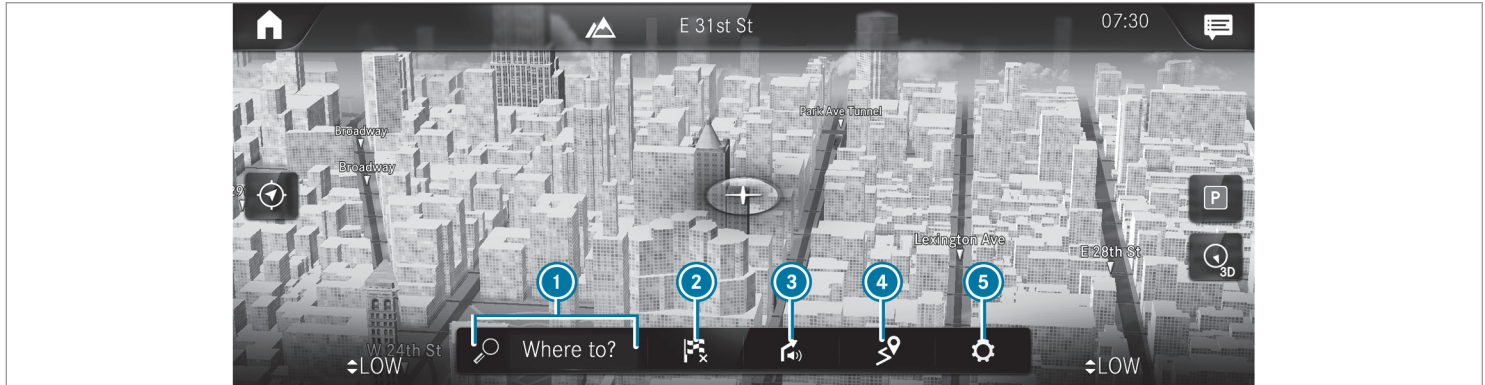

Example: digital map with navigation menu

- ① To enter a POI or address and additional destination entry options
- ② To interrupt route guidance (if route guidance is active)

- ③ To repeat a navigation announcement and switch navigation announcements on or off
- ④ To call up the **ON THE WAY** menu
  - To show **Route Overview**
  - To select **Alternative Routes**
  - **Report Traffic Incident** (Car-to-X)

- To call up the **TRAFFIC** menu
  - ◇ To show **Traffic Announcements**
  - ◇ To show **Area Alerts**
  - ◇ To show **Live Traffic Subscription Info**
- To show **Route List**
- To call up the **POSITION** menu

- ◇ Save Position
- ◇ To show [Compass](#)
- ⑤ Quick-access and settings

- ① The options are not available in all countries.
- ① You can enter 3 word addresses in the online search (→ page 293). This option is not available in all countries.

## Destination entry

### Notes on destination entry

**⚠ WARNING** Risk of distraction from operating integrated communication equipment while the vehicle is in motion

If you operate communication equipment integrated in the vehicle when driving, you will be distracted from the traffic situation. This could also cause you to lose control of the vehicle.

- ▶ Only operate this equipment when the traffic situation permits.

- To show [Traffic](#)
- To show [Parking](#)

▶ If you cannot be sure of this, stop the vehicle whilst paying attention to road and traffic conditions and operate the equipment with the vehicle stationary.

You must observe the legal requirements for the country in which you are currently driving when operating the multimedia system.

### Entering a POI or address

**⚠ WARNING** Risk of distraction from information systems and communications equipment

If you operate information and communication equipment integrated in the vehicle when driving, you will be distracted from the traffic situation. This could also cause you to lose control of the vehicle.

- To show [Highway Information](#)
- Via [Advanced](#) options to use [View](#), [Announcements](#) and [Route](#)

▶ Only operate this equipment when the traffic situation permits.

▶ If you cannot be sure of this, stop the vehicle whilst paying attention to road and traffic conditions and operate the equipment with the vehicle stationary.

You must observe the legal requirements for the country in which you are currently driving when operating the multimedia system.

### Requirements:

- **For the online search:** Mercedes me connect is available.
- You have a user account for the Mercedes me portal.
- The service is available.
- The service has been activated at an authorized Mercedes-Benz Center.



Multimedia system:

→ → Navigation → Where to?



On-board search with the keypad

Destination entry uses the on-board search of the database stored in the multimedia system.

The federal state or province in which the vehicle is located is set **1**.

▶ Enter the POI or the address using the keyboard (in the image) or using handwriting recognition **6** in input line **2**. The entries can be made in any order. During destination entry, suggestions are offered in **3** by the multimedia system. Des-

ination selection takes place in list **3** or with **OK** **5**.

If the multimedia system is equipped with a small display, calling up list **3** is carried out using a list symbol at the top right.

The following entries can be made, for example:

- City, street, house number
- Street, city
- ZIP code
- POI name
- POI categories, e.g. [Gas Station](#)
- City, POI name
- Telephone number, if this is available for the POI
- Contact name

▶ Alternatively, use voice input **8**.

▶ **To switch to handwriting recognition:** select **6**.

▶ Write the character on the touchpad. The letters can be written next to each other or above each other (→ page 268).

▶ **To return to entry using the keyboard:** select .

or

▶ Press the touchpad.

▶ **To delete an entry:** select **4**.  
The characters are deleted individually.

or

▶ If characters have been entered in **2**, select  next to the input line.

The complete entry is deleted.

▶ **To switch to upper-case or lower-case letters:** select **11**.

▶ **To switch to digits, special characters and symbols:** select **10**.  
*123* changes to *ABC*.

Display **11** changes to *#+=*.

▶ Select **11** and switch to additional special characters.

▶ **To enter a space:** select **7**.

▶ **To set the language:** select **9**.

▶ Select the language.

**i** This function is useful for countries in which several character sets are supported. An example is Russia, which uses Cyrillic and Latin characters.

▶ **To change the state:** select indicator for federal state or province **1**.

▶ Select the state in **1**.

▶ Enter the country indicator, e.g. *CA* for Canada.

The list is filtered.

▶ Select the country on list **3**.

The destination can be entered.

▶ **To change the state or province:** select the state or the province in list **3**.

▶ **To accept a destination:** select the destination in list **3**.

▶ If the destination is ambiguous, select the destination in the list.

The destination address is shown. The route can be calculated.

### Using online search

**i** Requirements: there is an Internet connection.



Further information on Mercedes me:  
<http://www.mercedes.me>

Online search is not available in all countries.

Destination entry uses online map services. If the on-board search finds no suitable destinations or if you change countries, the online search is available.

For the destination you can enter an address, a POI or a 3 word address.

 Enter a 3 word address (→ page 293).

 Select country indicator .

 Select the provider for the online service from the countries list.

or

 If the on-board search delivers no results, enter the destination in the input line. The entry order is not relevant, e.g. street and city. Use the functions described for the on-board search.

The search results are displayed.

 Select the destination in the list. The detailed view for the route is displayed.

### Selecting previous destinations

#### Requirements:

- Previous destinations are stored.



- **For destination suggestions:** you have created a profile (→ page 255).
- The **Allow Destination Suggestions** option is switched on (→ page 260).
- The multimedia system has already gathered sufficient data in order to show destination suggestions.

Multimedia system:

   **Navigation**   **Where to?**

 **PREV. DESTINATIONS**

The following entries can be selected in the previous destinations:

- Destination suggestions (→ page 311)
  - Destinations
  - Routes
-  Select the destination or route. The destination address is shown. The route can be calculated.
-  You can save a previous destination or a destination suggestion as a favorite (→ page 311).

Using the favorites, you have quick access to the destinations (→ page 295).

### Selecting a POI

#### Requirements:

- **For use of personal POIs:** a USB device is connected with the multimedia system.
- Personal POIs with the GPS Exchange format (.gpx) have been saved in the "PersonalPOI" folder on the USB device.



Multimedia system:

   **Navigation**   **Where to?**

 **POIS**

### Searching using categories (no route guidance)

 Select the category, for example **Gas Station**.  
or

-  Select **All Categories**.
-  Select the category and the sub-category (if available).  
The search takes place in the vicinity of the vehicle's current position. The search result are sorted by distance in ascending order.

The POIs show the following information:

- direction of the linear distance to the POI (arrow)
- name of POI
- linear distance to the POI

▶ **To filter according to categories or in search results:** enter a search entry in the  **Search** text field.

▶ Select a POI from the list.  
The destination address is shown. The route can be calculated.

#### Searching using categories (route guidance active)

▶ Select the category, for example **Gas Station**.  
or

▶ Select **All Categories**.

▶ Select the category and the sub-category (if available).

▶ **To filter according to categories or in search results:** enter a search entry in the  **Search** text field.

- ▶ Select the search positions **In the Vicinity**, **Near Destination** or **Along the Route**.
- ▶ If there are intermediate destinations for the route and **Near Destination** has been selected, select the search position in the route overview.
- ▶ Select a POI from the list.  
The destination address is shown. The route can be calculated.



#### Searching for personal POIs

- ▶ Select **Personal POIs**.
- ▶ Select a category.
- ▶ If route guidance is active, select a search position **In the Vicinity**, **Near Destination** or **Along the Route**.
- ▶ Select a personal POI.  
The destination address is shown. The route can be calculated.

or

- ▶ Enter a search entry into the search field and filter the list.
- ▶ Select a personal POI.

#### Editing personal POI categories





- ▶ Select a personal POI category from the list .  
A menu opens.
- ▶ **To change a name:** select **Change Name**.
- ▶ Enter the name.
- ▶ Select .
- ▶ **To change a symbol:** select **Change Icon**.
- ▶ Select a symbol.
- ▶ **To delete a personal POI category:** select **Delete**.
- ▶ Select **Yes**.

#### Configuring categories for quick-access

You can configure the categories for quick-access.

If you calculate the route, for example, the first three of these categories can be selected as symbols.

- ▶ Select **All Categories**.
- ▶ Select the category and the sub-category (if available).



- ▶ Select  or .
-  adds the category.
-  removes the category.
- ▶ If all available quick-access positions are full, select the category to be replaced.

### Selecting a contact for destination entry

#### Requirements:

- A mobile phone is connected to the multimedia system (→ page 329).

Multimedia system:

  Navigation  Where to?  
▶▶ CONTACTS

#### Using the contact list

- ▶ Select a contact.  
The contact details are displayed.
- ▶ Select the address.

#### Using search entry

- ▶ Enter a name or telephone number, for example, into the search field.
- ▶ Select .



- ▶ Select the contact.
- ▶ Select the address.  
The destination address is shown. The route can be calculated.
- ① Route guidance to a contact address is reliable in the following cases:
  - the contact address is complete.
  - the contact data matches the map data in the digital map.

### Entering geo-coordinates

Multimedia system:

  Navigation  Where to?  
▶▶ GEO-COORDINATES

- ▶ Select **Latitude** or **Longitude**.
- ▶ Select geo-coordinates as latitude and longitude coordinates in degrees, minutes and seconds. To do this swipe up or down respectively.  
The map shows the position.
- ▶ Confirm the entry with .



- ▶ **To set the destination:** select  or .
- ▶ Calculate the route (→ page 296).

### Entering the destination as a 3 word address

#### Requirements:

- Searching for a destination using 3 word addresses is possible in the online search (→ page 288).
- The media display shows an Internet connection with a double-arrow symbol in the status line.
- ① Searching for a destination using 3 word addresses is not possible in all countries and in all languages.

Multimedia system:

  Navigation  Where to?  
▶ Select the country indicator.  
▶ Select the provider for the online service from the countries list.

or

▶ If the on-board search delivers no search results, enter the destination address as a 3 word address. Separate each of the words with a full stop.

The search results are displayed.

▶ Select the destination in the list.

The destination address is shown. The route can be calculated.

① 3 word addresses from what3words are an alternative addressing system for multilingual georeferencing of global locations with a resolution of three meters. Using this grid, locations on the Earth's surface are included which do not have a building address such as street and house number, for example.

The Empire State Building has this language dependent 3 word address:

- English: **parade.help.bleat**
- French: **commun.verbe.bisquer**
- Spanish: **suertes.diga.pesca**

3 word addresses are unique, easy to remember and suffice for most routine applications.

You can convert addresses to 3 word addresses and back again:

- at the website <http://what3words.com>
- in the what3words apps

### Selecting a destination on the map

Multimedia system:

  ▶▶ Navigation

▶ Move the map (→ page 316).

▶ **To use the touchscreen:** press and hold on the touchscreen.

The destination address is shown.

If several destinations are located at the selected position, a list shows the available roads and POIs.

▶ Select the destination in the list.

The destination address is shown. The route can be calculated.

▶ **To use the touchpad:** when the crosshair marks the destination, press and hold on the control element.

The destination address is shown.

If several destinations are located around the crosshair, a list shows the available roads and POIs.

▶ Select the destination in the list.

The destination address is shown. The route can be calculated.

### Showing POIs in the vicinity of the map

If several destinations are located around the crosshair, the function is available.

▶ Select .

▶ Select **POIs in the Vicinity**.

The map appears.

▶ Swipe left or right on the control element.

The previous or next POI is highlighted on the map. The name or the address is shown.

▶ Select the POI symbol.

or

▶ **To filter the display according to the POI category:** scroll on the control element.



▶ Select the POI category.

## Selecting a destination from favorites

### Requirements:

- Destinations are saved as favorites.  
Save a previous destination or a destination suggestion as a favorite (→ page 311).

Multimedia system:

  **Navigation**  **Where to?**  
**FAVORITES**

- ▶ Select a favorite.  
The destination address is shown. The route can be calculated.

The following options are available in the favorites menu:

- Saving addresses for home and work
- Creating favorites
- Deleting favorites
- ▶ **If no address has been saved for home and work:** select **Home** or **Work**.
- ▶ Confirm the prompt with **Yes**.
- ▶ Enter the favorite as a POI or address (→ page 288).

- ▶ **To save a favorite:** select **Add Favorites**.

▶ Enter the favorite as a POI or address (→ page 288).

or

- ▶ If all the positions in the favorites are full, first select a favorite which is to be overwritten (→ page 261).

▶ Follow the instructions provided.

- ▶ **To delete a favorite:** select  for a destination.

▶ Select **Delete**.

or

- ▶ Press on a favorite until the **OPTIONS** menu is shown.

▶ Select **Delete**.

### Selecting received destinations

#### Requirements:

- There is an Internet connection.
- A destination has been sent to the vehicle.

Multimedia system:

  **Navigation**  **Where to?**  
**REC. DESTINATIONS**

The vehicle can receive destinations from services or apps.

- ▶ Select a destination.  
The destination address is shown. The route can be calculated.

- ① You can save a received destination in the favorites (→ page 311).  
You have fast access to the destinations via the favorites (→ page 295).

### Deleting a received destination

- ▶ **To delete a destination:** select  for a destination.

▶ Select **Delete**.

▶ Select **Yes**.

- ▶ **To delete all destinations:** select .

▶ Select **Delete All**.

▶ Select **Yes**.



## Route

### Calculating a route

#### Requirements:

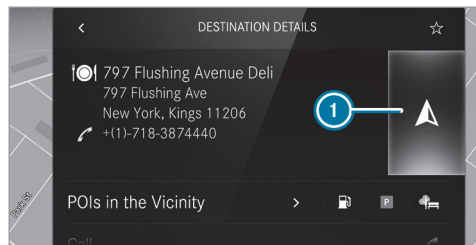
- The destination has been entered.
- The destination address is shown.



- ①  No route yet
-  A route has been mapped

- ▶ Select . The route to the destination is calculated. The map shows the route. Route guidance then begins.

or

- ▶ Select . If a route is already mapped, a prompt is shown.
- ▶ Select **Set as Way Point**. The selected destination address is set as the next intermediate destination. Route guidance begins.

If there are already four intermediate destinations, the multimedia system asks whether intermediate destination 4 should be deleted. Confirm the prompt with **Yes**.

or

- ▶ Select **Start New Route Guidance**. The selected destination address is set as a new destination. The previous destination and the intermediate destinations are deleted. Route guidance to the new destination begins.

### Searching for POIs in the vicinity of the destination shown

- ① The POI symbols to the right of **POIs in the Vicinity** show the first three categories for

quick-access. You can configure these categories (→ page 291).

- ▶ Select a POI symbol. The search results are displayed.
- ▶ Select a POI. The destination address is shown. The route can be calculated.

or

- ▶ Select **POIs in the Vicinity** .
- ▶ Search using categories, enter a search entry or search for a personal POI (→ page 291).
- ▶ Select a POI. The destination address is shown. The route can be calculated.

### Other menu functions

- ▶ **To save the destination:** select .
- ▶ Select an option.

The following options are available:

- **Save in "Previous Destinations"**
- **Save as Favorite**
- **Save as "Home"**



- Save as "Work"

- ▶ **To call the destination:** if a telephone number is available, select [Call](#).
  - ▶ **To share the destination using NFC or QR code:** select [Share via NFC or QR Code](#).
  - ▶ Hold the NFC area of the mobile phone (see manufacturer's operating instructions) on the mat or place the mobile phone on it (→ page 331).
- or
- ▶ Hold the mobile phone near to the multimedia system and scan the QR code.
  - ▶ **To call up an Internet address:** if a web address is available, select [www](#).
  - ▶ **To show on the map:** select [Show on Map](#).

### Selecting a route type

Multimedia system:



▶▶ [Navigation](#) ▶▶ [Settings](#)

▶▶ [Advanced](#) ▶▶ [Route](#)

- ▶ Select the route type.  
If no route has been created, the next route is calculated on the basis of the new route type.  
If a route has already been created, the route is calculated on the basis of the new route type.

The following route types are available:

- **Fast**  
A route with a quick journey time is calculated.
- **Short**  
A route with a short driving distance is calculated.
- **Eco**  
An economical route is calculated. The journey time may be somewhat longer than for quicker routes.

- **Trailer**

The option is available if a trailer has been coupled with the vehicle.

A prompt is shown in the multimedia system. Confirm the prompt.

The route is optimized for trailer operation.

### For these route types you can select the following dynamic route guidance options:

- ▶ Select [Dynamic Route Guidance](#) .
- ▶ Select [Automatic, On Request](#) or [Off](#).

Explanation of the options:

- **Automatic**  
The route is calculated with the currently set route type.  
Traffic reports via Live Traffic Information are taken into account (→ page 312).  
Live Traffic Information is not available in all countries.
- **On Request**  
A prompt appears when a new route is detected with a shorter journey time based on traf-

fic reports. You can continue to use the current route or use the dynamic route instead (→ page 298).

- **Off**

No traffic reports are taken into account for the route.

### Calculating alternative routes

- ▶ Activate [Suggest Alternative Route](#). The display button is activated. Alternative routes are calculated for every route.
- ▶ Select an alternative route (→ page 302).

### Accepting a detour recommendation after a prompt

#### Requirements:

- [On Request](#) is switched on • in the [DYNAMIC ROUTE GUIDANCE](#) menu (→ page 297).
- Route guidance is active.
- There are traffic reports for the current route.

If a new route with a shorter driving time is determined, the current and new routes will be shown.

The notification is shown in another application. Confirm the notification.

- ▶ **To accept the new route:** select [Accept Recommended Detour](#).
- ▶ **To maintain the current route:** select [Keep to Current Route](#).

### Selecting route options

Multimedia system:



### Avoiding areas

- ▶ Select [Avoid Options](#).
- ▶ Select [Avoid Areas](#) (→ page 319).

### Avoiding or using highways, ferries, tunnels, motorail trains, unpaved roads

- ▶ Select [Avoid Options](#).

- ▶ Activate or deactivate the avoid option.

**To avoid:** the display button is activated. The route avoids highways, for example.

**To use:** the display button is off. The route takes highways into consideration, for example.

These route options are not available in every country.

The selected route options cannot always be taken into account. Therefore, a route may include a ferry, for instance, even though the [Avoid Ferries](#) avoid option is enabled. A message then appears and you will hear a corresponding message.

### Avoiding or using toll roads

- ▶ Select [Avoid Options](#).
  - ▶ Select [Toll Roads](#).
  - ▶ Switch [Avoid All](#) on or off.
- To avoid:** the display button is activated. The route avoids all toll roads.
- To use:** the display button is off. The route takes into account all roads that require the payment of a usage fee (toll).

or

- ▶ **To avoid a type of payment:** select [Avoid](#).  
The route avoids all toll roads with the selected method of payment.
- ▶ **To use a type of payment:** select [Use](#).  
The route takes into account all toll roads with the selected method of payment.

These route options are not available in every country.

### Using carpool lanes

When using carpool lanes, observe the applicable legal requirements as well as any conditions pertaining to when and where such lanes may be used. Carpool lanes may only be used if certain conditions are met.

Carpool lanes are not available in all countries.

- ▶ Select [Avoid Options](#).
- ▶ Select [Carpool Lanes](#).
- ▶ Select [For Two Occupants](#) or [For 3 Occupants or More](#) .

or

- ▶ Select [On Request](#) .

When this option is selected and a carpool lane is available, a prompt appears. You can continue to use the current route or select a route with the carpool lane.

- ⓘ If the [Avoid](#) option is selected, then no carpool lanes will be used for the route.

### Selecting notifications for the route

#### Requirements:

- **For an audible indication when approaching a personal POI:** the USB device contains personal POIs.
- The USB device is connected with the multimedia system.
- The category in which the personal POI belongs is activated.

Multimedia system:



▶▶ [Advanced](#) ▶▶ [Announcements](#)

- ▶ Switch [No Driving Recomm.](#) on or off.  
No navigation announcements are issued when the display button is switched on.

- ▶ **To select a navigation announcement:** select an option  under the [DRIVING RECOMMENDATION](#) category.

The following options are available:

- [Tone Only](#)  
In place of the spoken navigation announcement you hear a gong. The gong signals an upcoming driving maneuver and also sounds during the driving maneuver.
- [Reduced Driving Recomm.](#)  
If a navigation announcement is available, you hear a brief announcement, e.g. "turn right".
- [Detailed Driving Recomm.](#)  
If a navigation announcement is available and the [Announce Street Names](#) option is switched on, you hear a complete announcement, e.g. "In 600 ft (200 m) at the end of the street turn right into Station Road".

▶ **To have street names announced during a driving maneuver:** switch on [Announce Street Names](#).

▶ Select [Reduced Driving Recomm.](#) or [Detailed Driving Recomm.](#)

The name of the street into which you should turn is announced.

ⓘ The options in the [DRIVING RECOMMENDATION](#) category are not available in every country and in all languages.

### Selecting messages for **TRAFFIC**

▶ Activate a message.

The display button is activated.

The following options are available:

- [Traffic Incidents](#)

Traffic incidents are announced, e.g. roadworks and road blocks.

This function is not available in all countries and languages.

- [Announce Traffic Warnings](#)

Warning messages are announced, e.g. before tailbacks that pose a risk (if available).

This function is not available in all countries and languages.

### Audible indication when approaching a personal POI

▶ Select the [Personal POIs](#) option in the [ALERTS](#) category.

▶ Activate a category.

The display button is activated. When approaching a personal POI in this category an audible indication will be issued.

### Showing destination information for the route

#### Requirements:

- A destination is entered.

Multimedia system:



▶ Select [Route Overview](#).

When route guidance is active, the destination and intermediate destinations are shown, if these have been entered and not yet been passed.

The route can include up to four intermediate destinations.

▶ Select a destination or an intermediate destination.

The following information is displayed:

- Remaining driving distance
- Time of arrival
- Remaining journey time
- Name, destination address
- Phone number (if available)
- Web address (if available)

## Planning routes

Multimedia system:

  **»» Navigation**

**»»**  **»» Route Overview**







- ▶** Select **Set Way Point**.
  - ▶** Enter the intermediate destination as a POI or address, for example (→ page 288).
  - ▶** Select the intermediate destination. After selection of an intermediate destination, the route overview is shown again.
  - ▶** Calculate the route with intermediate destinations (→ page 301)
- i** If there are already four intermediate destinations, delete an intermediate destination (→ page 301).

## Editing a route with intermediate destinations

Multimedia system:

  **»» Navigation**

**»»**  **»» Route Overview**

- ▶** **To change the sequence of destinations:** select  for a destination. A menu opens.
- ▶** Select **Move**.  is highlighted.
- ▶** Move the intermediate destination or the destination with  or  to the desired position.
- ▶** Tap on .
- ▶** **To delete a destination:** select  for an intermediate destination or destination.
- ▶** Select **Delete**. The destination is deleted.

## Calculating a route with intermediate destinations

**Requirements:**

- The destination and at least one intermediate destination have been entered.

Multimedia system:

  **»» Navigation**

**»»**  **»» Route Overview**

**▶** Select **Start Route Guidance**.

or

- ▶** If the route has been edited, select **To Navigation** .
- ▶** Confirm the prompt with **Yes**. The route is calculated. Route guidance begins.

## Displaying the route list

Multimedia system:

  **»» Navigation** **»»** 

- ▶** Select **Route List**. The route sections are displayed. The current vehicle position is marked on the map.

The current vehicle position is shown with the following information:

- The  symbol for the current vehicle position is displayed.
- The name of the road on which you are currently driving is shown.
- The road number of the road on which you are currently driving is shown.

The route list is updated during the journey.

- ▶ **To show route sections:** swipe up or down on the control element.

The route section is shown on the map.

### Selecting an alternative route

#### Requirements:

- The [Suggest Alternative Route](#) option is switched on (→ page 297).

Multimedia system:



- ▶ Select [Alternative Routes](#).

The routes are displayed in accordance with the setting made in the route settings.

The routes are numbered.

- ▶ Select the alternative route.

- ▶ **To show the route on the map:** select [Show on Map](#).

- ▶ Move the map (→ page 316).

- ▶ Set the map scale (→ page 316).

- ▶ **To avoid or use route options:** select .

- ▶ Switch the route option, e.g. [Highways](#), on or off.

**To avoid:** the display button is activated. The alternative route avoids highways.

**To use:** the display button is off. The alternative route uses highways.

### Activating a commuter route

#### Requirements:

- You have created a profile (→ page 255).
- The [Allow Destination Suggestions](#) option is switched on (→ page 260).
- The [Activate Commuter Route](#) option is switched on.

- The multimedia system has gathered sufficient data in order to show destination suggestions.
- Routes have been learned for these destination suggestions.

- ⓘ This commuter route is not available in all countries.

Multimedia system:



- ▶ [Advanced](#) ▶ [Route](#)

- ▶ Activate [Activate Commuter Route](#).

The display button is activated. The navigation system automatically detects that the vehicle is on a commuter route. It automatically starts a route guidance without voice output.

For the daily commuter route, traffic incidents on the route are also reported when driving without active route guidance.

### Switching the automatic gas station search on/off

Multimedia system:

→  → Settings → Vehicle

- ▶ Switch **Gas Station Search** on or off. When the fuel reserve level is reached, and the display button is switched on, a message appears to start searching for gas stations.

### Starting an automatic gas station search

#### Requirements:

- The automatic gas station search is activated (→ page 303).

#### Driving situation

The fuel level in the fuel tank reaches the reserve fuel level.

The following notification is shown in the media display **Reserve Fuel Tap here to search for gas stations**.

- ▶ Confirm the notification. The automatic gas station search begins. The available gas stations along the route or in

the vicinity of the vehicle's current position are displayed.

- ▶ Select a gas station. The address of the gas station is displayed.
- ▶ Calculate the route (→ page 296). The gas station is set as the destination or the next intermediate destination.
- ▶ **If there are already four intermediate destinations:** select **Yes** in the prompt. The gas station is entered in the route overview. Intermediate destination 4 is deleted. Route guidance begins.

### Starting the automatic service station search

#### Requirements:

- ATTENTION ASSIST and the **Suggest Rest Area** function are activated (→ page 199).
- There are service stations along the route section ahead.

#### Driving situation

The following notification is shown in the media display **ATTENTION ASSIST Tap here to search for rest areas**.

- ▶ Confirm the notification. The service station search starts. The available service stations along the route or in the vicinity of the vehicle's current position are displayed.
- ▶ Select a service station. The service station address is displayed.
- ▶ Calculate the route (→ page 296). The service station is set as the destination or the next intermediate destination.
- ▶ **If there are already four intermediate destinations:** select **Yes** in the prompt. The service station is entered in the route overview. Intermediate destination 4 is deleted. Route guidance begins.

### Showing a stored route on the map

#### Requirements:

- A USB device with stored routes is connected with the multimedia system (→ page 364).
- The route is stored in the "Routes" folder with the GPS Exchange format (.gpx).

Multimedia system:

→  » Navigation »  Where to?  
» SAVED ROUTES

- ▶ Select a route.
- ▶ Select [Show on Map](#).
- ▶ Move the map (→ page 316).

#### Starting a saved route



##### Requirements:

- A USB device with stored routes is connected with the multimedia system (→ page 364).
- The route is stored in the "Routes" folder with the GPS Exchange format (.gpx).

Multimedia system:

→  » Navigation »  Where to?  
» SAVED ROUTES

- ▶ Select a route.
- ▶ Select [Start Route Guid. from Beginning of Route](#) or [Start Route Guidance from Curr. Position](#).  
Route guidance starts.



 The route can be saved with  in the menu (→ page 296).

#### Recording a route

##### Requirements:

- A USB device is connected with the multimedia system (→ page 364).

Multimedia system:

→  » Navigation »  Where to?  
» SAVED ROUTES

- ▶ **To start recording:** select [Start Recording a New Route](#).  
A red recording symbol is shown.  
The route is stored on the USB device.
- ▶ **To stop recording:** select [End Recording](#).

#### Saving a recorded route

##### Requirements:

- A USB device is connected with the multimedia system (→ page 364).

Multimedia system:

→  » Navigation »  Where to?  
» SAVED ROUTES

- ▶ Select a route.
- ▶ Select .
- ▶ Select [Save in "Previous Destinations"](#).  
The route is stored in the "Previous destinations" memory and can be called up from there for route guidance.

#### Editing a stored route

##### Requirements:

- A USB device with stored routes is connected with the multimedia system (→ page 364).

Multimedia system:

→  » Navigation »  Where to?  
» SAVED ROUTES

- ▶ Select a route with .
- ▶ **To enter a name:** select [Change Name](#).
- ▶ Enter the name.



▶ Select **OK**.  
or

▶ When the name has been changed, press the  button.

▶ Select **Yes**.

▶ **To delete a route:** select **Delete**.

▶ Select **Yes**.

## Route guidance

### Notes on route guidance

**⚠ WARNING** Risk of distraction from operating integrated communication equipment while the vehicle is in motion

If you operate communication equipment integrated in the vehicle when driving, you will be distracted from the traffic situation. This could also cause you to lose control of the vehicle.

▶ Only operate this equipment when the traffic situation permits.

▶ If you cannot be sure of this, stop the vehicle whilst paying attention to road and traffic conditions and operate the equipment with the vehicle stationary.

You must observe the legal requirements for the country in which you are currently driving when operating the multimedia system. Route guidance begins once a route has been calculated.

The road and traffic rules and regulations always have priority over multimedia system driving instructions.

Driving instructions are:

- Navigation announcements
- Route guidance displays
- Lane recommendations

If you do not follow the driving instructions or if you leave the calculated route, a new route is calculated automatically.

Driving instructions may differ from the actual road and traffic conditions if:

- The route is diverted

- The direction of a one-way street has been changed

For this reason, you must always observe road and traffic rules and regulations during your journey as well as the prevailing traffic conditions.

The route may differ from the ideal route due to the following:

- Roadworks
- Incomplete digital map data

### Notes on GPS reception

The correct function of the navigation system depends amongst other things on GPS reception. In certain situations GPS reception can be impaired, defective or even not possible, e.g. in tunnels or in parking garages.

### Changing direction overview

Changes of direction are shown in the following displays:

- Detailed image of the intersection

The display appears when you drive into an intersection.

- 3D image

The display appears when driving on intersection-free, multi-lane roads, for example on freeway exits and freeway interchanges.



Example: 3D image of the upcoming change of direction

- ① Driving maneuver
- ② Maneuver point, above this the current distance to the change of direction
- ③ Current vehicle position

There are three phases when changing direction:

- Preparation phase

If there is enough time between the changes of direction, the multimedia system prepares you for the upcoming change of direction. A navigation announcement is issued depending on the settings for driving recommendations, e.g. "Prepare to turn right".

Select navigation announcements for driving recommendations (→ page 299).

The map appears in full-screen mode.

The status line shows: the direction information or the name of the road which is to be turned into and the distance to the change of direction.

- Announcement phase

The multimedia system announces the upcoming change of direction depending on the settings for driving recommendations, e.g. by announcing "In 600 ft (200 m) at the end of the street turn right into Station Road".

The display is split into two parts. The map is displayed on the left; on the right, there is a detailed image of the intersection or a 3D image of the upcoming change of direction.

- Change-of-direction phase

The multimedia system announces the imminent change of direction depending on the settings for driving recommendations, e.g. by announcing "Now turn right".

The display is split into two parts.

The change of direction takes place when the distance to maneuver point ② is shown with 0 ft (0 m) and the symbol for vehicle position ③ has reached maneuver point ②.

When the change of direction is complete, the map appears in full-screen mode.

- ① Changes of direction are also shown in the Instrument Display.

### Lane recommendations overview

This display appears for multi-lane roads.

The multimedia system can show lane recommendations if the digital map contains the relevant data.

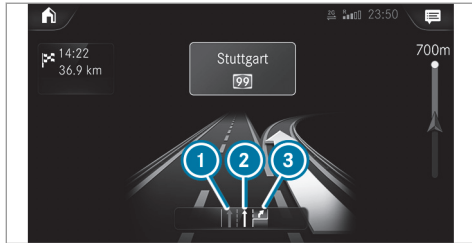

- ① Lane not recommended (gray arrow)
- ② Possible lane (white arrow)
- ③ Recommended lane (white arrow, blue background)

Explanation of the displayed lanes:

- Lane not recommended ①  
In this lane, you will not be able to complete the next change of direction without changing lane.
- Possible lane ②  
In this lane, you will only be able to complete the next change of direction.
- Recommended lane ③

In this lane, you will be able to complete both the next change of direction and the one after that.

During the change of direction, new lanes may be added.

Bus lanes are also shown.

- ① Lane recommendations can also be displayed in the Instrument Display and in the Head-up Display.

### Using freeway information

#### Requirements

- The [Highway Information](#) option is switched on (→ page 318).

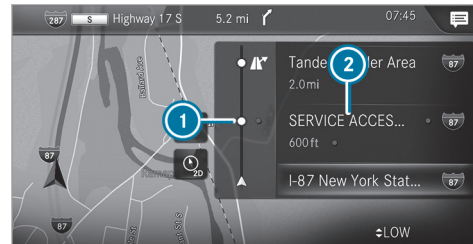

When driving on the freeway, upcoming freeway facilities ① and available service facilities ② are shown in the overview. These include gas stations, parking lots, service stations and freeway exits, for example.

▶ **To open the display:** select .

The entries are sorted according to increasing distance from the current vehicle position.

▶ **To close the display:** tap on the map.

or

▶ **To use freeway information:** select an entry.

▶ If several service facilities are available, select a service facility from the list. The destination address and the map position are shown.

▶ Calculate the route (→ page 296).

or

▶ Search for a POI in the vicinity.

or

▶ Use other functions, e.g. save the destination address of the service facility.

### Using quick-access for a destination information, alternative route and POIs

#### Requirements:

- The POI categories for quick-access are configured (→ page 291).

- ▶ If route guidance is active, select the  symbol with arrival time and distance to the destination on the map.  
The address of the destination or the next intermediate destination is shown.

#### Using alternative routes

- ▶ Select **Alternative Route**.  
The routes are displayed in accordance with the setting made in the route settings.  
The routes are numbered.
- ▶ Select the alternative route.

#### Setting a POI as an intermediate destination

- ▶ Select a category symbol, e.g.  for a parking lot.

- ▶ Select a POI from the list.  
The selection takes place on the route. The destination address is shown. The route can be calculated.
  - ▶ **To use POI categories for quick-access:** select a search position **In the Vicinity, Near Destination** or **Along the Route**.
  - ▶ Select a POI from the list.
- or
- ▶ Enter a search entry into the search field and filter the list.
  - ▶ Select a POI from the list.  
The destination address is shown. The route can be calculated.

#### Saving the current vehicle position

- ▶ Select **Save Position**.  
The current vehicle position is saved to the "Previous destinations" memory.

#### Destination reached





Once the destination is reached, you will see the  checkered flag. Route guidance is finished. The navigation menu is shown.

When an intermediate destination has been reached, you will see the intermediate destination flag with the number of your  intermediate destination. Route guidance is continued.

#### Switching navigation announcements on/off

- ▶ **To switch off:** turn the volume control on the steering wheel or next to the touchpad during a navigation announcement (→ page 266).  
The **Voice Guidance has been deactivated** message appears.

or



- ▶ Show the navigation menu (→ page 286).
- ▶ Select .  
The symbol changes to .
- ▶ **To activate:** select .  
The current navigation announcement is played.  
The symbol changes to .

- ⓘ This function can be added and called up from the favorites within the navigation category.

### Switching navigation announcements on or off during a phone call

- ▶ Press the  button on the steering wheel or on the touchpad.

or

- ▶ Tap on  in the media display.
- ▶ Select **Settings**.
- ▶ Select **System**.
- ▶ Select **Audio**.
- ▶ Select **Navigation and Traffic Announcements**.
- ▶ Switch **Voice Guidance During Call** on or off. When the option is switched on, the display button is activated.
- ▶ **To leave the menu:** select .

### Adjusting the volume of navigation announcements

Multimedia system:

- ▶  **▶▶ Settings ▶▶ System ▶▶ Audio**
- ▶▶ **Navigation and Traffic Announcements**
- ▶ Select **Voice Guidance Volume**.

- ▶ Set the volume.
- ▶ **To leave the menu:** select .



### Route guidance is active

- ▶ Turn the volume control on the steering wheel or next to the touchpad during a navigation announcement.

### Switching audio fadeout on or off during navigation announcements

- ▶ Press the  button on the steering wheel or on the touchpad.

or

- ▶ Tap on  in the media display.
- ▶ Select **Settings**.
- ▶ Select **System**.
- ▶ Select **Audio**.
- ▶ Switch **Audio Fadeout** on or off. When the option is switched on, the display button is activated.
- ▶ **To leave the menu:** select .



### Repeating navigation announcements

#### Requirements:

- A route has already been created.
- Route guidance is active.

Multimedia system:

- ▶  **Navigation** (Navigation)

- ▶ Select .
- ▶ Select . The current navigation announcement is repeated.

- ▶  This function can be added and called up from the favorites within the navigation category.

### Canceling route guidance

#### Requirements:

- a route has already been created.
- route guidance is active.
- ▶ Show the navigation menu.
- ▶ Select  in the navigation menu (→ page 287).

### Overview of route guidance to an off-road destination

An off-road destination is within the digital map. The map contains no roads that lead to the destination.

You can enter geo-coordinates or a 3 word address for off-road destinations on the map.

Route guidance guides you for as long as possible with navigation announcements and displays on roads that are known to the multimedia system.

Shortly before you reach the last known position on the map, you will hear the "Please follow the direction arrow" announcement, for example. The display shows a direction arrow and the linear distance to the destination.

### Overview of route guidance from an off-road location to a destination

In an off-road position, the current vehicle position is located within the digital map on roads that are not available.

The following displays appear when route guidance begins:

- A message appears that the road is not on the map.
- A direction arrow showing the linear direction to the POI.

When the vehicle is back on a road known to the multimedia system, route guidance continues as normal.

### Overview of off-road status during route guidance

Due to roadworks, for example, there may be differences between the data on the digital map and the actual course of the road. In such cases, the multimedia system will temporarily be unable to locate the vehicle's current position on the digital map. The vehicle is off-road.

When the vehicle is off-road, the following displays are shown:

- A message appears that the road is not on the map.
- A direction arrow showing the linear direction to the POI.

When the vehicle is back on a road known to the multimedia system, route guidance continues as normal.

## Destination

### Saving the current vehicle position

Multimedia system:

   Navigation   Position

- ▶ Select [Save Position](#).  
The current vehicle position is saved to the "Last destinations" memory.

### Using quick-access

- ▶ If route guidance is active, select the  symbol with arrival time and distance to the destination on the map.  
The address of the destination or the next intermediate destination is shown.
- ▶ Select [Save Position](#).

## Editing the previous destinations

### Requirements:

- To edit destination suggestions: the [Allow Destination Suggestions](#) option is activated (→ page 260).
- The multimedia system has gathered sufficient data in order to show destination suggestions.

Multimedia system:







 Navigation
 
 Where to?
   

 PREV. DESTINATIONS



The following entries can be edited:

- Destination suggestions
  - Destinations
  - Routes
- ▶ **To no longer display a destination suggestion:** select  for a destination suggestion.
- ▶ Select [No Longer Suggest](#).

## Saving the last destination as a favorite

-  After saving, the destination can be called up via the favorites (→ page 261).
- ▶ Select  for a destination.
  - ▶ Select  [Save as Favorite](#).
  - ▶ **To save as a favorite:** select [Save as Favorite](#).
  - ▶ **To save as "Home" address:** select [Save as "Home"](#).
  - ▶ **To save as "Work" address:** select [Save as "Work"](#).

## Deleting a previous destination

- ▶ **To delete a destination:** select  for a destination.
- ▶ Select [Delete](#).
- ▶ Select [Yes](#).
- ▶ **To delete all destinations:** select .
- ▶ Select [Delete All](#).
- ▶ Select [Yes](#).

## Using external destinations and routes

External destinations and routes can be received from the following sources, for example:

- Mercedes-Benz Apps
- door-to-door navigation with the Companion app (USA)
- a call with the Mercedes-Benz Customer Assistance Center via the me button (→ page 347)

A prompt appears on the media display. Received destinations and routes are saved in the previous destinations.

- ▶ **A destination has been received:** select [Yes](#).
  - ▶ Calculate the route.
  - ▶ If route guidance is already active, select [Set as Way Point](#) or [Start New Route Guidance](#).
- or
- ▶ If a destination was received with photo information, select [Start Route Guidance](#).
  - ▶ Calculate the route.
- or

- ▶ If a destination has been received from an app, select [Details](#).
- ▶ Calculate the route.
- ▶ **A route has been received:** select [Yes](#).
- ▶ Select [Start Route Guid. from Beginning of Route](#) or [Start Route Guidance from Curr. Position](#).  
Route guidance starts from the selected position.

### Route guidance with current traffic reports

#### Traffic information overview

Traffic reports are received using Live Traffic Information and are used for route guidance.

This service is unavailable in some countries.

- ⓘ There may be differences between the traffic reports received and the actual road and traffic conditions.

Important information on Live Traffic Information:

- Current traffic reports are received via the Internet connection.

- The traffic situation is updated at short, regular intervals.
- Subscription information shows the status (→ page 312).

Information on the vehicle's position is regularly sent to Daimler AG. The data is immediately rendered anonymous by Daimler AG and forwarded to the traffic data provider. Using this data, traffic reports relevant to the vehicle's position are sent to the vehicle. The vehicle acts as a sensor for the flow of traffic and helps to improve the quality of the traffic reports.

If you do not want to transmit the vehicle position, you have the following options:

- You deactivate the service in the Mercedes me portal.
- You have the service deactivated at an authorized Mercedes-Benz Center.

#### Showing information from the service provider for Live Traffic Information

##### Requirements:

- The vehicle is equipped with Live Traffic Information.

Multimedia system:

→  ▶ [Navigation](#) ▶  ▶ [Traffic](#)

- ▶ Select [Provider Information](#).

The logo of the service provider for Live Traffic Information is shown.

- ⓘ Further information on Live Traffic Information can be called up on the home screen using [Mercedes me & Apps](#) (→ page 349).
- ⓘ The subscription can be extended:
  - at any authorized Mercedes-Benz Center
  - with a call to the Mercedes-Benz Customer Assistance Center via the me button

#### Showing traffic information

##### Requirements:

- The [Traffic](#) display is switched on (→ page 314).
- The following traffic displays are switched on (→ page 314):

[Traffic Incidents](#)

[Free Flowing Traffic](#)



## Delay

Multimedia system:



▶ Select **Navigation**.

The map shows the following traffic information:

- traffic incidents, for example:
  - roadworks
  - road blocks
  - warning messages

When route guidance is active, the symbols for traffic incidents will be shown in color on the route. Off the route they are gray.

- warning message symbols:
  - Symbol 
  - road safety notes, e.g. when approaching the end of a traffic jam  
If the vehicle approaches a danger area on the route, a warning message is displayed on the map. In addition, an audible notification can follow a hazard warning.
- traffic flow information:

- traffic jam (red line)
- slow-moving traffic (orange line)
- heavy traffic (yellow line)
- free-flowing traffic (green line)
- display for traffic delays on the route lasting at least one minute

## Displaying traffic incidents

### Requirements:

- The **Traffic Incidents** display is switched on (→ page 314).

Multimedia system:





- ▶ Select **Traffic Announcements**.  
If there are traffic reports, you will see a list. Traffic reports include accidents and other traffic events, for example. The list is sorted according to distance and shows the traffic reports received both on and off the route.  
A traffic report shows the following information:
  - Street number or street name

- Traffic incident symbol  
On the route: color  
Off the route: gray
- Cause
- Street symbol for a traffic incident on the route
- Distance from current vehicle position
- ▶ Select a traffic report .  
The detailed information is shown, for example the route section.

## Showing traffic incidents in the vicinity of the map

- ▶ Select a traffic incident symbol on the map. The details about the traffic incident are displayed.
- ▶ Select .
- ▶ Select **Traffic Incidents in Vicinity**.  
The map shows the traffic incident symbols in the vicinity.  
Traffic incident information is displayed in the status line:
  - Traffic incident symbol

- Cause of the traffic incident, e.g. construction work
- Warning message (highlighted red)

▶ **To select a traffic incident symbol:** select  or .

▶ **To select a map section:** tap on the touchscreen.

or

▶ Press the Touch Control or the touchpad.

▶ Move the map.

▶ **To return to the navigation map:** tap on .

or

▶ Press the  button on the Touch Control or on the touchpad.

### Switching the traffic information display on

Multimedia system:



- ▶ Activate **Traffic**.  
The display button is activated.

### Activating Incidents, Free Flow and Delay

▶ Select **Advanced**.

▶ Select **View**.

▶ Select **Map Elements**.

▶ In the **TRAFFIC** category, activate the **Traffic Incidents, Free Flowing Traffic** and **Delay** entries.

The display buttons are activated.

If traffic information has been received, then traffic incidents such as roadworks, road blocks, local area reports (e.g. fog) and warning messages are displayed.

The traffic delay is displayed for the current route. Traffic delays lasting one minute or longer are taken into consideration.

### Showing local area messages

Multimedia system:



- ▶ Select **Area Alerts**.  
Local area messages are shown, for example fog or heavy rain.

- ▶ Select a local area message.  
The details are displayed.

### Car-to-X-Communication

#### Car-to-X-Communication overview

The following requirements apply for using Car-to-X-Communication:

- The vehicle is equipped with a multimedia system featuring navigation and a communication module with an activated, integrated SIM card.
- Car-to-X-Communication is activated.

 Car-to-X-Communication is available in selected countries.

The communication module automatically establishes an Internet connection once the ignition is switched on. If there are any hazard warnings, they will be provided shortly thereafter. Depending on the mobile phone connection, the provision takes place from within a second up to about a minute.

### Benefits of Car-to-X-Communication:

- Hazards are recognized automatically in the background by the vehicle or may be reported by the driver. These are then sent to vehicles with Car-to-X-Communication in the immediate vicinity.
- If available, current details relating to hazard spots near the vehicle's current position are received.

This gives you sufficient time to adapt your driving style to the traffic conditions.

The use of Car-to-X-Communication requires the regular transmission of vehicle data to Daimler AG. The data is then immediately pseudonymized by Daimler AG. The vehicle data is deleted after an appropriate amount of time has elapsed (several weeks) and is not stored permanently.

- ① Data which serves as identification is replaced during the pseudonymization process. In this way, your identity is protected against access by unauthorized third parties.

### Displaying hazard warnings

Multimedia system:

  **Navigation** (Navigation)

If hazard warnings are available these can be shown as symbols on the map. The display depends on the settings for the **Traffic** and **Traffic Incidents** options.

- ▶ Set the options (→ page 314).

The following displays are available:

- Show all symbols  
The **Traffic** and **Traffic Incidents** options are switched on.
- Only show symbols on the expected route  
The **Traffic** option is switched off, the **Traffic Incidents** option is switched on.
- Show no symbols  
The **Traffic Incidents** option is switched off.

The following hazard warnings are shown on the map:

- Broken-down vehicles
- Accidents

- Hazardous weather
- General hazards
- Hazard warning lights, when switched on
- Crosswind warning
- ① If the vehicle is approaching a hazard spot with a vehicle speed of at least 37 mph (60 km/h), the voice output "Traffic incident ahead" is issued.  
The voice output is not issued for hazardous weather.

### Sending hazard warnings

Automatically detected hazard warnings are sent by the vehicle.

- ▶ **To send a hazard warning yourself:** tap on the media display when the map is shown. The navigation menu is shown.
- ▶ Select .
- ▶ Select **Report Traffic Incident**. A prompt is shown.
- ▶ Select **Yes**.  
The **Thank You for Supporting Accident Prevention** message appears.

## Map and compass

### Setting the map scale

Multimedia system:



### Zooming in

- ▶ When the map is shown, tap twice quickly with one finger on the media display or the touchpad.

or

- ▶ Move two fingers apart on the media display or on the touchpad.

### Zooming out

- ▶ Tap with two fingers on the media display or the touchpad.

or

- ▶ Move two fingers together on the media display or on the touchpad.

- ① You can set the unit of measurement of the map scale (→ page 282).

### Moving the map

Multimedia system:

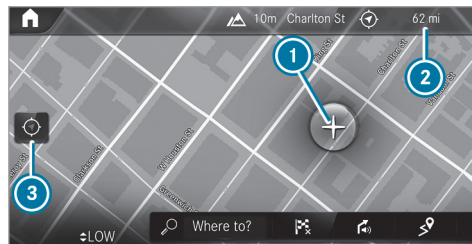

- ▶ **On the touchscreen:** move the finger in any direction when the map is shown.
- ▶ **On the touchpad:** call up the navigation menu by pressing.
- ▶ Swipe your finger up.
- ▶ Press the touchpad. Crosshair ① appears. The map can be moved.

- ▶ Touch the touchpad and move your finger in any direction. The map moves in the opposite direction under crosshair ①.

When the map has been moved the following information appears in the status line, for example:

- Distance ② from the vehicle's current position is shown.
- Information about the current map position is shown, e.g. the name of the road.

The following functions are available:

- Select a destination on the map (→ page 294).
- Select a POI (→ page 291).
- Show traffic incidents on the map (→ page 313).
- ▶ **To reset the map to the current vehicle position:** select ③.

### Rotating the map

- ▶ With two fingers, rotate counter-clockwise or clockwise on the media display or the touchpad.

### Selecting the map orientation

Multimedia system:



#### ▶▶ Advanced

- ▶ Select **View**.
- ▶ Select **Map Orientation**.
- ▶ Select an option.  
The ● dot indicates the current setting.

The following options are available:

- **2D Heading Up** option: the 2D map view is aligned to the direction of travel.
- **2D North Up** option: the 2D map view is displayed so that north is always at the top.
- **3D** option: the 3D map view is aligned to the direction of travel.

or

- ▶ **To use quick-access:** repeatedly tap or press on the compass symbol on the map.  
The view changes in the sequence **3D**, **2D Heading Up** to **2D North Up**.  
If the map is moved, it can switch between **3D** and **2D North Up**.

### Selecting POI symbols for the map display

Multimedia system:



POIs include gas stations and hotels, for example. These can be displayed as symbols on the map. Not all POIs are available everywhere.

Personal POIs are destinations which you have saved on a USB device, for example.

- ① The display of POI symbols on the map can be activated or deactivated as a favorite.
- ▶ **To switch on/off using quick-access:** if available, switch **POI Symbols** on or off.  
The POI symbols for the selected categories are shown on the map.

or

- ▶ **To switch on/off in the menu:** select **Advanced**.
- ▶ Select **View**.
- ▶ Select **Map Elements**.
- ▶ Select **POI Symbols** .  
The **POI SYMBOLS** menu is shown.
- ▶ Switch **Display POIs** on or off.



### Selecting categories

- ▶ Select **All Categories** in the **POI SYMBOLS** menu.
- ▶ Switch **Show All** on or off.  
When the option is switched on, the POI symbols for all categories are shown on the map.

or

- ▶ Select the categories and sub-categories (if available) .
- ▶ Activate or deactivate the categories.  
The POI symbols for the selected categories are shown on the map.

### Selecting personal POI categories

- ▶ Select  in the **POI SYMBOLS Personal POIs** menu.
- ▶ Select a category .
- ▶ Switch **Show on Map** on or off. When the display is switched on and the vehicle approaches a personal POI in this category, a visual and audible notification can be issued.
- ▶ **To set a notification when approaching:** select a category or a personal POI .
- ▶ Switch **Visual Notification** and **Acoustic Notification** on or off.

### Switching display of categories for quick-access on/off

- ▶ Switch a category on or off in the **POI SYMBOLS** menu.

### Resetting the POI symbol display

- ▶ Select **POI SYMBOLS Reset POIs** in the menu. The settings are reset to the standard settings.

### Selecting the display of text information in the map

Multimedia system:



- ▶ Select **View**.
- ▶ Select **Text Information**.
- ▶ Select an option in the **FOOTER** category. The • dot indicates the current setting.

The following options are available:

- **Current Street** option  
The street you are currently on is shown in the bottom bar.  
When the map is moved, the street name, the POI name or the area name appears under the crosshair.
- The **Geo-coordinates** option shows the following information in the bottom bar:
  - longitude and latitude
  - elevation  
The elevation shown may deviate from the actual elevation.

- **None** option  
The media display shows no text information in the bottom bar.

### Switching freeway information on/off

Multimedia system:



- ▶ **Using quick-access:** switch **Highway Information** on or off. The display button is activated or off.
- or
- ▶ **Using the menu:** select **Advanced**.
  - ▶ Select **View**.
  - ▶ Select **Text Information**.
  - ▶ Switch **Highway Information** on or off. When the display button is switched on, additional information about the freeway facilities ahead appears during the freeway journey. These include parking lots, service stations and freeway exits, for example.

## Displaying the next intersecting street

### Requirements:

- Route guidance is not active.

Multimedia system:



▶▶ Advanced

▶ Select **View**.

▶ Select **Text Information**.

▶ Activate **Next Intersecting Street**.

The display button is activated. If the option is switched on and the journey continues without route guidance, the name of the next intersecting street will be displayed at the upper edge of the display.

### Displaying the map version

Multimedia system:



▶▶ Advanced

▶ Select **View**.

▶ Select **Map Version**.

The detail information is displayed.

- ❶ The online map update service from Mercedes me connect can be used to update the map data (→ page 320). A message is shown in the media display when a new map version is available.
- ❷ Information about new versions of the digital map can be obtained from an authorized Mercedes-Benz Center.

### Overview of avoiding an area for the route

You can define areas along a route that you would like to avoid.

Highways or multi-lane highways, which are routed through an area to be avoided are taken into account for the route.

### Avoiding a new area for the route

Multimedia system:



▶▶ Advanced ▶▶ Route ▶▶ Avoid Options

▶▶ Avoid Areas

▶ Select **Avoid New Area**.

▶ **To start in the map:** select **Using Map**.

▶ Move the map (→ page 316).

- ▶ **To start via destination search:** select **Via Address Entry**.
- ▶ Enter the address (→ page 288).
- ▶ Select the destination in the list or accept with **OK**.  
The map appears.
- ▶ **To show an area:** tap or press on the control element.  
A red rectangle appears. This designates the area that should be avoided.
- ▶ **To change the map scale:** move two fingers apart or together on the media display or on the touchpad.  
The map is zoomed in or out.
- ▶ **To set an area:** select **OK**.  
The **Avoid area has been set**. message appears. The area is entered into the list.

### Changing an area to be avoided

Multimedia system:



» Advanced » Route » Avoid Options

» Avoid Areas

- ▶ Select an area in the list.
- ▶ Select **Edit**.
- ▶ **To move an area on the map:** swipe in any direction on the control element.
- ▶ **To change the size of the area:** tap or press on the control element.
- ▶ Swipe up or down on the control element.
- ▶ Select **OK**.  
The **Avoid area has been set.** message appears. The area is entered into the list.
- ▶ **To take account of an area for the route:** select an area from the list.
- ▶ Activate **Avoid Area**.  
The display button is activated.  
If route guidance is active, a new route is calculated.

If there is no route yet, the setting is carried over to the next route guidance.

The route can include an area that is to be avoided in the following cases:

- the destination is located in an area that is to be avoided.
- the route includes highways or multi-lane expressways which pass through an area to be avoided.
- there is no sensible alternative route.

### Deleting an area

Multimedia system:



» Advanced » Route » Avoid Options

» Avoid Areas

- ▶ **To delete an area:** select an area in the list.
- ▶ Select **Delete**.
- ▶ Confirm the prompt with **Yes**.
- ▶ **To delete all areas:** if at least two areas to avoid are set, select **Delete All**.
- ▶ Confirm the prompt with **Yes**.

### Map data update overview

#### Updating at the authorized Mercedes-Benz Center

The digital maps generated by the map software become outdated in the same way as conventional road maps. Optimal route guidance can only be provided by the navigation system in conjunction with the most up-to-date map data. Information about new versions of the digital map can be obtained from an authorized Mercedes-Benz Center.

You can receive updates to the digital map there.

#### Online map update

The online map update service from Mercedes me connect can be used to update the map data.

- ⓘ The online map update service is not available in all countries.

The following options are available for the update:

- for one region (automatic map update)



For automatic map updates the [Automatic Online Update](#) system setting must be activated (→ page 284).

- for several or all regions (manual map update)  
The map data will first be downloaded onto a storage medium and then updated on the multimedia system.

Further information on online map updates is available here:

- at any authorized Mercedes-Benz Center
- at: <http://www.mercedes.me>

Further information on updates can be found at: [http://manuals.daimler.com/baix/cars/connectme/en\\_GB/index.html](http://manuals.daimler.com/baix/cars/connectme/en_GB/index.html).

### Overview of map data

Your vehicle is supplied with map data at the factory. Depending on the country, map data for your region is either pre-installed or the map data is supplied on a data storage medium.

If the map data on your vehicle has been installed at the factory and you wish to reinstall it, you do not need to enter the activation code.

For map data that you have purchased in the form of a data storage medium, you must enter the accompanying activation code.

- ① If you save the map data on a data storage medium with the online map update service, no entry is required. The activation code is stored on the data storage medium during the downloading process.

Observe the following when entering the activation code:

- The activation code can be used for one vehicle
- The activation code is not transferable
- The activation code has six digits

In the event of the following problems, please contact an authorized Mercedes-Benz Center:

- The multimedia system does not accept the activation code
- You have lost the activation code

### Displaying the compass

Multimedia system:

→  → [Navigation](#) →  → [Position](#)

#### ▶ Select [Compass](#).

The compass display shows the following information:

- The current direction of travel with bearing (360° format) and compass direction
- Longitude and latitude coordinates in degrees, minutes and seconds
- Height (rounded)
- Number of satellites from which a signal can be received

### Setting the map scale automatically

Multimedia system:

→  → [Navigation](#) → 

#### ▶ [Advanced](#)

#### ▶ Select [View](#).

#### ▶ Select [Map Orientation](#).

▶ Activate [Auto Zoom](#).

The display button is activated. The map scale is set automatically depending on your driving speed and the type of road.

- ⓘ The automatically selected map scale can be changed manually. After a few seconds, this is automatically reset.

**Displaying the satellite map**

Multimedia system:

▶▶ [Advanced](#)▶ Select [View](#).▶ Select [Map Elements](#).▶ Switch [Satellite Map](#) on or off.

If the display button is activated, satellite maps are displayed in map scales from 2 mi (2 km).

If the display button is deactivated, satellite maps are not displayed in map scales from 2 mi (2 km) to 20 mi (20 km).

- ⓘ The satellite maps for these map scales are not available in all countries.

**Displaying the range****Requirements:**

- The multimedia system supports the function.

Multimedia system:

▶▶ [Advanced](#)▶ Select [View](#).▶ Select [Map Elements](#).▶ Activate [Range](#).

The display button is activated.

The range is shown on the map with the following displays:

- For gasoline and diesel vehicles: green display

When the lower reserve capacity is reached then the range display on the map is switched off.

- ⓘ The range display on the map is not available in all countries.

**Displaying weather information and other map contents****Requirements:**

- Mercedes me connect is available.
- You have a user account for the Mercedes me portal.
- The service is available.
- The service has been activated at an authorized Mercedes-Benz Center.

Multimedia system:

▶▶ [Advanced](#)▶ Select [View](#).▶ Select [Map Elements](#).▶ Scroll up and show the [ONLINE MAP CONTENT](#) category.

The available services are displayed. The services are provided by Mercedes me connect.

- ▶ Switch on a service, e.g. [Weather](#). Current weather information is displayed on the navigation map, e.g. temperature or

cloud cover. The service information is not shown in all map scales, e.g. weather symbols.

Further information about available services and about displaying information in the map scales can be found at: <http://www.mercedes.me>

 Weather information is not available in all countries.

### Showing map view in the multifunction display of the instrument cluster

Multimedia system:



» Advanced

- ▶ Select **View**.
- ▶ Select **Map Orientation**.
- ▶ Scroll up and show the **INSTRUMENT CLUSTER VIEW** category.
- ▶ **To set the map scale automatically:** switch on **Auto Zoom**.  
The display button is activated. The map scale is set automatically depending on your driving speed and the type of road.

▶ **To select map orientation:** select an option. The ● dot indicates the current selection.

The following options are available:

- **2D Heading Up** option: the 2D map view is aligned to the direction of travel.
- **2D North Up** option: the 2D map view is displayed so that north is always at the top.
- **3D** option: the 3D map view is aligned to the direction of travel.

### Parking service

#### Notes on the parking service

 **WARNING** Risk of accident and injury due to not observing the maximum permitted access height

If the vehicle height exceeds the maximum permitted access height for parking garages and underground parking lots, the vehicle roof as well as other vehicle parts could be damaged.

There could be a risk of injury to the vehicle occupants.

- ▶ Before driving into a parking garage or underground parking lot observe the locally signposted access height.
- ▶ If the vehicle height, including any additional equipment, exceeds the maximum permitted access height, do not drive into the parking garage or underground parking lot.

This service is not available in all countries.

#### Selecting parking options

 **NOTE** Before selecting the parking option

The data is based on the information made available by the respective service provider.

- ▶ Always pay attention to the local information and circumstances.

### Requirements:

- The navigation services option is available, subscribed to and activated in the Mercedes me portal.
- The parking service is within the scope of the navigation service.
- **Parking** is activated (→ page 324).

Multimedia system:

→  » **Navigation**

▶ Tap on  in the map.

▶ Select a parking option.

The map shows the parking options in the vicinity.

The following information is displayed (if available):

- Destination address, distance from current vehicle position and arrival time
- Information on the parking garage/parking lot

For example, opening times, parking charges, current occupancy, maximum parking time, **maximum access height**.

The maximum access height shown by the parking service does not replace the need for observation of the actual circumstances.

- Available payment options (Mercedes pay, coins, bank notes, cards)
- Details on parking tariffs
- Number of available parking spaces
- Payment method (e.g. at the parking machine)
- Services/facilities at the parking option
- Telephone number

▶ Calculate the route (→ page 296).

The following functions can also be selected (if available):

- Search for POIs in the vicinity.
- Save the destination.
- Place a call at the destination.
- Share the destination using NFC or QR code.
- Call up the web address.
- Show the destination on the map.

### Displaying parking options on the map

#### Requirements:

- The navigation services option is available, subscribed to and activated in the Mercedes me portal.
- The parking service is within the scope of the navigation service.

Multimedia system:

→  » **Navigation** » 

▶ Activate **Parking**.

The display button is activated. The parking options within the vicinity of the current vehicle position are shown.

### Dashcam

#### Selecting a USB device for a video recording with the dash cam

#### Requirements:

- several USB devices are connected with the multimedia system (→ page 364).

This function is not available in all countries.

Multimedia system:

→  » Mercedes me & Apps  
» Dashcam

▶ Select the USB device.

### Starting/stopping video recording with the dash cam

#### Requirements:

- A USB device is connected with the multimedia system (→ page 364).
- The ignition is switched on.

This function is not available in all countries.

Multimedia system:

→  » Mercedes me & Apps  
» Dashcam

▶ If several USB devices are connected with the multimedia system, select the USB device (→ page 324).

▶ **To select a recording mode:** select **Individual Recording** or **Loop Recording**.  
If **Individual Recording** is selected and the memory is full the recording stops. An indi-

vidual recording is automatically protected against being overwritten.

If **Loop Recording** has been selected, several short video files are recorded. When the memory limit is reached, the oldest video file is deleted and recording is continued automatically.

- ▶ **To start:** select **Start Recording**.  
The length of the recording is shown. The **Please do not remove the storage medium** message appears. The video file is stored on the USB device.
- ▶ **To end:** select **End Recording**.

A report may appear in the following cases:

- For the **Individual Recording** recording mode: the memory is full or there are only a few minutes recording time available. The video recording stops or will be stopped imminently.  
Change the USB device or delete a video file.
- If a video recording has started and a national border is detected, the **National Border Crossed. Please observe the country-**

**specific regulations on video recording** message appears.

This function is not available in all countries.

- The camera is not functional, the **Camera Unavailable** message appears.  
Have the camera checked at an authorized Mercedes-Benz Center.

### Deleting a dash cam video recording



#### Requirements:

- A USB device with video recordings is connected with the multimedia system (→ page 364).

This function is not available in all countries.

Multimedia system:

→  » Mercedes me & Apps  
» Dashcam

- ▶ Select the  symbol.  
The **RECORDINGS** menu appears.
- ▶ Select  for a video file.
- ▶ Select **Delete**.
- ▶ Select **Yes**.

- ▶ **To delete all video files:** select .
- ▶ Select **Delete All Entries**.

### Configuring dash cam settings

#### Requirements:

- A USB device is connected with the multimedia system (→ page 364).

This function is not available in all countries.

Multimedia system:

- ▶  ▶ **Mercedes me & Apps**
- ▶ **Dashcam**

- ▶ Select .

- ▶ **To show messages after passing a national border:** switch on **National Borders Alert**.

The display button is activated.

A message appears under the following conditions:

- A video is being recorded.
- The vehicle has passed a national border.

- ⓘ This function is not available in all countries.

- ▶ **To start automatic video recording:** select **Automatic Video Recording**.

- ▶ Activate **Automatic Video Recording**. The display button is activated. When the vehicle is started, video recording starts automatically.

- ⓘ This function is not available in all countries.

## Telephone

### Telephony

#### Notes on telephony

- ⚠ **WARNING** Risk of distraction from operating integrated communication equipment while the vehicle is in motion

If you operate communication equipment integrated in the vehicle when driving, you will be distracted from the traffic situation. This could also cause you to lose control of the vehicle.

- ▶ Only operate this equipment when the traffic situation permits.

- ▶ If you cannot be sure of this, stop the vehicle whilst paying attention to road and traffic conditions and operate the equipment with the vehicle stationary.

- ⚠ **WARNING** Risk of an accident from operating mobile communication equipment while the vehicle is in motion

Mobile communications devices distract the driver from the traffic situation. This could also cause the driver to lose control of the vehicle.

- ▶ As the driver, only operate mobile communications devices when the vehicle is stationary.
- ▶ As a vehicle occupant, only use mobile communications devices in the areas intended for this purpose, e.g. in the rear passenger compartment.

You must observe the legal requirements for the country in which you are currently driving when operating mobile communication equipment in the vehicle.

Further information can be obtained from an authorized Mercedes-Benz Center or at: <http://www.mercedes-benz.com/connect>.

### Telephone menu overview

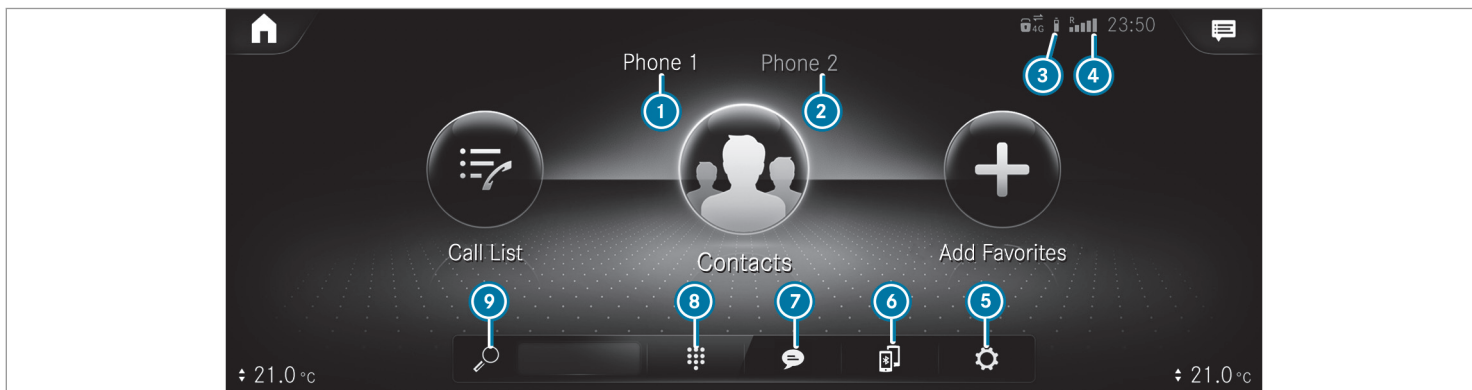

① Bluetooth® device name of the currently connected mobile phone/of the mobile phone

② Bluetooth® device name of the currently connected mobile phone/of the mobile phone (two phone mode)

③ Battery status of the connected mobile phone

④ Signal strength of the mobile phone network

- 5 Options
- 6 Device manager

### Bluetooth® profile overview

Bluetooth® profile of the mobile phone	Function
PBAP (Phone Book Access Profile)	Contacts are automatically displayed in the multimedia system
MAP (Message Access Profile)	Message functions can be used

### Telephony operating modes overview

Depending on your equipment, the following telephony operating modes are available:

- A mobile phone is connected to the multimedia system via Bluetooth® (→ page 329).
- Two mobile phones are connected with the multimedia system via Bluetooth® (two phone mode) (→ page 329).

- 7 Messages
- 8 Numerical pad

- You can use all the functions of the multimedia system with the mobile phone in the foreground.
- You can receive incoming calls and messages with the mobile phone in the background.  
You can interchange the mobile phone in the foreground and background any time (→ page 329).

- i Irrespective of this, Bluetooth® audio functionality can be used with any mobile phone (→ page 364).

### Information on telephony

The following situations can lead to the call being disconnected while the vehicle is in motion:

- there is insufficient network coverage in the area

- 9 Contact search

- you move from one transmission/reception station to another and no communication channels are free
- the SIM card used is not compatible with the network available
- a mobile phone with "Twincard" is logged into the network with the second SIM card at the same time

The multimedia system supports calls in HD Voice® for improved speech quality. A requirement for this is that the mobile phone and the mobile phone network provider of the person you are calling support HD Voice®.

Depending on the quality of the connection, the voice quality may fluctuate.



## Connecting a mobile phone

### Requirements:

- Bluetooth® is activated on the mobile phone (see the manufacturer's operating instructions).
- Bluetooth® is activated on the multimedia system (→ page 278).

Multimedia system:



### Searching for a mobile phone



Select

- ▶ Select [Connect New Device](#).

### Connecting a mobile phone (authorization using Secure Simple Pairing)

- ▶ Select a mobile phone.
- ▶ A code is displayed in the multimedia system and on the mobile phone.
- ▶ **If the codes match:** confirm the code on the mobile phone.

- ▶ For older mobile phone models, enter a one to sixteen-digit number code on the mobile phone and on the multimedia system for authorization.
- ▶ Up to 15 mobile phones can be authorized on the multimedia system. Authorized mobile phones are reconnected automatically.
- ▶ The connected mobile phone can also be used as Bluetooth® audio equipment (→ page 364).

### Connecting a second mobile phone (two phone mode)

#### Requirements:

- At least one mobile phone is already connected to the multimedia system via Bluetooth®.

Multimedia system:



Select

- ▶ Select [Connect New Device](#).

- ▶ Select the mobile phone.
- ▶ Select [<Mobile phone> + <Mobile phone>](#). The selected mobile phone is connected to the multimedia system.

### Functions of the mobile phone in two phone mode

#### Functions overview

Mobile phone in the foreground	Mobile phone in the background
Full range of functions	Incoming calls and messages

### Interchanging mobile phones (two phone mode)

Multimedia system:



Both mobile phones are shown individually in separate tabs.

- ▶ Select the tab with the desired mobile phone. The mobile phone in the selected tab is the mobile phone in the foreground.

With the exception of telephone settings, the submenus in the telephone menu relate to the mobile phone in the foreground. In the telephone settings, settings can be made for both mobile phones.

### Changing the function of a mobile phone

Multimedia system:



#### Activating a function

- ▶ Select  .
- ▶ Select a gray symbol in the line of a mobile phone.  
The corresponding function is activated.

#### Deactivating a function

- ▶ Select  .
- ▶ **One function is active:** select the color symbol in the line of a mobile phone.  
The mobile phone is disconnected from the multimedia system.

- ▶ **Several functions are active:** select a color symbol in the line of a mobile phone.  
The corresponding function is deactivated.

### Replacing mobile phones

Multimedia system:



- ▶ Select  .
- ▶ **No authorized mobile phone available:** select [Connect New Device](#).
- ▶ Select a mobile phone.
- ▶ **Newly authorized mobile phone:** confirm the number code on the mobile phone.

### Using in single telephone mode

- ▶ Select [<Mobile phone>](#).  
A newly authorized mobile phone is connected in single telephone mode.  
If the mobile phone has already been authorized and connected in single telephone mode, it is connected again in single telephone mode.

If a mobile phone has already been authorized and connected in two phone mode with another mobile phone, it will be connected in future in single telephone mode.

### Using in two phone mode

- ▶ Select [<Mobile phone>](#) + [<Mobile phone>](#).  
A newly authorized mobile phone is connected with the selected mobile phone in two phone mode.  
If the mobile phone has already been authorized and connected in single telephone mode, it will be connected in future with the selected mobile phone in two phone mode.  
If the mobile phone was previously connected with another mobile phone, this connection is canceled.

### Disconnecting/de-authorizing a mobile phone

Multimedia system:



- ▶ Select  .

- ▶ Select  in the line of the mobile phone.
- ▶ **To disconnect:** select [Disconnect](#).  
If applicable, the mobile phone will be automatically reconnected when the vehicle is next started.
- ▶ **To de-authorize:** select [Deauthorize](#).

### Information on Near Field Communication (NFC)

NFC enables short-range wireless data transfer or (re)connection of a mobile phone with the multimedia system.

The following functions are available without having authorized a mobile phone:

- Transferring a URL or a contact to be viewed in the multimedia system (see the manufacturer's operating instructions).
- Setting up the vehicle's Wi-Fi access data via the system settings (→ page 280).

Further information can be obtained at: <http://www.mercedes-benz.com/connect>

### Using the mobile phone with Near Field Communication (NFC)

#### Requirements:

- NFC is activated on the mobile phone (see the manufacturer's operating instructions)
- The mobile phone's screen is switched on and unlocked (see the manufacturer's operating instructions)

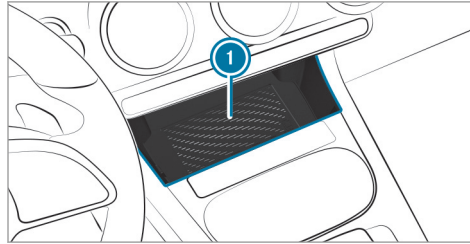

- ▶ **To connect a mobile phone:** hold the NFC area of the mobile phone (see manufacturer's operating instructions) on mat ① or place the mobile phone on it.

- ▶ Follow the additional prompts on the media display to connect the mobile phone. Connect the mobile phone in single telephone mode (→ page 329). Connect the mobile phone in two phone mode (→ page 329).
- ▶ **To replace a mobile phone:** hold the NFC area of the mobile phone (see manufacturer's operating instructions) on mat ① or place the mobile phone on it.
- ▶ Follow the additional prompts on the media display to replace the mobile phone in one or two phone mode (→ page 329).
- ▶ If required, confirm the prompts on your mobile phone (see the manufacturer's operating instructions).
- ① If your mobile phone supports wireless charging, it will be automatically charged via NFC when it is connected or replaced. A requirement for this is that the mobile phone is on the mat (→ page 111).

If you want to charge a mobile phone without connecting it to the multimedia system, lay it on the mat without beforehand unblocking the screen.

Further information can be found at: <http://www.mercedes-benz.com/connect>

### Setting the reception and transmission volume

#### Requirements:

- A mobile phone is connected (→ page 329).

Multimedia system:



This function ensures optimal language quality.

- ① Please note that the respective mobile phone must be selected for adjustment of the reception and transmission volume.

- ▶ Select **Volume**.
- ▶ Set **Reception Volume** and **Transmission Volume**.

Further information on the recommended reception and transmission volume: <http://www.mercedes-benz.com/connect>

### Setting the ringtone

Multimedia system:



- ▶ Select **Ringtones**.
- ▶ Set the ringtone.

- ① If the mobile phone supports the transfer of the ringtone, you will hear the ringtone of the mobile phone instead of that of the vehicle.

### Starting/stopping mobile phone voice recognition



#### Requirements:

- The mobile phone in the foreground is connected with the multimedia system (→ page 329).

#### Starting mobile phone voice recognition

- ▶ Press and hold the  button on the multi-function steering wheel for more than one second.  
You can use mobile phone voice recognition.

### Stopping mobile phone voice recognition

- ▶ Press the  or  button on the multi-function steering wheel.
- ① If a mobile phone is connected via Smartphone Integration, the voice recognition of this mobile phone is started or stopped.



## Calls

### Using the telephone

Multimedia system:



### Making a call by entering the numbers

- ▶ Select .
- ▶ Enter a number.
- ▶ Select .
- ▶ The call is made.

### Accepting a call

- ▶ Select  **Accept**.

### Rejecting a call





- ▶ Select  **Reject**.

### Ending a call

- ▶ Select .

### Activating functions during a call

The following functions are available during a call:

-  **End Call**
-  **Microphone Off**
-  **Numeric Keypad** (show to send DTMF tones)
-  **Add Call**
-  **Transfer to Phone** (an active call in hands-free mode is transferred over to the telephone)

- ▶ Select a function.

### Conducting calls with several participants

#### Requirements:

- There is an active call (→ page 332).
- Another call is being made.

### Switching between calls

- ▶ Select the contact.  
The selected call is active. The other call is on hold.

### Activating a call on hold

- ▶ Select the contact of the call on hold.

### Conducting a conference call

- ▶ Select  **Create Confer. Call**.  
The new participant is included in the conference call.

### Ending an active call

- ▶ Select  **End Call**.
- ⓘ On some mobile phones, the call on hold is activated as soon as the active call is ended.

### Accepting/rejecting a waiting call

#### Requirements:

- There is an active call (→ page 332).

If you receive a call while already in a call, a message is displayed.

Depending on the mobile phone and mobile network operator you will hear a call-waiting sound. In addition, in two phone mode you will hear an acoustic signal when the call goes through to the other (not yet active) mobile phone.

- ▶ Select  **Accept**.  
The incoming call is active.

If only one mobile phone is connected with the multimedia system, the previous call will be put on hold.

If during a call you accept a call with the other mobile phone when in two phone mode then the existing call is ended.

- ▶ Select  **Reject**.
- ⓘ This function and behavior depends on your mobile phone network provider and the mobile phone (see the manufacturer's operating instructions).

## Contacts

### Information about the contacts menu

The contacts menu contains all contacts from existing data sources, e.g. mobile phone or data storage medium.

Depending on the data source, you have the following number of contacts:

- Permanently saved contacts: 3,000 entries
- Contacts loaded from the mobile phone: 5,000 entries per mobile phone

From the contacts menu, you can perform the following actions:

- Make a call, for example call a contact (→ page 335)
- Navigation (→ page 293)
- Compose messages
- Additional options (→ page 336)

If a mobile phone is connected to the multimedia system (→ page 329) and automatic calling up (→ page 334) is activated, the mobile phone's contacts are displayed in the address book.

The multimedia system can show suggestions based on frequently used contacts as well as incoming and outgoing calls (→ page 260). These are shown at the top of the contact list.

### Downloading mobile phone contacts

Multimedia system:

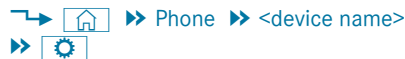

- ▶ Select **Contacts & Recent Calls**.

### Automatically

- ▶ To switch **Synchronize Contacts Automatically** on: activate the LED symbol.

### Manually

- ▶ To deactivate **Synchronize Contacts Automatically**: deactivate the LED symbol.
- ▶ Select **Synchronize Contacts**.

### Calling up contacts

Multimedia system:



The following options can be used to search for contacts:

- searching by initials
- searching by name
- searching by phone number

- ▶ Enter characters into the search field.
- ▶ Select the contact.

A contact can contain the following details:

- phone numbers
- navigation addresses
- geo-coordinates
- Internet address
- e-mail addresses
- voice tag (if set)
- relation (if set)

## Editing the format of a contact's name

Multimedia system:





- ▶ Select **General**.
- ▶ Select **Name Format**.

The following options are available:

- **Last Name, First Name**
  - **Last Name First Name**
  - **First Name Last Name**
- ▶ Select an option.

## Overview of importing contacts

### Contacts from various sources

Source	Requirements
 USB device	The USB device is connected with the USB port.
 Bluetooth® connection	If the sending of vCards via Bluetooth® is supported, vCards can be received on mobile phones or notebooks, for example.  Bluetooth® is activated in the multimedia system and on the respective device (see the manufacturer's operating instructions).

## Importing contacts into the contacts menu

Multimedia system:







- ▶ Select a mobile phone <device name>, from which the contacts should be imported.
- ▶ Select an option.

### Saving a mobile phone contact

Multimedia system:



- ▶ Select   in the line of the mobile phone contact.
- ▶ Select .
- ▶ Select **Save to Vehicle**.
- ▶ Select **Yes**.  
The contact saved in the multimedia system is identified by the  symbol.

### Calling a contact

Multimedia system:





- ▶ Select  **Search for Contacts**.

- ▶ Enter characters into the search field.
- ▶ Select the contact.
- ▶ Select the telephone number.  
The number is dialed.

### Selecting further options in the contacts menu

Multimedia system:



- ▶ Select  in the line of the contact.
- ▶ Select .

Depending on the stored data, the following options are available:

- [Add Voice Tag/Delete Voice Tag](#)
- [Set Relationship/Delete Relationship](#)
- [Send DTMF Tones](#) (for a number with DTMF tones)  
The function is available when a call is active.
- ▶ Select an option.



### Selecting options for suggestions in the contacts menu

Requirements:

- A profile has been created (→ page 255).
- The [Allow Contact Suggestions](#) setting is switched on (→ page 260).

Multimedia system:



- ▶ Select  [Recent Calls](#).
- ▶ Select  in the line of a suggested contact.

The following options are available:

- [Save as Favorite](#)  
The suggestions are saved as global favorites and do not appear on the home screen.
- [No Longer Suggest](#)
- ▶ Select an option.

### Deleting contacts

Requirements:

- The contacts are saved in the vehicle.
- To delete an individual contact, this has been imported manually into the vehicle.



Multimedia system:



### Deleting all contacts

- ▶ Select .
- ▶ Select [General](#).
- ▶ Select [Delete Contacts](#).
- ▶ Select an option.

### Deleting a contact

- ▶ Select .
- ▶ Select  in the line of the contact.
- ▶ Select .
- ▶ Select [Delete Contact](#).
- ▶ Select [Yes](#).



### Saving a contact as a favorite

Multimedia system:

 **Phone** **+** Add Favorites

- ▶ Select a contact.
- ▶ Select  in the line of the contact.
- ▶ Select the telephone number.  
The contact is stored as a favorite in the telephone menu overview.

### Deleting favorites in the telephone menu overview

Multimedia system:



- ▶ Select a favorite in the telephone menu overview (→ page 337).
- ▶ Press and hold the favorite.
- ▶ Select **Delete**.
- ▶ Select **Yes**.

### Deleting all favorites

- ▶ Tap on  in the media display.
- ▶ Select **Phone**.

- ▶ Select .
- ▶ Select the connected telephone.
- ▶ Select **Contacts & Recent Calls**.
- ▶ Select **Do you want to delete all favorites?**.
- ▶ Select **Yes**.

### Call list

#### Overview of the call list

Depending on whether your mobile phone supports the PBAP Bluetooth® profile or not, this can have different effects on the presentation and functions of the call list.

If the PBAP Bluetooth® profile is supported, the effects are as follows:

- The call lists from the mobile phone are displayed in the multimedia system.
- When connecting the mobile phone, you may have to confirm the connection for the PBAP Bluetooth® profile.

If the PBAP Bluetooth® profile is not supported, the effects are as follows:

- The multimedia system generates a call list independently as soon as calls are made in the vehicle.
- The call list is not synchronized with the call lists in the mobile phone.

The multimedia system can show suggestions based on frequently used contacts as well as incoming and outgoing calls (→ page 260). These are shown at the top of the call list.

#### Making a call from the call list

Multimedia system:

 **Phone**

- ▶ Select  **Recent Calls**.
- ▶ Select an entry.  
The call is made.

#### Calling up additional options in the call list

Multimedia system:

 **Phone**

- ▶ Select  **Recent Calls**.

- ▶ For previously stored contacts: select  in the line of an entry.  
The search results are displayed.



### Selecting options for suggestions in the call list

#### Requirements:

- A profile has been created (→ page 255).
- The [Allow Contact Suggestions](#) setting is switched on (→ page 260).

Multimedia system:

  ▶▶ Phone

- ▶ Select  [Recent Calls](#).
- ▶ Select  in the line of a suggested entry.  
The following options are available:
  - [Save as Favorite](#)
  - [No Longer Suggest](#)
- ▶ Select an option.

### Deleting the call list

Multimedia system:

  ▶▶ Phone ▶▶ <device name>

▶▶ 

- ▶ Select [Contacts & Recent Calls](#).
- ▶ Select [Delete Recent Calls](#).
- ▶ Select [Yes](#).

 This function is only available if your mobile does not support the PBAP Bluetooth® profile.

### Text messages

#### Overview of message functions

In the messages menu you can receive and send text messages.

If the connected mobile phone supports the Bluetooth® MAP profile, the message function can be used on the multimedia system.

You can obtain further information about settings and supported functions of Bluetooth®-capable mobile phones from an authorized

Mercedes-Benz Center or at: <http://www.mercedes-benz.com/connect>

Some mobile phones require further settings after being connected to the multimedia system (see manufacturer's operating instructions).

### Setting message displays

Multimedia system:

  ▶▶ Phone ▶▶ <device name>

▶▶ 

- ▶ Select [Message Display](#).  
The following options are available:
  - [All Messages](#)
  - [New and Unread Messages](#)
  - [Messages While Driving](#)
  - [Off](#) (The message function is no longer available.)
- ▶ Select a setting.

### Reading messages

Multimedia system:



### Using the read-aloud function

- ▶ Select a contact.
- ▶ Select read aloud.  
The message is read aloud.

### Using message templates

Multimedia system:

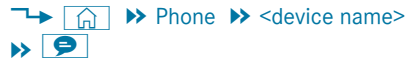

### Using a template as a new message

- ▶ Select to write a new message.
- ▶ Add a recipient using .
- ▶ Select a template.

### Answering a message with a template

- ▶ Select a message sequence with a contact.
- ▶ Select a template.

- ▶ Select a template.

### Forwarding a message

Multimedia system:



A message list is shown.

- ▶ Select next to a contact.  
The messaging history with this contact is shown.
- ▶ Press and hold on a message.
- ▶ **To forward a message:** select [Forward](#).

### Calling a message sender

Multimedia system:

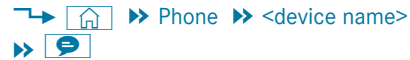

A message list is shown.

- ▶ Select next to a contact.  
The messaging history with this contact is shown.
- ▶ Select .

- ▶ Select [Call](#).

### Using telephone numbers or URLs from a text message

#### Requirements:

- An Internet connection is available to call up a URL.

Multimedia system:



A message list is shown.

- ▶ Select next to a contact.  
The messaging history with this contact is shown.
- ▶ Select a telephone number or a URL in the message.  
If a URL is selected the web browser opens.  
If a telephone number is selected the following options are available:
  - [Call](#)
  - [Write New Text Message](#)
- ▶ Select an option.

**Deleting a message**

Multimedia system:



- ▶ Select a contact.
- ▶ Press and hold on a message.
- ▶ **To delete the message:** select **Delete**.

**Mercedes-Benz link****Overview of Mercedes-Benz Link**

**⚠ WARNING** Risk of distraction from information systems and communications equipment

If you operate information and communication equipment integrated in the vehicle when driving, you will be distracted from the traffic situation. This could also cause you to lose control of the vehicle.

- ▶ Only operate this equipment when the traffic situation permits.

▶ If you cannot be sure of this, stop the vehicle whilst paying attention to road and traffic conditions and operate the equipment with the vehicle stationary.

You must observe the legal requirements for the country in which you are currently driving when operating the multimedia system.

With Mercedes-Benz Link you can use mobile phone functions via the multimedia system. It is operated using the touchscreen or the voice-operated control system. You can activate the voice-operated control system by pressing and holding the  button on the multifunction steering wheel.

When using Mercedes-Benz Link via the voice-operated control system, the multimedia system can still be operated via the Voice Control System (→ page 222).

The Mercedes-Benz Link control box supplementary equipment is required for this. This is available at an authorized Mercedes-Benz Center.

Only one mobile phone at a time can be connected via Mercedes-Benz Link to the multimedia system.

When a mobile phone is connected with Mercedes-Benz Link, only one additional mobile phone can be connected using Bluetooth® with the multimedia system when in two phone mode.

- ⓘ The Mercedes-Benz Link control box uses the Android operating system.
- ⓘ The service provider is responsible for these apps and the services and content connected to it.

**Notes on Mercedes-Benz Link**

If a mobile phone is used with Mercedes-Benz Link, USB access using the media menu is possible for this mobile phone.

- ⓘ Only one route guidance can be active at a time. If route guidance is active on the multimedia system, it is closed when route guidance is started on the mobile phone.

## Connecting Mercedes-Benz Link with the multimedia system

### Requirements:

- The vehicle is equipped with the Mercedes-Benz Link control box.
  - The Mercedes-Benz Link app is installed on the mobile phone.
  - The mobile phone is switched on.
  - Mercedes-Benz Link is connected to the multimedia system via the  USB port using a suitable cable (→ page 364).
- i** The first activation of Mercedes-Benz Link on the multimedia system must be carried out when the vehicle is stationary for safety reasons.

Multimedia system:

- ➔  ➔ Mercedes me & Apps
- ➔ Smartphone ➔ Mercedes-Benz Link
- ➔ Start Mercedes-Benz Link

### Accepting/rejecting the data protection regulations

For the initial start of the application: a message with the data protection provisions appears.

- ▶ Select **Accept & Start**.

### Quitting Mercedes-Benz Link

- ▶ Press the  button.
- i** Mercedes-Benz Link starts automatically when it is connected with the system using a cable. If Mercedes-Benz Link was not displayed in the foreground before disconnecting, the application starts in the background when reconnected. You can call up Mercedes-Benz Link using the main menu.

You can find more information in the Mercedes-Benz Link control box operating instructions.

## Calling up Mercedes-Benz Link sound settings

Multimedia system:

- ➔  ➔ Mercedes me & Apps
- ➔ Smartphone ➔ Mercedes-Benz Link
- ➔ 

- ▶ Select sound settings.

### Ending Mercedes-Benz Link

- ▶ Disconnect the connecting cable between Mercedes-Benz Link and the multimedia system.
- i** Mercedes-Benz recommends disconnecting the connecting cable only when the vehicle is stationary.

## Apple CarPlay™

### Overview of Apple CarPlay™

**⚠ WARNING** Risk of distraction from information systems and communications equipment

If you operate information and communication equipment integrated in the vehicle when driving, you will be distracted from the traffic situation. This could also cause you to lose control of the vehicle.

- ▶ Only operate this equipment when the traffic situation permits.
- ▶ If you cannot be sure of this, stop the vehicle whilst paying attention to road and traffic conditions and operate the equipment with the vehicle stationary.

You must observe the legal requirements for the country in which you are currently driving when operating the multimedia system.

iPhone® functions can be used via the multimedia system using Apple CarPlay™. They are operated using the touchscreen, touchpad, Touch

Control or the Siri® voice-operated control system. You can activate the voice-operated control system by pressing and holding the  button on the multifunction steering wheel.

When using Apple CarPlay™ via the voice-operated control system, the multimedia system can still be operated via the Voice Control System (→ page 222).

Only one iPhone® at a time can be connected via Apple CarPlay™ with the multimedia system.

Also for use of Apple CarPlay™ with two phone mode, only one additional mobile phone can be connected using Bluetooth® with the multimedia system.

The availability of Apple CarPlay™ may vary according to the country.

The service provider is responsible for this application and the services and content connected to it.

### Information on Apple CarPlay™

When Apple CarPlay™ is being used, the iPod® media source is not available for the respective iPhone®.

Only one route guidance can be active at a time. If route guidance is active on the multimedia system, it is closed when route guidance is started on the mobile phone.

### Connecting an iPhone® via Apple CarPlay™ (cable)



#### Requirements:

- The current version of your device's operating system is being used (see the manufacturer's operating instructions).
- There is an Internet connection for the full range of functions for Apple CarPlay™.
- The iPhone® is connected to the multimedia system via the USB port  using a suitable cable (→ page 364).

Multimedia system:

- ➔  ➔ [Mercedes me & Apps](#)
- ➔ [Smartphone](#) ➔ [Apple CarPlay](#)
- ➔ [Start Apple CarPlay](#)

- ▶ Alternative: If an Apple CarPlay™ application is active (e.g. when music is being played or route guidance is active), you can call up the

active application using the ,  or  application buttons (→ page 253).

- Control using the application buttons can be switched on or off (→ page 343).

### Accepting/rejecting the data protection regulations

For the initial start of the application: a message with the data protection provisions appears.

- Select **Accept & Start**.

### Exiting Apple CarPlay™

- Press the  button.

- Apple CarPlay™ starts automatically when the iPhone® is connected with the system using a cable. If Apple CarPlay™ was not displayed in the foreground before disconnecting, the application starts in the background when reconnected. You can call up Apple CarPlay™ in the main menu.

### Calling up Apple CarPlay™ sound settings

Multimedia system:

-  ▶ **Mercedes me & Apps**
- ▶ **Smartphone** ▶ **Apple CarPlay** ▶ 

- Select sound settings.

### Setting control of the application buttons (Apple CarPlay™)

Multimedia system:

-  ▶ **Mercedes me & Apps**
- ▶ **Smartphone** ▶ **Apple CarPlay** ▶ 
- ▶ **General**

- To switch **Control via Application Buttons** on: activate the LED symbol.
- To deactivate **Control via Application Buttons**: deactivate the LED symbol.

### Ending Apple CarPlay™

- To **end the connection of Apple CarPlay™ (with cable)**: disconnect the connection via the connecting cable between the mobile phone and multimedia system.

- Mercedes-Benz recommends disconnecting the connecting cable only when the vehicle is stationary.

## Android Auto

### Android Auto overview

**⚠ WARNING** Risk of distraction from information systems and communications equipment

If you operate information and communication equipment integrated in the vehicle when driving, you will be distracted from the traffic situation. This could also cause you to lose control of the vehicle.

- Only operate this equipment when the traffic situation permits.
- If you cannot be sure of this, stop the vehicle whilst paying attention to road and traffic conditions and operate the equipment with the vehicle stationary.

You must observe the legal requirements for the country in which you are currently driving when operating the multimedia system.

Mobile phone functions can be used with Android Auto using the Android operating system on the multimedia system. It is operated using the touchscreen or the voice-operated control system. You can activate the voice-operated control system by pressing and holding the  button on the multifunction steering wheel.

When using Android Auto via the voice-operated control system, the multimedia system can still be operated via the Voice Control System (→ page 222).

Only one mobile phone at a time can be connected via Android Auto with the multimedia system.

Also for use of Android Auto with two phone mode, only one additional mobile phone can be connected using Bluetooth® with the multimedia system.

The availability of Android Auto and Android Auto apps may vary according to the country.

The service provider is responsible for this application and the services and content connected to it.

#### Information on Android Auto

If a mobile phone is used with Android Auto, USB access using the media menu is not possible for this mobile phone.

Only one route guidance can be active at a time. If route guidance is active on the multimedia system, it is closed when route guidance is started on the mobile phone.

#### Connecting a mobile phone via Android Auto





##### Requirements:





- The mobile phone supports Android Auto from Android 5.0.
- The Android Auto app is installed on the mobile phone.
- In order to use the telephone functions, the mobile phone must be connected to the multimedia system via Bluetooth® (→ page 329).



If there was no prior Internet connection, this is established with the use of the mobile phone with Android Auto.

- The mobile phone is connected to the multimedia system via the  USB port using a suitable cable (→ page 364).
- There is an Internet connection for the full range of functions for Android Auto.

Multimedia system:

  **Mercedes me & Apps**  
 **Smartphone**  **Android Auto**  
 **Start Android Auto**

 Alternative: If an Android Auto application is active (e.g. when music is being played or route guidance is active), you can call up the active application using the ,  or  application buttons (→ page 253).

-  Control using the application buttons can be switched on or off (→ page 345).
-  The first activation of Android Auto on the multimedia system must be carried out when the vehicle is stationary for safety reasons.



### Accepting/rejecting the data protection regulations

For the initial start of the application: a message with the data protection provisions appears.

- ▶ Select **Accept & Start**.



### Exiting Android Auto

- ▶ Press the  button.

**i** Android Auto starts automatically when the mobile phone is connected with the system using a cable. If Android Auto was not displayed in the foreground before disconnecting, the application starts in the background when reconnected. You can call up Android Auto in the main menu.



### Calling up the Android Auto sound settings

Multimedia system:

- ▶  ▶ **Mercedes me & Apps**
- ▶ **Smartphone** ▶ **Android Auto** ▶ 
- ▶ Select sound settings.

### Setting control of the application buttons (Android Auto)

Multimedia system:

- ▶  ▶ **Mercedes me & Apps**
- ▶ **Smartphone** ▶ **Android Auto** ▶ 
- ▶ **General**
- ▶ To switch **Control via Application Buttons** on: activate the LED symbol.
- ▶ To deactivate **Control via Application Buttons**: deactivate the LED symbol.

### Ending Android Auto

- ▶ **To end the connection of Android Auto (with cable)**: disconnect the connection via the connecting cable between the mobile phone and multimedia system.
- i** Mercedes-Benz recommends disconnecting the connecting cable only when the vehicle is stationary.

### Transferred vehicle data with Android Auto and Apple CarPlay™

#### Overview of transferred vehicle data

When using Android Auto or Apple CarPlay™, certain vehicle data is transferred to the mobile phone. This enables you to get the best out of selected mobile phone services. Vehicle data is not directly accessible.

The following system information is transmitted:

- Software release of the multimedia system
- System ID (anonymized)

The transfer of this data is used to optimize communication between the vehicle and the mobile phone.

To do this, and to assign several vehicles to the mobile phone, a vehicle identifier is randomly generated.

This has no connection to the vehicle identification number (VIN) and is deleted when the multimedia system is reset (→ page 286).

The following driving status data is transmitted:

- Transmission position engaged

- Distinction between parked, standstill, rolling and driving
- Day/night mode of the instrument cluster

The transfer of this data is used to alter how content is displayed to correspond to the driving situation.

The following position data is transmitted:

- Coordinates
- Speed
- Compass direction
- Acceleration direction

This data is only transferred while the navigation system is active, in order to improve it (e.g. so it can continue functioning when in a tunnel).

### Mercedes me connect

#### Notes on Mercedes me connect

Mercedes me connect consists of multiple services.

Depending on whether the services are activated and on the vehicle equipment, you can use the following services via the multimedia system and the overhead control panel, for example:

- Accident and breakdown management (me button)
- If the service is activated: Concierge Service (me button)
- Mercedes-Benz emergency call system (automatic emergency call or SOS button)

Mercedes me connect accident and breakdown management, the Mercedes me connect Concierge Service (if service is activated) and the Mercedes-Benz emergency call center are available for you around the clock.

The me button and the SOS button can be found on the vehicle's overhead control panel .

You can also call the Mercedes-Benz Customer Center using the multimedia system .

Please note that Mercedes me connect is a Mercedes-Benz service. In emergencies, always call the national emergency services first using the standard national emergency service phone

numbers. In emergencies, you can also use the Mercedes-Benz emergency call system (→ page 351).

Observe the conditions of use for Mercedes me connect and other services. These can be obtained in the Mercedes me portal: <https://me.secure.mercedes-benz.com>

Further information about Mercedes me connect services can be obtained in the Mercedes me portal: <https://me.secure.mercedes-benz.com>

### Calling the Mercedes-Benz Customer Center using the multimedia system

#### Requirements:

- Access to a GSM network is available.
- The contract partner's GSM network coverage is available in the respective region.
- The ignition must be switched on so that vehicle data can be transferred automatically.

Multimedia system:



▶ Call Mercedes me connect.

Then, you can select a service and be connected to a specialist at the Mercedes-Benz Customer Center.

Further information on Mercedes me connect, the provided service scope and operation are available at: [http://manuals.daimler.com/baix/cars/connectme/en\\_GB/index.html](http://manuals.daimler.com/baix/cars/connectme/en_GB/index.html)

### Making a call via the overhead control panel

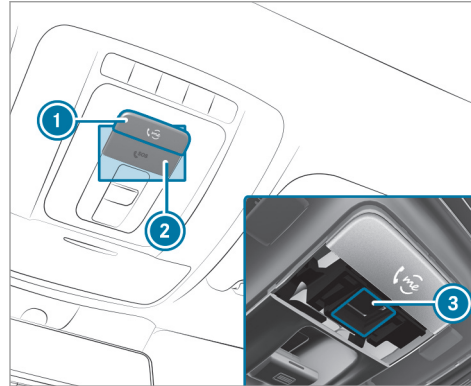

- ① me button for service, concierge or information calls
- ② SOS button cover
- ③ SOS button (emergency call system)

▶ **To make a Mercedes me call:** press me button ①.

- ▶ **To make an emergency call:** press SOS button cover ② briefly to open.
- ▶ Press and hold SOS button ③ for at least one second.

If a Mercedes me call is active, an emergency call can still be triggered. This has priority over all other active calls.

### Information about the Mercedes me call using the me button

A call to the Mercedes-Benz Customer Center has been initiated via the me button in the overhead control panel or the multimedia system .

Using the voice dialog system you access the desired service:

- Concierge Service (if the service is activated)
- Accident and breakdown management (→ page 348)
- Mercedes-Benz Customer Center for general information about the vehicle

You can find information on the following topics:

- Activation of Mercedes me connect
- Operating the vehicle

- Nearest authorized Mercedes-Benz Center
- Other products and services from Mercedes-Benz

Data is transferred during the connection to the Mercedes-Benz Customer Center (→ page 348).

### Information on Mercedes me connect accident and breakdown management

The accident and breakdown management can include the following functions:

- Supplement to the Mercedes-Benz emergency call system (→ page 351)  
If necessary, the contact person at the Mercedes-Benz emergency call center forwards the call to Mercedes me connect breakdown and accident management. Forwarding the call is however not possible in all countries.
- Breakdown assistance by a mechanic on location and/or the towing away of the vehicle to the nearest authorized Mercedes-Benz Center  
You may be charged for these services.

More information about Mercedes me connect services can be obtained in the Mercedes me portal: <https://me.secure.mercedes-benz.com>

### Arranging a service appointment via Mercedes me connect

If you have activated the maintenance management service, relevant vehicle data is transferred automatically to the Mercedes-Benz Customer Center. You will then receive individual recommendations regarding the maintenance of your vehicle.

Regardless of whether you have consented to the maintenance management service, the multimedia system reminds you after a certain amount of time that a service is due. A prompt appears asking if you would like to make an appointment.

#### ▶ To arrange a service appointment: select Call.

After your agreement the vehicle data is sent and a Mercedes-Benz Customer Center employee deals with your appointment. The information is then sent to your desired service outlet.

This will contact you to confirm the appointment and if necessary consult about the details.

- ❗ If you select **Later** after the service message appears, the message is hidden and reappears after a certain period of time.

### Transferred data during a Mercedes me call

The data transferred when calling depends on the services activated and the type of call made:

- General information about the vehicle
- Concierge Service
- Accident and breakdown assistance
- Service appointment arrangement

Which data is transferred for the services, can be taken from the currently valid terms of use. These can be obtained in the Mercedes me portal: <https://me.secure.mercedes-benz.com>

The following data is transmitted if no service is activated and the data protection prompt has been confirmed:

- Vehicle identification number

- Mercedes me customer identification number
- Reason for the initiation of the call
- Language set in the multimedia system
- Confirmation of the data protection prompt

During the service appointment arrangement via the service reminder, **the current mileage and maintenance data** can also be transferred, assuming the required data transfer technology is supported by the mobile service operator and the quality of the mobile connection is sufficient.

In addition, **the current location of the vehicle** can be demanded by the Mercedes-Benz Customer Center from the vehicle, if accident and breakdown management is called via the voice control system and no service has been activated, but the data protection query has been confirmed.

- ① At the time of going to press, this function is technically not yet available but can be supported in the future.

The following data is transmitted if the data protection prompt has been rejected:

- Reason for the initiation of the call
- Rejection of the data protection prompt

### Mercedes me and apps

#### Information about Mercedes me

When you log in with a user account to the Mercedes me portal, then services and offers from Mercedes-Benz will be available to you.

Availability is country-dependent.

For more information consult an authorized Mercedes-Benz Center or visit the Mercedes me portal: <http://me.secure.mercedes-benz.com>

- ① Make sure you always keep the Mercedes me apps updated.

#### Calling up the Mercedes me user account

Multimedia system:



#### Your vehicle is connected with a user account

- ▶ Select **Mercedes me**.  
Information about the connected user account appears.

#### Your vehicle is not yet connected with a user account

- ▶ Select **Mercedes me**.
- ▶ The instructions for creating a user account and connecting the vehicle with this follow on the media display.
- ① If the Mercedes me app is available on a mobile phone, the vehicle connection can be accomplished using the QR code shown.

#### Calling up the Mercedes me services

##### Requirements:

- The vehicle is connected with the user account.

Multimedia system:

→  » Mercedes me & Apps

▶ Select **Services**.

Within the various categories you can see the Mercedes me services you have already purchased and also those still available to purchase.

To activate or deactivate the services, log in to your user account in the Mercedes me portal.

### Deleting a connection between a user account and the vehicle

#### Requirements:

- The (vehicle) profile of the user account that was initially connected with the vehicle is selected.
- The profile is synchronized (→ page 256).
- A PIN has been set.

Multimedia system:

→  » Mercedes me & Apps

» Mercedes me

▶ Select **Delete Vehicle Assignment**.

▶ Enter the PIN of the connected user account.

 Only the user, whose user account was initially connected with the vehicle can delete the connection between all user accounts and the vehicle.

### Mercedes-Benz emergency call system

#### Information on the Mercedes-Benz emergency call system

Your vehicle is equipped with the Mercedes-Benz emergency call system ("eCall"). This feature can help save lives in the event of an accident. eCall in no way replaces assistance provided from dialing 911.

Mercedes-Benz eCall only functions in areas where mobile phone coverage is available from the wireless service providers. Insufficient network coverage from the wireless service provid-

ers may result in an emergency call not being transmitted.

eCall is a standard feature in your Mercedes-Benz vehicle. In order to function as intended, the system relies on the transmission of data detailed in the "Mercedes-Benz emergency call system data transmission" section that follows (→ page 352).

To disable eCall, a customer must visit an authorized Mercedes-Benz Service department to deactivate the vehicle's communication module.

**Deactivation of this module prevents the activation of any and all Mercedes me connect services. After the deactivation of eCall, automatic emergency call and manual emergency call will not be available.**

The ignition must be switched on before an automatic emergency call can be made.

 eCall is activated at the factory.

- ❗ eCall can be deactivated by an authorized Mercedes-Benz dealer. Please note that in the event ownership of the vehicle is transferred to another owner in its deactivated state, eCall will remain deactivated unless the new owner visits an authorized Mercedes-Benz dealership to reactivate the system.

### Overview of the Mercedes-Benz emergency call system

eCall can help to reduce the time between an accident and the arrival of emergency services at the site of the accident. It helps locate an accident site in places that are difficult to access. However, even if a vehicle is equipped with eCall, this does not mean the system is ON. As such, eCall does not replace dialing 911 in the event of an accident.

The emergency call can be made automatically (→ page 351) or manually (→ page 352). Only make emergency calls if you or others are in need of rescue.

Only make emergency calls if you or others are in need of rescue. Do not make an emergency

call in the event of a breakdown or a similar situation.

### Notification in the multimedia system display:

**SOS NOT READY:** the ignition is not on or eCall not available.

During an active emergency call,  appears in the display.

You can find more information on the regional availability of eCall at: [http://www.mercedes-benz.com/connect\\_ecall](http://www.mercedes-benz.com/connect_ecall)

- ❗ If there is a malfunction in the Mercedes-Benz emergency call system (e.g. a malfunction with the speaker, microphone, airbag, SOS button), a corresponding message appears in the multifunction display of the instrument cluster.

### Triggering an automatic Mercedes-Benz emergency call

#### Requirements:

- The ignition is switched on.
- The starter battery is sufficiently charged.

The Mercedes-Benz emergency call system triggers an emergency call automatically in the following cases:

- After activation of the restraint systems such as airbags or Emergency Tensioning Devices after an accident.

The emergency call has been made:

- A voice connection is made to the Mercedes-Benz emergency call center.
- A message with accident data is transmitted to the Mercedes-Benz emergency call center.

The Mercedes-Benz emergency call center can transmit the vehicle position data to one of the emergency call centers.

The SOS button in the overhead control panel flashes until the emergency call is finished.

It is not possible to immediately end an automatic emergency call.

If no connection can be made to the emergency services either, a corresponding message appears in the media display.

- ▶ Dial the local emergency number on your mobile phone.

If an emergency call has been initiated:

- Remain in the vehicle if the road and traffic conditions permit you to do so until a voice connection is established with the emergency call center service provider.
- On the basis of the call, the service provider decides whether it is necessary to call rescue teams and/or the police to the accident site.
- If no vehicle occupant answers, an ambulance is sent to the vehicle immediately.

#### Triggering a manual Mercedes-Benz emergency call

- ▶ **To use the SOS button in the overhead control panel:** press the SOS button at least one second long .
- ▶ **To use voice control:** use the Voice Control System voice commands (→ page 231).

The emergency call has been made:

- A voice connection is made to the Mercedes-Benz emergency call center.

- A message with accident data is transmitted to the Mercedes-Benz emergency call center.

The Mercedes-Benz emergency call center can transmit the vehicle position data to one of the emergency call centers.

- Remain in the vehicle if the road and traffic conditions permit you to do so until a voice connection is established with the emergency call center service provider.
- On the basis of the call, the service provider decides whether it is necessary to call rescue teams and/or the police to the accident site.

If no connection can be made to the emergency services either, a corresponding message appears in the media display.

- ▶ Dial the local emergency number on your mobile phone.

#### Ending an unintentionally triggered manual Mercedes-Benz emergency call

- ▶ **On the multifunction steering wheel:** select . Depress button for several seconds.

#### Data transfer of the Mercedes-Benz emergency call system

In the event of an automatic or manual emergency call the following data is transmitted, for example:

- Vehicle's GPS position data
- GPS position data on the route (a few hundred meters before the incident)
- Direction of travel
- Vehicle identification number
- Vehicle drive type
- Number of people determined to be in the vehicle
- Whether Mercedes me connect is available or not
- Whether the emergency call was initiated manually or automatically
- Time of the accident
- Language setting on the multimedia system

Data transmitted is vehicle information. For any questions about the collection, use and sharing of the eCall system data, please contact MBU-



SA's Customer Assistance Center at 800-FOR-MERC.

For Canada, please contact MBC's Customer Assistance Center at 1-800-387-0100.

Customer requests for covered information should be submitted via the same channels.

For accident clarification purposes, the following measures can be taken up to an hour after the emergency call has been initiated:

- The current vehicle position can be called up.
- A voice connection to the vehicle occupants can be established.

## Online and Internet functions

### Internet connection

#### Information on connecting to the Internet

**⚠ WARNING** Risk of distraction from information systems and communications equipment

If you operate information and communication equipment integrated in the vehicle when driving, you will be distracted from the traffic situation. This could also cause you to lose control of the vehicle.

- ▶ Only operate this equipment when the traffic situation permits.
- ▶ If you cannot be sure of this, stop the vehicle whilst paying attention to road and traffic conditions and operate the equipment with the vehicle stationary.

You must observe the legal requirements for the country in which you are currently driving when operating the multimedia system.

**⚠ WARNING** Risk of an accident from operating mobile communication equipment while the vehicle is in motion

Mobile communications devices distract the driver from the traffic situation. This could also cause the driver to lose control of the vehicle.

- ▶ As the driver, only operate mobile communications devices when the vehicle is stationary.
- ▶ As a vehicle occupant, only use mobile communications devices in the areas intended for this purpose, e.g. in the rear passenger compartment.

You must observe the legal requirements for the country in which you are currently driving when operating mobile communication equipment in the vehicle.

The Internet functions can only be used to a limited degree whilst driving.

### Function of the communication module

On vehicles with a built-in communication module, the Internet connection is established via an integrated SIM card.

To use Internet access via the communication module the following conditions must be met:

- Mercedes me connect is active and ready for operation.
- Mercedes me connect is activated for Internet access.
- In some countries: data volume via Mercedes me connect is available.

In some countries: if the data volume limit is reached, the availability of Mercedes me connect services is limited. The data volume must be purchased via Mercedes me connect.

- ① Contact an authorized Mercedes-Benz Center to find out whether it is possible to purchase data volume in your country.

### Establishing an Internet connection

Multimedia system:

➔  ➔ Mercedes me & Apps

▶ For example, select  Browser.

- ① The multimedia system usually establishes the Internet connection automatically. If the multimedia system is not connected to the Internet, the Internet connection is established when an Internet application is used.
- ① The availability of web browsers is country-dependent.

### Connection status

#### Connection status overview

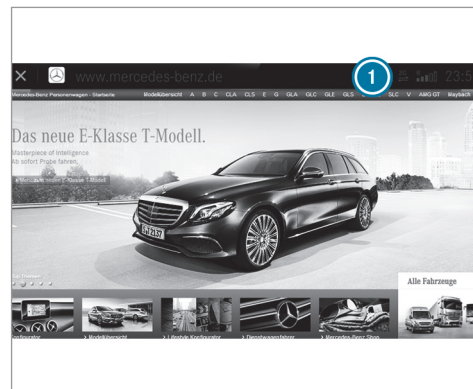

- ① Display of existing connection (double arrow) and reception field strength of the communication module

## Displaying the connection status

Multimedia system:

→  » Settings » System  
» Wi-Fi & Bluetooth

▶ Select **Internet Status**.

**i** In the case of a connection via the communication module the following status information is shown:

- Type of network
- Status online/offline

## Web browser

### Calling up a web page

**⚠ WARNING** Risk of distraction from information systems and communications equipment

If you operate information and communication equipment integrated in the vehicle

when driving, you will be distracted from the traffic situation. This could also cause you to lose control of the vehicle.

- ▶ Only operate this equipment when the traffic situation permits.
- ▶ If you cannot be sure of this, stop the vehicle whilst paying attention to road and traffic conditions and operate the equipment with the vehicle stationary.

You must observe the legal requirements for the country in which you are currently driving when operating the multimedia system.

Multimedia system:

→  » Mercedes me & Apps  
»  Browser

### Calling up a new web page

- ▶ Select **URL**.
- ▶ Entering a web address

▶ Select **OK** .

- i** The function is country-dependent.
- i** Websites cannot be shown while the vehicle is in motion.

### Calling up a website from the browser history

- ▶ To call up the previous or next page from the history: select **←** or **→**.

## Web browser overview

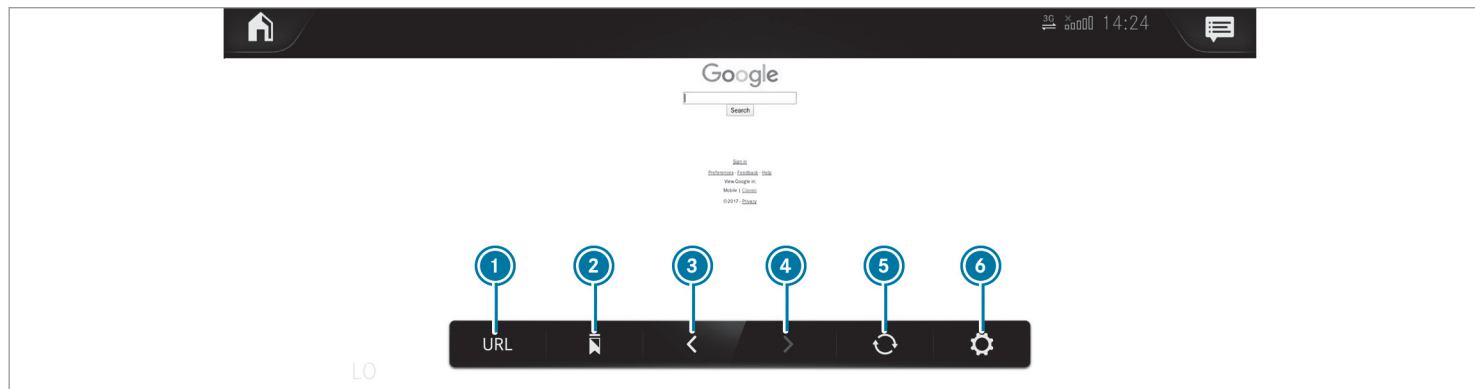

- ① URL entry
- ② Bookmarks

- ③ Web page, back
- ④ Web page, forwards

- ⑤ To refresh/stop
- ⑥ Options

### Calling up web browser options

Multimedia system:





 Mercedes me & Apps  

 Browser
 

The following functions are available:

- [Bookmarks](#)
- [Options with the settings:](#)
  - [Browser Settings](#)
  - [Delete Browser Data](#)

-  Select an option.
-  Change the settings.

### Calling up the web browser settings

Multimedia system:



 Mercedes me & Apps  

 Browser
 
  
 [Browser Settings](#)

The following functions are available:





- [Block Pop-ups](#)
- [Activate Javascript](#)
- [Allow Cookies](#)

 **To switch a function on:** activate the LED symbol.



 **To switch a function off:** deactivate the LED symbol.

### Deleting Internet history

Multimedia system:





 Mercedes me & Apps  

 Browser
 
  
 [Delete Browser Data](#)

The following options are available:

- [All](#)
  - [Cache](#)
  - [Cookies](#)
  - [Entered URLs](#)
-  Select an option.
  -  Select [Yes](#).

### Managing bookmarks

Multimedia system:



 Mercedes me & Apps  

 Browser

 Select .







### Selecting a bookmark

 Select an entry.





### Creating a bookmark

 Select [Add Current Page to Bookmarks](#).  
The bookmark is created.

### Editing a bookmark



-  Select  after a bookmark.
-  Select [Edit](#).
-  Enter the name.
-  Select .

### Deleting a bookmark

-  Select  after a bookmark.
-  Select [Delete](#).
-  Select [Yes](#).

### Closing the browser

Multimedia system:

-  » Mercedes me & Apps
- »  Browser
- ▶ Select .

### Internet radio

---

#### Calling up Internet radio

#### Requirements:

- The Internet radio service is activated.

- The data volume is available.  
Depending on the country, data volume may need to be purchased.
- A fast Internet connection for data transmission free of interference.
- ⓘ The functions and services are country-dependent. For more information, consult an authorized Mercedes-Benz Center.

#### Multimedia system:

→  » Radio

- ▶ Select **TuneIn Radio**.  
The Internet radio menu appears. The last station set starts playing.
- ⓘ The connection quality depends on the local mobile phone reception.

## Internet radio overview

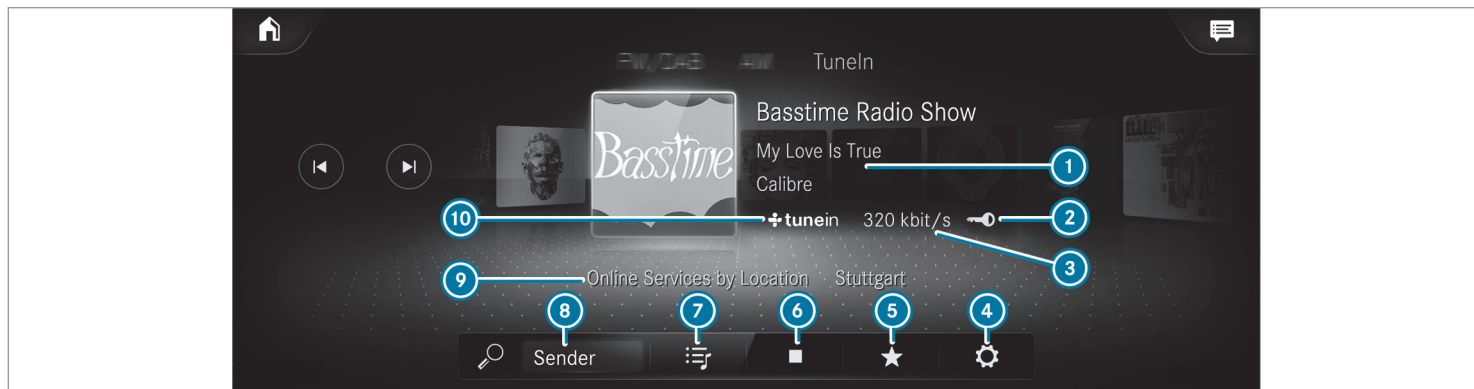

- ① Additional information on the current station
- ② Display (if connected to private user account)
- ③ Data transfer rate

- ④ Options
- ⑤ Favorites
- ⑥ To start/end
- ⑦ To browse

- ⑧ Search
- ⑨ Selected category
- ⑩ Internet radio provider

### Selecting and connecting Internet radio stations

Multimedia system:

 **▶▶ Radio ▶▶ Tuneln Radio**

- ▶ Select .
- ▶ Select a category.
- ▶ Select a station.  
The connection is established automatically.

or

- ▶ Select the search field.
- ▶ Enter a station name.

 A relatively large volume of data can be transmitted when using Internet radio.

### Saving/deleting an Internet radio station as a favorite

Multimedia system:

 **▶▶ Radio ▶▶ Tuneln Radio**

- ▶ Select a station.
- ▶ Select .
- The list of saved favorite stations appears.
- ▶ Select **Add to favorites**.

or

- ▶ Create an account for the online provider (Tuneln radio) and then log in on the multimedia system.  
Your favorites are imported to the multimedia system.

### Deleting favorites

- ▶ Select a station.
- ▶ Select .
- ▶ Select **Delete favorite**.

### Setting Internet radio options

Multimedia system:

 **▶▶ Radio ▶▶ Tuneln Radio ▶▶ **  
**▶▶ Tuneln**

The following options are available:

- **Select Stream:** select the stream quality.
- **Login to Tuneln Account:** log in to your Tuneln user account.
- **Log Out of Account:** log out of your Tuneln user account.
- ▶ Select an option.

### Showing the station list for the last category selected

Multimedia system:

 **▶▶ Radio ▶▶ Tuneln Radio**

- ▶ Press the cover of the current station.  
Depending on how the station was selected, a station list is shown.

## Media

### Information about media mode

### Information about supported formats and data storage media

 **WARNING** Risk of distraction when handling data storage media

If you handle a data storage medium while driving, your attention is diverted from the traffic conditions. This could also cause you to lose control of the vehicle.

- ▶ Only handle a data storage medium when the vehicle is stationary.



**The multimedia system supports the following formats and data media:**

Permissible file systems	FAT32, exFAT, NTFS
Permissible data carriers	USB devices, iPod®/iPhone®, MTP devices, Bluetooth® audio equipment
Supported audio formats	MP3, WMA, AAC, WAV, FLAC, ALAC
Supported video formats	MPEG, AVI, DivX, MKV, MP4, M4V, WMV

**i** Observe the following notes:

- The multimedia system supports a total of up to 50,000 files.
- Data storage media up to 2 TB are supported (32-bit address space).
- Due to the large variety of available music and video files regarding encoders, sampling rates and data transfer rates, playback cannot be guaranteed.

- Due to the wide range of USB devices available on the market, playback cannot be guaranteed for all USB devices.
- Videos up to FullHD (1920x1080) are supported.
- Copy-protected music and video files or DRM (Digital Rights Management) encrypted files cannot be played back.
- MP3 players must support Media Transfer Protocol (MTP).

**Information on copyright protection and trademarks**

Audio files which you create yourself (e.g. copies of data storage media you make yourself) are generally subject to copyright protection. In many countries, reproductions are not permitted without the prior consent of the copyright holder, even for private use. Make sure that you know about the applicable copyright regulations and that you comply with these.



Manufactured under license from Dolby Laboratories. Dolby, Dolby Audio and the double-D symbol are trademarks of Dolby Laboratories.



Gracenote, the Gracenote logo and logotype, "Powered by Gracenote", MusicID and Playlist Plus are either registered trademarks or trademarks of Gracenote, Inc. in the United States and/or other countries.



TIDAL and TIDAL logo are registered trademark of Aspiro AB in the European Union and other countries.



For DTS Patents, see <http://patents.dts.com>.  
Manufactured under license from DTS Licensing Limited. DTS, the Symbol, & DTS and the Symbol together are registered trademarks, and DTS TrueVolume is a trademark of DTS, Inc.®. DTS, Inc. All rights reserved.

## Overview of the media menu



- ① Previous track or fast rewind
- ② Next track or fast forward
- ③ Album cover
- ④ Active media source
- ⑤ Track and artist

- ⑥ Current track number/track in playback list and active data storage medium
- ⑦ Repeat
- ⑧ Settings
- ⑨ Additional options

- ⑩ Controls playback
- ⑪ Timeline
- ⑫ Categories
- ⑬ Music search
- ⑭ Random playback

## Connecting the data storage medium to the multimedia system

### Connecting USB devices

**NOTE** Damage caused by high temperatures

High temperatures can damage USB devices.

- ▶ Remove the USB device after use and take it out of the vehicle.

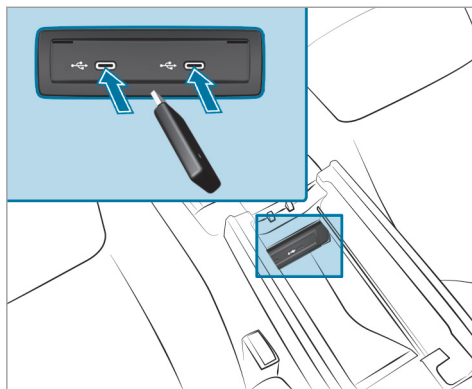

The multimedia connection unit is found in the stowage compartment under the armrest and has two type C USB ports. Depending on the vehicle's equipment, additional USB ports can be found in the stowage compartment of the center console or rear folding compartment.

- ▶ Connect the USB device to the USB port.

**i** When connecting several Apple® devices simultaneously, pay attention to the order in

which the devices are connected. The multimedia system only connects with the device that is connected first. Additional Apple® devices that are connected at the same time are only supplied with power.

### Searching for and authorizing a Bluetooth® audio device

#### Requirements:

- Bluetooth® is activated on the multimedia system and audio equipment.
- The audio equipment supports the Bluetooth® audio profiles A2DP and AVRCP.
- The audio equipment is "visible" for other devices.

Multimedia system:

➤ ▶▶ Media ▶▶ Bluetooth ▶▶

### Authorizing a new Bluetooth® audio device

- ▶ Select **Connect New Device**. Detected equipment is displayed in the device list.

- ▶ Select an audio device. Authorization starts. A code is displayed on the multimedia system and on the mobile phone.
- ▶ If the codes are identical, confirm on the audio equipment.
- ▶ Select **Only as Bluetooth Audio Device**. The Bluetooth® audio equipment is connected with the multimedia system.

### Connecting previously authorized Bluetooth® audio equipment

- ▶ Select a Bluetooth® audio device from the list. The connection is established.

### Starting media playback

#### Requirements

- A data storage medium is connected to the multimedia system.

Multimedia system:





- ▶ Select **USB** or **Bluetooth** as the media source.

### Controlling media playback

Multimedia system:



- ▶ **To pause playback:** select .
- ▶ **To continue playback:** select .
- ▶ **To repeat a track:** select .

For the repeat function there are the following settings:

- **Select once:** the active playlist is repeated.
- **Select twice:** the current track is repeated.
- **Select three times:** the repeat function is deactivated.

- ▶ **To play back tracks in random order:**

select .

- ▶ **To wind a track forwards or backwards:**

tap on the desired point on the timeline.

- ▶ **To select the next track:** select .

- ▶ **To select the previous track:** select .

- ▶ **To scroll through tracks quickly:** press and hold  or .

- ▶ **To show the current track list:** select the track image shown.

### Additional options for setting media playback

Multimedia system:



#### Calling up additional options

- ▶ Select . The additional options are shown.

The following options are available:

- **Surprise Mix**

A playlist with randomly selected tracks is created.

- **Add to Favorite Songs**

The current track is added to the favorite songs.

- **Remove from Favorite Songs**

The current track is removed from the favorite songs.

- ▶ Select an option.

## Media search

### Notes about the search function in categories

Under  you can search through all available media files. There are several categories available for selection. The categories shown depend on the connected device and data format.

Available categories with Bluetooth® audio:

- **Current Tracklist**

The folders and categories of the connected device are shown.

Available categories with audio files:

- **Current Tracklist**
- **Playlists**
- **Folder**
- **Albums**
- **Artists**
- **Tracks**
- **Favorite Songs**
- **Often Played**
- **Most Recently Added**
- **Mood** (→ page 367)
- **Music Genres**
- **Year**
- **Composers**
- **Select By Cover**
- **Podcasts** (Apple® devices)
- **Audiobooks** (Apple® devices)

- ⓘ The categories are available as soon as the entire media content has been read in and analyzed.

### Starting a search in categories

Multimedia system:



- ▶ Select a category.
- ▶ Select  and enter a search term.

### Sorting results shown or playing back all media found

- ▶ Select .
- ▶ **To play back all results found in the category:** select **Play All**.  
If, for example, the **Albums** category is active, all albums found by the desired artist will be played back.
- ▶ **To sort results alphabetically:** select **Sort from A-Z**.
- ▶ **To sort results in reverse alphabetical order:** select **Sort from Z-A**.

- ⓘ The available options depend on the selected category and the connected device.

## Using the keyword search

Multimedia system:



You can look for content using the keyword search with free text input.

- ▶ Select . A keyboard for character entry appears.
- ▶ Enter the term searched for.
- ⓘ The search begins with the first character entered. The more characters entered the more concrete the search results become.
- ▶ Select the desired entry from the result list. If the selected result is an album, song or a playback list then playback is started. If the

selected result is a new category then this is opened in the search.

## Searching for a track according to mood

Multimedia system:



By searching in categories, you can find music tracks suitable for a mood.

- ▶ Select **Mood**. A grid with the following moods appears:
  - **Positive**
  - **Calm**
  - **Dark**

- **Energetic**

- ▶ Pull the controller to the desired position. The system searches for tracks that are suitable for the mood entered.

## Radio

### Switching on the radio

Multimedia system:



- ▶ Alternatively: press the  button. The radio display appears. You will hear the last station played on the last frequency band selected.

## Radio overview

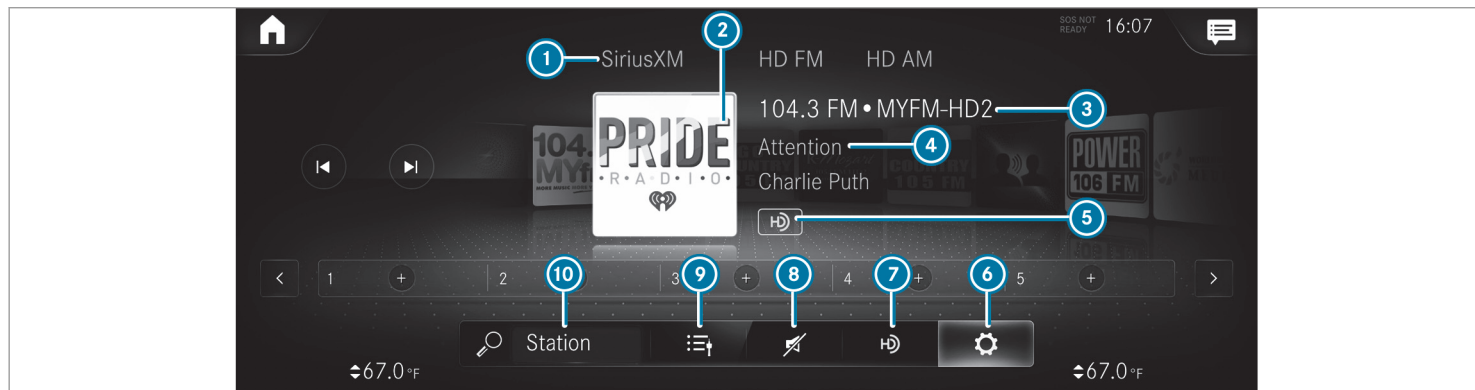

- ① Selects an active frequency band
- ② Station logo
- ③ Station name or set frequency
- ④ Artist, title, album and radio text

- ⑤ HD radio logo
- ⑥ Options
- ⑦ Switches the HD Radio function on or off
- ⑧ Mute function

- ⑨ Calls up the station list
- ⑩ Search



### Switching the HD Radio function on/off

Multimedia system:

→ ▶▶ Radio ▶▶ HD FM



▶ Switch **HD** on or off.

**i** HD Radio Technology manufactured under license from iBiquity Digital Corporation. U.S. and Foreign Patents. For patents see DTS website. HD Radio and the HD, HD Radio, and "ARC" logos are registered trademarks or trademarks of iBiquity Digital Corporation in the United States and/or other countries.

### Setting the waveband

Multimedia system:

→ ▶▶ Radio

The following frequency bands are available:

- SiriusXM
  - HD FM
  - HD AM
- ▶ Select a frequency band.

### Selecting a radio station

Multimedia system:

→ ▶▶ Radio

▶ Swipe to the left or right on the control element.

### Calling up the radio station list

Multimedia system:

→ ▶▶ Radio

▶ Select . The station list appears.

▶ Select a station.

### Searching for radio stations using station names or frequency entry

Multimedia system:

→ ▶▶ Radio

▶ Select .

▶ Enter a station name or frequency.

▶ Select a station.

### Storing radio stations

Multimedia system:

→ ▶▶ Radio

▶ Select a radio station.

**Memory slots are available in station presets**

- ▶ Select .
- or
- ▶ Press and hold on the radio station.

**Replacing an entry in the station presets**

- ▶ Press and hold on an entry in the station presets.
- ▶ Select **Yes**.

**Editing station presets**

Multimedia system:

**Moving stations**

- ▶ Press and hold a stored station.
- ▶ Select **Move**.
- ▶ Move the station to the new position.

**Deleting channels**

- ▶ Press and hold a station.
- ▶ Select **Delete**.

**Replacing a station**

- ▶ Press and hold a station.
- ▶ Select **Replace Radio Station**.

**Showing accident reports**

Multimedia system:



- ▶  The availability of the function is dependent on the country.
- ▶ Switch **Display Emergency Warnings** on or off.

**Displaying radio text**

Multimedia system:



- ▶ Switch **Display Radio Text Information** on or off.

**Satellite radio****Information on the satellite radio**

SIRIUS XM<sup>®</sup> satellite radio offers more than 175 digital-quality radio channels providing 100% commercial-free music, sports, news and entertainment, for example. SIRIUS XM satellite radio employs a fleet of high-performance satellites to broadcast around the clock throughout the USA and Canada. The satellite radio program is available for a monthly fee. Information about this can be obtained from a Sirius XM<sup>®</sup> Service Center and at <http://www.siriusxm.com> (USA) or <http://www.siriusxm.ca> (Canada).

- ▶  Sirius, XM and all related marks and logos are trademarks of Sirius XM Radio Inc. and its subsidiaries. All other marks, channel names and logos are the property of their respective owners. All rights reserved.

**Satellite radio restrictions**

Satellite radio mode may be temporarily unavailable or interrupted for a variety of reasons. These include environmental or topographical conditions beyond the control of Mercedes-Benz

USA, LLC. Thus, operation at certain locations may not be possible.

### Registering satellite radio

#### Requirements:

- Satellite radio equipment is available.
- Registration with a satellite radio provider has been completed.
- If registration is not included when purchasing the system, your credit card details will be required to activate your account

Multimedia system:

   Radio  SiriusXM

  Options

- ▶ Select **Service Information**.  
The service information screen appears showing the radio ID and the current subscription status.
- ▶ Establish a telephone connection.
- ▶ Follow the service staff's instructions.  
The activation process may take up to ten minutes.

- ⓘ You can also have the satellite service activated online. To do so, please visit <http://www.siriusxm.com> (USA) or <http://www.siriusxm.ca> (Canada).

### Switching on satellite radio

Multimedia system:

   Radio

- ▶ Select **SiriusXM**.

### Overview of the satellite radio



- ① Active frequency band
- ② Logo or album art (if available)
- ③ Channel name
- ④ Track information

- ⑤ Traffic & Weather Now and Sports Flash
- ⑥ Options
- ⑦ Shows or hides playback controls
- ⑧ Stops playback controls

- ⑨ Station list
- ⑩ Search

**Selecting a satellite radio category**

Multimedia system:

→ » Radio » SiriusXM

- ▶ Select .
- ▶ Select **Category**.
- ▶ Select a category.

**Selecting a satellite radio channel**

Multimedia system:

→ » Radio » SiriusXM

- ▶ Select .
- ▶ Select a channel.

**Saving or deleting a satellite radio channel**

Multimedia system:

→ » Radio » SiriusXM

**Storing the current channel**

- ▶ Press and hold the logo of the current station until the Options menu appears.
- ▶ Select **Add to Presets**.

**Moving a channel**

- ▶ Press and hold a channel in the presets until the Options menu appears.
- ▶ Select **Move Highlighted Station**.
- ▶ Move the channel to a new position.

**Deleting a channel**

- ▶ Press and hold a channel in the presets until the Options menu appears.
- ▶ Select **Delete Highlighted Station**.

**Displaying EPG information for the current channel**

Multimedia system:

 → » Radio » SiriusXM  
 » 

- ▶ Select **Electr. Program Guide**.

**Setting parental control for radio**

Multimedia system:

 → » Radio » SiriusXM  
 » 

- ▶ Select **Parental Control**.

- ▶ Determine a four-digit character sequence and select **OK**.  
All channels with adult content are locked.

**Unlocking a channel**

- ▶ Enter the four-digit character sequence and select **OK**.  
All channels with adult content are unlocked.

**Music and sport alerts function**

This function enables you to program an alert for your favorite artists, tracks or sporting events. Music alerts can be saved whilst a track is being played and sport alerts can be saved during a live game. You can also specify sport alerts via the menu option. The system then continuously searches through all the channels. If a match is found with a stored alert, you will be informed.

**Setting music and sport alerts**

Multimedia system:

 → » Radio » SiriusXM  
 » » Alerts
**Activating the music information function**

- ▶ Activate **Music Alerts** .

### Setting a music alert

- ▶ Select [Add Alert](#).
- ▶ Select [Artists](#) or [Song](#) in the dialog window. The alert is set for the current artist or track. If a match is found, a prompt appears asking whether you wish to change to the station.

### Activating sports information

- ▶ Activate [Activate Sports Alerts](#) .

### Setting a sport alert

- ▶ Select [Add Alert](#).
- ▶ Select the team name or league in the dialog window.

### Deleting individual sports and music alerts

- ▶ Select [Manage Music Alerts](#).

or

- ▶ Select [Manage Sports Alerts](#).
- ▶ Select an artist or track.

or

- ▶ Select a team.
- ▶ Select [Delete Selected Entries](#). All highlighted alerts are deleted.

### Deleting all sports and music alerts

- ▶ Select [Manage Music Alerts](#).

or

- ▶ Select [Manage Sports Alerts](#).
- ▶ Select [Delete All Entries](#). All alerts are deleted.

### Information about Smart Favorites and TuneStart

From the station presets you can set up to eight stations as Smart Favorites. Smart Favorites stations are automatically saved to temporary storage in the background. If you change to a Smart Favorites station, you can replay, pause or actively skip forward or back to broadcasts which you have missed. If Tune Start is activated and you change to another Smart Favorites station, the music track currently playing on the station is automatically restarted from the beginning of the track.

### Adding a channel to Smart Favorites

Multimedia system:

↳   [Radio](#) [▶▶ SiriusXM](#)

- ▶ Press and hold on the station logo until the Options menu appears.
- ▶ **To add a channel:** select [Add to Smart Favorites](#) in the menu.
- ▶ **To remove a channel:** select [Delete from Smart Favorites](#) in the menu.

### Creating a TuneMix list

Multimedia system:

↳   [Radio](#) [▶▶ SiriusXM](#)  
 ▶▶  [▶▶ TuneMix Lists](#)

In order to listen to seamless music, you can put together a TuneMix list from various stations.

- ▶ Select [Create TuneMix List](#).
- ▶ If necessary, limit the number of stations shown using the [Category](#) entry.
- ▶ Select the station shown .
- ▶ Press  to confirm. A TuneMix station logo is created in the radio menu.

### Activating/deactivating TuneStart

Multimedia system:



- ▶ Switch **TuneStart** on or off.

### Switching on satellite radio playback control

Multimedia system:



You can pause the playback of the current station or skip forward or backward in the timeline. This leaves live mode to access the internal temporary storage.

- ▶ **To show the timeline:** press .

- ▶ **To fast forward/rewind:** tap anywhere on the timeline.

- ▶ **To pause playback:** select .

- ▶ **To return to live mode:** navigate to the end of the timeline.

### Displaying satellite radio service information

Multimedia system:



- ▶ Select **Service Information**.

## Sound

### Tone settings

#### Information about the sound system

The sound system has a total output of 100 W and is equipped with six speakers. It is available for all functions in the radio and media modes.

#### Calling up the sound menu

Multimedia system:



The following functions are available:

- **Equalizer**
- **Balance and Fader**
- **Volume**

- ▶ Select a function.

### Adjusting treble, mid-range and bass settings

Multimedia system:



- ▶ Set **TREBLE**, **MID** or **BASS**.

### Activating/deactivating automatic volume adjustment

Multimedia system:



Automatic volume adjustment compensates for differing volumes when changing between audio sources and within an audio source.

- ▶ Switch **Automatic Adjustment** on or off.

### Adjusting the balance/fader

Multimedia system:

→  » Media »  » Sound  
» Balance and Fader

#### Adjusting the balance

- ▶ Move the volume distribution between the right and left sides of the vehicle in the grid shown.  
The volume is distributed between the speakers on the left and right sides in the vehicle.

#### Adjusting the fader

- ▶ Move the volume distribution between the front and rear of the vehicle in the grid shown.  
The volume is distributed between the speakers in the front and rear of the vehicle.

### Burmester® surround sound system

#### Information about the Burmester® surround sound system

The Burmester® surround sound system has a total output of 590 W and is equipped with 12

speakers. It is available for all functions in the radio and media modes.

#### Calling up the sound menu in the Burmester® surround sound system

Multimedia system:

→  » Media »  » Burmester

The following functions are available:

- Equalizer
- Balance and Fader
- Sound Focus
- Sound Profiles
- Volume

- ▶ Select a function.

#### Adjusting the treble, mid and bass settings on the Burmester® surround sound system

Multimedia system:

→  » Media »  » Burmester  
» Equalizer

- ▶ Set **TREBLE**, **MID** or **BASS**.

#### Activating/deactivating volume adjustment in the Burmester® surround sound system

Multimedia system:

→  » Media »  » Burmester  
» Volume

Automatic volume adjustment compensates for differing volumes when changing between audio sources and within an audio source.

- ▶ Switch **Automatic Adjustment** on or off.

#### Adjusting the balance/fader in the Burmester® surround sound system

Multimedia system:

→  » Media »  » Burmester  
» Balance and Fader

#### Adjusting the balance

- ▶ Move the volume distribution between the right and left sides of the vehicle in the grid shown.  
The volume is distributed between the speakers on the left and right sides in the vehicle.



### Adjusting the fader

- ▶ Move the volume distribution between the front and rear of the vehicle in the grid shown.  
The volume is distributed between the speakers in the front and rear of the vehicle.

### Selecting a sound profile in the Burmester® surround sound system

Multimedia system:

-  ▶ Media ▶  ▶ Burmester
- ▶ Sound Profiles

The following profiles are available:

- Pure
  - Surround
- ▶ Select a sound profile.

### Adjusting the sound focus in the Burmester® surround sound system

Multimedia system:

-  ▶ Media ▶  ▶ Burmester
- ▶ Sound Focus

- ▶ Select a position for the sound focus or *All Seats*.

### Advanced sound system

#### Information about the Advanced sound system

The Advanced sound system has a total output of 225 W and is equipped with ten speakers. It is available for all functions in the radio and media modes.

#### Calling up the sound menu in the Advanced sound system

Multimedia system:

-  ▶ Media ▶  ▶ Sound

The following functions are available:

- Equalizer
- Balance and Fader

- Volume

- ▶ Select a function.

#### Adjusting treble, mid-range and bass settings in the Advanced sound system

Multimedia system:

-  ▶ Media ▶  ▶ Sound
- ▶ Equalizer

- ▶ Set **TREBLE**, **MID** or **BASS**.

#### Switching volume adjustment in the Advanced sound system on/off

Multimedia system:

-  ▶ Media ▶  ▶ Sound
- ▶ Volume

Automatic volume adjustment compensates for differing volumes when changing between audio sources and within an audio source.

- ▶ Switch **Automatic Adjustment** on or off.

### Setting the balance/fader in the Advanced sound system

Multimedia system:

     
▶▶ Balance and Fader

#### Adjusting the balance

- ▶ Move the volume distribution between the right and left sides of the vehicle in the grid shown.  
The volume is distributed between the speakers on the left and right sides in the vehicle.

#### Adjusting the fader

- ▶ Move the volume distribution between the front and rear of the vehicle in the grid shown.  
The volume is distributed between the speakers in the front and rear of the vehicle.

## ASSYST PLUS service interval display

### Function of the ASSYST PLUS service interval display

The ASSYST PLUS service interval display on the Instrument Display provides information on the remaining time or distance before the next service due date.

You can hide this service display using the back button on the left-hand side of the steering wheel.

Depending on how the vehicle is used, the ASSYST PLUS service interval display may shorten the service interval, e.g. in the following cases:

- Mainly short-distance driving
- When the engine is often left idling for long periods
- In the event of frequent cold start phases

Mercedes-Benz recommends avoiding such operating conditions.

You can obtain information concerning the servicing of your vehicle from a qualified specialist

workshop, e.g. an authorized Mercedes-Benz Center.

### Displaying the service due date

On-board computer:

↳ Service ► ASSYST PLUS

The next service due date is displayed.

► **To exit the display:** press the back button on the left-hand side of the steering wheel.

Make sure to observe the following further related subject:

- Operating the on-board computer (→ page 210).

### Information on regular maintenance work

**!** **NOTE** Premature wear through failure to observe service due dates

Service work which is not carried out at the right time or incompletely can lead to increased wear and damage to the vehicle.

- Always observe the prescribed service intervals.
- Always have the prescribed service work carried out at a qualified specialist workshop.

### Special service requirements

The prescribed service interval is based on normal operation of the vehicle. Maintenance work will need to be performed more often if the vehicle is operated under arduous conditions or increased loads.

The ASSYST PLUS service interval display is only an aid. The driver of the vehicle bears responsibility as regards to whether maintenance work needs to be performed more often than specified based on the actual operating conditions and/or loads.

Examples of arduous operating conditions:

- regular city driving with frequent intermediate stops
- mainly short-distance driving

- frequent operation in mountainous terrain or on poor road surfaces
- when the engine is often left idling for long periods
- operation in particularly dusty conditions and/or if air-recirculation mode is frequently used

In these or similar operating conditions, have the interior air filter, engine air cleaner, engine oil and oil filter etc. changed more frequently. The tires must be checked more frequently if the vehicle is operated under increased loads. Further information can be obtained at a qualified specialist workshop.

### Battery disconnection periods

**The ASSYST PLUS service interval display can only calculate the service due date when the battery is connected.**

- ▶ Note down the service due date displayed on the instrument display before disconnecting the battery (→ page 379).

### Engine compartment

#### Opening/closing the hood

**⚠ WARNING** Risk of accident if the engine hood is unlatched while driving

An unlocked engine hood may open up when the vehicle is in motion and block your view.

- ▶ Never unlatch the engine hood while driving.
- ▶ Before every trip, ensure that the engine hood is latched.

**⚠ WARNING** Risk of accident and injury when opening and closing the engine hood

When opening or closing the engine hood, it may suddenly drop into the end position.

There is a risk of injury for anyone in the engine hood's range of movement.

- ▶ Only open or close the engine hood when there are no persons in the engine hood's range of movement.

**⚠ WARNING** Danger of burns when opening the hood

If you open the hood when the engine has overheated or during a fire in the engine compartment, you could come into contact with hot gases or other escaping operating fluids.

- ▶ Before opening the hood, allow the engine to cool down.
- ▶ In the event of a fire in the engine compartment, keep the hood closed and call the fire service.

**⚠ WARNING** Risk of injury due to moving parts

Certain components in the engine compartment may continue to move or suddenly move again even after the ignition has been switched off, e.g. the cooler fan.

Make sure of the following before performing tasks in the engine compartment:

- ▶ Switch the ignition off.

- ▶ Never touch the danger zone surrounding moving component parts, e.g. the rotation area of the fan.
- ▶ Remove jewelry and watches.
- ▶ Keep items of clothing and hair away from moving parts.

**⚠ WARNING** Risk of injury from touching component parts under voltage

The ignition system and the fuel injection system work under high voltage. If you touch component parts which are under voltage, you could receive an electric shock.

- ▶ Never touch component parts of the ignition system or the fuel injection system when the ignition is switched on.

**⚠ WARNING** Risk of burns from hot component parts in the engine compartment

Certain components in the engine compartment can be very hot, e.g. the engine, the radiator and parts of the exhaust system.

- ▶ Allow the engine to cool down and only touch component parts described in the following.

**⚠ WARNING** Risk of injury from using the windshield wipers while the engine hood is open

When the engine hood is open and the windshield wipers are set in motion, you can be trapped by the wiper linkage.

- ▶ Always switch off the windshield wipers and ignition before opening the engine hood.

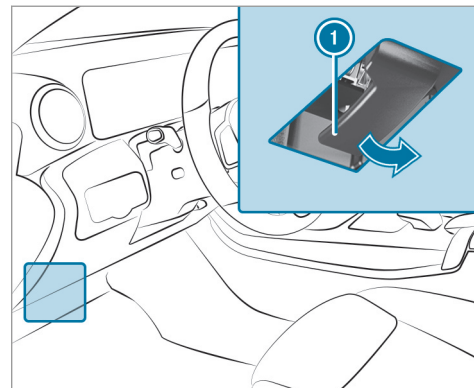

- ▶ **To open:** pull lever ① to release the hood.

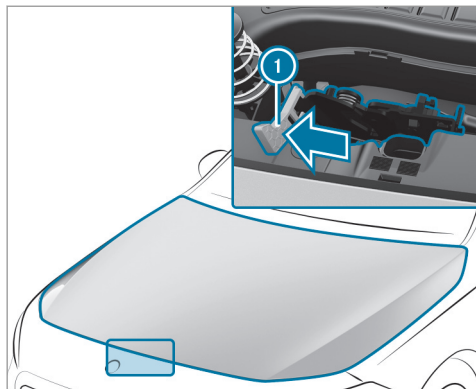

- ▶ Push yellow handle ① on the hood catch to the left as far as it will go (palm downwards). Lift the hood until it is automatically raised by the pneumatic strut.
- ▶ **To close:** lower the hood and let it fall from a height of approximately 8 in (20 cm).
- ▶ If the hood can still be lifted slightly, open the hood again and close it with a little force until it engages correctly.

## Engine oil

### Checking the engine oil level using the on-board computer

#### Requirements

The engine oil level is determined during driving. Determining the engine oil level can take up to 30 minutes with a normal driving style and even longer with an active driving style.

In order to receive a result as quickly as possible:

- Warm up the engine
- Park the vehicle on a level surface
- Leave the engine running at idling speed

On-board computer:

↪ **Service** ▶ **Engine Oil Level**

You will see one of the following messages on the multifunction display:

- **Measuring Engine Oil Level...:** measurement of the oil level is not yet possible.
- ▶ Repeat the request after a maximum of 30 minutes driving.

- **Engine Oil Level OK** and the bar display for indicating the oil level on the multifunction display is green and is between "min" and "max": the oil level is correct.
- **Engine Oil Level Add 1,1 qts.** and the bar display for indicating the oil level on the multifunction display is orange and is below "min":
  - ▶ Add 1.1 US qt (1 l) engine oil.
- **Reduce Engine Oil Level** and the bar display for indicating the oil level on the multifunction display is orange and is above "max":
  - ▶ Drain off excess engine oil that has been added. Consult a qualified specialist workshop.
- **For Engine Oil Level Switch Ignition On:**
  - ▶ Switch on the ignition to check the engine oil level.
- **Engine Oil Level System Inoperative:** sensor faulty or not inserted.
- ▶ Consult a qualified specialist workshop.
- **Engine Oil Level System Currently Unavail.:**

- ▶ Close the hood.

### Adding engine oil

- ⚠ **WARNING** Risk of burns from hot component parts in the engine compartment

Certain components in the engine compartment can be very hot, e.g. the engine, the radiator and parts of the exhaust system.

- ▶ Allow the engine to cool down and only touch component parts described in the following.

- ⚠ **WARNING** Risk of fire and injury from engine oil

If engine oil comes into contact with hot component parts in the engine compartment, it may ignite.

- ▶ Make sure that no engine oil is spilled next to the filler opening.
- ▶ Allow the engine to cool off and thoroughly clean the engine oil from component parts before starting the vehicle.

- ⚠ **NOTE** Engine damage caused by an incorrect oil filter, incorrect oil or additives

- ▶ Do not use engine oils or oil filters which do not correspond to the specifications explicitly prescribed for the service intervals.
- ▶ Do not alter the engine oil or oil filter in order to achieve longer change intervals than prescribed.
- ▶ Do not use additives.
- ▶ Follow the instructions in the service interval display regarding the oil change.

- ⚠ **NOTE** Damage caused by adding too much engine oil

Too much engine oil can damage the engine or the catalytic converter.

- ▶ Have excess engine oil removed at a qualified specialist workshop.

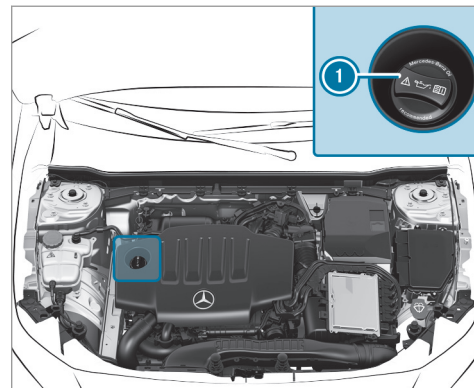

- ▶ Turn cap ① counter-clockwise and remove it.
- ▶ Add engine oil.
- ▶ Replace cap ① and turn it clockwise as far as it will go.
- ▶ Check the oil level again (→ page 382).

### Checking coolant level

**⚠ WARNING** Risk of burns from hot component parts in the engine compartment

Certain components in the engine compartment can be very hot, e.g. the engine, the radiator and parts of the exhaust system.

- ▶ Allow the engine to cool down and only touch component parts described in the following.

**⚠ WARNING** Risk of scalding from hot coolant

The engine cooling system is pressurized, particularly when the engine is warm. If you open the cap, you could be scalded by hot coolant spraying out.

- ▶ Let the engine cool down before opening the cap.
- ▶ When opening the cap, wear protective gloves and safety glasses.
- ▶ Open the cap slowly to release pressure.

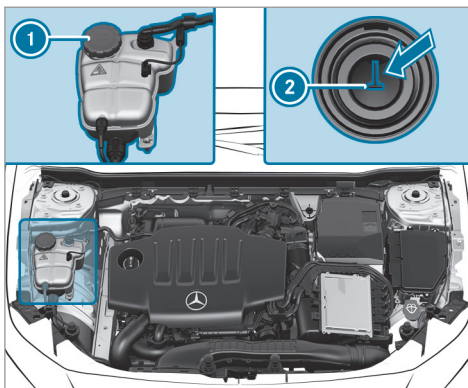

- ▶ Park the vehicle on a level surface.
- ▶ Check the coolant temperature display in the instrument cluster. The coolant temperature must be below 158 °F (70 °C).
- ▶ Slowly turn cap ① counter-clockwise to release overpressure.

- ▶ Continue turning cap ① counter-clockwise and remove it.

The coolant level is correct in the following cases:

- If the engine is cold, the coolant is up to marker bar ②.
- If the engine is warm, the coolant is up to 0.6 in (1.5 cm) over the marker bar ②.
- ▶ If necessary, add coolant that has been approved for Mercedes-Benz.
- Further information on coolant (→ page 454).

### Adding washer fluid to the windshield washer system

**⚠ WARNING** Risk of burns from hot component parts in the engine compartment

Certain components in the engine compartment can be very hot, e.g. the engine, the radiator and parts of the exhaust system.



- ▶ Allow the engine to cool down and only touch component parts described in the following.

**⚠ WARNING** Danger of burns when opening the hood

If you open the hood when the engine has overheated or during a fire in the engine compartment, you could come into contact with hot gases or other escaping operating fluids.

- ▶ Before opening the hood, allow the engine to cool down.
- ▶ In the event of a fire in the engine compartment, keep the hood closed and call the fire service.

**⚠ WARNING** - Risk of fire and injury from windshield washer concentrate

Windshield washer concentrate is highly flammable. It could ignite if it comes into contact with hot engine component parts or the exhaust system.

- ▶ Make sure that no windshield washer concentrate spills out next to the filler opening.

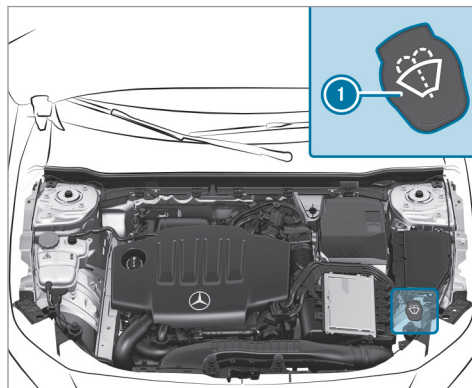

- ▶ Remove cap ① by the tab.
- ▶ Add washer fluid.

### Keeping the air-water duct free

- ▶ Keep the area between the hood and the windshield free of deposits, e.g. ice, snow and leaves.

### Cleaning and care

#### Information on washing the vehicle in a car wash

- ⚠ WARNING** Risk of accident due to reduced braking effect after washing the vehicle

The braking effect is reduced after washing the vehicle.

- ▶ After the vehicle has been washed, brake carefully while paying attention to the traffic conditions until the braking effect has been fully restored.

**!** **NOTE** Damage due to unsuitable car wash

- ▶ Before driving into a car wash make sure that the car wash is suitable for the vehicle dimensions.
- ▶ Ensure there is sufficient ground clearance between the underbody and the guide rails of the car wash.
- ▶ Ensure that the clearance width of the car wash, in particular the width of the guide rails, is sufficient.

To avoid damage to your vehicle when using a car wash, ensure the following beforehand:

- Active Distance Assist DISTRONIC and the HOLD function are deactivated.
- the 360° Camera or the rear view camera is switched off.
- the side windows and sliding sunroof are completely closed.
- the blower for the ventilation/heating is switched off.
- the windshield wiper switch is in position **0**.

- in car washes with a conveyor system: neutral **N** is engaged.
- the SmartKey is at a minimum distance of 10 ft (3 m) away from the vehicle, otherwise the trunk lid could open unintentionally.

- ① If you would like to leave the vehicle while it is being washed, make sure the SmartKey is located in the vehicle. The **P** gear is otherwise automatically engaged.
- ① If, after the car wash, you remove the wax from the windshield and wiper rubbers, this will prevent smearing and reduce wiper noise.

### Activating/deactivating automatic car wash mode

#### Requirements:

- The vehicle is stationary
- The engine is running.

Multimedia system:

- ➔  ➔ **Settings**
- ➔ **Schnellzugriff** (Quick access)

#### Activating automatic car wash mode

- ▶ Select **Automatic car wash mode**.
- ▶ Select **Start**.

If one of the settings cannot be selected, this is displayed by a **X** behind the respective setting.

- ① For an overview of the settings made when activating automatic car wash mode (→ page 385).

#### Deactivating automatic car wash mode

- ▶ Select **Stop**.  
The automatic car wash settings are reset.
- ① The automatic car wash mode is automatically deactivated as soon as a speed of 6 mph (10 km/h) is exceeded.

### Information on using a power washer

**▲ WARNING** Risk of accident when using high-pressure cleaning equipment with round-spray nozzles

The water jet from a round-spray nozzle (dirt grinder) may cause damage to tires and suspension components that is not visible.

Components damaged in this way may fail unexpectedly.

- ▶ Do not use high-pressure cleaning equipment with round-spray nozzles to clean your vehicle.
- ▶ Damaged tires or suspension components must be replaced immediately.

To avoid damage to your vehicle, observe the following when using a power washer:

- keep the SmartKey at least 10 ft (3 m) away from the vehicle. Otherwise the trunk lid could open unintentionally.
- maintain a distance of at least 11.8 in (30 cm) to the vehicle.
- **vehicles with decorative foil:** parts of your vehicle are covered with a decorative foil. Maintain a distance of at least 27.6 in (70 cm) between the foil-covered parts of the vehicle and the nozzle of the power washer. Move the power washer nozzle around whilst cleaning. The water temperature of the power washer must not exceed 140 °F (60 °C).
- observe the information on the correct distance in the equipment manufacturer's operating instructions.
- do not point the nozzle of the power washer directly at sensitive parts such as tires, slits, electrical components, batteries, light bulbs and ventilation slots.

### Washing the vehicle by hand

Observe the legal requirements, e.g. in a number of countries, washing by hand is only permitted in specially designated wash bays.

- ▶ Use a mild cleaning agent, e.g. car shampoo.
- ▶ Wash the vehicle with lukewarm water using a soft car sponge. When doing so, do not expose the vehicle to direct sunlight.
- ▶ Carefully hose the vehicle off with water and dry using a chamois. Take care not to point the water jet directly towards the air inlet grille below the hood.

### Notes on paintwork/matte finish paintwork care

Observe the following information:

	Cleaning and care	Avoiding paintwork damage
<b>Paintwork</b>	<ul style="list-style-type: none"><li>• Insect remains: soak with insect remover and rinse off the treated areas afterwards.</li><li>• Bird droppings: soak with water and rinse off afterwards.</li><li>• Tree resin, oils, fuels and greases: remove by rubbing gently with a cloth soaked in petroleum ether or lighter fluid.</li><li>• Coolant and brake fluid: remove with a damp cloth and clean water.</li><li>• Tar stains: use tar remover.</li><li>• Wax: use silicone remover.</li></ul>	<ul style="list-style-type: none"><li>• Do not attach stickers, films or similar.</li><li>• Remove dirt immediately, where possible.</li></ul>

Cleaning and care		Avoiding paintwork damage
<b>Matte finish</b>	<ul style="list-style-type: none"> <li>• Only use care products approved for Mercedes-Benz.</li> </ul>	<ul style="list-style-type: none"> <li>• Do not polish the vehicle and alloy wheels.</li> <li>• Only use car washes that correspond to the latest engineering standards.</li> <li>• Do not use car wash programs with a final hot wax treatment.</li> <li>• Do not use paint cleaners, buffing or polishing products, gloss preservers, e.g. wax.</li> <li>• Always have paintwork repairs carried out at a qualified specialist workshop.</li> </ul>

### Notes on cleaning decorative foils

Observe the notes on matte finish care in the chapter "Notes on paintwork/matte finish paint-

work care" (→ page 388). They also apply to matte decorative foils.

**Observe the following information:**

Cleaning	Avoiding damage to the decorative foil
<ul style="list-style-type: none"><li>• For cleaning, use plenty of water and a mild cleaning agent without additives or abrasive substances, e.g. a car shampoo approved for Mercedes-Benz.</li><li>• Remove dirt immediately, where possible, whilst avoiding rubbing too hard. There is otherwise a risk of damaging the decorative foil irreparably.</li><li>• If there is dirt on the finish or if the decorative foil is dull: use the Paint Cleaner recommended and approved for Mercedes-Benz.</li><li>• Insect remains: soak with insect remover and rinse off the treated areas afterwards.</li><li>• Bird droppings: soak with water and rinse off afterwards.</li><li>• To prevent water stains, dry a foil-wrapped vehicle with a soft, absorbent cloth after every car wash.</li></ul>	<ul style="list-style-type: none"><li>• The service life and color of decorative foils are impaired by:<ul style="list-style-type: none"><li>- Sunlight</li><li>- Temperature, e.g. hot air blower</li><li>- Weather conditions</li><li>- Stone chippings and dirt</li><li>- Chemical cleaning agents</li><li>- Oily products</li></ul></li><li>• Do not use polish on matte decorative foil. Polishing will have the effect of shining the foil-wrapped surface.</li><li>• Do not treat matte or structured decorative foils with wax. Permanent stains may occur.</li></ul>

Scratches, corrosive deposits, areas affected by corrosion and damage caused by incorrect care cannot always be completely repaired. In such cases, visit a qualified specialist workshop.

You can obtain more information on care and cleaning products from the manufacturer.

In the case of foil-wrapped surfaces, optical differences may occur between the surfaces that were not protected by a decorative foil after removing a decorative foil.

**i** Have work or repairs to decorative foils carried out at a qualified specialist workshop, e.g. in an authorized Mercedes-Benz Center.

### Notes on care of vehicle parts

**⚠ WARNING** Risk of entrapment if the windshield wipers are switched on while the windshield is being cleaned

If the windshield wipers are set in motion while you are cleaning the windshield or wiper blades, you can be trapped by the wiper arm.

▶ Always switch off the windshield wipers and the ignition before cleaning the windshield or wiper blades.

**⚠ WARNING** Risk of burning from the tailpipe or tailpipe trim

The tailpipe and tailpipe trim can become very hot. If you come into contact with these car parts, you could burn yourself.

▶ Always be particularly careful when in the vicinity of the tailpipe and tailpipe trims and supervise children very closely when in this area.

▶ Before any contact, allow the car parts to cool down.

### Observe the following information:

	Notes on cleaning and care	Avoiding vehicle damage
<b>Wheels/rims</b>	Use water and acid-free wheel cleaners.	<ul style="list-style-type: none"> <li>• Do not use acidic wheel cleaners to remove brake dust. This could damage wheel bolts and brake components.</li> <li>• To avoid corrosion of the brake discs and brakepads, drive the vehicle for a few minutes after cleaning before parking it. The brake discs and brakepads warm up and dry out.</li> </ul>
<b>Windows</b>	Clean windows inside and outside with a damp cloth and with a cleaning agent recommended for Mercedes-Benz.	Do not use dry cloths or abrasive or solvent-based cleaning agents to clean the inside of windows.
<b>Wiper blades</b>	Fold out the wiper blades and clean them using a damp cloth.	Do not clean the wiper blades too often.

	Notes on cleaning and care	Avoiding vehicle damage
<b>Exterior lighting</b>	Clean the lenses with a wet sponge and mild cleaning agent, e.g. car shampoo.	Only use cleaning agents or cleaning cloths that are suitable for plastic lenses.
<b>Sensors</b>	Clean the sensors in the front and rear bumper and in the radiator grill with a soft cloth and car shampoo.	When using a power washer, maintain a minimum distance of 11.8 in (30 cm).
<b>Rear view camera and 360° Camera</b>	<ul style="list-style-type: none"> <li>Use clean water and a soft cloth to clean the camera lens.</li> </ul>	Do not use a power washer.
<b>Tailpipes</b>	Clean with a cleaning agent recommended for Mercedes-Benz, especially in the winter and after washing the vehicle.	Do not use acidic cleaning agents.

### Notes on care of the interior

**⚠ WARNING** Risk of injury from plastic parts breaking off after the use of solvent-based care products

Care and cleaning products containing solvents can cause surfaces in the cockpit to become porous.

When the airbags are deployed, plastic parts may break away.

- ▶ Do not use any care or cleaning products containing solvents to clean the cockpit.

**⚠ WARNING** Risk of injury or death from bleached seat belts

Bleaching or dyeing seat belts can severely weaken them.

This can, for example, cause seat belts to tear or fail in an accident.

- ▶ Never bleach or dye seat belts.



## Observe the following information:

	Cleaning and care	Avoiding vehicle damage
<b>Seat belts</b>	Clean with lukewarm and soapy water.	<ul style="list-style-type: none"> <li>Do not use chemical cleaning agents.</li> <li>Do not dry seat belts by heating them to over 176 °F (80 °C) or exposing them to direct sunlight.</li> </ul>
<b>Display</b>	Clean the surface carefully with a microfiber cloth and a suitable display care product (TFT/LCD).	<ul style="list-style-type: none"> <li>Switch off the display and let it cool down.</li> <li>Do not use any other cleaning products.</li> </ul>
<b>Plastic trim</b>	<ul style="list-style-type: none"> <li>Clean with a damp microfiber cloth.</li> <li>For heavy soiling: use care product recommended for Mercedes-Benz.</li> </ul>	<ul style="list-style-type: none"> <li>Do not attach stickers, films or similar materials.</li> <li>Do not allow cosmetics, insect repellent or sun cream to come in contact with the plastic trim.</li> </ul>
<b>Real wood/trim inserts</b>	<ul style="list-style-type: none"> <li>Clean with a microfiber cloth.</li> <li>Black piano-lacquer look: clean with a damp cloth and soapy water.</li> <li>For heavy soiling: use care product recommended for Mercedes-Benz.</li> </ul>	Do not use solvent-based cleaning agents, polishes or waxes.
<b>Headliner</b>	Clean with a brush or dry shampoo.	
<b>Carpet</b>	Use carpet and textile cleaning agents recommended for Mercedes-Benz.	

	Cleaning and care	Avoiding vehicle damage
<b>Genuine leather seat covers</b>	<ul style="list-style-type: none"><li>• Clean with a damp cloth and then wipe with a dry cloth.</li><li>• Leather care: use leather care agents that have been recommended for Mercedes-Benz.</li></ul>	<ul style="list-style-type: none"><li>• Do not allow the leather to become too damp.</li><li>• Do not use a microfiber cloth.</li></ul>
<b>DINAMICA seat covers</b>	Clean with a damp cloth.	Do not use a microfiber cloth.
<b>Imitation leather seat covers</b>	Clean with a damp cloth and 1% soapy water.	Do not use a microfiber cloth.
<b>Cloth seat covers</b>	Clean with a damp microfiber cloth and 1% soapy water and allow to dry.	

## Emergency

### Removing the safety vest

The safety vests are located in the safety vest compartments in the driver's and front passenger door stowage compartments.

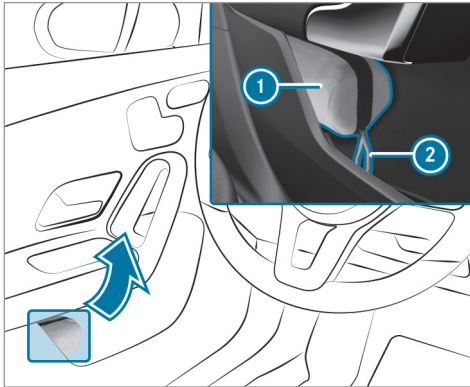

▶ **To remove:** pull out safety vest bag ① by loop ②.

▶ Open safety vest bag ① and pull out the safety vest.

① There are also safety vest compartments in the rear door stowage compartments in which safety vests can be stored.

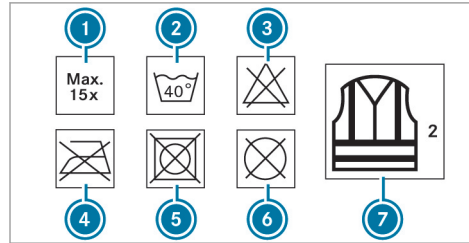

- ① Maximum number of washes
- ② Maximum wash temperature
- ③ Do not bleach
- ④ Do not iron
- ⑤ Do not tumble dry
- ⑥ Do not dry clean
- ⑦ Class 2 safety vest

The requirements defined by the legal standard are only fulfilled if the safety vest is the correct size and is fully closed.

The safety vest must be replaced in the following situations:

- the reflective strips are damaged or dirty
- the maximum permissible number of washes is exceeded
- the fluorescence has faded

## Warning triangle

### Removing the warning triangle

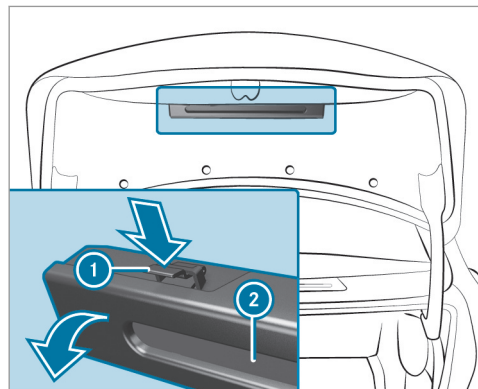

- ▶ Push both sides of warning triangle holder ① in the direction of the arrow and open it.
- ▶ Remove warning triangle ②.

### Setting up the warning triangle

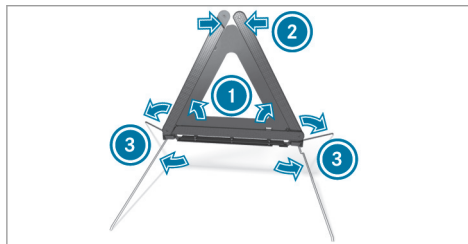

- ▶ Fold side reflectors ① upwards to form a triangle and attach at the top using upper press-stud ②.
- ▶ Fold legs ③ down and out to the side.

## First-aid kit (soft-sided) overview

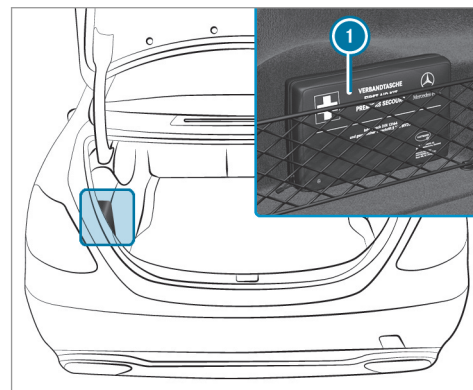

First-aid kit (soft sided) ① is in the trunk in the left-hand storage net.

## Flat tire

### Notes on flat tires

**⚠ WARNING** Risk of accident due to a flat tire

A flat tire severely affects the driving characteristics as well as the steering and braking of the vehicle.

#### Tires without run-flat characteristics:

- ▶ Do not drive on with a flat tire.
- ▶ Change the flat tire immediately with an emergency spare wheel or spare wheel. Alternatively, consult a qualified specialist workshop.

#### Tires with run-flat characteristics:

- ▶ Observe the information and warning notes on MOExtended tires (run-flat tires).

In the event of a flat tire, the following options are available depending on your vehicle's equipment:

- **Vehicles with MOExtended tires:** it is possible to continue the journey for a short period of time. Make sure you observe the notes on MOExtended tires (run-flat tire) (→ page 397).
- **Vehicles with a TIREFIT kit:** you can repair the tires so that it is possible to continue the journey for a short period of time. To do this, use the TIREFIT kit (→ page 398).
- **Vehicles with Mercedes me connect:** you can make a call for Roadside Assistance via the overhead control panel in the case of a breakdown .
- **All vehicles:** change the wheel (→ page 442).

### Notes on MOExtended tires (run-flat tire)

**⚠ WARNING** Risk of accident when driving in emergency mode

When driving in emergency mode, the handling characteristics are impaired. e.g. when cornering, when accelerating strongly and when braking.

- ▶ Do not exceed the permissible maximum speed for MOExtended tires.
- ▶ Avoid any abrupt steering and driving maneuvers as well as driving over obstacles (curbs, pot holes, off-road). This applies, in particular, to a loaded vehicle.
- ▶ Stop driving in the emergency mode if you notice:
  - banging noise
  - vehicle vibration
  - smoke which smells like rubber
  - continuous ESP® intervention
  - cracks in tire side walls

- ▶ After driving in emergency mode have the rims checked by a qualified specialist workshop with regard to their further use.
- ▶ The defective tire must be replaced in every case.

With MOExtended tires (run-flat tire), you can continue to drive your vehicle even if there is a total loss of pressure in one or more tires. However, the tire affected must not show any clearly visible damage.

You can recognize MOExtended tires by the MOExtended marking which appears on the side wall of the tire.

**Vehicles with tire pressure loss warning system:** MOExtended tires may only be used in conjunction with an activated tire pressure loss warning system.

**Vehicles with tire pressure monitoring system:** MOExtended tires may only be used in conjunction with an activated tire pressure monitoring system.

If a pressure loss warning message appears in the multifunction display, proceed as follows:

- Check the tire for damage.
- If driving on, observe the following notes.

#### Driving distance possible in emergency mode after the pressure loss warning:

Load condition	Driving distance possible in emergency mode
Partially laden	50 miles (80 km)
Fully laden	19 miles (30 km)

The driving distance possible in emergency mode may vary depending on the driving style. Observe the maximum permissible speed of 50 mph (80 km/h).

If a tire has gone flat and cannot be replaced with an MOExtended tire, you can use a standard tire as a temporary measure.

#### TIREFIT kit storage location

The TIREFIT kit is located under the trunk floor.

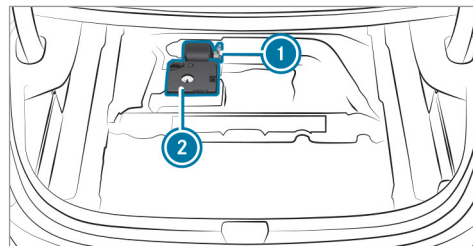

- ① Tire sealant bottle
- ② Tire inflation compressor

#### Using the TIREFIT kit

##### Requirements:

- Tire sealant bottle
- TIREFIT sticker
- Tire inflation compressor
- Gloves (depending on the vehicle equipment)

TIREFIT kit storage location: (→ page 398)

You can use TIREFIT tire sealant to seal perforation damage of up to 0.16 in (4 mm), particularly those in the tire contact surface. You can use TIREFIT in outside temperatures down to -4 °F (-20 °C).

**⚠ WARNING** Risk of accident when using tire sealant

In the following situations in particular, the tire sealant is unable to provide sufficient breakdown assistance, as it is unable to seal the tire properly:

- There are cuts or punctures in the tire larger than those previously mentioned.
  - The wheel rim is damaged.
  - You have driven at very low tire pressure or on a flat tire.
- ▶ Do not drive on.
- ▶ Consult a qualified specialist workshop.

**⚠ WARNING** Risk of injury and poisoning from tire sealant

The tire sealant is harmful and causes irritation. Do not allow it to come into contact with the skin, eyes or clothing, and do not swallow it. Do not inhale tire sealant fumes. Keep the tire sealant away from children.

If you come into contact with the tire sealant, observe the following:

- ▶ Rinse off the tire sealant from your skin immediately using water.
- ▶ If tire sealant gets into your eyes, thoroughly rinse out the eyes using clean water.
- ▶ If tire sealant has been swallowed, immediately rinse out the mouth thoroughly and drink plenty of water. Do not induce vomiting and seek medical attention immediately.
- ▶ Change out of any clothes contaminated with tire sealant immediately.
- ▶ If allergic reactions occur, seek medical attention immediately.

**! NOTE** Overheating due to the tire inflation compressor running too long

- ▶ Do not run the tire inflation compressor for longer than ten minutes without interruption.

Comply with the manufacturer's safety notes on the sticker on the tire inflation compressor.

Have the tire sealant bottle replaced at a qualified specialist workshop every five years.

- ▶ Do not remove any foreign objects which have entered the tire.

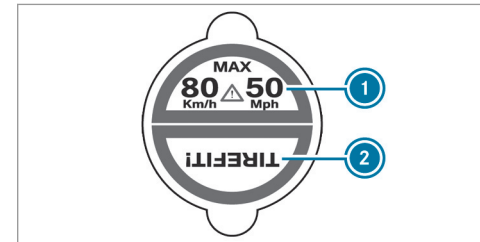

- ▶ Affix part ① of the TIREFIT sticker to the instrument cluster within the driver's field of vision.
- ▶ Affix part ② of the TIREFIT sticker near the valve on the wheel with the faulty tire.

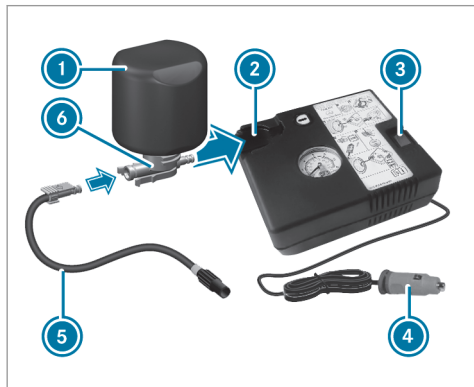

- ▶ Pull plug ④ with the cable and hose ⑤ out of the tire inflation compressor housing.

- ▶ Push the plug of hose ⑤ into flange ⑥ of tire sealant bottle ① until the plug engages.
- ▶ Place tire sealant bottle ① head downwards into recess ② of the tire inflation compressor.



- ▶ Remove the valve cap from valve ⑦ on the faulty tire.
- ▶ Screw filling hose ⑧ onto valve ⑦.
- ▶ Insert plug ④ into a 12 V socket in your vehicle.
- ▶ Switch on the ignition.

- ▶ Press on and off switch ③ on the tire inflation compressor. The tire inflation compressor is switched on. The tire is inflated. First, tire sealant is pumped into the tire. The pressure may briefly rise to approximately 500 kPa (5 bar/73 psi).

**Do not switch off the tire inflation compressor during this phase.**

- ▶ Let the tire inflation compressor run for a maximum of ten minutes. The tire should then have attained a tire pressure of at least 200 kPa (2.0 bar/29 psi).

If tire sealant leaks out, make sure you clean the affected area as quickly as possible. It is preferable to use clean water.

If you get tire sealant on your clothing, have it cleaned as soon as possible with perchloroethylene.



**If, after ten minutes, a tire pressure of 200 kPa (2.0 bar/29 psi) has not been achieved:**

- ▶ Switch off the tire inflation compressor.
- ▶ Unscrew the filling hose from the valve of the defective tire.

Please note that tire sealant may leak out when unscrewing the filling hose.

- ▶ Drive forwards or reverse very slowly for approximately 33 ft (10 m).
- ▶ Pump up the tire again.  
After a maximum of ten minutes the tire pressure must be at least 200 kPa (2.0 bar/29 psi).

**⚠ WARNING** Risk of accident due to the specified tire pressure not being reached

If the specified tire pressure is not reached after the specified time, the tire is too badly damaged. The tire sealant cannot repair the tire in this instance.

Damaged tires and a tire pressure that is too low can significantly impair braking and handling characteristics.

- ▶ Do not continue driving.
- ▶ Consult a qualified specialist workshop.

**If, after ten minutes, a tire pressure of 200 kPa (2.0 bar/29 psi) has been achieved:**

- ▶ Switch off the tire inflation compressor.
- ▶ Unscrew the filling hose from the valve of the defective tire.

**⚠ WARNING** Risk of accident from driving with sealed tires

A tire temporarily sealed with tire sealant impairs driving characteristics and is not suitable for higher speeds.

- ▶ Adapt your driving style accordingly and drive carefully.
- ▶ Do not exceed the maximum speed limit with a tire that has been repaired using tire sealant.

- ▶ Observe the maximum permissible speed for a tire sealed with tire sealant 50 mph (80 km/h).
- ▶ Affix the upper section of the TIREFIT sticker to the instrument cluster in a location where it will be easily seen by the driver.

**!** **NOTE** Staining caused by leaking tire sealant

After use, excess tire sealant may leak out from the filling hose.

- ▶ Therefore, place the filling hose in the plastic bag that contained the TIREFIT kit.

**🔥 ENVIRONMENTAL NOTE** Environmental pollution caused by environmentally irresponsible disposal

Tire sealant contains pollutants.

- ▶ Have the tire sealant bottle disposed of professionally, e.g. at an authorized Mercedes-Benz Center.

- ▶ Stow the tire sealant bottle and the tire inflation compressor.
- ▶ **Pull away immediately.**
- ▶ Stop driving after approximately ten minutes and check the tire pressure using the tire inflation compressor.  
The tire pressure must now be at least 130 kPa (1.3 bar/19 psi).

**⚠ WARNING** Risk of accident due to the specified tire pressure not being reached

If the specified tire pressure is not reached after a brief drive, the tire is too badly damaged. The tire sealant cannot repair the tire in this instance.

Damaged tires and tire pressure that is too low can significantly impair the braking properties and the handling characteristics.

- ▶ Do not continue driving.
- ▶ Consult a qualified specialist workshop.

In cases such as the one mentioned above, contact an authorized Mercedes-Benz Center. Or

call 1-800-FOR-MERCEdes (in the USA) or 1-800-387-0100 (in Canada).

- ▶ **To increase the tire pressure:** switch on the tire inflation compressor.

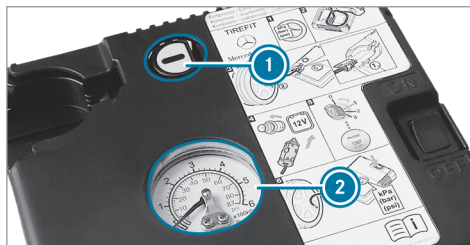

- ▶ **To reduce the tire pressure:** press pressure release button ① next to pressure gauge ②.
- ▶ When the tire pressure is correct, unscrew the filling hose from the valve of the sealed tire.
- ▶ Screw the valve cap onto the valve of the sealed tire.

- ▶ Pull the tire sealant bottle out of the tire inflation compressor.  
The filling hose stays on the tire sealant bottle.
- ▶ Drive to the nearest qualified specialist workshop and have the tire, tire sealant bottle and filling hose replaced there.

## Battery (vehicle)

### Notes on the 12 V battery

**⚠ WARNING** Risk of an accident due to work carried out incorrectly on the battery

Work carried out incorrectly on the battery can, for example, lead to a short circuit. This can lead to function restrictions in safety-relevant systems, for example the lighting system, ABS (anti-lock braking system) or ESP® (Electronic Stability Program). The operating safety of your vehicle may be restricted.

You could lose control of the vehicle in the following situations:

- when braking
  - in the event of abrupt steering maneuvers and/or when the vehicle's speed is not adapted to the road conditions
- ▶ In the event of a short circuit or a similar incident, contact a qualified specialist workshop immediately.
- ▶ Do not continue driving.
- ▶ Always have work on the battery carried out at a qualified specialist workshop.

- Further information on ABS (→ page 158)
- Further information on ESP® (→ page 159)

For safety reasons, Mercedes-Benz recommends that you only use batteries which have been tested and approved for your vehicle by Mercedes-Benz. These batteries provide increased impact protection to prevent vehicle occupants from suffering acid burns should the battery be damaged in the event of an accident.

#### All vehicles except vehicles with a lithium-ion battery

**⚠ WARNING** Risk of explosion due to electrostatic charge

Electrostatic charge can cause sparks which may ignite the highly flammable gas mixture in the battery.

- ▶ To discharge any electrostatic charge that may have built up, touch the metal vehicle body before handling the battery.

The highly flammable gas mixture is created while the battery is charging and during starting assistance.

**⚠ WARNING** Danger of chemical burns from the battery acid

Battery acid is caustic.

- ▶ Avoid contact with the skin, eyes or clothing.
- ▶ Do not lean over the battery.

- ▶ Do not inhale battery gases.
- ▶ Keep children away from the battery.
- ▶ Immediately rinse battery acid off thoroughly with plenty of clean water and seek medical attention immediately.

#### All vehicles

**🔥 ENVIRONMENTAL NOTE** Environmental damage caused by improper disposal of batteries



Batteries contain pollutants. It is illegal to dispose of them with the household rubbish.



Dispose of batteries in an environmentally responsible manner. Take discharged batteries to a qualified

specialist workshop or to a collection point for used batteries.

If you have to disconnect the 12 V battery, contact a qualified specialist workshop.

Comply with safety notes and take protective measures when handling batteries.



Risk of explosion.



Fire, open flames and smoking are prohibited when handling the battery. Avoid creating sparks.



Electrolyte or battery acid is corrosive. Avoid contact with the skin, eyes or clothing. Wear suitable protective clothing, in particular gloves, an apron and a face mask. Immediately rinse electrolyte or acid splashes off with clean water. Consult a doctor if necessary.



Wear safety glasses.



Keep children away.



Observe this Operator's Manual.

Observe the following if you do not intend to use the vehicle over an extended period of time:

- Activate standby mode.
- Alternatively: connect the battery to a battery charger approved by Mercedes-Benz or consult a qualified specialist workshop to disconnect the battery.

### Notes on starting assistance and on charging the 12 V battery

#### Vehicles with a lithium-ion battery

When charging the battery and during starting assistance, always use the jump-start connection point in the engine compartment.

**!** **NOTE** Damage to the battery from over-voltage

When charging using a battery charger without a maximum charging voltage, the battery or the on-board electronics may be damaged.

► Only use battery chargers with a maximum charging voltage of 14.4 V.

#### All other vehicles

When charging the battery and during starting assistance, always use the jump-start connection point in the engine compartment.

**!** **NOTE** Damaging the battery through overvoltage

When charging using a battery charger without a maximum charging voltage, the battery or the vehicle electronics may be damaged.

- ▶ Only use battery chargers with a maximum charging voltage of 14.8 V.

**!** **WARNING** Risk of explosion from hydrogen gas igniting

A battery generates hydrogen gas during the charging process. If there is a short circuit or sparks start to form, there is a danger of the hydrogen gas igniting.

- ▶ Make sure that the positive terminal of the connected battery does not come into contact with vehicle parts.
- ▶ Never place metal objects or tools on a battery.
- ▶ When connecting and disconnecting the battery, you must observe the described order for the battery clamps.

- ▶ When giving starting assistance, always make sure that you only connect battery terminals with identical polarity.
- ▶ During starting assistance, you must observe the described order for connecting and disconnecting the jumper cables.
- ▶ Do not connect or disconnect the battery clamps while the engine is running.

**!** **WARNING** Risk of explosion during charging process and starting assistance

During the charging process and starting assistance, the battery may release an explosive gas mixture.

- ▶ Avoid fire, open flames, creating sparks and smoking.
- ▶ Make sure that there is sufficient ventilation during the charging process and during starting assistance.
- ▶ Do not lean over a battery.

**!** **WARNING** Risk of explosion from a frozen battery

A discharged battery may freeze at temperatures slightly above or below freezing point.

During starting assistance or battery charging, battery gas may be released.

- ▶ Always thaw a frozen battery out first before charging it or performing starting assistance.

If the indicator/warning lamps in the instrument cluster do not light up at low temperatures, it is very likely that the discharged battery has frozen. In this case you may neither jump-start the vehicle nor charge the battery.

The service life of a battery that has been thawed may be dramatically shortened. The starting characteristics may be impaired, especially at low temperatures.

It is recommended that you have a thawed battery checked at a qualified specialist workshop.

## All vehicles

**!** **NOTE** Damage caused by numerous or extended attempts to start the engine

Numerous or extended attempts to start the engine may damage the catalytic converter due to non-combusted fuel.

▶ Avoid numerous and extended attempts to start the engine.

Observe the following points during starting assistance and when charging the battery:

- Only use undamaged jumper cables/charging cables with a sufficient cross-section and insulated terminal clamps.
- Non-insulated parts of the terminal clamps must not come into contact with other metal parts while the jumper cable/charging cable is connected to the battery/jump-start connection point.
- The jumper cable/charging cable must not come into contact with any parts which may move when the engine is running.

- Always make sure that neither you nor the battery is electrostatically charged.
- Keep away from fire and open flames.
- Do not lean over the battery.

Observe the additional following points when charging the battery:

- Only use battery chargers tested and approved for Mercedes-Benz.
- Read the battery charger's operating instructions before charging the battery.

Observe the additional following points during starting assistance:

- Starting assistance may only be provided using batteries with a nominal voltage of 12V.
- The vehicles must not touch.
- **Gasoline engine:** Only accept starting assistance if the engine and exhaust system are cold.

## Starting assistance and charging the 12 V battery

### Requirements:

- The vehicle is secured with the electric parking brake.
- **Vehicles with automatic transmission:** The transmission is in position **P**.
- The ignition and all electrical consumers are switched off.
- The hood is open.

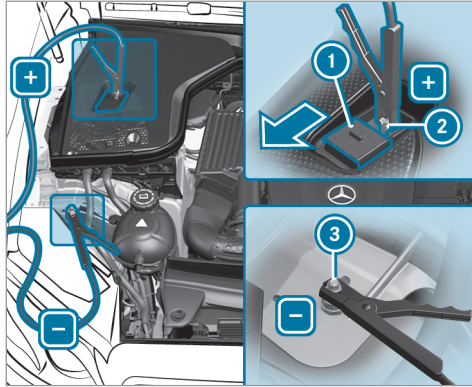

- ▶ Slide cover ① of positive clamp ② on the jump-starting connection point in the direction of the arrow.
- ▶ Connect positive clamp ② on your vehicle to the positive pole of the donor battery using the jumper cable/charging cable. Always begin with positive clamp ② on your own vehicle first.

- ▶ **During starting assistance:** start the engine of the donor vehicle and run at idle speed.
- ▶ Connect the negative pole of the donor battery and ground point ③ of your own vehicle by using the jumper cable/charging cable. Begin with the donor battery first.
- ▶ **During starting assistance:** start the engine of your own vehicle.
- ▶ **During the charging process:** start the charging process.
- ▶ **During starting assistance:** let the engines run for several minutes.
- ▶ **During starting assistance:** before disconnecting the jumper cable, switch on an electrical consumer in your own vehicle, e.g. the rear window heater or lighting.

When the starting assistance/charging process is complete, perform the following steps:

- ▶ First, remove the jumper cable/charging cable from ground point ③ and the negative pole of the donor battery, then from positive clamp ② and the positive pole of the donor

battery. Begin each time with the contacts on your own vehicle first.

- ▶ After removing the jumper cable/charging cable, close cover ① of positive clamp ②.

Further information can be obtained at a qualified specialist workshop.

### Replacing the 12 V battery

- ▶ Observe the notes on the 12 V battery (→ page 402).

Mercedes-Benz recommends that you have the 12 V battery replaced at a qualified specialist workshop, e.g. at an authorized Mercedes-Benz Center.

Observe the following notes if you want to replace the battery yourself:

- Always replace a faulty battery with a battery which meets the specific vehicle requirements.

The vehicle is equipped with an AGM technology battery (Absorbent Glass Mat) or a lithium-ion battery. Full vehicle functionality is

only guaranteed with an AGM battery or lithium-ion battery. For safety reasons, Mercedes-Benz recommends that you only use batteries which have been tested and approved for your vehicle by Mercedes-Benz.

- Carry over detachable parts, such as vent hoses, elbow fitting or terminal covers from the battery being replaced.
- Make sure that the vent hose is always connected to the original opening on the side of the battery.

Install any existing or supplied cell caps. Otherwise, gases or battery acid could escape.

- Make sure that detachable parts are reconnected in the same way.

### Tow starting or towing away

#### Permitted towing methods

Mercedes-Benz recommends transporting your vehicle in the case of a breakdown, rather than towing it away.

For towing, use a tow rope or tow bar with both axles on the ground. Do not use tow bar systems.

**⚠ WARNING** Risk of accident when towing with steering wheel lock

You will no longer be able to steer the vehicle if the steering wheel lock is engaged.



- ▶ Always switch on the ignition when towing the vehicle with a tow cable or a tow bar.

**! NOTE** Damage to the vehicle due to towing away incorrectly

- ▶ Observe the instructions and notes on towing away.



## Permitted towing methods

Vehicle equipment/towing method	 <b>Both axles on the ground</b>	 <b>Front axle raised</b>	 <b>Rear axle raised</b>
Vehicles with automatic transmission	Yes, maximum 31 miles (50 km) at 31 mph (50 km/h)	Yes, maximum 31 miles (50 km) at 31 mph (50 km/h)	Yes, maximum 31 miles (50 km) at 31 mph (50 km/h) if the steering wheel is fixed in the center position with a steering wheel lock
4MATIC vehicles	Yes, maximum 31 miles (50 km) at 31 mph (50 km/h)	No	No

**Towing with a raised axle:** towing should be performed by a towing company.

### Towing the vehicle with both axles on the ground

- ▶ Observe the notes on the permitted towing methods (→ page 408).

- ▶ Make sure that the battery is connected and charged.

Observe the following points when the battery is discharged:

- The engine cannot be started
- The electric parking brake cannot be released or applied

- **Vehicles with automatic transmission:** The automatic transmission cannot be shifted to position **N** or **P**.

**i Vehicles with automatic transmission:** If the automatic transmission cannot be shifted to position **N**, or the multifunction display in the instrument cluster does not show anything, have the vehicle transported away (→ page 411). A towing vehicle with lifting equipment is required for vehicle transportation.

**!** **NOTE** Damage due to towing away at excessively high speeds or over long distances

The drivetrain could be damaged when towing at excessively high speeds or over long distances.

- ▶ A towing speed of 30 mph (50 km/h) must not be exceeded.
- ▶ A towing distance of 30 miles (50 km) must not be exceeded.

**!** **WARNING** Risk of accident when towing a vehicle which is too heavy

If the vehicle being tow-started or towed away is heavier than the permissible gross mass of your vehicle, the following situations can occur:

- The towing eye may become detached.
- The vehicle/trailer combination may swerve or even overturn.

▶ If another vehicle is tow-started or towed away, its weight must not exceed the permissible gross mass of your own vehicle.

If a vehicle must be tow started or towed away, its permissible gross mass must not exceed the permissible gross mass of the towing vehicle.

- ▶ Information on the permissible gross mass of the vehicle can be found on the vehicle identification plate (→ page 449).
- ▶ **Vehicles with automatic transmission:** Do not open the driver's door or front passenger

door, otherwise the automatic transmission automatically shifts to position **P**.

- ▶ Installing the towing eye (→ page 413).
- ▶ Fasten the tow bar.

**!** **NOTE** Damage due to incorrect connection

▶ Only connect the tow rope or tow bar to the towing eyes.

- ▶ Deactivating the automatic locking mechanism (→ page 71).
- ▶ Do not activate the HOLD function.
- ▶ Deactivating the tow-away alarm (→ page 86).
- ▶ Deactivate Active Brake Assist (→ page 167).
- ▶ **Vehicles with automatic transmission:** Shift the automatic transmission to position **N**.
- ▶ Release the electric parking brake.

**⚠ WARNING** Risk of accident due to limited safety-related functions during the towing process

Safety-related functions are limited or no longer available in the following situations:

- the ignition is switched off.
- the brake system or power steering system is malfunctioning.
- the energy supply or the on-board electrical system is malfunctioning.

When your vehicle is then towed away, significantly more effort may be required to steer and brake than is normally required.

- ▶ Use a tow bar.
- ▶ Make sure that the steering wheel can move freely, before towing the vehicle away.

**⚠ NOTE** Damage due to excessive tractive power

If you pull away sharply, the tractive power may be too high and the vehicles could be damaged.

- ▶ Pull away slowly and smoothly.

### Loading the vehicle for transport

- ▶ Observe the notes on towing away (→ page 409).
- ▶ Connect the tow bar to the towing eye in order to load the vehicle.
- ▶ **Vehicles with automatic transmission:** Shift the automatic transmission to position **[N]**.
- ▶ **Vehicles with automatic transmission:** The automatic transmission may be locked in position **[P]** in the event of damage to the electrical system. To shift to **[N]**, provide the on-board electrical system with power (→ page 406).

- ▶ Load the vehicle onto the transporter.
- ▶ **Vehicles with automatic transmission:** Shift the automatic transmission to position **[P]**.
- ▶ Use the electric parking brake to secure the vehicle against rolling away.
- ▶ Only secure the vehicle by the wheels.

### AMG vehicles with ADS PLUS (Adaptive Damping System PLUS)

**⚠ WARNING** Risk of an accident when transporting vehicles with Adaptive Damping System PLUS

The reduced damping forces on the vehicle being transported can cause the vehicle/trailer combination to start to swing.

As a result, when transporting vehicles with the Adaptive Damping System PLUS, the vehicle/trailer combination may start to skid. Consequently, you could lose control of your vehicle.

- ▶ When transporting, ensure that:

- The vehicle has been loaded onto the transporter correctly
- The vehicle is secured at all four wheels with suitable tensioning straps
- The maximum permissible speed of 35 mph (60 km/h) is not exceeded when transporting

**!** **NOTE** Damage to the vehicle from securing it incorrectly

- ▶ After loading, the vehicle must be secured on all four wheels. Otherwise, the vehicle could be damaged.
- ▶ A minimum distance of 8 in (20 cm) upwards and 4 in (10 cm) downwards must be kept to the transport platform.

- ▶ Secure the vehicle on all four wheels after loading.

#### 4MATIC vehicles/vehicles with automatic transmission

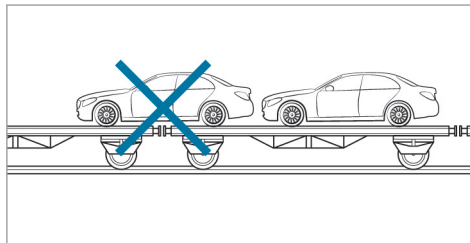

- ▶ Make sure that the front and rear axles come to rest on the same transportation vehicle.

**!** **NOTE** Damage to the drivetrain due to incorrect positioning

- ▶ Do not position the vehicle above the connection point of the transport vehicle.

#### Towing eye storage location

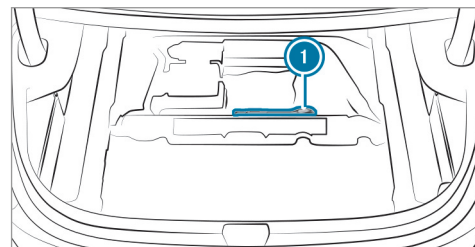

Towing eye ① is located in the stowage space under the trunk floor.

## Installing the towing eye

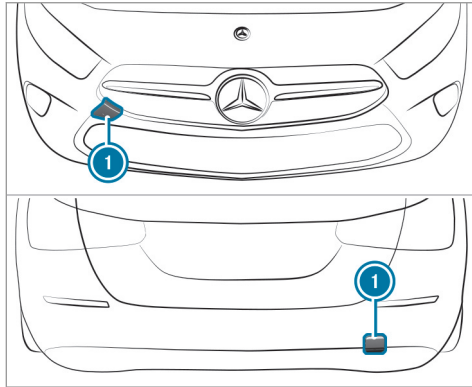

- ▶ Press the mark on cover ① inwards and remove.
- ▶ Screw in the towing eye clockwise as far as it will go and tighten.
- ① Make sure that cover ① engages in the bumper when you remove the towing eye.

**!** **NOTE** Damage due to incorrect use of the towing eye

When a towing eye is used to recover a vehicle, the vehicle may be damaged in the process.

- ▶ Only use the towing eye to tow away or tow start the vehicle.

## Tow starting the vehicle (emergency engine start)

### Vehicles with automatic transmission

**!** **NOTE** Damage to the automatic transmission due to tow starting

The automatic transmission may be damaged in the process of tow starting vehicles with automatic transmission.

- ▶ Vehicles with automatic transmission must not be tow started.

- ▶ Vehicles with automatic transmission must not be tow-started.

## Electrical fuses

### Notes on electrical fuses

**!** **WARNING** Risk of accident and injury due to overloaded lines

If you manipulate or bridge a faulty fuse or if you replace it with a fuse with a higher amperage, the electric line could be overloaded.

This could result in a fire.

- ▶ Always replace faulty fuses with specified new fuses containing the correct amperage.

**!** **NOTE** Damage due to incorrect fuses

Electrical components or systems may be damaged by incorrect fuses, or their functionality may be significantly impaired.

- ▶ Only use fuses that have been approved by Mercedes-Benz and which have the correct fuse rating.

Blown fuses must be replaced with fuses of the same rating, which you can recognize by the color and fuse rating. The fuse ratings and further information to be observed are listed in the fuse assignment diagram.

**Fuse assignment diagram:** on the fuse box in the engine compartment (→ page 414).

**!** **NOTE** Damage or malfunctions caused by moisture

Moisture may cause damage to the electrical system or cause it to malfunction.

- ▶ When the fuse box is open, make sure that no moisture can enter the fuse box.
- ▶ When closing the fuse box, make sure that the seal of the lid is positioned correctly on the fuse box.

If the newly inserted fuse also blows, have the cause traced and rectified at a qualified specialist workshop.

Ensure the following before replacing a fuse:

- The vehicle is secured against rolling away.

- All electrical consumers are switched off.
- The ignition is switched off.

The electrical fuses are located in various fuse boxes:

- Fuse box in the engine compartment on the left-hand side of the vehicle, when viewed in the direction of travel (→ page 414)
- Fuse box in the front passenger footwell (→ page 415)
- Fuse box in the center of the trunk (→ page 416)

### Opening and closing the fuse box in the engine compartment

#### Requirements:

- A dry cloth and a screwdriver are available.

Observe the notes on electrical fuses (→ page 413).

#### Opens

**!** **WARNING** Risk of injury from using the windshield wipers while the engine hood is open

When the engine hood is open and the windshield wipers are set in motion, you can be trapped by the wiper linkage.

- ▶ Always switch off the windshield wipers and ignition before opening the engine hood.

- ▶ Open the hood.

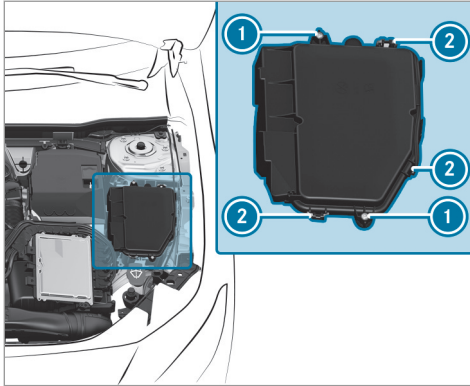

- ▶ Remove any existing moisture from the fuse box using a dry cloth.
- ▶ Loosen screws ①.
- ▶ Press clamps ② and lift the fuse box lid up and out.

The fuse allocation chart is in a recess on the side of the fuse box.

### Closing

- ▶ Check whether the seal is positioned correctly in the lid.
- ▶ Place the lid on the fuse box.
- ▶ Make sure that clamps ② engage.
- ▶ Tighten screws ①.
- ▶ Close the hood.

### Opening and closing the fuse box in the front passenger footwell

Observe the notes on electrical fuses (→ page 413).

### Opening

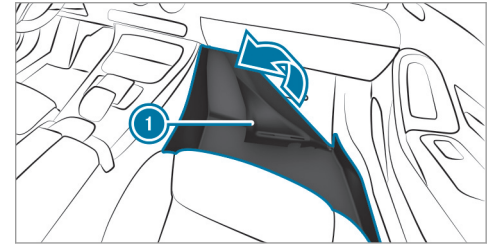

- ▶ Lift carpet ① in the direction of the arrow.

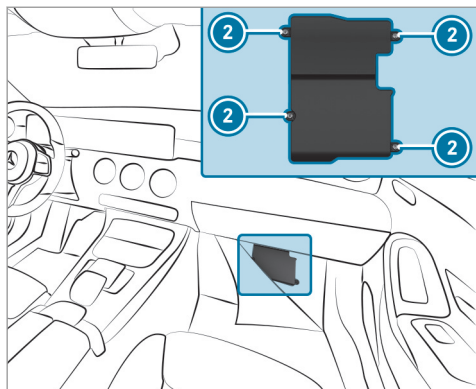

- ▶ Loosen screws ②, remove fuse box lid from the top.

### Opening and closing the fuse box in the trunk

Observe the notes on electrical fuses (→ page 413).

- ▶ Open the trunk floor (→ page 103).

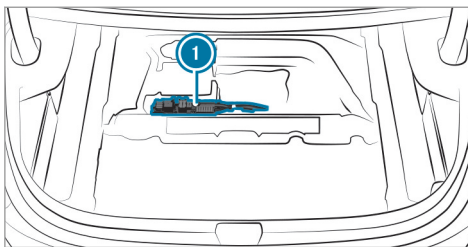

Fuse box ① is located in the center underneath the trunk floor.



### Notes on noise or unusual handling characteristics

While driving, pay attention to vibrations, noises and unusual handling characteristics, e.g. pulling to one side. This may indicate that the wheels or tires are damaged. If you suspect that a tire is defective, reduce your speed immediately. Stop the vehicle as soon as possible to check the wheels and tires for damage. Hidden tire damage could also be causing the unusual handling characteristics. If you find no signs of damage, have the tires and wheels checked at a qualified specialist workshop.

### Notes on regularly inspecting wheels and tires

**⚠ WARNING** Risk of accident from damaged tires

Damaged tires can cause tire pressure loss. As a result, you could lose control of your vehicle.

▶ Check the tires regularly for signs of damage and replace any damaged tires immediately.

**⚠ WARNING** Risk of aquaplaning due to insufficient tire tread

Insufficient tire tread will result in reduced tire grip. The tire tread is no longer able to dissipate water.

This means that in heavy rain or slush the risk of hydroplaning is increased, in particular if vehicle speed is not adapted to suit the conditions.

If the tire pressure is too high or too low, tires may exhibit different levels of wear at different locations on the tire contact surface.

▶ Thus, you should regularly check the tread depth and the condition of the tire contact surface across the entire width of all tires.

Minimum tread depth for:

- Summer tires:  $\frac{1}{8}$  in (3 mm)
- M+S tires:  $\frac{1}{8}$  in (4 mm)

▶ For safety reasons, replace the tires before the legally prescribed limit for the minimum tread depth is reached.

Carry out the following checks on all wheels regularly, at least once a month or as required, e.g. prior to a long journey or driving off-road:

- Check the tire pressure (→ page 419).
- Visually inspect tires and wheels for damage.
- Check the valve caps.

The valves must be protected against moisture and dirt by the valve caps approved especially for your vehicle by Mercedes-Benz.

- Visual check of the tire tread depth and the tire contact surface across the entire width. The minimum tread depth for summer tires is  $\frac{1}{8}$  in (3 mm) and for winter tires  $\frac{1}{8}$  in (4 mm).

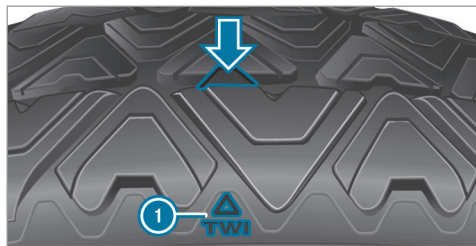

Six marks ① show where the bar indicators (arrow) are integrated into the tire tread. They are visible once a tread depth of approximately  $\frac{1}{16}$  in (1.6 mm) has been reached.

#### Notes on snow chains

**⚠ WARNING** Risk of accident due to incorrect snow chain fitting

If you fit snow chains to the rear wheels, the snow chains may grind against the vehicle body or chassis components.

This could cause damage to the vehicle or the tires.

- ▶ Never fit snow chains to the rear wheels.
- ▶ Always fit snow chains to the front wheels in pairs.

**!** **NOTE** Damage to components of the vehicle body or chassis due to fitted snow chains

If you fit snow chains to the front wheels of 4MATIC vehicles, you may damage components of the vehicle body or chassis.

- ▶ Only fit snow chains to the rear wheels of 4MATIC vehicles.

**!** **NOTE** Damage to the wheel trim from mounted snow chains

If snow chains are mounted to steel wheels, the wheel trims can be damaged.

- ▶ Remove the wheel trims of steel wheels before mounting snow chains.

Observe the following notes when using snow chains:

- Snow chains are only permissible for certain wheel/tire combinations. You can obtain information about this from an authorized Mercedes-Benz Center.
  - For safety reasons, only use snow chains that have been specifically approved for your vehicle by Mercedes-Benz, or snow chains with the same quality standard.
  - If snow chains are installed, the maximum permissible speed is 30 mph (50 km/h).
  - **Vehicles with Active Parking Assist:** Do not use Active Parking Assist when snow chains are installed.
- ① You can deactivate ESP® to pull away (→ page 161). This allows the wheels to spin, achieving an increased driving force.

## Tire pressure

### Notes on tire pressure

**⚠ WARNING** Risk of accident due to insufficient or excessive tire pressure

Underinflated or overinflated tires pose the following risks:

- The tires may burst, especially as the load and vehicle speed increase.
  - The tires may wear excessively and/or unevenly, which may greatly impair tire traction.
  - The driving characteristics, as well as steering and braking, may be greatly impaired.
- ▶ Comply with the recommended tire pressure and check the tire pressure of all tires including the spare wheel regularly:
- at least once a month
  - when the load changes

- before embarking on a longer journey
  - if operating conditions change, e.g. off-road driving
- ▶ Adjust the tire pressure as necessary.

Tire pressure which is too high or too low can:

- Shorten the service life of the tires.
- Cause increased tire damage.
- Adversely affect driving characteristics and thus driving safety, e.g. due to hydroplaning.

**⚠ WARNING** Risk of an accident due to insufficient tire pressure

Tires with pressure that is too low can overheat and burst as a result.

In addition, they also suffer from excessive and/or irregular wear, which can significantly impair the braking properties and the handling characteristics.

- ▶ Avoid excessively low tire pressures in all the tires, including the spare wheel.

Tire pressure which is too low can cause:

- Tire defects as a result of overheating.
- Impaired handling characteristics.
- Irregular wear.
- Increased fuel consumption.

**⚠ WARNING** Risk of accident from excessive tire pressure

Tires with excessively high pressure can burst because they are damaged more easily by highway fill, pot holes etc.

In addition, they also suffer from irregular wear, which can significantly impair the braking properties and the handling characteristics.

- ▶ Avoid excessively high tire pressures in all the tires, including the spare wheel.

Tire pressure which is too high can cause:

- Increased braking distance.
- Impaired handling characteristics.
- Irregular wear.

- Impaired driving comfort.
- Susceptibility to damage.

**⚠ WARNING** Risk of accident caused by repeated drop in tire pressure

If the tire pressure drops repeatedly, the wheel, valve or tire may be damaged.

Insufficient tire pressure can cause the tires to burst.

- ▶ Inspect the tire for signs of foreign objects.
- ▶ Check whether the wheel or valve has a leak.
- ▶ If you are unable to rectify the damage, contact a qualified specialist workshop.

You can find information on tire pressure for the vehicle's factory-installed tires on the following labels:

- Tire and Loading Information placard on the B-pillar of your vehicle (→ page 426).
- Tire pressure table on the inside of the fuel filler flap (→ page 420).

Observe the maximum tire pressure (→ page 432).

Use a suitable pressure gauge to check the tire pressure. The outer appearance of a tire does not permit any reliable conclusion about the tire pressure.

**Vehicles with a tire pressure monitoring system:** You can also check the tire pressure using the on-board computer.

Only correct tire pressure when the tires are cold. Conditions for cold tires:

- The vehicle has been parked with the tires out of direct sunlight for at least three hours.
- The vehicle has traveled less than 1 mile (1.6 km).

A rise in the tire temperature of 18 °F (10 °C) increases the tire pressure by approx. 10 kPa (0.1 bar/1.5 psi). Take this into account when checking the tire pressure of warm tires.

The tire pressure recommended for increased load/speed in the tire pressure table can affect the ride comfort.

**⚠ WARNING** Risk of accident due to unsuitable accessories on tire valve

If you mount unsuitable accessories onto tire valves, the tire valves may be overloaded and malfunction, which can cause a loss of tire pressure. Aftermarket tire pressure monitoring systems will cause the tire valve to remain open, depending on the design. This can also result in a loss of tire pressure.

- ▶ Only screw standard valve caps or valve caps specifically approved by Mercedes-Benz for your vehicle onto the tire valve.

### Tire pressure table

The tire pressure table is on the inside of the fuel filler flap.

- ⓘ The data shown in the images is example data.

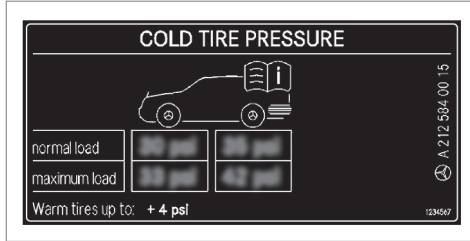

The tire pressure table shows the recommended tire pressure for all tires approved for this vehicle. The recommended tire pressures apply for cold tires under various operating conditions, i.e. loading and/or speed of the vehicle.

If one or more tire sizes precede a tire pressure, the tire pressure information following is only valid for those tire sizes.

The load conditions "partially laden" and "fully laden" are defined in the table for different numbers of passengers and amounts of luggage. The actual number of seats may differ from this.

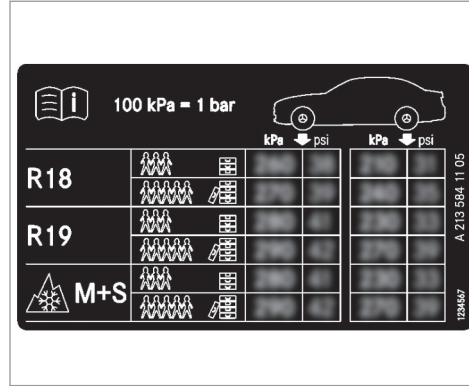

Some tire pressure tables only show the rim diameter instead of the complete tire size, e.g. **R18**. The rim diameter is part of the tire size and can be found on the tire side wall (→ page 433).

Be sure to also observe the following further related subjects:

- Notes on tire pressure (→ page 419)
- Tire and Loading Information placard (→ page 426)

- Maximum tire pressure (→ page 432)

### Checking tire pressures manually

- ▶ Read the tire pressure for the current operating conditions from the Tire and Loading Information placard or the tire pressure table. Observe the notes on tire pressure.
- ▶ Remove the valve cap of the tire to be checked.
- ▶ Press the tire pressure gauge securely onto the valve.
- ▶ Read the tire pressure.
- ▶ If the tire pressure is lower than the recommended value, increase the tire pressure to the recommended value.
- ▶ If the tire pressure is higher than the recommended value, release air. To do so, press down the metal pin in the valve, e.g. using the tip of a pen for example. Then check the tire pressure again using the tire pressure gauge.
- ▶ Screw the valve cap onto the valve.

Further related subjects:

- Notes on tire pressure (→ page 419)
- Tire pressure table (→ page 420)
- Tire and Loading Information placard (→ page 426)

### Tire pressure monitoring system

#### Function of the tire pressure monitoring system

**▲ DANGER** Risk of accident due to incorrect tire pressure

Every tire, including the spare (if provided), should be checked when cold at least once a month and inflated to the pressure recommended by the vehicle manufacturer (see Tire and Loading Information placard on the B-pillar on the driver's side or the tire pressure label on the inside of the fuel filler flap of your vehicle). If your vehicle has tires of a different size than the size indicated on the Tire and Loading Information placard or the

tire pressure table, you need to determine the proper tire pressure for those tires.

As an added safety feature, your vehicle has been equipped with a tire pressure monitoring system (TPMS) that illuminates a low tire pressure indicator lamp when one or more of your tires are significantly underinflated.

Accordingly, if the low tire pressure indicator lamp lights up, you should stop and check your tires as soon as possible, and inflate them to the proper pressure. Driving on a significantly underinflated tire causes the tire to overheat and can lead to tire failure.

Underinflation also increases fuel consumption and reduces tire tread life, and may affect the vehicle's handling and braking ability. Please note that the TPMS is not a substitute for proper tire maintenance, and it is the driver's responsibility to maintain correct tire pressure, even if underinflation has not reached the level to trigger illumination of the TPMS low tire pressure indicator lamp.

Your vehicle has also been equipped with a TPMS malfunction indicator to indicate when

the system is not operating properly. The TPMS malfunction indicator is combined with the low tire pressure indicator lamp. When the system detects a malfunction, the indicator lamp will flash for approximately a minute and then remain continuously illuminated. This sequence will continue upon subsequent vehicle start-ups as long as the malfunction exists.

When the malfunction indicator is illuminated, the system may not be able to detect or signal low tire pressure as intended. TPMS malfunctions may occur for a variety of reasons, including the installation of incompatible replacement or alternate tires or wheels on the vehicle that prevent the TPMS from functioning properly.

Always check the TPMS malfunction warning lamp after replacing one or more tires or wheels on your vehicle to ensure that the replacement or alternate tires and wheels allow the TPMS to continue to function properly.

The system checks the tire pressure and the tire temperature of the tires installed on the vehicle by means of a tire pressure sensor.

New tire pressure sensor, e.g. in winter tires, are automatically taught-in during the first journey they are used.

The tire pressure and the tire temperature appear in the multifunction display (→ page 423).

If there is a substantial pressure loss or if the tire temperature is excessive, you will be warned in the following ways:

- via display messages (→ page 491)
- via the  warning lamp in the instrument cluster (→ page 515)

The tire pressure monitoring system is only an aid. It is the driver's responsibility to set the tire pressure to the recommended cold tire pressure suitable for the operating situation. Set the tire pressure for cold tires using a tire pressure gauge. Note that the correct tire pressure for the

current operating situation must first be taught-in to the tire pressure monitoring system.

In most cases, the tire pressure monitoring system will automatically update the new reference values after you have changed the tire pressure. You can, however, also update the reference values by restarting the tire pressure monitoring system manually (→ page 424).

#### System limits

The system may be impaired or may not function in the following situations:

- The tire pressure has been set incorrectly.
- There is a sudden pressure loss caused, for example, by a foreign object penetrating the tire.
- There is a malfunction caused by another radio signal source.

Make sure to observe the following further related subject:

- Notes on tire pressure (→ page 419)

### Checking the tire pressure with the tire pressure monitoring system

#### Requirements:

- The ignition is switched on.

On-board computer:

 [Service](#)  [Tires](#)

One of the following displays appears:

- Current tire pressure and tire temperature of the individual wheels:

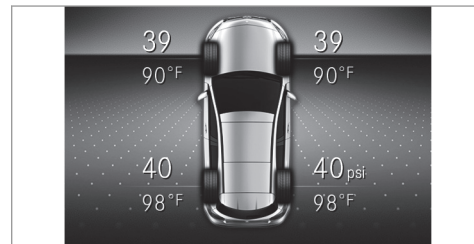

- [Tire pressure will be displayed after driving a few minutes](#)

- **Tire Pressure Monitor Active:** the teach-in process of the system is not yet complete. The tire pressures are already being monitored.
- ▶ Compare the tire pressure with the recommended tire pressure for the current operating condition (→ page 420). Observe the notes on tire temperature (→ page 419).
- ⓘ The values displayed in the multifunction display may deviate from those of the tire pressure gauge as they refer to sea level. At high altitudes, the tire pressure values indicated by a pressure gauge are higher than those shown by the on-board computer. In this case, do not reduce the tire pressure.

Make sure to observe the following further related subject:

- Notes on tire pressure (→ page 419)

### Restarting the tire pressure monitoring system

#### Requirements:

- The recommended tire pressure is correctly set for the respective operating status on each of the four wheels (→ page 419).

Restart the tire pressure monitoring system in the following situations:

- The tire pressure has changed.
- The wheels or tires have been changed or newly installed.

On-board computer:

↳ Service ▶ Tires

- ▶ Swipe downwards on the Touch Control on the left-hand side of the steering wheel. The **Use Current Pressures as New Reference Values** message is shown in the multifunction display.
- ▶ To begin restart, press the Touch Control on the left-hand side of the steering wheel. The **Tire Press. Monitor Restarted** message is shown in the multifunction display.

Current warning messages are deleted and the yellow  warning lamp goes out.

After you have been driving for a few minutes, the system checks whether the current tire pressures are within the specified range. The current tire pressures are then accepted as reference values and monitored.

Make sure to observe the following further related subject:

- Notes on tire pressure (→ page 419)

### Radio equipment approval of the tire pressure monitoring system

#### Radio equipment approval numbers

Country	Radio equipment approval number
Canada	IC: 4008C-TSSRE4A
USA	FCC ID: YGOTSSRE4A

Further information on the declaration of conformity for wireless vehicle components (→ page 25).



## Tire pressure loss warning system

### Function of the tire pressure loss warning system

The tire pressure loss warning system warns the driver by means of display messages when there is a severe tire pressure loss.

After a change in tire pressure, a wheel rotation or a tire change, or if you have re-installed wheels or tires, the tire pressure loss warning system has to be restarted (→ page 425).

The tire pressure loss warning system does not replace the need to regularly check the tire pressure.

### System limitations

The system may be impaired or may not function particularly in the following situations:

- Incorrectly set tire pressure
- Sudden pressure loss caused, for example, by a foreign object penetrating the tire
- Steady pressure loss in several tires

The system has a restricted or delayed function particularly in the following situations:

- Poor ground conditions, e.g. snow or gravel
- Driving with snow chains
- When adopting a very sporty driving style with high cornering speeds or sudden acceleration
- Driving with a high load

Be sure to also observe the following further related subjects:

- Notes on tire pressure (→ page 419)
- Display messages about the tires (→ page 491)

### Restarting the tire pressure loss warning system

#### Requirements:

- The recommended tire pressure is correctly set for the respective operating status on each of the four wheels (→ page 419).

Restart the tire pressure loss warning system in the following situations:

- The tire pressure has changed.
- The wheels or tires have been changed or newly installed.

On-board computer:

↪ [Service](#) ▶ [Tires](#)

▶ Swipe downwards on the Touch Control on the left-hand side of the steering wheel. The [Tire Pressure Control System ActiveRestart](#) message is shown in the multifunction display.

Restart the tire pressure loss warning system in the following situations:

- The tire pressure has changed.
- The wheels or tires have been changed or newly installed.

▶ To begin the restart, press the Touch Control on the left-hand side of the steering wheel. The [Tire Pressure Now OK?](#) message is shown in the multifunction display.

- ▶ Select **Yes**.
  - ▶ To confirm the restart, press the Touch Control on the left-hand side of the steering wheel.
- The **Run Flat Indicator Restarted** message is shown in the multifunction display.
- After you have driven for a few minutes, the tire pressure loss warning system monitors the set tire pressures of all the tires.

Be sure to also observe the following further related subjects:

- Notes on tire pressure (→ page 419)

### Loading the vehicle

#### Notes on Tire and Loading Information placard

**⚠ WARNING** Risk of accident from overloaded tires

Overloaded tires may overheat and burst as a consequence. Overloaded tires can also impair the steering and handling characteristics and lead to brake failure.

- ▶ Observe the load-bearing capacity of the tires.
- ▶ The load-bearing capacity must be at least half the gross axle weight rating of the vehicle.
- ▶ Never overload the tires by exceeding the maximum load.

The Tire and Loading Information placard is on the B-pillar on the driver's side of the vehicle.

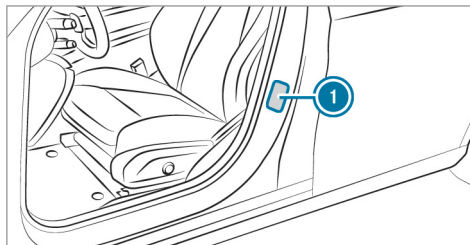

① Tire and Loading Information placard

TIRE AND LOADING INFORMATION		RENSEIGNEMENTS SUR LES PNEUS ET LE CHARGEMENT	
SEATING CAPACITY NOMBRE DE PLACES	TOTAL 7	FRONT AVANT	2
MILE MI	3	REAR ARRIÈRE	2
The combined weight of occupants and cargo should never exceed XXX kg or XXX lbs. Le poids total des occupants et du chargement ne doit jamais dépasser			
TIRE PNEU	SIZE DIMENSIONS	COLD TIRE PRESSURE PRESSION DES PNEUS À FROID	SEE OWNER'S MANUAL FOR ADDITIONAL INFORMATION
FRONT AVANT	255/40 ZR18 99Y XL	200 KPA, 29 PSI	VOIR LE MANUEL DE L'USAGER POUR PLUS DE RENSEIGNEMENTS
REAR ARRIÈRE	285/35 ZR18 101Y XL	200 KPA, 29 PSI	
SPARE DE SECOURS	175/55-18 95P	420 KPA, 60 PSI	

① The data shown in the illustration is example data.

The Tire and Loading Information placard shows:

- Maximum number of seats ② according to the maximum number of people permitted to travel in the vehicle.
- Maximum permissible load ③ comprises the gross weight of all vehicle occupants, load and luggage.

- Recommended tire pressures  for cold tires. The recommended tire pressures are valid for the maximum permissible load and up to the maximum permissible vehicle speed.

Please also note:

- Information on permissible weights and loads on the vehicle identification plate (→ page 449).
- Information on tire pressure in the tire pressure table (→ page 420).

Further related subjects:

- Determining the maximum permissible load (→ page 427)
- Notes on tire pressure (→ page 419).

### Determining the maximum permissible load

The following steps have been developed as required of all manufacturers under Title 49, Code of U.S. Federal Regulations, Part 575, pursuant to the "National Traffic and Motor Vehicle Safety Act of 1966".

- ▶ **Step 1:** locate the statement "The combined weight of occupants and load should never exceed XXX kg or XXX lbs." ("The combined weight of occupants and load should never exceed XXX kg or XXX lbs.") on your vehicle's Tire and Loading Information placard.
- ▶ **Step 2:** determine the combined weight of the driver and passengers that will be traveling in your vehicle.
- ▶ **Step 3:** subtract the combined weight of the driver and passengers from XXX kg or XXX lbs.
- ▶ **Step 4:** the resulting figure equals the permissible cargo and luggage load capacity. For example: If "XXX" equals 1400 lbs and there are five occupants in your vehicle with a weight of 150 lbs each, the maximum cargo and luggage load capacity is 650 lbs (1400 - 750 (5 x 150) = 650 lbs).
- ▶ **Step 5:** determine the combined weight of luggage and load that the vehicle will be carrying. For safety reasons, this weight may not safely exceed the available cargo and luggage load capacity calculated in step 4.

Even if you have calculated the total load carefully, you should still make sure that the maximum permissible gross mass and the maximum permissible axle load of your vehicle are not exceeded. Details can be found on the vehicle identification plate.

- ▶ Have your loaded vehicle – including driver, occupants and load – weighed on a vehicle weighbridge. The measured values may not exceed the maximum permissible values stated on the vehicle identification plate.

Further related subjects:

- Calculation example for determining the maximum load (→ page 428)
- Tire and Loading Information placard (→ page 426)
- Tire pressure table (→ page 420)
- Vehicle identification plate

### Calculation example for determining the maximum load

The following table shows examples of how to calculate total and load capacities with varying

seating configurations and different numbers and sizes of occupants. The following examples use a maximum load of 1500 lbs (680 kg). **This is for illustration purposes only.** Make sure you are using the actual load limit for your vehi-

cle stated on your vehicle's Tire and Loading Information placard (→ page 426).

The higher the weight of all the occupants, the smaller the maximum load for luggage.

#### Step 1

	Example 1	Example 2
Combined maximum weight of occupants and load (data from the Tire and Loading Information placard)	1500 lbs (680 kg)	1500 lbs (680 kg)

#### Step 2

	Example 1	Example 2
Number of people in the vehicle (driver and occupants)	5	1
Distribution of the occupants	Front: 2 Rear: 3	Front: 1

	Example 1	Example 2
Weight of occupants	Occupant 1: 150 lbs (68 kg) Occupant 2: 180 lbs (82 kg) Occupant 3: 160 lbs (73 kg) Occupant 4: 140 lbs (63 kg) Occupant 5: 120 lbs (54 kg)	Occupant 1: 200 lbs (91 kg)
Total weight of all occupants	750 lbs (340 kg)	200 lbs (91 kg)

**Step 3**

	Example 1	Example 2
Permissible load (maximum gross vehicle weight rating from the Tire and Loading Information placard minus the gross weight of all occupants)	1500 lbs (680 kg) - 750 lbs (340 kg) = 750 lbs (340 kg)	1500 lbs (680 kg) - 200 lbs (91 kg) = 1300 lbs (589 kg)

## Tire labeling

### Overview of tire labeling

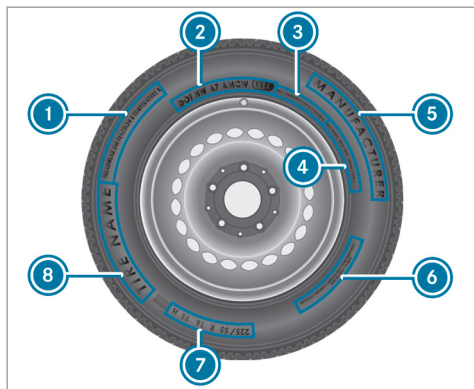

- ① Uniform Tire Quality Grading Standard (→ page 430)
- ② DOT, Tire Identification Number (→ page 431)
- ③ Maximum tire load (→ page 432)
- ④ Maximum tire pressure (→ page 432)

- ⑤ Manufacturer
- ⑥ Characteristics of the tire (→ page 433)
- ⑦ Tire size designation, load-bearing capacity, speed rating and load index (→ page 433)
- ⑧ Tire name
- ⓘ The data shown in the image is example data.

### Tire Quality Grading

In accordance with the US Department of Transportation's "Uniform Tire Quality Grading Standards", tire manufacturers are required to grade their tires on the basis of the following three performance factors:

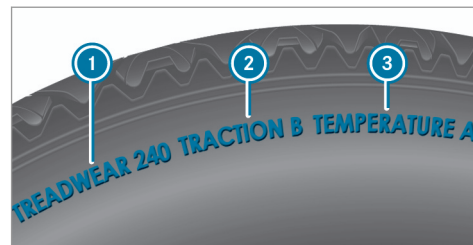

- ① Tread wear grade
- ② Traction grade
- ③ Temperature grade
- ⓘ The data shown in the image is example data.
- ⓘ The classification is not legally stipulated for Canada, but it is generally stated.

### Tread wear grade

The tread wear grade is a comparative rating based on the wear rate of the tire when tested under controlled conditions on a specified test track of the US Department of Transportation. For example, a tire graded 150 would wear one

and one-half times as well on the government test track as a tire graded 100.

The relative performance of tires depends upon the actual conditions of their use, however, and may depart significantly from the norm due to variations in driving habits, service practices and differences in road characteristics and climate conditions.

### Traction grade

**⚠ DANGER** Risk of accident due to inadequate traction

The traction grade assigned to this tire is based on straight-ahead braking traction tests, and does not include either acceleration, cornering, hydroplaning or peak traction characteristics.

- ▶ Always adapt your driving style and drive at a speed to suit the prevailing traffic and weather conditions.

**⚠ NOTE** Damage to the drivetrain from wheelspin

- ▶ Avoid wheelspin.

The traction grades – from highest to lowest – are AA, A, B and C. Those grades represent the tire's ability to stop on wet pavement as measured under controlled conditions on specified government test surfaces made of asphalt and concrete.

### Temperature grade

**⚠ WARNING** Risk of accident from tire overheating and tire failure

The temperature grade for this tire is established for a tire that is properly inflated and not overloaded. Excessive speed, underinflation, or excessive loading, either separately or in combination, can cause excessive heat build-up and possible tire failure.

- ▶ Observe the recommended tire pressures and regularly check the tire pres-

sure of all tires including the spare wheel.

- ▶ Adjust the tire pressure as necessary.

The temperature grades are A (the highest), B and C. They represent the tire's resistance to the generation of heat and its ability to dissipate heat when tested under controlled conditions on a specified indoor laboratory test wheel. Sustained high temperature can cause the material of the tire to degenerate and reduce tire life, and excessive temperature can lead to sudden tire failure. Grade C corresponds to a level of performance which all passenger car tires must meet under the requirements of the US Department of Transportation.

### DOT, Tire Identification Number (TIN)

US tire regulations stipulate that every tire manufacturer or retreader must imprint a TIN in or on the side wall of each tire produced.

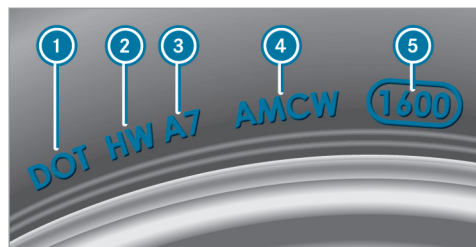

**i** The data shown in the image is example data.

The TIN is a unique identification number to identify tires and comprises the following:

- **DOT (Department of Transportation):** tire symbol marks **1** indicating that the tire complies with the requirements of the US Department of Transportation.
- **Manufacturer identification code:** manufacturer identification code **2** contains details of the tire manufacturer. New tires have a code with two symbols. Retreaded tires have a code with four symbols. Further information on retreaded tires (→ page 438).

- **Tire size:** identifier **3** describes the tire size.
- **Tire type code:** tire type code **4** can be used by the manufacturer as a code to describe specific characteristics of the tire.
- **Manufacturing date:** manufacturing date **5** provides information about the age of a tire. The 1st and 2nd positions represent the calendar week and the 3rd and 4th positions state the year of manufacture (e.g. "3208" represents the 32nd week of 2008).

#### Information on the maximum tire load

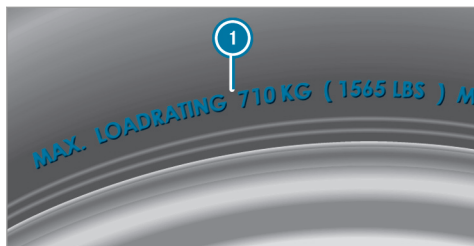

**i** The data shown in the image is example data.

Maximum tire load **1** is the maximum permissible weight for which the tire is approved.

Do not overload the tires by exceeding the specified load limit. The maximum permissible load can be found on the vehicle's Tire and Loading Information placard on the B-pillar on the driver's side (→ page 426).

#### Specifications for maximum tire pressure



**i** The data shown in the image is example data.



Never exceed maximum tire pressure ❶ specified for the tire.

### Information on tire characteristics



❶ The data shown in the image is example data.

This information describes the type of tire cord and the number of layers in side wall ❶ and under tire tread ❷.

### Tire size designation, load-bearing capacity, speed rating and load index

**⚠ WARNING** Risk of injury through exceeding the specified tire load rating or the permissible speed rating

Exceeding the specified tire load rating or the permissible speed rating may lead to tire damage and to the tires bursting.

- ▶ Therefore, only use tire types and sizes approved for your vehicle model.
- ▶ Observe the tire load rating and speed rating required for your vehicle.

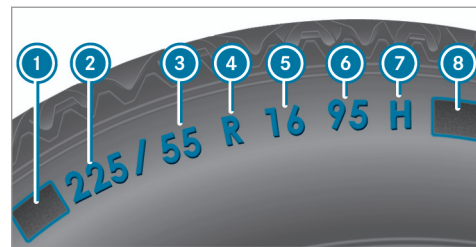

- ❶ Preceding letter
- ❷ Nominal tire width in millimeters
- ❸ Aspect ratio in %
- ❹ Tire code
- ❺ Rim diameter
- ❻ Load-bearing index
- ❼ Speed rating
- ❽ Load index

❶ The data shown in the image is example data.

Information about reading tire data can be obtained from any qualified specialist workshop.

**Preceding letter 1:**

- Without: passenger vehicle tires according to European manufacturing standards.
- "P": passenger vehicle tires according to US manufacturing standards.
- "LT": light truck tires according to US manufacturing standards.
- "T": compact emergency spare wheels with high tire pressure that are only designed for temporary use in an emergency.

**Aspect ratio 3:**

Ratio between tire height and tire width in percent (tire height divided by tire width).

**Tire code 4 (tire type):**

- "R" radial tire
- "D": bias ply tire
- "B": bias belted tires
- "ZR": radial tire with a maximum speed above 149 mph (240 km/h) (optional)

**Rim diameter 5:**

The diameter of the bead seat (not the diameter of the rim flange). The rim diameter is specified in inches (in).

**Load-bearing index 6:**

Numerical code that specifies the maximum load-bearing capacity of a tire (e.g. "91" corresponds to 1356 lbs (615 kg)).

The load-bearing capacity of the tire must be at least half the permissible axle load of your vehicle. Do not overload the tires by exceeding the specified load limit.

See also:

- Maximum permissible load on the Tire and Loading Information placard (→ page 426)
- Maximum tire load (→ page 432)
- Load index

**Speed rating 7:**

Specifies the approved maximum speed of the tire.

**i** An electronic speed limiter prevents your vehicle from exceeding a speed of 130 mph (210 km/h).

Make sure that your tires have the required speed rating. You can obtain information on the required speed rating from an authorized Mercedes-Benz Center.

**Summer tires**

Index	Speed rating
Q	up to 100 mph (160 km/h)
R	up to 106 mph (170 km/h)
S	up to 112 mph (180 km/h)
T	up to 118 mph (190 km/h)
H	up to 130 mph (210 km/h)
V	up to 149 mph (240 km/h)
W	up to 168 mph (270 km/h)
Y	up to 186 mph (300 km/h)

Index	Speed rating
ZR...Y <sup>1</sup>	up to 186 mph (300 km/h)
ZR...(..Y) <sup>1</sup>	over 186 mph (300 km/h)
ZR <sup>1</sup>	over 149 mph (240 km/h)

- Specifying the speed rating as the "ZR" index in tire code ④ is optional for tires up to 186 mph (300 km/h).
- If your tire code ④ includes "ZR" and there is no speed rating ⑦, find out what the maximum speed is from the tire manufacturer.
- If load-bearing index ⑥ and speed rating ⑦ are in brackets, the maximum speed rating of your tire is above 186 mph (300 km/h). To find out the maximum speed, ask the tire manufacturer.

<sup>1</sup> "ZR" stated in the tire code.

<sup>2</sup> Or "M+S"  " for winter tires

### All-weather tires and winter tires

Index	Speed rating
Q M+S <sup>2</sup>	up to 100 mph (160 km/h)
T M+S <sup>2</sup>	up to 118 mph (190 km/h)
H M+S <sup>2</sup>	up to 130 mph (210 km/h)
V M+S <sup>2</sup>	up to 149 mph (240 km/h)

Winter tires bear the  snowflake symbol and fulfill the requirements of the Rubber Manufacturers Association (RMA) and the Rubber Association of Canada (RAC) regarding the tire traction on snow.

### Load index ⑧:

- No specification given: standard load (SL) tire
- "XL" or "Extra Load": extra load tire or reinforced tire
- "Light Load": light load tire

- "C", "D", "E": a load range that depends on the maximum load that the tire can carry at a certain pressure

### Definition of terms for tires and loading

**Tire structure and characteristics:** describes the number of layers or the number of rubber-coated belts in the tire contact surface and the tire wall. These are made of steel, nylon, polyester and other materials.

**Bar:** metric unit for tire pressure. 14.5038 pounds per square inch (psi) and 100 kilopascal (kPa) is the equivalent of one bar.

**DOT (Department of Transportation):** DOT-marked tires fulfill the requirements of the US Department of Transportation.

**Average weight of the vehicle occupants:** the number of vehicle occupants for which the vehicle is designed, multiplied by 150 lb (68 kg).

**Uniform Tire Quality Grading Standards:** a uniform standard to grade the quality of tires with regard to tread quality, tire traction and temperature characteristics. The quality grading assessment is made by the manufacturer following specifications from the U.S. government. The quality grade of a tire is imprinted on the side wall of the tire.

**Recommended tire pressure:** the recommended tire pressure is the tire pressure specified for the tires mounted to the vehicle at the factory.

The tire and information table contains the recommended tire pressures for cold tires, the maximum permissible load and the maximum permissible vehicle speed.

The tire pressure table contains the recommended tire pressures for cold tires under various operating conditions, i.e. loading and/or speed of the vehicle.

**Increased vehicle weight due to optional equipment:** the combined weight of all standard and optional equipment available for the vehicle,

regardless of whether it is actually installed on the vehicle or not.

**Rim:** the part of the wheel on which the tire is installed.

**GAWR (Gross Axle Weight Rating):** the GAWR is the maximum permissible axle load. The actual load on an axle must never exceed the gross axle weight rating. The gross axle weight rating can be found on the vehicle identification plate on the B-pillar on the driver's side.

**Speed rating:** the speed rating is part of the tire identification. It specifies the speed range for which a tire is approved.

**GVW (Gross Vehicle Weight):** the gross vehicle weight comprises the weight of the vehicle including fuel, tools, the spare wheel, accessories installed, occupants, luggage and the trailer drawbar noseweight, if applicable. The gross vehicle weight must not exceed the gross vehicle weight rating GVWR as specified on the vehicle identification plate on the B-pillar on the driver's side.

**GVWR (Gross Vehicle Weight Rating):** the GVWR is the maximum permitted gross weight

of the fully laden vehicle (weight of the vehicle including all accessories, occupants, fuel, luggage and the trailer drawbar noseweight if applicable). The gross vehicle weight rating is specified on the vehicle identification plate on the B-pillar on the driver's side.

**Maximum weight of the laden vehicle:** the maximum weight is the sum of the curb weight of the vehicle, the weight of the accessories, the maximum load and the weight of optional equipment installed at the factory.

**Kilopascal (kPa):** metric unit for tire pressure. 6.9 kPa corresponds to 1 psi. Another unit for tire pressure is bar. 100 kilopascal (kPa) equals 1 bar.

**Load index:** in addition to the load-bearing index, the load index may also be imprinted on the side wall of the tire. This specifies the load-bearing capacity of the tire more precisely.

**Curb weight:** the weight of a vehicle with standard equipment including the maximum capacity of fuel, oil and coolant. It also includes the air conditioning system and optional equipment if

these are installed on the vehicle, but does not include passengers or luggage.

**Maximum tire load:** the maximum tire load is the maximum permissible weight in kilograms or lbs for which a tire is approved.

**Maximum permissible tire pressure:** maximum permissible tire pressure for one tire.

**Maximum load on one tire:** maximum load on one tire. This is calculated by dividing the maximum axle load of one axle by two.

**PSI (pounds per square inch):** standard unit of measurement for tire pressure.

**Aspect ratio:** ratio between tire height and tire width in percent.

**Tire pressure:** pressure inside the tire applying an outward force to every square inch of the tire. The tire pressure is specified in pounds per square inch (psi), in kilopascals (kPa) or in bar. The tire pressure should only be corrected when the tires are cold.

**Cold tire pressure:** the tires are cold when the vehicle has been parked for at least 3 hours

without direct sunlight on the tires or the vehicle has been driven for less than 1 mile (1.6 km).

**Tire contact surface:** the part of the tire that comes into contact with the road.

**Tire bead:** the purpose of the tire bead is to ensure that the tire sits securely on the wheel rim. There are several wire cores in the tire bead to prevent the tire from changing length on the wheel rim.

**Side wall:** the part of the tire between the tread and the tire bead.

**Weight of optional equipment:** the combined weight of the optional equipment weighing more than the replaced standard parts and more than 5 lbs (2.3 kg). This optional equipment, such as high-performance brakes, level control system, a roof luggage rack or high-performance batteries, is not included in the curb weight and the weight of the accessories.

**TIN (Tire Identification Number):** a unique identification number which can be used by a tire manufacturer to identify tires, for example, in a product recall, and thus identify the purchasers. The TIN is made up of the manufactur-

er's identity code, tire size, tire type code and the manufacturing date.

**Load-bearing index:** the load-bearing index is a code that contains the maximum load-bearing capacity of a tire.

**Traction:** traction is the grip resulting from friction between the tires and the road surface.

**Wear indicator:** narrow bars (tread wear bars) that are distributed over the tire contact surface. If the tire tread is level with the bars, the wear limit of 1/16 in (1.6 mm) has been reached.

**Distribution of vehicle occupants:** distribution of vehicle occupants over designated seat positions in a vehicle.

**Maximum permissible payload weight:** nominal load and luggage load plus 150 lb (68 kg) multiplied by the number of seats in the vehicle.

## Changing a wheel

### Notes on selecting, installing and replacing tires

**Mercedes-AMG vehicles:** observe the notes in the Supplement. Otherwise, you may fail to recognize dangers.

You can ask for information regarding permitted wheel/tire combinations at an authorized Mercedes-Benz Center.

**⚠ WARNING** Risk of accident due to incorrect dimensions of wheels and tires

If wheels and tires of the wrong size are installed, the wheel brakes or wheel suspension components may be damaged.

- ▶ Always replace wheels and tires with those that fulfill the specifications of the original part.

When replacing wheels, make sure to fit the correct:

- Designation

- Model

When replacing tires, make sure to install the correct:

- Designation
- Manufacturer
- Model

**⚠ WARNING** Risk of injury through exceeding the specified tire load rating or the permissible speed rating

Exceeding the specified tire load rating or the permissible speed rating may lead to tire damage and to the tires bursting.

- ▶ Therefore, only use tire types and sizes approved for your vehicle model.
- ▶ Observe the tire load rating and speed rating required for your vehicle.

**! NOTE** Vehicle and tire damage through tire types and sizes that have not been approved

For safety reasons, only use tires, wheels and accessories which have been specially approved by Mercedes-Benz for your vehicle.

These tires are specially adapted to the control systems, such as ABS, ESP® and 4MATIC, and marked as follows:

- MO = Mercedes-Benz Original
- MOE = Mercedes-Benz Original Extended (run-flat tire only for certain wheels)
- MO1 = Mercedes-Benz Original (only certain AMG tires)

Certain characteristics, such as handling, vehicle noise emissions, fuel consumption, etc. may otherwise be adversely affected. Furthermore, other tire sizes could result in the tires rubbing against the body and axle components when loaded. This could result in damage to the tire or the vehicle.

Only use tires, wheels and accessories that have been checked and recommended by Mercedes-Benz.

**!** **NOTE** Risk to driving safety from retreaded tires

Retreaded tires are neither tested nor recommended by Mercedes-Benz, since previous damage cannot always be detected on retreaded tires.

For this reason driving safety cannot be guaranteed.

- ▶ Do not use used tires if you have no information about their previous usage.

**!** **NOTE** Possible damage to wheels or tires when driving over obstacles

Large wheels have a lower tire section width. The lower the tire section width, the greater is the risk of damage to wheels or tires when driving over obstacles.

- ▶ Avoid obstacles or drive particularly carefully.

**!** **NOTE** Damage to electronic component parts from the use of tire-mounting tools

**Vehicles with a tire pressure monitoring system:** Electronic component parts are located in the wheel. Tire-mounting tools should not be used in the area of the valve.

This could otherwise damage the electronic component parts.

- ▶ Have the tires changed at a qualified specialist workshop only.

**!** **NOTE** Damage to summer tires at low ambient temperatures

At low ambient temperatures, tears could form when driving with summer tires, causing permanent damage to the tires.

- ▶ At temperatures below 45 °F (7 °C), use M+S tires .

Accessory parts that are not approved for your vehicle by Mercedes-Benz or are not being used correctly can impair the operating safety.

Before purchasing and using non-approved accessories, visit a qualified specialist workshop and inquire about:

- Suitability
- Legal stipulations
- Factory recommendations

**!** **WARNING** Risk of accident with high performance tires

The special tire tread in combination with the optimized tire compound means that the risk of skidding or hydroplaning on wet roads is increased.

In addition, the tire grip is greatly reduced at a low outside temperature and tire running temperature.

- ▶ Switch on the ESP® and adapt your driving style accordingly.
- ▶ Use M+S tire at outside temperatures of less than 10 °C (50 °F).

Observe the following when selecting, installing and replacing tires:

- Only use tires and wheels of the same type (summer tires, winter tires, MOExtended tires) and the same make.
- Only install wheels of the same size on one axle (left and right).

It is only permissible to install a different wheel size in the event of a flat tire in order to drive to the specialist workshop.

- Only install tires of the correct size onto the wheels.
- **Vehicles with a tire pressure monitoring system:** All installed wheels must be equipped with functioning sensors for the tire pressure monitoring system.
- At temperatures below 45 °F (7 °C), use winter tires or all-season tire marked M+S for all wheels.

Winter tires bearing the  snowflake symbol in addition to the M+S marking provide the best possible grip in wintry road conditions.

- For M+S tires, only use tires with the same tread.
- Observe the maximum permissible speed for the M+S tires installed.

If this is below the vehicle's maximum speed, this must be indicated by an appropriate label in the driver's field of vision.

- Break in new tires at moderate speeds for the first 60 miles (100 km).
- Replace the tires after six years at the latest, regardless of wear.
- **When replacing with tires that do not feature run-flat characteristics:** vehicles with MOExtended tires are not equipped with a TIREFIT kit at the factory. Equip the vehicle with a TIREFIT kit after replacing with tires that do not feature run-flat characteristics, e.g. winter tires.

For more information on wheels and tires, contact a qualified specialist workshop.

Be sure to also observe the following further related subjects:

- Notes on tire pressure (→ page 419)

- Tire and Loading Information placard (→ page 426)
- Tire size designation, load-bearing capacity, speed rating and load index (→ page 433)
- Tire pressure table (→ page 420)

### Notes on rotating wheels

 **WARNING** Risk of injury through different wheel sizes

Interchanging the front and rear wheels if the wheels or tires have different dimensions may severely impair the driving characteristics.

The wheel brakes or wheel suspension components may also be damaged.

- ▶ Rotate front and rear wheels only if the wheels and tires are of the same dimensions.



The wear patterns on the front and rear wheels differ:

- Front wheels wear more on the shoulder of the tire
- Rear wheels wear more in the center of the tire

On vehicles that have the same size front and rear wheels, rotating the wheels according to the intervals in the tire manufacturer's warranty book in your vehicle documents. If this is not available, rotate the tires every 3,000 to 6,000 miles (5,000 to 10,000 km), depending on the wear. Ensure that the direction of rotation is maintained.

It is imperative to observe the instructions and safety notes on "Changing a wheel" when doing so Preparing the vehicle for a wheel change(→ page 442).

### Notes on storing wheels

When storing wheels, observe the following notes:

- After removing wheels, store them in a cool, dry and preferably dark place.
- Protect the tires from contact with oil, grease or fuel.

### Overview of the tire-change tool kit

Apart from some country-specific variants, vehicles are not equipped with a tire-change tool kit. For more information on which tire-change tools are required and approved for performing a wheel change on your vehicle, consult a qualified specialist workshop.

You require the following tools, for instance, to change a wheel:

- Jack
- Chock
- Lug wrench

The tire-change tool kit is located in tool bag ① in the trunk.

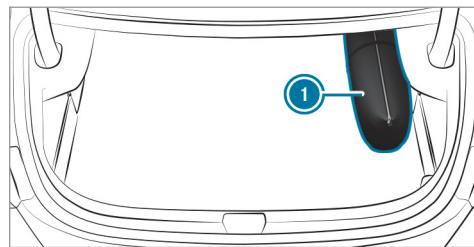

① Tool bag

Tool bag ① contains:

- Jack
- Gloves
- Lug wrench
- Folding chock
- Ratchet for jack

### Setting up the folding chock

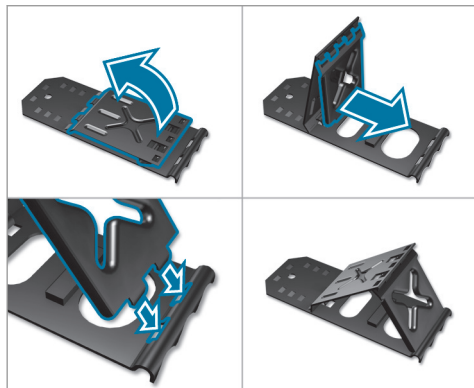

### Preparing the vehicle for a wheel change

#### Requirements:

- The required tire-change tool is available. If your vehicle is not equipped with the tire-change tool kit, consult a qualified specialist workshop to find out about suitable tools.

- The vehicle is not on a slope.
- The vehicle is on solid, non-slippery and level ground.

- ▶ Apply the electric parking brake manually.
- ▶ Move the front wheels to the straight-ahead position.
- ▶ **Vehicles with automatic transmission:** Shift into position **P**.
- ▶ Switch off the engine.
- ▶ Make sure that the engine cannot be started.
- ▶ Place chocks or other suitable items under the front and rear of the wheel that is diagonally opposite the wheel you wish to change.
- ▶ Remove the hub caps if necessary (→ page 442).
- ▶ Raise the vehicle (→ page 443).

### Removing and installing hub caps

#### Requirements:

- The vehicle is prepared for a wheel change (→ page 442).

### Vehicles with steel wheels

The wheel trim covers the wheel bolts. Before you can unscrew the wheel bolts, you must remove the wheel trim.

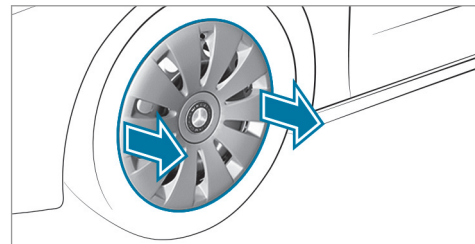

- ▶ **To remove:** using both hands, carefully reach into two wheel trim openings and remove the wheel trim.

### Plastic hub cap

- ▶ **To remove:** turn the center cover of the hub cap counter-clockwise and remove the hub cap.
- ▶ **To install:** make sure that the center cover of the hub cap is turned counter-clockwise.

- ▶ Position the hub cap and turn the center cover clockwise until the hub cap engages physically and audibly.

### Raising the vehicle when changing a wheel

#### Requirements:

- There are no persons in the vehicle.
- The vehicle has been prepared for a wheel change (→ page 442).

#### Important notes on using the jack:

- Only use the vehicle-specific jack that has been tested and approved by Mercedes-Benz to raise the vehicle.
- The jack is only designed for raising and holding the vehicle for a short time while a wheel is being changed and not for maintenance work under the vehicle.
- The jack must be placed on a firm, flat and non-slip surface. If necessary, use a large, flat, load-bearing, non-slip underlay.
- The foot of the jack must be positioned vertically under the jack support point.

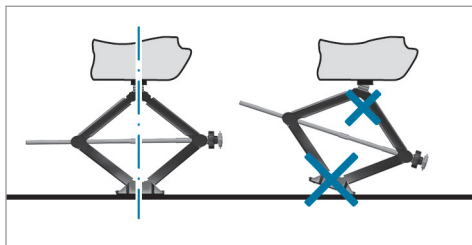

#### Rules of conduct when the vehicle is raised:

- Never place your hands or feet under the vehicle.
- Never lie under the vehicle.
- Do not start the engine and do not release the electric parking brake.
- Do not open or close any doors or the trunk lid.

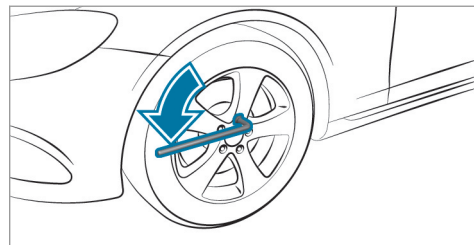

- ▶ Using the lug wrench, loosen the wheel bolts on the wheel you wish to change by about one full turn. Do not unscrew the bolts completely.

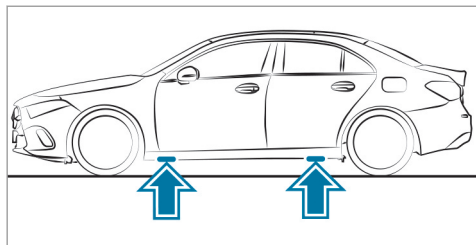

Position of jack support points

**Mercedes-AMG vehicles:** observe the notes in the Supplement. Otherwise, you may not recognize dangers.

**⚠ WARNING** Risk of injury from incorrect positioning of the jack

If you do not position the jack correctly at the appropriate jacking point of the vehicle, the jack could tip with the vehicle raised.

- ▶ Only position the jack at the appropriate jacking point of the vehicle. The base of the jack must be positioned

vertically under the jacking point of the vehicle.

**! NOTE** Vehicle damage from the jack

If you do not position the jack correctly at the appropriate jack support point of the vehicle, the jack could tip over with the vehicle raised.

- ▶ The jack is designed exclusively for jacking up the vehicle at the jack support points.
- ▶ Take the ratchet out of the tire-change tool kit and place it on the hexagon nut of the jack so that the letters "AUF" are visible.

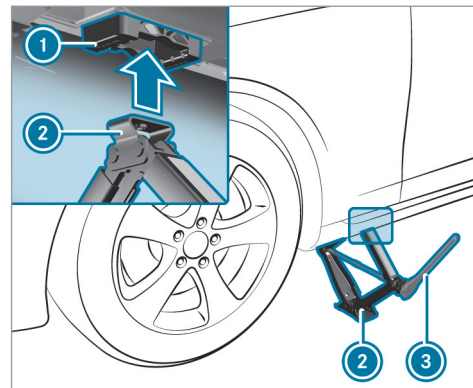

- ▶ Position jack ② at jack support point ①.
- ▶ Turn ratchet ③ clockwise until jack ② sits completely on jack support point ① and the base of the jack lies evenly on the ground.
- ▶ Turn ratchet ③ until the tire is raised a maximum of 1.2 in (3 cm) from the ground.
- ▶ Loosen and remove the wheel (→ page 445).

## Removing a wheel

### Requirements:

- The vehicle is raised (→ page 443).

**Mercedes-AMG vehicles:** observe the notes in the Supplement. Otherwise, you may not recognize dangers.

When changing a wheel, avoid applying any force to the brake discs, since this could impair the level of comfort when braking.

**!** **NOTE** Damage to threading from dirt on wheel bolts

▶ Do not place wheel bolts in sand or on a dirty surface.

- ▶ Unscrew the uppermost wheel bolt completely.
- ▶ Unscrew the remaining wheel bolts fully.
- ▶ Remove the wheel.
- ▶ Install the new wheel (→ page 445).

## Mounting a new wheel

### Requirements:

- The wheel is removed (→ page 445).

**Mercedes-AMG vehicles:** observe the notes in the Supplement. Otherwise, you may not recognize dangers.

**⚠ WARNING** Risk of accident from losing a wheel

Oiled, greased or damaged wheel bolt/wheel nut threads or wheel hub/wheel mounting bolt threads can cause the wheel bolts/wheel nuts to come loose.

As a result, you could lose a wheel while driving.

- ▶ Never oil or grease the threads.
- ▶ In the event of damage to the threads, contact a qualified specialist workshop immediately.
- ▶ Have the damaged wheel bolts or damaged hub threads replaced.
- ▶ Do not continue driving.

- ▶ Observe the information on the choice of tires (→ page 438).

For tires with a specified direction of rotation, an arrow on the side wall of the tire indicates the correct direction of rotation. Observe the direction of rotation when installing.

**⚠ WARNING** Risk of injury from tightening wheel bolts and nuts

If you tighten the wheel bolts or wheel nuts when the vehicle is raised, the jack could tip.

- ▶ Only tighten wheel bolts or wheel nuts when the vehicle is on the ground.

- ▶ Be sure to observe the instructions and safety notes on "Changing a wheel" (→ page 438).
- ▶ For safety reasons, only use wheel bolts which have been approved by Mercedes-Benz and for the wheel in question.

**NOTE** Damage to paintwork of the wheel rim when screwing on the first wheel bolt

If the wheel has too much play when screwing in the first wheel bolt, the wheel rim paint can be damaged.

- ▶ Press the wheel firmly against the wheel hub when screwing on the first wheel bolt.

- ▶ Tighten the wheel bolts evenly in a diagonal pattern in the order indicated until they are finger-tight.
- ▶ Lower the vehicle (→ page 446).

### Lowering the vehicle after a wheel change

#### Requirements:

- The new wheel has been installed (→ page 445).
- ▶ Place the ratchet onto the hexagon nut of the jack so that the letters "AB" are visible.
- ▶ **To lower the vehicle:** turn the ratchet of the jack counter-clockwise.

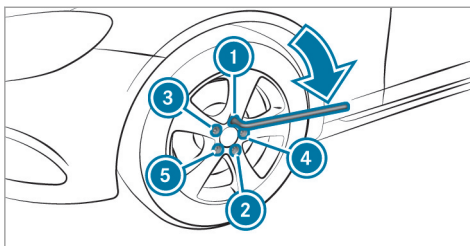

- ▶ Tighten the wheel bolts evenly in a diagonal pattern in the order indicated ① to ⑤ with a maximum of 59 lb-ft (80 Nm).
- ▶ Then tighten the wheel bolts evenly in a diagonal pattern in the order indicated ① to ⑤ to the specified tightening torque of 96 lb-ft (130 Nm).

**WARNING** Risk of injury through incorrect tightening torque

The wheels could come loose if the wheel bolts or wheel nuts are not tightened to the prescribed tightening torque.

- ▶ Make sure the wheel bolts or wheel nuts are tightened to the prescribed tightening torque.
- ▶ If you are not sure, do not move the vehicle. Consult a qualified specialist workshop and have the tightening torque checked immediately.

- ▶ Check the tire pressure of the newly mounted wheel and adjust accordingly.
- ▶ **Vehicles with tire pressure loss warning system:** Restart the tire pressure loss warning system (→ page 425).
- ▶ **Vehicles with a tire pressure monitoring system:** Restart the tire pressure monitoring system (→ page 424).

Make sure to observe the following further related subject:

- Notes on tire pressure (→ page 419)

### Notes on technical data

**Mercedes-AMG vehicles:** be sure to observe the notes in the Supplement. Otherwise, you may fail to recognize dangers.

The data stated only applies to vehicles with standard equipment. You can obtain further information from an authorized Mercedes-Benz Center.

### Vehicle electronics

#### Two-way radios

##### Notes on installing two-way radios

**⚠ WARNING** Risk of accident due to improper work on two-way radios

The electromagnetic radiation from two-way radios can interfere with the on-board electronics if RF transmitters are manipulated or retrofitted incorrectly.

This could jeopardize the operating safety of the vehicle.

- ▶ You should have all work on electrical and electronic components carried out at a qualified specialist workshop.

**⚠ WARNING** Risk of accident from incorrect operation of two-way radios

If you operate two-way radios incorrectly in the vehicle, the electromagnetic radiation could interfere with the on-board electronics, e.g.:

- if the two-way radio is not connected to an exterior antenna
- if the exterior antenna is not correctly mounted or is not of low reflection

This could jeopardize the operating safety of the vehicle.

- ▶ Have the low-reflection exterior antenna installed at a qualified specialist workshop.
- ▶ When operating two-way radios in the vehicle, always connect them to the low-reflection exterior antenna.

**! NOTE** Invalidation of the operating permit due to failure to comply with the instructions for installation and use

The operating permit may be invalidated if the instructions for installation and use of two-way radios are not observed.

- ▶ Only use approved frequency bands.
- ▶ Observe the maximum permissible output power in these frequency bands.
- ▶ Only use approved antenna positions.

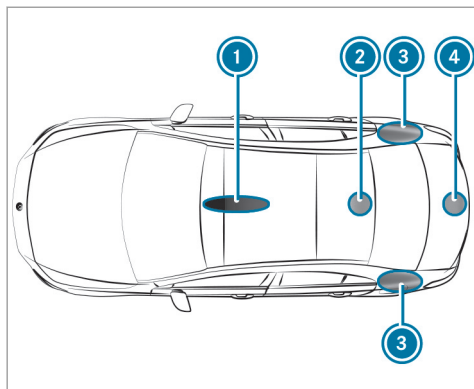

- ① Front roof area
- ② Rear roof area
- ③ Rear fenders
- ④ Trunk lid

On vehicles with a panoramic sliding sunroof, installing an antenna to the front or rear roof area is not permitted.

On the rear fenders, it is recommended that you install the antenna on the side of the vehicle closest to the center of the road.

Use Technical Specification ISO/TS 21609 (Road Vehicles - "EMCs for installation of aftermarket radio frequency transmitting equipment") when retrofitting two-way radios. Comply with the legal requirements for detachable parts.

If your vehicle has installations for two-way radio equipment, use the power supply and antenna connectors provided in the pre-installation. Be sure to observe the manufacturer's supplements when installing.

#### Two-way radio transmission output

The maximum transmission output (PEAK) at the base of the antenna must not exceed the values in the following table.

#### Frequency band and maximum transmission output

Frequency band	Maximum transmission output
Short wave 3 - 54 MHz	(100 W)
4 m frequency band 74 - 88 MHz	(30 W)
2 m frequency band 144 - 174 MHz	(50 W)
Trunked radio system/Tetra 380 - 460 MHz	(10 W)
70 cm frequency band 420 - 450 MHz	(35 W)
Two-way radio (2G/3G/4G)	(10 W)



The following devices can be used in the vehicle without restrictions:

- Two-way radios with a maximum transmission output of up to 100 mW
- Two-way radios with transmitter frequencies in the 380 - 410 MHz frequency band and a maximum transmission output of up to 2 W (trunked radio system/Tetra)
- Mobile phones (2G/3G/4G)

There are no restrictions when positioning the antenna on the outside of the vehicle for the following frequency bands:

- Trunked radio system/Tetra
- 70 cm frequency band
- 2G/3G/4G

## Vehicle identification plate, VIN and engine number

### Vehicle identification plate

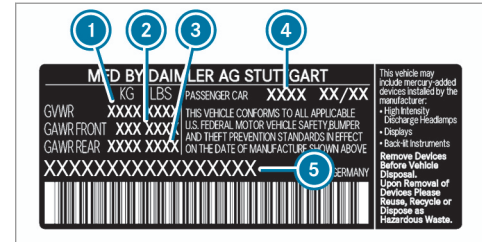
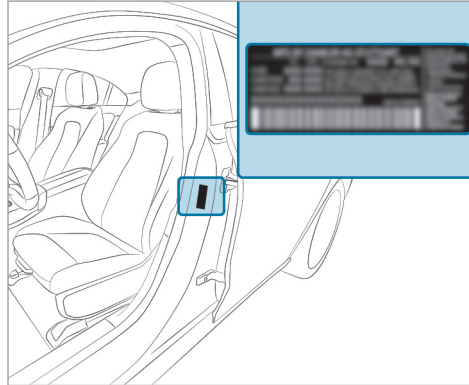

Vehicle identification plate (USA only)

- 1 Permissible gross weight
- 2 Maximum permissible front axle load
- 3 Maximum permissible rear axle load
- 4 Paint code
- 5 VIN (vehicle identification number)

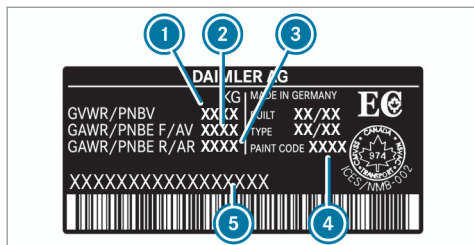

Vehicle identification plate (Canada only)

- ① Permissible gross weight
- ② Maximum permissible front axle load
- ③ Maximum permissible rear axle load
- ④ Paint code
- ⑤ VIN (vehicle identification number)

The maximum permissible gross vehicle weight is made up of the vehicle weight, all vehicle occupants, the fuel and the load. The maximum gross axle weight rating is the maximum weight that can be carried on one axle (front or rear axle).

Do not exceed the maximum permissible gross vehicle weight or the maximum gross axle weight rating for the front or rear axle.

### VIN, engine number and other signs

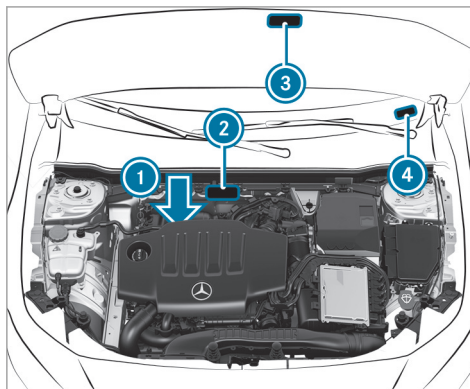

- ① Engine number stamped into the crankcase
- ② VIN (vehicle identification number) stamped into the crossmember

- ③ Plate with information about emissions testing, including confirmation of emissions guidelines at the U.S. federal level as well as for California
- ④ VIN as a label at the lower edge of the windshield

### Operating fluids

#### Notes on operating fluids

**Mercedes-AMG vehicles:** be sure to observe the information in the Supplement. Otherwise, you may fail to recognize dangers.

**⚠ WARNING** Risk of injury from operating fluids harmful to your health

Operating fluids may be poisonous and harmful to your health.

- ▶ Observe the text on the original containers when using, storing or disposing of operating fluids.
- ▶ Always store operating fluids sealed in their original containers.

- ▶ Always keep children away from operating fluids.

 **ENVIRONMENTAL NOTE** Environmental pollution caused by environmentally irresponsible disposal

- ▶ Dispose of operating fluids in an environmentally responsible manner.

Operating fluids include the following:

- Fuels
- Lubricants
- Coolant
- Brake fluid
- Windshield washer fluid
- Climate control system refrigerant

Only use products approved by Mercedes-Benz. Damage caused by the use of products that have not been approved is not covered by the Mercedes-Benz warranty or goodwill gestures.

You can identify operating fluids approved by Mercedes-Benz by the following inscriptions on the container:

- MB-Freigabe (e.g. MB-Freigabe 229.51)
- MB-Approval (e.g. MB-Approval 229.51)

Further information on approved operating fluids is available at the following locations:

- in the Mercedes-Benz Specifications for Operating Fluids by entering the designation
  - at <http://bevo.mercedes-benz.com>
  - in the Mercedes-Benz BeVo App
- at a qualified specialist workshop

 **WARNING** Risk of fire or explosion from fuel

Fuels are highly flammable.

- ▶ Fire, open flames, smoking and creation of sparks must be avoided.
- ▶ Switch off the ignition and, if available, the stationary heater, before and while refueling the vehicle.

 **WARNING** Risk of injury from fuels

Fuels are poisonous and hazardous to your health.

- ▶ Do not swallow fuel or let it come into contact with skin, eyes or clothing.
- ▶ Do not inhale fuel vapor.
- ▶ Keep children away from fuel.
- ▶ Keep doors and windows closed during the refueling process.

If you or other people come into contact with fuel, observe the following:

- ▶ Immediately rinse fuel off your skin with soap and water.
- ▶ If fuel comes into contact with your eyes, immediately rinse them thoroughly with clean water. Seek medical attention immediately.
- ▶ If you swallow fuel, seek medical attention immediately. Do not induce vomiting.

- ▶ Change immediately out of clothing that has come into contact with fuel.

## Fuel

### Notes on fuel grades for vehicles with a gasoline engine

Observe the notes on operating fluids (→ page 450).

#### **!** NOTE Damage caused by the wrong fuel

Even small amounts of the wrong fuel could result in damage to the fuel system, the engine and the emission control system.

- ▶ Only refuel with low-sulfur unleaded fuel.

This fuel may contain up to 10% ethanol by volume. Your vehicle is suitable for use with E10 fuel.

Never refuel with one of the following fuels:

- Diesel

- Gasoline with more than 10% ethanol by volume, e.g. E15, E85, E100
- Gasoline with more than 3% methanol by volume, e.g. M15, M30, M85, M100
- Gasoline with additives containing metal

If you have accidentally refueled with the wrong fuel:

- ▶ Do not switch on the ignition.
- ▶ Consult a qualified specialist workshop.

If the available fuel is not sufficiently low in sulfur, this can produce unpleasant odors.

Only refuel with fuel that has at least the octane number specified in the instruction label in the fuel filler flap (→ page 145).

**If you want maximum engine output:** only refuel with unleaded premium grade gasoline with an octane number of at least 91 AKI/95 RON.

As a temporary measure, if the recommended fuel is not available, you may also refuel with unleaded regular gasoline with at least 87 AKI/

91 RON. This may reduce engine output and increase fuel consumption.

Never refuel using gasoline with an even lower RON.

#### **!** NOTE Premature wear caused by unleaded regular gasoline

Unleaded regular gasoline can cause the engine to wear more quickly and impair longevity and performance.

If unleaded premium grade gasoline is unavailable and you have to refuel using unleaded regular gasoline:

- ▶ Only fill the fuel tank to half full with unleaded regular gasoline and refill as soon as possible with unleaded premium grade gasoline.
- ▶ Do not drive at the maximum speed.
- ▶ Avoid sudden acceleration and engine speeds over 3,000 rpm.

Further information on fuel is available at the following locations:

- at a gas station
- at a qualified specialist workshop
- USA only: at <http://www.mbusa.com>

#### Information on additives in gasoline

Observe the notes on operating fluids (→ page 450).

**!** **NOTE** Damage from use of unsuitable additives

Even small amounts of the wrong additive may lead to malfunctions occurring.

▶ Only add cleaning additives recommended by Mercedes-Benz to the fuel.

Mercedes-Benz recommends that you use fuel brands that have additives.

In some countries, the fuel available may not have sufficient additives. Residue could build up in the fuel injection system as a result. In this case, in consultation with an authorized Mercedes-Benz Center, the fuel may be mixed

with the cleaning additive recommended by Mercedes-Benz. Be sure to observe the notes and mixing ratios specified on the container.

#### Tank content and fuel reserve

##### Capacity

Model	Total capacity
All models	13.5 gal (51.0 l)

Model	Of which reserve
All models	1.3 gal (5.0 liters)

#### Engine oil

##### Notes on engine oil

Observe the notes on operating fluids (→ page 450).



**!** **NOTE** Engine damage caused by an incorrect oil filter, incorrect oil or additives

- ▶ Do not use engine oils or oil filters other than those which meet the specifications necessary for the prescribed service intervals.
- ▶ Do not alter the engine oil or oil filter in order to achieve longer change intervals than prescribed.
- ▶ Do not use additives.
- ▶ Have the engine oil changed after the prescribed intervals.

Mercedes-Benz recommends that you have the oil change carried out at a qualified specialist workshop.

Further information on engine oil and oil filters is available at the following locations:

- In the Mercedes-Benz Specifications for Operating Fluids by entering the designation:
  - At <http://bevo.mercedes-benz.com>
  - In the Mercedes-Benz BeVo app
- at a qualified specialist workshop

### Quality and capacity of engine oil

#### MB-Freigabe or MB-Approval

Gasoline engines	MB-Freigabe or MB-Approval
CLA 250	229.71
CLA 250 4MATIC	

The following values refer to an oil change, including the oil filter.

### Capacity

Model	Capacity
All models	5.8 US qt (5.5 liters)

### Notes on brake fluid

Observe the notes on operating fluids (→ page 450).

**⚠ WARNING** Risk of an accident due to vapor pockets forming in the brake system

The brake fluid constantly absorbs moisture from the air. This lowers the boiling point of the brake fluid. If the boiling point is too low, vapor pockets may form in the brake system when the brakes are applied hard.

This causes the braking effect to be impaired.

- ▶ Have the brake fluid renewed at the specified intervals.

Have the brake fluid regularly replaced at a qualified specialist workshop. Only use brake fluid approved by Mercedes-Benz according to MB-Freigabe or MB-Approval 331.0. You can obtain further information on brake fluid in the following places:

- in the Mercedes-Benz Specifications for Operating Fluids
  - at <http://bevo.mercedes-benz.com>
  - in the Mercedes-Benz BeVo App
- at a qualified specialist workshop

### Coolant

#### Notes on coolant

Observe the notes on operating fluids (→ page 450).

**⚠ WARNING** - Risk of fire and injury from antifreeze

If antifreeze comes into contact with hot component parts in the engine compartment, it may ignite.

- ▶ Allow the engine to cool down before adding antifreeze.
- ▶ Make sure that no antifreeze spills out next to the filler opening.
- ▶ Thoroughly clean off any antifreeze from component parts before starting the vehicle.

**!** **NOTE** Damage caused by incorrect coolant

- ▶ Only add coolant that has been pre-mixed with the required antifreeze protection.

Information on coolant is available at the following locations:

- In the Mercedes-Benz Specification for Operating Fluids 310.1
  - At <http://bevo.mercedes-benz.com>
  - In the Mercedes-Benz BeVo app
- At a qualified specialist workshop

**!** **NOTE** Overheating at high outside temperatures

If an inappropriate coolant is used, the engine cooling system is not sufficiently protected against overheating and corrosion at high outside temperatures.

- ▶ Always use coolant approved by Mercedes-Benz.
- ▶ Observe the instructions in the Mercedes-Benz Specifications for Operating Fluids 310.1.

Have the coolant regularly replaced at a qualified specialist workshop.

The proportion of corrosion inhibitor/antifreeze concentrate in the engine cooling system should be:

- a minimum of 50% (antifreeze protection down to approximately -35 °F (-37 °C))
- a maximum of 55% (antifreeze protection down to -49 °F (-45 °C))

### Coolant capacity

Model	Capacity
All models	9.4 US qt (8.9 liters)

### Notes on windshield washer fluid

Observe the notes on operating fluids (→ page 450).

**!** **WARNING** - Risk of fire and injury from windshield washer concentrate

Windshield washer concentrate is highly flammable. It could ignite if it comes into contact with hot engine component parts or the exhaust system.

- ▶ Make sure that no windshield washer concentrate spills out next to the filler opening.

**!** **NOTE** Damage to the exterior lighting due to unsuitable windshield washer fluid

Unsuitable windshield washer fluid may damage the plastic surface of the exterior lighting.

- ▶ Only use windshield washer fluid which is also suitable for use on plastic surfaces, e.g. MB SummerFit or MB WinterFit.

**!** **NOTE** Blocked spray nozzles caused by mixing windshield washer fluids

- ▶ Do not mix MB SummerFit and MB WinterFit with other windshield washer fluids.

Do not use distilled or de-ionized water as the fill level sensor may be triggered erroneously.

Recommended windshield washer fluid:

- Above freezing point: e.g. MB SummerFit
- Below freezing point: e.g. MB WinterFit

For the correct mixing ratio, refer to the information on the antifreeze container.

Mix the washer fluid with the windshield washer fluid all year round.

### Refrigerant

#### Notes on refrigerant

Observe the notes on operating fluids (→ page 450).

**!** **NOTE** Damage due to incorrect refrigerant

If a non-approved refrigerant is used, the climate control system may be damaged.

- ▶ Only use the refrigerant R-134a

**!** **NOTE** Damage to the climate control system due to incorrect refrigerant compressor oil

- ▶ Only use refrigerant compressor oil that has been approved by Mercedes-Benz.

- ▶ Do not mix the approved refrigerant compressor oil with a different refrigerant compressor oil.

Work on the climate control system may be carried out only by a qualified specialist workshop. All applicable regulations, as well as SAE standard J639, must be adhered to.

The instruction label on the climate control system for the refrigerant type and the refrigerant compressor oil is located on the inside of the hood.

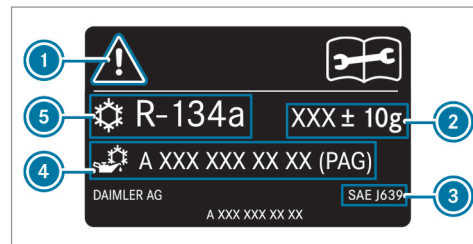

- ① Hazard and service warning symbols
- ② Refrigerant filling capacity



- ③ Applicable standards
- ④ PAG oil part number
- ⑤ Refrigerant type

Symbols ① warn of the following:

- Possible dangers
- Having service work carried out at a qualified specialist workshop

### Refrigerant filling capacity

#### Filling capacity for refrigerant and PAG oil

Model	Refrigerant
All models	24.3 ± 0.4 oz (690 ± 10 g)
Model	PAG oil
All models	2.8 ± 0.4 oz (80 ± 10 g)

### Vehicle data

#### Vehicle dimensions

The heights specified may vary as a result of the following factors:

- Tires
- Load
- Condition of the suspension
- Optional equipment

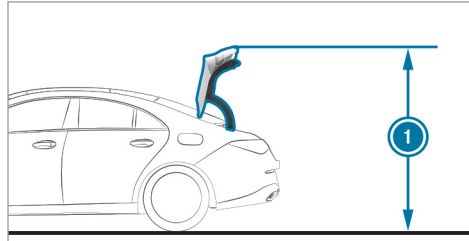

### Height when opened

Model	① Height when opened
CLA 250	73.0 in (1844 mm)
CLA 250 4MATIC	73.0 in (1841 mm)

### Vehicle dimensions

All models	
Vehicle length	185.0 in (4688 mm)
Vehicle width including outside mirrors	78.7 in (1999 mm)
Wheelbase	107.4 in (2729 mm)
Turning radius	36.4 ft (11.10 m)

## 458 Technical data

---

### Vehicle height

Model	
CLA 250	57.0 in (1447 mm)
CLA 250 4MATIC	57.0 in (1444 mm)

### Weights and loads

---

Please observe the following notes for the specified vehicle data:

- Items of optional equipment increase the curb weight and reduce the payload.

### Roof load

All models	
Maximum roof load	220.5 lb (100 kg)

## Display messages

### Introduction

#### Notes on display messages

Display messages appear on the multifunction display.

Display messages with graphic symbols are simplified in the Operator's Manual and may differ from the symbols on the multifunction display. The multifunction display shows high-priority display messages in red. Certain display messages are accompanied by a warning tone.



Please respond in accordance with the display messages and follow the additional notes in this Operator's Manual.

For some display messages, a symbol is also shown:

-  Further information

-  Hide display message

You can select the desired symbol by swiping left or right on the left-hand Touch Control.

Press the  symbol to show further information on the multifunction display. Press the  symbol to hide the display message.

You can hide low-priority display messages by pressing the  button or the left-hand Touch Control. The display messages are then stored in the message memory.

Rectify the cause of a display message as quickly as possible.

High-priority display messages cannot be hidden. The multifunction display shows these display messages continuously until the cause of the message has been rectified.

#### Calling up stored display messages

On-board computer:

 Service  1 Message



If there are no display messages, **No Messages** appears on the multifunction display.

▶ Scroll through the display messages by swiping upwards or downwards on the left-hand Touch Control.

▶ **To exit the message memory:** press the  button.

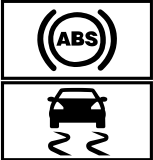

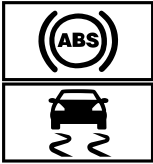

## Safety systems

Display messages	Possible causes/consequences and ► Solutions
 <p data-bbox="144 467 408 515">Currently Unavailable See Operator's Manual</p>	<p data-bbox="476 291 1628 410">* ABS and ESP® are temporarily unavailable. Other driving systems and driving safety systems may also be temporarily unavailable. The brake system continues to operate normally. The braking distance in an emergency braking situation can increase.</p> <div data-bbox="495 430 1646 679" style="background-color: #f0f0f0; padding: 10px;"> <p data-bbox="513 441 1190 467"><b>▲ WARNING</b> Risk of skidding if ABS and ESP® are malfunctioning</p> <p data-bbox="513 482 1591 534">If ABS and ESP® are malfunctioning, the wheels could lock when braking and ESP® cannot carry out vehicle stabilization.</p> <p data-bbox="513 544 1628 596">The steering capability and braking characteristics are thus severely impaired. The braking distance in an emergency braking situation can increase. In addition, other driving safety systems are switched off.</p> <ul data-bbox="513 607 1313 669" style="list-style-type: none"> <li>▶ Drive on carefully.</li> <li>▶ Have ABS and ESP® checked immediately at a qualified specialist workshop.</li> </ul> </div> <p data-bbox="495 695 1578 746">▶ Carefully drive on a suitable stretch of road, making slight steering movements at a speed above 19 mph (30 km/h).</p> <p data-bbox="495 757 1637 783">▶ If the display message does not disappear, consult a qualified specialist workshop immediately. Drive carefully.</p>

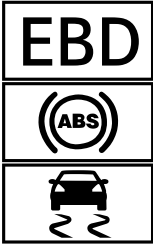
Display messages	Possible causes/consequences and ► Solutions
 <p data-bbox="195 428 469 477">Inoperative See Operator's Manual</p>	<p data-bbox="524 252 888 277">* ABS and ESP® are malfunctioning.</p> <p data-bbox="543 288 1258 312">Other driving systems and driving safety systems may also malfunction.</p> <p data-bbox="543 323 1637 370">The brake system continues to operate normally. The braking distance in an emergency braking situation can increase.</p> <div data-bbox="543 391 1702 640" style="border: 1px solid gray; padding: 5px;"> <p data-bbox="565 401 1240 426"><b>▲ WARNING</b> Risk of skidding if ABS and ESP® are malfunctioning</p> <p data-bbox="561 443 1641 491">If ABS and ESP® are malfunctioning, the wheels could lock when braking and ESP® cannot carry out vehicle stabilization.</p> <p data-bbox="561 505 1677 553">The steering capability and braking characteristics are thus severely impaired. The braking distance in an emergency braking situation can increase. In addition, other driving safety systems are switched off.</p> <ul style="list-style-type: none"> <li data-bbox="561 567 778 592">► Drive on carefully.</li> <li data-bbox="561 602 1360 627">► Have ABS and ESP® checked immediately at a qualified specialist workshop.</li> </ul> </div> <ul style="list-style-type: none"> <li data-bbox="543 654 759 679">► Drive on carefully.</li> <li data-bbox="543 689 1068 714">► Visit a qualified specialist workshop immediately.</li> </ul>
 <p data-bbox="195 822 458 871">Currently Unavailable See Operator's Manual</p>	<p data-bbox="524 734 864 759">* ESP® is temporarily unavailable.</p> <p data-bbox="543 769 1258 794">Other driving systems and driving safety systems may also malfunction.</p>

Display messages	Possible causes/consequences and ► Solutions
	<div data-bbox="500 249 1646 291" style="background-color: #e0e0e0; padding: 5px;"> <p><b>▲ WARNING</b> Risk of skidding if ESP® is malfunctioning</p> </div> <p>If ESP® is malfunctioning, ESP® cannot carry out vehicle stabilization. In addition, other driving safety systems are switched off.</p> <ul style="list-style-type: none"> <li>▶ Drive on carefully.</li> <li>▶ Have ESP® checked at a qualified specialist workshop.</li> </ul> <p>► Carefully drive on a suitable stretch of road, making slight steering movements at a speed above 19 mph (30 km/h).</p> <p>► If the display message does not disappear, consult a qualified specialist workshop immediately. Drive carefully.</p>
<div data-bbox="155 557 312 640" style="border: 1px solid black; padding: 5px; text-align: center;">  </div> <p>Inoperative See Operator's Manual</p>	<p>* ESP® is malfunctioning</p> <p>Other driving systems and driving safety systems may also malfunction.</p> <p>The brake system continues to operate normally. The braking distance in an emergency braking situation can increase.</p> <div data-bbox="500 695 1646 736" style="background-color: #e0e0e0; padding: 5px;"> <p><b>▲ WARNING</b> Risk of skidding if ESP® is malfunctioning</p> </div> <p>If ESP® is malfunctioning, ESP® cannot carry out vehicle stabilization. In addition, other driving safety systems are switched off.</p> <ul style="list-style-type: none"> <li>▶ Drive on carefully.</li> <li>▶ Have ESP® checked at a qualified specialist workshop.</li> </ul>

Display messages	Possible causes/consequences and ► Solutions
 <p data-bbox="195 588 469 636">Inoperative See Operator's Manual</p>	<ul style="list-style-type: none"> <li>► Drive on carefully.</li> <li>► Visit a qualified specialist workshop immediately.</li> </ul> <p data-bbox="528 325 1258 384">* EBD, ABS and ESP® are malfunctioning. Other driving systems and driving safety systems may also malfunction.</p> <div style="border: 1px solid gray; padding: 5px; margin: 10px 0;"> <p data-bbox="565 415 1295 441"><b>▲ WARNING</b> Risk of skidding if EBD, ABS and ESP® are malfunctioning</p> <p data-bbox="565 456 1674 508">If EBD, ABS and ESP® are malfunctioning, the wheels can lock when braking and ESP® cannot carry out vehicle stabilization.</p> <p data-bbox="565 519 1674 570">The steering capability and braking characteristics are thus severely impaired. The braking distance in an emergency braking situation can increase. In addition, other driving safety systems are switched off.</p> <ul style="list-style-type: none"> <li>► Drive on carefully.</li> <li>► Have the brake system checked immediately at a qualified specialist workshop.</li> </ul> </div> <ul style="list-style-type: none"> <li>► Drive on carefully.</li> <li>► Visit a qualified specialist workshop immediately.</li> </ul>

Display messages	Possible causes/consequences and ► Solutions
<div data-bbox="155 252 310 332" data-label="Image"> </div> <p data-bbox="155 339 260 366">(USA only)</p> <div data-bbox="155 379 310 458" data-label="Image"> </div> <p data-bbox="155 466 291 493">(Canada only)</p> <p data-bbox="147 505 410 553">Turn On the Ignition to Release the Parking Brake</p>	<p data-bbox="473 249 1363 308">* The red  (USA only) or  indicator lamp (Canada only) is lit. You have attempted to release the electric parking brake with the ignition switched off.</p> <ul data-bbox="495 319 753 346" style="list-style-type: none"> <li>► Switch on the ignition.</li> </ul>
<div data-bbox="155 577 310 656" data-label="Image"> </div> <p data-bbox="155 664 260 691">(USA only)</p> <div data-bbox="155 703 310 783" data-label="Image"> </div> <p data-bbox="155 790 291 817">(Canada only)</p> <p data-bbox="147 824 380 872">Please Release Parking Brake</p>	<p data-bbox="473 573 1445 629">* The red  (USA only) or  (Canada only) indicator lamp flashes. The electric parking brake is applied while you are driving:</p> <ul data-bbox="500 640 1445 698" style="list-style-type: none"> <li>• A condition for automatic release of the electric parking brake is not fulfilled (→ page 155).</li> <li>• You are performing emergency braking using the electric parking brake (→ page 156).</li> </ul> <ul data-bbox="495 718 1419 777" style="list-style-type: none"> <li>► Check that the conditions for automatic release of the electric parking brake are fulfilled.</li> <li>► Release the electric parking brake manually.</li> </ul>



## Display messages



(USA only)



(Canada only)

Parking Brake See Operator's Manual

## Possible causes/consequences and ► Solutions



\* The yellow  indicator lamp is lit. The electric parking brake is malfunctioning.

**To apply:**

- Switch off the ignition and turn it back on.
- Apply the electric parking brake manually (→ page 155).

If it is not possible to apply the electric parking brake:

- Visit a qualified specialist workshop.
- Where necessary, also safeguard the parked vehicle against rolling away.

The yellow  and the red  (USA only) or  (Canada only) indicator lamps are lit. The electric parking brake is malfunctioning.

**To release:**



- Switch off the ignition and turn it back on.
- Release the electric parking brake manually (→ page 155).

or





- Release the electric parking brake automatically (→ page 155).

If it is still not possible to release the electric parking brake:

- Do not continue driving under any circumstances. Consult a qualified specialist workshop.





The yellow  indicator lamp is lit and the red  (USA only) or  (Canada only) indicator lamp is flashing. The electric parking brake is malfunctioning.



The electric parking brake could not be applied or released.

Display messages	Possible causes/consequences and ► Solutions
	<ul style="list-style-type: none"><li>► Switch off the ignition and turn it back on.</li></ul> <p><b>To apply:</b></p> <ul style="list-style-type: none"><li>► Release and then apply the electric parking brake manually (→ page 155).</li></ul> <p><b>To release:</b></p> <ul style="list-style-type: none"><li>► Apply and then release the electric parking brake manually.</li></ul> <p>If the electric parking brake cannot be applied or the red  (USA only) or  (Canada only) indicator lamp continues to flash:</p> <ul style="list-style-type: none"><li>► Do not continue driving under any circumstances. Consult a qualified specialist workshop.</li><li>► Where necessary, also safeguard the parked vehicle against rolling away.</li></ul> <p>The yellow  indicator lamp is on and the red  indicator lamp (USA only) or the  indicator lamp (Canada only) flashes for approximately ten seconds after the electric parking brake has been applied or released. It then remains lit or goes out. The electric parking brake is malfunctioning.</p> <p><b>If the battery charge level is too low:</b></p> <ul style="list-style-type: none"><li>► Charge the battery.</li></ul> <p><b>To apply:</b></p> <ul style="list-style-type: none"><li>► Switch the ignition off. The electric parking brake is applied automatically.</li></ul>

Display messages	Possible causes/consequences and ► Solutions
	<p>If the electric parking brake should not be applied, e.g. when washing the vehicle in an automatic car wash or when having the vehicle towed, leave the ignition switched on. This does not include having the vehicle towed with the rear axle raised.</p> <p>If the electric parking brake is not applied automatically:</p> <ul style="list-style-type: none"><li>► Switch off the ignition and turn it back on.</li><li>► Release and then apply the electric parking brake manually (→ page 155).</li></ul> <p>If it is still not possible to apply the electric parking brake:</p> <ul style="list-style-type: none"><li>► Visit a qualified specialist workshop.</li><li>► Where necessary, also safeguard the parked vehicle against rolling away.</li></ul> <p><b>To release:</b></p> <ul style="list-style-type: none"><li>► If the conditions for automatic release are fulfilled and the electric parking brake is not released automatically, release the electric parking brake manually (→ page 155).</li></ul> <p>If it is still not possible to release the electric parking brake:</p> <ul style="list-style-type: none"><li>► Do not continue driving under any circumstances. Consult a qualified specialist workshop.</li></ul>

Display messages	Possible causes/consequences and ► Solutions
<div data-bbox="155 252 310 332" data-label="Image"> </div> <p data-bbox="149 342 251 366">(USA only)</p> <div data-bbox="155 379 310 458" data-label="Image"> </div> <p data-bbox="149 469 284 493">(Canada only)</p> <p data-bbox="149 503 389 527">Check Brake Fluid Level</p>	<p data-bbox="476 249 1077 273">* There is insufficient brake fluid in the brake fluid reservoir.</p> <div data-bbox="513 291 1646 332" data-label="Text"> <p><b>▲ WARNING</b> Risk of an accident due to low brake fluid level</p> </div> <p data-bbox="513 339 1513 363">If the brake fluid level is too low, the braking effect and the braking characteristics may be impaired.</p> <ul data-bbox="513 373 1585 493" style="list-style-type: none"> <li>▶ Pull over and stop the vehicle safely as soon as possible, paying attention to road and traffic conditions. Do not continue driving under any circumstances.</li> <li>▶ Consult a qualified specialist workshop.</li> <li>▶ Do not add brake fluid.</li> </ul> <ul data-bbox="495 524 1641 638" style="list-style-type: none"> <li>▶ Pull over and stop the vehicle safely as soon as possible, paying attention to road and traffic conditions. Do not continue driving under any circumstances.</li> <li>▶ Do not add brake fluid.</li> <li>▶ Consult a qualified specialist workshop.</li> </ul>
<p data-bbox="149 669 371 715">Check Brake Pads See Operator's Manual</p>	<p data-bbox="476 664 935 687">* The brake pads have reached the wear limit.</p> <div data-bbox="513 705 1646 746" data-label="Text"> <p><b>▲ WARNING</b> Risk of accident due to restricted braking power</p> </div> <p data-bbox="513 754 1400 778">When the brake pads have reached their wear limit, the braking power may be restricted.</p> <ul data-bbox="513 788 1337 845" style="list-style-type: none"> <li>▶ Drive on carefully.</li> <li>▶ Have the brake system checked immediately at a qualified specialist workshop.</li> </ul>

Display messages	Possible causes/consequences and ► Solutions
 <p data-bbox="195 384 445 433">SRS Malfunction Service Required</p>	<p data-bbox="543 249 944 275">► Visit a qualified specialist workshop.</p> <p data-bbox="524 291 975 317">* The restraint system is faulty (→ page 34).</p> <div data-bbox="547 332 1696 503" style="border: 1px solid gray; padding: 5px;"> <p data-bbox="565 342 1286 368"><b>⚠ WARNING</b> Risk of injury due to malfunctions in the restraint system</p> <p data-bbox="565 384 1668 456">If the restraint system is malfunctioning, restraint system components may be triggered unintentionally or may not deploy as intended during an accident. This may affect the Emergency Tensioning Devices or airbags, for example.</p> <p data-bbox="565 472 1548 498">► Have the restraint system checked and repaired immediately at a qualified specialist workshop.</p> </div> <p data-bbox="552 524 1014 550">Recognition of a restraint system malfunction:</p> <ul data-bbox="561 560 1530 617" style="list-style-type: none"> <li>• The  restraint system warning lamp does not light up when the ignition is switched on.</li> <li>• The  restraint system warning lamp lights up continuously or repeatedly during a journey.</li> </ul> <p data-bbox="543 622 1068 648">► Visit a qualified specialist workshop immediately.</p>
 <p data-bbox="195 754 473 800">Front Left Malfunction Service Required (Example)</p>	<p data-bbox="524 660 1123 686">* The corresponding restraint system is faulty (→ page 34).</p> <div data-bbox="547 702 1696 873" style="border: 1px solid gray; padding: 5px;"> <p data-bbox="565 712 1286 738"><b>⚠ WARNING</b> Risk of injury due to malfunctions in the restraint system</p> <p data-bbox="565 754 1668 826">If the restraint system is malfunctioning, restraint system components may be triggered unintentionally or may not deploy as intended during an accident. This may affect the Emergency Tensioning Devices or airbags, for example.</p> <p data-bbox="565 842 1548 868">► Have the restraint system checked and repaired immediately at a qualified specialist workshop.</p> </div>

Display messages	Possible causes/consequences and ► Solutions
	<p>Detection of a restraint system malfunction:</p> <ul style="list-style-type: none"> <li>• The  restraint system warning lamp does not light up when the ignition is switched on.</li> <li>• The  restraint system warning lamp lights up continuously or repeatedly during a journey.</li> </ul> <p>► Visit a qualified specialist workshop immediately.</p>
 <p>Left Side Curtain Airbag Malfunction Service Required (Example)</p>	<p>* The corresponding window curtain airbag is malfunctioning (→ page 34).</p> <div style="border: 1px solid gray; padding: 5px; margin: 5px 0;"> <p><b>▲ WARNING</b> Risk of injury or fatal injury due to malfunctions in the window airbag</p> <p>If the window airbag is malfunctioning, it might be triggered unintentionally or might not be triggered at all in the event of an accident with high deceleration.</p> <p>► Have the window airbag checked and repaired immediately at a qualified specialist workshop.</p> </div> <p>► Visit a qualified specialist workshop immediately.</p>
<p>Front Passenger Airbag Disabled See Operator's Manual</p>	<p>* The front passenger airbag and the knee airbag are disabled, although an adult or a person with an adult stature is on the front passenger seat. If additional forces are applied to the seat, the weight the system detects may be too low.</p> <div style="border: 1px solid gray; padding: 5px; margin: 5px 0;"> <p><b>▲ WARNING</b> Risk of injury or fatal injury due to a disabled front passenger airbag</p> <p>If the front passenger airbag is disabled, the front passenger airbag will not be deployed in the event of an accident and cannot perform its intended protective function.</p> </div>

Display messages	Possible causes/consequences and ► Solutions
	<p>A person in the front passenger seat could then, for example, come into contact with the vehicle's interior, especially if the person is sitting too close to the cockpit.</p> <ul style="list-style-type: none"> <li>► Make sure, both before and during the journey, that the status of the front passenger airbag is correct.</li> </ul> <ul style="list-style-type: none"> <li>► Pull over and stop the vehicle safely as soon as possible, paying attention to road and traffic conditions.</li> <li>► Check the status of the automatic front passenger airbag shutoff (→ page 45).</li> <li>► If necessary, consult a qualified specialist workshop immediately.</li> </ul>
<p>Front Passenger Airbag Enabled See Operator's Manual</p>	<p>* The front passenger airbag and knee airbag are enabled during the journey:</p> <ul style="list-style-type: none"> <li>• even when a child, a small adult or an object weighing less than the system weight threshold is located on the front passenger seat</li> <li>• even when the front passenger seat is not occupied</li> </ul> <p>The system may detect objects or forces that are adding to the weight applied to the seat.</p> <div style="background-color: #f0f0f0; padding: 5px;"> <p><b>⚠ WARNING</b> Risk of injury or fatal injury when using a child restraint system while the front passenger air bag is enabled</p> </div> <p>If you secure a child in a child restraint system on the front passenger seat and the front passenger air bag is enabled, the front passenger air bag can deploy in the event of an accident. The child could be struck by the air bag.</p> <ul style="list-style-type: none"> <li>► Ensure, both before and during the journey, that the status of the front passenger air bag is correct.</li> </ul>

## 472 Display messages and warning/indicator lamps

Display messages	Possible causes/consequences and ► Solutions
	<p data-bbox="513 263 1628 319">NEVER use a rearward facing child restraint on a seat protected by an ACTIVE FRONT AIR BAG; DEATH or SERIOUS INJURY to the CHILD can occur.</p> <ul style="list-style-type: none"> <li data-bbox="495 342 1567 366">► Pull over and stop the vehicle safely as soon as possible, paying attention to road and traffic conditions.</li> <li data-bbox="495 377 1319 400">► Check the status of the automatic front passenger airbag shutoff (→ page 45).</li> <li data-bbox="495 411 1184 435">► If necessary, consult a qualified specialist workshop immediately.</li> </ul>
<p data-bbox="144 459 421 536">Active Brake Assist Functions Currently Limited See Operator's Manual</p>	<p data-bbox="476 453 1628 505">* <b>Vehicles with the Driving Assistance Package:</b> Active Brake Assist with cross-traffic function, Evasive Steering Assist or PRE-SAFE® PLUS are temporarily unavailable or only partially available.</p> <p data-bbox="495 515 1646 567"><b>Vehicles without the Driving Assistance Package:</b> Active Brake Assist is temporarily unavailable or only partially available.</p> <p data-bbox="495 578 1175 601">The ambient conditions are outside the system limits (→ page 162).</p> <ul style="list-style-type: none"> <li data-bbox="495 612 1563 664">► Drive on. As soon as the ambient conditions are within the system limits, the system will become available again.</li> <li data-bbox="495 674 1646 726">► If the display message does not disappear, stop the vehicle in accordance with the traffic conditions and restart the engine.</li> </ul>
<p data-bbox="144 745 402 822">Active Brake Assist Functions Limited See Operator's Manual</p>	<p data-bbox="476 739 1585 791">* <b>Vehicles with Driving Assistance Package:</b> Active Brake Assist with cross-traffic function, Evasive Steering Assist or PRE-SAFE® PLUS is malfunctioning.</p> <p data-bbox="495 801 1363 825"><b>Vehicles without Driving Assistance Package:</b> Active Brake Assist is malfunctioning.</p> <ul style="list-style-type: none"> <li data-bbox="495 836 894 859">► Visit a qualified specialist workshop.</li> </ul>





Display messages	Possible causes/consequences and ► Solutions
PRE-SAFE Inoperative See Operator's Manual	* PRE-SAFE® functions are malfunctioning. ► Visit a qualified specialist workshop.
Mercedes me connect Services Limited See Operator's Manual	* Service limited. At least one of the main functions of the Mercedes me connect system is malfunctioning. ► Observe the notes on the diagnostics connection (→ page 26). ► Visit a qualified specialist workshop.
 Inoperative	* At least one of the main functions of the Mercedes me connect system or of the SOS emergency call system is malfunctioning. ► Visit a qualified specialist workshop.

### Driving systems

Display messages	Possible causes/consequences and ► Solutions
 ATTENTION ASSIST: Take a Break!	* ATTENTION ASSIST has detected fatigue or an increasing lack of concentration on the part of the driver (→ page 198). ► If necessary, take a break.

#### 474 Display messages and warning/indicator lamps





Display messages	Possible causes/consequences and ► Solutions
 <p>ATTENTION ASSIST Inoperative</p>	<ul style="list-style-type: none"> <li>* ATTENTION ASSIST is malfunctioning.               <ul style="list-style-type: none"> <li>► Visit a qualified specialist workshop.</li> </ul> </li> </ul>
<p>Malfunction Drive at Max. 50 mph</p>	<ul style="list-style-type: none"> <li>* The adjustable damping is malfunctioning. The vehicle's handling characteristics may be affected.               <ul style="list-style-type: none"> <li>► Do not drive at speeds greater than 50 mph (80 km/h).</li> <li>► Visit a qualified specialist workshop.</li> </ul> </li> </ul>
<p>Active Steering Assist Currently Unavailable See Operator's Manual</p>	<ul style="list-style-type: none"> <li>* Active Steering Assist is temporarily unavailable. The ambient conditions are outside the system limits (→ page 175).               <ul style="list-style-type: none"> <li>► Drive on. As soon as the ambient conditions are within the system limits, the system will become available again.</li> <li>► If necessary, clean the windshield in the camera's field of vision.</li> <li>► Check the tire pressure if necessary.</li> </ul> </li> </ul>
<p>Active Steering Assist Inoperative</p>	<ul style="list-style-type: none"> <li>* Active Steering Assist is malfunctioning. Active Distance Assist DISTRONIC remains available.               <ul style="list-style-type: none"> <li>► Visit a qualified specialist workshop.</li> </ul> </li> </ul>
	<ul style="list-style-type: none"> <li>* Active Steering Assist has reached the system limits (→ page 175). You have not steered independently for a considerable period of time.</li> </ul>



Display messages	Possible causes/consequences and ► Solutions
Beginning Emergency Stop	<p>► Take over the steering and drive on in accordance with the traffic conditions.</p> <p>* Your hands are not on the steering wheel. Emergency stop is initiated (→ page 177).</p> <p>► Put your hands back on the steering wheel.</p> <p>You can cancel the deceleration at any time by performing one of the following actions:</p> <ul style="list-style-type: none"> <li>• Steering</li> <li>• Braking or accelerating</li> <li>• Pressing a steering wheel button</li> <li>• Operating Touch Control</li> <li>• Deactivating Active Distance Assist DISTRONIC</li> </ul>
Active Steering Asst. Currently Unavailable Due to Multiple Emergency Stops	<p>* Active Steering Assist is temporarily unavailable due to multiple emergency stops.</p> <p>► Take over the steering and stop in accordance with the traffic conditions.</p> <p>► Switch off the ignition and turn it back on. Active Steering Assist is available once more.</p>
Active Lane Keeping Assist Currently Unavailable See Operator's Manual	<p>* Active Lane Keeping Assist is temporarily unavailable.</p> <p>The ambient conditions are outside the system limits (→ page 205).</p> <p>► Drive on. As soon as the ambient conditions are within the system limits, the system will become available again.</p>



## 476 Display messages and warning/indicator lamps

Display messages	Possible causes/consequences and ► Solutions
Active Lane Keeping Assist Inoperative	<ul style="list-style-type: none"> <li>* Active Lane Keeping Assist is malfunctioning.               <ul style="list-style-type: none"> <li>► Visit a qualified specialist workshop.</li> </ul> </li> </ul>
Blind Spot Assist Currently Unavailable See Operator's Manual	<ul style="list-style-type: none"> <li>* Blind Spot Assist is temporarily unavailable. The system limits have been reached (→ page 202).               <ul style="list-style-type: none"> <li>► Drive on. Once the cause of the problem is no longer present, the system will be available again.</li> <li>or</li> <li>► If the display message does not disappear, stop the vehicle in accordance with the traffic conditions and restart the engine.</li> </ul> </li> </ul>
Blind Spot Assist Inoperative	<ul style="list-style-type: none"> <li>* Blind Spot Assist is malfunctioning.               <ul style="list-style-type: none"> <li>► Visit a qualified specialist workshop.</li> </ul> </li> </ul>
Blind Spot Assist Not Available When Towing a Trailer See Operator's Manual	<ul style="list-style-type: none"> <li>* When you establish the electrical connection to the trailer, Blind Spot Assist is unavailable.               <ul style="list-style-type: none"> <li>► Press the left-hand Touch Control and acknowledge the display message.</li> </ul> </li> </ul>
Active Blind Spot Assist Currently Unavailable See Operator's Manual	<ul style="list-style-type: none"> <li>* Active Blind Spot Assist is temporarily unavailable. The system limits have been reached (→ page 202).               <ul style="list-style-type: none"> <li>► Drive on. Once the cause of the problem is no longer present, the system will be available again.</li> <li>or</li> </ul> </li> </ul>

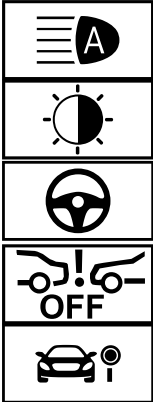
Display messages	Possible causes/consequences and ► Solutions
	<ul style="list-style-type: none"> <li>► If the display message does not disappear, stop the vehicle in accordance with the traffic conditions and restart the engine.</li> </ul>
Active Blind Spot Assist Inoperative	<ul style="list-style-type: none"> <li>* Active Blind Spot Assist is malfunctioning.               <ul style="list-style-type: none"> <li>► Visit a qualified specialist workshop.</li> </ul> </li> </ul>
Active Blind Spot Asst. Not Available When Towing a Trailer See Operator's Manual	<ul style="list-style-type: none"> <li>* When you establish the electrical connection to the trailer, Active Blind Spot Assist is unavailable.               <ul style="list-style-type: none"> <li>► Press the left-hand Touch Control and acknowledge the display message.</li> </ul> </li> </ul>
Active Parking Assist and PARKTRONIC Inoperative See Operator's Manual	<ul style="list-style-type: none"> <li>* Active Parking Assist and Parking Assist PARKTRONIC are malfunctioning.               <ul style="list-style-type: none"> <li>► Stop the vehicle, paying attention to road and traffic conditions, and restart the engine.</li> <li>► If the display message continues to be displayed, consult a qualified specialist workshop.</li> </ul> </li> </ul>
Traffic Sign Assist Currently Unavailable See Operator's Manual	<ul style="list-style-type: none"> <li>* Traffic Sign Assist is temporarily unavailable.               <ul style="list-style-type: none"> <li>► Drive on.</li> <li>Once the cause of the problem is no longer present, the system will be available again.</li> </ul> </li> </ul>
Traffic Sign Assist Inoperative	<ul style="list-style-type: none"> <li>* Traffic Sign Assist is malfunctioning.               <ul style="list-style-type: none"> <li>► Visit a qualified specialist workshop.</li> </ul> </li> </ul>

Display messages	Possible causes/consequences and ► Solutions
 <p data-bbox="144 342 408 391">Please Check Direction of Travel</p>	<p data-bbox="473 249 1036 272">* You have turned the wrong way onto a one-way street.</p> <ul style="list-style-type: none"> <li data-bbox="495 285 820 308">► Check the direction of travel.</li> <li data-bbox="495 319 1197 341">► Turn as soon as possible, in accordance with the traffic conditions.</li> </ul>
    <p data-bbox="144 757 362 806">Currently Unavailable Radar Sensors Dirty</p>	<p data-bbox="473 412 1134 435">* The radar sensor system is malfunctioning. Possible causes are:</p> <ul style="list-style-type: none"> <li data-bbox="500 446 722 469">• dirt on the sensors</li> <li data-bbox="500 479 722 502">• heavy rain or snow</li> <li data-bbox="500 512 1169 535">• extended country driving without other traffic, e.g. in the desert</li> </ul> <p data-bbox="495 557 1428 580">Driving systems and driving safety systems may be malfunctioning or temporarily unavailable.</p> <p data-bbox="495 590 1609 640">Once the cause of the problem is no longer present, driving systems and driving safety systems will be available again.</p> <p data-bbox="495 650 924 673">If the display message does not disappear:</p> <ul style="list-style-type: none"> <li data-bbox="495 683 1567 706">► Pull over and stop the vehicle safely as soon as possible, paying attention to road and traffic conditions.</li> <li data-bbox="495 716 855 739">► Clean all sensors (→ page 391).</li> <li data-bbox="495 750 722 772">► Restart the engine.</li> </ul>

Display messages	Possible causes/consequences and ► Solutions
 <p data-bbox="195 681 473 731">Currently Unavailable Camera View Restricted</p>	<p data-bbox="524 249 1055 272">* The camera view is restricted. Possible causes are:</p> <ul data-bbox="550 283 1123 376" style="list-style-type: none"> <li data-bbox="550 283 1097 306">• dirt on the windshield in the camera's field of vision</li> <li data-bbox="550 318 814 340">• heavy rain, snow or fog</li> <li data-bbox="550 352 1123 376">• condensation on the windshield in front of the camera</li> </ul> <p data-bbox="547 394 1692 444">❗ Condensation detected on the windshield is automatically removed using a built-in heater within approximately 12 minutes.</p> <p data-bbox="543 456 1480 479">Driving systems and driving safety systems may be malfunctioning or temporarily unavailable.</p> <p data-bbox="543 491 1663 540">Once the cause of the problem is no longer present, driving systems and driving safety systems will be available again.</p> <p data-bbox="543 552 972 574">If the display message does not disappear:</p> <ul data-bbox="543 586 1618 645" style="list-style-type: none"> <li data-bbox="543 586 1618 609">► Pull over and stop the vehicle safely as soon as possible, paying attention to road and traffic conditions.</li> <li data-bbox="543 620 922 643">► Clean the windshield if necessary.</li> </ul>
 <p data-bbox="195 842 232 865">Off</p>	<p data-bbox="524 752 1591 774">* The HOLD function is deactivated because the vehicle is skidding or a condition for activation is not met.</p> <ul data-bbox="543 786 1655 809" style="list-style-type: none"> <li data-bbox="543 786 1655 809">► Reactivate the HOLD function later or check the activation conditions for the HOLD function (→ page 179).</li> </ul>

Display messages	Possible causes/consequences and ► Solutions
 <p>--- mph</p>	<ul style="list-style-type: none"> <li>* Active Distance Assist DISTRONIC cannot be activated as not all activation conditions have been fulfilled.                             <ul style="list-style-type: none"> <li>► Comply with the activation conditions of Active Distance Assist DISTRONIC (→ page 172).</li> </ul> </li> </ul>
 <p>Suspended</p>	<ul style="list-style-type: none"> <li>* If you activate the accelerator pedal beyond the Active Distance Assist DISTRONIC setting, the system will be put into passive mode (→ page 177).</li> </ul>
 <p>Off</p>	<ul style="list-style-type: none"> <li>* Active Distance Assist DISTRONIC was deactivated. If a warning tone also sounds, the Active Distance Assist DISTRONIC has deactivated automatically (→ page 172).</li> </ul>
<p>Active Distance Assist Currently Unavailable See Operator's Manual</p>	<ul style="list-style-type: none"> <li>* Active Distance Assist DISTRONIC is temporarily unavailable. The ambient conditions are outside the system limits (→ page 170).                             <ul style="list-style-type: none"> <li>► Drive on. As soon as the ambient conditions are within the system limits, the system will become available again.</li> </ul> </li> </ul>
<p>Active Distance Assist Inoperative</p>	<ul style="list-style-type: none"> <li>* Active Distance Assist DISTRONIC is malfunctioning. Other driving systems and driving safety systems may also malfunction.                             <ul style="list-style-type: none"> <li>► Visit a qualified specialist workshop.</li> </ul> </li> </ul>





Display messages	Possible causes/consequences and ► Solutions
Active Distance Assist Now Available	* Active Distance Assist DISTRONIC is operational again and can be activated (→ page 172).
 --- mph	* Cruise control cannot be activated as not all activation conditions are fulfilled. ► Observe the activation conditions for cruise control (→ page 169).
Cruise Control Inoperative	* Cruise control is malfunctioning. ► Visit a qualified specialist workshop.
Cruise Control Off	* Cruise control has been deactivated. If there is an additional warning tone, cruise control has been deactivated automatically (→ page 168).

## Engine

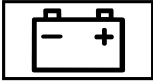
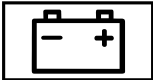

Display messages	Possible causes/consequences and ► Solutions
 Coolant Too Hot Stop Vehicle Turn Engine Off	* The coolant is too hot. ► Pull over and stop the vehicle safely and switch off the engine, paying attention to road and traffic conditions.

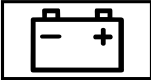
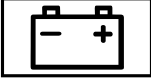

Display messages	Possible causes/consequences and ► Solutions
	<div data-bbox="500 249 1644 427" style="border: 1px solid gray; padding: 5px;"> <p><b>▲ WARNING</b> Danger of burns when opening the hood</p> <p>If you open the hood when the engine has overheated or during a fire in the engine compartment, you could come into contact with hot gases or other escaping operating fluids.</p> <ul style="list-style-type: none"> <li>▶ Before opening the hood, allow the engine to cool down.</li> <li>▶ In the event of a fire in the engine compartment, keep the hood closed and call the fire service.</li> </ul> </div> <ul style="list-style-type: none"> <li>▶ Wait until the engine has cooled down.</li> <li>▶ Make sure that the air supply to the radiator is not obstructed.</li> <li>▶ Avoiding high loads on the engine, drive to the nearest qualified specialist workshop. In doing so, ensure that the coolant temperature display remains below the red marking.</li> </ul>
<p>Check Coolant Level See Operator's Manual</p>	<p>* The coolant level is too low.</p> <div data-bbox="500 622 1644 710" style="border: 1px solid gray; padding: 5px;"> <p><b>! NOTE</b> Engine damage due to insufficient coolant</p> <ul style="list-style-type: none"> <li>▶ Avoid long journeys with insufficient coolant.</li> </ul> </div> <ul style="list-style-type: none"> <li>▶ Add coolant (→ page 384).</li> </ul>
	<p>* The fan motor is defective.</p> <ul style="list-style-type: none"> <li>▶ Avoiding high loads on the engine, drive to the nearest qualified specialist workshop. In doing so, ensure that the coolant temperature display remains below the red marking.</li> </ul>

Display messages	Possible causes/consequences and ► Solutions
 <p data-bbox="195 343 428 367">See Operator's Manual</p>	<p data-bbox="526 250 877 274">* The battery is not being charged.</p> <div data-bbox="563 295 1696 336" style="border: 1px solid black; padding: 5px;"> <p data-bbox="569 302 1142 326"><b>!</b> <b>NOTE</b> Possible engine damage if you continue driving</p> <ul data-bbox="563 343 1099 404" style="list-style-type: none"> <li data-bbox="563 343 1099 367">► Do not continue driving under any circumstances.</li> <li data-bbox="563 378 1099 404">► Consult a qualified specialist workshop.</li> </ul> </div> <ul data-bbox="545 429 1672 486" style="list-style-type: none"> <li data-bbox="545 429 1672 455">► Pull over and stop the vehicle safely and switch off the engine, paying attention to road and traffic conditions.</li> <li data-bbox="545 461 979 486">► Consult a qualified specialist workshop.</li> </ul>
 <p data-bbox="195 597 443 647">Stop Vehicle See Operator's Manual</p>	<p data-bbox="526 504 1321 528">* The battery is no longer being charged and the battery charge level is too low.</p> <div data-bbox="563 549 1696 590" style="border: 1px solid black; padding: 5px;"> <p data-bbox="569 556 1142 580"><b>!</b> <b>NOTE</b> Possible engine damage if you continue driving</p> <ul data-bbox="563 597 1099 657" style="list-style-type: none"> <li data-bbox="563 597 1099 621">► Do not continue driving under any circumstances.</li> <li data-bbox="563 626 1099 657">► Consult a qualified specialist workshop.</li> </ul> </div> <ul data-bbox="545 683 1690 802" style="list-style-type: none"> <li data-bbox="545 683 1690 735">► Pull over and stop the vehicle safely as soon as possible, paying attention to road and traffic conditions. Do not continue driving under any circumstances.</li> <li data-bbox="545 740 803 766">► Switch off the engine.</li> <li data-bbox="545 771 979 802">► Consult a qualified specialist workshop.</li> </ul>

Display messages	Possible causes/consequences and ► Solutions
 <p data-bbox="144 342 391 391">12 V Battery See Operator's Manual</p>	<ul style="list-style-type: none"> <li data-bbox="476 249 1055 272">* The engine is off and the battery charge level is too low.                             <ul style="list-style-type: none"> <li data-bbox="495 283 1064 306">► Switch off electrical consumers that are not required.</li> <li data-bbox="495 318 1264 366">► Leave the engine running for a few minutes, or drive for a longer distance. The battery will charge.</li> </ul> </li> <li data-bbox="495 370 1578 393">If the message appears while the engine is running, this indicates an on-board electrical system malfunction.</li> <li data-bbox="495 405 894 427">► Visit a qualified specialist workshop.</li> </ul>
 <p data-bbox="144 542 413 591">Stop Vehicle Leave Engine Running</p>	<ul style="list-style-type: none"> <li data-bbox="476 449 842 472">* The battery charge level is too low.                             <ul style="list-style-type: none"> <li data-bbox="495 483 1641 532">► Pull over and stop the vehicle safely as soon as possible, paying attention to road and traffic conditions. Do not continue driving under any circumstances.</li> <li data-bbox="495 543 790 566">► Leave the engine running.</li> <li data-bbox="495 578 1153 600">► Wait until the display message disappears before pulling away.</li> </ul> </li> </ul>
 <p data-bbox="144 711 297 734">Fuel Level Low</p>	<ul style="list-style-type: none"> <li data-bbox="476 618 1009 641">* The fuel supply has dropped into the reserve range.                             <ul style="list-style-type: none"> <li data-bbox="495 652 598 675">► Refuel.</li> </ul> </li> </ul>
 <p data-bbox="144 846 297 869">Gas Cap Loose</p>	<ul style="list-style-type: none"> <li data-bbox="476 753 1591 801">* There has been pressure loss in the fuel system. The fuel filler cap is not closed correctly or the fuel system is leaking.                             <ul style="list-style-type: none"> <li data-bbox="495 813 768 836">► Close the fuel filler cap.</li> <li data-bbox="495 847 1448 870">► <b>If the fuel filler cap was already properly closed:</b> consult a qualified specialist workshop.</li> </ul> </li> </ul>

## Engine oil

Display messages	Possible causes/consequences and ► Solutions
 <p data-bbox="195 408 426 456">Check Engine Oil Level (Add 1 quart)</p>	<p data-bbox="524 314 1092 373">* Display message only for certain engines: The engine oil level has dropped to the minimum level.</p> <div data-bbox="561 394 1696 433" style="border: 1px solid gray; padding: 2px;"> <p data-bbox="569 401 1273 425">! <b>NOTE</b> Engine damage caused by driving with insufficient engine oil</p> </div> <div data-bbox="561 439 1696 477" style="border: 1px solid gray; padding: 2px;"> <p data-bbox="569 443 1068 467">► Avoid long journeys with insufficient engine oil.</p> </div> <p data-bbox="543 493 1045 519">► When next refueling, add 1 quart of engine oil.</p> <p data-bbox="543 534 842 560">Add engine oil (→ page 383).</p> <p data-bbox="543 570 894 596">Notes on engine oil (→ page 453).</p>
 <p data-bbox="195 708 458 757">Engine Oil Level Low Stop Vehicle Turn Engine Off</p>	<p data-bbox="524 615 962 674">* Display message only for certain engines: The engine oil level is too low.</p> <div data-bbox="561 689 1696 728" style="border: 1px solid gray; padding: 2px;"> <p data-bbox="569 697 1273 721">! <b>NOTE</b> Engine damage caused by driving with insufficient engine oil</p> </div> <div data-bbox="561 734 1696 772" style="border: 1px solid gray; padding: 2px;"> <p data-bbox="569 738 1068 762">► Avoid long journeys with insufficient engine oil.</p> </div> <p data-bbox="543 788 1692 845">► Pull over and stop the vehicle safely as soon as possible, paying attention to road and traffic conditions. Do not continue driving under any circumstances.</p> <p data-bbox="543 850 802 876">► Switch off the engine.</p>

Display messages	Possible causes/consequences and ► Solutions
	<ul style="list-style-type: none"> <li>► Add 1.1 US qt (1 l) engine oil.</li> <li>► Check the engine oil level.</li> </ul> <p>Add engine oil (→ page 383). Notes on engine oil (→ page 453).</p>
 <p>Engine Oil Reduce Oil Level</p>	<p>* Display message only for certain engines: The engine oil level is too high.</p> <div style="border: 1px solid black; padding: 5px; margin: 5px 0;"> <p><b>!</b> <b>NOTE</b> Engine damage caused by driving with excess engine oil</p> </div> <ul style="list-style-type: none"> <li>► Avoid long journeys with excess engine oil.</li> </ul> <p>► Consult a qualified specialist workshop immediately and have the engine oil siphoned off.</p>
 <p>Engine Oil Pressure Stop Switch Off Engine</p>	<p>* Display message only for certain engines: The engine oil pressure is too low.</p> <div style="border: 1px solid black; padding: 5px; margin: 5px 0;"> <p><b>!</b> <b>NOTE</b> Engine damage caused by driving with insufficient engine oil pressure</p> </div> <ul style="list-style-type: none"> <li>► Avoid driving with insufficient engine oil pressure.</li> </ul> <p>► Pull over and stop the vehicle safely as soon as possible, paying attention to road and traffic conditions. Do not continue driving under any circumstances.</p>

Display messages	Possible causes/consequences and ► Solutions
 <p data-bbox="195 384 469 433">Engine Oil Level Cannot Be Measured</p>	<ul style="list-style-type: none"> <li data-bbox="543 249 975 275">► Consult a qualified specialist workshop.</li> <li data-bbox="524 291 1541 317">* The electrical connection to the oil level sensor has been interrupted or the oil level sensor is faulty.</li> <li data-bbox="543 327 944 353">► Visit a qualified specialist workshop.</li> </ul>

### Transmission

Display messages	Possible causes/consequences and ► Solutions
<p data-bbox="195 584 450 630">Apply Brake to Shift from 'P'</p>	<ul style="list-style-type: none"> <li data-bbox="524 576 1578 601">* You have attempted to shift the transmission out of position <b>P</b> and into another transmission position.</li> <li data-bbox="543 612 833 638">► Depress the brake pedal.</li> <li data-bbox="543 648 1060 674">► Shift the transmission to position <b>R</b>, <b>N</b> or <b>D</b>.</li> </ul>
<p data-bbox="195 697 445 774">To Deselect P or N, Depress Brake and Start Engine</p>	<ul style="list-style-type: none"> <li data-bbox="524 688 1596 714">* You have attempted to shift the transmission out of position <b>P</b> or <b>N</b> into another transmission position.</li> <li data-bbox="543 725 833 751">► Depress the brake pedal.</li> <li data-bbox="543 761 750 787">► Start the engine.</li> </ul>
<p data-bbox="195 810 463 887">Driver's Door Open &amp; Transmission Not in P Risk of Vehicle Rolling Away</p>	<ul style="list-style-type: none"> <li data-bbox="524 800 1393 826">* The driver's door is not fully closed and the transmission is in position <b>R</b>, <b>N</b> or <b>D</b>.</li> <li data-bbox="543 837 1221 862">► Shift the transmission to position <b>P</b> when you park the vehicle.</li> </ul>

## 488 Display messages and warning/indicator lamps

Display messages	Possible causes/consequences and ► Solutions
N Permanently Active Risk of Rolling Away	<ul style="list-style-type: none"><li>* While the vehicle is rolling or while you are driving, the transmission has been shifted to position <b>N</b>.<ul style="list-style-type: none"><li>► Depress the brake pedal to stop and, when the vehicle is stationary, shift the transmission to position <b>P</b>.</li><li>► To continue your journey, shift the transmission to position <b>D</b> or <b>R</b>.</li></ul></li></ul>
Only Shift to 'P' when Vehicle is Stationary	<ul style="list-style-type: none"><li>* The transmission can only be shifted to position <b>P</b> when the vehicle is stationary.</li></ul>
Apply Brake to Shift to 'R'	<ul style="list-style-type: none"><li>* You have tried to switch to transmission position <b>R</b>.<ul style="list-style-type: none"><li>► Depress the brake pedal.</li><li>► Shift the transmission to position <b>R</b>.</li></ul></li></ul>
Service Required Do Not Shift Gears Visit Dealer	<ul style="list-style-type: none"><li>* The transmission is malfunctioning. The transmission position can no longer be shifted.<ul style="list-style-type: none"><li>► When the transmission is in position <b>D</b>, consult a qualified specialist workshop and do not change the transmission position.</li><li>► For all other transmission positions, park the vehicle safely.</li><li>► Consult a qualified specialist workshop or breakdown service.</li></ul></li></ul>
Reversing Not Possible Service Required	<ul style="list-style-type: none"><li>* The transmission is malfunctioning. The transmission position <b>R</b> cannot be engaged.<ul style="list-style-type: none"><li>► Visit a qualified specialist workshop.</li></ul></li></ul>
Transmission Malfunction Stop	<ul style="list-style-type: none"><li>* The transmission is malfunctioning. The transmission shifts to position <b>N</b> automatically.<ul style="list-style-type: none"><li>► Pull over and stop the vehicle safely as soon as possible, paying attention to road and traffic conditions.</li></ul></li></ul>



Display messages	Possible causes/consequences and ► Solutions
	<ul style="list-style-type: none"> <li>► Switch the transmission to position <b>P</b>.</li> <li>► Consult a qualified specialist workshop.</li> </ul>
Auxiliary Battery Malfunction	<ul style="list-style-type: none"> <li>* The auxiliary battery for the transmission is no longer being charged.</li> <li>► Visit a qualified specialist workshop.</li> <li>► Until then, manually set the transmission to position <b>P</b> before you switch off the engine.</li> <li>► Before leaving the vehicle, apply the electric parking brake.</li> </ul>
Transmission Malfunction	<ul style="list-style-type: none"> <li>* The transmission is malfunctioning. The cause could be an overheated clutch or blocked gears.</li> <li>► Let the transmission cool down.</li> <li>► If the display message still appears following a restart, consult a qualified specialist workshop.</li> </ul>
Trans. Oil Overheated Drive on with Care	<ul style="list-style-type: none"> <li>* The transmission is overheating. When the display message is active, start-up and driving characteristics may be temporarily impaired.</li> <li>► Drive at low speeds.</li> <li>► Avoid sporty driving.</li> <li>► Before starting up on uphill gradients, let the transmission cool down until the display message disappears.</li> </ul>
Parking Lock Malfunc. Apply Parking Brake	<ul style="list-style-type: none"> <li>* The transmission is malfunctioning. The transmission position <b>P</b> cannot be engaged.</li> <li>► Park the vehicle safely.</li> <li>► Use the electric parking brake to secure the vehicle against rolling away.</li> </ul>

## 490 Display messages and warning/indicator lamps



Display messages	Possible causes/consequences and ► Solutions
<p>Teaching in Transmission Operate Selector Lever Apply Brake for XX s Risk of Vehicle Rolling Away</p>	<ul style="list-style-type: none"><li>* The transmission is being taught in. There is a risk of the vehicle rolling away.<ul style="list-style-type: none"><li>► Depress and hold the brake pedal until the teach-in procedure has been completed. The electric parking brake is applied automatically during the teach-in procedure.</li><li>► Switch on the ignition.</li><li>► Select transmission position <b>P</b>, <b>R</b> or <b>N</b>.</li></ul></li></ul>
<p>Apply Parking Brake Risk of Rolling Away See Operator's Manual</p>	<ul style="list-style-type: none"><li>* The transmission position cannot be identified securely.<ul style="list-style-type: none"><li>► Use the electric parking brake to secure the vehicle against rolling away.</li></ul></li></ul>
<p>Teaching in Transmission Complete</p>	<ul style="list-style-type: none"><li>* The transmission's teach-in process is complete. All transmission positions can be engaged again.</li></ul>
<p>Transmission Malfunction Service Required</p>	<ul style="list-style-type: none"><li>* The transmission is malfunctioning. Visit a qualified specialist workshop.</li></ul>
 <p>Before Starting the Engine, Turn Steering Wheel</p>	<ul style="list-style-type: none"><li>* The electric steering lock has not unlocked the steering.<ul style="list-style-type: none"><li>► Switch the ignition off.</li><li>► To unlock the steering, move the steering wheel slightly to the left and right.</li><li>► Switch the ignition back on.</li></ul></li></ul>



Display messages	Possible causes/consequences and ► Solutions
<div data-bbox="205 252 362 334" data-label="Image"> </div> <p data-bbox="195 344 452 394">Steering Malfunction See Operator's Manual</p>	<p data-bbox="526 249 1548 275">* The electric steering lock is malfunctioning. The steering may be locked by the electric steering lock.</p> <div data-bbox="547 291 1696 472" data-label="Complex-Block" style="border: 1px solid gray; padding: 5px;"> <p data-bbox="565 301 1204 327">▲ <b>WARNING</b> Risk of accident if steering capability is impaired</p> <p data-bbox="565 339 1461 365">If the steering does not function as intended, the vehicle's operating safety is jeopardized.</p> <ul style="list-style-type: none"> <li data-bbox="565 376 1633 425">▶ Pull over and stop the vehicle safely as soon as possible, paying attention to road and traffic conditions. Do not continue driving under any circumstances.</li> <li data-bbox="565 436 994 462">▶ Consult a qualified specialist workshop.</li> </ul> </div> <ul style="list-style-type: none"> <li data-bbox="547 487 1692 539">▶ Pull over and stop the vehicle safely as soon as possible, paying attention to road and traffic conditions. Do not continue driving under any circumstances.</li> <li data-bbox="547 550 975 576">▶ Consult a qualified specialist workshop.</li> </ul>



## Tires

Display messages	Possible causes/consequences and ► Solutions
<p data-bbox="195 723 456 749">Check Tire Pressure Soon</p>	<p data-bbox="526 717 1356 774">* Canada only: The tire pressure loss warning system has detected a significant loss in pressure.</p>

Display messages	Possible causes/consequences and ► Solutions
	<div style="background-color: #f0f0f0; padding: 5px; border: 1px solid #ccc;"> <p><b>▲ WARNING</b> Risk of an accident due to insufficient tire pressure</p> <p>Tire pressures that are too low pose the following hazards:</p> <ul style="list-style-type: none"> <li>• The tires may burst, especially as the load and vehicle speed increase.</li> <li>• The tires may wear excessively and/or unevenly, which may greatly impair tire traction.</li> <li>• The driving characteristics, as well as steering and braking, may be greatly impaired.</li> </ul> <p>You could then lose control of the vehicle.</p> <ul style="list-style-type: none"> <li>► Observe the recommended tire pressure.</li> <li>► Adjust the tire pressure if necessary.</li> </ul> </div> <ul style="list-style-type: none"> <li>► Stop the vehicle, paying attention to road and traffic conditions.</li> <li>► Check the tire pressure (→ page 419) and the tires.</li> <li>► When the tire pressure is correct, restart the tire pressure loss warning system (→ page 425).</li> </ul>
<p>Check Tire Pressure Then Restart Run Flat Indicator</p>	<p>* Canada only: The tire pressure loss warning system generated a display message and has not been restarted since.</p> <ul style="list-style-type: none"> <li>► When the tire pressure is correct, restart the tire pressure loss warning system (→ page 425).</li> </ul>
<p>Run Flat Indicator Inoperative</p>	<p>* Canada only: The tire pressure loss warning system is malfunctioning.</p> <ul style="list-style-type: none"> <li>► Visit a qualified specialist workshop.</li> </ul>

Display messages	Possible causes/consequences and ► Solutions
 <p data-bbox="195 342 439 391">Tire Press. Monitor Currently Unavailable</p>	<ul style="list-style-type: none"> <li>* There is interference from a powerful radio signal source. As a result, no signals from the tire pressure sensors are received. The tire pressure monitoring system is temporarily unavailable.               <ul style="list-style-type: none"> <li>► Drive on.</li> <li>► The tire pressure monitoring system restarts automatically as soon as the cause has been rectified.</li> </ul> </li> </ul>
 <p data-bbox="195 505 476 554">Tire Press. Monitor Inoperative</p>	<ul style="list-style-type: none"> <li>* The tire pressure monitoring system is faulty.               <div style="border: 1px solid gray; padding: 5px; margin-top: 10px;"> <p><b>▲ WARNING</b> There is a risk of an accident if the tire pressure monitoring system is malfunctioning</p> <p>If the tire pressure monitoring system is malfunctioning, it is not able to issue a warning if there is pressure loss in one or more of the tires.</p> <p>Underinflated tires may, for example, impair the driving, steering and braking characteristics.</p> <ul style="list-style-type: none"> <li>► Have the tire pressure monitoring system checked at a qualified specialist workshop.</li> </ul> </div> <ul style="list-style-type: none"> <li>► Visit a qualified specialist workshop.</li> </ul> </li> </ul>
 <p data-bbox="195 785 469 833">Tire Pressure Monitor Inoperative No Wheel Sensors</p>	<ul style="list-style-type: none"> <li>* The wheels installed do not have suitable tire pressure sensors. The tire pressure monitoring system is deactivated.               <ul style="list-style-type: none"> <li>► Install wheels with suitable tire pressure sensors.</li> </ul> </li> </ul>

Display messages	Possible causes/consequences and ► Solutions
 <p>Wheel Sensor(s) Missing</p>	<p>* There is no signal from the tire pressure sensor of one or more wheels. The pressure of the affected tire is not displayed.</p> <ul style="list-style-type: none"> <li>► Have the faulty tire pressure sensor replaced at a qualified specialist workshop.</li> </ul>
 <p>Check Tires</p>	<p>* The tire pressure in one or more tires has dropped significantly. The wheel position is displayed.</p> <div style="background-color: #f0f0f0; padding: 5px; border: 1px solid #ccc;"> <p><b>⚠ WARNING</b> Risk of an accident due to insufficient tire pressure</p> <p>Tire pressures that are too low pose the following hazards:</p> <ul style="list-style-type: none"> <li>• The tires may burst, especially as the load and vehicle speed increase.</li> <li>• The tires may wear excessively and/or unevenly, which may greatly impair tire traction.</li> <li>• The driving characteristics, as well as steering and braking, may be greatly impaired.</li> </ul> <p>You could then lose control of the vehicle.</p> <ul style="list-style-type: none"> <li>► Observe the recommended tire pressure.</li> <li>► Adjust the tire pressure if necessary.</li> </ul> </div> <ul style="list-style-type: none"> <li>► Stop the vehicle, paying attention to road and traffic conditions.</li> <li>► Check the tire pressure (→ page 419) and the tires.</li> </ul>

Display messages	Possible causes/consequences and ► Solutions
 <p data-bbox="195 344 445 391">Please Correct Tire Pressure</p>	<p data-bbox="524 249 1652 301">* The tire pressure is too low in at least one of the tires or the tire pressure difference between the wheels is too great.</p> <ul style="list-style-type: none"> <li data-bbox="543 311 1068 335">► Check the tire pressure and add air, if necessary.</li> <li data-bbox="543 346 1504 369">► When the tire pressure is correct, restart the tire pressure monitoring system (→ page 424).</li> </ul>
 <p data-bbox="195 503 445 527">Warning Tire Malfunction</p>	<p data-bbox="524 412 1471 436">* The tire pressure in one or more tires has dropped suddenly. The wheel position is displayed.</p> <div data-bbox="561 453 1696 491" style="background-color: #e0e0e0; padding: 5px;"> <p data-bbox="565 462 1179 485">▲ <b>WARNING</b> Risk of an accident from driving with a flat tire</p> </div> <p data-bbox="561 503 1018 527">Flat tires are dangerous in the following ways:</p> <ul style="list-style-type: none"> <li data-bbox="569 539 990 563">• The tires can overheat and cause a fire.</li> <li data-bbox="569 573 1437 597">• The driving characteristics, as well as steering and braking, may be greatly impaired.</li> </ul> <p data-bbox="561 614 981 638">You could then lose control of the vehicle.</p> <ul style="list-style-type: none"> <li data-bbox="561 650 870 674">► Do not drive with a flat tire.</li> <li data-bbox="561 684 907 708">► Observe the notes on flat tires.</li> </ul> <p data-bbox="543 733 875 757">Notes on flat tires (→ page 397).</p> <ul style="list-style-type: none"> <li data-bbox="543 769 1215 793">► Stop the vehicle, paying attention to road and traffic conditions.</li> <li data-bbox="543 803 735 827">► Check the tires.</li> </ul>

## 496 Display messages and warning/indicator lamps

Display messages	Possible causes/consequences and ► Solutions
Tires Overheated	<ul style="list-style-type: none"><li>* At least one tire is overheating. The affected tires are displayed in red. At temperatures close to the limit value, the tires are displayed in yellow.<ul style="list-style-type: none"><li>► Drive more slowly.</li></ul></li></ul>
Decrease Speed	<ul style="list-style-type: none"><li>* At least one tire is overheating. The affected tires are displayed in red. At temperatures close to the limit value, the tires are displayed in yellow.<div data-bbox="495 419 1646 536" style="border: 1px solid black; padding: 5px;"><p><b>▲ WARNING</b> Risk of an accident from driving with overheated tires Overheated tires may burst, particularly at high speeds.</p><ul style="list-style-type: none"><li>► Reduce speed so that the tires cool down.</li></ul></div></li><li>► Reduce speed so that the tires cool down.</li></ul>

## SmartKey

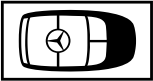
Display messages	Possible causes/consequences and ► Solutions
 Obtain a New Key	<ul style="list-style-type: none"><li>* The SmartKey needs to be replaced.<ul style="list-style-type: none"><li>► Visit a qualified specialist workshop.</li></ul></li></ul>



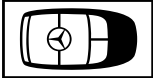
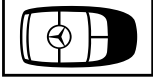
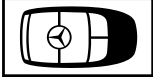

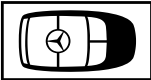
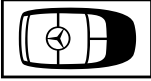
Display messages	Possible causes/consequences and ► Solutions
 <p data-bbox="195 342 399 368">Replace Key Battery</p>	<p data-bbox="519 249 907 275">* The SmartKey battery is discharged.</p> <ul style="list-style-type: none"> <li data-bbox="543 283 916 309">► Replace the battery (→ page 66).</li> </ul>
 <p data-bbox="195 477 450 524">Key Not Detected (white display message)</p>	<p data-bbox="519 384 925 410">* The SmartKey is currently undetected.</p> <ul style="list-style-type: none"> <li data-bbox="543 418 1092 444">► Change the location of the SmartKey in the vehicle.</li> <li data-bbox="543 452 1554 499">► If the SmartKey is still not recognized, place it in the marked space for starting with the SmartKey (→ page 130).</li> </ul>
 <p data-bbox="195 638 469 684">Key Not Detected (red display message)</p>	<p data-bbox="519 544 1249 601">* The SmartKey cannot be detected and may no longer be in the vehicle. The SmartKey is no longer in the vehicle and you switch off the engine:</p> <ul style="list-style-type: none"> <li data-bbox="543 615 931 641">• You can no longer start the engine.</li> <li data-bbox="543 649 949 675">• You cannot centrally lock the vehicle.</li> </ul> <p data-bbox="543 687 1005 713">► Ensure that the SmartKey is in the vehicle.</p> <p data-bbox="543 739 1430 765">If the SmartKey detection function has a malfunction due to a strong radio signal source:</p> <ul style="list-style-type: none"> <li data-bbox="543 773 1615 799">► Pull over and stop the vehicle safely as soon as possible, paying attention to road and traffic conditions.</li> <li data-bbox="543 808 1554 833">► Place the SmartKey in the marked space for starting the engine with the SmartKey (→ page 130).</li> </ul>



Display messages	Possible causes/consequences and ► Solutions
 <p data-bbox="144 342 413 415">Place the Key in the Marked Space See Operator's Manual</p>	<ul style="list-style-type: none"> <li>* The SmartKey detection function is malfunctioning.                             <ul style="list-style-type: none"> <li>► Change the location of the SmartKey in the vehicle.</li> <li>► Place the SmartKey in the marked space for starting the engine with the SmartKey (→ page 130).</li> </ul> </li> </ul>
 <p data-bbox="144 532 369 552">Don't Forget Your Key</p>	<ul style="list-style-type: none"> <li>* A warning tone will also sound. This message reminds you to take your SmartKey with you when you leave the vehicle.</li> </ul>

## Vehicle

Display messages	Possible causes/consequences and ► Solutions
 <p data-bbox="144 790 421 862">Vehicle Operational Switch the Ignition Off Before Exiting</p>	<ul style="list-style-type: none"> <li>* You are leaving the vehicle when it is in a ready-to-drive state.                             <ul style="list-style-type: none"> <li>► When you leave the vehicle, switch off the ignition, secure the vehicle against rolling away and take the SmartKey with you.</li> <li>► If you do not leave the vehicle, switch off the electrical consumers, e.g. the seat heater. Otherwise, the 12-V battery may discharge and it will then be possible to start the vehicle only using a donor battery (starting assistance).</li> </ul> </li> </ul>



Display messages	Possible causes/consequences and ► Solutions
 <p data-bbox="195 344 449 418">Steering Malfunction Increased Physical Effort See Operator's Manual</p>	<p data-bbox="524 249 1103 275">* The power assistance for the steering is malfunctioning.</p> <div data-bbox="561 298 1696 443" style="border: 1px solid gray; padding: 5px;"> <p data-bbox="569 303 1297 329"><b>▲ WARNING</b> Risk of an accident due to altered steering characteristics</p> <p data-bbox="565 342 1633 368">If the power assistance of the steering fails partially or completely, you will need to use more force to steer.</p> <ul style="list-style-type: none"> <li data-bbox="565 377 1045 403">▶ If safe steering is possible, drive on carefully.</li> <li data-bbox="565 411 1193 437">▶ Visit or consult a qualified specialist workshop immediately.</li> </ul> </div> <ul style="list-style-type: none"> <li data-bbox="547 464 1027 490">▶ If safe steering is possible, drive on carefully.</li> <li data-bbox="547 498 1175 524">▶ Visit or consult a qualified specialist workshop immediately.</li> </ul>
 <p data-bbox="195 631 460 705">Steering Malfunction Stop Immediately See Operator's Manual</p>	<p data-bbox="524 536 1297 562">* The steering is malfunctioning. Steering capability is considerably impaired.</p> <div data-bbox="561 585 1696 757" style="border: 1px solid gray; padding: 5px;"> <p data-bbox="569 590 1204 616"><b>▲ WARNING</b> Risk of accident if steering capability is impaired</p> <p data-bbox="565 629 1461 655">If the steering does not function as intended, the vehicle's operating safety is jeopardized.</p> <ul style="list-style-type: none"> <li data-bbox="565 664 1633 715">▶ Pull over and stop the vehicle safely as soon as possible, paying attention to road and traffic conditions. Do not continue driving under any circumstances.</li> <li data-bbox="565 724 994 750">▶ Consult a qualified specialist workshop.</li> </ul> </div> <ul style="list-style-type: none"> <li data-bbox="547 777 1692 828">▶ Pull over and stop the vehicle safely as soon as possible, paying attention to road and traffic conditions. Do not continue driving under any circumstances.</li> <li data-bbox="547 837 975 862">▶ Consult a qualified specialist workshop.</li> </ul>

## 500 Display messages and warning/indicator lamps





Display messages	Possible causes/consequences and ► Solutions
	<ul style="list-style-type: none"><li>* At least one door is open.<ul style="list-style-type: none"><li>► Close all doors.</li></ul></li></ul>
	<ul style="list-style-type: none"><li>* The hood is open.<div data-bbox="495 366 1648 519"><p><b>▲ WARNING</b> Risk of accident if the engine hood is unlatched while driving</p><p>An unlocked engine hood may open up when the vehicle is in motion and block your view.</p><ul style="list-style-type: none"><li>► Never unlatch the engine hood while driving.</li><li>► Before every trip, ensure that the engine hood is latched.</li></ul></div><ul style="list-style-type: none"><li>► Stop the vehicle immediately, paying attention to road and traffic conditions.</li><li>► Close the hood.</li></ul></li></ul>
	<ul style="list-style-type: none"><li>* The trunk lid is open.<div data-bbox="495 653 1648 832"><p><b>▲ DANGER</b> Risk of exhaust gas poisoning</p><p>Combustion engines emit poisonous exhaust gases such as carbon monoxide. Exhaust gases can enter the vehicle interior if the trunk lid is open when the engine is running, especially if the vehicle is in motion.</p><ul style="list-style-type: none"><li>► Always switch off the engine before opening the trunk lid.</li><li>► Never drive with the trunk lid open.</li></ul></div><ul style="list-style-type: none"><li>► Close the trunk lid.</li></ul></li></ul>



Display messages	Possible causes/consequences and ► Solutions
 <p data-bbox="195 342 399 366">Check Washer Fluid</p>	<p data-bbox="522 249 1387 273">* The washer fluid level in the washer fluid reservoir has dropped below the minimum.</p> <ul style="list-style-type: none"> <li data-bbox="543 283 901 307">► Add washer fluid (→ page 384).</li> </ul>

## Lights

Display messages	Possible causes/consequences and ► Solutions
 <p data-bbox="195 603 362 655">Check Left Low Beam (Example)</p>	<p data-bbox="522 510 981 534">* The corresponding light source is defective.</p> <ul style="list-style-type: none"> <li data-bbox="543 544 763 568">► Drive on carefully.</li> <li data-bbox="543 579 1073 602">► Visit a qualified specialist workshop immediately.</li> <li data-bbox="543 613 1702 665">ⓘ LED light bulbs: the display message for the corresponding lamp appears only when all the light-emitting diodes in the lamp have failed.</li> </ul>
 <p data-bbox="195 775 436 827">Malfunction See Operator's Manual</p>	<p data-bbox="522 682 837 706">* The exterior lighting is faulty.</p> <ul style="list-style-type: none"> <li data-bbox="543 716 944 740">► Visit a qualified specialist workshop.</li> </ul>

## 502 Display messages and warning/indicator lamps

Display messages	Possible causes/consequences and ► Solutions
 <p data-bbox="144 342 421 391">Automatic Headlamp Mode Inoperative</p>	<ul style="list-style-type: none"><li>* The light sensor is faulty.<ul style="list-style-type: none"><li>► Visit a qualified specialist workshop.</li></ul></li></ul>
 <p data-bbox="144 503 365 526">Switch On Headlamps</p>	<ul style="list-style-type: none"><li>* You are driving without low-beam headlamps.<ul style="list-style-type: none"><li>► Turn the light switch to the  or <b>AUTO</b> position.</li></ul></li></ul>
 <p data-bbox="144 636 317 658">Switch Off Lights</p>	<ul style="list-style-type: none"><li>* You are leaving the vehicle and the lights are still switched on.<ul style="list-style-type: none"><li>► Turn the light switch to the <b>AUTO</b> position.</li></ul></li></ul>
 <p data-bbox="144 768 395 817">Hazard Warning Flashers Malfunctioning</p>	<ul style="list-style-type: none"><li>* The hazard warning lamp switch is faulty.<ul style="list-style-type: none"><li>► Visit a qualified specialist workshop.</li></ul></li></ul>

Display messages	Possible causes/consequences and ► Solutions
 <p data-bbox="195 344 469 391">Intell. Light System Inoperative</p>	<p data-bbox="519 249 1665 301">* The Intelligent Light System is faulty. The lighting system continues to function properly without the functions of the Intelligent Light System.</p> <p data-bbox="543 311 944 337">► Visit a qualified specialist workshop.</p>
 <p data-bbox="195 507 469 554">Active Headlamps Inoperative</p>	<p data-bbox="519 412 870 438">* The active headlamps are faulty.</p> <p data-bbox="543 448 944 474">► Visit a qualified specialist workshop.</p>
<p data-bbox="195 578 462 655">Adaptive Highbeam Assist Currently Unavailable See Operator's Manual</p>	<p data-bbox="519 570 1073 627">* Adaptive Highbeam Assist is temporarily unavailable. The system limits have been reached (→ page 116).</p> <p data-bbox="543 638 1692 715">► Drive on. Once the cause of the problem is no longer present, the system will be available again. The <b>Adaptive Highbeam Assist Now Available</b> display message appears.</p>
<p data-bbox="195 743 462 790">Adaptive Highbeam Assist Inoperative</p>	<p data-bbox="519 736 990 762">* Adaptive Highbeam Assist is malfunctioning.</p> <p data-bbox="543 772 944 798">► Visit a qualified specialist workshop.</p>

## Warning and indicator lamps

### Overview of warning and indicator lamps

Some systems will perform a self-test when the ignition is switched on. Some warning and indicator lamps may briefly light up or flash. This behavior is non-critical. These warning and indicator lamps indicate a malfunction only if they light up or flash after the engine has been started or during a journey.

### Instrument Display (standard)





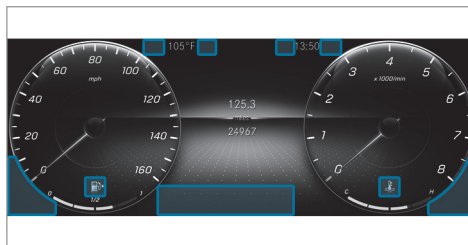



### Widescreen cockpit Instrument Display



Depending on the display setting, the positions of the indicator lamps on the Instrument Display may differ from the example shown.

### Warning and indicator lamps:

-  Low beam(→ page 113)
-  Parking lights(→ page 113)
-  High beam(→ page 114)
-  Turn signal lights(→ page 114)
-  Rear fog light (→ page 113)
-  Restraint system(→ page 505)
-  Seat belt not fastened(→ page 510)



USA: brakes (red) (→ page 505)

Canada: brakes (red) (→ page 505)

Electric parking brake (yellow)  
(→ page 505)

USA: electric parking brake applied  
(red) (→ page 505)

Canada: electric parking brake  
applied (red) (→ page 505)

ABS malfunction(→ page 505)

ESP®(→ page 505)

ESP® OFF(→ page 505)

Distance warning(→ page 511)

Electric power steering malfunction  
(→ page 516)

Check Engine(→ page 512)

Electrical malfunction (→ page 512)

Fuel reserve with fuel filler cap loca-  
tion indicator(→ page 512)

**Vehicles with a Widescreen Cock-  
pit:** coolant too hot/cold  
(→ page 512)







Tire pressure monitor (→ page 515)

## Safety systems

Warning/indicator lamp	Possible causes/consequences and ► Solutions
 <p data-bbox="194 440 378 466">ABS warning lamp</p>	<p data-bbox="508 347 1127 476">The yellow ABS warning lamp is lit while the engine is running. ABS is malfunctioning. If there is an additional warning tone, EBD is malfunctioning. Other driving systems and driving safety systems may also malfunction.</p> <div data-bbox="508 492 1690 709" style="border: 1px solid gray; padding: 5px;"> <p data-bbox="517 502 1238 528"><b>▲ WARNING</b> There is risk of skidding if EBD or ABS is malfunctioning</p> <p data-bbox="517 543 1635 626">If EBD or ABS is malfunctioning, the wheels could lock when braking. The steering capability and braking characteristics are thus severely impaired. The braking distance in an emergency braking situation can increase. In addition, other driving safety systems are switched off.</p> <ul style="list-style-type: none"> <li data-bbox="517 637 739 663">▶ Drive on carefully.</li> <li data-bbox="517 668 1349 694">▶ Have the brake system checked immediately at a qualified specialist workshop.</li> </ul> </div> <ul style="list-style-type: none"> <li data-bbox="508 725 720 751">▶ Drive on carefully.</li> <li data-bbox="508 756 1062 782">▶ Observe the messages on the multifunction display.</li> <li data-bbox="508 787 905 813">▶ Visit a qualified specialist workshop.</li> </ul>

Warning/indicator lamp	Possible causes/consequences and ► Solutions
 <p>ESP® warning lamp flashes</p>	<p>The yellow ESP® warning lamp flashes while the vehicle is in motion. At least one wheel and tire assembly has reached its traction limit (→ page 159).</p> <ul style="list-style-type: none"> <li>► Adapt your driving style to suit the road and weather conditions.</li> </ul>
 <p>ESP® warning lamp lights up</p>	<p>The yellow ESP® warning lamp is lit while the engine is running. ESP® is malfunctioning Other driving systems and driving safety systems may also malfunction.</p> <div style="border: 1px solid black; padding: 5px; margin: 10px 0;"> <p><b>⚠ WARNING</b> Risk of skidding if ESP® is malfunctioning</p> <p>If ESP® is malfunctioning, ESP® cannot carry out vehicle stabilization. In addition, other driving safety systems are switched off.</p> <ul style="list-style-type: none"> <li>► Drive on carefully.</li> <li>► Have ESP® checked at a qualified specialist workshop.</li> </ul> </div> <ul style="list-style-type: none"> <li>► Drive on carefully.</li> <li>► Observe the messages on the multifunction display.</li> <li>► Visit a qualified specialist workshop.</li> </ul>

Warning/indicator lamp	Possible causes/consequences and ► Solutions
 <p data-bbox="195 346 439 370">ESP® OFF warning lamp</p>	<p data-bbox="506 251 1184 311">The yellow ESP® OFF warning lamp is lit while the engine is running. ESP® is deactivated.</p> <div data-bbox="506 332 1696 373"><p data-bbox="519 342 1203 368">▲ <b>WARNING</b> Risk of skidding when driving with ESP® deactivated</p></div> <p data-bbox="519 386 1668 436">If ESP® is deactivated, ESP® cannot carry out vehicle stabilization. The availability of further driving safety systems is also limited.</p> <ul data-bbox="519 448 1138 508" style="list-style-type: none"><li data-bbox="519 448 735 472">▶ Drive on carefully.</li><li data-bbox="519 484 1138 508">▶ Only deactivate ESP® for as long as the situation requires.</li></ul> <p data-bbox="519 536 1045 560">If ESP® cannot be activated, ESP® is malfunctioning.</p> <ul data-bbox="519 572 1230 596" style="list-style-type: none"><li data-bbox="519 572 1230 596">▶ Have ESP® checked immediately at a qualified specialist workshop.</li></ul> <p data-bbox="506 624 1095 648">► Observe the notes on deactivating ESP® (→ page 159).</p>

## Warning/indicator lamp



Brake warning lamp (USA)



Brakes warning lamp (Canada)

## Possible causes/consequences and ► Solutions

The red brake system warning lamp is lit while the engine is running.

Possible causes are:

- The brake force boosting is malfunctioning and the braking characteristics may be affected.
- There is not enough brake fluid in the brake fluid reservoir.

**▲ WARNING** Risk of accident and injury if brake force boosting is malfunctioning

If brake force boosting is malfunctioning, increased brake pedal force may be necessary for braking. The braking characteristics may be impaired. The braking distance can increase in emergency braking situations.

- ▶ Stop in a safe location immediately. Do not continue driving.
- ▶ Consult a qualified specialist workshop.

**▲ WARNING** Risk of an accident due to low brake fluid level

If the brake fluid level is too low, the braking effect and the braking characteristics may be impaired.

- ▶ Pull over and stop the vehicle safely as soon as possible, paying attention to road and traffic conditions. Do not continue driving under any circumstances.
- ▶ Consult a qualified specialist workshop.
- ▶ Do not add brake fluid.

- ▶ Pull over and stop the vehicle safely as soon as possible, paying attention to road and traffic conditions. Do not continue driving under any circumstances.

Warning/indicator lamp	Possible causes/consequences and ► Solutions
<div data-bbox="205 327 362 410" data-label="Image"> </div> <p data-bbox="195 418 473 495">Red indicator lamp, electric parking brake applied (USA only)</p> <div data-bbox="205 501 362 584" data-label="Image"> </div> <p data-bbox="195 592 473 669">Red indicator lamp, electric parking brake applied (Canada only)</p> <div data-bbox="205 675 362 758" data-label="Image"> </div> <p data-bbox="195 766 473 843">Yellow electric parking brake indicator lamp is malfunctioning</p>	<ul data-bbox="504 251 1058 310" style="list-style-type: none"> <li>► Observe the messages on the multifunction display.</li> <li>► Consult a qualified specialist workshop.</li> </ul> <p data-bbox="504 325 1687 373">The red electric parking brake indicator lamp flashes or is lit. The yellow indicator lamp is also lit if the electric parking brake malfunctions.</p> <ul data-bbox="504 388 1058 412" style="list-style-type: none"> <li>► Observe the messages on the multifunction display.</li> </ul>

Warning/indicator lamp	Possible causes/consequences and ► Solutions
 <p data-bbox="144 339 402 391">Restraint system warning lamp</p>	<p data-bbox="452 246 1166 308">The red restraint system warning lamp is lit while the engine is running. The restraint system is faulty (→ page 34).</p> <div data-bbox="452 325 1646 470"><p data-bbox="465 332 1197 360"><b>▲ WARNING</b> Risk of injury due to malfunctions in the restraint system</p><p data-bbox="465 373 1618 425">If the restraint system is malfunctioning, restraint system components may be triggered unintentionally or may not deploy as intended during an accident. This may affect the Emergency Tensioning Devices or airbags, for example.</p><p data-bbox="465 436 1461 464">► Have the restraint system checked and repaired immediately at a qualified specialist workshop.</p></div> <ul data-bbox="452 487 1007 581" style="list-style-type: none"><li data-bbox="452 487 667 515">► Drive on carefully.</li><li data-bbox="452 519 1007 547">► Observe the messages on the multifunction display.</li><li data-bbox="452 550 981 581">► Visit a qualified specialist workshop immediately.</li></ul>

### Seat belts



Warning/indicator lamp	Possible causes/consequences and ► Solutions
 <p data-bbox="144 814 376 866">Seat belt warning lamp lights up</p>	<p data-bbox="452 721 1332 783">The red seat belt warning lamp will light up for six seconds once the engine has started. In addition, a warning tone may sound.</p> <p data-bbox="452 793 1376 821">The seat belt warning lamp reminds the driver and front passenger to fasten their seat belts.</p> <ul data-bbox="452 824 842 852" style="list-style-type: none"><li data-bbox="452 824 842 852">► Fasten your seat belt (→ page 38).</li></ul>

Warning/indicator lamp	Possible causes/consequences and ► Solutions
 <p data-bbox="195 384 426 430">Seat belt warning lamp flashes</p>	<p data-bbox="506 249 1480 273">If you have placed objects on the front passenger seat, the seat belt warning lamp may remain lit.</p> <p data-bbox="506 291 1310 314">The red seat belt warning lamp flashes and an intermittent warning tone sounds.</p> <p data-bbox="506 325 1415 349">The driver or front passenger has not fastened their seat belt while the vehicle is in motion.</p> <ul style="list-style-type: none"> <li data-bbox="506 359 885 383">► Fasten your seat belt(→ page 38).</li> <li data-bbox="506 387 968 411">There are objects on the front passenger seat.</li> <li data-bbox="506 421 1049 445">► Remove the objects from the front passenger seat.</li> </ul>

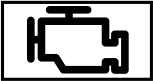
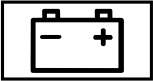

### Driving systems

Warning/indicator lamp	Possible causes/consequences and ► Solutions
 <p data-bbox="195 679 460 726">Warning lamp for distance warning function</p>	<p data-bbox="506 586 1204 610">The red distance warning lamp lights up while the vehicle is in motion.</p> <p data-bbox="506 620 1208 644">The distance to the vehicle in front is too small for the speed selected.</p> <p data-bbox="506 654 1411 678">If there is an additional warning tone, you are approaching an obstacle at too high a speed.</p> <ul style="list-style-type: none"> <li data-bbox="506 688 885 712">► Be prepared to brake immediately.</li> <li data-bbox="506 723 763 746">► Increase the distance.</li> </ul> <p data-bbox="506 764 968 788">Function of Active Brake Assist (→ page 162).</p>

## Engine

Warning/indicator lamp	Possible causes/consequences and ► Solutions
 <p data-bbox="144 384 402 433">Engine diagnosis warning lamp</p>	<p data-bbox="452 291 1171 313">The yellow Check Engine warning lamp is lit while the engine is running.</p> <p data-bbox="452 324 1264 347">A malfunction has occurred in the engine, the exhaust system or the fuel system.</p> <p data-bbox="452 357 1328 380">The emission limit values may be exceeded and the engine may be in emergency mode.</p> <p data-bbox="452 390 1641 444">In some states, legal requirements stipulate that you must immediately consult a qualified specialist workshop as soon as the yellow Check Engine warning lamp lights up.</p> <ul data-bbox="452 454 1289 477" style="list-style-type: none"> <li>► Have the vehicle checked as soon as possible at a qualified specialist workshop.</li> </ul>
 <p data-bbox="144 589 426 638">Electrical malfunction warning lamp</p>	<p data-bbox="452 498 949 521">The red electrical malfunction warning lamp is lit.</p> <p data-bbox="452 531 838 554">There is a malfunction in the electrics.</p> <ul data-bbox="452 564 1007 587" style="list-style-type: none"> <li>► Observe the messages on the multifunction display.</li> </ul>
 <p data-bbox="144 747 412 770">Fuel reserve warning lamp</p>	<p data-bbox="452 656 1197 679">The yellow fuel reserve warning lamp lights up while the engine is running.</p> <p data-bbox="452 689 968 712">The fuel supply has dropped into the reserve range.</p> <ul data-bbox="452 723 561 745" style="list-style-type: none"> <li>► Refuel.</li> </ul>





Warning/indicator lamp	Possible causes/consequences and ► Solutions
 <p data-bbox="195 342 462 366">Fuel reserve warning lamp</p>	<p data-bbox="504 249 1184 273">The yellow fuel reserve warning lamp lights up while you are driving.</p> <p data-bbox="504 283 1687 307">There has been pressure loss in the fuel system. The fuel filler cap is not closed correctly or the fuel system is leaking.</p> <ul style="list-style-type: none"> <li data-bbox="504 318 778 341">► Close the fuel filler cap.</li> </ul> <p data-bbox="504 366 1042 390">If the fuel filler cap has already been closed correctly:</p> <ul style="list-style-type: none"> <li data-bbox="504 400 905 424">► Visit a qualified specialist workshop.</li> </ul>
 <p data-bbox="195 537 415 561">Coolant warning lamp</p>	<p data-bbox="504 444 1129 468">The red coolant warning lamp is lit while the engine is running.</p> <p data-bbox="504 478 709 502">Possible causes are:</p> <ul style="list-style-type: none"> <li data-bbox="511 512 959 536">• The temperature sensor is malfunctioning</li> <li data-bbox="511 547 813 570">• The coolant level is too low</li> <li data-bbox="511 581 966 605">• The air supply to the radiator is obstructed</li> <li data-bbox="511 615 783 639">• The radiator fan is faulty</li> </ul> <p data-bbox="504 659 1670 683">If there is an additional warning tone, the coolant temperature has exceeded the maximum permissible temperature.</p> <div data-bbox="504 699 1703 740" style="background-color: #e0e0e0; padding: 5px;"> <p data-bbox="511 709 1082 733"><b>▲ WARNING</b> Danger of burns when opening the hood</p> </div> <p data-bbox="511 749 1665 800">If you open the hood when the engine has overheated or during a fire in the engine compartment, you could come into contact with hot gases or other escaping operating fluids.</p> <ul style="list-style-type: none"> <li data-bbox="511 811 1121 835">► Before opening the hood, allow the engine to cool down.</li> <li data-bbox="511 845 1509 869">► In the event of a fire in the engine compartment, keep the hood closed and call the fire service.</li> </ul>

## 514 Display messages and warning/indicator lamps

Warning/indicator lamp	Possible causes/consequences and ► Solutions
	<ul style="list-style-type: none"><li>► Pull over and stop the vehicle safely and switch off the engine, paying attention to road and traffic conditions. Do not continue driving under any circumstances.</li><li>► Observe the messages on the multifunction display.</li></ul> <p>If the coolant temperature display is at the lower end of the temperature scale:</p> <ul style="list-style-type: none"><li>► Consult a qualified specialist workshop.</li></ul> <p>or</p> <ul style="list-style-type: none"><li>► Exit the vehicle and keep a safe distance from it until the engine has cooled down.</li><li>► Check the coolant level (→ page 384).</li><li>► Make sure that the air supply to the radiator is not obstructed.</li><li>► Avoiding high loads on the engine, drive to the nearest qualified specialist workshop. In doing so, ensure that the coolant temperature display remains below the red area.</li></ul>

## Tires

Warning/indicator lamp	Possible causes/consequences and ► Solutions
 <p data-bbox="194 383 471 461">Tire pressure monitoring system warning lamp lights up</p>	<p data-bbox="508 290 1450 347">The yellow tire pressure monitoring system warning lamp (pressure loss/malfunction) is lit. The tire pressure monitoring system has detected tire pressure loss in at least one of the tires.</p> <div data-bbox="508 367 1690 409" style="background-color: #f0f0f0; padding: 5px;"> <p data-bbox="517 372 1191 398">▲ <b>WARNING</b> Risk of an accident due to insufficient tire pressure</p> </div> <p data-bbox="517 414 1108 440">Tire pressures that are too low pose the following hazards:</p> <ul data-bbox="526 450 1432 543" style="list-style-type: none"> <li>• The tires may burst, especially as the load and vehicle speed increase.</li> <li>• The tires may wear excessively and/or unevenly, which may greatly impair tire traction.</li> <li>• The driving characteristics, as well as steering and braking, may be greatly impaired.</li> </ul> <p data-bbox="517 559 942 585">You could then lose control of the vehicle.</p> <ul data-bbox="517 595 970 657" style="list-style-type: none"> <li>► Observe the recommended tire pressure.</li> <li>► Adjust the tire pressure if necessary.</li> </ul> <ul data-bbox="508 678 1182 740" style="list-style-type: none"> <li>► Stop the vehicle, paying attention to road and traffic conditions.</li> <li>► Check the tire pressure and the tires.</li> </ul>

Warning/indicator lamp	Possible causes/consequences and ► Solutions
 <p data-bbox="144 342 395 415">Tire pressure monitoring system warning lamp flashes</p>	<p data-bbox="452 246 1615 335">The yellow tire pressure monitoring system warning lamp (pressure loss/malfunction) flashes for approximately one minute and then remains lit. The tire pressure monitoring system is defective.</p> <div data-bbox="452 353 1646 532" style="border: 1px solid gray; padding: 5px;"> <p data-bbox="467 360 1480 387"><b>⚠ WARNING</b> There is a risk of an accident if the tire pressure monitoring system is malfunctioning</p> <p data-bbox="467 401 1615 453">If the tire pressure monitoring system is malfunctioning, it is not able to issue a warning if there is pressure loss in one or more of the tires. Underinflated tires may, for example, impair the driving, steering and braking characteristics.</p> <p data-bbox="467 495 1356 522">► Have the tire pressure monitoring system checked at a qualified specialist workshop.</p> </div> <p data-bbox="452 547 857 573">► Visit a qualified specialist workshop.</p>

## Vehicle

Warning/indicator lamp	Possible causes/consequences and ► Solutions
 <p data-bbox="144 811 395 862">Warning lamp for electric power steering</p>	<p data-bbox="452 714 1269 774">The red warning lamp for electric power steering is lit while the engine is running. The power-assisted steering or the steering itself is malfunctioning.</p> <div data-bbox="452 792 1646 872" style="border: 1px solid gray; padding: 5px;"> <p data-bbox="467 799 1116 826"><b>⚠ WARNING</b> Risk of accident if steering capability is impaired</p> <p data-bbox="467 841 1373 868">If the steering does not function as intended, the vehicle's operating safety is jeopardized.</p> </div>

Warning/indicator lamp	Possible causes/consequences and ► Solutions
	<ul style="list-style-type: none"><li data-bbox="517 256 1685 308">▶ Pull over and stop the vehicle safely as soon as possible, paying attention to road and traffic conditions. Do not continue driving under any circumstances.</li><li data-bbox="517 313 1685 344">▶ Consult a qualified specialist workshop.</li></ul> <p data-bbox="498 370 1685 396">▶ Observe the messages on the multifunction display.</p>

## 1, 2, 3 ...

<b>4MATIC</b> .....	145
Function .....	145

<b>12 V battery</b>	
see Battery (vehicle)	

<b>12 V socket</b>	
see Socket (12 V)	

<b>115 V socket</b>	
see Socket (115 V)	

<b>360° Camera</b> .....	189
Care .....	391
Function .....	189
Opening the camera cover (rear view camera) .....	192
Selecting a view .....	192
Setting favorites .....	192

## A

**A/C function**

Activating/deactivating (multimedia system) .....	126
Switching on/off (control panel) .....	125

<b>ABS (Anti-lock Braking System)</b> .....	158
---	-----

**Acceleration**

    see Kickdown

**Accident and breakdown management**

Mercedes me connect .....	348
---------------------------	-----

**Acoustic locking verification signal**

Activating/deactivating .....	65
-------------------------------	----

**Activating/deactivating automatic volume adjustment**

Advanced sound system .....	377
Burmester® surround sound system .....	376

**Active Blind Spot Assist** .....

Brake application .....	203
Function .....	202
Switching on/off .....	204
System limitations .....	202

**Active Brake Assist**

Function/notes .....	162
Setting .....	167

**Active Distance Assist DISTRONIC** .....

Active Emergency Stop Assist .....	177
Calling up a speed .....	172
Displays in the Instrument Display .....	177
Function .....	170

Increasing/decreasing speed .....	172
Requirements .....	172
Steering wheel buttons .....	172
Storing a speed .....	172
Switching off/deactivating .....	172
Switching on/activating .....	172
System limitations .....	170

**Active Emergency Stop Assist** .....**Active Lane Keeping Assist** .....

Activating/deactivating .....	206
Activating/deactivating the warning ...	207
Function .....	205
Setting the sensitivity .....	207
System limitations .....	205

**Active Parking Assist** .....

Cross Traffic Alert .....	197
Drive Away Assist .....	196
Exiting a parking space .....	195
Function .....	192
Maneuvering assistance .....	198
Parking .....	193
System limitations .....	192

**Active Service System PLUS**

    see ASSYST PLUS

- Active Speed Limit Assist** ..... 174
  - Display ..... 174
  - Function ..... 174
- Active Steering Assist** ..... 175
  - Activating/deactivating ..... 176
  - Active Emergency Stop Assist ..... 177
  - Displays in the Instrument Display ..... 177
  - Function ..... 175
  - System limitations ..... 175
- Adaptive brake lights** ..... 168
- Adaptive cruise control**
  - see Active Distance Assist DISTRONIC
- Adaptive Highbeam Assist**
  - Function ..... 116
  - Switching on/off ..... 117
- Additives** ..... 453
  - Engine oil ..... 453
  - Fuel ..... 453
- Additives (engine oil)**
  - see Additives
- Additives (fuel)**
  - see Fuel
- Address book**
  - see Contacts
- Adjusting the balance/fader**
  - Advanced sound system ..... 378
  - Burmester® surround sound system .... 376
- Adjusting the sound focus**
  - Burmester® surround sound system .... 377
- Adjusting treble, mid-range and bass settings**
  - Advanced sound system ..... 377
  - Burmester® surround sound system .... 376
- Advanced sound system**
  - Activating/deactivating automatic volume adjustment ..... 377
  - Adjusting the balance/fader ..... 378
  - Adjusting treble, mid-range and bass settings ..... 377
  - Calling up the sound menu ..... 377
  - Information ..... 377
- After-sales service center**
  - see ASSYST PLUS
- Air bag**
  - Reduced protection ..... 42
- Air conditioning menu**
  - Calling up ..... 126
- Air distribution**
  - Setting (multimedia system) ..... 126
- Air inlet**
  - see Air-water duct
- Air pressure**
  - see Tire pressure
- Air vents** ..... 128
  - Adjusting (front) ..... 128
  - Adjusting (rear) ..... 128
- Air vents**
  - see Air vents
- Air-recirculation mode** ..... 127
- Air-water duct** ..... 385
  - Keeping free ..... 385
- Airbag** ..... 40
  - Activation ..... 34
  - Front airbag (driver, front passenger) .... 40
  - Installation locations ..... 40
  - Knee airbag ..... 40
  - Overview ..... 40
  - PASSENGER AIR BAG indicator lamp ..... 45

- Protection ..... 41
- Side airbag ..... 40
- Window curtain airbag ..... 40
- Alarm**
  - see Panic alarm
- Alarm system**
  - see ATA (anti-theft alarm system)
- All-wheel drive**
  - see 4MATIC
- Alternative route**
  - see Route
- Ambient lighting**
  - Setting (multimedia system) ..... 118
- Android Auto** ..... 343
  - Connecting a mobile phone ..... 344
  - Ending ..... 345
  - Information ..... 344
  - Overview ..... 343
  - Sound settings ..... 345
  - Transferred vehicle data ..... 345
- Android Auto™**
  - Control using the application buttons  
..... 345
- Animals**
  - Pets in the vehicle ..... 63
- Anti-lock braking system**
  - see ABS (Anti-lock Braking System)
- Anti-skid chains**
  - see Snow chains
- Anti-theft alarm system**
  - see ATA (anti-theft alarm system)
- Anti-theft protection**
  - Immobilizer ..... 85
- Anticipatory occupant protection**
  - see PRE-SAFE® (anticipatory occupant protection)
  - see PRE-SAFE® PLUS (anticipatory occupant protection plus)
- Apple CarPlay™** ..... 342
  - Connecting an iPhone® ..... 342
  - Control using the application buttons  
..... 343
  - Ending ..... 343
  - Notes ..... 342
  - Overview ..... 342
  - Sound settings ..... 343
- Transferred vehicle data ..... 345
- Ashtray**
  - Using ..... 106
- Assistance systems**
  - see Driving safety system
- Assistant display**
  - Menu (on-board computer) ..... 214
- ASSYST PLUS** ..... 379
  - Battery disconnection periods ..... 380
  - Displaying the service due date ..... 379
  - Function/notes ..... 379
  - Regular maintenance work ..... 379
  - Special service requirements ..... 379
- ATA (anti-theft alarm system)** ..... 85
  - Activating/deactivating the interior motion sensor ..... 87
  - Arming/disarming the tow-away alarm ..... 86
  - Deactivating the alarm ..... 86
  - Function ..... 85
  - Function of the interior motion sensor .. 87
  - The tow-away alarm function ..... 86
- ATTENTION ASSIST** ..... 198, 199
  - Function ..... 198



Setting .....	199
System limitations .....	198
<b>Attention assistant</b>	
see ATTENTION ASSIST	
<b>Authorized Mercedes-Benz Center</b>	
see Qualified specialist workshop	
<b>Authorized workshop</b>	
see Qualified specialist workshop	
<b>Automatic car wash mode</b>	
Activating .....	386
<b>Automatic distance control</b>	
see Active Distance Assist DISTRONIC	
<b>Automatic driving lights</b> .....	114
<b>Automatic engine start (ECO start/ stop function)</b> .....	135
<b>Automatic engine stop (ECO start/ stop function)</b> .....	135
<b>Automatic front passenger front air- bag shutoff</b> .....	43, 45
Function of the automatic front passenger front airbag shutoff .....	43
PASSENGER AIR BAG indicator lamp .....	45

<b>Automatic front passenger front air- bag shutoff</b>	
see Automatic front passenger front airbag shutoff	
<b>Automatic mirror folding function</b>	
Activating/deactivating .....	124
<b>Automatic transmission</b>	
DIRECT SELECT lever .....	140
Drive program display .....	138
Drive programs .....	137
DYNAMIC SELECT switch .....	137
Engaging drive position .....	142
Engaging neutral .....	141
Engaging park position .....	141
Engaging reverse gear .....	141
Kickdown .....	143
Manual gearshifting .....	142
Steering wheel paddle shifters .....	142
Transmission position display .....	140
Transmission positions .....	140
<b>Automatic transmission (problem)</b>	
see Transmission (problem)	

## B

<b>Baidu CarLife</b>	
Transferred vehicle data .....	345
<b>BAS (Brake Assist System)</b> .....	159
<b>Battery</b>	
Charging (Remote Online) .....	132
SmartKey .....	66
<b>Battery</b>	
see Battery (vehicle)	
<b>Battery (vehicle)</b> .....	407
Charging .....	406
Charging (Remote Online) .....	132
Notes .....	402
Notes (starting assistance and charging) .....	404
Replacing .....	407
Starting assistance .....	406
<b>Belt</b>	
see Seat belt	
<b>Blind Spot Assist</b> .....	202
Function .....	202
Switching on/off .....	204
System limitations .....	202

<b>Bluetooth®</b> .....	278
Activating/deactivating .....	278
Information .....	278
<b>Brake Assist System</b>	
see BAS (Brake Assist System)	
<b>Brake fluid</b>	
Notes .....	454
<b>Brake force distribution</b>	
EBD (electronic brake force distribution) .....	162
<b>Brakes</b>	
ABS (Anti-lock Braking System) .....	158
Active Brake Assist .....	162
Adaptive brake lights .....	168
BAS (Brake Assist System) .....	159
Driving tips .....	133
EBD (electronic brake force distribution) .....	162
HOLD function .....	179
Limited braking effect (salt-treated roads) .....	133
New/replaced brakepads/brake discs .....	132
Notes on breaking-in a new vehicle .....	132

**Braking assistance**

    see BAS (Brake Assist System)

**Breakdown**

Changing a wheel .....	442
Overview of the help functions .....	18
Roadside Assistance .....	23
Tow-starting .....	413
Towing away .....	409
Transporting the vehicle .....	411

**Breakdown**

    see Flat tire

**Burmester® surround sound system** .... 376

Adjusting the balance/fader .....	376
Adjusting the sound focus .....	377
Adjusting treble, mid-range and bass settings .....	376
Automatic volume adjustment .....	376
Calling up the sound menu .....	376
Information .....	376
Selecting the sound profile .....	377

**Buttons**

Steering wheel .....	209
----------------------	-----

**C****Call list**

Deleting .....	338
Making a call .....	337
Overview .....	337
Selecting options .....	337
Selecting options for suggestions .....	338

**Calling up the sound menu**

Advanced sound system .....	377
Burmester® surround sound system ....	376

**Calls** .....

Accepting .....	332
Activating functions during a call .....	333
Calls with several participants .....	333
Declining .....	332
Ending a call .....	332
Incoming call during an existing call ....	333
Making .....	332
Mercedes me connect .....	347

**Camera**

see 360° Camera  
    see Rear view camera

**Car key**

see SmartKey

- Car wash**  
 see Care
- Car wash (care)** ..... 385
- Car-to-X-Communication**  
 Displaying hazard warnings ..... 315  
 Overview ..... 314  
 Sending hazard warnings ..... 315
- Care** ..... 392  
 Air-water duct ..... 385  
 Automatic car wash ..... 385  
 Carpet ..... 392  
 Decorative foil ..... 389  
 Display ..... 392  
 Exterior lighting ..... 391  
 Headliner ..... 392  
 Matte finish ..... 388  
 Paintwork ..... 388  
 Plastic trim ..... 392  
 Power washer ..... 387  
 Real wood/trim elements ..... 392  
 Rear view camera ..... 391  
 Rear view camera/360° Camera ..... 391  
 Seat belts ..... 392  
 Seat cover ..... 392  
 Sensors ..... 391  
 Tailpipes ..... 391  
 Washing by hand ..... 387  
 Wheels/rims ..... 391  
 Windows ..... 391  
 Wiper blades ..... 391
- Cargo tie-down rings** ..... 103
- Carpet (Care)** ..... 392
- Change of address** ..... 23
- Change of ownership** ..... 23
- Changing a wheel**  
 Preparation ..... 442  
 Raising the vehicle ..... 443
- Changing gears** ..... 142  
 Manually ..... 142
- Changing hub caps** ..... 442
- Character entry**  
 On the touchpad ..... 268
- Charging**  
 Battery (vehicle) ..... 406  
 USB port ..... 109
- Child safety lock**  
 Activating/deactivating (multimedia system) ..... 282  
 Rear door ..... 61  
 Rear side windows ..... 62
- Child seat**  
 Attaching (notes) ..... 53  
 Basic instructions ..... 48  
 front-passenger seat (notes) ..... 59  
 LATCH-type (ISOFIX) (installing) ..... 55  
 Notes on risks and dangers ..... 49  
 Securing on the front passenger seat .... 60  
 Securing on the rear seat ..... 58  
 Top Tether ..... 57
- Children**  
 Avoiding dangers in the vehicle ..... 49  
 Basic instructions ..... 48  
 Special seat belt retractor ..... 54
- Chock** ..... 441  
 Storage location ..... 441
- Chock**  
 see Chock
- Cigarette lighter**  
 Front center console ..... 107

**Cleaning**

see Care

**Climate control**

Activating/deactivating ..... 125  
 Activating/deactivating the A/C function (control panel) ..... 125  
 Activating/deactivating the A/C function (multimedia system) ..... 126  
 Activating/deactivating the synchronization function (control panel) ..... 127  
 Activating/deactivating the synchronization function (multimedia system) ..... 127  
 Air distribution settings ..... 126  
 Air-recirculation mode ..... 127  
 Automatic control ..... 126  
 Calling up the air conditioning menu ... 126  
 Control panel for 3-zone automatic climate control ..... 125  
 Filling capacity for PAG oil ..... 457  
 Front air vents ..... 128  
 Note ..... 125  
 Rear air vents ..... 128  
 Refrigerant ..... 456  
 Refrigerant filling capacity ..... 457

Removing condensation from the windows ..... 127  
 Residual heat ..... 127  
 Setting (multimedia system) ..... 126  
 Ventilating the vehicle (convenience opening) ..... 78

**Cockpit** ..... 6  
 Overview ..... 6

**Coffee cup symbol**  
 see ATTENTION ASSIST

**Combination switch** ..... 114

**Compass** ..... 321

**Computer**  
 see On-board computer

**Connection status**  
 Displaying ..... 355  
 Overview ..... 354

**Connectivity**  
 Switching transmission of the vehicle position on/off ..... 278

**Contacts** ..... 334  
 Calling up ..... 334  
 Deleting ..... 336

Deleting favorites ..... 337  
 Downloading (from mobile phone) ..... 334  
 Importing ..... 335  
 Importing (overview) ..... 335  
 Information ..... 334  
 Making a call ..... 335  
 Name format ..... 335  
 Options ..... 336  
 Saving as a favorite ..... 337  
 Selecting options for suggestions ..... 336  
 Storing ..... 335

**Convenience closing feature** ..... 78

**Convenience opening** ..... 78





**Coolant (engine)**  
 Check level ..... 384  
 Filling capacity ..... 455  
 Notes ..... 454

















**Copyright**  
 Licenses ..... 31  
 Trademarks ..... 32



























**Cornering light function** ..... 115

**Cross Traffic Alert** ..... 197















- Crosswind Assist**  
 Function/notes ..... 162
- Cruise control** ..... 168  
 Buttons ..... 169  
 Calling up a speed ..... 169  
 Function ..... 168  
 Requirements: ..... 169  
 Selecting ..... 169  
 Setting a speed ..... 169  
 Storing a speed ..... 169  
 Switching off ..... 169  
 Switching on ..... 169  
 System limitations ..... 168
- Cup holder** ..... 105  
 Installing/removing (center console) ... 105  
 Rear passenger compartment ..... 106
- Customer Assistance Center (CAC)** ..... 27
- Customer Relations Department** ..... 27
- D**
- Damage detection (parked vehicle)** ..... 156
- Damping adjustment** ..... 181
- Dash cam**  
 Starting/ending a video recording ..... 325
- Dashboard**  
 see Cockpit
- Dashboard lighting**  
 see Instrument cluster lighting
- Dashcam**  
 Configuring the settings ..... 326  
 Deleting a video recording ..... 325  
 Selecting a USB device ..... 324
- Data acquisition**  
 Vehicle ..... 28
- Data import/export** ..... 282  
 Function/notes ..... 282  
 Importing/exporting ..... 282
- Data storage**  
 Electronic control units ..... 28  
 Online services ..... 30  
 Vehicle ..... 28
- Date**  
 Setting the time and date automatically ..... 277
- Deactivating the alarm (ATA)** ..... 86
- Dealership**  
 see Qualified specialist workshop
- Declaration of conformity**  
 Wireless vehicle components ..... 25
- Decorative foil (cleaning instructions)**  
 ..... 389
- Definitions (tires and loading)** ..... 435
- Designs**  
 Menu (on-board computer) ..... 211
- Destination** ..... 310  
 Editing intermediate destinations ..... 301  
 Editing the previous destinations ..... 311  
 External ..... 311  
 Quick-access to destination information ..... 308  
 Saving (current vehicle position) ..... 310  
 Saving as global favorite ..... 311
- Destination entry** ..... 288  
 Entering 3 word addresses ..... 293  
 Entering a POI or address ..... 288  
 Entering an intermediate destination ... 301  
 Entering geo-coordinates ..... 293  
 Notes ..... 288  
 Selecting a contact ..... 293

- Selecting a POI ..... 291
- Selecting a received destination ..... 295
- Selecting from favorites ..... 295
- Selecting from the map ..... 294
- Selecting previous destinations ..... 291
- Detecting inattentiveness**  
see ATTENTION ASSIST
- Diagnostics connection** ..... 26
- Digital Operator's Manual** ..... 20
- Digital speedometer** ..... 215
- Dinghy towing**  
see Tow-bar system
- DIRECT SELECT lever** ..... 140
  - Engaging drive position ..... 142
  - Engaging neutral ..... 141
  - Engaging park position ..... 141
  - Engaging park position automatically ... 141
  - Engaging reverse gear ..... 141
  - Function ..... 140
- Display**  
Care ..... 392
- Display (multimedia system)** ..... 245
  - Home screen ..... 242
  - Operating ..... 245
  - Setting acoustic operating feedback ... 246
  - Settings ..... 276
- Display (on-board computer)**  
Displays on the multifunction display ... 213
- Display content**  
Displaying ..... 212
- Display message** ..... 459
  - Calling up (on-board computer) ..... 459
  - Notes ..... 459
- Display messages**
  -  --- mph ..... 481
  -  --- mph ..... 480
  -  12 V Battery See Operator's Manual ..... 484
  - Active Blind Spot Assist Currently Unavailable See Operator's Manual .... 476
  - Active Blind Spot Assist Inoperative .... 477
  - Active Blind Spot Asst. Not Available When Towing a Trailer See Operator's Manual ..... 477
  - Active Brake Assist Functions Currently Limited See Operator's Manual ..... 472
  - Active Brake Assist Functions Limited See Operator's Manual ..... 472
  - Active Distance Assist Currently Unavailable See Operator's Manual .... 480
  - Active Distance Assist Inoperative ..... 480
  - Active Distance Assist Now Available .. 481
  -  Active Headlamps Inoperative .... 503
  - Active Lane Keeping Assist Currently Unavailable See Operator's Manual .... 475
  - Active Lane Keeping Assist Inoperative ..... 476
  - Active Parking Assist and PARKTRONIC Inoperative See Operator's Manual ..... 477
  - Active Steering Assist Currently Unavailable See Operator's Manual .... 474
  - Active Steering Assist Inoperative ..... 474

- Active Steering Asst. Currently Unavailable Due to Multiple Emergency Stops ..... 475
- Adaptive Highbeam Assist Currently Unavailable See Operator's Manual ..... 503
- Adaptive Highbeam Assist Inoperative ..... 503
- Apply Brake to Shift from 'P' ..... 487
- Apply Brake to Shift to 'R' ..... 488
- Apply Parking Brake Risk of Rolling Away See Operator's Manual ..... 490
-  ATTENTION ASSIST Inoperative ... 474
-  ATTENTION ASSIST: Take a Break! ..... 473
-  Automatic Headlamp Mode Inoperative ..... 502
- Auxiliary Battery Malfunction ..... 489
-  Before Starting the Engine, Turn Steering Wheel ..... 490
- Beginning Emergency Stop ..... 475
- Blind Spot Assist Currently Unavailable See Operator's Manual ..... 476
- Blind Spot Assist Inoperative ..... 476
- Blind Spot Assist Not Available When Towing a Trailer See Operator's Manual ..... 476
-  Check Brake Fluid Level ..... 468
- Check Brake Pads See Operator's Manual ..... 468
- Check Coolant Level See Operator's Manual ..... 482
-  Check Engine Oil Level (Add 1 quart) ..... 485
-  Check Left Low Beam (Example) ..... 501
- Check Tire Pressure Soon ..... 491
- Check Tire Pressure Then Restart Run Flat Indicator ..... 492
-  Check Tires ..... 494
-  Check Washer Fluid ..... 501
-  Coolant Too Hot Stop Vehicle Turn Engine Off ..... 481
- Cruise Control Inoperative ..... 481
- Cruise Control Off ..... 481
-  Currently Unavailable Camera View Restricted ..... 479
-  Currently Unavailable Radar Sensors Dirty ..... 478
-  Currently Unavailable See Operator's Manual ..... 460
-  Currently Unavailable See Operator's Manual ..... 461
- Decrease Speed ..... 496
-  Don't Forget Your Key ..... 498
- Driver's Door Open & Transmission Not in P Risk of Vehicle Rolling Away ... 487
-  Engine Oil Level Cannot Be Measured ..... 487
-  Engine Oil Level Low Stop Vehicle Turn Engine Off ..... 485

-  Engine Oil Pressure Stop Switch Off Engine ..... 486
-  Engine Oil Reduce Oil Level ..... 486
-  Front Left Malfunction Service Required (Example) ..... 469
- Front Passenger Airbag Disabled See Operator's Manual ..... 470
- Front Passenger Airbag Enabled See Operator's Manual ..... 471
-  Fuel Level Low ..... 484
-  Gas Cap Loose ..... 484
-  Hazard Warning Flashers Malfunctioning ..... 502
-  Inoperative See Operator's Manual ..... 461
-  Inoperative See Operator's Manual ..... 462
-  EBD Inoperative See Operator's Manual ..... 463
-  SOS Inoperative ..... 473
-  Intell. Light System Inoperative ... 503
-  Key Not Detected (red display message) ..... 497
-  Key Not Detected (white display message) ..... 497
-  Left Side Curtain Airbag Malfunction Service Required (Example) ... 470
- Malfunction Drive at Max. 50 mph ..... 474
-  Malfunction See Operator's Manual ..... 501
- Mercedes me connect Services Limited See Operator's Manual ..... 473
- N Permanently Active Risk of Rolling Away ..... 488
-  Obtain a New Key ..... 496
-  Off ..... 480
-  HOLD Off ..... 479
- Only Shift to 'P' when Vehicle is Stationary ..... 488
-  PARK Parking Brake See Operator's Manual ..... 465
- Parking Lock Malfunc. Apply Parking Brake ..... 489
-  Place the Key in the Marked Space See Operator's Manual ..... 498
-  Please Check Direction of Travel ..... 478
-  Please Correct Tire Pressure ..... 495
-  PARK Please Release Parking Brake ..... 464
- PRE-SAFE Inoperative See Operator's Manual ..... 473
-  Replace Key Battery ..... 497
- Reversing Not Possible Service Required ..... 488
- Run Flat Indicator Inoperative ..... 492
-  See Operator's Manual ..... 483
- Service Required Do Not Shift Gears Visit Dealer ..... 488
-  SRS Malfunction Service Required ..... 469



-  Steering Malfunction Increased Physical Effort See Operator's Manual ..... 499
-  Steering Malfunction See Operator's Manual ..... 491
-  Steering Malfunction Stop Immediately See Operator's Manual ... 499
-  Stop Vehicle Leave Engine Running ..... 484
-  Stop Vehicle See Operator's Manual ..... 483
-  Suspended ..... 480
-  Switch Off Lights ..... 502
-  Switch On Headlamps ..... 502
- Teaching in Transmission Complete .... 490
- Teaching in Transmission Operate Selector Lever Apply Brake for XX s Risk of Vehicle Rolling Away ..... 490
-  Tire Press. Monitor Currently Unavailable ..... 493
-  Tire Press. Monitor Inoperative ... 493
-  Tire Pressure Monitor Inoperative No Wheel Sensors ..... 493
- Tires Overheated ..... 496
- To Deselect P or N, Depress Brake and Start Engine ..... 487
- Traffic Sign Assist Currently Unavailable See Operator's Manual ..... 477
- Traffic Sign Assist Inoperative ..... 477
- Trans. Oil Overheated Drive on with Care ..... 489
- Transmission Malfunction ..... 489
- Transmission Malfunction Service Required ..... 490
- Transmission Malfunction Stop ..... 488
-  Turn On the Ignition to Release the Parking Brake ..... 464
-  Vehicle Operational Switch the Ignition Off Before Exiting ..... 498
-  Warning Tire Malfunction ..... 495
-  Wheel Sensor(s) Missing ..... 494
- Display on the windshield**  
see Head-up Display
- Distance control**  
see Active Distance Assist DISTRONIC
- Distance recorder**  
see Trip distance
- DISTRONIC**  
see Active Distance Assist DISTRONIC
- Door**
  - Child safety lock (rear door) ..... 61
  - Locking (emergency key) ..... 72
  - Opening (from the inside) ..... 69
  - Unlocking (emergency key) ..... 72
  - Unlocking (from the inside) ..... 69
- Door control panel** ..... 16
- DOT, Tire Identification Number (TIN)** ... 431
- Drawbar**  
see Tow-bar system
- Drinking and driving** ..... 133
- Drinks holder**  
see Cup holder

- Drive Away Assist** ..... 196
- Drive Away Assist**  
see Protection against collision
- Drive position**  
Inserting ..... 142
- Drive program display** ..... 138
- Drive programs**  
see DYNAMIC SELECT
- Driver's seat**  
see Seat
- Driving lights**  
see Automatic driving lights
- Driving safety system** ..... 157
- ABS (Anti-lock Braking System) ..... 158
  - Active Brake Assist ..... 162
  - Adaptive brake lights ..... 168
  - BAS (Brake Assist System) ..... 159
  - EBD (electronic brake force distribution) ..... 162
  - ESP® Crosswind Assist ..... 162
  - Overview ..... 158
  - Radar sensors ..... 157
  - Responsibility ..... 157
- STEER CONTROL ..... 162
- Driving system**  
Suspension with adaptive damping adjustment ..... 181
- Driving system**  
see 360° Camera  
see Active Blind Spot Assist  
see Active Distance Assist DISTRONIC  
see Active Emergency Stop Assist  
see Active Lane Keeping Assist  
see Active Parking Assist  
see Active Speed Limit Assist  
see Active Steering Assist  
see ATTENTION ASSIST  
see Blind Spot Assist  
see Cruise control  
see Driving safety system  
see HOLD function  
see Parking Assist PARKTRONIC  
see Rear view camera  
see Traffic Sign Assist
- Driving tips**  
Drinking and driving ..... 133  
General driving tips ..... 133  
Notes on breaking-in a new vehicle ..... 132
- Drowsiness detection**  
see ATTENTION ASSIST
- Dynamic handling control system**  
see ESP® (Electronic Stability Program)
- DYNAMIC SELECT** ..... 137
- Configuring drive program I ..... 139
  - Displaying engine data ..... 140
  - Displaying vehicle data ..... 139
  - Drive program display ..... 138
  - Drive programs ..... 137
  - Function ..... 137
  - Operating (DYNAMIC SELECT switch) ..... 138
  - Selecting the drive program ..... 138
- DYNAMIC SELECT switch**  
Damping adjustment ..... 181
- E**
- E10** ..... 452
- Easy entry feature**  
Function/notes ..... 95  
Setting ..... 96
- Easy exit feature**  
Function/notes ..... 95

- Setting ..... 96
- EBD (electronic brake force distribution)**
- Function/notes ..... 162
- ECO display**
- Function ..... 137
- Resetting ..... 216
- ECO start/stop function** ..... 135
- Automatic engine start ..... 135
- Automatic engine stop ..... 135
- Method of operation ..... 135
- Switching off/on ..... 136
- Electric parking brake** ..... 154
- Applying automatically ..... 154
- Applying or releasing manually ..... 155
- Emergency braking ..... 156
- Releasing automatically ..... 155
- Electronic Stability Program**
- see ESP® (Electronic Stability Program)
- Emergency**
- First-aid kit (soft sided) ..... 396
- Overview of the help functions ..... 18
- Reflective safety vest ..... 395
- Removing the warning triangle ..... 396
- Setting up the warning triangle ..... 396
- Emergency braking** ..... 156
- Emergency braking**
- see BAS (Brake Assist System)
- Emergency call system**
- see Mercedes-Benz emergency call system
- Emergency engine start** ..... 413
- Emergency key**
- Locking a door ..... 72
- Unlocking a door ..... 72
- Emergency operation mode**
- Starting the vehicle ..... 130
- Emergency release**
- Trunk lid (from inside) ..... 76
- Emergency Tensioning Devices**
- Activation ..... 34
- Engine**
- ECO start/stop function ..... 135
- Engine number ..... 449
- Starting (emergency operation mode) ..... 130
- Starting (Remote Online) ..... 132
- Starting (start/stop button) ..... 130
- Starting assistance ..... 406
- Switching off (start/stop button) ..... 148
- Engine data**
- Displaying ..... 140
- Engine number** ..... 449
- Engine oil** ..... 383
- Additives ..... 453
- Capacity ..... 454
- Checking the oil level using the on-board computer ..... 382
- MB-Freigabe or MB-Approval ..... 454
- Quality ..... 454
- Topping up ..... 383
- Entering characters** ..... 268
- Function/notes ..... 268
- On the touchscreen (media display) .... 272
- Setting the keyboard ..... 276
- ESC (Electronic Stability Control)**
- see ESP® (Electronic Stability Program)
- ESP®**
- Crosswind Assist ..... 162
- ESP® (Electronic Stability Program)** ..... 159
- Activating/deactivating ..... 161

- Function/notes ..... 159
- Exterior lighting**
- Care ..... 391
- Exterior lighting**
- see Lights
- Exterior mirrors** ..... 121, 122
- Anti-glare mode (automatic) ..... 122
- Automatic mirror folding function ..... 124
- Folding in/out ..... 121
- Operating the memory function ..... 96
- Parking position ..... 123
- Setting ..... 121
- External device**
- Locking (child safety lock) ..... 282
- Eyeglasses compartment** ..... 100
- F**
- Fatigue detection**
- see ATTENTION ASSIST
- Favorites**
- Adding ..... 261
- Adding a destination ..... 295
- Calling up ..... 261
- Deleting ..... 262
- Home address ..... 295
- Moving ..... 262
- Overview ..... 261
- Renaming ..... 262
- Work address ..... 295
- First-aid kit (soft sided)** ..... 396
- Flat tire** ..... 397
- Changing a wheel ..... 442
- MOExtended tires ..... 397
- Notes ..... 397
- TIREFIT kit ..... 398
- Flat towing**
- see Tow-bar system
- Floor mats** ..... 111
- Foil covering**
- Radar sensors ..... 157
- Free software** ..... 31
- Frequencies**
- Mobile phone ..... 448
- Two-way radio ..... 448
- Frequency band**
- Dialing (on-board computer) ..... 218
- Front airbag (driver, front passenger)** ..... 40
- Front passenger seat**
- see Seat
- Fuel** ..... 453
- Additives ..... 453
- E10 ..... 452
- Fuel reserve ..... 453
- Gasoline ..... 452
- Quality (gasoline) ..... 452
- Refueling ..... 145
- sulfur content ..... 452
- Tank content ..... 453
- Fuel consumption**
- On-board computer ..... 215
- Fuel consumption indicator**
- Calling up ..... 140
- Function seat**
- see Door control panel
- Fuses** ..... 413
- Before replacing a fuse ..... 413
- Fuse assignment diagram ..... 413
- Fuse box in the engine compartment ... 414
- Fuse box in the front-passenger foot-well ..... 415

- Fuse box in the trunk ..... 416  
 Notes ..... 413
- Fuses**  
 see Fuses
- G**
- Garage door opener**  
 Clearing the memory ..... 152  
 Opening or closing the door ..... 152  
 Programming buttons ..... 149  
 Radio equipment approval numbers .... 152  
 Resolving problems ..... 151  
 Synchronizing the rolling code ..... 151
- Gas station search**  
 Starting automatic search ..... 303  
 Switching automatic search on/off .... 303
- Gasoline** ..... 452
- Gearshift recommendation** ..... 143
- Genuine parts** ..... 21
- Glide mode** ..... 143
- Global search**  
 Function ..... 265  
 Overview ..... 264
- Glove box**  
 Locking/unlocking ..... 99
- H**
- Handbrake**  
 see Electric parking brake
- Handling characteristics (unusual)** ..... 417
- HANDS-FREE ACCESS** ..... 74
- Hazard warning lights** ..... 115
- Hazardous substances**  
 Information ..... 24
- Head restraint**  
 Front (adjusting mechanically) ..... 90  
 Rear (installing/removing) ..... 91  
 Rear passenger compartment  
 (adjusting) ..... 91
- Head-up Display** ..... 220  
 Adjusting display elements (on-board  
 computer) ..... 220  
 Adjusting the brightness (on-board  
 computer) ..... 220  
 Function ..... 220  
 Menu (on-board computer) ..... 220
- Operating the memory function ..... 96  
 Setting the position (on-board com-  
 puter) ..... 220  
 Switching on/off ..... 221
- Headliner (care)** ..... 392
- High beam**  
 Switching on/off ..... 114
- High-beam flasher** ..... 114
- High-beam headlamps**  
 Adaptive Highbeam Assist ..... 116
- Hill start assist** ..... 179
- HOLD function** ..... 179  
 Function/notes ..... 179  
 Switching on/off ..... 179
- Home screen (media display)**  
 Overview ..... 242
- Hood**  
 Opening/closing ..... 380
- Hotspot**  
 Setting up (Wi-Fi) ..... 280

- I**
- Identification plate**
- Engine ..... 449
  - Refrigerant ..... 456
  - Vehicle ..... 449
- Ignition**
- Switching on (Start/Stop button) ..... 129
- Ignition key**
- see SmartKey
- Immobilizer** ..... 85
- Indicator lamps**
- see Warning/indicator lamps
- Individual drive program**
- Configuring ..... 139
  - Selecting ..... 138
- Inside rearview mirror**
- see Exterior mirrors
- Inspection**
- see ASSYST PLUS
- Instrument cluster**
- see Instrument Display
- Instrument cluster lighting** ..... 214
- Instrument Display** ..... 208
- Adjusting the lighting ..... 214
  - Function/notes ..... 208
  - Instrument cluster ..... 10
  - Warning/indicator lamps ..... 504
- Intelligent Light System**
- Adaptive Highbeam Assist ..... 116
  - Cornering light function ..... 115
- Interior lighting** ..... 118
- Ambient lighting ..... 118
  - Reading light ..... 118
  - Setting ..... 118
  - Switch-off delay time ..... 119
- Interior motion sensor**
- Activating/deactivating ..... 87
  - Function ..... 87
- Intermediate destination**
- Calculating a route with intermediate destinations ..... 301
  - Entering ..... 301
  - Modifying ..... 301
  - Starting an automatic gas station search ..... 303
- Starting the automatic service station search ..... 303
- Internet**
- Calling up a web page ..... 355
  - Closing the browser ..... 358
  - Deleting a bookmark ..... 357
  - Deleting history ..... 357
  - Managing bookmarks ..... 357
- Internet connection**
- Communication module function ..... 354
  - Connection status ..... 354
  - Displaying the connection status ..... 355
  - Establishing ..... 354
  - Information ..... 353
  - Restrictions ..... 353
- Internet radio**
- Calling up ..... 358
  - Calling up the station list (category last selected) ..... 360
  - Deleting stations ..... 360
  - Logging out ..... 360
  - Overview ..... 359
  - Registering ..... 360
  - Saving stations ..... 360

- Selecting and connecting to a station ..... 360
- Selecting stream ..... 360
- Setting options ..... 360
- Terms of use ..... 360
- iPhone®**
  - see Apple CarPlay™
  - see Mercedes-Benz Link
- J**
- Jack**
  - Storage location ..... 441
- Jump-start connection** ..... 406
  - General notes ..... 404
- K**
- KEYLESS-GO**
  - Locking the vehicle ..... 69
  - Problem ..... 70
  - Unlocking setting ..... 65
  - Unlocking the vehicle ..... 69
- Kickdown** ..... 143
  - Using ..... 143
- Knee airbag** ..... 40
- L**
- Labeling (tires)**
  - see Tire labeling
- Lamp**
  - see Interior lighting
- Lamps (Instrument Display)**
  - see Warning/indicator lamps
- Lane detection (automatic)**
  - see Active Lane Keeping Assist
- Lane Keeping Assist**
  - see Active Lane Keeping Assist
- Language** ..... 282
  - Notes ..... 282
  - Setting ..... 282
- LATCH-type (ISOFIX) child seat securing system**
  - Installing ..... 55
- Light switch**
  - Overview ..... 113
- Lighting**
  - see Interior lighting
- see Lights
- Lights** ..... 113
  - Adaptive Highbeam Assist ..... 116
  - Adjusting the instrument lighting ..... 214
  - Automatic driving lights ..... 114
  - Combination switch ..... 114
  - Cornering light function ..... 115
  - Hazard warning lights ..... 115
  - High beam ..... 114
  - High-beam flasher ..... 114
  - Light switch ..... 113
  - Low-beam headlamps ..... 113
  - Parking lights ..... 113
  - Rear fog lamp ..... 113
  - Responsibility for lighting systems ..... 113
  - Setting the exterior lighting switch-off delay time ..... 117
  - Standing lights ..... 113
  - Switching the surround lighting on/off ..... 117
  - Turn signals ..... 114
- Limited Warranty**
  - Vehicle ..... 28
- Live Traffic Information**
  - Displaying the traffic map ..... 312

- Displaying traffic incidents ..... 313
  - Provider information ..... 312
  - Showing local area messages ..... 314
  - Switching the traffic information display on ..... 314
  - Load index (tires)** ..... 433
  - Load-bearing capacity (tires)** ..... 433
  - Loading** ..... 103
    - Cargo tie-down rings ..... 103
    - Definitions ..... 435
    - Notes ..... 98
    - Roof carrier ..... 103
    - Stowage space under the trunk floor ... 103
  - Loading guidelines** ..... 98
  - Loading information table** ..... 426
  - Loads**
    - Securing ..... 98
  - Locking/unlocking**
    - Activating/deactivating the automatic locking feature ..... 71
    - Emergency key ..... 72
    - KEYLESS-GO ..... 69
    - Unlocking and opening doors from the inside ..... 69
  - Low-beam headlamps**
    - Switching on/off ..... 113
  - Lubricant additives**
    - see Additives
  - Luggage**
    - Securing ..... 98
  - Lumbar support**
    - see Lumbar support (4-way)
  - Lumbar support (4-way)** ..... 90
- M**
- Maintenance**
    - Menu (on-board computer) ..... 214
    - Vehicle ..... 23
  - Maintenance**
    - see ASSYST PLUS
  - Malfunction**
    - Parking Assist PARKTRONIC ..... 183
    - Restraint system ..... 34
  - Malfunction message**
    - see Display message
  - Map** ..... 312, 316
    - Avoiding an area ..... 319
    - Avoiding an area (overview) ..... 319
    - Changing an area ..... 320
    - Deleting an area ..... 320
    - Displaying the compass ..... 321
    - Displaying the map version ..... 319
    - Displaying the next intersecting street ..... 319
    - Displaying the range ..... 322
    - Displaying the satellite map ..... 322
    - Displaying the traffic map ..... 312
    - Displaying weather information ..... 322
    - Map data ..... 321
    - Moving ..... 316
    - Selecting POI symbols ..... 317
    - Selecting text information ..... 318
    - Selecting the map orientation ..... 317
    - Setting the map scale ..... 316
    - Setting the map scale automatically .... 321
    - Showing in the multifunction display of the instrument cluster ..... 323
    - Switching freeway information on/off ..... 318
    - Updating ..... 320



- Message program**
  - Resetting the settings ..... 92
- Message programs**
  - Selecting the front seats ..... 92
- Message settings**
  - Resetting ..... 92
- Matte finish (cleaning instructions)** ..... 388
- Maximum load rating** ..... 432
- Maximum permissible load**
  - Calculation example ..... 428
  - Determining ..... 427
- Maximum tire pressure** ..... 432
- MBUX in-car assistant (multimedia system)** ..... 248
  - Notes ..... 248
  - Operating functions through proximity of the hand ..... 250
  - Operating functions using poses ..... 251
  - Overview ..... 248
  - Selecting settings ..... 252
  - Switching the reading light for the driver and front passenger on/off ..... 252
- MBUX Touch** ..... 281
  - Managing devices ..... 281
- Mechanical key**
  - Inserting/removing ..... 66
- Media**
  - Menu (on-board computer) ..... 218
- Media display**
  - Notes ..... 241
- Media mode**
  - Adding a favorite song ..... 365
  - Connecting Bluetooth® audio equipment ..... 364
  - Connecting USB devices ..... 364
  - Controlling media playback ..... 365
  - Copyright and trademarks ..... 361
  - Notes about the search function in categories ..... 366
  - Overview of the media menu ..... 363
  - Playing back similar music tracks ..... 365
  - Removing a favorite song ..... 365
  - Searching for a music track according to mood ..... 367
  - Starting a search in categories ..... 366
  - Starting media playback ..... 365
- Supported format and data storage media ..... 360
- Surprise mix ..... 365
- Using the keyword search ..... 367
- Media playback**
  - Operating (on-board computer) ..... 218
- Media source**
  - Selecting (on-board computer) ..... 218
- Memory function**
  - Head-up Display – Calling up stored settings ..... 96
  - Head-up Display – Storing settings ..... 96
  - Operating ..... 96
  - Outside mirrors – Calling up stored settings ..... 96
  - Outside mirrors – Storing settings ..... 96
  - Seat – Calling up stored settings ..... 96
  - Seat – Storing settings ..... 96
- Menu (on-board computer)**
  - Assistant display ..... 214
  - Designs ..... 211
  - Head-up Display ..... 220
  - Maintenance ..... 214
  - Media ..... 218

- Navigation ..... 216
- Overview ..... 210
- Radio ..... 218
- Telephone ..... 219
- Trip ..... 215
- Mercedes me**
  - Calling up services ..... 349
  - Calling up your user account ..... 349
  - Deleting a connection ..... 350
  - Information ..... 349
- Mercedes me connect**
  - Accident and breakdown management ..... 348
  - Arranging a service appointment ..... 348
  - Call with the me button ..... 347
  - Calling the Mercedes-Benz Customer Center ..... 346
  - Information ..... 346
  - Making a call via the overhead control panel ..... 347
  - Transferred data ..... 348
- Mercedes-AMG vehicles**
  - Notes ..... 129
- Mercedes-Benz emergency call system** ..... 350
  - Automatic emergency call ..... 351
  - Information ..... 350
  - Information on data transfer ..... 352
  - Manual emergency call ..... 352
  - Overview ..... 351
- Mercedes-Benz Link** ..... 340
  - Connecting ..... 341
  - Ending ..... 341
  - Note ..... 340
  - Overview ..... 340
  - Sound settings ..... 341
- Message (multifunction display)**
  - see Display message
- Message memory** ..... 459
- Messages** ..... 338
  - Calling a message sender ..... 339
  - Configuring the displayed text messages ..... 338
  - Deleting ..... 340
  - Forwarding ..... 339
  - Overview ..... 338
  - Reading ..... 339
- Using a number/URL ..... 339
- Using templates ..... 339
- Voice commands (Voice Control System) ..... 235
- Mirrors**
  - see Exterior mirrors
- Mobile phone**
  - Damage detection (parked vehicle) ..... 156
  - Frequencies ..... 448
  - Transmission output (maximum) ..... 448
  - Wireless charging ..... 111
- Mobile phone**
  - see Android Auto
  - see Apple CarPlay™
  - see Mercedes-Benz Link
  - see Second telephone
  - see Telephone
- Mobile phone voice recognition**
  - Starting ..... 332
  - Stopping ..... 332
- Model series**
  - see Vehicle identification plate
- MOExtended tires** ..... 397

<b>Multifunction display</b>	
Overview of displays .....	213
<b>Multifunction steering wheel</b>	
Overview of buttons .....	209
<b>Multifunction steering wheel</b>	
see Steering wheel	
<b>Multimedia system</b>	
Activating/deactivating standby mode .....	157
Adjusts the volume .....	267
Central control elements .....	244
Configuring display settings .....	276
Configuring drive program I .....	139
Favorites .....	261
Main functions .....	253
MBUX in-car assistant (notes) .....	248
Overview .....	240
Restoring the factory settings .....	286
Standby mode function .....	157
Switching the sound on/off .....	266
<b>Multimedia system</b>	
see Display (multimedia system)	
see Entering characters	

see MBUX in-car assistant (multimedia system)	
see Notifications Center	
see Profile	
see Suggestions	
see Themes	
see Touch Control	
see Touchpad	

## N

### Navigation

Menu (on-board computer) .....	216
Overview .....	287
Showing/hiding the menu .....	286
Switching on .....	286
Updating the map data .....	320
Voice commands (Voice Control System) .....	227

### Navigation

see Destination	
see Destination entry	
see Map	
see Parking service	
see Route	
see Route guidance	

see Traffic information	
-------------------------	--

### Navigation announcements

Activating/deactivating .....	308
Adjusting the volume .....	309
Repeating .....	309
Switching audio fadeout on/off .....	309

### Navigation messages

On-board computer .....	216
-------------------------	-----

### Near Field Communication (NFC)

Connecting the mobile phone to the multimedia system .....	331
General information .....	331
Switching mobile phones .....	331
Using a mobile phone .....	331

### Neutral

Inserting .....	141
-----------------	-----

### NFC

see Near Field Communication (NFC)	
------------------------------------	--

### Non-operational time

Activating/deactivating standby mode .....	157
Standby mode function .....	157

### Notes on breaking-in a new vehicle

132

<b>Notifications Center</b> .....	262
Calling up a notification .....	263
Editing a notification .....	264
Global search (overview) .....	264
Notification types .....	262
Overview .....	262
Selecting actions for a notification .....	264
Using the global search .....	265

## O

<b>Occupant safety</b>	
Pets in the vehicle .....	63
<b>Occupant safety</b>	
see Airbag	
see Automatic front passenger front airbag shutoff	
see PRE-SAFE® (anticipatory occupant protection)	
see PRE-SAFE® PLUS (anticipatory occupant protection plus)	
see Restraint system	
see Seat belt	
<b>Odometer</b>	
see Total distance	

<b>Oil</b>	
see Engine oil	
<b>On-board computer</b> .....	210
Assistance graphic menu .....	214
Displaying the service due date .....	379
Head-up Display menu .....	220
Media menu .....	218
Menu designs .....	211
Menu overview .....	210
Multifunction display .....	213
Navigation system menu .....	216
Operating .....	210
Radio menu .....	218
Service menu .....	214
Telephone menu .....	219
Trip menu .....	215

### On-board diagnostics interface

see Diagnostics connection

<b>Open-source software</b> .....	31
-----------------------------------	----

<b>Opening the trunk lid using your foot</b>	
HANDS-FREE ACCESS .....	74

<b>Operating fluids</b>	
Additives (fuel) .....	453
Brake fluid .....	454

Coolant (engine) .....	454
Engine oil .....	453
Fuel (gasoline) .....	452
Notes .....	450
Refrigerant (air conditioning system) ...	456
Windshield washer fluid .....	455

### Operating safety

Declaration of conformity (wireless vehicle components) .....	25
Information .....	24

### Operating system

see On-board computer

### Operator's Manual

Vehicle equipment .....	22
-------------------------	----

<b>Operator's Manual (digital)</b> .....	20
--	----

### Overhead control panel

Overview .....	14
----------------	----

## P

<b>Paint code</b> .....	449
-------------------------	-----

<b>Paintwork (cleaning instructions)</b> .....	388
--	-----

<b>Panic alarm</b> .....	65
Activating/deactivating .....	65

- Panoramic sliding sunroof**
  - see Sliding sunroof
- Park position**
  - Inserting ..... 141
  - Selecting automatically ..... 141
- Parking**
  - see Electric parking brake
- Parking aid**
  - see Parking Assist PARKTRONIC
- Parking Assist PARKTRONIC** ..... 181
  - Activating ..... 185
  - Adjusting warning tones ..... 186
  - Function ..... 181
  - Problems ..... 183
  - Side impact protection ..... 184
  - Switching off ..... 185
  - System limitations ..... 181
- Parking assistance systems**
  - see Active Parking Assist
- Parking brake**
  - see Electric parking brake
- Parking for an extended period** ..... 156
- Parking lights** ..... 113
- Parking options**
  - see Parking service
- Parking position**
  - Exterior mirrors ..... 123
  - Storing the position of the front-passenger outside mirror using reverse gear ..... 124
- Parking service** ..... 323
  - Notes ..... 323
  - Selecting parking options ..... 323
  - Showing a parking option on the map ..... 324
- PARKTRONIC**
  - Malfunction ..... 183
- Particulates status display** ..... 126
- PASSENGER AIR BAG status display**
  - see Automatic front passenger front airbag shutoff
- Payload**
  - Calculation example ..... 428
  - Determining the maximum ..... 427
- Permitted towing methods** ..... 408
- Pets in the vehicle** ..... 63
- Phone book**
  - see Contacts
- PIN protection**
  - Activating/deactivating ..... 283
- Plastic trim (Care)** ..... 392
- POI**
  - Quick access ..... 308
  - Selecting ..... 291
- POI symbols**
  - Selecting ..... 317
- Power supply**
  - Switching on (Start/Stop button) ..... 129
- Power washer (care)** ..... 387
- Power windows**
  - see Side windows
- PRE-SAFE® (anticipatory occupant protection)** ..... 47
  - Function ..... 47
  - PRE-SAFE® Sound ..... 47
  - Reversing measures ..... 48

<b>PRE-SAFE® PLUS (anticipatory occupant protection plus)</b> .....	48
Function .....	48
Reversing measures .....	48

### **Preventative occupant protection system**

see PRE-SAFE® (anticipatory occupant protection)

### **Previous destinations**

Selecting ..... 291

### **Profile** ..... 253, 254

Creating a new profile .....	255
Maximum number of profiles .....	254
Notes .....	253
Overview .....	254
Selecting a profile .....	256
Selecting profile options .....	255
Showing the profile selection when entering .....	256
Synchronizing .....	256

### **Programs**

see DYNAMIC SELECT

### **Protecting the environment**

Notes ..... 21

**Protection against collision** ..... 196

### **Protection against theft**

see ATA (anti-theft alarm system)

## **Q**

### **QR code**

Rescue card ..... 28

**Qualified specialist workshop** ..... 26

## **R**

### **Radar sensors**

Foil covering ..... 157

### **Radio**

Activating/deactivating radio text .....	370
Calling up the station list .....	369
Deleting channels .....	370
Direct frequency entry .....	369
Displaying information .....	370
Displaying radio text .....	370
Editing station presets .....	370
Menu (on-board computer) .....	218
Moving stations .....	370
Overview .....	368
Searching for stations .....	369

Setting a channel ..... 369

Setting the waveband ..... 369

Showing accident reports ..... 370

Storing radio stations ..... 369

Switching on ..... 367

Switching the HD radio function on/off ..... 369

### **Radio stations**

Dialing (on-board computer) ..... 218

### **Rain closing function**

Sliding sunroof ..... 83

### **Range**

Displaying ..... 215

### **Reading light**

see Interior lighting

**Real wood (Care)** ..... 392

**Rear door (child safety lock)** ..... 61

### **Rear fog lamp**

Switching on/off ..... 114

### **Rear seat**

see Seat

**Rear view camera** ..... 186

Care ..... 391

- Function ..... 186
- Opening the camera cover (360° Camera) ..... 192
- Setting favorites (360° Camera) ..... 192
- Reflective safety vest** ..... 395
- Refrigerant (air conditioning system)**
  - Notes ..... 456
- Refueling**
  - Refueling the vehicle ..... 145
- Remote Online**
  - Charging the battery ..... 132
  - Cooling or heating the vehicle interior ..... 131
  - Starting the vehicle ..... 132
- Reporting malfunctions relevant to safety** ..... 27
- Rescue card** ..... 28
- Reserve**
  - Fuel ..... 453
- Reset function (multimedia system)** ..... 286
- Residual heat** ..... 127
- Restoring (factory settings)**
  - see Reset function (multimedia system)
- Restraint system** ..... 33
  - Basic instructions for children ..... 48
  - Function in an accident ..... 34
  - Functionality ..... 34
  - Malfunction ..... 34
  - Protection ..... 33
  - Reduced protection ..... 33
  - Self-test ..... 34
  - Warning lamp ..... 34
- Reverse gear**
  - Inserting ..... 141
- Rims (Care)** ..... 391
- Roadside Assistance** ..... 23
- Roll away protection**
  - see HOLD function
- Roof carrier**
  - Attaching ..... 103
  - Loading ..... 103
- Roof load** ..... 458
- Roof load display**
  - Information ..... 138
- Route** ..... 296, 302
  - Accepting a detour recommendation after a prompt ..... 298
  - Activating a commuter route ..... 302
  - Alternative route (quick-access) ..... 308
  - Calculating ..... 296
  - Displaying destination information ..... 300
  - Displaying the route list ..... 301
  - Editing a stored route ..... 304
  - External ..... 311
  - Planning ..... 301
  - Recording a route ..... 304
  - Saving a recorded route ..... 304
  - Selecting a type ..... 297
  - Selecting an alternative route ..... 302
  - Selecting notifications ..... 299
  - Selecting options ..... 298
  - Showing a stored route on the map .... 303
  - Starting a saved route ..... 304
  - Starting the automatic service station search ..... 303
  - Switching the automatic gas station search on/off ..... 303
  - With intermediate destinations ..... 301

- Route guidance** ..... 305
    - Canceling ..... 309
    - Changing direction ..... 305
    - Destination reached ..... 308
    - Freeway information ..... 307
    - From an off-road location ..... 310
    - Lane recommendations ..... 306
    - Notes ..... 305
    - Off-road ..... 310
    - To an off-road destination ..... 310
  - Route-based speed adaptation**
    - Displays in the Instrument Display ..... 177
  - Run-flat characteristics**
    - MOExtended tires ..... 397
- S**
- Safety systems**
    - see Driving safety system
  - Satellite map** ..... 322
  - Satellite radio**
    - Activating/deactivating TuneStart ..... 375
    - Adding a channel to Smart Favorites ... 374
    - Deleting a channel ..... 373
    - Displaying EPG information ..... 373
    - Displaying service information ..... 375
    - Information ..... 370
    - Information about Smart Favorites and TuneStart ..... 374
    - Logging in ..... 371
    - Moving a channel ..... 373
    - Music and sport alerts function ..... 373
    - Overview ..... 372
    - Pause and playback function ..... 375
    - Restrictions ..... 370
    - Selecting a category ..... 373
    - Selecting a channel ..... 373
    - Setting music and sport alerts ..... 373
    - Setting the parental control ..... 373
    - Storing a channel ..... 373
    - Switching on ..... 371
  - Seat** ..... 88, 100
    - 4-way lumbar support ..... 90
    - Adjusting (electrically) ..... 89
    - Adjusting (Seat Comfort) ..... 89
    - Backrest (rear) locking ..... 102
    - Configuring the settings ..... 92
    - Correct driver's seat position ..... 88
    - Folding the backrest (rear passenger compartment) back ..... 101
    - Folding the backrest (rear) forwards .... 100
    - Operating the memory function ..... 96
    - Resetting the settings ..... 92
    - Setting options ..... 16
  - Seat belt** ..... 35
    - Fastening ..... 38
    - Protection ..... 35
  - Seat belt adjustment**
    - Activating/deactivating ..... 39
    - Function ..... 39
  - Seat belt warning**
    - see Seat belts
  - Seat belts** ..... 39
    - Activating/deactivating seat belt adjustment ..... 39
    - Care ..... 392
    - Reduced protection ..... 37
    - Releasing ..... 39
    - Seat belt adjustment (function) ..... 39
    - Warning lamp ..... 39
  - Seat cover (Care)** ..... 392
  - Seat heating**
    - Activating/deactivating ..... 92



- Seat ventilation**  
Switching on/off ..... 93
- Second telephone** ..... 329  
Connecting ..... 329  
Features ..... 329
- Selecting a gear**  
see Changing gears
- Selecting the sound profile**  
Burmester® surround sound system .... 377
- Selector lever**  
see DIRECT SELECT lever
- Self-test**  
Automatic front passenger front air-bag shutoff ..... 45
- Sensors (Care)** ..... 391
- Service center**  
see Qualified specialist workshop
- Service interval display**  
see ASSYST PLUS
- Service station search**  
Starting automatic search ..... 303
- Setting a speed**  
see Cruise control
- Setting the date format** ..... 277
- Setting the distance unit** ..... 282
- Setting the map scale**  
see Map
- Shift paddles**  
see Steering wheel paddle shifters
- Shifting gears**  
Gearshift recommendation ..... 143
- Short messages**  
see Messages
- Side airbag** ..... 40
- Side impact protection** ..... 184
- Side windows** ..... 76  
Child safety lock in the rear  
passenger compartment ..... 62  
Closing ..... 76  
Closing using the SmartKey ..... 78  
Convenience closing feature ..... 78  
Convenience opening ..... 78  
Opening ..... 76  
Opening with the SmartKey ..... 78  
Problem ..... 79
- Size designation (tires)** ..... 433
- Sliding sunroof** ..... 80  
Automatic functions ..... 83  
Closing ..... 80  
Closing using the SmartKey ..... 78  
Opening ..... 80  
Opening with the SmartKey ..... 78  
Problem ..... 83  
Rain closing function ..... 83
- SmartKey** ..... 64  
Acoustic locking verification signal ..... 65  
Battery ..... 66  
Energy consumption ..... 65  
Features ..... 64  
Key ring attachment ..... 66  
Mechanical key ..... 66  
Overview ..... 64  
Panic alarm ..... 65  
Problem ..... 67  
Unlocking setting ..... 65
- SmartKey functions**  
Deactivating ..... 65

**Smartphone**

- see Android Auto
- see Apple CarPlay™
- see Mercedes-Benz Link
- see Telephone

**Snow chains** ..... 418

**Socket (12 V)** ..... 107

Front center console ..... 107

Trunk ..... 109

**Socket (115 V)** ..... 108

Rear passenger compartment ..... 108

**Software update** ..... 284

Important system updates ..... 285

Information ..... 284

Performing ..... 284

**Sound**

PRE-SAFE® Sound ..... 47

Wheels and tires ..... 417

**Sound**

see Burmester® surround sound system

see Sound settings

**Sound settings** ..... 375

Adjusting the balance/fader ..... 376

Adjusting treble, mid-range and bass

settings ..... 375

Automatic volume adjustment ..... 375

Calls up the sound menu ..... 375

Information ..... 375

**Special seat belt retractor** ..... 54

**Specialist workshop** ..... 26

**Speech dialog system**

see Voice Control System

**Speed index (tires)** ..... 433

**Speedometer**

Digital ..... 215

**Standby mode**

Activating/deactivating ..... 157

Function ..... 157

**Standing lights** ..... 113

**Start-off assist**

Activating ..... 181

Function ..... 180

**Start/Stop button**

Parking the vehicle ..... 148

Starting the vehicle ..... 130

Switching on the power supply or

ignition ..... 129

**Start/stop function**

see ECO start/stop function

**Starting assistance**

see Jump-start connection

**Starting the engine**

see Vehicle

**Starting-off aid**

see Hill start assist

**Station**

Deleting ..... 370

Direct frequency entry ..... 369

Moving ..... 370

Searching ..... 369

Setting ..... 369

Storing ..... 369

**Station list**

Calling up ..... 369

**Station presets**

Modifying ..... 370

**STEER CONTROL**

Function/notes ..... 162

- Steering wheel** ..... 209  
 Adjusting (manually) ..... 94  
 Buttons ..... 209  
 Steering wheel heater ..... 95
- Steering wheel heater**  
 Switching on/off ..... 95
- Steering wheel paddle shifters** ..... 142
- Stowage areas**  
 see Loading  
 see Stowage compartment
- Stowage compartment** ..... 99  
 Armrest ..... 99  
 Center console ..... 99  
 Door ..... 99  
 Eyeglasses compartment ..... 100  
 Glove box ..... 99
- Stowage compartments**  
 see Loading  
 see Stowage compartment
- Stowage space under the trunk floor** .... 103
- Suggestions** ..... 259  
 Calling up ..... 260  
 Configuring ..... 260
- Deleting ..... 261  
 Overview ..... 259  
 Renaming ..... 260
- Sulfur content** ..... 452
- Sun visor**  
 Operating ..... 124
- Surround lighting**  
 Switching on/off ..... 117
- Surround View**  
 see 360° Camera
- Suspension**  
 Adaptive damping adjustment ..... 181  
 Damping characteristics ..... 181
- Switch-off delay time**  
 Exterior ..... 117  
 Interior ..... 119
- Synchronization function**  
 Activating/deactivating (multimedia system) ..... 127  
 Switching on/off (control panel) ..... 127
- System settings**  
 Activating/deactivating PIN protection ..... 283  
 Deleting ..... 261  
 Overview ..... 259  
 Renaming ..... 260
- Reset function (multimedia system) .... 286  
 Setting the distance unit ..... 282  
 Setting the time and date automatically ..... 277  
 Setting the time zone ..... 277  
 Setting the time/date format ..... 277  
 Switching transmission of the vehicle position on/off ..... 278
- System settings**  
 see Bluetooth®  
 see Data import/export  
 see Language  
 see MBUX Touch  
 see Software update  
 see Wi-Fi
- T**
- Tailpipes (Care)** ..... 391
- Tank content**  
 Fuel ..... 453  
 Reserve (fuel) ..... 453
- Technical data**  
 Information ..... 447  
 Tire pressure monitor ..... 424

- Vehicle identification plate ..... 449
- Telephone** ..... 219, 327
- Activating functions during a call ..... 333
  - Changing a function ..... 330
  - Connecting a mobile phone (Near Field Communication (NFC)) ..... 331
  - Connecting a mobile phone (Pass-key) ..... 329
  - Connecting a mobile phone (Secure Simple Pairing) ..... 329
  - Disconnecting a mobile phone ..... 330
  - Importing contacts ..... 335
  - Importing contacts (overview) ..... 335
  - Incoming call during an existing call .... 333
  - Information ..... 328
  - Interchanging mobile phones ..... 329
  - Menu (on-board computer) ..... 219
  - Mobile phone voice recognition ..... 332
  - Notes ..... 326
  - Operating modes ..... 328
  - Reception and transmission volume .... 332
  - Replacing mobile phones ..... 330
  - Setting the ringtone ..... 332
  - Switching mobile phones (Near Field Communication (NFC)) ..... 331
  - Telephone menu overview ..... 327
  - Telephone operation ..... 332
  - Using Near Field Communication (NFC) ..... 331
  - Voice commands (Voice Control System) ..... 231
  - Wireless charging (mobile phone) ..... 111
- Telephone**
- see Second telephone
- Telephone number**
- Dialing (on-board computer) ..... 219
- Telephony operating modes**
- Bluetooth® Telephony ..... 328
- Telephony operating modes**
- see Second telephone
- Temperature grade** ..... 430
- Text messages**
- Voice commands (Voice Control System) ..... 235
- Text messages**
- see Messages
- Themes** ..... 257
- Calling up ..... 257
- Deleting ..... 259
  - Displaying information (DIBA) ..... 259
  - Fastening ..... 257
  - Modifying ..... 259
  - Moving ..... 259
  - Overview ..... 257
- Through-loading feature**
- see Seat
- Time**
- Manual time setting ..... 277
  - Setting the time and date automatically ..... 277
  - Setting the time zone ..... 277
  - Setting the time/date format ..... 277
- TIN (Tire Identification Number)** ..... 431
- Tire and Loading Information placard** ... 426
- Tire characteristics** ..... 433
- Tire inflation compressor**
- see TIREFIT kit
- Tire information table** ..... 426
- Tire labeling** ..... 430
- Characteristics ..... 433
  - DOT, Tire Identification Number (TIN) .. 431





















- Load index ..... 433
- Load-bearing capacity ..... 433
- Maximum tire load ..... 432
- Maximum tire pressure ..... 432
- Overview ..... 430
- Speed rating ..... 433
- Temperature grade ..... 430
- Tire Quality Grading ..... 430
- Tire size designation ..... 433
- Traction grade ..... 430
- Tread wear grade ..... 430
- Tire load (maximum)** ..... 432
- Tire pressure** ..... 420, 421
  - Checking (manually) ..... 421
  - Checking (tire pressure monitoring system) ..... 423
  - Maximum ..... 432
  - Notes ..... 419
  - Restarting the tire pressure loss warning system ..... 425
  - Restarting the tire pressure monitoring system ..... 424
  - Tire pressure loss warning system (function) ..... 425
  - Tire pressure monitoring system (function) ..... 422
  - Tire pressure table ..... 420
  - TIREFIT kit ..... 398
- Tire pressure loss warning system**
  - Function ..... 425
  - Restarting ..... 425
- Tire pressure monitor**
  - Restarting ..... 424
  - Technical data ..... 424
- Tire pressure monitoring system**
  - Checking the tire pressure ..... 423
  - Function ..... 422
- Tire pressure table** ..... 420
- Tire Quality Grading** ..... 430
- Tire temperature**
  - Tire pressure monitoring system (function) ..... 422
- Tire tread** ..... 417
- Tire-change tool kit**
  - Overview ..... 441
- TIREFIT kit** ..... 398
  - Storage location ..... 398
- Using ..... 398
- Tires**
  - Changing hub caps ..... 442
  - Characteristics ..... 433
  - Checking ..... 417
  - Checking the tire pressure (manually) ..... 421
  - Checking the tire pressure (tire pressure monitoring system) ..... 423
  - Definitions ..... 435
  - DOT, Tire Identification Number (TIN) .. 431
  - Flat tire ..... 397
  - Installing ..... 445
  - Load index ..... 433
  - Load-bearing capacity ..... 433
  - Maximum tire load ..... 432
  - Maximum tire pressure ..... 432
  - MOExtended tires ..... 397
  - Noise ..... 417
  - Notes on installing ..... 438
  - Overview of tire labeling ..... 430
  - Removing ..... 445
  - Replacing ..... 438, 442
  - Restarting the tire pressure loss warning system ..... 425

- Restarting the tire pressure monitoring system ..... 424
- Rotating ..... 440
- Selection ..... 438
- Snow chains ..... 418
- Speed rating ..... 433
- Storing ..... 441
- Temperature grade ..... 430
- Tire and Loading Information placard ..... 426
- Tire pressure (notes) ..... 419
- Tire pressure loss warning system (function) ..... 425
- Tire pressure monitoring system (function) ..... 422
- Tire pressure table ..... 420
- Tire Quality Grading ..... 430
- Tire size designation ..... 433
- TIREFIT kit ..... 398
- Traction grade ..... 430
- Tread wear grade ..... 430
- Unusual handling characteristics ..... 417
- Tool**
  - see Vehicle tool kit
- Top Tether** ..... 57
- Total distance** ..... 215
  - Displaying ..... 215
- Touch Control** ..... 244
  - On-board computer ..... 210
  - Operating ..... 244
  - Setting acoustic operating feedback ... 245
  - Setting the sensitivity ..... 245
- Touchpad** ..... 246
  - Activating/deactivating haptic operating feedback ..... 247
  - Operating ..... 246
  - Reading the handwriting recognition aloud ..... 247
  - Selecting a station and track ..... 248
  - Setting acoustic operating feedback ... 247
  - Setting the sensitivity ..... 247
- Touchscreen (media display)**
  - Entering characters ..... 272
  - Operating ..... 245
  - Setting acoustic operating feedback ... 246
- Tow-away alarm**
  - Activating/deactivating ..... 86
  - Function ..... 86
- Tow-bar system** ..... 207
- Tow-starting** ..... 413
- Towing away** ..... 409
- Towing eye**
  - Installing ..... 413
  - Storage location ..... 412
- Towing methods** ..... 408
- Traction grade** ..... 430
- Traffic information** ..... 312
  - Car-to-X-Communication ..... 314
  - Displaying the traffic map ..... 312
  - Displaying traffic incidents ..... 313
  - Live Traffic Information ..... 312
  - Overview ..... 312
  - Switching on the display ..... 314
- Traffic map**
  - see Map
- Traffic Sign Assist** ..... 200
  - Function/notes ..... 200
  - Setting ..... 201
  - System limitations ..... 200
- Transferred vehicle data**
  - Android Auto ..... 345
  - Apple CarPlay™ ..... 345

- Baidu CarLife ..... 345
- Transmission (problem)** ..... 144
- Transmission position display** ..... 140
- Transporting**
- Vehicle ..... 411
- Tread wear grade** ..... 430
- Trim element (Care)** ..... 392
- Trip**
- Menu (on-board computer) ..... 215
- Trip computer**
- Displaying ..... 215
- Resetting ..... 216
- Trip distance** ..... 215
- Displaying ..... 215
- Resetting ..... 216
- Trip odometer**
- see Trip distance
- Trunk lid**
- Closing ..... 74
- Emergency release (from inside) ..... 76
- HANDS-FREE ACCESS ..... 74
- Opening ..... 73
- Opening dimensions ..... 457
- TuneMix**
- Creating a list ..... 374
- Turn signal indicator**
- see Turn signals
- Turn signals** ..... 114
- Switching on/off ..... 114
- Two phone mode**
- see Second telephone
- Two-way radios**
- Frequencies ..... 448
- Notes on installation ..... 447
- Transmission output (maximum) ..... 448
- U**
- Units of measurement**
- Setting ..... 282
- Unlocking setting** ..... 65
- USB port** ..... 109
- User profile**
- see Profile
- Using the telephone**
- see Calls
- V**
- Vehicle** ..... 130
- Activating/deactivating standby mode ..... 157
- Correct use ..... 27
- Damage detection (parking) ..... 156
- Data acquisition ..... 28
- Data storage ..... 28
- Diagnostics connection ..... 26
- Equipment ..... 22
- Limited Warranty ..... 28
- Locking (automatically) ..... 71
- Locking (from the inside) ..... 69
- Locking (KEYLESS-GO) ..... 69
- Locking/unlocking (emergency key) ..... 72
- Lowering ..... 446
- Maintenance ..... 23
- Parking for an extended period ..... 156
- Problem notification ..... 27
- QR code rescue card ..... 28
- Qualified specialist workshop ..... 26
- Raising ..... 443

- Standby mode function ..... 157
- Starting (emergency operation mode) ..... 130
- Starting (Remote Online) ..... 132
- Starting (start/stop button) ..... 130
- Switching off (start/stop button) ..... 148
- Towing ..... 207
- Unlocking (from the inside) ..... 69
- Unlocking (KEYLESS-GO) ..... 69
- Ventilating (convenience opening) ..... 78
- Voice commands (Voice Control System) ..... 236
- Vehicle data**
- Displaying (DYNAMIC SELECT) ..... 139
- Roof load ..... 458
- Transferring to Android Auto ..... 345
- Transferring to Apple CarPlay™ ..... 345
- Transferring to Baidu CarLife ..... 345
- Turning circle ..... 457
- Vehicle height ..... 457
- Vehicle length ..... 457
- Vehicle width ..... 457
- Wheelbase ..... 457
- Vehicle data storage**
- Event data recorders ..... 30
- MBUX multimedia system/Mercedes me connect ..... 30
- Vehicle dimensions** ..... 457
- Vehicle electronics**
- Notes ..... 447
- Two-way radios ..... 447
- Vehicle identification number**  
  see VIN
- Vehicle identification plate** ..... 449
- Paint code ..... 449
- VIN ..... 449
- Vehicle interior**
- Cooling or heating (Remote Online) ..... 131
- Vehicle key**  
  see SmartKey
- Vehicle maintenance**  
  see ASSYST PLUS
- Vehicle operation**
- Outside the USA or Canada ..... 23
- Vehicle position**
- Switching transmission on/off ..... 278
- Vehicle tool kit** ..... 398
- TIREFIT kit ..... 398
- Towing eye ..... 412
- Ventilating**
- Convenience opening ..... 78
- Vents**  
  see Air vents
- VIN** ..... 449
- Engine compartment ..... 449
- Identification plate ..... 449
- Windshield ..... 449
- Vision**
- Removing condensation from the windows ..... 127
- Voice Control System** ..... 222
- Audible help functions ..... 225
- Improving speech quality ..... 225
- Language setting ..... 224
- Media player voice commands ..... 233
- Message voice commands ..... 235
- Multifunction steering wheel (operating) ..... 222
- Navigation voice commands ..... 227
- Notes on the voice commands ..... 226
- Online voice control ..... 226
- Operable functions ..... 224



- Operating safety ..... 222
  - Setting (multimedia system) ..... 224
  - Switch voice commands ..... 226
  - Telephone voice controls ..... 231
  - Text message voice commands ..... 235
  - Vehicle voice commands ..... 236
  - Voice prompting ..... 223
  - Voice control system**  
see Voice Control System
- W**
- Warning lamps**  
see Warning/indicator lamps
  - Warning system**  
see ATA (anti-theft alarm system)
  - Warning triangle**  
Removing ..... 396  
Setting up ..... 396
  - Warning/indicator lamp**
    -  ABS warning lamp ..... 505
    -  Brake warning lamp (USA) ..... 508
    -  Brakes warning lamp (Canada) .... 508
    -  Coolant warning lamp ..... 513
    -  Electrical malfunction warning lamp ..... 512
    -  Engine diagnosis warning lamp .... 512
    -  ESP® OFF warning lamp ..... 507
    -  ESP® warning lamp flashes ..... 506
    -  ESP® warning lamp lights up ..... 506
    -  Fuel reserve warning lamp ... 512, 513
    -  Red indicator lamp, electric parking brake applied (Canada only) ... 509
    -  Red indicator lamp, electric parking brake applied (USA only) ..... 509
    -  Restraint system warning lamp .... 510
    -  Seat belt warning lamp flashes .... 511
    -  Seat belt warning lamp lights up ..... 510
    -  Tire pressure monitoring system warning lamp flashes ..... 516
    -  Tire pressure monitoring system warning lamp lights up ..... 515
    -  Warning lamp for distance warning function ..... 511
    -  Warning lamp for electric power steering ..... 516
    -  Yellow electric parking brake indicator lamp is malfunctioning ..... 509
  - Warning/indicator lamps** ..... 504  
Overview ..... 504  
PASSENGER AIR BAG ..... 45
  - Warranty** ..... 28
  - Washer fluid**  
see Windshield washer fluid
  - Washing by hand (care)** ..... 387
  - Water tank**  
see Air-water duct
  - Weather information** ..... 322
  - Web browser**
    - Calling up a web page ..... 355
    - Calling up options ..... 357
    - Calling up the settings ..... 357
    - Deleting a bookmark ..... 357
    - Deleting Internet history ..... 357

- Ending ..... 358
- Managing bookmarks ..... 357
- Overview ..... 356
- Website**
  - Calling up ..... 355
- Wheel change**
  - Lowering the vehicle ..... 446
  - Mounting a new wheel ..... 445
  - Removing a wheel ..... 445
  - Removing/installing hub caps ..... 442
- Wheel rotation** ..... 440
- Wheels**
  - Care ..... 391
  - Changing hub caps ..... 442
  - Checking ..... 417
  - Checking the tire pressure (manually) ..... 421
  - Checking the tire pressure (tire pressure monitoring system) ..... 423
  - Definitions ..... 435
  - DOT, Tire Identification Number (TIN) .. 431
  - Flat tire ..... 397
  - Installing ..... 445
  - Load index ..... 433
  - Load-bearing capacity ..... 433
  - Maximum tire load ..... 432
  - Maximum tire pressure ..... 432
  - MOExtended tires ..... 397
  - Noise ..... 417
  - Notes on installing ..... 438
  - Overview of tire labeling ..... 430
  - Removing ..... 445
  - Replacing ..... 438, 442
  - Restarting the tire pressure loss warning system ..... 425
  - Restarting the tire pressure monitoring system ..... 424
  - Rotating ..... 440
  - Selection ..... 438
  - Snow chains ..... 418
  - Speed rating ..... 433
  - Storing ..... 441
  - Temperature grade ..... 430
  - Tire and Loading Information placard ..... 426
  - Tire characteristics ..... 433
  - Tire pressure (notes) ..... 419
  - Tire pressure loss warning system (function) ..... 425
  - Tire pressure monitoring system (function) ..... 422
  - Tire pressure table ..... 420
  - Tire Quality Grading ..... 430
  - Tire size designation ..... 433
  - TIREFIT kit ..... 398
  - Traction grade ..... 430
  - Tread wear grade ..... 430
  - Unusual handling characteristics ..... 417
- Wi-Fi** ..... 278
  - Overview ..... 278
  - Setting ..... 279
  - Setting up a hotspot ..... 280
- Widescreen Cockpit Instrument Display**
  - Instrument cluster ..... 12
- Window curtain airbag** ..... 40
- Windows**
  - see Side windows
- Windows (Care)** ..... 391
- Windshield** ..... 120
  - Replacing the wiper blades ..... 120

**Windshield**

see Windshield

**Windshield washer fluid** ..... 455

Notes ..... 455

**Windshield washer system**

Topping up ..... 384

**Windshield wipers**

Activating/deactivating ..... 119

Replacing the wiper blades ..... 120

**Winter operation**

Snow chains ..... 418

**Wiper blades**

Care ..... 391

Replacing ..... 120

**Wireless charging**

Function/notes ..... 109

Mobile phone ..... 111

**Wireless vehicle components**

Declaration of conformity ..... 25

**Workshop**

see Qualified specialist workshop

