



#### Digital - in the vehicle

Explore the Operator's Manual in the multimedia system under "Vehicle". Begin with Quick Start and discover highlights and useful tips.



#### Vehicle document wallet

This contains a physical copy of comprehensive information about operating your vehicle and about services and your vehicle's warranty.



2545848603

Order no. P254 0151 13 Part no. 254 584 86 03  
Edition C-2024

GLC Coupe



Mercedes-Benz

## GLC Coupe

Operator's Manual

Mercedes-Benz



## Front passenger air bag warning

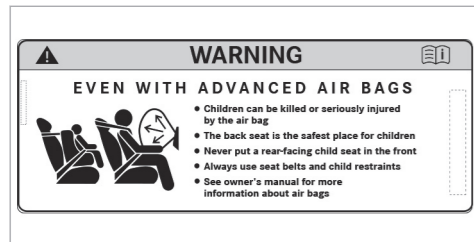

Air bag warning sticker for USA and Canada

## **⚠ WARNING** Risk of injury or fatal injuries if the front passenger air bag is enabled

If the front passenger air bag is enabled, a child on the front passenger seat may be struck by the front passenger air bag in the event of an accident.

- ▶ NEVER use a rearward-facing child restraint system on a seat with an ENABLED FRONT AIR BAG. This can result in the DEATH of or SERIOUS INJURY to the CHILD.

Observe the chapter "Children in the vehicle".

## Publication details

### Internet

Further information about Mercedes-Benz vehicles and about Mercedes-Benz AG can be found on the following websites:

<https://www.mbusa.com> (USA only)

<https://www.mercedes-benz.ca> (Canada only)

### Documentation team

©Mercedes-Benz AG: Not to be reprinted, translated or otherwise reproduced, in whole or in part, without written permission from Mercedes-Benz AG.

### Vehicle manufacturer

Mercedes-Benz AG

Mercedesstraße 120

70372 Stuttgart

Germany

## Welcome to the world of Mercedes-Benz

Before your first drive, please read this Operator's Manual carefully and familiarize yourself with your vehicle. For your own safety and a longer service life of the vehicle, follow the instructions and warning notices in this Operator's Manual. Disregarding them may lead to damage to the vehicle or injury to people.

Damage to the vehicle resulting from the disregard of the instructions is not covered by the Mercedes-Benz Limited warranty.

The standard equipment and product description of your vehicle may vary and depends on the following factors:

- Model
- Order
- National version
- Availability

Your vehicle may therefore differ from that shown in the descriptions and illustrations in individual cases.

Mercedes-Benz reserves the right to introduce changes in the following areas:

- Design
- Equipment
- Technical features

The following documents are components of the vehicle:

- Digital Operator's Manual
- Printed Operator's Manual
- Maintenance Booklet
- Supplementary manuals relating to specific equipment
- Supplementary documents

Keep these documents in the vehicle at all times. Ensure that all documents are in the vehicle or passed on in the event of sale or rental.

Mercedes-Benz USA, LLC

Mercedes-Benz Canada, Inc.

A Mercedes-Benz Group AG Company

2545848603



<b>Symbols</b> .....	5	National information for components relevant to radio regulation .....	29	<b>Children in the vehicle</b> .....	56
<b>At a glance</b> .....	6	Diagnostics connection .....	30	Brief overview of most important points .....	56
Cockpit .....	6	Qualified specialist workshop .....	31	Important safety notes .....	56
Cockpit (plug-in hybrid) .....	8	Correct use of the vehicle .....	31	Suitable child restraint systems for the transport of children .....	62
Indicator and warning lamps .....	10	Notes for persons with electronic medical aids .....	31	Securing the child restraint system .....	62
Overhead control panel .....	14	Problems with your vehicle .....	32	Child safety locks .....	68
Door operating unit and seat adjustment .....	16	Reporting safety defects .....	32	Occupant presence reminder .....	70
Emergencies and breakdowns .....	18	Limited Warranty .....	33	<b>Opening and closing</b> .....	71
<b>Digital Operator's Manual</b> .....	20	QR code for rescue card .....	33	SmartKey .....	71
Calling up the Digital Operator's Manual .....	20	Data storage .....	34	Digital Vehicle Key .....	75
<b>General notes</b> .....	21	Copyright .....	38	Doors .....	77
Protecting the environment .....	21	<b>Occupant safety</b> .....	39	Running boards .....	81
Mercedes-Benz Genuine Parts .....	22	Brief overview of the most important points .....	39	Cargo compartment .....	81
Operator's Manual .....	23	Information on the automatic functions of the restraint system .....	46	Side windows .....	87
Touch-sensitive controls .....	23	Purpose and function of the restraint system .....	50	Sliding sunroof .....	90
Mercedes me App .....	24	Seat belts .....	55	Anti-theft protection .....	94
Service and vehicle operation .....	24	Airbags .....	55	<b>Seats and stowing</b> .....	98
Operating safety .....	25			Notes on the correct driver's seat position .....	98
Fitting the license plate to the front license plate holder .....	29			Notes on grab handles .....	98
				Seats .....	99
				Steering wheel .....	107

Easy entry and exit feature .....	110	Automatic transmission .....	189	Using MBUX Voice Assistant effectively .....	310
Memory function .....	111	Function of the 4MATIC .....	193	Essential voice commands .....	311
Stowage areas .....	113	Refueling .....	193		
Cup holder .....	125	Charging the high-voltage battery (plug-in hybrid) .....	196	<b>MBUX multimedia system .....</b>	<b>316</b>
Sockets .....	128	Parking .....	213	Overview and operation .....	316
Wireless charging of the mobile phone and connection with the exterior antenna ....	129	Driving and driving safety systems .....	221	System settings .....	328
Installing/removing the floor mats .....	131	Trailer hitch .....	296	AMG TRACK PACE .....	333
		Vehicle towing instructions .....	299	Plug-in hybrid settings .....	337
				Off-road menu .....	339
<b>Light and visibility .....</b>	<b>133</b>			Navigation and traffic .....	340
Exterior lighting .....	133	<b>Driver's display .....</b>	<b>301</b>	Telephone .....	351
Interior lighting .....	142	Notes on the driver display .....	301	Mercedes me Apps .....	354
Windshield wiper and windshield washer system .....	144	Operating the driver's display .....	301	Mercedes-Benz emergency call system .....	361
Mirrors .....	147	Driver display menus .....	302	Radio & media .....	365
		Head-up Display .....	303	Sound settings .....	369
		Vehicles with a 48 V on-board electrical system .....	305		
<b>Climate control .....</b>	<b>151</b>	Function of the power meter .....	306	<b>Maintenance and care .....</b>	<b>371</b>
Overview of climate control systems .....	151	Overview of status displays on the driver's display .....	306	ASSYST PLUS service interval display .....	371
Operating the climate control system .....	153			Maintenance Management .....	372
				Telediagnosis .....	372
<b>Driving and parking .....</b>	<b>162</b>	<b>MBUX voice assistant .....</b>	<b>308</b>	Engine compartment .....	373
Driving .....	162	Notes on operating safety .....	308	Cleaning and care .....	379
DYNAMIC SELECT .....	185	Operation .....	308		

---

<b>Breakdown assistance</b> .....	<b>389</b>	Vehicle electronics .....	443
Emergency .....	389	Radio regulations .....	445
Flat tire .....	390	Vehicle identification plate, VIN and engine number overview .....	445
Battery (vehicle) .....	396	Operating fluids .....	447
Tow starting or towing away .....	404	Vehicle data .....	454
Electrical fuses .....	409	Trailer hitch .....	455
<hr/>			
<b>Wheels and tires</b> .....	<b>413</b>	<b>Display messages and warning/indicator lamps</b> .....	<b>457</b>
Notes on noise or unusual handling char- acteristics .....	413	Display messages .....	457
Notes on regularly inspecting wheels and tires .....	413	Warning and indicator lamps .....	531
Notes on snow chains .....	414	<hr/>	
Activating or deactivating snow chain mode .....	414	<b>Index</b> .....	<b>551</b>
Tire pressure .....	414		
Loading the vehicle .....	420		
Tire labeling .....	424		
Definition of terms for tires and loading .....	429		
Changing a wheel .....	431		
Emergency spare wheel .....	441		
<hr/>			
<b>Technical data</b> .....	<b>443</b>		
Notes on technical data .....	443		

In this Operator's Manual, you will find the following symbols:

 **WARNING** Danger due to failure to observe the warning notices

Warning notices draw your attention to hazards that may endanger your health or life, or the health or life of others.

 Observe the warning notices.

 **ENVIRONMENTAL NOTE** Environmental damage due to failure to observe environmental notes

Environmental notes include information on environmentally responsible behavior or environmentally responsible disposal.

 Observe environmental notes.

 **NOTE** Damage to property due to failure to observe notes on material damage

Notes on material damage inform you of risks which may lead to your vehicle being damaged.

 Observe notes on material damage.

 These symbols indicate useful instructions or further information that could be helpful to you.

 Instruction

(→ page) Further information on a topic

**Display** Display in the central display

 Highest menu level, which is to be selected in the multimedia system





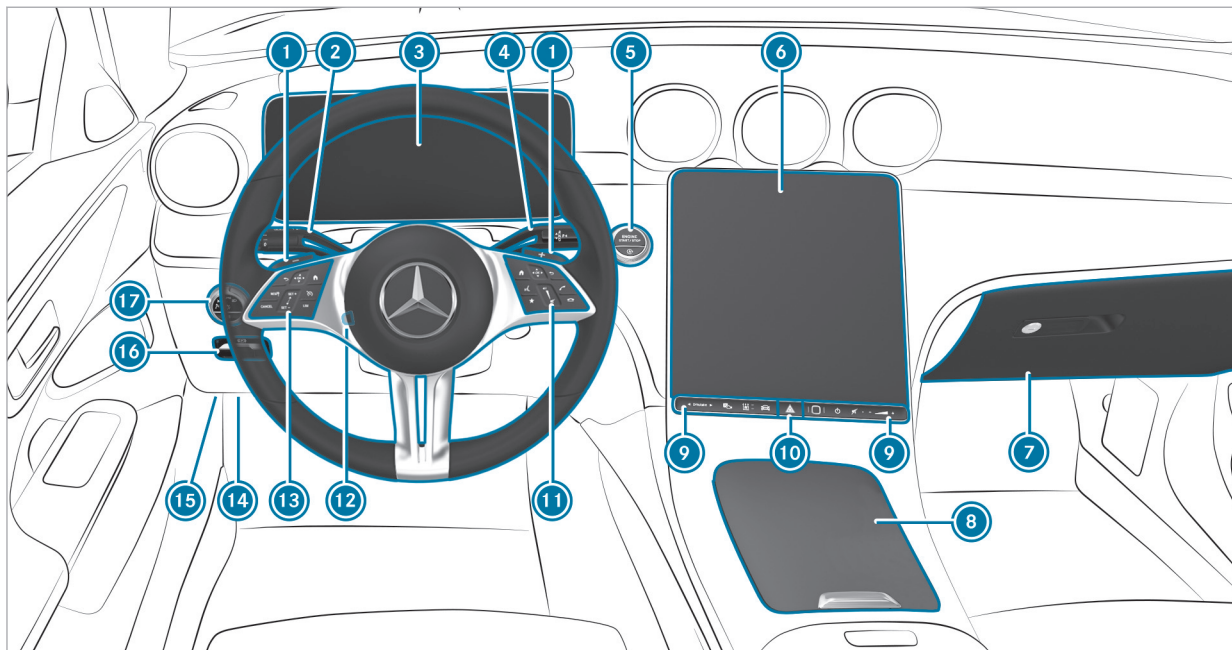







 Relevant submenus, which are to be selected in the multimedia system

\* Indicates a cause





Left-hand drive vehicles



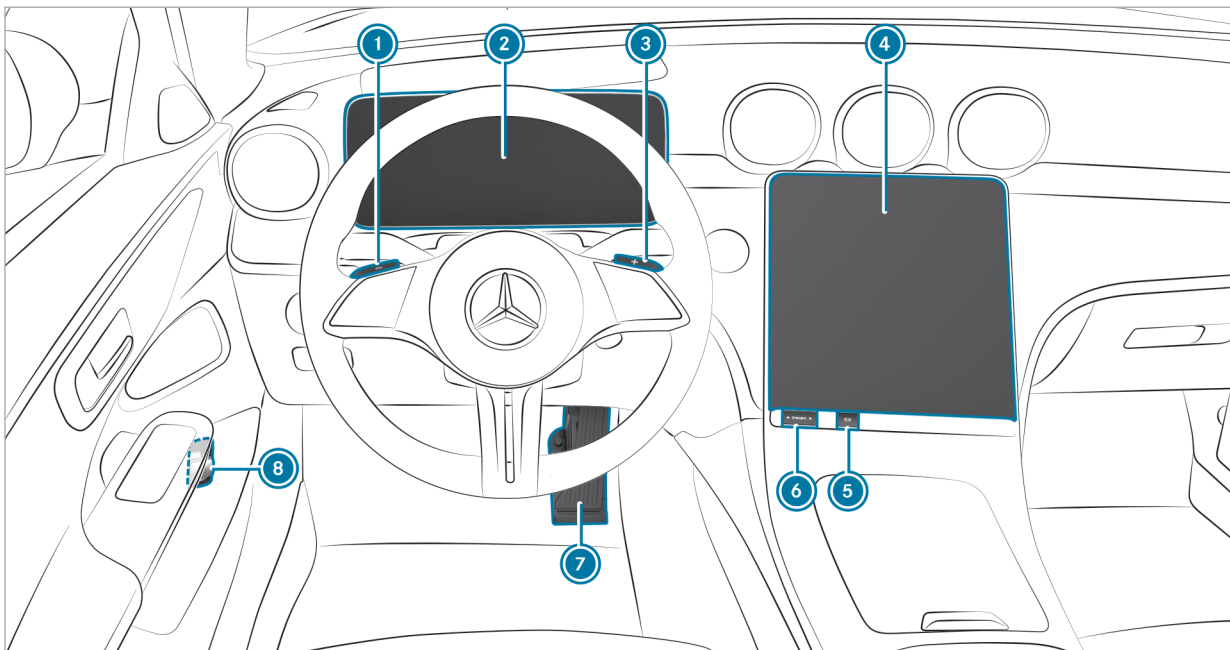

1	Steering wheel paddle shifters	→	191				
2	Combination switch	→	134				
3	Driver's display	→	301				
4	DIRECT SELECT lever	→	189				
5	 Start/stop button	→	166				
	 ECO start/stop function	→	178				
6	Central display	→	316				
7	Glove box	→	116				
8	Stowage compartment	→	116				
9	Switch panel for:						
	 DYNAMIC SELECT button	→	187				
	 Active Parking Assist	→	282				
	 Quick vehicle access						
	 Fingerprint sensor						
	 Switches the MBUX multimedia system on/off	→	316				
	 Switches sound on/off	→	316				
	 Adjusts the volume	→	316				
10	 Hazard warning light system	→	135				
11	Control panel for the MBUX multimedia system	→	322				
12	Adjusts the steering wheel	→	108				
13	Control panel:						
	Driver's display	→	301				
	Cruise control	→	232				
	 Active Distance Assist DISTRONIC	→	236				
14	Diagnostics connection	→	30				
15	Opens the hood	→	373				
16	 Electric parking brake	→	217				
17	Light switch	→	133				



Left-hand drive vehicles







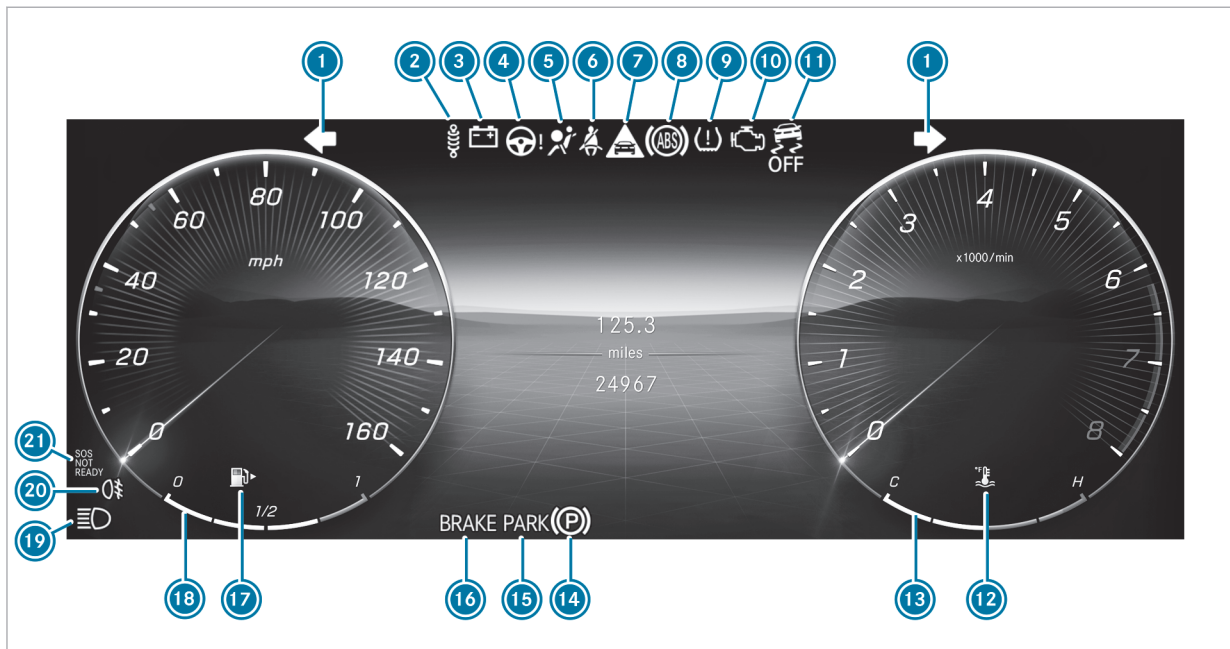



















①	 Increases recuperation	→	181
②	Driver's display:		
	 Operational readiness	→	306
	Trip computer		
	ECO Assist	→	182
③	 Reduces recuperation	→	181
④	Central display:		

	Plug-in hybrid settings	→	337
	Energy flow display	→	339
⑤	Sets charging times	→	337
⑥	 DYNAMIC SELECT button	→	185
⑦	 Haptic accelerator pedal	→	184
⑧	 Depressurizes the fuel tank	→	196

10 At a glance - Indicator and warning lamps





Driver's display

1		Turn signal lights	→	134
2		Indicator lamp inoperative		
3		Electrical malfunction	→	538
4		Power steering (red)	→	536
		Power steering (yellow)	→	536
		Rear axle steering (red)	→	536
		Rear axle steering (yellow)	→	536
5		Restraint system	→	533
6		Seat belt	→	533
7		Distance warning	→	545
8		ABS	→	545
9		Tire pressure monitoring system	→	549
10		Engine diagnosis	→	538
11		ESP® OFF	→	545
		ESP®	→	545
12		Coolant temperature	→	538
13		Coolant temperature display		
14		Electric parking brake (yellow)	→	542
15		Electric parking brake (red)	→	542
		USA only		
		Canada only		
16		Brakes (red)	→	542
		USA only		
		Canada only		
		Recuperative Brake System, USA only	→	542
		Brakes (yellow), Canada only	→	542
17		Reserve fuel with fuel filler flap location indicator	→	538
18		Fuel level		
19		High beam	→	134
		Low beam	→	133
		Standing lights	→	133



## 12 At a glance - Indicator and warning lamps

---

  Rear fog light



134

  Mercedes-Benz emergency call system







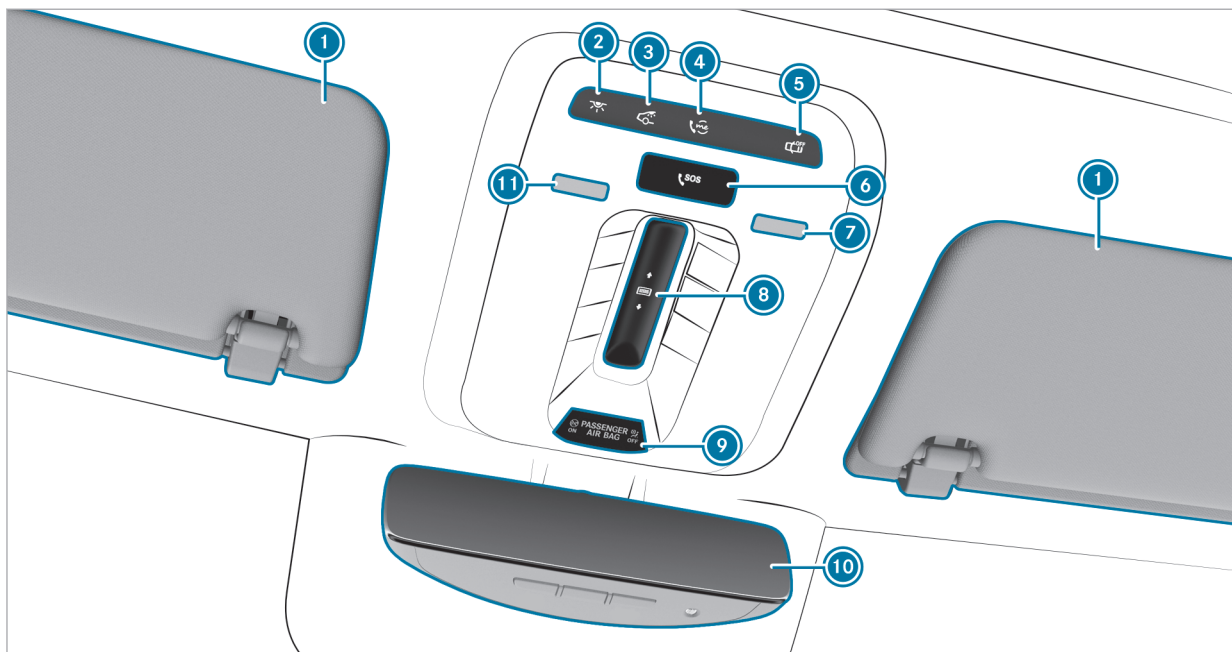

549



14 At a glance - Overhead control panel









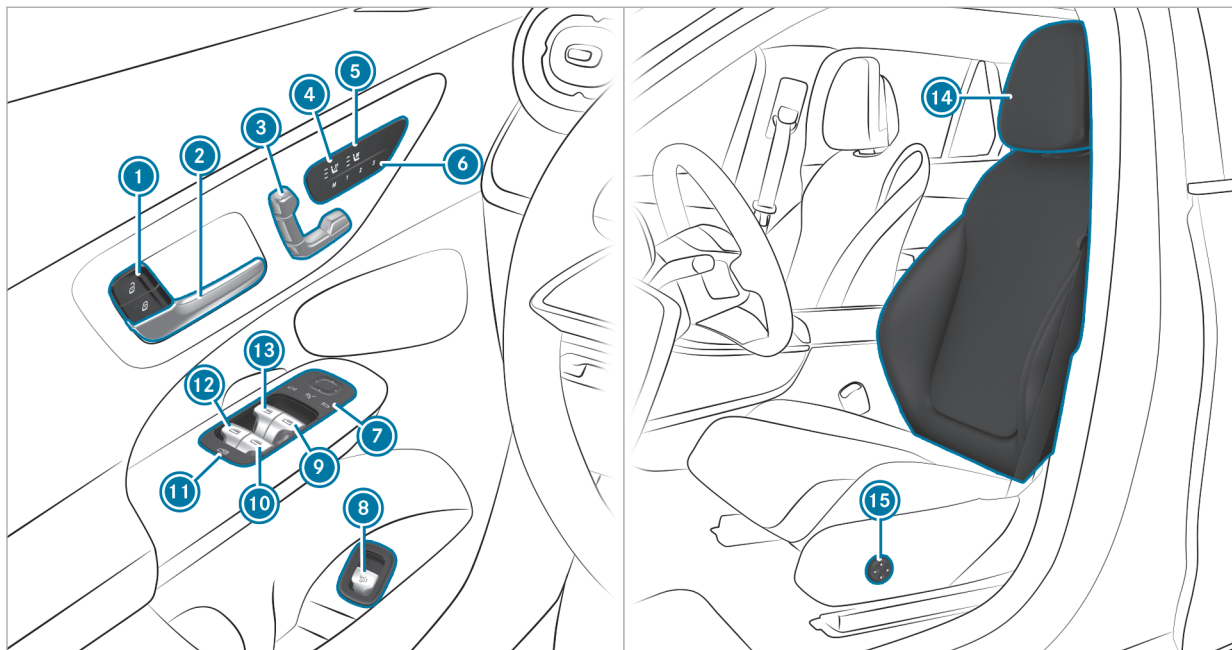





①	Sun visors (folding, available in extendable design as an optional extra)		
②	 Switches the front interior lighting on/off	→	142
③	 Switches the rear interior lighting on/off	→	142
④	 me button	→	354
⑤	 Switches automatic interior lighting control on/off	→	142
⑥	 SOS button	→	354
⑦	Switches the right-hand reading lamp on/off	→	142
⑧	 Opens/closes the panorama roof with power tilt/sliding panel	→	90
	 Opens/closes the panorama roof with power tilt/sliding panel roller sunblind	→	90
⑨	PASSENGER AIR BAG indicator lamp	→	44
⑩	Inside rear-view mirror	→	148
⑪	Switches the left-hand reading lamp on/off	→	142



16 At a glance - Door operating unit and seat adjustment

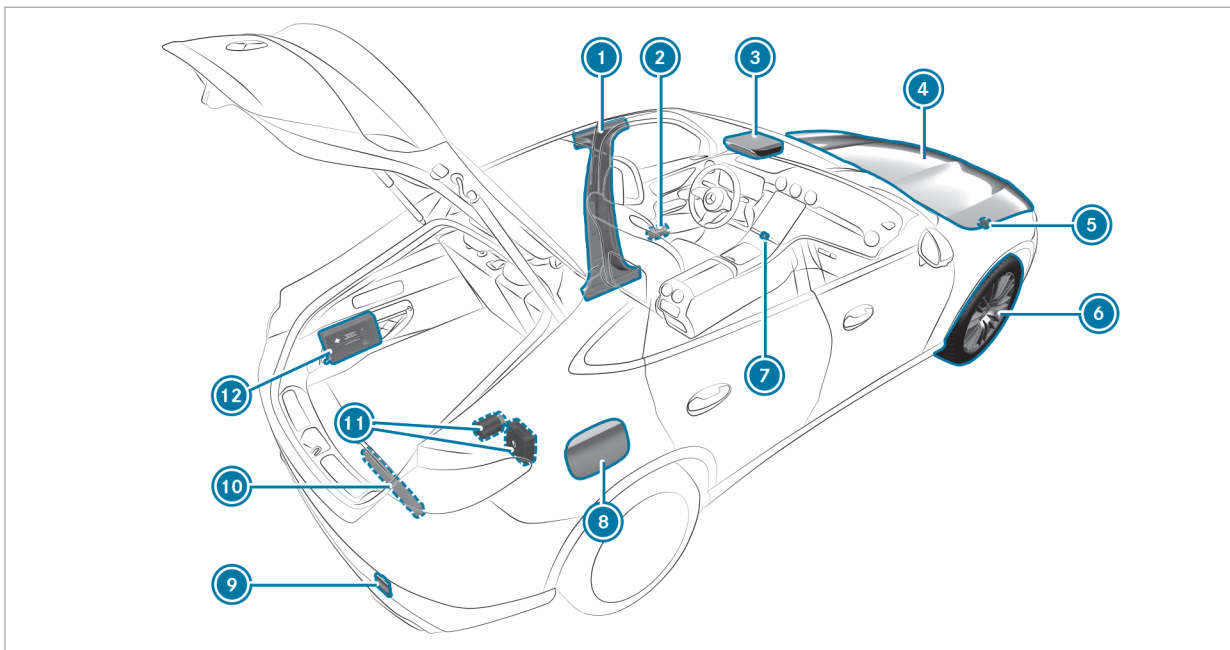

①	 	Locks/unlocks the vehicle	→	78
②		Opening the door	→	77
③		Adjusts the seats electrically	→	101
④		Switches the seat heating on/off	→	106
⑤		Switches the seat ventilation on/off	→	107
⑥	<b>M</b>	Operates the memory function	→	112
⑦		Operates the outside mirrors	→	147
⑧		Opens/closes the tailgate	→	81

⑨		Opens/closes the right side window	→	87
⑩		Opens/closes the rear right side window	→	87
⑪		Child safety lock for the rear side windows	→	69
⑫		Opens/closes the rear left side window	→	87
⑬		Opens/closes the left side window	→	87
⑭		Adjusts the head restraints	→	102
⑮		Adjusts the 4-way lumbar support	→	102



1	B-pillar with:		
	QR code for accessing the rescue card	→	33
2	Safety vests	→	389
3	 me button	→	354
	 SOS button	→	354
4	To check and refill operating fluids	→	447
	Starting assistance	→	401
5	Tow-starting or towing away	→	405
6	Flat tire	→	390
7	 Hazard warning lamps	→	135
8	Fuel filler flap with:		
	Information label on fuel type	→	193
	Information label on tire pressure	→	416
	QR code for accessing the rescue card	→	33
9	Tow-starting or towing away	→	405
10	Warning triangle	→	390
11	TIREFIT kit	→	392
12	First-aid kit (soft sided)	→	390

## Calling up the Digital Operator's Manual

Multimedia system:

→  » Settings » Info

» Operator's Manual

» Open Digital Operator's Manual

The Digital Operator's Manual describes the functions and operation of the vehicle and the multimedia system.

▶ Select one of the following menu items in the Digital Operator's Manual:

- **Quick start:** find the first steps towards adjusting your seat (driver's side).
- **Tips:** find information that prepares you for certain everyday situations with your vehicle.
- **Animations:** watch animations of the vehicle functions.
- **Messages:** receive additional information about the messages in the driver's display.
- **Language:** select the language for the Digital Operator's Manual.

You can search for keywords using the search field **Search**, in order to find quick answers to questions about the operation of the vehicle.

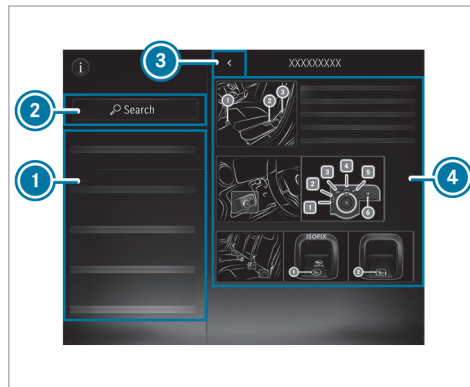

- 1 Menu
- 2 Search
- 3 Back
- 4 Contents section

Some sections in the Digital Operator's Manual, such as warning notes, can be expanded and collapsed.

**Additional methods of calling up the Digital Operator's Manual:**

**Driver's display:** call up brief information as display messages in the driver's display

**MBUX Voice Assistant:** call up via the voice control system

**Global search:** call up search results for contents of the Digital Operator's Manual in the home screen

For safety reasons, the Digital Operator's Manual is deactivated while driving.

## Protecting the environment

 **ENVIRONMENTAL NOTE** Environmental damage due to operating conditions and personal driving style

The pollutant emission of the vehicle is directly related to the way you operate the vehicle.

Operate your vehicle in an environmentally responsible manner to help protect the environment. Please observe the following recommendations on operating conditions and personal driving style.

### Operating conditions:

- ▶ Make sure that the tire pressure is correct.
- ▶ Do not carry any unnecessary weight (e.g. roof luggage racks once you no longer need them).
- ▶ Adhere to the service intervals. A regularly serviced vehicle will contribute to environmental protection.

- ▶ Always have maintenance work carried out at a qualified specialist workshop.

### Personal driving style:

- ▶ Do not depress the accelerator pedal when starting the engine.
- ▶ Do not warm up the vehicle while stationary.
- ▶ Drive carefully and maintain a suitable distance from the vehicle in front.
- ▶ Avoid frequent, sudden acceleration and braking.
- ▶ Change gear in good time and use each gear only up to  $\frac{2}{3}$  of its maximum engine speed.
- ▶ Switch off the vehicle in stationary traffic, e.g. by using the ECO start/stop function.
- ▶ Drive in a fuel-efficient manner. Observe the ECO display for an economical driving style.

## Plug-in hybrid

 **ENVIRONMENTAL NOTE** Environmental pollution caused by irresponsible disposal of the high-voltage battery

A high-voltage battery contains materials which are harmful to the environment.

- ▶ Dispose of defective high-voltage batteries at a qualified specialist workshop.

### Environmental issues and recommendations:

It is recommended that you re-use or recycle materials instead of just disposing of them.

The relevant environmental guidelines and regulations serve to protect the environment and must be strictly observed.

### Mercedes-Benz Genuine Parts

 **ENVIRONMENTAL NOTE** Environmental damage due to not using recycled reconditioned components

Mercedes-Benz AG offers recycled reconditioned components and parts with the same quality as new parts. The same entitlement from the Limited Warranty is valid as for new parts.

- ▶ Use recycled reconditioned components and parts from Mercedes-Benz AG.

 **NOTE** Impairment of the operating efficiency of the restraint systems from installing accessory parts or from repairs or welding

Air bags and Emergency Tensioning Devices, as well as control units and sensors for the restraint systems, may be installed in the following areas of your vehicle:

- doors

- door pillars
- sill
- seats
- cockpit
- driver's display
- center console
- lateral roof frame

- ▶ Do not install accessory parts such as audio systems in these areas.
- ▶ Do not carry out repairs or welding.
- ▶ Have accessories retrofitted at a qualified specialist workshop.

You could jeopardize the operating safety of your vehicle if you use parts, tires and wheels as well as accessories relevant to safety that have not been approved by Mercedes-Benz. Safety-critical systems (e.g. the brake system) may malfunction. Use only Mercedes-Benz Genuine Parts or parts of equal quality. Use only tires, wheels and accessory parts that have been specifically approved for your vehicle model.

Mercedes-Benz Genuine Parts are subject to strict quality inspections. Each part has been specially developed, manufactured or selected for Mercedes-Benz vehicles and adapted to them. Therefore, only Mercedes-Benz Genuine Parts should be used.

More than 300,000 different Mercedes-Benz Genuine Parts are available for Mercedes-Benz models.

All authorized Mercedes-Benz Service Centers maintain a supply of Mercedes-Benz Genuine Parts for necessary service and repair work. In addition, strategically located parts delivery centers provide for quick and reliable parts service.

Always specify the vehicle identification number (VIN) (→ page 445) when ordering Mercedes-Benz Genuine Parts.



## Operator's Manual

This Operator's Manual and the Digital Operator's Manual in the vehicle describe the following models and the standard and special equipment for your vehicle:

- The models and the standard and special equipment available at the time of this Operator's Manual going to press.
- The models and the standard and special equipment only available in certain countries.
- The models and the standard and special equipment, which will only be available at a later date.

Note that your vehicle may not have all features described. This is also the case for systems relevant to safety. Therefore, the equipment on your vehicle may differ from that in the descriptions and illustrations.

The original purchase agreement for your vehicle contains a list of the equipment in your vehicle at the time of delivery.

Should you have any questions concerning equipment and operation, please consult an authorized Mercedes-Benz Center.

- ⓘ Please bear in mind that all the speed values stated in this Operator's Manual are approximate and are subject to a certain tolerance.

The Operator's Manual, Supplement, further supplementary documents and Maintenance Booklet are important documents and should be kept in the vehicle.

## Touch-sensitive controls

In addition to conventional switches and buttons, your vehicle is equipped with touch-sensitive controls.

These are located in the following areas of your vehicle:

- Roof and door control panel
- Climate control
- Steering wheel
- MBUX multimedia system

The controls have touch-sensitive user interface surfaces. You can control these surfaces by pressing or swiping to adjust settings or to trigger functions, for example.

When using touch-sensitive user interfaces, note the following points to avoid problems:

- Do not affix stickers or similar objects to the surfaces.
- Do not attach smartphone holders or other mountings to the surface of the central display.
- Keep the surfaces protected from moisture and wet conditions.
- Keep the surfaces free of dust and dirt (→ page 385).

Some touch-sensitive controls have both a symbol and integrated indicator lamps. Be sure to press on the symbol of the control element when using it.

## Mercedes me App

### Notes about the on-demand feature

You can also activate various functions (on-demand feature) subsequently via Mercedes me after purchasing your vehicle.

Information is available at any authorized Mercedes-Benz Center.

### Activating on-demand feature using Mercedes me

#### Requirements

- The vehicle has a wireless connection.
- The vehicle is linked to the Mercedes me user account.

#### Ordering and activating on-demand feature

- ▶ Add the desired on-demand feature for the vehicle to the shopping basket in the Mercedes me Store.
- ▶ Complete the order.  
The on-demand feature is activated when operating the vehicle.

#### Speeding up activation

- ▶ Switch the vehicle off and lock it.
- ▶ Unlock the vehicle after about two minutes and switch on the vehicle.  
The on-demand feature has been activated.  
For some features, a notification also appears in the vehicle's multimedia system.

If the activation was not successful, repeat the process.

## Service and vehicle operation

### Vehicle operation outside the USA or Canada

When you are abroad with your vehicle, observe the following points:

- service points or replacement parts may not be available immediately.
- unleaded fuel may not be available for vehicles with a catalytic converter. Leaded fuel may cause damage to the catalytic converter.
- the fuel may have an extremely low octane number. Unsuitable fuel can cause engine damage.

Some Mercedes-Benz models are available in Europe through our European Delivery Program. For more information, please consult an authorized Mercedes-Benz Service Center, or write to one of the following addresses:

#### **in the USA:**

Mercedes-Benz USA, LLC  
European Delivery Department  
One Mercedes-Benz Drive  
Sandy Springs, GA 30328

#### **in Canada:**

Mercedes-Benz Canada, Inc.  
European Delivery Department  
98 Vanderhoof Avenue  
Toronto, Ontario M4G 4C9

### Maintenance

Your customer advisor confirms the service in the service report.

### Roadside Assistance

The Mercedes-Benz Roadside Assistance Program offers technical help in the case of a breakdown. Your calls to the toll-free Roadside Assistance Hotline are answered by our agents 24 hours a day, 365 days a year.

1-800-FOR-MERCEdes (1-800-367-6372) (USA)  
1-800-387-0100 (Canada)

You can find further information in the Mercedes-Benz Roadside Assistance Program brochure (USA) or the "Roadside Assistance" section in the Service and Warranty booklet (Canada). You will find both in the vehicle document wallet.

### Change of address or change of ownership

In the event of a change of address, please send us the "Notification of address change" in the Service and Guarantee booklet or simply call the Mercedes-Benz Customer Assistance Center (USA) on the hotline number 1-800-FOR-MERCEdes (1-800-367-6372) or Customer Service (Canada) on 1-800-387-0100. We

can then reach you in a timely fashion, if necessary.

If you sell your Mercedes, please leave all literature in the vehicle so that it is available to the next owner. If you have purchased a used vehicle, please send us the "Notice of Purchase of Used Car" in the Service and Guarantee booklet or simply call the Mercedes-Benz Customer Assistance Center (USA) at the hotline number 1-800-FOR-MERCEdes (1-800-367-6372) or Customer Service (Canada) at 1-800-387-0100.

### Possible danger due to substances hazardous to health

In compliance with Proposition 65 ("Prop65"), the following detachable label has been added to each vehicle sold in California:



## WARNING



Operating, servicing and maintaining a passenger vehicle, pickup truck, van or off-road motor vehicle can expose you to chemicals including engine exhaust, carbon monoxide, phthalates, and lead, which are known to the State of California to cause cancer and birth defects or other reproductive harm. To minimize exposure, avoid breathing exhaust, do not idle the engine except as necessary, service your vehicle in a well-ventilated area and wear gloves or wash your hands frequently when servicing your vehicle. For more information go to [www.P65Warnings.ca.gov/passenger-vehicle](http://www.P65Warnings.ca.gov/passenger-vehicle)

A 000 817 82 02

### Operating safety



**WARNING** Risk of accident due to malfunctions or system failures

If you do not have the prescribed service/maintenance work or any required repairs carried out, this could result in malfunctions or system failures.

- ▶ Always have the prescribed service and maintenance work or any required repairs carried out in a qualified specialist workshop.

**⚠ WARNING** Risk of accident or injury due to incorrect modifications on electronic component parts

Modification of electronic components, their software or wiring could impair their function and/or the function of other networked component parts or safety-relevant systems.

This can endanger the operating safety of the vehicle.

- ▶ Never tamper with the wiring and electronic component parts or their software.
- ▶ You should have all work on electrical and electronic components carried out at a qualified specialist workshop.

Observe the "On-board electronics" section in "Technical data".

**⚠ WARNING** Risk of fire caused by flammable material on hot exhaust system components

Flammable material such as leaves, grass or twigs may ignite if they come into contact with hot parts of the exhaust system.

- ▶ When driving on an unpaved road or off-road, check the vehicle underside regularly.
- ▶ In particular, remove trapped plant parts or other flammable material.
- ▶ If there is damage, consult a qualified specialist workshop immediately.

**! NOTE** Damage to the vehicle due to driving too fast and due to impacts to the vehicle underbody or suspension components

In the following situations, in particular, there is a risk of damage to the vehicle:

- The vehicle becomes grounded, e.g. on a high curb or an unpaved road
- The vehicle is driven too fast over an obstacle, e.g. a curb, speed bump or pothole
- A heavy object strikes the underbody or suspension components

In situations such as these, damage to the body, underbody, suspension components, wheels or tires may not be visible. Components damaged in this way can unexpectedly fail or, in the case of an accident, may no longer absorb the resulting force as intended.

If the underbody paneling is damaged, flammable materials such as leaves, grass or twigs can collect between the underbody and the

underbody paneling. These materials may ignite if they come into contact with hot parts of the exhaust system.

- ▶ Have the vehicle checked and repaired immediately at a qualified specialist workshop.

or

- ▶ If driving safety is impaired while continuing your journey, pull over and stop the vehicle immediately, while paying attention to road and traffic conditions, and contact a qualified specialist workshop.

### Plug-in hybrid

Hybrid vehicles have a combustion engine and at least one electric motor. The energy supply for operating the vehicle electrically is provided by the vehicle's high-voltage electrical system.

**⚠ DANGER** Risk of death and fire due to modified and/or damaged components of the high-voltage on-board electrical system

The vehicle's high-voltage on-board electrical system is under high voltage. If you modify component parts in the vehicle's high-voltage on-board electrical system or touch damaged component parts, you may be electrocuted. In addition, modified and/or damaged components may cause a fire.

In the event of an accident or impact to the underbody, components of the high-voltage electrical system may be damaged although the damage is not visible.

- ▶ Never make any modifications to the high-voltage on-board electrical system.
- ▶ Do not switch on or use the vehicle if its high-voltage on-board electrical system components have been modified or damaged.

- ▶ Never touch damaged components of the high-voltage on-board electrical system.
- ▶ After an accident, do not touch any components of the high-voltage on-board electrical system.
- ▶ After an accident, have the vehicle transported away.
- ▶ Have the components of the high-voltage on-board electrical system checked at a qualified specialist workshop and replaced if necessary.

The components of the vehicle's high-voltage on-board electrical system are marked with yellow warning stickers. The cables of the vehicle's high-voltage on-board electrical system are orange in color.

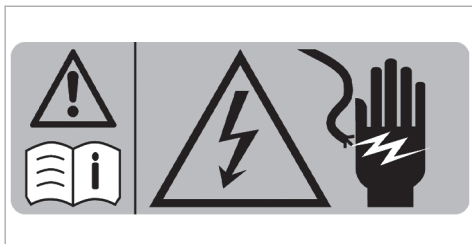

#### Example

High-voltage components that can become very hot are marked with an additional warning sticker:

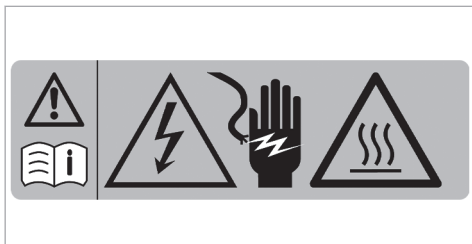

Vehicles with hybrid systems generate significantly less noise when stationary and when being driven compared with vehicles that have combustion engines.

When you are driving in electric mode, the vehicle may not be heard by other road users due to the significantly reduced noise generated when driving and when stationary.

It is for this reason that the vehicle is equipped with a sound generator, which serves as an acoustic vehicle alerting system (AVAS). This safety system is prescribed by law.

The external noise produced by the sound generator (AVAS) can be heard in the passenger compartment at low speeds and does not represent a malfunction.

#### Vehicles with a 48 V on-board electrical system

**⚠ DANGER** Risk of fatal injury by touching damaged high-voltage components

Vehicles with a 48 V on-board electrical system contain individual high-voltage components. These high-voltage components are under high voltage.

If you modify component parts of these high-voltage components or touch damaged component parts, you may be electrocuted.

High voltage components may be damaged in an accident, although the damage may not be visible.

- ▶ Never perform modifications to component parts of high-voltage components.
- ▶ Never touch damaged component parts of high-voltage components.
- ▶ Never touch component parts of high-voltage components after an accident.

Vehicles with a 48 V on-board electrical system contain high-voltage components. These components are marked with a high-voltage label:

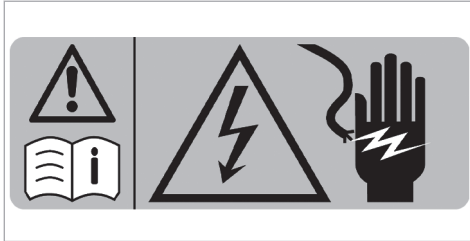

#### Example

All work on high-voltage components must be carried out at a qualified specialist workshop.

### Fitting the license plate to the front license plate holder

**!** **NOTE** Malfunctions and system failures due to incorrect mounting of the license plate on the front license plate holder

If the license plate is incorrectly mounted on the front license plate holder, sensors, cam-

eras or driving and safety systems may malfunction or fail.

Observe the following points when mounting the license plate on the front license plate holder:

- ▶ Mount the license plate directly on the license plate holder without advertising media or other holders.
- ▶ Mount the license plate so that it does not protrude above or to the side of the license plate adapter.

### National information for components relevant to radio regulation

#### Information on crossing national borders

You must observe the radio regulations for the country in which you are currently operating your vehicle.

#### Wireless vehicle components



USA: "Radio based devices of this vehicle comply with Part 15 of the FCC Rules. Operation is subject to the following two conditions: 1) These devices may not cause harmful interference, and 2) These devices must accept any interference received, including interference that may cause undesired operation. Changes or modifications not expressly approved by the party responsible for compliance could void the user's authority to operate the equipment."

Canada: "This vehicle contains licence-exempt transmitter(s)/receiver(s) that comply with Innovation, Science and Economic Development Canada's licence-exempt RSS(s). Operation is subject to the following two conditions: (1) These devices may not cause interference. (2) These devices must accept any interference, including interference that may cause undesired operation of the devices." "Les émetteurs/récepteurs dans cette véhicule sont conforme aux CNR d'Innovation, Sciences et Développement économique Canada applicables aux appareils radio exempts de licence. L'exploitation est autorisée aux deux conditions suivantes : 1) Ces appareils ne doivent pas produire de brouillage; 2) Ces appareils doivent

accepter tout brouillage radioélectrique subi, même si le brouillage est susceptible d'en compromettre le fonctionnement."

### Diagnostics connection

The diagnostics connection is a technical interface in the vehicle. It is used, for example, during repair and maintenance work or for reading out vehicle data in a specialist workshop. Diagnostic devices should therefore only be connected in a qualified specialist workshop.

**⚠ WARNING** Risk of accident due to connecting devices to the diagnostics connection

If you connect devices to the diagnostics connection of the vehicle, the function of vehicle systems and operating safety may be impaired.

- ▶ For safety reasons, we recommend that you use and connect only products approved by an authorized Mercedes-Benz Service Center.

**⚠ WARNING** Risk of accident due to objects in the driver's footwell

Objects in the driver's footwell may impede pedal travel or block a depressed pedal.

This jeopardizes the operating and road safety of the vehicle.

- ▶ Stow all objects in the vehicle securely so that they cannot get into the driver's footwell.
- ▶ Always install the floor mats securely and as prescribed in order to ensure that there is always sufficient room for the pedals.
- ▶ Do not use loose floor mats and do not place floor mats on top of one another.

**! NOTE** Battery discharging from using devices connected to the diagnostics connection

Using devices at the diagnostics connection drains the battery.

- ▶ Check the charge level of the battery.

- ▶ If the charge level is low, charge the battery, e.g. by driving a considerable distance.

Please also note the information about the 12 V battery and short-distance trips in the "Driving and Parking" chapter (→ page 171).

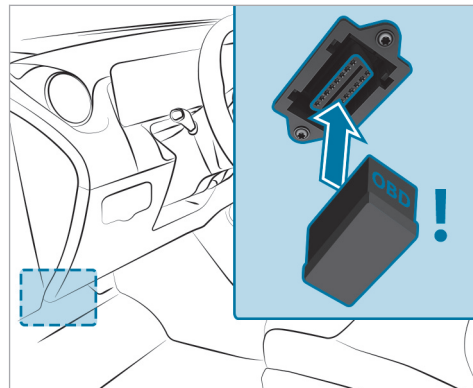



Connecting and using another device with the diagnostics connection can have the following effects:

- Malfunctions in the vehicle system
- Permanent damage to vehicle components

Please refer to the warranty terms and conditions for this matter.

Moreover, connecting equipment to the diagnostics connection can lead to emissions monitoring information being reset, for example. This may lead to the vehicle failing to meet the requirements of the next emissions inspection during the main inspection.

#### Qualified specialist workshop

An authorized Mercedes-Benz Service Center is a qualified specialist workshop. It has the necessary special skills, tools and qualifications to correctly carry out the work required on your vehicle. This particularly applies to safety-relevant work.

For the following, always have your vehicle checked at an authorized Mercedes-Benz Service Center:

- Safety-relevant work
- Service and maintenance work
- Repair work
- Modifications as well as installations and conversions
- Work on electronic components
- **Plug-in hybrid:** work on the hybrid system
- **Vehicles with 48 V on-board electrical system:** work on the high-voltage component of the 48 V on-board electrical system

Mercedes-Benz recommends a Mercedes-Benz Service Center.

#### Correct use of the vehicle

If you remove any warning stickers, you or others could fail to recognize certain dangers. Leave warning stickers in position.

Observe the following information in particular when driving your vehicle:

- the safety notes in this Operator's Manual, vehicle-specific supplements and further supplementary documents
- technical data for the vehicle
- traffic laws and regulations of the country you are currently driving in
- laws pertaining to motor vehicles and safety standards of the country you are currently driving in
- radio regulatory requirements of the country you are currently driving in

#### Notes for persons with electronic medical aids

Mercedes-Benz AG cannot, despite carefully developing vehicle systems, completely rule out the interaction of vehicle systems with electronic medical aids such as cardiac pacemakers.

In addition, there are components installed in the vehicle that, regardless of the operating status of the vehicle, can generate magnetic fields on a par with permanent magnets. These fields can be

found, for example, in the area around the multimedia and sound system or also in the area of the seats, depending on the vehicle equipment.

For this reason, the following can occur in isolated cases, depending on the aids used:

- Medical aids malfunctioning
- Adverse health effects

Observe the notes and warnings of the manufacturer of the medical aids; if in doubt, contact the device manufacturer and/or your doctor. If there is continuing uncertainty concerning the possibility of medical aids malfunctioning, Mercedes-Benz AG recommends using only few electrical vehicle systems and/or maintaining a distance from the components.

### Plug-in hybrid

When charging the high-voltage battery, keep a distance of at least an arm's length between the medical aid and the following components:

- The power supply equipment  
This includes charging stations in the form of a wallbox or a public charging point, for example.

- Vehicle components carrying live voltage  
This includes the charging cable and the charging control box, for example.

Only have repairs and maintenance work in the area of the following components carried out at a qualified specialist workshop:

- Vehicle components carrying live voltage
- Transmission antenna
- Multimedia system and sound system

If you have any queries or suggestions, consult a qualified specialist workshop.

### Problems with your vehicle

If you should experience a problem with your vehicle, particularly one that you believe may affect its safe operation, we urge you to contact an authorized Mercedes-Benz Center immediately to have the problem diagnosed and rectified. If the problem is not resolved to your satisfaction, please discuss the problem again with an authorized Mercedes-Benz Center or, if necessary, contact us at one of the following addresses:

### In the USA:

Mercedes-Benz USA, LLC  
Customer Assistance Center  
One Mercedes-Benz Drive  
Sandy Springs, GA 30328

### In Canada:

Mercedes-Benz Canada, Inc.  
Customer Relations Department  
98 Vanderhoof Avenue  
Toronto, Ontario M4G 4C9

### Reporting safety defects

#### USA only:

The following text is published as required of manufacturers under Title 49, Code of U.S. Federal Regulations, Part 575 pursuant to the "National Traffic and Motor Vehicle Safety Act of 1966".

If you believe that your vehicle has a defect which could cause a crash or could cause injury or death, you should immediately inform the National

Highway Traffic Safety Administration (NHTSA) in addition to notifying Mercedes-Benz USA, LLC.

If NHTSA receives similar complaints, it may open an investigation, and if it finds that a safety defect exists in a group of vehicles, it may order a recall and remedy campaign. However, NHTSA cannot become involved in individual problems between you, your dealer, or Mercedes-Benz USA, LLC.

To contact NHTSA, you may call the Vehicle Safety Hotline toll-free at 1-888-327-4236 (TTY: 1-800-424-9153) ; go to <https://www.safercar.gov>; or write to: Administrator, NHTSA, 400 Seventh Street, SW., Washington, DC 20590, USA.

You can also obtain other information about motor vehicle safety from <https://www.safercar.gov>.

#### Canada only:

The following text is published as required of manufacturers under subsection 18.4 (4) of the Motor Vehicle Safety Regulations.

If you believe that your vehicle has a defect which could cause a crash or could cause injury or death, you should immediately inform Transport

Canada in addition to notifying Mercedes-Benz Canada Inc.

If Transport Canada received similar complaints, it may open an investigation, and if it finds that a safety defect exists in a group of vehicles, it may order a recall and remedy campaign. However, Transport Canada cannot become involved in individual problems between you, your dealer, or Mercedes-Benz Canada Inc.

To contact Transport Canada, you may call the Defect Investigations and Recalls Division toll-free in Canada at 1-800-333-0510 or 819-994-3328 in the Gatineau-Ottawa area or internationally; may also go to the following websites for more information:

- English: <https://www.tc.gc.ca/recalls>
- French: <https://www.tc.gc.ca/rappels>

### Limited Warranty

**!** **NOTE** Damage to the vehicle arising from violation of these operating instructions.

Damage to the vehicle can arise from violation of these operating instructions.

This damage is not covered either by the Mercedes-Benz implied warranty or by the New- or Used-Vehicle Warranty.

▶ Follow the instructions in these operating instructions on proper operation of your vehicle as well as on possible vehicle damage.

### QR code for rescue card

QR codes are attached in the fuel filler flap and on the opposite side on the B-pillar. In the event of an accident, rescue services can use the QR code to quickly find the appropriate rescue card for your vehicle. The current rescue card contains the most important information about your vehicle (e.g. the routing of the electric lines) in compact form.

Further information can be obtained at <https://www.mercedes-benz.de/qr-code>

## Data storage

### Data processing in the vehicle

#### Electronic control units

There are electronic control units installed in your vehicle. Control units process data that they e.g. receive from vehicle sensors, generate themselves or exchange among themselves. Some control units are required for the safe operation of your vehicle. For example, some assist you when you are driving, such as driver assistance systems, while others enable convenience or infotainment functions.

The following provides you with general information regarding data processing in the vehicle. Additional information on what specific data is collected, stored and transmitted to third parties for what purpose in your vehicle can be found in the notes on the functional features in question in the respective operating instructions. These are also available online and, depending on the equipment, digitally in the vehicle.

#### Personal data

Each vehicle is marked with a unique vehicle identification number. Depending on the country, this vehicle identification number can be used by, for example, government authorities to determine the identity of the owner. There are other possibilities for using data collected from the vehicle to identify the owner or driver, such as the license plate number.

The data generated or processed by control units may therefore be personal or, in certain circumstances, become personal. Depending on which vehicle data are available, it may be possible to make inferences about, for example, your driving behavior, your location, your route or your use patterns.

#### Legal requirements for the disclosure of data

If legal regulations exist, manufacturers are generally obligated to release data stored by the manufacturer to the necessary extent in individual cases at the request of state authorities. This may be the case during the investigation of a criminal offense, for example.

Within the framework of applicable law, state authorities are also authorized to take data readouts from vehicles themselves in specific cases. In the event of an accident, for example, information readouts can be taken from the air bag control unit to help to establish what happened.

#### Operating data in the vehicle

Control units process data to operate the vehicle.

This includes the following data, for example:

- Vehicle status information such as speed, longitudinal acceleration, lateral acceleration, number of wheel revolutions or the fastened seat belts indicator
- Ambient conditions, such as temperature, rain sensor or distance sensor

As a rule, this data is volatile, is not stored beyond the operating time and is processed only in the vehicle itself. Control units (e.g. the vehicle key) often contain data memories. These are used to temporarily or permanently document information about the vehicle's operating state, component stress, maintenance requirements or technical events and malfunctions.

Depending on the technical equipment, the following data will be stored:

- Operating status of system components (e.g. fill levels, tire pressure, battery status)
- Malfunctions or faults in important system components (e.g. lights, brakes)
- System reactions in special driving situations (e.g. air bag deployment, the intervention of stability control systems)
- Information on events leading to vehicle damage

In special cases, it may be necessary to store data that would otherwise only be volatile. This may be the case if the vehicle has detected a malfunction, for example.

If you use services such as repair services or maintenance work, stored operational data readouts can be taken and used together with the vehicle identification number, where necessary. Readouts can be taken by service network employees such as workshops and manufacturers, or third parties, such as breakdown services. The same is true in the case of warranty claims and quality assurance measures.

The readout will usually be taken via the diagnostics connection in the vehicle, which is required by law. The operating data readout taken documents technical conditions of the vehicle or individual components and helps to diagnose malfunctions, meet warranty obligations and improve quality. This data, particularly information on component stress, technical events, operating errors and other malfunctions, will be transmitted to the manufacturer for this purpose together with the vehicle identification number if necessary. In addition, the manufacturer is subject to product liability. For this reason, the manufacturer also uses operational data from the vehicle for e.g. recalls. This data can also be used to check customer claims for warranty and guarantee.

Fault memories in the vehicle can be reset by a service outlet or at your request as part of repair or maintenance work.

#### **Comfort and infotainment functions**

You can save comfort settings and individualization in the vehicle and change or reset them at any time.

Depending on the vehicle equipment, this includes the following settings, for example:

- Seat positions and steering wheel positions
- Suspension tuning and climate control settings
- Custom settings (e.g. interior lighting)

You can incorporate data into the vehicle's infotainment functions yourself as part of the selected equipment.

Depending on the vehicle equipment, this includes the following data, for example:

- Multimedia data (e.g. music, films or photos for playback in an integrated multimedia system)
- Address book data for use in conjunction with an integrated hands-free system or an integrated navigation system
- Navigation destinations that have been entered
- Data about the use of internet services

This data for comfort and infotainment functions can be saved locally in the vehicle or stored on a

device that you have connected to the vehicle (e.g. smartphone, USB flash drive or MP3 player). If you have entered data yourself, you can delete it at any time.

The transfer of this data out of the vehicle will take place exclusively at your request. This applies in particular when you are using online services according to the settings you have selected.

#### **Smartphone integration (e.g. Android Auto or Apple CarPlay®)**

If your vehicle is equipped appropriately, you can connect your smartphone or another mobile device to the vehicle. You will then be able to control them using the controls integrated in the vehicle. The smartphone's picture and sound can be output via the multimedia system. Specific items of information will also be transferred to your smartphone. Depending on the type of integration, this may include position data, day/night mode and other general vehicle statuses. Please refer to the vehicle Operator's Manual / infotainment system operating instructions for further information.

This integration allows the use of selected smartphone apps (e.g. navigation apps, music player apps). There will be no further interaction between your smartphone and the vehicle; in particular, vehicle data will not be directly accessible. The type of additional data processing is determined by the provider of the app being used. Whether you can configure settings for it and, if so, which ones, depend on the app and your smartphone's operating system.

#### **Online services**

##### **Wireless network connection**

If your vehicle has a wireless network connection, it enables data to be exchanged between your vehicle and additional systems. The wireless network connection is made possible by the vehicle's own transmitter and receiver or by a mobile end device that you have brought into the vehicle, for example, a smartphone. Online functions can be used via the wireless network connection. This includes online services and applications/apps provided to you by the manufacturer or by other providers.

##### **Manufacturer's services**

Regarding the manufacturer's online services, the individual functions are described by the manufacturer in a suitable place, for example, in the Operator's Manual or on the manufacturer's website, where the relevant data protection information is also given. Personal data may be used for the provision of online services. Data is exchanged via a secure connection, such as the manufacturer's designated IT systems. Any personal data which is collected, processed and used, other than for the provision of services, is done so exclusively on the basis of legal permission. This is the case, for example, for a legally prescribed emergency call system, a contractual agreement or when consent has been given.

You can have services and functions, some of which are subject to a fee, activated or deactivated. This excludes legally prescribed functions and services, such as an emergency call system.

##### **Third-party services**

If you use online services from other providers (third parties), these services are the responsibility of the provider in question and subject to that provider's data protection conditions and terms of

use. As a general rule, the manufacturer has no influence on the content exchanged.

For this reason, when services are provided by third parties, please ask the service provider in question for information about the type, extent and purpose of the collection and use of personal data.

### Data protection rights

Depending on your country or the equipment and range of functions of your vehicle as well as the services you use and the services on offer, you are entitled to different data protection rights. Further information on data protection and your data protection rights can either be found on the manufacturer's website or you will receive this information as part of the various services and service offers. There you will also find the contact information for the manufacturer and its data protection officers.

At a workshop, for example, with the support of a specialist and possibly for a fee, you can have data read out which is stored only locally in the vehicle.

### MBUX multimedia system/Mercedes me connect

If the vehicle is equipped with the MBUX multimedia system or Mercedes me connect, additional data about the vehicle's operation, the use of the vehicle in certain situations, and the location of the vehicle may be compiled by the MBUX multimedia system or Mercedes me connect.

For additional information, please refer to the "MBUX multimedia system" section and/or the Mercedes me connect Terms and Conditions.

### Event data recorder

USA only:

This vehicle is equipped with an event data recorder (EDR). The main purpose of an EDR is to record, in certain crash or near crash-like situations, such as an air bag deployment or hitting a road obstacle, data that will assist in understanding how a vehicle's systems performed. The EDR is designed to record data related to vehicle dynamics and safety systems for a short period of time, typically 30 seconds or less.

The EDR in this vehicle is designed to record such data as:

- How various systems in your vehicle were operating;
- Whether or not the driver and passenger safety belts were buckled/fastened;
- How far (if at all) the driver was depressing the accelerator and/or brake pedal; and,
- How fast the vehicle was traveling.

These data can help provide a better understanding of the circumstances in which crashes and injuries occur. NOTE: EDR data are recorded by your vehicle only if a non-trivial crash situation occurs; no data are recorded by the EDR under normal driving conditions and no personal data (e.g., name, gender, age, and crash location) are recorded. However, other parties, such as law enforcement could combine the EDR data with the type of personally identifying data routinely acquired during a crash investigation.

To read data recorded by an EDR, special equipment is required, and access to the vehicle or the EDR is needed. In addition to the vehicle manufacturer, other parties, such as law enforcement,

that have the special equipment, can read the information if they have access to the vehicle or the EDR.

EDR data may be used in civil and criminal matters as a tool in accident reconstruction, accident claims, and vehicle safety. Since the Crash Data Retrieval CDR tool that is used to extract data from the EDR is commercially available, Mercedes-Benz USA, LLC („MBUSA“) expressly disclaims any and all liability arising from the extraction of this information by unauthorized Mercedes-Benz personnel.

MBUSA will not share EDR data with others without the consent of the vehicle owners or, if the vehicle is leased, without the consent of the lessee. Exceptions to this representation include responses to subpoenas by law enforcement; by federal, state or local government; in connection with or arising out of litigation involving MBUSA or its subsidiaries and affiliates; or, as required by law.

Warning: The EDR is a component of the Restraint System Module. Tampering with, altering, modifying or removing the EDR component may result in

a malfunction of the Restraint System Module and other systems.

State laws or regulations regarding EDRs that conflict with federal regulation are pre-empted. This means that in the event of such conflict, the federal regulation governs. As of Dec 2016, 17 states have enacted laws relating to EDRs.

### Copyright

#### Free and open source software

Information on licenses for free and open-source software used in your vehicle can be found on the data carrier in your vehicle document wallet and with updates on the following website:

<https://www.mercedes-benz.com/opensource>

#### Registered trademarks

- Bluetooth® is a registered trademark of Bluetooth SIG, Inc.
- DTS™ is a registered trademark of DTS, Inc.
- Dolby® and MLP™ are registered trademarks of DOLBY Laboratories.



- ESP® and PRE-SAFE® are registered trademarks of Mercedes-Benz Group AG.
- HomeLink® is a registered trademark of Genex Corporation.
- iPod® and iTunes® are registered trademarks of Apple Inc.
- Burmester® is a registered trademark of Burmester Audiosysteme GmbH.
- Microsoft® and Windows Media® are registered trademarks of Microsoft Corporation.
- SiriusXM® is a registered trademark of Sirius XM Radio Inc.
- HD Radio™ is a registered trademark of iBiquity Digital Corporation.
- Gracenote® is a registered trademark of Gracenote, Inc.
- ZAGAT Survey® and related brands are registered trademarks of Zagat Survey, LLC.



## Brief overview of the most important points

### Basic information

Make sure that the following prerequisites in particular have been met so that the components of the restraint system are able to provide the intended level of protection:

- Sit correctly (→ page 40).
- Fasten the seat belt correctly (→ page 41).
  - Function of the seat belt warning lamp  (→ page 43).
  - Function of the rear seat belt status display (→ page 43).
- The restraint system warning lamp  has gone out after the self-test (→ page 42).
- The PASSENGER AIR BAG indicator lamps display the correct status for the front passenger air bag (→ page 44).

### Helping you to understand clearly

The "Occupant safety" chapter includes information on equipment, functions and behaviors that contribute directly to the safety of vehicle occupants.

The information is structured as follows:

- **Brief overview of the most important points:** this chapter provides an overview of the relationship between the restraint system and the correct behavior of all vehicle occupants.
- **Specific information:** in further sections of the "Occupant safety" chapter, you can find specific information on the equipment and functions of the restraint system.
- **Index:** you can also find certain topics in this Operator's Manual using the index.

The "Occupant safety" chapter does not provide information on topics including the following:

- Children in the vehicle (→ page 56)
- Driving and driving safety systems (→ page 221)
- Stowage areas (→ page 113)

### Defining generic terms clearly

The following generic terms are used in this Operator's Manual:

- **Occupant safety:** comprises the components and system functions that help to minimize, as

much as possible, the stresses and consequences for vehicle occupants caused by an accident.

- **Restraint system:** comprises those components that, along with the vehicle structure, help prevent vehicle occupants from potentially coming into contact with parts of the vehicle interior. The seat belts and air bags, for example, are components of the restraint system.
- **Child restraint system:** you can find all information on this topic in the chapter "Children in the vehicle" (→ page 56).

### Be diligent

For the components of the restraint system to provide the intended level of protection, it is essential for your posture to be correct and for the seat belt to be fastened correctly.

Bear in mind that negligence when adopting your sitting position and fastening your seat belt may have serious consequences. Be diligent and make sure that all vehicle occupants are sitting correctly and have fastened their seat belts properly before starting every journey.

### Information on the correct seat position

The seat position must be correct in order for the components of the restraint system to provide the intended level of protection.

The seat position influences both the protection provided by the seat belt and the additional protection provided by the air bag.

The correct seat position with an almost upright posture and a correctly fastened seat belt also reduce the risk posed by the air bag when it is deployed.

When choosing the seat, take note of the available space. When you are sitting with the right posture in a nearly upright position, your head should not touch the roof.

**▲ WARNING** Risk of injury or death due to an incorrect seat position

If you deviate from the correct seat position, the air bag cannot provide its intended protective function.

Each vehicle occupant must make sure of the following.

- ▶ Put the seat in the correct position.
- ▶ Fasten seat belts correctly. Pregnant women must take particular care to ensure that the lap belt never lies across the abdomen.
- ▶ Observe the following information.

In order for the restraint system to provide the intended level of protection, observe the following information:

- Before starting your journey, adjust your seat correctly (→ page 98).  
When doing so, make sure you are able to fasten your seat belt correctly. The shoulder belt strap must be routed forward from the seat belt outlet over the center of your shoulder.
- Keep your distance from the air bags, especially the front air bags. Set the driver's seat and front passenger seat as far back as possible while making sure the seat belt is fastened correctly.
- If persons are sitting on the rear seats, vehicle occupants should maintain a sufficient dis-

tance to the parts of the vehicle interior in front of them.

- Make sure there are no people, animals or objects between the vehicle occupants and an air bag.
- If you are the driver, observe the following information on the correct position of the driver's seat (→ page 98).  
Hold the steering wheel only by the steering wheel rim. This allows the driver's air bag to fully deploy.
- Assume a nearly upright position, with your buttocks as far back as possible in the gap between the seat cushion and seat backrest.  
This ensures that your back lies as flat and firmly as possible against the seat backrest.
- While driving, do not lean forward and do not lean against the door or side window. You may otherwise be in the deployment area of the air bags.
- Sit with your feet resting on the floor, if possible. Your thighs are slightly supported by the seat cushion

Do not put your feet up on the cockpit, for example. Your feet may otherwise be in the deployment area of the air bag.

- Fasten the seat belt correctly.

### Notes on wearing the seat belt correctly

Always fasten your seat belt correctly before starting a journey. A seat belt can provide the best level of protection only if it is worn correctly.

#### **⚠ WARNING** Risk of injury or death due to incorrectly fastened seat belt

If the seat belt is not worn correctly, it cannot perform its intended protective function.

In addition, an incorrectly fastened seat belt can also cause injuries, for example, in the event of an accident or when braking or changing direction suddenly.

- ▶ Always ensure that all vehicle occupants have their seat belts fastened correctly and are sitting properly.

#### **⚠ WARNING** Risk of injury or death when additional restraint systems are not used for persons with a smaller stature

Persons under 5 ft (1.50 m) tall cannot wear the seat belt correctly without a suitable additional restraint system.

- ▶ Always secure persons under 5 ft (1.50 m) tall in a suitable restraint system.

Each vehicle occupant must observe the following notes in particular:

- The seat belt must not be twisted:
- The shoulder belt strap must be routed forward from the seat belt outlet over the center of your shoulder.
- The shoulder belt strap should neither touch your neck nor be routed under your arm or behind your back.
- The lap belt must be routed as low down across the hips as possible.

In addition, push the lap belt down as far as possible across your hips and pull tight with

the shoulder belt strap. Never route the lap belt across your abdomen.

Pregnant women must also take particular care with this.

- The shoulder belt strap and lap belt must fit snugly against the body after being tightened.
- Avoid wearing bulky clothing, e.g. a winter coat.
- Never route the seat belt across sharp, pointed, abrasive or fragile objects.
- Only one person should use each seat belt at any one time.
- Never secure objects with a seat belt if the seat belt is also being used by one of the vehicle's occupants.

Also ensure that no objects, e.g. a cushion, are ever placed between a person and the seat.

### Fastening and adjusting seat belts

If the seat belt is pulled quickly or sharply, the seat belt retractor locks. The seat belt strap cannot be pulled out any further.

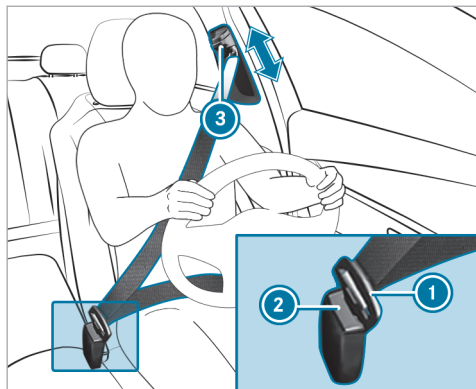

- ▶ Always engage seat belt tongue ① of the seat belt into seat belt buckle ② of the corresponding seat.
- ▶ **To adjust the seat belt height:** press button ③ on the seat belt outlet and slide the seat belt outlet to the desired position.
- ▶ **To engage the seat belt outlet:** release button ③ and ensure that the seat belt outlet engages.

**!** **NOTE** Deployment of components of the restraint system when the front passenger seat is unoccupied and a seat belt is buckled

When the front passenger seat is unoccupied and the seat belt tongue of the seat belt is engaged in the seat belt buckle, components of the restraint system may deploy unnecessarily on the front passenger side, e.g. the Emergency Tensioning Device.



▶ Only buckle the seat belts as intended.

**i** Observe the information on child seat safety feature of the seat belt (→ page 64).

### Function of the restraint system warning lamp

When the vehicle is switched on, a self-test is performed, during which the restraint system warning lamp  lights up. It goes out no later than a few seconds after the vehicle is started. The components of the restraint system are then functional.

A malfunction has occurred in the restraint system if:

- the restraint system warning lamp  does not light up or lights up continuously when the vehicle is switched on.
- the restraint system warning lamp  lights up continuously or repeatedly during a journey.

If components of the restraint system have been deployed, the restraint system warning lamp  will light up continuously.

**!** **WARNING** Risk of injury due to malfunctions in the restraint system

Components in the restraint system may be activated unintentionally or not deploy as planned in an accident.

▶ Have the restraint system checked and repaired immediately at a qualified specialist workshop.

**Plug-in hybrid:** if the restraint system is malfunctioning, the automatic high-voltage emergency shutoff may not function.

**⚠ DANGER** Risk of fatal injuries due to malfunctions of the automatic high-voltage emergency shutoff

In the event of an accident, the high-voltage on-board electrical system may not be deactivated as intended.

You may be electrocuted if you touch the damaged component parts of the high-voltage on-board electrical system.

- ▶ Have the automatic high-voltage emergency shutoff checked and repaired immediately at a qualified specialist workshop.
- ▶ After an accident, switch off the vehicle immediately.

Mercedes-Benz recommends that you have the vehicle towed to a qualified specialist workshop.

### Function of the seat belt warning lamp

The  seat belt warning lamp in the driver's display is a reminder that all vehicle occupants must wear their seat belts correctly.

The  seat belt warning lamp lights up for six seconds every time the vehicle is started.

In addition, a warning tone may sound.

When the driver's and front passengers doors are closed and the driver and front passenger have fastened their seat belts, the seat belt warning goes out.

In the following cases, the seat belt warning lights up during a journey if:

- The driver or front passenger is not wearing a seat belt and the following criteria apply:
  - The vehicle travels faster than 5 mph (9 km/h) for more than 20 seconds.
  - The vehicle travels faster than 15 mph (25 km/h) once.
- The driver or front passenger unfastens their seat belt while the vehicle is in motion.

### Function of the rear seat belt status display

The rear seat belt status display in the driver's display is a reminder that all vehicle occupants must wear their seat belts correctly.

In addition, a warning tone may sound.

If a person unfastens a seat belt in the rear passenger compartment while the vehicle is in motion, the rear seat belt status display appears again.

### Display in the driver's display

Every time the vehicle is switched on, the rear seat belt status display informs you for a certain amount of time which rear seat belt is not fastened.

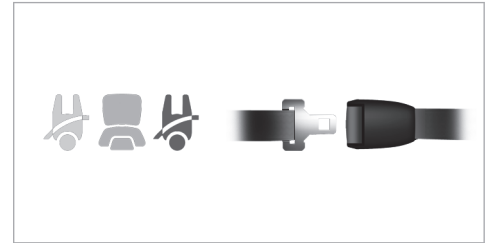

You can determine the status of the rear seat belt by the color of the seat symbol in the driver's display as follows:

- Gray: the rear seat belt is not fastened.
- Green: the seat belt tongue of a rear seat belt is engaged in the seat belt buckle of the displayed seat.
- Red: the person in the rear seat has unfastened their seatbelt.

#### Function of the PASSENGER AIR BAG indicator lamps (front passenger air bag)



The PASSENGER AIR BAG indicator lamps display the status of the front passenger air bag.

If the front passenger seat is occupied or a child restraint system is installed on the front passenger seat, you must make sure, both before and during a journey, that the status of the front

passenger air bag is correct for the current situation.

**⚠ WARNING** Risk of potentially fatal injuries due to objects trapped under the front passenger seat

Objects trapped under the front passenger seat may interfere with the function of the automatic front passenger air bag shutoff or damage the system.

- ▶ Do not stow any objects under the front passenger seat.
- ▶ When the front passenger seat is occupied, ensure that no objects have become trapped beneath the front passenger seat.

**Self-test:** when the vehicle is switched on, both the PASSENGER AIR BAG ON and OFF indicator lamps light up simultaneously for several seconds.

After the self-test, you can determine the status of the front passenger air bag as follows:

- **Front passenger air bag disabled:** PASSENGER AIR BAG OFF lights up continuously.

The front passenger air bag will not be deployed in the event of an accident. If PASSENGER AIR BAG OFF is lit, no one may use the front passenger seat.

If a rearward-facing child restraint system is installed on the front passenger seat, PASSENGER AIR BAG OFF must be lit continuously.

- **Front passenger air bag enabled:** PASSENGER AIR BAG ON lights up for up to 60 seconds or both the PASSENGER AIR BAG ON and OFF indicator lamps do not light up.

The front passenger air bag may be deployed during an accident. If the front passenger air bag has this status, no rearward-facing child restraint system may be installed on the front passenger seat.

- **i** If you are driving with a child in the vehicle, observe the information in the chapter "Children in the vehicle" (→ page 56)

**⚠ WARNING** Risk of injury or death due to a disabled front passenger airbag

The front passenger airbag is disabled when the PASSENGER AIR BAG OFF indicator lamp is lit.

A person in the front passenger seat could then, for example, come into contact with the vehicle interior, especially if the person is sitting too close to the cockpit.

If the front passenger seat is occupied, always ensure that:

- The classification of the person in the front passenger seat is correct and the front passenger airbag is enabled or disabled in accordance with the person in the front passenger seat.
- The front passenger seat has been moved as far back as possible.
- The person is seated correctly.

▶ Both before and during the journey, ensure that the status of the front passenger airbag is correct.

**Malfunction of the automatic front passenger air bag shutoff**

The PASSENGER AIR BAG OFF indicator lamp and the restraint system indicator lamp  light up simultaneously.

In this case, no one may use the front passenger seat and no child restraint system may be installed on the front passenger seat.

Have the automatic front passenger air bag shutoff checked and repaired immediately at a qualified specialist workshop.

Be sure to also observe the following further related subjects:

- Child restraint system on the front passenger seat (→ page 60)

**Disabling or enabling the front passenger air bag**

The automatic front passenger air bag shutoff can activate or deactivate the front passenger air bag and front passenger knee bag according to the situation.

This happens automatically as a result of the classification of the person or child restraint system on the front passenger seat.

You cannot manually disable or enable the front passenger air bag.

Also observe the following information:

- The status of the front passenger air bag: see "Function of the PASSENGER AIR BAG indicator lamps" (→ page 44)
- Notes on using the front passenger seat: see "Information on automatic front passenger air bag shutoff" (→ page 46)
- If you are driving with a child in the vehicle, observe the chapter "Children in the vehicle" (→ page 56)

### Information on the child restraint system

When installing a child restraint system, observe the notes in "Children in the vehicle" (→ page 56).

### **Notes on the child restraint system on the front passenger seat**

**▲ WARNING** Risk of injury or fatal injuries if the front passenger air bag is enabled

If the front passenger air bag is enabled, a child on the front passenger seat may be struck by the front passenger air bag in the event of an accident.

▶ NEVER use a rearward-facing child restraint system on a seat with an ENABLED FRONT AIR BAG. This can result in the DEATH of or SERIOUS INJURY to the CHILD.

Also pay particular attention to the notes on rearward-facing or forward-facing child restraint systems on the front passenger seat (→ page 60).

### **Information on the automatic functions of the restraint system**

#### Function of the automatic front passenger air bag shutoff

A person on the front passenger seat must observe the following information:

- Sit correctly (→ page 40).
- Fasten the seat belt correctly (→ page 41).

The automatic front passenger air bag shutoff can activate or deactivate the front passenger air bag and front passenger knee bag according to the situation.

Make sure you observe the following information:

- Status of the front passenger air bag: see "Function of the PASSENGER AIR BAG indicator lamps" (→ page 44).
- When installing a child restraint system on the front passenger seat, observe the vehicle-specific information (→ page 60).



Status of the front passenger air bag in relation to the stature of the person:

- **Front passenger air bag disabled:** PASSENGER AIR BAG OFF lights up continuously.

The front passenger air bag will not be deployed in the event of an accident. If PASSENGER AIR BAG OFF is lit, no one may use the front passenger seat.

- **Front passenger air bag enabled:** PASSENGER AIR BAG ON lights up for up to 60 seconds or until both the PASSENGER AIR BAG ON and OFF indicator lamps go out.

The front passenger air bag may be deployed during an accident. Observe the following information on the correct seat position (→ page 40).

**Vehicles with rear seats:** a person of smaller stature should use a rear seat.

### System limits

The front passenger air bag may otherwise be disabled by mistake, for example, in the following situation:

- The front passenger transfers their weight by supporting themselves on a vehicle armrest.
- The front passenger sits in such a way that their weight is raised from the seat surface.

**!** **NOTE** Deployment of components of the restraint system when the front passenger seat is unoccupied

In an accident, the components of the restraint system may deploy unnecessarily on the front passenger side if:

- There are heavy objects on the front passenger seat.
- The seat belt tongue is engaged in the seat belt buckle of the front passenger seat and the front passenger seat is unoccupied.

▶ Store objects in a suitable place.

▶ Only one person should use each seat belt at any one time.

Depending on the detected accident situation, the window air bag on the front passenger side may deploy. The air bag is deployed regardless of whether the front passenger seat is occupied.

### Function of PRE-SAFE® (anticipatory occupant protection)

PRE-SAFE® is able to detect certain critical driving situations and implement pre-emptive measures to protect the vehicle occupants.

PRE-SAFE® can implement the following measures independently of each other:

- Tightening the seat belts on the driver's seat and front passenger seat.
- Closing the side windows.
- **Vehicles with sliding sunroof:** closing the sliding sunroof.
- **Vehicles with memory function:** moving the front passenger seat to a more favorable seat position.

- **Vehicles with multicontour seat:** increasing the lateral support by inflating the seat side bolsters of the seat backrest.
- **PRE-SAFE® Sound:** provided that the multimedia system is switched on, generating a brief noise signal to stimulate the innate protective mechanism of a person's hearing.

**!** **NOTE** Damage caused by objects in the footwell or behind the seat

The automatic adjustment of the seat position may result in damage to the seat and/or the object.

- ▶ Stow objects in a suitable place.

### Reversing the PRE-SAFE® system measures

If an accident did not occur, the pre-emptive measures that were taken will be reversed.

You will need to perform certain settings yourself.

- ▶ If the seat belt pre-tensioning is not reduced, move the seat backrest back slightly. The locking mechanism will release.

### Function of PRE-SAFE® PLUS (anticipatory occupant protection plus)

PRE-SAFE® PLUS can detect certain impacts, particularly an imminent rear impact, and take pre-emptive measures to protect the vehicle occupants. These measures cannot necessarily prevent an imminent impact.

PRE-SAFE® PLUS can implement the following measures independently of each other:

- Tightening the seat belts on the driver's seat and front passenger seat.
- Increasing brake pressure when the vehicle is stationary. This brake application is canceled automatically when the vehicle pulls away.

If an accident did not occur, the pre-emptive measures that were taken are reversed.

### **System limits**

The system will not initiate any action in the following situations:

- if the vehicle is backing up  
or

- when the vehicle is towing a trailer and there is a risk of a rear-end collision

The system will not initiate any braking application in the following situations:

- while driving  
or
- when entering or exiting a parking space while using Active Parking Assist

### Function of PRE-SAFE® Impulse Side

If an imminent side impact is detected, PRE-SAFE® Impulse Side can pre-emptively move the front seat vehicle occupant's upper body towards the center of the vehicle. It does this by rapidly inflating an air cushion in the outer seat side bolster of the seat backrest on the side on which the impact is anticipated. This increases the distance between the door and the vehicle occupant.

If PRE-SAFE® Impulse Side has been deployed or is faulty, a display message reading **PRE-SAFE Pulse Side Inoperative See Operator's Manual**(→ page 458) will appear.

### Seat belt adjustment function

**Vehicles with PRE-SAFE®:** after you have fastened the seat belt of the front seat, it may adjust itself against your body by pulling at the shoulder until somewhat tight. Do not hold the seat belt tightly while it is adjusting.

This function is a reminder that all vehicle occupants must wear their seat belts correctly.

You can activate and deactivate the seat belt adjustment function using the multimedia system (→ page 49).

### Activating/deactivating seat belt adjustment via the multimedia system

Multimedia system:

→  » Settings » Vehicle

» Occupant Protection

▶ Activate or deactivate **Belt adjustment**.

### Overview of the automatic measures after an accident

Depending on the type and severity of the accident, and depending on the vehicle's equipment, the following measures can be implemented, foreexample:

- automatic braking (post-collision brake)
- activating the hazard warning lights
- triggering an automatic emergency call (→ page 362)
- Switching off the engine

To start the vehicle again, switch the vehicle off and on once more (→ page 166). Depending on the type and severity of the accident, you may no longer be able to start the vehicle.

- switching off the fuel supply
- **Plug-in hybrid:** switching off the hybrid system and high-voltage on-board electrical system
- unlocking the vehicle doors
- lowering the side windows
- displaying the emergency guide in the central display

- switching on the interior lighting

### Function of the post-collision brake after an accident

Depending on the accident situation, the post-collision brake can minimise the severity of a further collision or even avoid it.

If an accident is detected, the post-collision brake can initiate automatic braking. When the vehicle has come to a standstill, the electric parking brake is automatically applied.

The driver can cancel automatic braking by taking the following actions:

- Braking more strongly than automatic braking
- Fully depressing the accelerator pedal with force

## Purpose and function of the restraint system

### Overview of deployment situations (restraint system)

Make sure that the following prerequisites in particular have been met so that the components of the restraint system are able to provide the intended level of protection:

- Sit correctly (→ page 40).
- Fasten the seat belt correctly (→ page 41).
  - Function of the seat belt warning lamp (→ page 43).
  - Function of the rear seat belt status display (→ page 43).
- The  restraint system warning lamp is not lit up after the self-test (→ page 42).
- The PASSENGER AIR BAG indicator lamps display the correct status of the front passenger air bag (→ page 44).

Depending on the detected deployment situation, the components of the restraint system can be activated or deployed independently of each other:

- Emergency Tensioning Device: frontal impact, rear impact, side impact, rollover
- Driver's air bag, front passenger air bag: frontal impact
- Knee air bag: frontal impact
- Side air bag: side impact
- Window air bag: side impact, rollover, frontal impact
- PRE-SAFE® Impulse Side: side impact

The installation location of an air bag is identified by the AIRBAG symbol (→ page 55).

Observe the information on the function of the restraint system (→ page 50).

### Information on how the restraint system works

How the restraint system functions depends on the severity of the impact detected and the apparent type of accident.

For more information about types of accidents, see "Overview of deployment situations" (→ page 50).

The activation thresholds for the components of the restraint system are determined based on the evaluation of the sensor values measured at various points in the vehicle. This process is pre-emptive in nature. The triggering/deployment of the components of the restraint system must take place in good time at the start of the collision.

Factors that can be seen and measured only after a collision has occurred cannot play a decisive role in air bag deployment. Nor do they provide an indication of air bag deployment.

The vehicle may be deformed significantly without an air bag being deployed. This is the case if only parts which are relatively easily deformed are affected and the rate of vehicle deceleration is not high. Conversely, an air bag may be deployed even though the vehicle suffers only minor deformation. If very rigid vehicle parts such as longitudinal members are hit, this may result in sufficiently high levels of vehicle deceleration.

Depending on the apparent type of accident and the detected deployment situation, Emergency Tensioning Devices and/or air bags can supplement the protection offered by a correctly worn seat belt.

When enabled, an air bag can provide additional protection for the respective vehicle occupant.

Potential protection provided by each air bag:

- Knee air bag: thigh, knee and lower leg
- Driver's air bag, front passenger air bag: head and ribcage
- Window air bag: head
- Side air bag: ribcage, also pelvis for front seat occupants

However, no system available today can completely eliminate injuries and fatalities in every accident situation. In particular, the seat belt and air bag generally do not protect against objects penetrating the vehicle from the outside. It is also not possible to completely rule out the risk of injury caused by the air bag deploying.

Mercedes-Benz recommends that you have the vehicle towed to a qualified specialist workshop

after an accident. Take this into account, particularly if an Emergency Tensioning Device is triggered or an air bag deployed.

If the Emergency Tensioning Devices are triggered or an air bag is deployed, you will hear a bang, and a small amount of powder may also be released:

- The bang will not generally affect your hearing.
- In general, the powder released is not hazardous to health but may cause short-term breathing difficulties to persons suffering from asthma or other pulmonary conditions.

Provided it is safe to do so, leave the vehicle immediately or open the window in order to prevent breathing difficulties.

Air bags and pyrotechnic Emergency Tensioning Devices contain perchlorate material, which may require special handling or environmental protection measures. National guidelines regarding waste disposal must be observed. In California, see the <https://dtsc.ca.gov/>. Using the search function, you will find information on perchlorate, for example.

### Information on the limited protection provided by the restraint system

#### Risk due to the incorrect behavior of vehicle occupants

All vehicle occupants must make sure of the following in particular:

- They observe the information on the correct seat position (→ page 40).
- There are no heavy, sharp-edged or fragile objects in the pockets of their clothing. Store such objects in a suitable place.

#### **⚠ WARNING** Risk of injury or death due to an incorrect seat position

The seat belt does not offer the intended level of protection if you have not moved the seat backrest to an almost vertical position.

In particular, you could slip beneath the seat-belt and become injured.

- ▶ Adjust the seat properly before beginning your journey.
- ▶ Always ensure that the seat backrest is in an almost vertical position and that

the shoulder belt is routed across the center of your shoulder.

### Risk due to objects in the vehicle interior

All vehicle occupants must make sure of the following in particular:

- They observe the information on the correct seat position (→ page 40).
- There are no objects between the seat, door and door pillar (B-pillar).
- There are no hard objects, e.g. coat hangers, hanging on the grab handles or coat hooks.
- There are no heavy, sharp-edged or fragile objects in the pockets of their clothing. Store such objects in a suitable place.

**⚠ WARNING** Risk of injury or death due to blocked seat belt buckle or seat belt anchorage

Objects next to the front seat that block the seat belt buckle or the moving seat belt anchorage on the front seat impair the function of the Emergency Tensioning Devices.

- ▶ Before starting the journey, make sure that there are no objects around the seat belt buckle or between the front seat and door.

**⚠ WARNING** Risk of injury from objects in the deployment area of an airbag

Objects in the deployment area of an airbag can hinder or prevent the correct deployment of the airbag.

The airbag may then deploy in an uncontrolled manner and may even cause additional injuries to the vehicle occupants by deploying. This may be the case in particular if the airbag is integrated into the seat.

- ▶ Always stow and secure objects correctly.
- ▶ Before commencing your journey, make sure that no objects are stowed in the deployment area of an airbag.

The installation location of an air bag is identified by the AIRBAG (→ page 55) symbol.

### Risk due to installing accessories

Do not attach accessories such as mobile navigation devices, mobile phones or cup holders within the deployment area of an air bag, e.g. on the cockpit, on the door, on the side window or on the side trim.

In addition, no connecting cables, tensioning straps or retaining straps may be routed or attached to the vehicle within the deployment area of an air bag. Always comply with the accessory manufacturer's installation instructions and, in particular, the notes on suitable places for installation.

**⚠ WARNING** Risk of injury or death due to unsuitable protective covers

Unsuitable protective covers mean that air bags can no longer protect vehicle occupants as they are designed to do.

- ▶ Use only protective covers approved by Mercedes-Benz for the seat in question.

In addition, the function of the automatic passenger air bag deactivation may be restricted by an unsuitable protective cover. If the front

passenger seat is occupied, ensure that the PASSENGER AIR BAG indicator lamps display the correct status of the front passenger air bag (→ page 44).

#### Risk due to pets in the vehicle interior

**⚠ WARNING** Risk of accident and injury due to animals left unsecured or unattended in the vehicle

If you leave animals in the vehicle unattended or unsecured, they could possibly press buttons or switches.

An animal may:

- Activate vehicle equipment and become trapped, for example
- Switch systems on or off and endanger other road users

Unsecured animals may be thrown around in the vehicle in the event of an accident or sudden steering and braking maneuvers and injure vehicle occupants in the process.

- ▶ Never leave animals in the vehicle unattended.
- ▶ Always correctly secure animals while driving, e.g. using a suitable animal carrier.

#### Risk due to modification, damage or wear to the components of the restraint system

**⚠ WARNING** Risk of injury or death due to modifications to the restraint system

Vehicle occupants may no longer be protected as intended if alterations are made to the restraint system.

- ▶ Never alter the parts of the restraint system.
- ▶ Never tamper with the wiring or any electronic component parts or their software.

If it is necessary to modify the vehicle to accommodate a person with disabilities, contact an authorized Mercedes-Benz Center for details.

USA only: for details, contact our Customer Assistance Center on 1-800-FOR-MERCEdes (1-800-367-6372).

**⚠ WARNING** Risk of injury or death due to damaged or modified seat belts

Seat belts cannot provide protection in the following situations:

- The seat belt is damaged, has been modified, is extremely dirty, bleached or dyed
- The seat belt buckle is damaged or extremely dirty
- Modifications have been made to the Emergency Tensioning Device, seat belt anchorage or seat belt retractor

Seat belts may sustain non-visible damage in an accident, e.g. due to glass splinters.

Modified or damaged seat belts could tear or fail in the event of an accident, for example.

Modified Emergency Tensioning Devices could accidentally trigger or fail to function as intended.

- ▶ Never modify the seat belt system, for example the seat belt, seat belt buckle, Emergency Tensioning Device, seat belt anchorage and seat belt retractor.
- ▶ Make sure that the seat belts are undamaged, not worn and clean.
- ▶ Always have the seat belts checked immediately after an accident at a qualified specialist workshop.

Use only seat belts that have been approved for your vehicle by Mercedes-Benz.

**⚠ WARNING** Risk of injury due to modifications to the cover of an airbag

If you change the cover of an airbag or attach objects, e.g. even stickers, to it, the airbag may no longer function as intended.

- ▶ Never modify the cover of an airbag.
- ▶ Do not attach any objects to the cover.

The installation location of an air bag is identified by the AIRBAG symbol (→ page 55).

**⚠ WARNING** Risk of injury due to malfunctioning sensors in the door

The function of the airbags can be impaired due to modifications or incorrect work performed on the doors or door trim, or if the doors are damaged.

- ▶ Never modify the doors or parts of the doors.
- ▶ Always have work on the doors or door trim carried out at a qualified specialist workshop.

**Risk due to components of the restraint system that have already been deployed**

Mercedes-Benz recommends that you have the vehicle towed to a qualified specialist workshop after an accident.

**⚠ WARNING** Risk of burns from hot air bag components

The air bag parts are hot after an air bag has been deployed.

- ▶ Do not touch the air bag parts.

- ▶ Have a deployed air bag replaced at a qualified specialist workshop as soon as possible.

**⚠ WARNING** Risk of injury due to deployed airbag

A deployed airbag no longer offers any protection.

- ▶ Have the vehicle towed to a qualified specialist workshop in order to have the deployed airbag replaced.

Have deployed air bags replaced immediately.

**⚠ WARNING** Risk of injury or death from deployed pyrotechnic Emergency Tensioning Devices

Pyrotechnic Emergency Tensioning Devices that have been deployed are no longer operational and are unable to perform their intended protective function.

- ▶ Therefore, have deployed pyrotechnic Emergency Tensioning Devices immedi-



ately replaced at a qualified specialist workshop.

## Seat belts

### Releasing seat belts

- ▶ Press the release button in the seat belt buckle and guide the seat belt back with the seat belt tongue.

**!** **NOTE** Damage caused by trapping the seat belt

If an unused seat belt is not fully retracted, it may become trapped in the door or in the seat mechanism.

- ▶ Always ensure that an unused seat belt is fully retracted.

## Airbags

### Overview of air bags

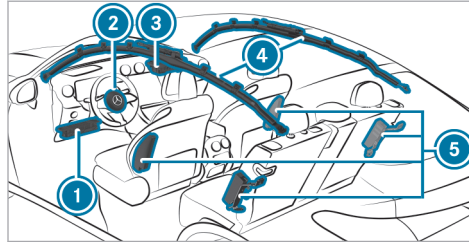

- ① Knee air bag
- ② Driver's air bag
- ③ Front passenger air bag
- ④ Window curtain air bag
- ⑤ Side impact air bag

The installation location of an air bag is identified by the AIRBAG symbol. An additional arrow symbol ▶ indicates the installation location for certain air bags.

Observe the information under "Overview of deployment situations" (→ page 50).

### Brief overview of most important points

#### Safely transporting children in the vehicle

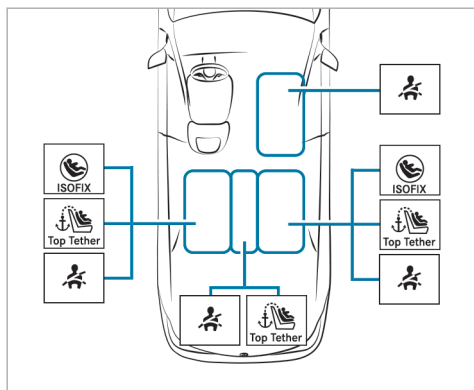

Always observe the following when transporting children:

- Do not leave children unsupervised in the vehicle (→ page 58).

- Secure children up to a height of 5 ft (1.50 m) on the respective seat (see illustration above) properly with a suitable and approved child restraint system, and secure small children in a rearward-facing child restraint system.
- Observe the child restraint system manufacturer's installation instructions.

#### Left/right rear seat (preferred seats)



Preferred securing system:

-  LATCH-type (ISOFIX) securing ring

and

-  Also secure Top Tether if present (→ page 66).

Alternative securing system:

-  Vehicle seat belt (→ page 67)
-  Additionally attach Top Tether if recommended by the manufacturer of the child restraint system (→ page 66).

#### Front passenger seat

Securing system:



-  Vehicle seat belt (→ page 67)

Be sure to observe:

- If the front passenger seat is occupied, ensure that the status of the front passenger air bag is correct for the current situation (→ page 44).

#### Center rear seat

Securing system:

-  Vehicle seat belt (→ page 67)
-  Additionally attach Top Tether if recommended by the manufacturer of the child restraint system (→ page 66).

### Important safety notes

#### Basic information

#### Be diligent

Bear in mind that negligence when securing a child in the child restraint system may have seri-

ous consequences. Always be diligent in securing a child carefully before every journey.

Never allow babies and children to travel sitting on the lap of another vehicle occupant.

To improve protection for children younger than 12 years old or under 5 ft (1.50 m) in height, Mercedes-Benz recommends you observe the following information:

- Always secure the child in a child restraint system suitable for this Mercedes-Benz vehicle.
- The child restraint system must be appropriate to the age, weight and size of the child.
- The vehicle seat must be suitable for the child restraint system to be installed:

Accident statistics show that children secured on the rear seats are generally safer than children secured on the front seats. For this reason, Mercedes-Benz strongly advises that you install a child restraint system on a rear seat.

### The generic term "child restraint system"

The generic term "child restraint system" is used in this Operator's Manual. A child restraint system is, for example:

- a baby car seat
- a rearward-facing child seat
- a forward-facing child seat
- a child booster seat – Mercedes-Benz recommends using a child booster seat **with** a backrest and seat belt guide.

### Observe laws and legal requirements

Always observe the legal requirements when using a child restraint system in the vehicle.

### Securing systems for child restraint systems in the vehicle

Use only the following securing systems for child restraint systems:

- the LATCH-type (ISOFIX) securing rings
- the vehicle's seat belt system
- the Top Tether anchorages

Simply attaching to the LATCH-type (ISOFIX) securing rings on the vehicle can reduce the risk of installing the child restraint system incorrectly.

When securing a child with the integrated seat belt of the ISOFIX/LATCH child restraint system, always comply with the permissible gross weight for the child and child restraint system (→ page 65).

A child booster seat may be necessary to achieve proper seat belt positioning for children over 40 lbs (18 kg) in weight or until they reach a height at which they can wear a three-point seat belt properly without a child booster seat.

Mercedes-Benz recommends a suitable child booster seat with a backrest and seat belt guide.

### Observe standards for child restraint systems

All child restraint systems must meet the following standards:

- U.S. Federal Motor Vehicle Safety Standards 213
- Canadian Motor Vehicle Safety Standards 213

Confirmation that the child restraint system complies with the standards can be found on an

instruction label on the child restraint system. This confirmation can also be found in the installation instructions that are included with the child restraint system.

### Important warning notices

#### Always secure a child restraint system correctly

**⚠ WARNING** Risk of injury or death due to incorrect installation of the child restraint system

The child can then not be protected or restrained as intended.

- ▶ Be sure to comply with the manufacturer's installation instructions for the child restraint system and its correct use.
- ▶ Make sure that the entire base of the child restraint system always rests on the sitting surface of the seat.
- ▶ Never place objects (e.g. cushions) under or behind the child restraint system.

- ▶ Use child restraint systems only with the original cover designed for them.
- ▶ Always replace damaged covers with genuine covers.

- Always observe the vehicle-specific information.
  - Installing the ISOFIX child restraint system on the right and left rear seats (→ page 65).
  - Securing the child restraint system with the seat belt (→ page 67).
- Observe the warning labels in the vehicle interior and on the child restraint system.

**⚠ WARNING** Risk of injury or death due to unsecured child restraint systems in the vehicle

If the child restraint system is incorrectly mounted or unsecured, it may come loose. The child can then not be protected or restrained as intended.

Unused child restraint systems could be flung around and hit vehicle occupants.

- ▶ Always comply with the manufacturer's installation instructions for the child restraint system and its correct use.
- ▶ Always fit child restraint systems correctly, even if they are transported in the vehicle unused.

#### Do not modify the child restraint system

**⚠ WARNING** Risk of injury due to modifications to the child restraint system

The child restraint system can no longer function properly. This poses an increased risk of injury.

- ▶ Never modify a child restraint system.
- ▶ Only affix accessories which have been specially approved for this child restraint system by the child restraint system's manufacturer.

### Use only child restraint systems that are in proper working condition

**⚠ WARNING** Risk of injury or death caused by the use of damaged child restraint systems

Child restraint systems or their retaining systems that have been subjected to stress in an accident may not be able to perform their intended protective function.

It may be the case that the child cannot be properly restrained.

- ▶ Always immediately replace child restraint systems that have been damaged or involved in an accident.
- ▶ Have the securing systems for the child restraint systems checked at a qualified specialist workshop before installing a child restraint system again.

### Avoid direct sunlight

**⚠ WARNING** Risk of burns when the child seat is exposed to direct sunlight

If the child restraint system is exposed to direct sunlight or heat, parts could heat up excessively.

Children could suffer burns from these parts, particularly the metallic parts of the child restraint system.

- ▶ Always make sure that the child restraint system is not exposed to direct sunlight.
- ▶ Cover the child restraint system with a blanket, for example.
- ▶ If the child restraint system has been exposed to direct sunlight, allow it to cool before securing a child into it.
- ▶ Never leave children unattended in the vehicle.

### Observe when stopping or parking

**⚠ WARNING** Risk of fatal injury due to exposure to extreme heat or cold in the vehicle

If persons, particularly children, are subjected to prolonged exposure to intense heat or cold, there is a risk of severe injury or even death.

- ▶ Never leave persons, particularly children, unattended in the vehicle.

**⚠ WARNING** Risk of accident and injury if children are left unattended in the vehicle

If children are left unattended in the vehicle, they could in particular:

- open doors, thereby endangering other persons or road users.
- get out and be struck by oncoming traffic.
- operate vehicle equipment and become trapped, for example.

In addition, the children could also set the vehicle in motion, for example by:

- releasing the parking brake.
- changing gear.
- starting the vehicle.

- ▶ Never leave children unattended in the vehicle.
- ▶ When leaving the vehicle, always take the SmartKey with you and lock the vehicle.
- ▶ Keep the SmartKey out of the reach of children.

### Notes on rearward-facing and forward-facing child restraint systems on the front passenger seat

**⚠ WARNING** Risk of injury or fatal injury when using a rearward-facing child restraint system while the co-driver airbag is enabled

If you secure a child in a rearward-facing child restraint system on the co-driver seat and the

PASSENGER AIR BAG OFF indicator lamp is off, the co-driver airbag can deploy in the event of an accident.

The child could be struck by the airbag.

- ▶ Always ensure that the co-driver airbag is disabled. The PASSENGER AIR BAG OFF indicator lamp must be lit.
- ▶ NEVER use a rearward-facing child restraint system on a seat with an ENABLED FRONT AIRBAG; DEATH or SERIOUS INJURY to the CHILD can occur.

Observe the specific instructions for the rearward-facing and forward-facing child restraint systems (→ page 62).

If it is absolutely necessary to install a child restraint system on the front passenger seat, always observe the following notes:

- When using a rearward-facing child restraint system on the front passenger seat, the front passenger air bag must always be disabled. This is only the case if the PASSENGER AIR BAG OFF indicator lamp is lit continuously (→ page 44).

- The front passenger air bag is enabled when the PASSENGER AIR BAG OFF indicator lamp is not lit. The front passenger air bag may be deployed during an accident. In that case, do not use rearward-facing child restraint systems.

### Information on automatic front passenger air bag shutoff

If the front passenger seat is occupied, ensure, both before and during the journey, that the status of the front passenger air bag is correct for the current situation.

**⚠ WARNING** Risk of injury or death due to objects between the seat surface and the child restraint system

Objects between the seat surface and the child restraint system can interfere with the function of the automatic front passenger air bag shutoff.

- ▶ Do not place any objects between the seat surface and the child restraint system.
- ▶ Make sure that the entire base of the child restraint system rests on the seat cushion of the front passenger seat.
- ▶ The backrest of a forward-facing child restraint system must, as far as possible, be resting against the seat backrest of the front passenger seat.
- ▶ Always comply with the installation instructions from the child restraint system manufacturer.

When installing a child restraint system on the front passenger seat, observe the vehicle-specific information (→ page 60).

#### **Rearward-facing child restraint system on the front passenger seat**

If a rearward-facing child restraint system is installed on the front passenger seat, the front passenger air bag must be disabled. The PASSENGER AIR BAG OFF indicator lamp must be continuously lit (→ page 44).

**⚠ WARNING** Risk of injury or fatal injury when using a rearward-facing child restraint system while the co-driver airbag is enabled

If you secure a child in a rearward-facing child restraint system on the co-driver seat and the PASSENGER AIR BAG OFF indicator lamp is off, the co-driver airbag can deploy in the event of an accident.

The child could be struck by the airbag.

- ▶ Always ensure that the co-driver airbag is disabled. The PASSENGER AIR BAG OFF indicator lamp must be lit.
- ▶ NEVER use a rearward-facing child restraint system on a seat with an ENABLED FRONT AIRBAG; DEATH or SERIOUS INJURY to the CHILD can occur.

- ⓘ Depending on the child restraint system and the stature of the child, the front passenger air bag will be enabled. The PASSENGER AIR BAG OFF indicator lamp will not light up. The front passenger air bag may be deployed during an accident. If the front passenger air

bag has this status, no rearward-facing child restraint system may be installed on the front passenger seat. Instead, install the rearward-facing child restraint system on a suitable rear seat.

#### **Forward-facing child restraint system on the front passenger seat**

If a forward-facing child restraint system is installed on the front passenger seat, the front passenger air bag may be automatically enabled or disabled. The status of the front passenger air bag depends on the child restraint system and the stature of the child.

The PASSENGER AIR BAG OFF indicator lamp will either light up continuously or not light up (→ page 44). Always observe the following information.

**⚠ WARNING** Risk of injury or death due to incorrect positioning of the child restraint system

If you secure a child in a forward-facing child restraint system on the co-driver seat and you position the co-driver seat too close to the dashboard, in the event of an accident, the child could:

- come into contact with the vehicle's interior if the PASSENGER AIR BAG OFF indicator lamp is lit, for example
  - be struck by the airbag if the PASSENGER AIR BAG OFF indicator lamp is off
- ▶ Always move the co-driver seat as far back as possible. In doing so, always make sure that the shoulder belt strap is correctly routed from the seat belt outlet of the vehicle to the shoulder belt guide on the child restraint system. The shoulder belt strap must be routed forwards and downwards from the seat belt outlet. If necessary, adjust the seat belt outlet and the co-driver seat accordingly.

▶ Always comply with the child restraint system manufacturer's installation instructions.

Be sure to also observe the following further related subjects:

- Function of the automatic front passenger air bag shutoff (→ page 44)

### Suitable child restraint systems for the transport of children

#### Information on the benefit of a rearward-facing child restraint system

Transport a baby in a suitable rearward-facing child restraint system only. It is also preferable to transport a small child in a suitable rearward-facing child restraint system. In this case, the child sits in the opposite direction to the direction of travel and faces backwards.

Babies and small children have comparatively weak neck muscles in relation to the size and weight of their head. The risk of injury to the cer-

vical spine during an accident can be reduced in a rearward-facing child restraint system.

### Securing the child restraint system

#### Adjusting the seat correctly

**When installing a child restraint system on the left or right rear seat, always observe the following:**

- ▶ Make sure that the child's feet do not touch the front seat. If necessary, move the front seat slightly forwards.

If the head restraint of the child restraint system cannot be fully extended when it is installed in the vehicle, this will result in restrictions on the maximum size setting for certain child restraint systems. Observe the child restraint system manufacturer's installation instructions.

- ⓘ Contact with the roof when the head restraint is fully extended and locked in place will not result in any restrictions on use.



 **When installing an ISOFIX/LATCH child restraint system, also observe the following:**

- ▶ **When using a rearward-facing child restraint system on a rear seat:** adjust the front seat so that it does not touch the child restraint system.
- ▶ **When using a forward-facing child restraint system with integrated child seat belt:** adjust the head restraint of the respective seat so that it does not push the child restraint system forwards. If necessary, the respective head restraint can be removed. In addition, the backrest of the child restraint system must lie as flat as possible against the backrest of the vehicle seat. After the child restraint system has been removed, replace the vehicle head restraint immediately and adjust correctly.
- ▶ The child restraint system must not be put under strain between the roof and seat cushion and/or be installed facing the wrong direction. Where possible, adjust the seat cushion inclination accordingly.

- ▶ Adjust the vehicle head restraints so that the child restraint system is not put under strain by the head restraint.

 **When installing a belt-secured child restraint system, also observe the following:**

- ▶ **When using a rearward-facing child restraint system on a rear seat:** adjust the front seat so that it does not touch the child restraint system.
- ▶ Also secure Top Tether if present (→ page 66).
- ▶ **When using a forward-facing child restraint system with integrated child seat belt:** adjust the head restraint of the respective seat so that it does not push the child restraint system forwards. If necessary, the respective head restraint can be removed. In addition, the backrest of the child restraint system must lie as flat as possible against the backrest of the vehicle seat. After the child restraint system has been removed, replace the vehicle head restraint immediately and adjust correctly.

- ▶ The backrest of the forward-facing child restraint system must be resting as flat as possible on the seat backrest of the rear seat.
- ▶ The child restraint system must not be put under strain between the roof and seat cushion and/or be installed facing the wrong direction. Where possible, adjust the seat cushion inclination accordingly.
- ▶ Adjust the vehicle head restraints so that the child restraint system is not put under strain by the head restraint.
- ▶ Make sure that the child's feet do not touch the front seat. If necessary, move the front seat slightly forwards.

 **Depending on the vehicle equipment, always observe the following when installing a belt-secured child restraint system on the front passenger seat:**

- ▶ Observe the notes on rearward- and forward-facing child restraint systems on the front passenger seat (→ page 60).
- ▶ **When using a forward-facing child restraint system integrated child seat belt:** remove the

head restraint from the respective seat, if possible. After the child restraint system has been removed, immediately replace the head restraint and adjust correctly.

- ▶ The backrest of the forward-facing child restraint system must be resting as flat as possible on the seat backrest of the front passenger seat.
- ▶ The child restraint system must not be put under strain between the roof and seat cushion and/or be installed facing the wrong direction.
- ▶ Adjust the vehicle head restraints so that the child restraint system is not put under strain by the head restraint.
- ▶ Never place objects (e.g. cushions) under or behind the child restraint system.
- ▶ Set the front passenger seat as far back as possible and move the seat into the highest position if possible. Always make sure that the shoulder belt strap is correctly routed from the seat belt outlet of the vehicle to the shoulder belt guide on the child restraint system. The shoulder belt strap must be routed for-

wards from the seat belt outlet and, where possible, downwards to the child restraint system.

- ▶ Fully retract the seat cushion length adjustment.
- ▶ Adjust the seat cushion inclination so that the front edge of the seat cushion is in the highest position and the rear edge of the seat cushion is in the lowest position.
- ▶ Set the seat backrest to the most vertical position possible.

#### Activating or deactivating the special seat belt retractor of the seat belt

**⚠ WARNING** Risk of injury or death if a seat belt is unfastened while the vehicle is in motion

If the seat belt is released while the vehicle is in motion, the special seat belt retractor is deactivated and the child restraint system is no longer correctly secured. The seat belt is drawn in slightly by the inertia reel and cannot be immediately closed again.

- ▶ Stop the vehicle immediately in accordance with the traffic conditions.
- ▶ Activate the special seat belt retractor again and correctly secure the child restraint system.

When enabled, the child seat safety feature ensures that the seat belts of the front passenger seat and rear seats do not slacken once the child restraint system is secured.

The seat belts on the following seats are equipped with a child seat safety feature:

- Front passenger seat
- Rear seats

#### Installing a child restraint system

- ▶ When installing a child restraint system, always observe the manufacturer's installation and operating instructions as well as the information in this Operator's Manual.
- ▶ Pull the seat belt smoothly from the seat belt outlet.
- ▶ Engage the seat belt tongue in the belt buckle.

**Activating the special seat belt retractor:**

- ▶ Pull the seat belt out fully and let the inertia reel retract it again. When the special seat belt retractor is activated, you should hear a ratcheting sound.
- ▶ Push the child restraint system down until the seat belt sits tightly.

**Deactivating the special seat belt retractor:**

- ▶ Press the release button of the seat belt buckle.
- ▶ Hold the seat belt tongue and guide back to the seat belt outlet.

**Installing an ISOFIX/LATCH child restraint system**

**⚠ WARNING** Risk of accident if the rear bench seat, rear seat and seat backrest are not engaged

The rear bench seat, rear seat and seat backrest may fold forwards, even when you are driving.

- As a result, the vehicle occupant will be pushed into the seat belt with increased force. The seat belt will not be able to protect as intended and could cause additional injury.
  - Objects or loads in the trunk or cargo compartment will not be restrained by the seat backrest.
- ▶ Make sure that the rear bench seat, the rear seat and the seat backrest are engaged before every trip.

If the rear seat backrest is not engaged and locked in place, the red lock verification indicator will be visible.

**⚠ WARNING** Risk of injury or death if the permissible gross mass of the child and child restraint system together is exceeded.

Too much load may be placed on the LATCH-type (ISOFIX) or iSize child restraint systems and the child may not be restrained correctly in the event of an accident, for example.

- ▶ If the child is secured in a LATCH-type (ISOFIX) child restraint system with integrated seat belt, the total mass of the child and child restraint system must not exceed 73 lb (33 kg).

Always comply with the information about the mass of the child:

- in the manufacturer's installation and operating instructions for the child restraint system used
- on a label on the child restraint system, if available

Regularly check that the permissible gross mass of the child and child restraint system is still complied with.

When you install a child restraint system, observe the following:

- ✓ Always observe the correct use and suitability of the seats for attaching a child restraint system.

LATCH-type (ISOFIX) securing rings

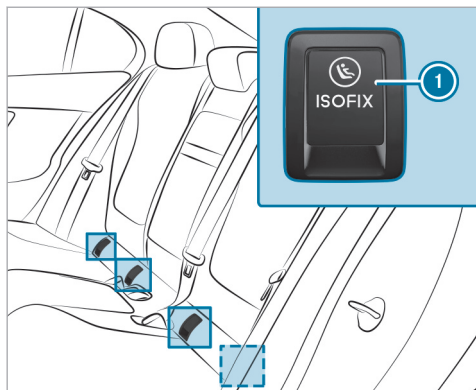

❶ LATCH-type (ISOFIX) securing rings

Before every journey, make sure that the ISOFIX/LATCH child restraint system has engaged both securing rings in the vehicle correctly.

**!** **NOTE** Damage to the seat belt for the center seat during installation of the child restraint system

▶ Make sure that the seat belt is not trapped.

- ▶ Fold the respective covers of LATCH-type (ISOFIX) securing rings ❶ backwards.
- ▶ Attach the ISOFIX/LATCH child restraint system to both securing rings ❶ in the vehicle.

### Fastening a Top Tether

**!** **WARNING** Risk of injury or death if the rear seat backrests are not locked after Top Tether belts are installed

The rear seat backrests may fold forwards when you are driving.

As a result, child restraint systems will no longer be able to perform their intended protective function. This may also cause additional injuries.

- ▶ Always lock rear seat backrests after installing Top Tether belts.
- ▶ Observe the lock verification indicator.

If the rear seat backrest is not engaged and locked in place, the red lock verification indicator will be visible.



If the child restraint system is equipped with a Top Tether belt:

The risk of injury may be reduced by Top Tether. The Top Tether belt enables an additional connection between the child restraint system attached with ISOFIX (left and right rear seats) or the seat belt (all rear seats) and the vehicle.

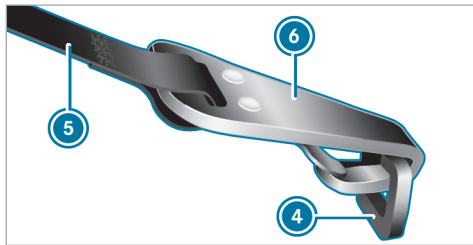
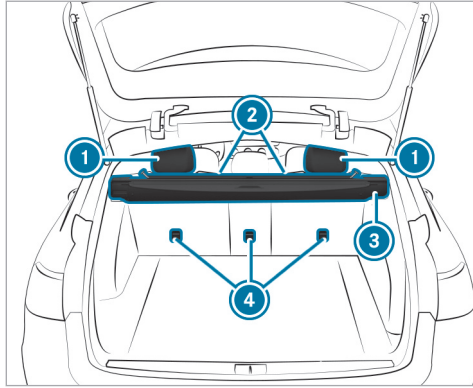

- ▶ If necessary, slide head restraint ❶ upwards (→ page 103).
- ▶ Install the ISOFIX or belt-secured child restraint system with Top Tether. In doing so, comply with the child restraint system manufacturer's installation instructions.
- ▶ Guide Top Tether belt ❺ under head restraint ❶ between the two head restraint bars.
- ▶ Guide Top Tether belt ❺ downwards between cargo compartment cover ❸ and seat backrest ❷.
- ▶ Hook Top Tether hook ❻ of Top Tether belt ❺ into Top Tether anchorage ❹ without twisting.
- ▶ Tension Top Tether belt ❺. In doing so, comply with the child restraint system manufacturer's installation instructions.
- ▶ If necessary, slide head restraint ❶ downwards (→ page 103). Make sure that you do not interfere with the correct routing of Top Tether belt ❺.

### Securing the child restraint system with the seat belt

**⚠ WARNING** Risk of accident if the rear bench seat, rear seat and seat backrest are not engaged

The rear bench seat, rear seat and seat backrest may fold forwards, even when you are driving.

- As a result, the vehicle occupant will be pushed into the seat belt with increased force. The seat belt will not be able to protect as intended and could cause additional injury.
- Objects or loads in the trunk or cargo compartment will not be restrained by the seat backrest.

▶ Make sure that the rear bench seat, the rear seat and the seat backrest are engaged before every trip.

If the rear seat backrest is not engaged and locked in place, the red lock verification indicator will be visible.

The seat belts on the following seats are equipped with a special seat belt retractor:

- Front passenger seat
- Rear seats

When enabled, the special seat belt retractor ensures that the seat belts of the front passenger seat and rear seats do not slacken once the child restraint system is secured.

- ▶ For a child restraint system in the "Universal" or "Semi-Universal" category, make sure that the system has been approved for the vehicle seat.
- ▶ Install the child restraint system. The entire base of the child restraint system must always rest on the sitting surface of the seat.
- ▶ Always make sure that the shoulder belt strap is correctly routed from the seat belt outlet of the vehicle to the shoulder belt guide on the child restraint system. The shoulder belt strap must be routed forwards from the seat belt outlet and, where

possible, downwards to the child restraint system.

- ▶ **When installing on the rear seat:** also secure Top Tether if present.
- ▶ **When installing on the front passenger seat:** if necessary, adjust the seat belt outlet and the front passenger seat accordingly.

### Child safety locks

#### Activating or deactivating the child safety lock for the rear doors

**⚠ WARNING** Risk of accident and injury if children are left unattended in the vehicle

If children are left unattended in the vehicle, they could in particular:

- open doors, thereby endangering other persons or road users.
- get out and be struck by oncoming traffic.
- operate vehicle equipment and become trapped, for example.

In addition, the children could also set the vehicle in motion, for example by:

- releasing the parking brake.
- changing gear.
- starting the vehicle.
- ▶ Never leave children unattended in the vehicle.
- ▶ When leaving the vehicle, always take the SmartKey with you and lock the vehicle.
- ▶ Keep the SmartKey out of the reach of children.

**⚠ WARNING** Risk of fatal injury due to exposure to extreme heat or cold in the vehicle

If persons, particularly children, are subjected to prolonged exposure to intense heat or cold, there is a risk of severe injury or even death.

- ▶ Never leave persons, particularly children, unattended in the vehicle.

**⚠ WARNING** Risk of accident and injury due to children left unattended in the vehicle

If children are traveling in the vehicle, they could, in particular:

- Open doors, thereby endangering other persons or road users.
  - Get out and be struck by oncoming traffic.
  - Operate vehicle equipment and become trapped, for example.
- ▶ Always activate the installed child safety locks if children are traveling in the vehicle.
- ▶ Never leave children unattended in the vehicle.
- ▶ When leaving the vehicle, always take the SmartKey with you and lock the vehicle.

There are child safety locks for the rear doors and the rear side windows.

The child safety lock on the rear doors secures each door separately. The doors can no longer be opened from the inside.

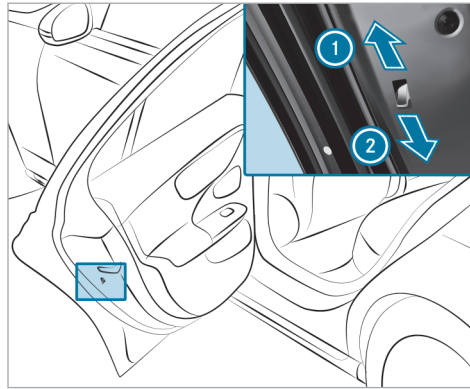

- ▶ Press the lever in direction ① (activate) or ② (deactivate).
- ▶ Make sure that the child-proof locks are working properly.

**Activating and deactivating the child safety lock for the rear side windows**

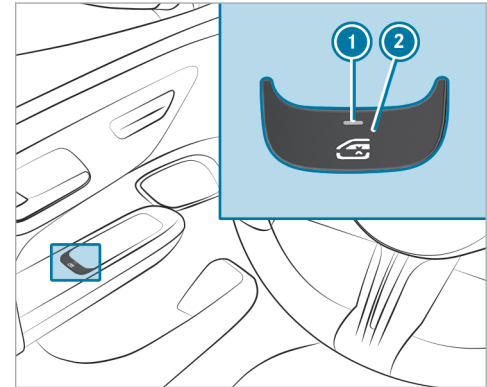

- ▶ **To activate/deactivate:** press button ②.
- The rear side window can be opened or closed in the following cases:
- Indicator lamp ① is lit: via the switch on the driver's door

- Indicator lamp  is off: via the switch on the corresponding rear door or driver's door

### Occupant presence reminder

#### Function of the occupant presence reminder

The occupant presence reminder can help to remind you about a child who may have been forgotten in the rear passenger compartment of the vehicle. It activates and deactivates automatically when a rear door is open for an extended period of time and a child, which the system presumes to be present, could enter or exit the vehicle.

When the vehicle is switched off, the **Do Not Leave People or Animals in the Vehicle** message will appear on the driver's display if the system has previously activated automatically.

You can permanently deactivate the function in the multimedia system (→ page 70). When the system is deactivated, the  indicator lamp on the driver's display lights up.

#### Activating or deactivating the occupant presence reminder in the multimedia system

Multimedia system:

→  » Settings » Vehicle  
» Occupant Protection

▶ Activate or deactivate the function.



## SmartKey

### Overview of key functions

**⚠ WARNING** Risk of accident and injury due to children left unattended in the vehicle

If you leave children unattended in the vehicle, they could, in particular:

- open doors, thereby endangering other persons or road users.
- get out and be struck by oncoming traffic.
- operate vehicle equipment and become trapped, for example.

In addition, the children could also set the vehicle in motion by, for example:

- releasing the parking brake.
- changing the gearbox position.
- starting the vehicle.

▶ Never leave children unattended in the vehicle.

- ▶ When leaving the vehicle, always take the key with you and lock the vehicle.
- ▶ Keep the key out of reach of children.

This also applies to the Digital Vehicle Key.

**⚠ NOTE** Damage to the SmartKey caused by magnetic fields



- ▶ Keep the SmartKey away from strong magnetic fields.



Vehicle key with panic alarm

- ① Opens/closes the tailgate
- ② Unlocks (with embossed surface)

- ③ Locks
- ④ Indicator lamp
- ⑤ Panic alarm

**i** If indicator lamp ④ does not light up after you press the  or  button, the battery may be weak or possibly discharged. Replace the battery as soon as possible.

Replace the key battery (→ page 73).

The key locks and unlocks the following components:

- Doors
- Fuel filler flap
- Socket flap (plug-in hybrid)
- Tailgate

If the vehicle is not opened within approximately 40 seconds after unlocking, it will lock again. Anti-theft protection will be armed again.

Do not keep the key together with electronic devices or metal objects. This may affect the key's functionality.

### Activating/deactivating the acoustic locking verification signal

Multimedia system:

→  >> Settings >> Vehicle

>> Open/Close

▶ Activate or deactivate the Acoustic Lock.

### Activating/deactivating the panic alarm

#### Requirements

- The vehicle is switched off.

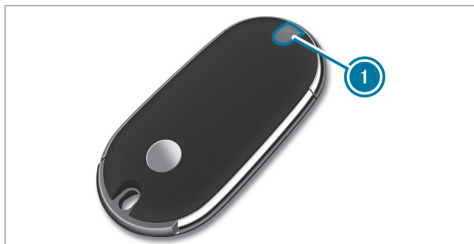

▶ **To activate:** press button  for approximately one second.

A visual and audible alarm is triggered.

▶ **To deactivate:** briefly press button  again.

or



▶ Press the start/stop button.

A key belonging to the vehicle must be detected in the vehicle.

### Changing the unlocking settings

Possible unlocking functions of the key:

- Central unlocking
- Unlocking the driver's door and fuel filler flap
- **Plug-in hybrid:** unlocking the driver's door and fuel filler flap/socket flap

▶ **To switch between settings:** press the  and  buttons simultaneously for approximately six seconds until the indicator lamp flashes twice.

Options if the unlocking function for the driver's door and fuel filler flap has been selected:

- **To unlock the vehicle centrally:** press the  button twice.
- **Vehicles with KEYLESS-GO:** if you touch the inner surface of the door handle on the driver's door, only the driver's door and the fuel filler flap are unlocked.

Options if the unlocking function for the driver's door and fuel filler flap / socket flap has been selected (plug-in hybrid):



- **To unlock the vehicle centrally:** press the  button twice.
- **Vehicles with KEYLESS-GO:** if you touch the inner surface of the door handle on the driver's door, only the driver's door and the fuel filler flap / socket flap are unlocked.

### Deactivating the function of the key

**Vehicles with KEYLESS-GO:** if you deactivate the function of the SmartKey, the KEYLESS-GO functions will also be deactivated. Access or drive authorization by KEYLESS-GO will then no longer

be possible with that particular SmartKey. Activate the function of the SmartKey so that all its functions will again be available.

You can also deactivate the function of the SmartKey to reduce the energy consumption of the SmartKey if you do not use the vehicle or a SmartKey for an extended period of time.

- ▶ Press and hold the  button on the SmartKey.
- ▶ With the key button  pressed, immediately press key button  twice in quick succession.  
The indicator light of the key lights up once briefly and once for a long time.

- i** The following options for re-activating the SmartKey are available:
- Press any button on the SmartKey.
  - Start the vehicle with the SmartKey in the marked space in the center console (→ page 167).

### Removing/inserting the mechanical key

#### Removing the mechanical key

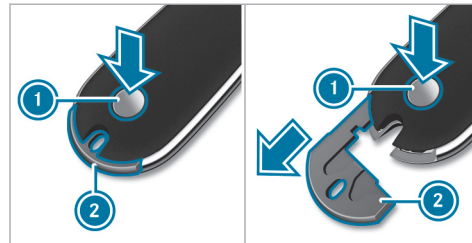

- ▶ Press release button **1**.
- ▶ Emergency key **2** is pushed out slightly.
- ▶ Fully remove mechanical key **2**.

#### Inserting the mechanical key

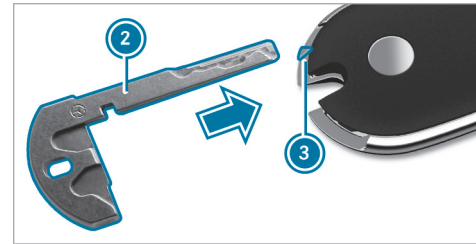

- ▶ Insert mechanical key **2** at marking **3** until it engages.
- i** You can use mechanical key **2** to attach the key to a key ring.

### Replacing the key battery

**⚠ DANGER** Risk of fatal injuries due to swallowing batteries

Batteries contain toxic and corrosive substances. If batteries are swallowed or otherwise

enter the body, severe internal burns can occur within two hours.

There is a risk of fatal injury.

- ▶ Keep batteries out of the reach of children.
- ▶ If the battery compartment cover and/or lid do not close securely, stop using the key and keep it away from children.
- ▶ If batteries are swallowed or otherwise enter the body, seek immediate medical attention.

 **ENVIRONMENTAL NOTE** Environmental damage due to improper disposal of batteries



Batteries contain pollutants. It is illegal to dispose of them with the household rubbish.



Dispose of batteries in an environmentally responsible manner. Take discharged batteries to a qualified specialist workshop or to a collection point for used batteries.

#### Requirements

- You require a CR 2032 3 V cell battery.

Mercedes-Benz recommends that you have the battery replaced at a qualified specialist workshop.

- ▶ Remove the emergency key (→ page 73).

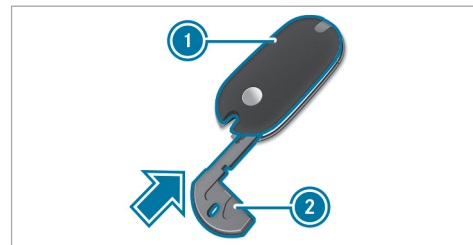

- ▶ Press emergency key ② into the opening in the key in the direction of the arrow until cover ① opens. When doing so, do not hold cover ① closed.

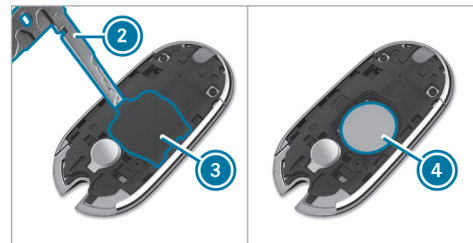

- ▶ Insert emergency key ② into the opening and lift up covering ③ and remove it.
- ▶ Repeatedly tap the key against your palm until battery ④ falls out of the key.
- ▶ Insert the new battery with the positive pole facing upwards. Use a lint-free cloth to do so.
- ▶ Make sure that the surface of the battery is free of lint, grease and other impurities.
- ▶ Insert the front tabs of covering ③ into the housing and then press on both sides to close it.
- ▶ Make sure that covering ③ is completely closed.
- ▶ Insert the front tabs of cover ① into the housing and then press until it is completely closed.
- ▶ Insert the emergency key again (→ page 73).

### Problems with the key, troubleshooting

#### **You can no longer lock or unlock the vehicle**

Possible causes are:

- The key battery is weak or discharged.
- ▶ Check the battery using the indicator lamp (→ page 71).
- ▶ Replace the key battery, if necessary (→ page 73).
- ▶ Use the replacement key.
- ▶ Use the mechanical key to lock or unlock (→ page 80).
- ▶ Have key checked at a qualified specialist workshop.

#### **There is interference from a powerful radio signal source**

Possible causes if the function of the key is impaired:

- high voltage power lines
- mobile phones
- electronic devices (notebooks, tablets)

- shielding due to metal objects or induction loops for electrical gate systems or automatic barriers

- ▶ Make sure that there is sufficient distance between the key and the potential source of interference.

#### **You have lost a key**

- ▶ Have the key deactivated at a qualified specialist workshop.
- ▶ If necessary, have the mechanical lock replaced as well.

### **Digital Vehicle Key**

#### Unlocking and locking the vehicle with the digital vehicle key

##### **Requirements**

- The vehicle is equipped with the "Digital Vehicle Key" pre-installation.
- The "Digital Vehicle Key" function is activated via Mercedes me: <https://www.mercedes.me>.

- A suitable end device is activated as a Digital Vehicle Key.
- Bluetooth® is switched on at the end device and at the vehicle.
- The terminal is sufficiently charged.
- ① If the connection via Bluetooth® is faulty or the battery of the Digital Vehicle Key is very low, you can also lock, unlock or start the vehicle via the NFC function. (→ page 167).

The Digital Vehicle Key can be used for the following functions:

- Locking and unlocking the vehicle with the NFC function
- Locking/unlocking the vehicle with KEYLESS-GO (→ page 78)
- HANDS-FREE ACCESS function (→ page 84)
- Convenience closing (closing the vehicle from outside) (→ page 89)
- Anti-theft protection (→ page 94)
- Starting the vehicle (→ page 166) or parking (→ page 213)

- Start the vehicle with the Digital Vehicle Key in the marked space (emergency operation mode) (→ page 167)
- ① Mercedes-Benz recommends that you carry the emergency key in case of function restrictions (→ page 73).
- ① Mercedes-Benz recommends that you place the Digital Vehicle Key in the marked space while driving (→ page 167).
- ① For more information on the Digital Vehicle Key, see the digital Operator's Manual.

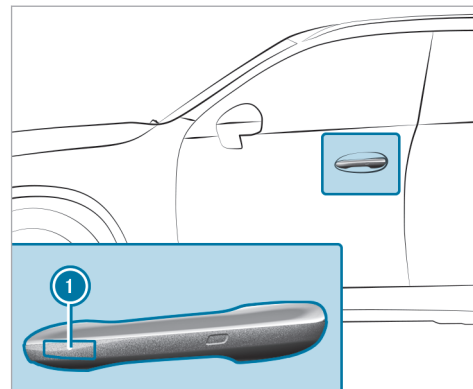

▶ **To lock and unlock the vehicle with the NFC function** hold the Digital Vehicle Key near NFC antenna ① on the door handle.

### Fixing problems with the Digital Vehicle Key

#### You can no longer lock and unlock the vehicle with the Digital Vehicle Key.

Possible causes are:

- Bluetooth® is switched off on the Digital Vehicle Key or in the vehicle.
  - The battery of the Digital Vehicle Key is low or empty.
- ▶ Switch on Bluetooth® on the Digital Vehicle Key or in the vehicle.
  - ▶ Check the state of charge of the Digital Vehicle Key battery.
  - ▶ If necessary, charge the battery of the Digital Vehicle Key.
  - ▶ Use the NFC function of the Digital Vehicle Key to lock or unlock the vehicle. (→ page 75).
  - ▶ Use the vehicle key.
  - ▶ Use the emergency key to lock or unlock the vehicle (→ page 80).

- ▶ Have the vehicle and the Digital Vehicle Key checked at a qualified specialist workshop.

#### There is interference from a powerful radio signal source

Possible causes of Digital Vehicle Key impairment:

- High-voltage power lines
  - Mobile phones
  - Electronic devices (notebooks, tablets)
  - Shielding due to metal objects or induction loops for electrical gate systems or automatic barriers
- ▶ Ensure sufficient distance between the Digital Vehicle Key and a potential source of interference.

#### You have lost a Digital Vehicle Key.

- ▶ Remove the Digital Vehicle Key.
- ⓘ For information on removing the Digital Vehicle Key, see the Digital Operator's Manual.

### Doors

#### Unlocking/opening the doors from the inside

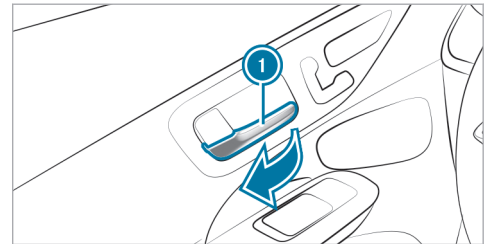

- ▶ **To unlock and open a front door:** pull door handle ①.
- ▶ **To unlock a rear door:** pull the rear door handle.
- ▶ **To open a rear door:** pull the rear door handle again.

### Centrally locking and unlocking the vehicle from the inside

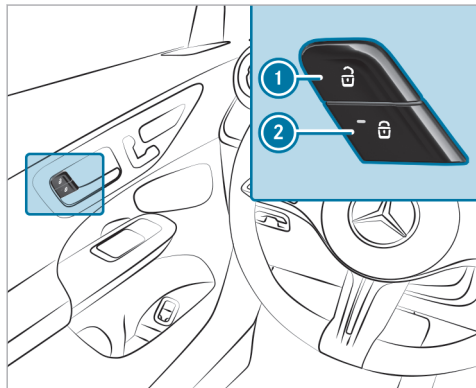

▶ **To unlock:** press ① button.

▶ **To lock:** press button ②.  
The red indicator lamp on button ② lights up once the vehicle is locked.

① The buttons are also on the front passenger and rear doors.

This does not lock or unlock the fuel filler flap.

**Plug-in hybrid:** the socket flap is also locked and unlocked. The socket flap can be opened even if a key is detected in the car.

The vehicle is not unlocked:

- if you have locked the vehicle using the key
- if you have locked the vehicle using KEYLESS-GO

### Locking/unlocking the vehicle with KEYLESS-GO

#### Requirements

- The key is outside the vehicle.
- The distance between the key and the vehicle does not exceed 3 ft (1 m).
- The driver's door and the door on which the door handle is used are closed.

① **Vehicles with Digital Vehicle Key:** You can use the Digital Vehicle Key like the conventional vehicle key.

! **NOTE** Vehicle damage due to unintentional opening of the tailgate

- When using an automatic car wash
- When using a high pressure cleaner

▶ Deactivate the function of the SmartKey in these situations.

or

▶ Make sure that the SmartKey is at a minimum distance of 10 ft (3 m) away from the vehicle.

#### Vehicles with digital vehicle key:

! **NOTE** Vehicle damage due to unintentional opening of the tailgate or a door

- when using an automatic car wash
- when using a power washer

▶ In these situations, switch off the Digital Vehicle Key.

or



- ▶ Make sure that the Digital Vehicle Key is at least 10 ft (3 m) (power washer) or 20 ft (6 m) (car wash) away from the vehicle.

Observe the notes:

- on washing the vehicle in a car wash (→ page 379)
- on using a power washer (→ page 381)

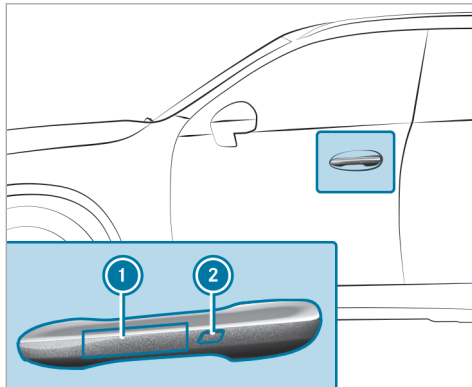

- ▶ **To unlock the vehicle:** touch the inner surface of the door handle.
  - ▶ **To lock the vehicle:** touch sensor surface ① or ②.
  - ▶ **Convenience closing:** touch recessed sensor surface ② for an extended period.
- ① Further information on convenience closing (→ page 89).

#### Problems with KEYLESS-GO, troubleshooting

##### **You can no longer lock or unlock the vehicle using KEYLESS-GO**

Possible causes:

- The function of the SmartKey has been deactivated.
  - The SmartKey battery is weak or discharged.
- ▶ Activate the function of the SmartKey (→ page 72).
  - ▶ Check the battery using the indicator lamp (→ page 71).

- ▶ Replace the SmartKey battery, if necessary (→ page 73).
- ▶ Use the replacement SmartKey.
- ▶ Use the emergency key to lock or unlock (→ page 80).
- ▶ Have the vehicle and SmartKey checked at a qualified specialist workshop.

##### **There is interference from a powerful radio signal source**

Possible causes if the function of KEYLESS-GO is impaired:

- High voltage power lines
  - Mobile phones
  - Electronic devices (notebooks, tablets)
  - Shielding due to metal objects or induction loops for electrical gate systems or automatic barriers
- ▶ Make sure that there is sufficient distance between the SmartKey and the potential source of interference.

### Activating/deactivating the automatic locking mechanism

Multimedia system:

→  ▶▶ Settings ▶▶ Vehicle  
▶▶ Open/Close

**i** The vehicle is locked automatically when it is switched on and the wheels are turning faster than walking pace.

▶ Activate or deactivate **Automatic Door Lock**.

In the following situations, there is a danger of being locked out when the function is activated:

- The vehicle is being towed or pushed.
- If the vehicle is being tested on a roller dynamometer.

### Locking/unlocking the vehicle with the emergency key

#### Unlocking a left-hand vehicle door with the mechanical key

**i** If you unlock and open the driver's door with the emergency key, this triggers the burglar alarm system.

**i** If you unlock the driver's door with the emergency key, the tailgate will not be unlocked.

▶ Remove the emergency key (→ page 73).

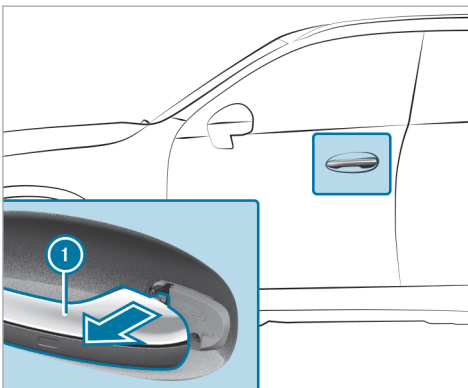

▶ Pull and hold door handle **1**.

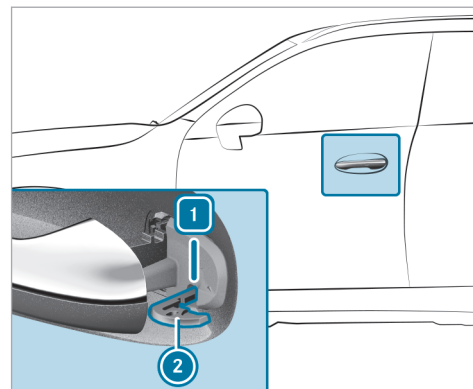

▶ Insert emergency key **2** into the lock cylinder as shown.

▶ Turn emergency key **2** counter-clockwise to position **1**.

▶ Turn emergency key **2** back to its starting position.

▶ Remove emergency key **2** and release door handle **1**.

## Locking the doors

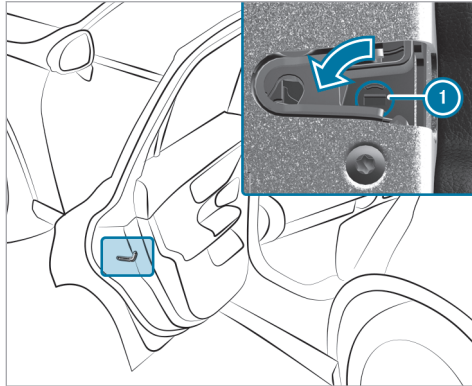

- ▶ Insert a suitable object, e.g. the emergency key, into opening ① on the door lock.
- ▶ **To lock the left-hand side of the vehicle:** turn the emergency key counter-clockwise as far as it will go.

- ▶ **To lock the right-hand side of the vehicle:** turn the emergency key clockwise as far as it will go.

If the locked door is then closed, it can no longer be opened from the outside.

## Running boards

### Notes on running boards

Your vehicle is equipped with running boards. Observe the following instructions for using the running boards.

Keep the running boards and footwear free of dirt and step only on the studded area. This will make your footing safer.

- ❗ **NOTE** Damage to the vehicle body or underbody due to low ground clearance

The running boards are attached to the vehicle body via the underbody. This limits the ground clearance.

- ▶ Drive over obstacles, such as curbs, particularly carefully and slowly.

## Cargo compartment

### Opening the tailgate

- ⚠ **DANGER** Risk of exhaust gas poisoning

Combustion engines emit poisonous exhaust gases such as carbon monoxide. Exhaust gases can enter the vehicle interior if the tailgate is open when the engine is running, especially if the vehicle is in motion.

- ▶ Always switch off the engine before opening the tailgate.
- ▶ Never drive with the tailgate open.

- ❗ **NOTE** Damage to the tailgate caused by obstacles above the vehicle

The tailgate swings rearwards and upwards when it is opened.

- ▶ Make sure that there is sufficient space behind and above the tailgate.

- ① Limiting the opening angle of the tailgate (→ page 86).

- ▶ If the tailgate is unlocked, press the top of the Mercedes star.
- ▶ **Vehicles with HANDS-FREE ACCESS:** Make a kicking movement with your foot below the bumper (→ page 84).

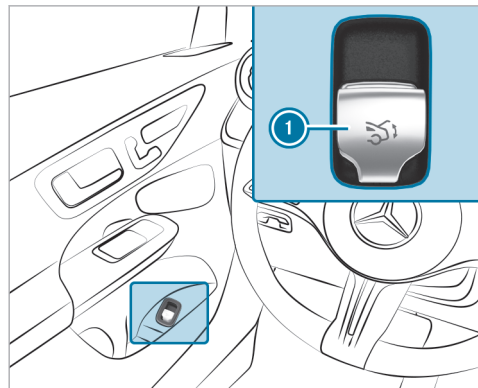

- ▶ Pull remote operating switch ① until the tailgate opens.

or

- ▶ Press and hold the  button on the SmartKey.
- ▶ If the tailgate has stopped in an intermediate position, pull it upwards. Release it as soon as it begins to open.

If an obstacle obstructs the tailgate during the automatic opening process, blockage detection will stop the tailgate. The automatic blockage detection function is only an aid. It is not a substitute for your attentiveness.

### Closing the tailgate

**⚠ WARNING** Risk of injury from unsecured items in the vehicle

If objects, luggage or loads are not secured or not secured sufficiently, they could slip, tip over or be thrown around and thereby hit vehicle occupants.

There is a risk of injury, particularly in the event of sudden braking or a sudden change in direction.

- ▶ Always stow objects in such a way that they cannot be thrown around.
- ▶ Before the journey, secure objects, luggage or loads against slipping or tipping over.

Observe the notes on loading the vehicle.

**Notes on closing the tailgate:** your vehicle is equipped with automatic SmartKey recognition. If a SmartKey belonging to the vehicle is detected in the vehicle, the tailgate will not be locked.

Note that the tailgate will not be locked in the following situation:

- You have locked the vehicle and close the tailgate while a SmartKey belonging to the vehicle is inside the vehicle.  
and
- A second SmartKey belonging to the vehicle is not detected outside the vehicle.

Automatic SmartKey recognition is only an aid and is not a substitute for your attentiveness.

- ▶ Before locking, ensure that at least one SmartKey belonging to the vehicle is outside the vehicle.
- ▶ **To close the tailgate:** pull the tailgate downwards slightly. Release it as soon as it begins to close.

**⚠ WARNING** Risk of becoming trapped during automatic closing of the tailgate

Parts of the body could become trapped. There may be people in the closing area.

- ▶ Make sure that nobody is in the vicinity of the closing area.

Use one of the following options to stop the closing process:

- Press the  button on the SmartKey.
- Press or pull the remote operating switch on the driver's door.
- Press the closing or locking button on the tailgate.
- Press the top of the Mercedes star on the tailgate.

**Vehicles with HANDS-FREE ACCESS:** it is also possible to stop the closing process by making a kicking movement below the rear bumper.

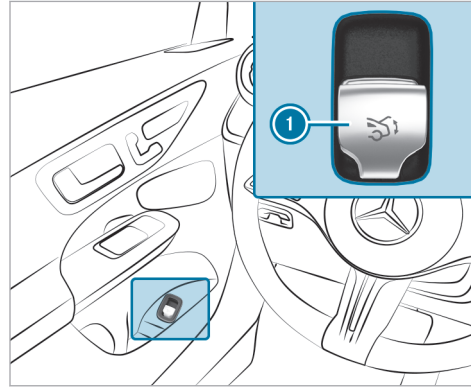

- ▶ Switch on the power supply or the vehicle.
- ▶ Push remote operating switch  until the tailgate is fully closed.

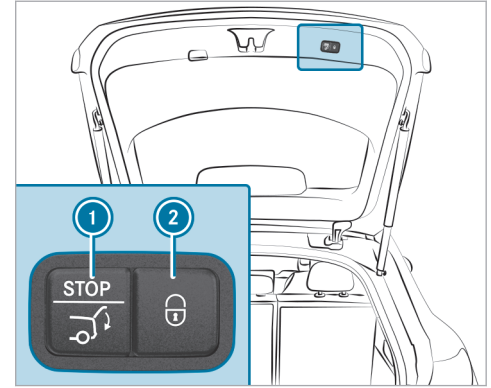

- ▶ Press closing button  on the tailgate.

**Vehicles with KEYLESS-GO**

- ▶ Press locking button  on the tailgate. If a SmartKey is detected outside the vehicle, the tailgate will close and the vehicle will be locked.

**i Vehicles with Digital Vehicle Key:** this also applies to the Digital Vehicle Key if the function is activated and the Digital Vehicle Key is connected to the vehicle.

▶ Press and hold the  button on the SmartKey. The SmartKey must be in the vicinity of the vehicle.

#### Vehicles with HANDS-FREE ACCESS

▶ Make a kicking movement with your foot below the bumper (→ page 84).

#### Automatic reversing function for the tailgate

The tailgate is equipped with automatic blockage detection with a reversing function. If an obstacle obstructs the tailgate during the automatic closing process, it will automatically open again slightly. Automatic blockage detection with the reversing function is only an aid and is not a substitute for your attentiveness.

▶ During the closing process, make sure that no body parts are in the closing area.

**⚠ WARNING** Risk of becoming trapped despite reversing function

The reversing function will not react:

- To soft, light and thin objects, e.g. fingers.
- Towards the end of the closing procedure.

In these situations in particular, the reversing function cannot prevent someone being trapped.

▶ Make sure that no body parts are in the closing area.

If someone is trapped, either:

- Press the  button on the SmartKey.
- Press or pull the remote operating switch on the driver's door.
- Press the closing or locking button on the tailgate.
- Press the top of the Mercedes star on the tailgate.

#### HANDS-FREE ACCESS function

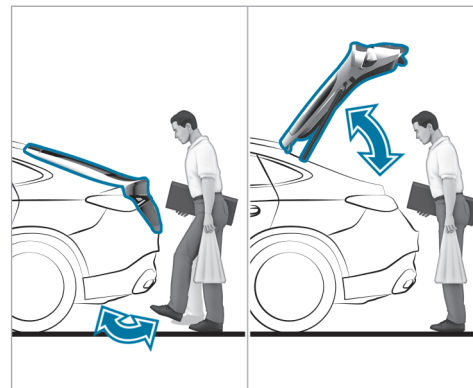

With HANDS-FREE ACCESS you can open, close or stop the tailgate by performing a kicking movement under the rear bumper. The transmission must be in position **P** for this.

The kicking movement triggers the opening or closing process alternately.

- If you stop the tailgate opening process with a kicking movement, the tailgate will be closed with the next kicking movement.

- If you stop the tailgate closing process with a kicking movement, the tailgate will be opened with the next kicking movement.

The tailgate can only be closed with HANDS-FREE ACCESS in the following situations:

- When the vehicle is switched on and the SmartKey's unlocking function has been set so that unlocking will only unlock the driver's door (→ page 72).
- If the vehicle was locked centrally from the inside (→ page 78).

Observe the notes when opening (→ page 81) and closing (→ page 82) the tailgate.

-  Two warning tones sound while the tailgate is opening or closing.

 **WARNING** Risk of burns caused by a hot exhaust system

The vehicle exhaust system can become very hot. If you use HANDS-FREE ACCESS, you could burn yourself by touching the exhaust system.

- ▶ Always ensure that you only make a kicking movement within the detection range of the sensors.

 **NOTE** Vehicle damage due to unintentional opening of the tailgate or a door

- When using an automatic car wash
- When using a high pressure cleaner
- ▶ Deactivate the function of the SmartKey in these situations.
- or
- ▶ Make sure that the SmartKey is at a minimum distance of 10 ft (3 m) (power washer) or 20 ft (6 m) (automatic car wash) away from the vehicle.

#### Vehicles with Digital Vehicle Key:

 **NOTE** Vehicle damage due to unintentional opening of the tailgate or a door

- when using an automatic car wash

- when using a power washer
- ▶ In these situations, switch off the Digital Vehicle Key.

or

- ▶ Make sure that the Digital Vehicle Key is at least 10 ft (3 m) (power washer) or 20 ft (6 m) (car wash) away from the vehicle.

When making the kicking movement, make sure that your footing is firm. You could otherwise lose your balance, e.g. on ice.

Observe the following notes:

- The SmartKey is behind the vehicle.  
If the SmartKey is not detected:
  - Hold the SmartKey in your hand.
  - or
  - Ensure that the SmartKey function is activated (→ page 72).
- **Vehicles with Digital Vehicle Key:** the Digital Vehicle Key is behind the vehicle.

- Stand at least 12 in (30 cm) away from the vehicle while performing the kicking movement.
- Do not touch the bumper while making the kicking movement.
- Do not carry out the kicking movement too slowly.
- The kicking movement must be towards the vehicle and back again.
- **Vehicles with trailer hitch:** perform the kicking movement to the left or right of the ball head.

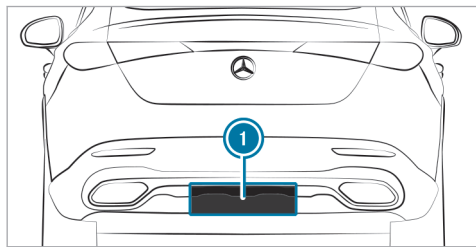

① Detection range of the sensors

If several consecutive kicking movements are not successful, wait ten seconds.

### System limits

The system may be impaired or may not function in the following cases:

- The sensors are dirty, e.g. due to road salt or snow.
- The kicking movement is made using a prosthetic leg.

The tailgate can open or close unintentionally in the following situations:

- A person's arms or legs are moving in the sensor detection range, e.g. when polishing the vehicle or picking up objects.
- Objects are moved or placed behind the vehicle, e.g. the hose of a fuel dispenser, a charging cable or luggage
- Clamping straps, tarp or other coverings are pulled over the bumper.
- A protective mat with a length reaching over the loading sill down into the detection range of the sensors is used.

- The protective mat is not secured correctly.
- **Vehicles with trailer hitch:** work is being done on the trailer hitch, trailers or rear bicycle racks.

Deactivate the function of the SmartKey (→ page 72) or do not carry the SmartKey about your person in such situations.

### Limiting the opening angle of the tailgate

#### Activating the opening angle limiter

You can limit the opening angle of the tailgate in the top half of its opening range up to a point shortly before the end position.

- ▶ Stop the opening procedure of the tailgate at the desired position.
- ▶ Press and hold the closing button on the tailgate until you hear a short acoustic signal. The opening angle limiter will be activated. The tailgate will then stop in the stored position when opened.



### Complete opening of the tailgate after automatic stop

- ▶ Press the top of the Mercedes star again.

### Deactivating the opening angle limiter

- ▶ Press and hold the closing button on the tailgate until two short acoustic signals sound.

### Unlocking the tailgate with the emergency key

#### Requirements:

- The rear seat backrest has been folded forward.
- The cargo compartment cover has been removed.

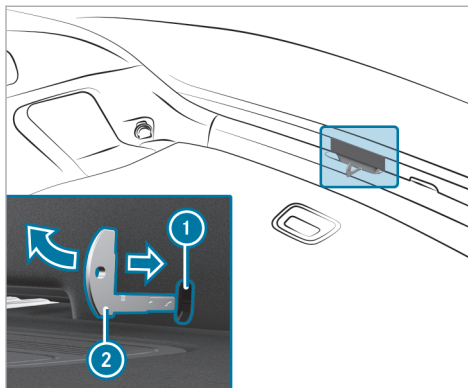

- ▶ Remove the emergency key (→ page 73).
- ▶ Insert emergency key ② into opening ① in the trim and push it in the direction of the arrow.  
The tailgate will be unlocked.

### Side windows

#### Opening and closing the side windows

- ⚠ **WARNING** Risk of entrapment when opening a side window

When opening a side window, parts of the body could be drawn in or become trapped between the side window and window frame.

- ▶ When opening, make sure that nobody is touching the side window.
- ▶ If someone is trapped, release the button immediately or pull it in order to close the side window again.

- ⚠ **WARNING** Risk of becoming trapped when closing a side window

When closing a side window, body parts could be trapped in the closing area in the process.

- ▶ When closing, make sure that no body parts are in the closing area.

- ▶ If someone is trapped, release the button immediately or press the button in order to reopen the side window.

**⚠ WARNING** Risk of becoming trapped when children operate the side windows

Children could become trapped if they operate the side windows, particularly when unattended.

- ▶ Activate the child safety lock for the rear passenger compartment side windows.
- ▶ When leaving the vehicle, always take the SmartKey with you and lock the vehicle.
- ▶ Never leave children unattended in the vehicle.

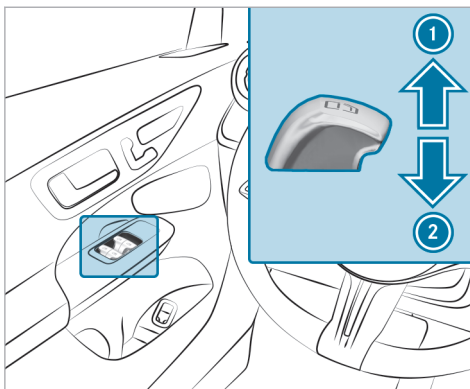

**Requirements:**

- The power supply or the vehicle has been switched on.



- ① Closing
- ② Opening

The buttons on the driver's door take precedence.

- ▶ **To start automatic operation:** press the  button beyond the pressure point or pull and release it.
- ▶ **To interrupt automatic operation:** press or pull the  button again.

When the vehicle is switched off, you can continue to operate the side windows.

This function is available for around four minutes or until a front door is opened.

**Automatic reversing function of the side windows**

If an obstacle impedes a side window during the closing process, the side window will open again automatically. The automatic reversing function is only an aid and is not a substitute for your attentiveness.

- ▶ During the closing process, make sure that no body parts are in the closing area.

**⚠ WARNING** Risk of becoming trapped despite there being reversing protection on the side window

The reversing function does not react:

- To soft, light and thin objects, e.g. fingers.
- During resetting.

The reversing function cannot prevent someone from becoming trapped in these situations.

- ▶ During the closing process, make sure that no body parts are in the closing area.
- ▶ If someone becomes trapped, press the  button to open the side window again.

### Convenience opening (ventilating the vehicle before starting a journey)

**⚠ WARNING** Risk of entrapment when opening a side window

When opening a side window, parts of the body could be drawn in or become trapped between the side window and window frame.

- ▶ When opening, make sure that nobody is touching the side window.
- ▶ Release the button immediately if somebody becomes trapped.

#### Requirements

- The SmartKey is in the immediate vicinity of the vehicle.

▶ Press and hold the  button on the SmartKey.

The following functions will be performed:

- The vehicle will be unlocked.
- The side windows will be opened.
- The panoramic sliding sunroof will be opened.
- The driver's seat ventilation will be switched on

ⓘ If the roller sunblind of the panoramic sliding sunroof is closed, the roller sunblind will be opened first.

▶ **To interrupt convenience opening:** release the  button.

▶ **To continue convenience opening:** press and hold the  button again.

### Convenience closing (closing the vehicle from outside)

**⚠ WARNING** Risk of entrapment due to not paying attention during convenience closing

When the convenience closing feature is operating, parts of the body could become trapped in the closing area of the side window and the sliding sunroof.

- ▶ When the convenience closing feature is operating, monitor the entire closing process and make sure that no body parts are in the closing area.

#### Requirements

- The SmartKey is in the immediate vicinity of the vehicle.

▶ Press and hold the  button on the SmartKey.

The following functions will be performed:

- The vehicle will be locked.
- The side windows will be closed.

- The panoramic sliding sunroof will be closed.

▶ **To interrupt convenience closing:** release the  button.

▶ **To continue convenience closing:** press and hold the  button again.

① Convenience closing also functions with KEY-LESS-GO (→ page 78).

### Resolving problems with the side windows

**⚠ WARNING** Risk of becoming trapped or fatally injured if reversing protection is not activated

If you close a side window again immediately after it has been blocked, the side window will close with increased or maximum force. The reversing function is then not active and body parts may become trapped.

▶ Make sure that no parts of the body are in the closing area.

▶ To stop the closing process, release the button or press the button again to reopen the side window.

**A side window cannot be closed and you cannot see the cause.**

- ▶ Check to see whether any objects are in the window guide.
- ▶ Adjust the side windows.

### Adjusting the side windows

If a side window is obstructed during closing and reopens again immediately:

- ▶ Immediately after this, pull and hold the corresponding button again until the side window has closed and hold the button for at least one more second (re-adjustment). The side window will be closed without the automatic reversing function.

If the side window is obstructed again and reopens again immediately:

- ▶ Immediately after this, pull and hold the corresponding button again until the side window

has closed and hold the button for at least one more second (follow-up adjustment). The side window will be closed without the automatic reversing function.

**The side windows cannot be opened or closed using the convenience opening feature.**

Possible causes are:

- The key battery is weak or discharged.

- ▶ Check the battery using the indicator lamp (→ page 71).
- ▶ Replace the key battery, if necessary (→ page 73).

### Sliding sunroof

#### Opening and closing the sliding sunroof

① The term "sliding sunroof" refers to the panorama roof with power tilt/sliding panel.

- ⚠ WARNING** Risk of becoming trapped when the sliding sunroof is being opened and closed

Body parts may become trapped in the range of movement.

- ▶ During the opening and closing process, make sure that no body parts are in the sweep of the sliding sunroof.
- ▶ If someone is trapped, release the control panel immediately.

or

- ▶ Touch the control panel during automatic operation.  
The opening/closing process will be stopped.

- ⚠ WARNING** Risk of becoming trapped if the sliding sunroof is operated by children

Children operating the sliding sunroof could get caught in the moving parts, particularly if unattended.

- ▶ Never leave children unattended in the vehicle.
- ▶ When leaving the vehicle, always take the key with you and lock the vehicle.

- ⚠ WARNING** Risk of becoming trapped when the roller sunblind is being opened and closed

Body parts may become trapped between the roller sunblind and frame or sliding roof.

- ▶ During the opening or closing process, make sure that no body parts are in the roller sunblind's range of movement.
- ▶ If someone is trapped, release the control panel immediately.

or

- ▶ Touch the control panel during automatic operation.  
The opening/closing process will be stopped.

- ! NOTE** Malfunction due to snow and ice

Snow and ice may cause the sliding sunroof to malfunction.

- ▶ Open the sliding sunroof only if it is free of snow and ice.

- ! NOTE** Damage caused by protruding objects

Objects that protrude from the sliding sunroof may damage the seals.

- ▶ Do not allow anything to protrude from the sliding sunroof.

- ! NOTE** Damage to panorama roof with power tilt/sliding panel caused by roof luggage rack

If the panorama roof with power tilt/sliding panel is opened when a roof luggage rack is installed, the panorama roof with power tilt/sliding panel may be damaged by the roof luggage rack.

- ▶ Do not open the panorama roof with power tilt/sliding panel if a roof luggage rack is installed.

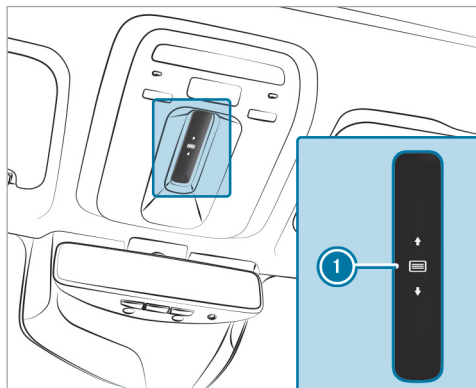

The sliding sunroof and the roller sunblind are operated using control panel ①.

The panorama roof with power tilt/sliding panel can be operated only when the roller sunblind is open.

- ▶ **To open:** swipe backwards across control panel ① and hold it.
- ▶ **To close:** swipe forwards across control panel ① and hold it.
- ▶ **To raise or lower:** press control panel ① briefly.
- ▶ **To start automatic operation:** swipe forwards or backwards across control panel ①.
- ▶ **To cancel automatic operation:** press control panel ① again.  
The opening/closing process will be stopped.

#### Automatic reversing function of the sliding sunroof

If an obstacle obstructs the sliding sunroof during the closing process, the sliding sunroof will open again automatically. The automatic reversing function is only an aid and is not a substitute for your attentiveness.

- ▶ During the closing process, make sure that no body parts are in the closing area.

#### ⚠ WARNING Risk of becoming trapped despite reversing function

The reversing function will not react:

- To soft, light and thin objects, e.g. fingers.
- Towards the end of the closing procedure.
- During resetting.

- ▶ During the closing process, make sure that no body parts are in the closing area.
- ▶ If someone is trapped, release the control panel immediately.

or

- ▶ Touch the control panel during automatic closing.  
The closing process will be stopped.

#### Automatic reversing function of the roller sunblind

If an obstacle obstructs the roller sunblind during the closing process, the roller sunblind will open again automatically. The automatic reversing function is only an aid and is not a substitute for your attentiveness.

- ▶ When closing the roller sunblind, make sure that no body parts are in the range of movement.

**⚠ WARNING** Risk of becoming trapped despite reversing function

In particular, the reversing function does not react to soft, light and thin objects, e.g. fingers.

- ▶ When closing the roller sunblind, make sure that no body parts are in the range of movement.
- ▶ If someone is trapped, release the control panel immediately.

or

- ▶ Touch the control panel during automatic closing.  
The closing process will be stopped.

### Automatic functions of the sliding sunroof

- ① The term "sliding sunroof" refers to the panorama roof with power tilt/sliding panel.

### Rain closing function when driving

**Vehicles with a panorama roof with power tilt/sliding panel:** if it starts to rain, the raised sliding sunroof will automatically be lowered while the vehicle is in motion.

### Automatic lowering function

**Vehicles with a panorama roof with power tilt/sliding panel:** if the sliding sunroof is raised at the rear, it will automatically be lowered slightly at higher speeds. At low speeds, it will be raised again automatically.

**⚠ WARNING** Risk of becoming trapped by automatic lowering of the sliding sunroof

At higher speeds, the raised sliding sunroof will automatically be lowered slightly at the rear.

- ▶ Make sure that nobody reaches into the sliding sunroof's range of movement while the vehicle is in motion.
- ▶ If someone becomes trapped, touch the control panel.

### Rectifying problems with the sliding sunroof

**⚠ WARNING** Risk of becoming trapped or fatal injuries when the sliding sunroof is closed again

If you close the sliding sunroof again immediately after it has been blocked or reset, the sliding sunroof will close with increased or maximum force.

There is a risk of becoming trapped or even of fatal injuries!

- ▶ Make sure that no parts of the body are in the closing area.
- ▶ If someone is trapped, release the control panel immediately.

or

- ▶ Touch the control panel during automatic closing.  
The closing process will be stopped.

**The sliding sunroof cannot be closed and you cannot see the cause.**

- ① The term "sliding sunroof" refers to the panorama roof with power tilt/sliding panel.

If the sliding sunroof is obstructed during closing and reopens again slightly:

- ▶ Immediately after automatic reversing, swipe forwards across the control panel (→ page 90) and hold it until the sliding sunroof is closed. The sliding sunroof will be closed with increased force.

If the sliding sunroof is obstructed again and opens again slightly:

- ▶ Repeat the previous step. The sliding sunroof will be closed again with increased force.

**The sliding sunroof or the roller sunblind is not operating smoothly.**

- ▶ Reset the sliding sunroof and the roller sunblind.

**Resetting the sliding sunroof and the roller sunblind**

- ▶ Swipe forwards across the control panel (→ page 90) and hold it repeatedly until the sliding sunroof is completely closed.

- ▶ Swipe across the control panel and hold it for another second.
- ▶ Swipe across and hold the control panel until the roller sunblind is fully closed.
- ▶ Swipe across the control panel and hold it for another second.
- ▶ Use automatic operation to fully open and then close the sliding sunroof.

### Anti-theft protection

#### Function of the immobilizer

The immobilizer prevents your vehicle from being started without the correct key.

This also applies to the Digital Vehicle Key.

The immobilizer is automatically activated when the vehicle is switched off, and deactivated when the vehicle is switched on.

When leaving the vehicle, always take the key with you and lock the vehicle. Anyone can start the vehicle if a valid key has been left inside the vehicle.

- ❗ In the event the engine cannot be started (yet the vehicle's battery is charged), the system is not operational. Contact an authorized Mercedes-Benz Center or call 1-800-FOR-MERCEDES (in the USA) or 1-800-387-0100 (in Canada).

### ATA (anti-theft alarm system)

#### Function of the ATA system

If the ATA system is armed, a visual and audible alarm is triggered in the following situations:

- When a door is opened
- When the tailgate is opened
- When the hood is opened
- When interior protection is triggered (→ page 96)
- When the tow-away alarm is triggered (→ page 95)

- ❗ **Vehicles with Digital Vehicle Key:** the ATA system works with the Digital Vehicle Key in the same way as with the conventional vehicle key.



The ATA system is armed automatically after approximately ten seconds in the following situations:

- After you lock the vehicle with the key
- After you lock the vehicle using KEYLESS-GO
- After you lock the vehicle with the NFC function (**vehicles with Digital Vehicle Key**)

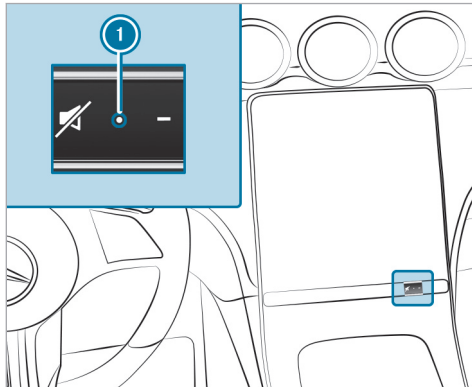

Indicator lamp ❶ flashes when the ATA system is armed.

The ATA system is deactivated automatically in the following situations:

- After you unlock the vehicle with the key
- After you unlock the vehicle using KEYLESS-GO
- After you unlock the vehicle with the NFC function (**vehicles with Digital Vehicle Key**)
- After you press the start/stop button with the key in the marked space (→ page 167)

#### Deactivating the ATA

▶ Press the ,  or  button on the key.

or

▶ Press the start/stop button with the key in the stowage compartment (→ page 167)

▶ **Vehicles with Digital Vehicle Key:** press the start/stop button with the Digital Vehicle Key in the marked space (→ page 167).

#### Deactivating the alarm using KEYLESS-GO

▶ Grasp the outside door handle with the key outside the vehicle.  
This also applies to the Digital Vehicle Key.

#### Function of the tow-away alarm

❶ This function may not be available in all countries.

An audible and visual alarm is triggered if an alteration to your vehicle's angle of inclination is detected while the tow-away alarm is armed.

The tow-away alarm is automatically armed after about 60 seconds:



- after you lock the vehicle with the key
- after you lock the vehicle using KEYLESS-GO  
This also applies to the Digital Vehicle Key.
- after you lock the vehicle with the NFC function (**vehicles with Digital Vehicle Key**)

The tow-away alarm is armed only when the following components are closed:

- Doors

- Tailgate

The tow-away alarm is automatically deactivated:

- after you press the  or  button on the key
- after you press the start/stop button with the key in the marked space (→ page 167)
- after you press the start-stop button with the Digital Vehicle Key in the marked space (**Vehicles with Digital Vehicle Key**) (→ page 167)
- after you unlock the vehicle using KEYLESS-GO

This also applies to the Digital Vehicle Key.

- after you unlock the vehicle with the NFC function (**vehicles with Digital Vehicle Key**)
- when you are using HANDS-FREE ACCESS

Information on collision detection when the vehicle is parked (→ page 219).

### Arming/deactivating tow-away alarm

Multimedia system:

- ▶  ▶ Settings ▶ Vehicle
- ▶▶ Opening/closing ▶▶ Vehicle Protection
- ▶▶ Arm or deactivate **Tow-away Protection**.

Tow-away alarm is armed again in the following cases:

- The vehicle is unlocked again.
- A door is opened.
- The vehicle is locked again.

### Function of interior protection

 This function may not be available in all countries.

When the interior motion sensor is activated, a visual and audible alarm is triggered if movement is detected in the vehicle interior.

Interior protection is armed automatically after approximately ten seconds:

- after you lock the vehicle with the key
- after you lock the vehicle using KEYLESS-GO



This also applies to the Digital Vehicle Key.

- after you lock the vehicle with the NFC function (**vehicles with Digital Vehicle Key**)

Interior protection is armed only when the following components are closed:

- Doors
- Tailgate

Interior protection is automatically deactivated:

- after you press the  or  button on the key
- after you press the start/stop button with the key in the marked space (→ page 167)
- after you press the start-stop button with the Digital Vehicle Key in the marked space (**Vehicles with Digital Vehicle Key**) (→ page 167)
- after you unlock the vehicle using KEYLESS-GO

This also applies to the Digital Vehicle Key.

- after you unlock the vehicle with the NFC function (**vehicles with Digital Vehicle Key**)
- when you are using HANDS-FREE ACCESS

The following situations can lead to a false alarm:

- When there are moving objects such as mascots in the vehicle interior
- If a side window is open
- If the panorama roof with power tilt/sliding panel is open

### Arming/deactivating interior protection

Multimedia system:

↳  » Settings » Vehicle  
» Opening/closing » Vehicle Protection

▶ Arm or deactivate [Interior Motion Sensor](#).

Interior protection is armed again in the following cases:

- The vehicle is unlocked again.
- A door is opened.
- The vehicle is locked again.

### Notes on the correct driver's seat position

**⚠ WARNING** Risk of accident due to adjusting the vehicle settings while the vehicle is in motion

You could lose control of the vehicle in the following situations in particular:

- If you adjust the driver's seat, the head restraint, the steering wheel or the mirror while the vehicle is in motion
- If you fasten your seat belt while the vehicle is in motion

► Before starting the vehicle: in particular, adjust the driver's seat, head restraint, steering wheel and mirror, and fasten your seat belt.

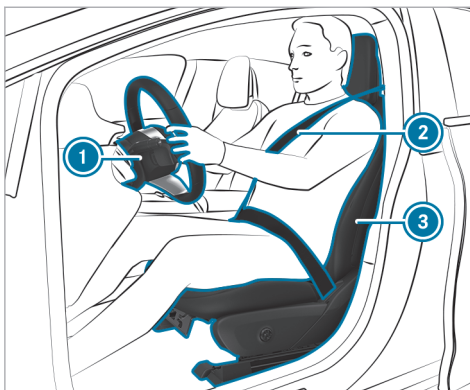

Ensure the following when adjusting steering wheel ①, seat belt ② and driver's seat ③:

- You are sitting as far away from the driver's air bag as possible, taking the following points into consideration:
- You are sitting in an upright position
- Your thighs are slightly supported by the seat cushion

- Your legs are not fully extended and you can depress the pedals properly
- The back of your head is supported at eye level by the center of the head restraint
- You can hold the steering wheel with your arms slightly bent
- You can move your legs freely
- You can see all the displays on the driver display clearly
- You have a good overview of the traffic conditions
- Observe the notes on correctly fastening the seat belt (→ page 41).

### Notes on grab handles

**⚠ WARNING** Risk of injury due to excessive load on the grab handles

If you apply your full body weight to the grab handle or pull it abruptly, the grab handle may be damaged or come loose from its anchorage. This may result in injuries.

- ▶ Use the grab handles only to stabilize the seating position or to assist in getting in and out of the seat.

## Seats

### Adjusting the front seat with manual and electric seat adjustment

- ⚠ WARNING** Risk of becoming trapped if the seats are adjusted by children

Children could become trapped if they adjust the seats, particularly when unattended.

- ▶ When leaving the vehicle, always take the SmartKey with you and lock the vehicle.
- ▶ Never leave children unattended in the vehicle.

You can adjust the seats when the vehicle is switched off.

- ⚠ WARNING** Risk of becoming trapped when adjusting the seat

When you adjust a seat, you or other vehicle occupants could become trapped, e.g. on the seat guide rail.

- ▶ When adjusting a seat, make sure that no one has any part of their body within the sweep of the seat.

Observe the safety notes on "Air bags" and "Children in the vehicle".

- ⚠ WARNING** Risk of accident due to the driver's seat not being engaged

The driver's seat may move unexpectedly while driving.

This could cause you to lose control of the vehicle.

- ▶ Always make sure that the driver's seat is engaged before starting the vehicle.

- ⚠ WARNING** Risk of accident due to adjusting the vehicle settings while the vehicle is in motion

You could lose control of the vehicle in the following situations in particular:

- If you adjust the driver's seat, the head restraint, the steering wheel or the mirror while the vehicle is in motion
- If you fasten your seat belt while the vehicle is in motion

- ▶ Before starting the vehicle: in particular, adjust the driver's seat, head restraint, steering wheel and mirror, and fasten your seat belt.

- ⚠ WARNING** Risk of becoming trapped if the seat height is adjusted carelessly

If you adjust the seat height carelessly, you or other vehicle occupants could be trapped and thereby injured.

Children in particular could accidentally press the electrical seat adjustment buttons and become trapped.

- ▶ While moving the seats, make sure that hands or other body parts do not get under the lever assembly of the seat adjustment system.

**⚠ WARNING** Risk of injury due to head restraints not being installed or being adjusted incorrectly

If head restraints have not been installed or have not been adjusted correctly, there is an increased risk of injury in the head and neck area, e.g. in the event of an accident or when braking.

- ▶ Always drive with the head restraints installed.
- ▶ Before driving off, make sure for every vehicle occupant that the center of the head restraint supports the back of the head at about eye level.

Adjust the head restraint fore-and-aft position so that it is as close as possible to the back of your head.

**⚠ WARNING** Risk of injury or death due to an incorrect seat position

The seat belt does not offer the intended level of protection if you have not moved the seat backrest to an almost vertical position.

In particular, you could slip beneath the seat-belt and become injured.

- ▶ Adjust the seat properly before beginning your journey.
- ▶ Always ensure that the seat backrest is in an almost vertical position and that the shoulder belt is routed across the center of your shoulder.

**⚠ WARNING** Risk of potentially fatal injuries due to objects trapped under the front passenger seat

Objects trapped under the front passenger seat may interfere with the function of the

automatic front passenger air bag shutoff or damage the system.

- ▶ Do not stow any objects under the front passenger seat.
- ▶ When the front passenger seat is occupied, ensure that no objects have become trapped beneath the front passenger seat.

**! NOTE** Damage to the seats when adjusting

The seats may be damaged by objects when adjusting the seats.

- ▶ When adjusting the seats, make sure that there are no objects in the footwell, under or behind the seats.

**! NOTE** Damage to the headliner when making adjustments

The headliner may be damaged when adjusting the front seats.

- ▶ Adjust the head restraints first before adjusting the height of the respective seat.

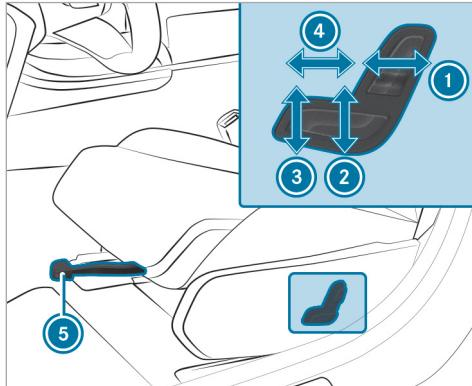

- ① Seat backrest inclination
- ② Seat height
- ③ Seat cushion inclination

- ④ Seat cushion length
- ⑤ Seat fore-and-aft position

- ▶ **To adjust the seat fore-and-aft position:** lift lever ⑤ and slide the seat into the desired position.
- ▶ Make sure that the seat is engaged.

#### Adjusting the front seat with fully electric seat adjustment

The switches for adjusting the seats do not move. You will therefore receive no direct feedback on the switch while pressing the switch. Feedback is provided only by the movement of the seat.

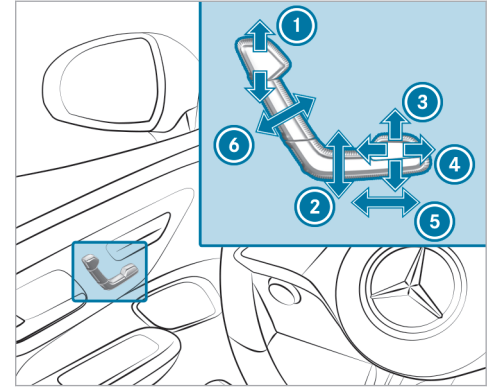

- ① Head restraint height
- ② Seat height
- ③ Seat cushion inclination
- ④ Seat cushion length
- ⑤ Seat fore-and-aft position
- ⑥ Seat backrest inclination

- ▶ Save the settings with the memory function (→ page 112).

- i The head restraint height will be adjusted automatically when you adjust the seat height or the seat fore-and-aft position.

### Adjusting the 4-way lumbar support

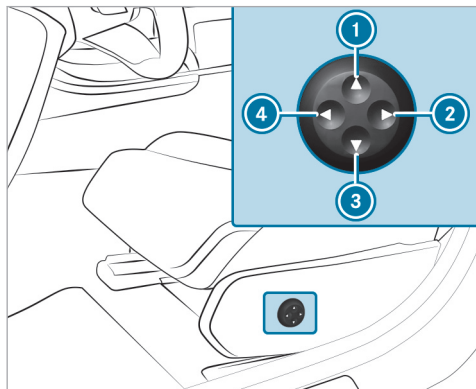

- 1 Higher
- 2 Softer

- 3 Lower
- 4 Firmer

▶ Use buttons 1 to 4 to adjust the contour of the backrest.

### Head restraints

#### Adjusting the head restraints on the front seats

**⚠ WARNING** Risk of accident due to adjusting the vehicle settings while the vehicle is in motion

You could lose control of the vehicle in the following situations in particular:

- If you adjust the driver's seat, the head restraint, the steering wheel or the mirror while the vehicle is in motion
  - If you fasten your seat belt while the vehicle is in motion
- ▶ Before starting the vehicle: in particular, adjust the driver's seat, head restraint,

steering wheel and mirror, and fasten your seat belt.

**⚠ WARNING** Risk of injury due to incorrectly adjusted head restraints

If head restraints have not been adjusted correctly, there is an increased risk of injury in the head and neck area, e.g. in the event of an accident or sudden braking.

▶ Before driving off, make sure for every vehicle occupant that the center of the head restraint supports the back of the head at about eye level.

Adjust the head restraint fore-and-aft position so that it is as close as possible to the back of your head.



## Seats with manual and electric seat adjustment

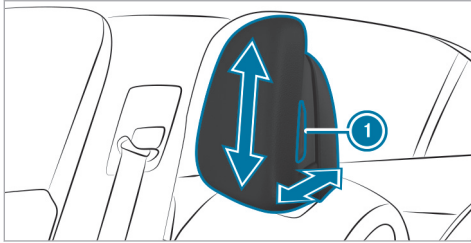

- ▶ Take hold of the head restraint on both sides and press release knob ①.
- ▶ **To move forwards or backwards:** pull the head restraint forwards or push it backwards.
- ▶ **To move upwards or downwards:** push the head restraint upwards or downwards.
- ▶ Let go of release knob ①.

## Seats with electric seat adjustment

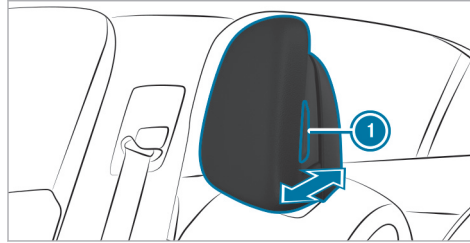

- ▶ Take hold of the head restraint on both sides and press release knob ①.
- ▶ **To move forwards or backwards:** pull the head restraint forwards or push it backwards.
- ▶ Let go of release knob ①.
- ▶ **To move upwards or downwards:** adjust the head restraint using the buttons on the door operating unit (→ page 101).

#### ■ Adjusting the head restraints of the rear seats manually

Move all head restraints up at least to the first detent.

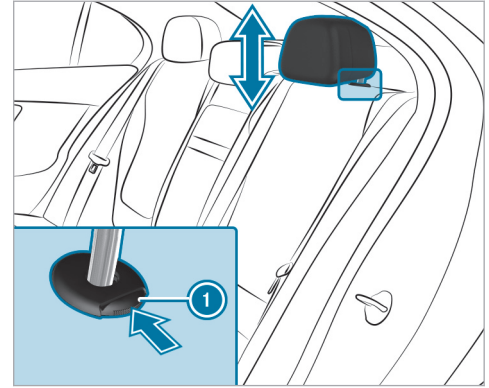

- ▶ **To raise:** push release knob ① in the direction of the arrow and pull the head restraint up until it engages.
- ▶ **To lower:** press release knob ① in the direction of the arrow and push the head restraint down until it engages.

## Installing/removing the rear seat head restraints

### Removing

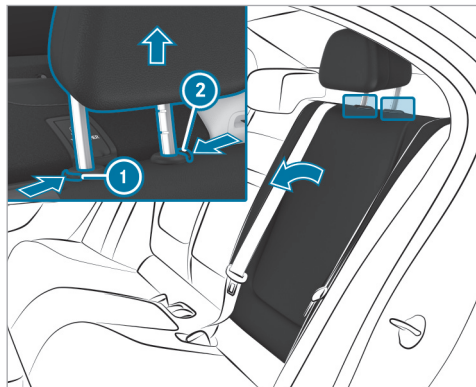

- ▶ Release the rear seat backrest and fold it forwards slightly (→ page 118).
- ▶ Press release knob ② and pull the head restraint upwards as far as it will go. Release knob ① will extend.

- ▶ Push both release knobs ① and ② at the same time in the direction of the arrow and pull out the head restraint.
- ▶ Fold the rear seat backrest back until it engages.

### Installing

- ▶ Release the rear seat backrest and fold it forwards slightly (→ page 118).
- ▶ Insert the head restraint such that the notches on the bar are on the left when viewed in the direction of travel.
- ▶ Push the head restraint down until it engages.
- ▶ Fold the rear seat backrest back until it engages.

## Configuring the seat settings

Multimedia system:

→ ▶ **Comfort** ▶ **Seat**

### Adjusting the air cushions

- ▶ In the corresponding menu, adjust the air cushions for **Lumbar** or **Side Bolsters**.

## Setting the seat heating balance

- ▶ Select **Heating Settings**.
- ▶ Select **Seat Heating Balance**.
- ▶ Adjust the heat distribution for the desired seat.

## Setting automatic seat adjustment

**⚠ WARNING** Risk of becoming trapped during adjustment of the driver's seat after calling up a driver profile

Selecting a user profile may trigger an adjustment of the driver's seat to the position saved under the user profile. You or other vehicle occupants could be injured in the process.

- ▶ Make sure that when the position of driver's seat is being adjusted using the multimedia system, no people or body parts are in the seat's range of movement.

If there is a risk of someone becoming trapped, immediately stop the adjustment process by:

- ▶ a) Pressing the warning message on the central display.
  - or
  - ▶ b) Pressing a position button of the memory function or a seat adjustment switch in the driver's door.
- The adjustment process is stopped.

Multimedia system:

↳  ▶▶ Comfort ▶▶ Seat  
▶▶ Automatic Seat Positioning

### Manually adjusting driver's seat and steering wheel position to body size

The vehicle calculates a suitable driver's seat and steering wheel position on the basis of the driver's body size and sets this directly.

- ▶ **To set the unit of measurement:** select **cm** or **ft/in**.
- ▶ Set the size using the scale.
- ▶ Select **Start Positioning**.  
The driver's seat and steering wheel position is adjusted to the body size that has been set.

- ⓘ You can also configure these settings via the Mercedes me user account for your user profile. By synchronizing the profiles in the vehicle and the Mercedes me connect profiles, you can carry over these settings for your vehicle. Further information about synchronizing user profiles .
- ⓘ If the driver's seat and steering wheel position calculated by the vehicle is not practical or comfortable, it can be manually adapted at any time via the control buttons. The outside mirrors are not set via this function. Instead, they have to be set manually via the operating switches.

### Overview of massage programs

- **Classic Massage:** Relaxing back massage
- **Mobilizing Massage** Mobilizing massage with upward-moving relaxing waves. Can promote slower, deeper respiration. This can improve the supply of oxygen to cells and the brain.
- **Activating Massage:** Activating massage with upward-moving relaxing waves

- **Relaxing Massage:** Relaxing back massage with increasing wave motions and then soothing movements
- **Deep Waves:** Wave-like movements in the cushion can promote blood flow and metabolic processes in the lower back and legs
- **Deep Workout:** Wave-like movements in the cushion are combined with wave movements from the backrest and can stimulate blood circulation and metabolism in the lower back, buttocks and legs
- ⓘ The **Deep Waves** and **Deep Workout** programs are only available on the driver's seat.

### Selecting the massage program for the front seats

Multimedia system:

↳  ▶▶ Comfort

- ▶ Select **Message**.
- ▶ Select a message program (→ page 105).
- ▶ Start the program for the desired seat .

▶ **To set the massage intensity:** switch **Intensive** on or off .

▶ **To stop the massage:** select .

① The availability of this function is dependent on the vehicle's equipment.

### Resetting seat settings

Multimedia system:

→  ▶▶ **Comfort** ▶▶ **Seat**

▶ Select **Reset**.

▶ Select  for the desired seat.

The settings for the selected seat are reset.

### Switching the seat heating on/off

**⚠ WARNING** Risk of burns due to repeatedly switching on the seat heating

Repeatedly switching on the seat heating can cause the seat cushion and seat backrest padding to become very hot.

In particular, the health of persons with limited temperature sensitivity or a limited ability to react to high temperatures may be affected or they may even suffer burn-like injuries.

▶ Do not repeatedly switch on the seat heating.

To protect against overheating, the seat heating may be temporarily deactivated after it has been switched on repeatedly.

**!** **NOTE** Damage to the seats caused by objects or documents when the seat heating is switched on

When the seat heating is switched on, overheating may occur due to objects or documents placed on the seats, e.g. seat cushions or child seats. This could cause damage to the seat surface.

▶ Make sure that no objects or documents are on the seats when the seat heating is switched on.

### Requirements

- The power supply is switched on.

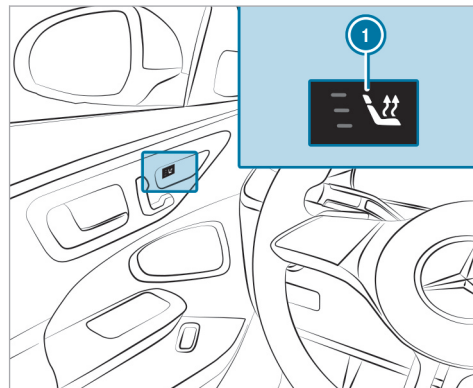

▶ Press button ① for the respective seat repeatedly until the desired heating level is reached. Depending on the heating level, up to three indicator lamps will light up. If all indicator lamps are off, the seat heating is switched off.

- ❶ The seat heating will automatically switch down from the three heating levels after around 8, 10 and 20 minutes until the seat heating is switched off.
- ❶ If you switch the power supply off and on again within 20 minutes, the previous setting of the seat heating for the driver's seat will remain active.

### Switching the seat ventilation on/off

#### Requirements

- The power supply is switched on.

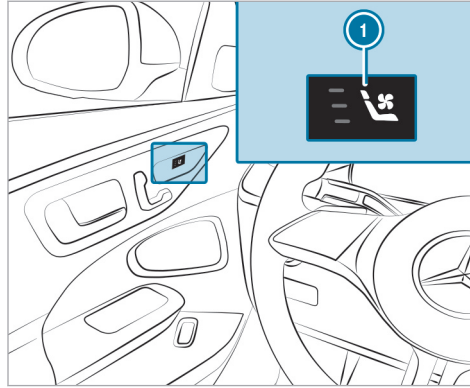

- ▶ Press button ❶ for the respective seat repeatedly until the desired blower setting is reached. Depending on the blower setting, up to three indicator lamps will light up. If all indicator lamps are off, the seat ventilation is switched off.

- ❶ If you switch the power supply off and on again within 20 minutes, the previous seat

ventilation setting for the driver's seat will remain active.

### Steering wheel

#### Adjusting the steering wheel manually

**⚠ WARNING** Risk of accident due to adjusting the vehicle settings while the vehicle is in motion

You could lose control of the vehicle in the following situations in particular:

- If you adjust the driver's seat, the head restraint, the steering wheel or the mirror while the vehicle is in motion
- If you fasten your seat belt while the vehicle is in motion
- ▶ Before starting the vehicle: in particular, adjust the driver's seat, head restraint, steering wheel and mirror, and fasten your seat belt.

**⚠ WARNING** Risk of entrapment for children when adjusting the steering wheel

Children could injure themselves if they adjust the steering wheel.

- ▶ Never leave children unattended in the vehicle.
- ▶ When leaving the vehicle, always take the key with you and lock the vehicle.

### Unlocking

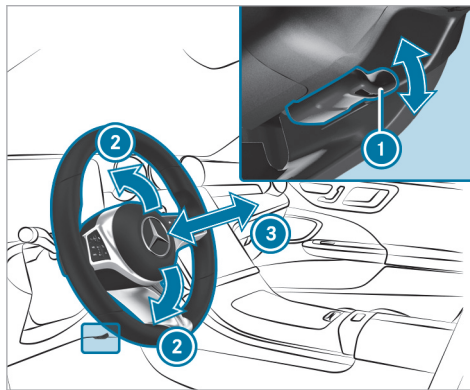

- ▶ Fold release lever ① down as far as it will go.
- ▶ Adjust height ② and distance ③ to the steering wheel.

### Locking

- ▶ Fold release lever ① up as far as it will go.

- ▶ Check and make sure that the steering column is locked by moving the steering wheel.

### Adjusting the steering wheel electrically

**⚠ WARNING** Risk of accident due to adjusting the vehicle settings while the vehicle is in motion

You could lose control of the vehicle in the following situations in particular:

- If you adjust the driver's seat, the head restraint, the steering wheel or the mirror while the vehicle is in motion
  - If you fasten your seat belt while the vehicle is in motion
- ▶ Before starting the vehicle: in particular, adjust the driver's seat, head restraint, steering wheel and mirror, and fasten your seat belt.

**⚠ WARNING** Risk of entrapment for children when adjusting the steering wheel

Children could injure themselves if they adjust the steering wheel.

- ▶ Never leave children unattended in the vehicle.
- ▶ When leaving the vehicle, always take the key with you and lock the vehicle.

This also applies to the Digital Vehicle Key. The steering wheel can be adjusted when the power supply is disconnected.

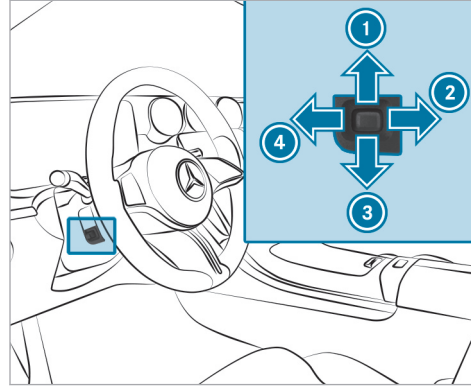

- ① To move up
  - ② To move back
  - ③ To move down
  - ④ To move forward
- ▶ Save the settings with the memory function (→ page 112).

### Decoupling the steering wheel heater from the seat heating

#### Requirements

- The power supply or the vehicle has been switched on.
- The steering wheel heater is linked to the seat heating.

Multimedia system:

→ ▶▶ Comfort ▶▶ Seat  
▶▶ Heating Settings

The function is active by default and the steering wheel heater is automatically activated and deactivated when the seat heating is switched on and off.

- ▶ Tap on **Additional Steering Wheel Heating**. The steering wheel heater will be decoupled from the seat heating.

When you switch the vehicle off, the steering wheel heater will switch off.

- ① The steering wheel heater can also be deactivated via the MBUX voice assistant.

### Easy entry and exit feature

#### Using the easy entry and exit feature

**⚠ WARNING** Risk of accident when pulling away during the adjustment process of the easy entry and exit feature

You could lose control of the vehicle.

- ▶ Always wait until the adjustment process is complete before driving off.

**⚠ WARNING** Risk of becoming trapped when adjusting the easy entry and exit feature

You and other vehicle occupants, particularly children, may become trapped.

- ▶ Make sure that no one has any part of their body within the range of movement of the steering wheel and driver's seat.

If there is a risk of becoming trapped by the steering wheel:

- ▶ Move the steering wheel adjustment lever.  
The adjustment process is stopped.

If there is a risk of becoming trapped by the driver's seat:

- ▶ Press the switch for seat adjustment.  
The adjustment process is stopped.
- ▶ Never leave children unattended in the vehicle.
- ▶ When leaving the vehicle, always take the key with you and lock the vehicle.

**Vehicles with memory function:** you can stop the adjustment process by pressing one of the memory function position switches.

**⚠ WARNING** Risk of becoming trapped if children activate the easy entry and exit feature

Children could become trapped if they activate the easy entry and exit feature, particularly when unattended.

- ▶ Never leave children unattended in the vehicle.
- ▶ When leaving the vehicle, always take the key with you and lock the vehicle.

In order to use the easy entry and exit feature, the automatic seat adjustment function must have been switched on (→ page 104).

When the easy entry and exit feature is active, the steering wheel and driver's seat will move as follows:

- The steering wheel will move upwards.
- The driver's seat will move forward or backward to an ideal position for entering or exiting the vehicle.

This will occur in the following situations:

- You switch off the vehicle when the driver's door is open.
- You open the driver's door when the vehicle is switched off.



- ① The steering wheel will then move upwards only if it is not already as high as it will go. The driver's seat only moves forwards or backwards if it is not already in an ideal position for entering or exiting the vehicle.

The steering wheel and the driver's seat will move back to the last driving position in the following cases:

- You switch the power supply or the vehicle on when the driver's door is closed.
- You close the driver's door when the vehicle is switched on.

The last drive position will be saved when:

- You switch off the vehicle.
- **Vehicles with memory function:** you call up the seat settings via the memory function.
- **Vehicles with memory function:** you save the seat settings via the memory function.

**Vehicles with memory function:** press one of the memory function position switches to stop the adjustment process.

### Setting the easy entry and exit feature

#### Requirements:

- Automatic seat adjustment is activated (→ page 104).

Multimedia system:

- ➔  ➔ Settings ➔ Vehicle ➔ Comfort ➔ Easy Entry And Exit Feature
- ▶ Select **Steering Wheel & Seat, Steering Wheel Only** or **Off**.

- ① If you are using an individual user profile, this information is used for the easy entry and exit feature. This will cause the driver's seat and steering wheel to move into the correct position automatically.

### Memory function

#### Function of the memory function

**⚠ WARNING** Risk of an accident if the memory function is used while driving

If you use the memory function on the driver's side while driving, you could lose control of the vehicle as a result of the adjustments being made.

- ▶ Only use the memory function on the driver's side when the vehicle is stationary.

**⚠ WARNING** Risk of entrapment when adjusting the seat with the memory function

When the memory function adjusts the seat, you and other vehicle occupants – particularly children – could become trapped.

- ▶ During the adjusting process of the memory function, ensure that no body

parts are in the area of movement of the seat or the steering wheel.

- ▶ If someone becomes trapped, press a preset position button or seat adjustment switch immediately. The adjustment process is stopped.

**⚠ WARNING** Danger of entrapment when memory function is activated by children

When children activate the memory function, they can get trapped, especially if they are unsupervised.

- ▶ Never leave children unattended in the vehicle.
- ▶ When leaving the vehicle, always take the key with you and lock the vehicle.

You can use the memory function when the vehicle is switched off.

Seat adjustments for up to three people can be stored and called up using the memory function.

You can save the following settings for the front seat:

- Seat, backrest, head restraint position and contour of the seat backrest in the lumbar region
- Seat heating: distribution of the heated sections of the seat cushion and seat backrest
- Driver's side: steering wheel position and position of the outside mirrors on the driver's and front passenger sides

## Operating the memory function

### Storing

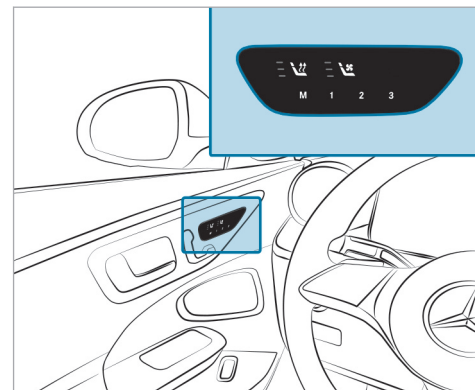

- ▶ Set the front seat, the steering wheel, the head-up display and the outside mirror to the desired position.
- ▶ Press the **M** button and then release it.

- ▶ Press one of the preset position buttons **1**, **2** or **3** within three seconds. An acoustic signal will sound. The settings are stored.
- ▶ **To call up:** press the preset position button **1**, **2** or **3**. The seat will be moved to the stored position. After releasing the button, the front seat, outside mirror, head-up display and steering column will continue to move into the stored position automatically.

### Stowage areas

#### Notes on loading the vehicle

#### **⚠ DANGER** Risk of exhaust gas poisoning

Combustion engines emit poisonous exhaust gases such as carbon monoxide. Exhaust gases can enter the vehicle interior if the tailgate is open when the engine is running, especially if the vehicle is in motion.

- ▶ Always switch off the engine before opening the tailgate.

- ▶ Never drive with the tailgate open.

Objects in the deployment area of an air bag may prevent the air bag from functioning correctly. Observe the notes on air bags (→ page 55).

#### **⚠ WARNING** Risk of injury from unsecured items in the vehicle

If objects, luggage or loads are not secured or not secured sufficiently, they could slip, tip over or be thrown around and thereby hit vehicle occupants.

There is a risk of injury, particularly in the event of sudden braking or a sudden change in direction.

- ▶ Always stow objects in such a way that they cannot be thrown around.
- ▶ Before the journey, secure objects, luggage or loads against slipping or tipping over.

#### **⚠ WARNING** Risk of injury due to objects being stowed incorrectly

If objects in the vehicle interior are stowed incorrectly, they can slide or be thrown around and hit vehicle occupants. In addition, cup holders, open storage spaces and mobile phone receptacles cannot always retain all objects within.

There is a risk of injury, particularly in the event of sudden braking or abrupt changes in direction.

- ▶ Always store objects such that they cannot be thrown around in such situations.
- ▶ Always make sure that objects do not protrude from storage spaces, parcel nets or storage nets.
- ▶ Close the lockable storage spaces before starting a journey.
- ▶ Stow and secure objects that are heavy, hard, pointed, sharp-edged, fragile or too large in the cargo compartment.

**⚠ WARNING** Risk of accident from objects in the driver's footwell and front-passenger footwell

Objects in the driver's footwell and front-passenger footwell may impede pedal travel or block a depressed pedal.

This jeopardizes the operating and road safety of the vehicle.

- ▶ Stow all objects in the vehicle securely so that they cannot get into the driver's footwell or front-passenger footwell.
- ▶ Always install the floor mats securely and as prescribed in order to ensure that there is always sufficient clearance for the pedals.
- ▶ Do not use loose floor mats and do not lay multiple floor mats on top of one another.

**Vehicles with automatic front-passenger air bag shutoff:** objects trapped under the front-passenger seat may interfere with the function of the automatic front-passenger air bag shutoff or damage the system. Please observe the notes on

the function of automatic front-passenger air bag shutoff (→ page 45).

**⚠ WARNING** - Risk of accident or injury when using the cup holder while the vehicle is moving

The cup holder cannot secure containers while the vehicle is moving.

If you use a cup holder while the vehicle is moving, the container may be flung around and liquids may be spilled. The vehicle occupants may come into contact with the liquid and if it is hot, they could be scalded. You could be distracted from traffic conditions and you may lose control of the vehicle.

- ▶ Only use the cup holder when the vehicle is stationary.
- ▶ Only use the cup holder for containers of the right size.
- ▶ Close the container, particularly if the liquid is hot.

**! NOTE** Damage to the cup holder

The cup holder can be damaged when folding back the rear armrest. When open, the cup holder can be damaged by body weight.

- ▶ The rear armrest can only be folded back when the cup holder is closed.
- ▶ Do not sit or support yourself on the cup holder when it is open.

**⚠ WARNING** Risk of injury due to an open cargo compartment floor

If you drive with the cargo compartment floor open, objects could be flung around and hit vehicle occupants as a result. There is a risk of injury, particularly in the event of sudden braking or a sudden change in direction.

- ▶ Always close the cargo compartment floor before a journey.

**⚠ WARNING** Risk of burns from the tailpipe and tailpipe trims

The exhaust tailpipe and tailpipe trims can become very hot. If you come into contact with these parts of the vehicle, you could burn yourself.

- ▶ Always be particularly careful around the tailpipe and the tailpipe trims and supervise children especially closely in this area.
- ▶ Allow vehicle parts to cool down before touching them.

**! NOTE** Damage to the cargo floor caused by an unevenly distributed load or an abrupt application of load

The cargo floor may be damaged by an unevenly distributed load or an abrupt application of load .

- ▶ Distribute the load evenly.

- ▶ Drive carefully when the vehicle is fully laden. Avoid abrupt starts, braking and steering as well as rapid cornering.

- ⓘ Leather is a natural product. It exhibits natural surface properties, such as differences in structure, marks caused by growth and injury or subtle color differences. These surface properties are characteristics of leather and not material defects. Leather is also subject to a natural aging process during which the surface properties change.

The driving characteristics of your vehicle are dependent on the distribution of the load within the vehicle. You should bear the following in mind when loading the vehicle:

- Never exceed the gross vehicle weight rating or the gross axle weight rating for the vehicle (with the load and including occupants). The values are specified on the vehicle identification plate on the vehicle's B-pillar.
- The load must not protrude above the upper edge of the seat backrests.

- Always use the partitioning net when transporting objects in the cargo compartment.
- Always place the load behind unoccupied seats if possible.
- Secure the load using the cargo tie down rings and distribute the load evenly.

Notes on driving with a roof load

- Distribute the roof load and the load inside the vehicle evenly, placing heavy objects at the bottom. Also comply with the notes on loading the vehicle.
- Drive attentively and avoid abrupt starts, braking and steering as well as rapid cornering.
- When transporting roof loads and when the vehicle is fully loaded or fully occupied, select drive program **E** or **C**. These are specially designed to ensure stability (→ page 185).
- ⓘ For more information on storage compartments and stowage areas, please refer to the Digital Operator's Manual.

## Stowage spaces in the vehicle interior

### ■ Overview of the front storage compartments

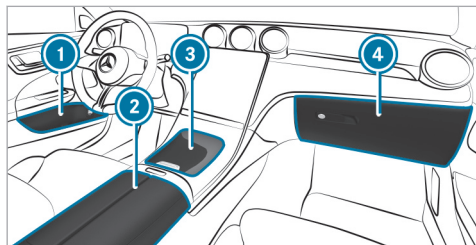

- ① Stowage spaces in the doors
- ② Storage compartment under the armrest with multimedia and USB ports
- ③ Storage compartment in the front center console with cup holders, USB ports and charging module for wireless charging of mobile phones
- ④ Glove box

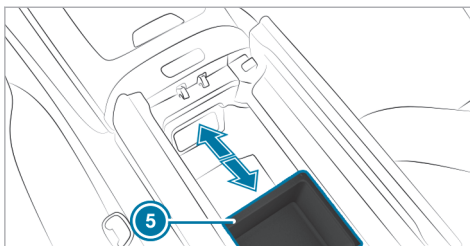

Under armrest ② there is also a sliding storage compartment ⑤, which can be used in the front or rear position. Push the compartment to the desired position until it engages.

For cleaning, the storage compartment can be moved to the middle position and removed. The rubber mat in the storage compartment can be removed for cleaning.

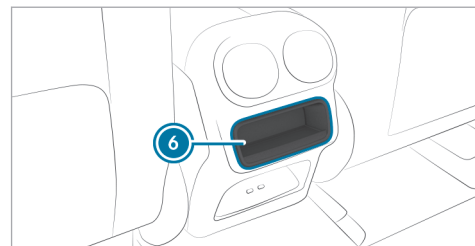

Depending on the vehicle version, there is a storage compartment in the rear center console ⑥. The rubber mat in the storage compartment can be removed for cleaning.

### ■ Opening and closing the storage compartment in the front center console

**▲ WARNING** Risk of injury due to objects being stowed incorrectly

If objects in the vehicle interior are stowed incorrectly, they can slide or be thrown around and hit vehicle occupants. In addition, cup holders, open storage spaces and mobile

phone brackets cannot always retain all objects they contain.

There is a risk of injury, particularly in the event of sudden braking or a sudden change in direction.

- ▶ Always stow objects in such a way that they cannot be thrown around in such situations.
- ▶ Always make sure that objects do not protrude from storage spaces, parcel nets or storage nets.
- ▶ Close the lockable storage spaces before starting a journey.
- ▶ Always stow and secure heavy, hard, pointed, sharp-edged, fragile or bulky objects in the trunk.

Observe the notes on loading the vehicle.

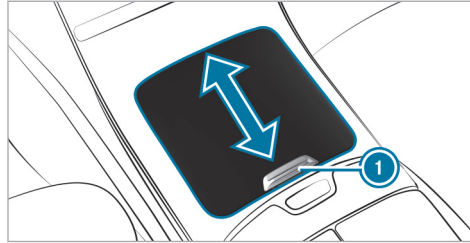

- ▶ **To open:** slide the cover of the storage compartment in the front center console all the way forwards in the direction of the arrow using handle ①.
- ▶ **To close:** briefly push handle ① of the open cover of the storage compartment in the front center console forwards. The cover will automatically close the storage compartment in the front center console.

### Locking/unlocking the glove box

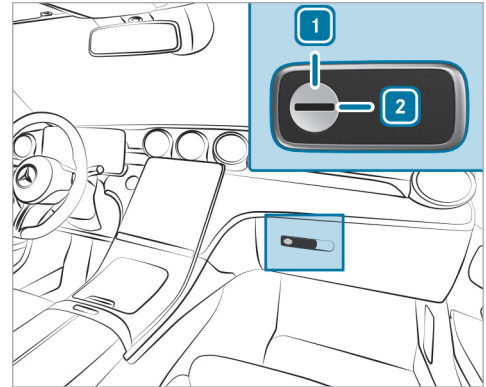

- ▶ Turn the emergency key a quarter turn clockwise ② (to lock) or counter-clockwise ① (to unlock).

### Through-loading feature in the rear bench seat (EASY-PACK Quickfold)

#### Folding the rear seat backrests forward

**⚠ WARNING** Risk of becoming trapped when adjusting the seats

When you adjust a seat, you may trap yourself or a vehicle occupant.

- ▶ When adjusting a seat, make sure that no one has any body parts in the sweep of the seat.

**⚠ WARNING** Risk of an accident because the seat backrest is not engaged

The seat backrest may fold forwards.

There is a risk of the following, in particular:

- The vehicle occupant may be pressed against the seat belt. The seat belt cannot protect as intended and could cause additional injury.

- A child restraint system is no longer properly supported or properly positioned and may no longer fulfill its function as intended.
- The seat backrest cannot restrain objects or goods in the trunk or cargo compartment.

Always ensure that the seat backrest is engaged, especially:

- After the seat has been adjusted.
- After the cargo compartment enlargement has been folded forwards

Prior to use, make sure that the red marking of the lock verification indicator is no longer visible. Otherwise, the seat backrest is not locked.

Always ensure that all vehicle occupants have their seat belts fastened correctly and are sitting properly. Particular attention must be paid to children.

#### Requirements

- The rear seat backrest head restraints are fully inserted.

- The rear armrest has been folded up.

If you no longer require the folded-down rear seat backrest as a load area, fold the backrest back into place.

- ▶ Ensure that the center seat backrest is in an upright position and locked to the left seat backrest (→ page 120).

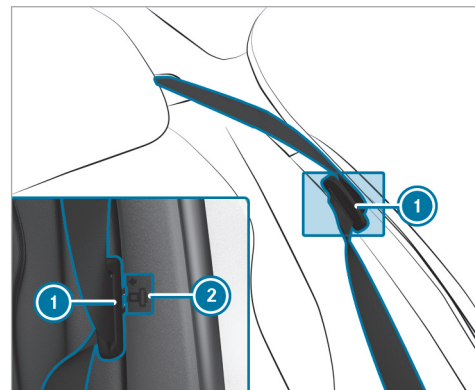



- ▶ Press the seat belt tongue of seat belt ① into marked position ②.

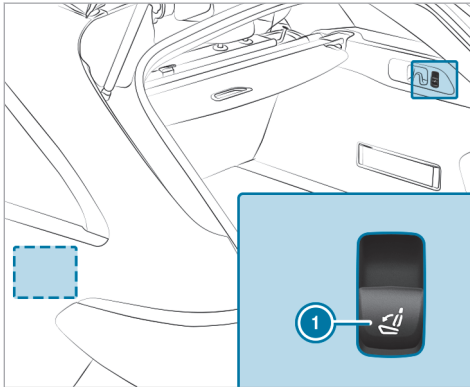

- ▶ **To fold the left seat backrest forward:** briefly pull left button ①. The left and center seat backrests fold forwards.

If the left seat backrest is not locked with the center seat backrest, this will be shown on the driver display.

- ▶ **To fold the right seat backrest forward:** briefly pull right button ①. The right seat backrest will fold forwards.

#### Folding the rear seat backrest back

**!** **NOTE** Damage caused by trapping the seat belt when folding back the seat backrest

The seat belt could become trapped and thus damaged when the seat backrest is folded back.

- ▶ Make sure that the seat belt is not trapped when folding back the seat backrest.

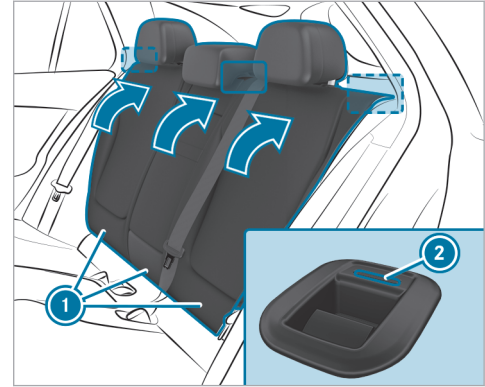

- ▶ Move the driver's or front passenger seat forwards, if necessary.
- ▶ Swivel seat backrest ① back until it engages. If the seat backrest is not engaged and locked in place, red lock verification indicator ② will be visible.

### Locking the release catch of the center rear seat backrest

#### Requirements:

- The left and center seat backrests are engaged and joined together.

You can lock the center seat backrest release catch if you want to secure the cargo compartment against unauthorized access. The center seat backrest can then be folded forwards only together with the left seat backrest.

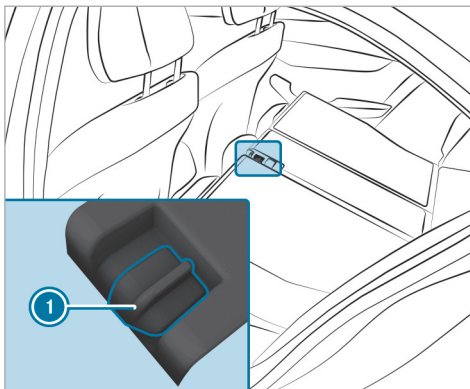

- ▶ Fold the center and left seat backrests forwards.
- ▶ **To lock or unlock:** slide catch ① upwards or downwards.

### Cargo compartment cover

#### Extending/retracting the cargo compartment cover

**⚠ WARNING** Risk of injury or death due to poorly secured objects

The cargo compartment cover alone cannot secure or restrain heavy objects, items of luggage or heavy loads.

You could be hit by an unsecured load, particularly in the event of abrupt changes in direction, sudden braking or an accident.

- ▶ Always stow objects in such a way that they cannot be thrown around.
- ▶ Secure objects, luggage or loads against slipping or tipping over, e.g. by using tie downs, even if you are using the cargo compartment cover.

**! NOTE** Damage to the cargo compartment cover when loading the vehicle

The cargo compartment cover may be damaged when the vehicle is being loaded.

- ▶ Do not place any objects above the lower edge of the side windows or on the cargo compartment cover.

The cargo compartment cover is attached behind the seat backrest of the rear bench seat.

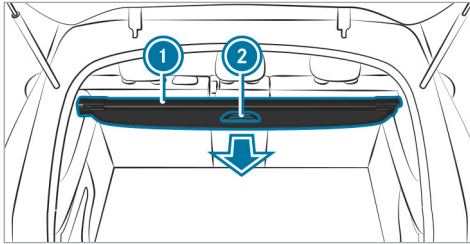

- ▶ **To extend:** pull cargo compartment cover ① back by grab handle ② and hook it into the holders on the left and right.
- ▶ **To retract:** unhook cargo compartment cover ① from the holders on the left and right and guide it forwards by grab handle ② until it is fully retracted.

### Installing and removing the cargo compartment cover

#### Requirements

- The cargo compartment cover is retracted.

#### Removing the cargo compartment cover

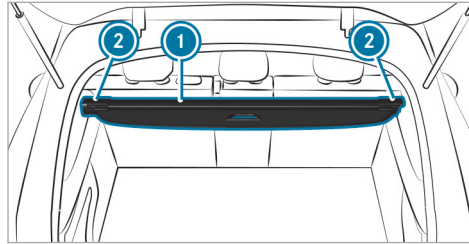

- ▶ Press in the end cap of cargo compartment cover ① on the right- or left-hand side.
- ▶ Push cargo compartment cover ① into recess ② on the opposite side.
- ▶ Take cargo compartment cover ① out by pulling it upwards.

#### Installing the cargo compartment cover

- ▶ Press in the end cap of cargo compartment cover ① on the opposite side and insert cargo compartment cover ① into other recess ②.
- ▶ Slide the end cap outwards.

#### Stowing the cargo compartment cover

Depending on the vehicle version, the cargo compartment cover can be stowed under the cargo floor.

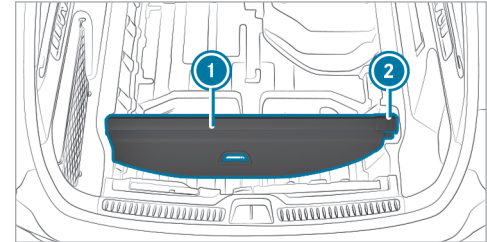

- ▶ **To insert:** position cargo compartment cover ① to the left under the trim and engage it in mounting ②.

- ▶ **To remove:** press the end cap of the cargo compartment cover inward and remove it from mounting ②.

### Attaching/removing the partitioning net

**⚠ WARNING** Risk of injury or death due to poorly secured objects

The partitioning net alone cannot secure or restrain heavy objects, items of luggage or heavy loads.

You could be hit by an unsecured load, particularly in the event of abrupt changes in direction, sudden braking or an accident.

- ▶ Always stow objects in such a way that they cannot be thrown around.
- ▶ Secure objects, luggage or loads against slipping or tipping over, e.g. by using tie downs, even if you are using the partitioning net.

For safety reasons, always use a partitioning net when transporting a load.

Damaged partitioning nets can no longer fulfill their functions and must be replaced. Visit a qualified specialist workshop.

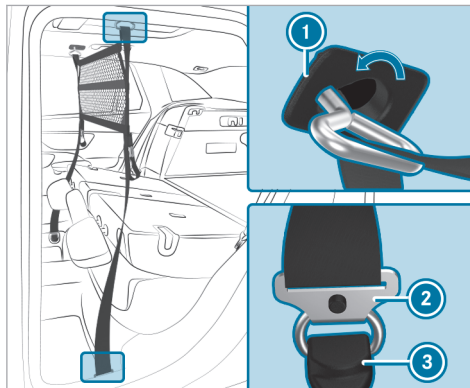

Partitioning net in the front position

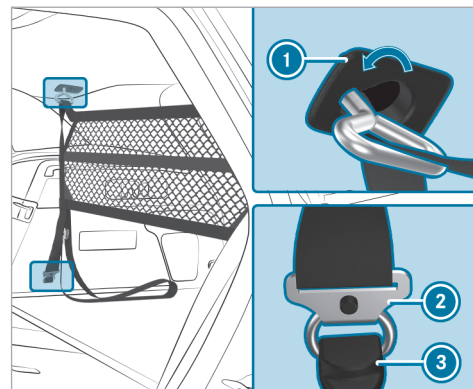

Partitioning net in the rear position

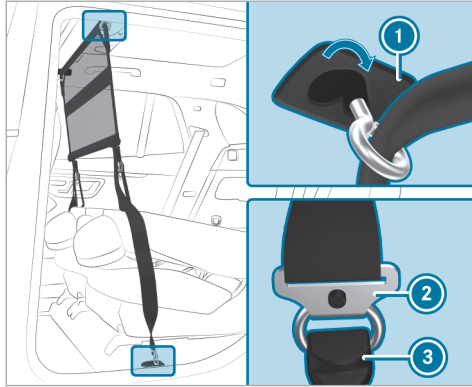

Partitioning net in the front position

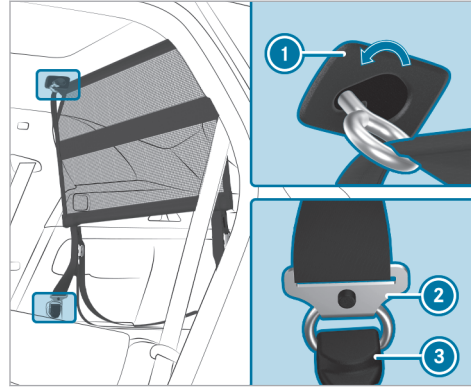

Partitioning net in the rear position

- ▶ **To attach:** extend and unfold the partitioning net.
- ▶ Attach the upper hooks of the partitioning net to holders ① on the headliner.
- ▶ Attach lower hooks ② in eyelets ③ on the left and right.

- ▶ Pull on the loose ends of the lashing straps until the partitioning net is tight.
- ▶ After driving a short distance, check the tension of the partitioning net and re-tension it if necessary.
- ▶ **To remove:** pull the belt clamps until the lashing straps are loose.
- ▶ Remove lower hooks ② from eyelets ③ on the left and right.
- ▶ Detach upper hooks from holders ①.

#### Overview of the tie-down eyes

Observe the notes on loading the vehicle (→ page 113).

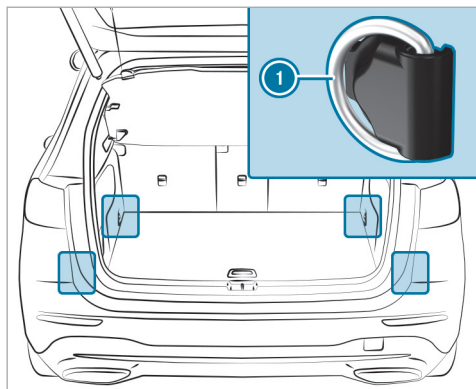

① Tie-down eyes

### Overview of bag hooks

**⚠ WARNING** Risk of injury when using bag hooks with heavy objects

The bag hooks cannot restrain heavy objects or items of luggage.

Objects or items of luggage may be flung around and hit vehicle occupants.

- ▶ Only hang light objects on the bag hooks.
- ▶ Never hang hard, sharp-edged or fragile objects on the bag hooks.

Observe the notes on loading the vehicle (→ page 113).

The bag hook can bear a maximum load of 6.6 lbs (3 kg). Do not use it to secure a load.

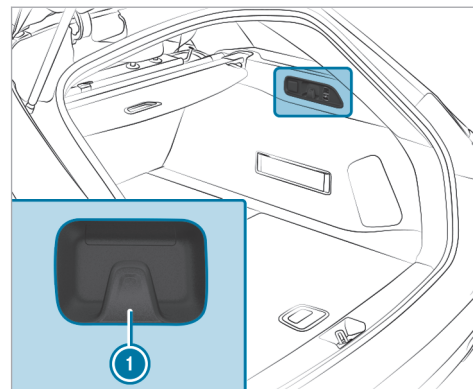

① Bag hook

### Attaching a roof luggage rack

**⚠ WARNING** Risk of accident due to exceeding the maximum roof load

The vehicle center of gravity and the usual driving characteristics as well as the steering and braking characteristics alter.

If you exceed the maximum roof load, the driving characteristics, as well as steering and braking, will be greatly impaired.

- ▶ Never exceed the maximum roof load and adjust your driving style.

You will find information on the maximum roof load in the "Technical data" section.

**! NOTE** Vehicle damage due to failure to observe the maximum permissible clearance height

If the vehicle height exceeds the maximum permissible clearance height, the roof and other vehicle parts may be damaged.

- ▶ Please observe the maximum clearance height indicated.
- ▶ If the vehicle exceeds the permissible clearance height, do not drive in.
- ▶ Take the modified vehicle height into account in the case of roof superstructures or other carrier systems.

**! NOTE** Damage to the panorama roof with power tilt/sliding panel due to non-approved roof luggage racks

The panorama roof with power tilt/sliding panel may be damaged by the roof luggage rack if you attempt to open it when using a roof luggage rack not tested and approved for Mercedes-Benz.

- ▶ When a roof luggage rack is installed, open the panorama roof with power tilt/sliding panel only if this has been tested and approved for Mercedes-Benz.

The panorama roof with power tilt/sliding panel may be raised to allow ventilation of the vehicle interior.

- ▶ Secure the roof luggage rack to the roof railing.
- ▶ Observe the manufacturer's installation instructions.

### Cup holder

#### Installing or removing the cup holder in the center console

**⚠ WARNING** - Risk of accident or injury when using the cup holder while the vehicle is moving

The cup holder cannot secure containers while the vehicle is moving.

If you use a cup holder while the vehicle is moving, the container may be flung around and liquids may be spilled. The vehicle occupants may come into contact with the liquid and if it is hot, they could be scalded. You could be distracted from traffic conditions and you may lose control of the vehicle.

- ▶ Only use the cup holder when the vehicle is stationary.
- ▶ Only use the cup holder for containers of the right size.
- ▶ Close the container, particularly if the liquid is hot.

**⚠ WARNING** Risk of injury due to objects being stowed incorrectly

If objects in the vehicle interior are stowed incorrectly, they can slide or be thrown around and hit vehicle occupants. In addition, cup holders, open storage spaces and mobile phone brackets cannot always retain all objects they contain.

There is a risk of injury, particularly in the event of sudden braking or a sudden change in direction.

- ▶ Always stow objects in such a way that they cannot be thrown around in such situations.

- ▶ Always make sure that objects do not protrude from storage spaces, parcel nets or storage nets.
- ▶ Close the lockable storage spaces before starting a journey.
- ▶ Always stow and secure heavy, hard, pointed, sharp-edged, fragile or bulky objects in the trunk.

Observe the notes on loading the vehicle (→ page 113).

### Installing

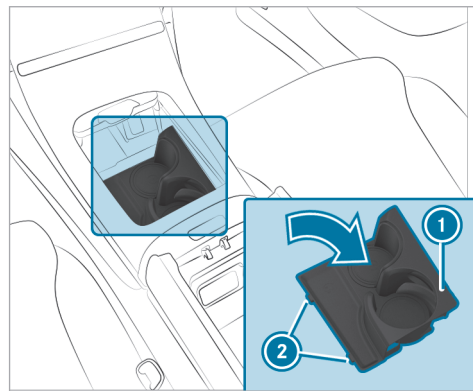

- ▶ Insert two lugs ② into the recesses in the trim and swing cup holder ① into the compartment until it engages.

### Removing

The cup holder can be removed for cleaning.



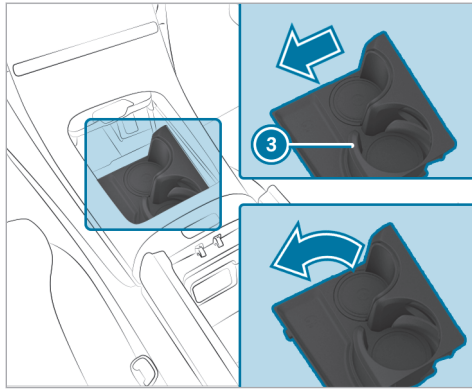

- ▶ Push the side wall of rear beverage compartment ③ to the left until the cup holder releases and swing the cup holder out upwards.

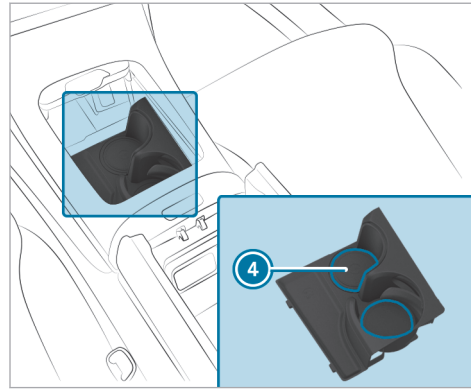

- ▶ Insert mats ④ in the cup holder beverage compartments can be removed for cleaning.
- ▶ To do so, use a suitable tool to push the insert mats out of their mounting from the rear of the removed cup holder.
- ▶ Reinsert the cup holder after cleaning.

### Using the cup holder

- ⓘ Check whether the beverage container is held firmly by the cup holder. Some beverage containers will not be secured adequately in the cup holder due to their shape or size.

The side wall of the front beverage compartment can be retracted and extended manually.

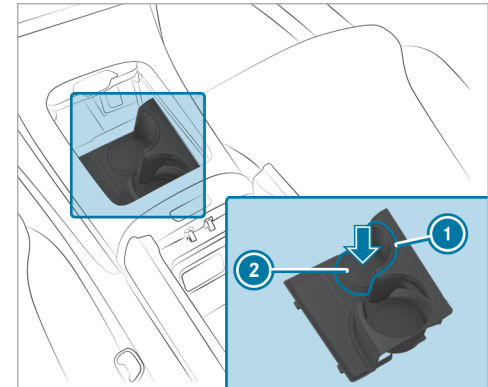

- ▶ Gently push a beverage container into the bottom ② of the beverage compartment. The side panel will automatically extend to the left to secure the beverage container.

Alternatively, you can extend the side wall of the beverage compartment by pressing lightly on grooved surface ①.

#### Retracting the side wall

When the front beverage compartment is not in use, the side panel can be retracted manually. The cup holder's holding function will then no longer be available.

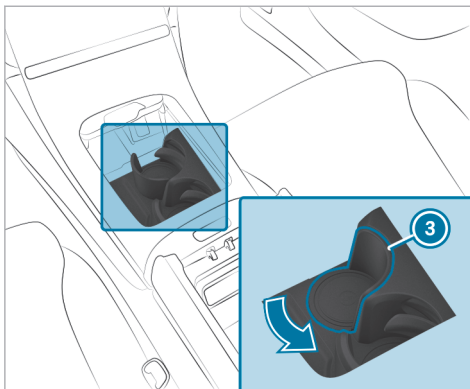

- ▶ Push the side panel back in the direction of the arrow until it engages in correct position ③.

#### Sockets

##### Using the 12 V socket

#### Requirements

- Connect only devices up to a maximum of 180 W (15 A).

Depending on the vehicle equipment, the vehicle has the following 12 V sockets:

- In the front passenger footwell
- In the cargo compartment

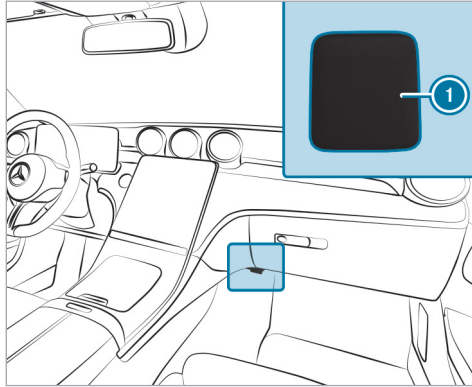

Example: 12 V socket in the front passenger footwell

- ▶ Fold up the cap of socket ①.
- ▶ Insert the plug of the device.

### USB ports

Depending on its equipment, the vehicle has the following USB ports:

- In the storage compartment in the front center console
- In the storage compartment under the front armrest
- In the rear passenger compartment center console

Depending on the vehicle equipment, the vehicle has either one or two USB ports in the storage compartment in the front center console and beneath the front armrest.

Depending on the vehicle equipment, the vehicle has two USB ports in the rear passenger compartment center console.

You can charge a USB device, such as a mobile phone, at the USB ports using a suitable charging cable. Depending on the vehicle equipment, devices can be charged with up to 20 V (5 A) when the vehicle is switched on.

### Wireless charging of the mobile phone and connection with the exterior antenna

#### Notes on wirelessly charging a mobile phone

**⚠ WARNING** Risk of injury due to objects being stowed incorrectly

If objects in the vehicle interior are stowed incorrectly, they can slide or be thrown around and hit vehicle occupants. In addition, cup holders, open stowage spaces and mobile phone receptacles cannot always retain all objects within.

There is a risk of injury, particularly in the event of sudden braking or a sudden change in direction.

- ▶ Always stow objects so that they cannot be thrown around in such situations.
- ▶ Always make sure that objects do not protrude from stowage spaces, parcel nets or stowage nets.
- ▶ Close the lockable stowage spaces before starting a journey.

- ▶ Always stow and secure heavy, hard, pointed, sharp-edged, fragile or bulky objects in the trunk/cargo compartment.

Observe the notes on loading the vehicle.

**⚠ WARNING** Risk of fire from placing objects in the mobile phone storage compartment

Placing other objects in the mobile phone storage compartment could constitute a fire hazard.

- ▶ Apart from a mobile phone, do not place any other objects in the mobile phone storage compartment, especially those made of metal.

**⚠ NOTE** Damage to objects caused by placing them in the mobile phone storage compartment

If objects are placed in the mobile phone storage compartment, these may be damaged by electromagnetic fields.

- ▶ Do not place credit cards, storage media, ski passes or other objects sensitive to electromagnetic fields in the mobile phone storage compartment.

**⚠ NOTE** Damage to the mobile phone storage compartment caused by liquids

If liquids enter the mobile phone storage compartment, the compartment may be damaged.

- ▶ Ensure that no liquids enter the mobile phone storage compartment.

Always observe the notes for persons with electronic medical aids (→ page 31).

- Depending on the vehicle equipment, the mobile phone is connected to the vehicle's exterior antenna via the charging module.
- The charging function and wireless connection of the mobile phone to the vehicle's exterior antenna are available only if the vehicle is switched on.

- Small mobile phones may not be able to be charged in every position of the mobile phone stowage compartment.
- Large mobile phones that do not rest flat in the mobile phone stowage compartment may not be able to be charged or connected with the vehicle's exterior antenna.
- The mobile phone may heat up during the charging process. This may also depend on the applications (apps) currently open in the background.
- To ensure more efficient charging and connection with the vehicle's exterior antenna, remove the protective cover from the mobile phone. Protective covers that are necessary for wireless charging are an exception.

### Wirelessly charging a mobile phone in the front

#### Requirements

- The mobile phone is suitable for wireless charging.

A list of compatible mobile phones can be found at: <https://www.mercedes-benz-mobile.com/>

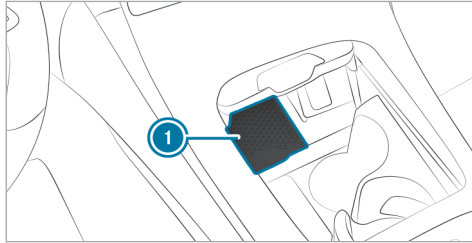

- ▶ Place the mobile phone in the front storage compartment as centrally as possible with the display facing upwards on mat ① next to the USB ports.

When the charging symbol is shown on the driver's display, the mobile phone is being charged. In addition, malfunctions when the mobile phone is being charged are shown on the central display.

- ① The mat can be removed for cleaning, e.g. using clean, lukewarm water.

### Installing/removing the floor mats

**⚠ WARNING** Risk of accident due to objects in the driver's footwell

Objects in the driver's footwell may impede pedal travel or block a depressed pedal.

This jeopardizes the operating and road safety of the vehicle.

- ▶ Stow all objects in the vehicle securely so that they cannot get into the driver's footwell.
- ▶ Always install the floor mats securely and as prescribed in order to ensure that there is always sufficient room for the pedals.
- ▶ Do not use loose floor mats and do not place floor mats on top of one another.

### Installing floor mats

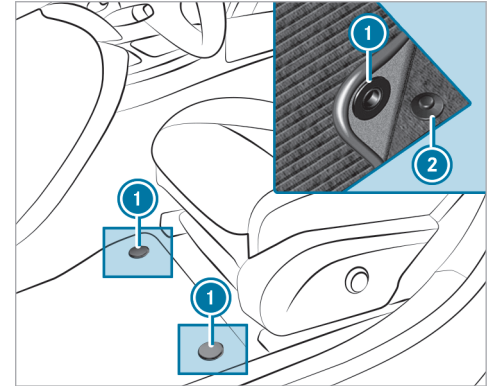

- ▶ Move the corresponding seat backwards and lay the floor mat in the footwell.
- ▶ Press studs ① onto holders ②.
- ▶ Adjust the corresponding seat.

### Removing floor mats

- ▶ Pull the floor mat off holders ②.

## 132 Seats and stowing

---

- ▶ Remove the floor mat.

## Exterior lighting

### Information about lighting systems and your responsibility

The various lighting systems of the vehicle are only aids. The driver of the vehicle is responsible for correct vehicle illumination in accordance with the prevailing light and visibility conditions, legal requirements and traffic situation.

## Light switch

### Operating the light switch

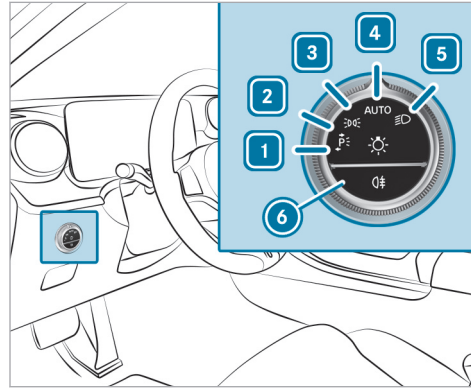

- 1 Left-hand parking lights
- 2 Right-hand parking lights
- 3 Standing lights and license plate lamp
- 4 Automatic driving lights (preferred light switch position)

- 5 Low beam / high beam
- 6 Switches the rear fog light on/off.

When low beam is activated, the indicator lamp for the standing lights will be deactivated and replaced by the low-beam indicator lamp.

▶ Always park your vehicle safely using sufficient lighting, in accordance with the relevant legal stipulations.

**!** **NOTE** Battery discharging by operating the parking lamps

Do not have the parking lamps switched on over a period of several hours.

If the battery is insufficiently charged, the standing lights or parking lights will be switched off automatically to facilitate the next engine start.

The exterior lighting (except standing and parking lights) will switch off automatically when the driver's door is opened.

- Observe the notes on locator lighting (→ page 142).

### Switching on accident scene lighting

- ▶ Switch off the vehicle.
- ▶ Switch on the hazard warning lights (→ page 135).
- ▶ Turn the light switch from the **AUTO** position to the  position. The low beam will be switched on despite the vehicle being switched off.

The accident scene lighting will be switched off if:

- you switch off the hazard warning lights.
- you turn the light switch back to **AUTO**.
- the battery is insufficiently charged.

### Automatic driving lights function

When the vehicle is switched on, the side lamps, low beam and daytime running lights will be switched on automatically depending on the ambient light.

**⚠ WARNING** Risk of accident when the low beam is switched off in poor visibility

When the light switch is set to **AUTO**, the low beam may not be switched on automatically if



there is fog, snow or other causes of poor visibility such as spray.

- ▶ In such cases, turn the light switch to .

The automatic driving lights are only an aid. You are responsible for the vehicle lighting.

### Switching the rear fog light on/off

#### Requirements

- The light switch is in the  or **AUTO** position.
- ▶ Press button .

Please observe the country-specific laws on the use of rear fog lamps.

### Operating the combination switch for the lights

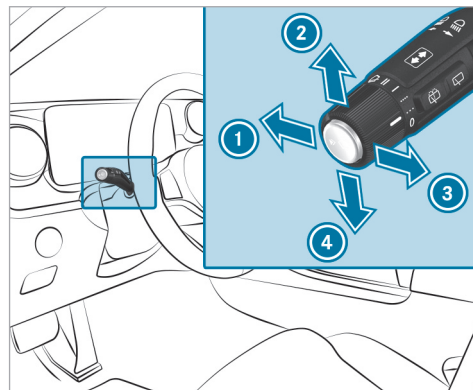



- ① High beam
- ② Turn signal light, right
- ③ Headlamp flashing
- ④ Turn signal light, left

- ▶ Use the combination switch to select the desired function.



### Switching on high beam

- ▶ Turn the light switch to the  or **AUTO** position.
- ▶ Push the combination switch in the direction of arrow ①.  
When high beam is activated, the indicator lamp for low beam  will be deactivated and replaced by the indicator lamp for high beam .

### Switching off high beam

- ▶ Push the combination switch in the direction of arrow ① or pull it in the direction of arrow ③.

### Headlamp flashing

- ▶ Pull the combination switch in the direction of arrow ③.

### Turn signals

- ▶ **To indicate briefly:** push the combination switch briefly to the point of resistance in the direction of arrow ② or ④.  
The corresponding turn signal light will flash three times.

▶ **To indicate permanently:** push the combination switch beyond the point of resistance in the direction of arrow ② or ④.

Vehicles with Active Lane Change Assist:

- A turn signal indicator activated by the driver may continue to operate for the duration of the lane change.
- If the driver indicated directly beforehand but a lane change was not immediately possible, the turn signal indicator may activate automatically.

### Activating/deactivating the hazard warning lights

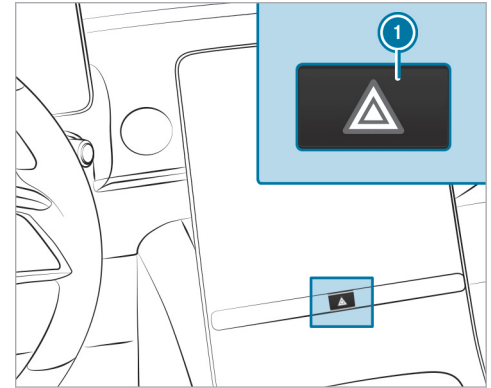

- ▶ Press button ①.

The hazard warning lights will switch on automatically if:

- the air bag has been deployed.

## DIGITAL LIGHT adaptive functions

### Function of dynamic low beam

With this system, the headlamps adapt to the driving and weather situation. It also provides extended functions for improved illumination of the road.

**i** The availability of the functions is country-dependent.

The system comprises the following functions:

- Active headlamps (→ page 136)
- Topographical compensation (→ page 136)

The system is active only when it is dark.

### Active headlamps function

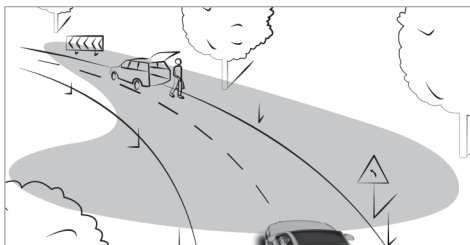

- The headlamps will follow your steering movements.
- Relevant areas will be better illuminated during a journey.

The functions will be active when the low beam is switched on.

### Function of the topographical compensation

Based on available map data, the lighting system responds pre-emptively to different road heights. This means that the headlamp range will remain virtually constant when you are driving uphill or downhill.

**i** Only vehicles with a multimedia system with navigation have this function.

### Assistance functions of DIGITAL LIGHT

DIGITAL LIGHT visually expands on the driver assistance systems by projecting the assistant displays in front of the vehicle while it is in motion. DIGITAL LIGHT can therefore help the driver in critical situations.

**i** The availability of the functions is country-dependent.

**i** The assistance functions of DIGITAL LIGHT may be an on-demand feature (→ page 24).

The system will remain active when Highbeam Assist is switched on.

**i** Depending on the country in which you are currently driving, certain functions may be disabled due to different legal requirements, even if they are enabled in the multimedia system. When you cross a border, the vehicle will automatically adapt to the applicable requirements.

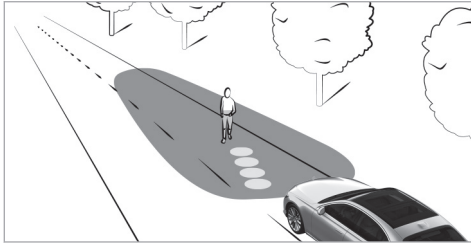
**Spotlight**

The spotlight function runs in the background and flashes the headlamps in four short bursts at persons detected within the lane markings. You will also be made aware of the position of the person by a projected symbol.

The function will be active in the following circumstances:

- You are driving outside illuminated areas.
- The system detects a lane marking.

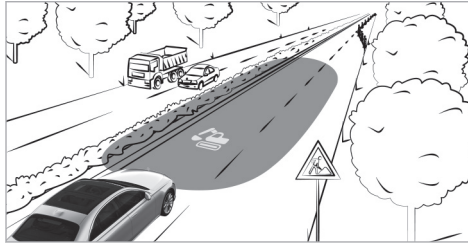
**Notes**

If Traffic Sign Assist detects a roadworks zone, the system will provide support as follows:

- A corresponding symbol will be projected onto the road when you enter a roadworks zone.

Observe the system limitations of Traffic Sign Assist (→ page 256).

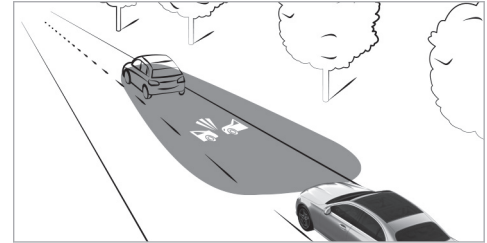
**Collision warning**

If you fall below the safe distance at speeds of at least 19 mph (30 km/h), a collision warning symbol will be projected onto the road.

Observe the system limitations of Active Brake Assist (→ page 250).

### Lane change warning

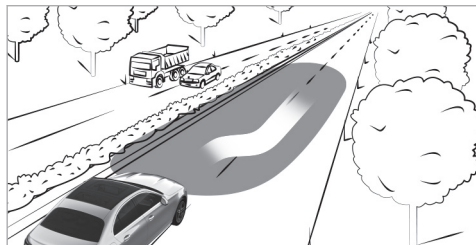

During assisted lane changes at speeds of at least 19 mph (30 km/h), the course of the lane change will flash.

Observe the system limitations of Active Lane Change Assist (→ page 246).

### Lane keeping and blind spot warning

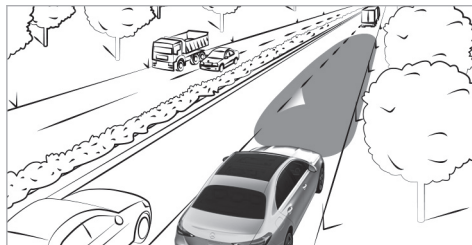

At speeds of at least 19 mph (30 km/h), a triangle that indicates a lane correction and its direction will be projected onto the road in the following cases:

- You leave the lane unintentionally.  
Observe the system limitations of Active Lane Keeping Assist (→ page 264).
- You switch on the turn signal light while an object or obstacle is in your blind spot.  
Observe the system limitations of Active Blind Spot Assist (→ page 261).

### Switching the Intelligent Light System on/off

#### Requirements

- The vehicle is switched on.

Multimedia system:

→  **Settings** **▶▶ Light**  
**▶▶ DIGITAL LIGHT**

- ▶ Activate or deactivate **Dynamic Low Beam**.

#### Activating/deactivating enhanced assistance functions

- ❗ The availability of the functions is country-dependent.
- ❗ This function is an on-demand feature (→ page 24).
- ▶ Select **Supporting Projections**.
- ▶ Activate or deactivate the desired projections.
- ▶ Switch **Projection for greeting/farewell** on or off.  
If the locator lighting or the exterior switch-off delay time is activated, a high-resolution greeting or farewell scene will be played back for a short period of time when the vehicle is

opened or switched off. You can choose between the **Digital Rain** and **Star Wave** sequences.

- i More information on locator lighting (→ page 142)  
 More information on the exterior switch-off delay time (→ page 142)

## Adaptive Highbeam Assist

### Adaptive Highbeam Assist function

**▲ WARNING** Risk of accident despite Adaptive Highbeam Assist

Adaptive Highbeam Assist does not react to:

- Road users without lights, e.g. pedestrians
- Road users with poor lighting, e.g. cyclists
- Road users whose lighting is obstructed, e.g. by a barrier

On very rare occasions, Adaptive Highbeam Assist may fail to recognize other road users with their own lighting, or may recognize them too late.

In these, or in similar situations, the automatic high beam will not be deactivated or will be activated despite the presence of other road users.

- ▶ Always observe the road and traffic conditions carefully and switch off the high beam in good time.

Adaptive Highbeam Assist cannot take into account road, weather or traffic conditions. Detection may be restricted in the following cases:

- In poor visibility, e.g. fog, heavy rain or snow
- if there is dirt on the sensors or the sensors are obscured

Adaptive Highbeam Assist is only an aid. You are responsible for adjusting the vehicle's lighting to the prevailing light, visibility and traffic conditions.

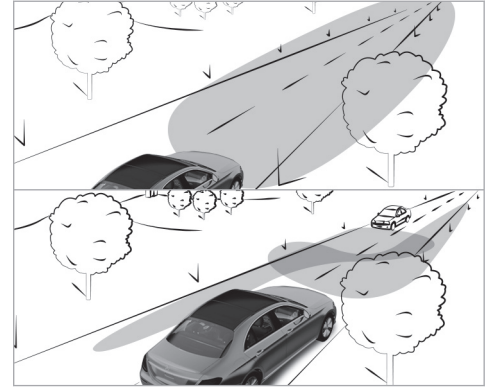

Adaptive Highbeam Assist automatically switches between the following types of light:

- Low-beam headlamps
- High beam

At speeds greater than 19 mph (30 km/h):

- If no other road users are detected, high beam will switch on automatically.

High beam will switch off automatically in the following cases:

- At speeds below 16 mph (25 km/h)
  - If other road users are detected
  - If street lighting is sufficient
- ① The system's optical sensor is located behind the windshield near the overhead control panel.

### Switching Adaptive Highbeam Assist on/off

#### Switching on

- ▶ Turn the light switch to the **AUTO** position.
- ▶ Switch on high beam using the combination switch.  
If Adaptive Highbeam Assist is activated, the  indicator lamp will light up on the driver's display.

#### Switching off

- ▶ Switch off high beam using the combination switch.

### Adaptive Highbeam Assist Plus

#### Adaptive Highbeam Assist Plus function (Canada)

**⚠ WARNING** Risk of accident despite Adaptive Highbeam Assist Plus

Adaptive Highbeam Assist Plus does not react to:

- Road users without lights, e.g. pedestrians
- Road users with poor lighting, e.g. cyclists
- Road users whose lighting is obstructed, e.g. by a barrier

On very rare occasions, Adaptive Highbeam Assist Plus may fail to recognize other road users with their own lighting, or may recognize them too late.

In these, or in similar situations, the automatic high beam will not be deactivated or will be activated despite the presence of other road users.

- ▶ Always observe the road and traffic conditions carefully and switch off the high beam in good time.

Adaptive Highbeam Assist Plus cannot take into account road, weather or traffic conditions.

Detection may be restricted in the following cases:

- In poor visibility, e.g. fog, heavy rain or snow
- if there is dirt on the sensors or the sensors are obscured

Adaptive Highbeam Assist Plus is only an aid. You are responsible for adjusting the vehicle's lighting to the prevailing light, visibility and traffic conditions.

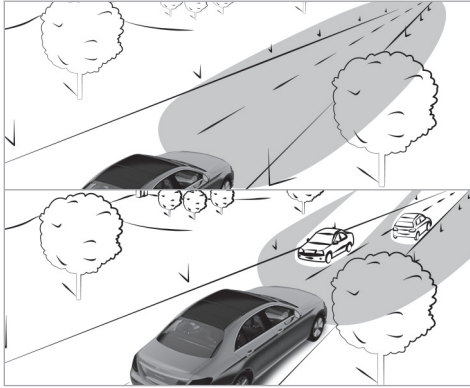

Adaptive Highbeam Assist Plus automatically switches between the following types of light:

- Low beam
- Partial high beam
- High beam
- ULTRA RANGE Highbeam

ULTRA RANGE Highbeam increases the brightness of the cone of light close to the legally permitted maximum.

Partial high beam does not include other road users in the high beam area. It does not dazzle them but enables full high-beam illumination for the driver apart from the excluded vehicles. Highly reflective signs are also illuminated with reduced brightness.

At speeds below 16 mph (25 km/h) or when there is sufficient street lighting:

- Partial high beam and high beam will be switched off automatically.

At speeds above 19 mph (30 km/h):

- If no other road users are detected, high beam will be switched on automatically.
- If other road users are detected, partial high beam will be switched on automatically.

at speeds below 25 mph (40 km/h):

- ULTRA RANGE Highbeam will switch off automatically.

At speeds above 31 mph (50 km/h):

- If no other road users are detected, the road is straight and it is not raining heavily, ULTRA RANGE Highbeam will be switched on automatically.
- If other road users are detected, partial high beam will be switched on automatically.
- If highly reflective signs are detected, ULTRA RANGE Highbeam will be switched off automatically.

**i** The system's optical sensor is located behind the windshield near the overhead control panel.

### ■ Switching Adaptive Highbeam Assist Plus on/off (Canada)

#### Switching on

▶ Turn the light switch to the **AUTO** position.

▶ Switch on high beam using the combination switch.

If Adaptive Highbeam Assist Plus is activated, the  indicator lamp will light up on the driver's display. When partial high beam or

high beam is active, the corresponding blue indicator lamp will also light up.

### Switching off

- ▶ Switch off high beam using the combination switch.

### Switching the daytime running lamps on/off

Multimedia system:

→  ▶ Settings ▶ Light  
▶▶ DIGITAL LIGHT

- ▶ Activate or deactivate the **Daytime Running Lights**.
- ⓘ In vehicles without DIGITAL LIGHT headlamps, the daytime running lamps can be switched on or off in the **driving lights** menu.
- ⓘ The availability of the function is dependent on the country.

### Setting the exterior lighting switch-off delay time

Multimedia system:

→  ▶ Settings ▶ Light  
▶▶ Interior/Exterior Lighting  
▶▶ External Lighting Delay

- ▶ Set a switch-off delay time.  
When the vehicle's engine is switched off, the exterior lighting will be activated for the set time.

### Switching locator lighting on/off

Multimedia system:

→  ▶ Settings ▶ Light  
▶▶ Interior/Exterior Lighting



- ▶ Activate or deactivate **Locator Lighting**.

When the function is activated, the exterior lighting will light up for 40 seconds after the vehicle is unlocked or the driver's door is opened when the vehicle is parked and not locked. When you start the vehicle, the locator lighting is switched off and automatic driving lights are activated.

### Interior lighting

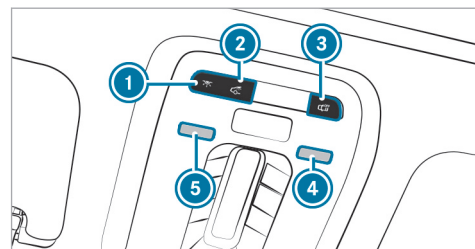
#### Adjusting the interior lighting





- ①  Switches the front interior lighting on/off.
- ②  Switches the rear interior lighting on/off.
- ③  Switches automatic interior lighting control on/off.

- ▶ **To switch reading lamps on/off:** hold your hand under the respective reading lamp ④ or ⑤.

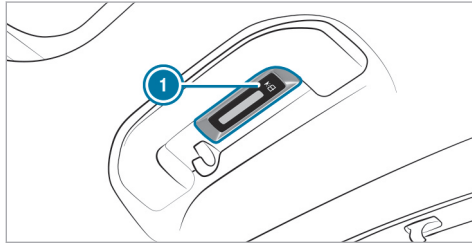

### Operating unit inside the grab handle (rear passenger compartment)



①  Rear reading lamp

▶ To switch on or off: press button ①.

### Adjusting the ambient lighting

Multimedia system:

→  ▶▶ Comfort ▶▶ Ambient Light

### Setting the color

- ▶ Select **Color**.
- ▶ Select **Monochrome** or **Multi-color**.

- ▶ Set the desired color or color scheme.

### Adjusting the brightness

- ▶ Select **Brightness**.
- ▶ Adjust the brightness.
- ① Depending on the ambient light, the ambient lighting will automatically switch between day and night modes.

### Activating the brightness for zones

- ▶ Select **Brightness**.
- ▶ Switch off **Link Zones**.  
The **Direct**, **Indirect** and **Accents** zones can be set separately.

### Activating effects

**⚠ WARNING** Risk of accident if ambient lighting and active ambient lighting effects are not switched on

The warning assistance effects will be fully active only when the relevant driving or driving safety systems are activated on the Driving Assistance menu.

- ▶ Make sure that the relevant driving or driving safety systems are activated.

- ① Observe the notes on driving systems and your responsibility; you may otherwise fail to recognize dangers (→ page 221).
- ▶ Select **Effects**.
- ▶ Activate the desired effect.
- ① Depending on the vehicle equipment, different effects are available.

### Operating feedback effects

- **Climate**: If changes are made to the temperature setting in the vehicle, the color of the ambient lighting will change briefly.

### Warning When Exiting

- If an object is detected in the blind spot while you are getting out of the vehicle, the ambient lighting in the affected door will flash red.  
Further information on the exit warning (→ page 261).

### Multi-color Animation

- The chosen color combination will change at predefined intervals.

### Switching the interior lighting switch-off delay time on/off

Multimedia system:

-  → Settings → Light
- Interior/Exterior Lighting
- Interior Lighting Delay



- ▶ Activate or deactivate **Interior Lighting Delay**. If this function is active, the interior lighting will be switched on for a short time after the end of the journey.

### Windshield wiper and windshield washer system

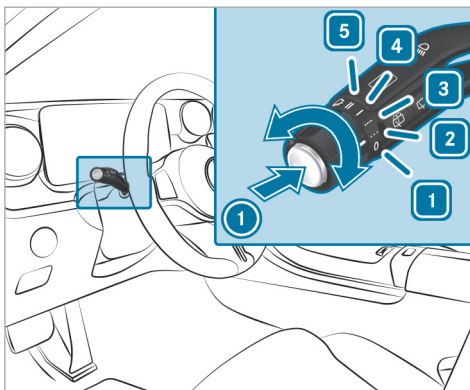
#### Switching the windshield wipers on/off



- |          |            |                            |
|----------|------------|----------------------------|
| <b>1</b> | <b>0</b>   | Windshield wipers off      |
| <b>2</b> | <b>...</b> | Automatic wiping, normal   |
| <b>3</b> | <b>...</b> | Automatic wiping, frequent |
| <b>4</b> | <b>—</b>   | Continuous wiping, slow    |
| <b>5</b> | <b>==</b>  | Continuous wiping, fast    |

- ▶ Turn the combination switch to the corresponding position **1** - **5**.
- ▶  **Single wipe:** press button **1** as far as the point of resistance.
- ▶  **Wiping with washer fluid:** press button **1** beyond the point of resistance.
- ▶ **i** Observe the notes on washing the vehicle in a car wash (→ page 379).

### Changing the windshield wiper blades

**⚠ WARNING** Risk of becoming trapped if the windshield wipers are switched on while wiper blades are being replaced

If the windshield wipers begin to move while you are changing the wiper blades, you can be trapped by the wiper arm.

- ▶ Always switch off the windshield wipers and vehicle before changing the wiper blades.

### Moving the wiper arms into the replacement position

- ▶ Switch the vehicle on and then off again immediately.
- ▶ Within around 15 seconds, press the  button on the combination switch for approximately three seconds (→ page 144). The wiper arms will move into the replacement position.
- ⓘ Depending on the production period of the vehicle, different variants of the wiper blades will have been installed.

### Removing the wiper blades (variant 1)

- ▶ Fold the wiper arms away from the windshield.

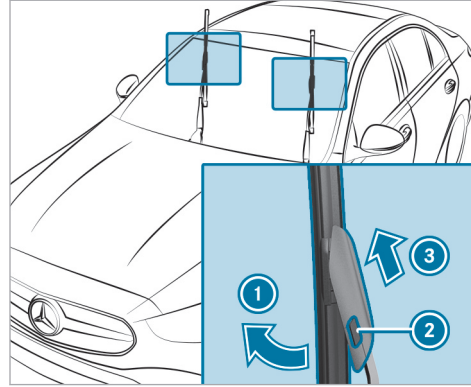

- ▶ Hold the wiper arm with one hand. With the other hand, turn the wiper blade away from the wiper arm in the direction of arrow ① as far as it will go.
- ▶ Press release knob ②.
- ▶ Remove the wiper blade in the direction of arrow ③ away from the wiper arm.

### Removing the wiper blades (variant 2)

- ▶ Fold the wiper arms away from the windshield.

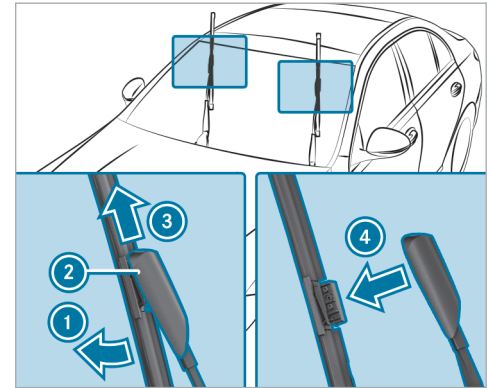

- ▶ Hold the wiper arm with one hand. With the other hand, turn the wiper blade away from the wiper arm in the direction of arrow ① as far as it will go.
- ▶ Slide catch ② in the direction of arrow ③ until it engages in the removal position.

- ▶ Remove the wiper blade from the wiper arm in the direction of arrow ④.

### Installing the wiper blades (variant 1)

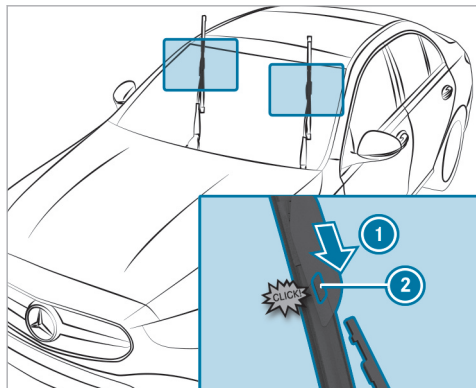

- ▶ Insert the new wiper blade in to the wiper arm in the direction of arrow ① until release knob ② engages.
- ▶ Make sure that the wiper blade is seated correctly.

- ▶ Fold the wiper arms back onto the windshield.
- ▶ Switch on the vehicle.
- ▶ Press the  button on the combination switch. The wiper arms will return to their original positions.
- ▶ Switch off the vehicle.

### Installing the wiper blades (variant 2)

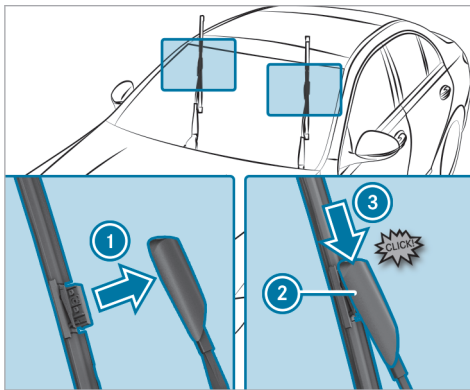

- ▶ Insert the new wiper blade into the wiper arm in the direction of arrow ①.
- ▶ Slide catch ② in the direction of arrow ③ until it engages in the locking position.
- ▶ Make sure that the wiper blade is seated correctly.
- ▶ Fold the wiper arms back onto the windshield.
- ▶ Switch on the vehicle.
- ▶ Press the  button on the combination switch. The wiper arms will return to their original positions.
- ▶ Switch off the vehicle.

### Maintenance display

A maintenance display can be found at the tip of the blade on the newly installed wiper blades.

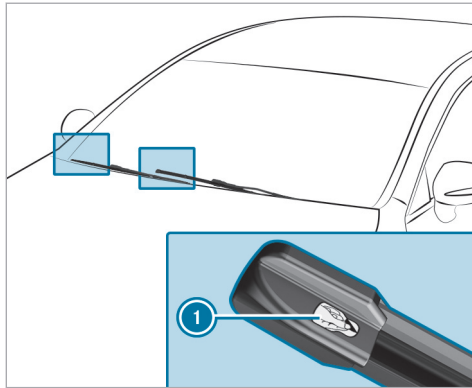

- ▶ Remove protective film ❶ from the maintenance display.

When the color of the maintenance displays changes from black to yellow, you should replace the wiper blades.

## Mirrors

### Operating the outside mirrors

- ⚠ **WARNING** Risk of accident due to adjusting the vehicle settings while the vehicle is in motion

You could lose control of the vehicle in the following situations in particular:

- If you adjust the driver's seat, the head restraint, the steering wheel or the mirror while the vehicle is in motion
  - If you fasten your seat belt while the vehicle is in motion
- ▶ Before starting the vehicle: in particular, adjust the driver's seat, head restraint, steering wheel and mirror, and fasten your seat belt.

- ⚠ **WARNING** Risk of accident due to misjudgment of distance when using the front-passenger mirror

The outside mirror on the front passenger side reflects objects on a smaller scale. The objects in view are in fact closer than they appear.

- ▶ Therefore, always look over your shoulder to check the actual distance between you and the road users traveling behind you.

### Adjusting the outside mirrors

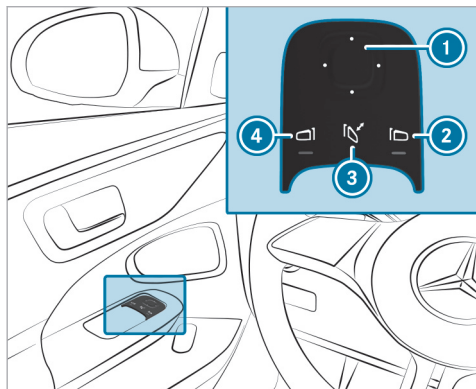

- ▶ Use button ② or ④ to select the desired mirror.
- ▶ Use button ① to adjust the position of the selected mirror.

### Folding the outside mirrors in/out (vehicles with electrically folding outside mirrors)

- ▶ Briefly press button ③.

- ⓘ If the battery has been disconnected or has discharged, the outside mirrors must be moved briefly using button ③. Only then will the automatic mirror folding function work properly.

### Engaging the outside mirrors

If an outside mirror has been forcibly disengaged, proceed as follows.

- ▶ Vehicles without electrically folding outside mirrors: move the outside mirror into the correct position manually, until it engages audibly.
- ▶ Vehicles with electrically folding outside mirrors: press and hold button ③. You will hear a click and the mirror will audibly engage. The outside mirror will now be set to the correct position.

### Automatic anti-glare mirrors function

**⚠ WARNING** Risk of acid burns and poisoning due to the anti-glare mirror electrolyte

Electrolyte may escape if the glass in an automatic anti-glare mirror breaks.

The electrolyte is hazardous to health and causes irritation. It must not come into contact with your skin, eyes, respiratory organs or clothing or be swallowed.

- ▶ If you come into contact with electrolyte, observe the following:
  - Immediately rinse the electrolyte from your skin with water and seek medical attention.
  - If electrolyte comes into contact with your eyes, immediately rinse them thoroughly with clean water and seek medical attention.
  - If the electrolyte is swallowed, immediately rinse your mouth out thoroughly. Do not induce vomiting. Seek medical attention immediately.
  - Immediately change out of clothing which has been contaminated with electrolyte.
  - If an allergic reaction occurs, seek medical attention immediately.

The inside rearview mirror and the outside mirror on the driver's side will automatically go into anti-glare mode if light from a headlamp hits the sensor on the inside rearview mirror.

### System limits

The system will not go into anti-glare mode if:

- The vehicle is switched off.
- Reverse gear is engaged.
- The interior lighting is switched on.

### Front-passenger outside mirror parking position function

The parking position makes parking easier.

The front-passenger outside mirror will swivel downwards in the direction of the rear wheel on the front passenger's side when:

- The parking position is stored (→ page 149).
- The front-passenger mirror is selected.
- Reverse gear is engaged.

The front-passenger outside mirror will move back to its original position when:

- You shift the transmission to another transmission position.
- You are traveling at a speed greater than 9 mph (15 km/h).
- You press the button for the outside mirror on the driver's side.

### Storing and calling up the parking position of the front-passenger outside mirror using reverse gear

#### Storing

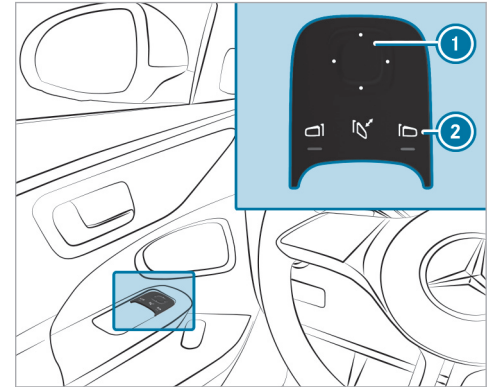

- ▶ Select the front-passenger outside mirror using button ②.
- ▶ Engage reverse gear.
- ▶ Move the front-passenger outside mirror into the desired parking position using button ①.

### Calling up

- ▶ Select the front-passenger outside mirror using button ②.
- ▶ Engage reverse gear.  
The front-passenger outside mirror will move into the stored parking position.

### Activating/deactivating the automatic mirror folding function

---

Multimedia system:

- ▶  ▶ Settings ▶ Vehicle
- ▶ Open/Close
- ▶ Activate or deactivate **Automatic Mirror Folding**.



## Overview of climate control systems

### Notes on climate control

An interior air filter in combination with the prefilter in the engine compartment must always be used so that the air conditioning system, pollution level monitoring and the air filtration work correctly. Use filters recommended and approved by Mercedes-Benz. Always have maintenance work carried out at a qualified specialist workshop.

### Overview of the THERMATIC climate bar

The indicator lamps indicate that the corresponding functions are activated.

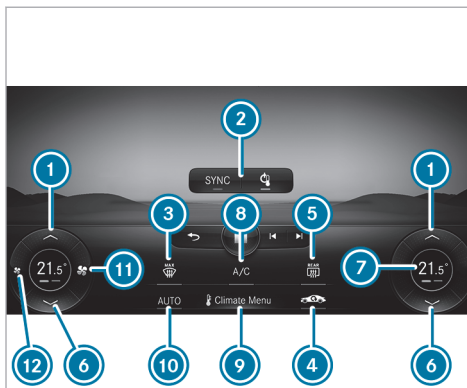

- ① Increases the temperature
- ② Upper display area of the climate bar with the examples of switching climate control on/off (→ page 153) and **SYNC** synchronization function (→ page 155)
- ③ Defrosts the windshield
- ④ Activates/deactivates the A/C function (→ page 154)

- ⑤ Switches the rear window defroster on/off
  - ⑥ Reduces the temperature
  - ⑦ Depending on vehicle equipment and settings: temperature display, defrost function display, display for pre-entry climate control or auxiliary heating
  - ⑧ Switches air-recirculation mode on/off (→ page 156)
  - ⑨ Calls up the air conditioning menu (→ page 154)
  - ⑩ **AUTO** Sets climate control to automatic mode (→ page 155)
  - ⑪ Increases the airflow or switches on climate control (→ page 153)
  - ⑫ Reduces the airflow or switches off climate control (→ page 153)
- ⓘ The availability of individual functions depends on the country and equipment.

### Overview of THERMOTRONIC climate bar

The indicator lamps indicate that the corresponding function is activated.

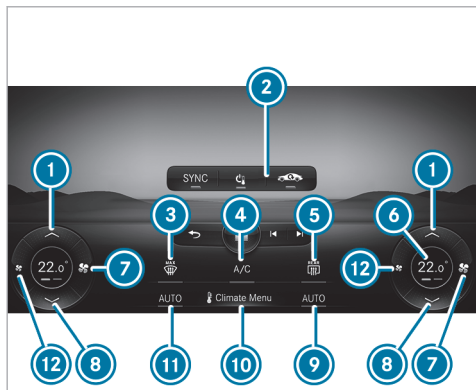

Front climate bar on the central display (example)

- ① ▲ Increases the temperature
- ② **SYNC** Synchronization function (→ page 155)

- ③ ❄️ Switches off climate control (→ page 153)

- ④ 🔄 Switches air-recirculation mode on/off (→ page 156)

- ③ ❄️ Defrosts the windshield

- ④ A/C Activates/deactivates the A/C function (→ page 154)

Activates/deactivates residual heat utilization (→ page 156)

- ⑤ 🚗 Switches the rear window defroster on/off

- ⑥ Depending on vehicle equipment and settings:

Temperature display

- ❄️ Display for the defrost function

- 🌀 Airflow

- 🚗 Pre-entry climate control or auxiliary heating

- ⑦ 🌀 Increases the airflow or switches on climate control (→ page 153)

- ⑧ ▼ Reduces the temperature

- ⑨ **AUTO** Sets climate control to automatic mode, right (→ page 155)

- ⑩ **MENU** Calls up the air conditioning menu (→ page 154)

- ⑪ **AUTO** Sets climate control to automatic mode, left (→ page 155)

- ⑫ 🌀 Reduces the airflow or switches off climate control (→ page 153)

- ⓘ The climate bar is visible even when the vehicle is parked or the air conditioning is switched off (→ page 153).

- ⓘ The availability of individual functions is country- and equipment-dependent.

## Overview of the rear operating unit

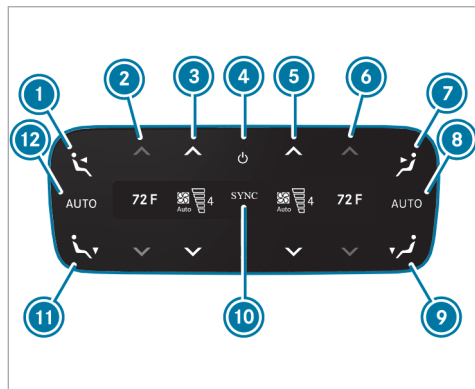

Example: USA

- ❶ Sets the air distribution to the center air vents in the rear passenger compartment, left
- ❷ Sets the temperature in the rear passenger compartment, left
- ❸ Sets the airflow in the rear passenger compartment, left, or switches climate control on/off (→ page 154)
- ❹ Switches climate control on/off (→ page 154)
- ❺ Sets the airflow in the rear passenger compartment, right, or switches climate control on/off (→ page 154)
- ❻ Sets the temperature in the rear passenger compartment, right
- ❼ Sets the air distribution to the center air vents in the rear passenger compartment, right
- ❽ Sets rear passenger compartment climate control to automatic mode, right
- ❾ Sets the air distribution to the footwell vents in the rear passenger compartment, right
- ❿ Synchronization is activated (→ page 155)
- ⓫ Sets the air distribution to the footwell vents in the rear passenger compartment, left
- ⓬ Sets rear passenger compartment climate control to automatic mode, left

The settings for the second row of seats can be configured via the rear operating unit or the multi-

media system (→ page 155) depending on the vehicle's equipment.

## Operating the climate control system

### Switching climate control on/off

#### Switching on climate control

▶ Set the airflow to level 1 or higher via on the climate bar on the central display

or

▶ Press **AUTO**, , or .

#### Switching off climate control

▶ Set the airflow to level 0 via on the climate bar on the central display

or

▶ Press .

If climate control is switched off, the windows may fog up more quickly. Switch climate control off only briefly.

- ❶ If you switch off climate control by pressing , fragrancing, if enabled, will also be switched off automatically.

### Switching climate control on/off via the rear operating unit

#### Switching on

- ▶ Press button ④.

or

- ▶ Set the airflow to level 1 or higher using buttons ③ and ⑤.

or

- ▶ Press buttons ②, ⑥, ⑧ or ⑫.

#### Switching off

- ▶ Press button ④.

or

- ▶ Set the airflow to level 0 using buttons ③ and ⑤.

- ① If rear climate control is switched off via button ④, OFF will be shown on the displays.

### Switching the A/C function on/off using the air conditioning control panel

The A/C function heats, cools and dehumidifies the vehicle's interior air.

- ▶ Press the  button.

Switch off the A/C function only briefly; otherwise, the windows may fog up more quickly.

Condensation may drip from the underside of the vehicle when cooling mode is active. This is not indicative of a malfunction.

### Calling up the air conditioning menu via the climate bar or the air conditioning control panel

The air conditioning menu can be called up via the climate bar. The climate bar is always shown on the lower edge of the central display.



- ▶ Select the **Climate Menu** entry in the air conditioning bar.  
The **First Row of Seats** menu is opened.

### Defrosting the windshield via the climate bar

#### Switching on

- ▶ Press  on the climate bar on the central display.

#### Switching off

- ▶ Press , **AUTO** or  on the climate bar on the central display.

or

- ▶ Set the airflow to 0.

- ① When the defrost function is activated, some functions (e.g. the temperature setting) will automatically be deactivated.

### Activating/deactivating the A/C function via the air conditioning menu

Multimedia system:



- ↳ **Climate Menu** ▶ **First Row of Seats**

Depending on the external conditions, support for improved cooling and dehumidification of the interior air will be provided when the A/C function is activated. If it is not possible to operate the A/C function on the climate bar on the central display, switch the function on or off in the climate menu of the central display.

- ▶ Select **A/C** (A/C).

### Sets climate control to automatic



In automatic mode, the set vehicle interior temperature is controlled automatically and maintained at a constant level by the air supply.

- ▶ Press **AUTO** on the climate bar on the central display.
- ❗ You can increase or reduce the airflow by pressing  on the climate bar on the multimedia system.
- ▶ **To switch to manual operation:** switch off automatic mode or adjust an aspect of air distribution, e.g. .

### Setting air distribution via the air conditioning menu

Multimedia system:

↳ Climate Menu

- ▶ Select **First Row of Seats** or **Second Row of Seats**.
- ▶ To set air distribution: select ,  or .
- ▶ Set the airflow.

- ❗ When the air conditioning system is switched on, at least one zone is always active. However, several air distribution options can be selected at the same time, for example to set the climate control for the vehicle interior and the footwells simultaneously. The  climate control for the windshield can only be selected for the first seat row. When automatic mode is active, the buttons for setting the air distribution are deactivated automatically. If the air conditioning system is deactivated, the buttons remain operable and the last setting is saved.

### Setting rear climate control using the air conditioning menu



Multimedia system:

↳ Climate Menu



#### Setting the temperature

- ▶ Select **Second Row of Seats**.
- ▶ Set the temperature.

### Setting the airflow

- ▶ Select **Second Row of Seats**.
- ▶ Set the air flow with  or .

### Controlling the rear climate control automatically

- ▶ Select **AUTO**.
- ❗ When the defrost function is activated, some functions (e.g. the temperature setting) will automatically be deactivated. To deactivate the defrost function, press either , **AUTO** or  set the air flow to level 0 (→ page 154).

### Deactivating rear climate control

- ▶ Select **REAR OFF**.

### Switching the synchronization function on/off via the air conditioning menu

Multimedia system:

↳ Climate Menu ▶▶ **First Row of Seats**

The synchronization function controls the climate control centrally. The driver's settings for temper-

ature, airflow and air distribution are automatically adopted for each climate zone.

- ▶ Select **SYNC** (SYNC).

### Defrosting the windows

#### Windows fogged up on the inside

- ▶ Press **AUTO** on the climate bar on the central display.
- ▶ If the windows remain fogged up: press  on the climate bar on the central display.

#### Windows fogged up on the outside

- ▶ Switch on the windshield wiper.

### Switching air-recirculation mode on/off via the multimedia system

#### Requirements

- The THERMOTRONIC air conditioning control panel is available.

Multimedia system:

↳ **Climate Menu** ▶▶ **First Row of Seats**

- ▶ Press  in the upper display area of the climate bar.

The interior air will be recirculated.

Air-recirculation mode will automatically switch to fresh air mode after a while.

- ⓘ If air-recirculation mode is switched on, the windows may fog up more quickly. Switch on air-recirculation mode only briefly.

### Switching air-recirculation mode on/off

- ▶ Press  on the climate bar on the central display.  
The interior air will be recirculated.

Air-recirculation mode will automatically switch to fresh air mode after a while.

- ⓘ If air-recirculation mode is switched on, the windows may fog up more quickly. Switch on air-recirculation mode only briefly.

### Switching residual heat mode on/off via the climate bar

#### Requirements

- The residual heat function is available.
- The vehicle is parked.
- The coolant temperature is sufficiently high.

It is possible to make use of the residual heat from the engine to continue heating or ventilating the front compartment of the vehicle for approximately 30 minutes, depending on the temperature set.

- ▶ **To switch on or off:** select **Residual Heat** on the climate bar of the central display.

The residual heat function will automatically switch off after some time.

- ⓘ If residual engine heat utilization is activated, the two buttons for setting the temperature and air distribution will automatically be deactivated.

## Pre-entry climate control when the vehicle is unlocked

### Function of pre-entry climate control when the vehicle is unlocked

**i** The following function is available only for the Mercedes-AMG GLC 63 S E Performance model.

The seats can be briefly pre-warmed or pre-cooled before you get into the vehicle.

Depending on the vehicle's equipment, the following functions will be activated as needed during pre-cooling:

- Automatic climate control
- Blower
- Seat ventilation

Depending on the vehicle's equipment, the following functions will be activated as needed during pre-warming:

- Automatic climate control
- Blower
- Seat heating

- Steering wheel heating
- Mirror heater
- Rear window heater

### Setting pre-entry climate control when the vehicle is unlocked in the multimedia system

Multimedia system:

↳ Climate Menu ▶▶ Pre-entry Climate Ctrl.

▶ Activate or deactivate the function.

#### Selecting seats

▶ Select **Driver**, **Passenger**, **Rear Left** or **Rear Right**.

The seat-specific functions of pre-entry climate control, such as seat heating, will be performed for the selected seats.

If pre-entry climate control is enabled, an LED on the climate bar of the central display will light up blue for a cooled vehicle and red for a heated vehicle.

**i** This function is available only for the Mercedes-AMG GLC 63 S E Performance model.

### Activating/deactivating pre-entry climate control when the vehicle is unlocked

#### Requirements

- The high-voltage battery is charged sufficiently.
- The function has been activated via the multimedia system.

▶ **To switch on:** unlock the vehicle. The climate control functions are activated for up to five minutes for pre-heating and pre-cooling.

Pre-entry climate control when the vehicle is unlocked cannot be activated more than twice when the vehicle is switched off.

▶ **To switch off:** press  on the climate bar on the central display.

Depending on the vehicle equipment, the following functions will remain active once the vehicle has been started:

- Seat heating
- Seat ventilation

- ⓘ This function is available only for the Mercedes-AMG GLC 63 S E Performance model.

### Pre-entry climate control for departure time

#### Function of pre-entry climate control at departure time

**⚠ WARNING** Risk of fatal injury due to exposure to extreme heat or cold in the vehicle

If persons, particularly children, are subjected to prolonged exposure to intense heat or cold, there is a risk of severe injury or even death.

- ▶ Never leave persons, particularly children, unattended in the vehicle.

**⚠ WARNING** Risk of burns due to repeatedly switching on the seat heating

Repeatedly switching on the seat heating can cause the seat cushion and seat backrest padding to become very hot.

In particular, the health of persons with limited temperature sensitivity or a limited ability to react to high temperatures may be affected or they may even suffer burn-like injuries.

- ▶ Do not repeatedly switch on the seat heating.

To protect against overheating, the seat heating may be temporarily deactivated after it has been switched on repeatedly.

- ⓘ This function is available only in vehicles with a high-voltage battery or some models with a 48 V on-board electrical system.

The air inside the vehicle can be heated, ventilated or cooled to the set temperature when the vehicle is parked.

Plug-in hybrid: when the vehicle is connected to power supply equipment, priority will be given to charging the high-voltage battery to a specified minimum charge.

The running time of pre-entry climate control may be reduced in the following circumstances:

- Plug-in hybrid: the vehicle is not connected to power supply equipment.

- The high-voltage battery or the 48 V battery is not fully charged.

Plug-in hybrid: with active pre-entry climate control, the state of charge of the high-voltage battery may be reduced, even if the charging cable connector is connected.

If present, seat ventilation will be activated in cooling and ventilation modes.

Depending on the vehicle's equipment, the following functions will be activated in heating mode, if available:

- Seat heating
- Steering wheel heating
- Mirror heater
- Rear window heating

When the set temperature changes, climate control mode will switch automatically as follows:

- From heating mode to ventilation or cooling mode, or
- From cooling mode to ventilation or heating mode, or



- From ventilation mode to heating or cooling mode

### ■ Setting pre-entry climate control at departure time via the multimedia system

Multimedia system:

➔ Climate Menu ➔ Pre-entry Climate Ctrl.

#### Setting the departure time

- ① Plug-in hybrid: the set departure times are used for the vehicle's pre-entry climate control and for predictions regarding the approximate state of charge and range at the time selected. Additional information on the charging settings: (→ page 337).

▶ Select **Edit Departure Time** .

▶ Select a departure time or set a new departure time.

#### Setting the repeat days

▶ Select **Edit Departure Time** .

▶ Set the desired departure time and select the corresponding weekdays on which this departure time is to apply.

▶ Press **OK** to confirm.

#### Selecting seats

▶ Select **Driver**, **Passenger**, **Rear Left** or **Rear Right**.

Pre-entry climate control will take place for the selected seats.

#### ■ Activating/deactivating pre-entry climate control for departure time

##### Requirements

- The 48 V battery or the high-voltage battery is charged sufficiently.
- The function has been activated via the multimedia system.

▶ **To activate:** set the departure time (→ page 159).

Vehicles with 48 V on-board electrical system: Pre-entry climate control for departure time will switch on a maximum of 5 minutes before the selected departure time.

Plug-in hybrid: Pre-entry climate control for departure time will switch on a maximum of 55 minutes before the selected departure

time. It will remain active for another five minutes if departure is delayed.

▶ **To deactivate the pre-entry climate control for departure time early:** press  on the climate bar on the central display or switch off the preselection of the time in the climate menu.

If present, the following functions will remain active once the vehicle has been started:

- Seat heating
- Seat ventilation

#### Activating/deactivating immediate pre-entry climate control (plug-in hybrid)

**⚠ WARNING** Risk of fatal injury due to exposure to extreme heat or cold in the vehicle

If persons, particularly children, are subjected to prolonged exposure to intense heat or cold, there is a risk of severe injury or even death.

▶ Never leave persons, particularly children, unattended in the vehicle.

Air conditioning of the vehicle interior can continue for up to 50 minutes, e.g. if the journey is interrupted.

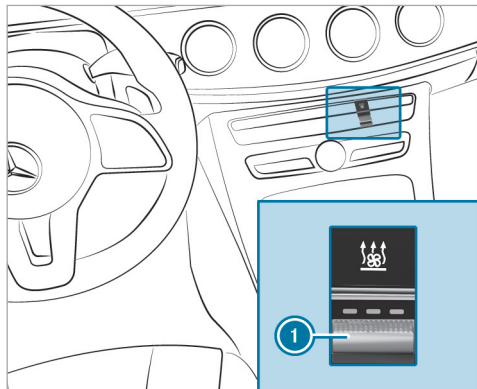

The colors of the indicator lamp have the following meanings:

- **Blue:** cooling is activated.
- **Red:** heating is activated.

- **Yellow:** the departure time has been preselected.
- ▶ Set the desired temperature using the ▼▲ button.
  - ▶ Press button ①. The red or blue indicator lamp on button ① will light up or go out.

### Air vents

#### Adjusting the front air vents

**⚠ WARNING** Risk of burns or frostbite due to being too close to the air vents

Very hot or very cold air can flow from the air vents.

- ▶ Make sure that all vehicle occupants always maintain a sufficient distance from the air vents.
- ▶ If necessary, direct the airflow to another area of the vehicle interior.

To guarantee the flow of fresh air through the air vents into the vehicle interior, note the following:

- Always keep the vents and ventilation grilles in the vehicle interior clear.
- Keep the air inlet free of residue build-up (→ page 379).

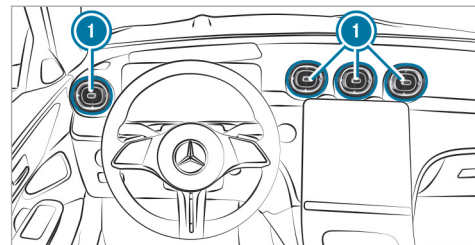

- ▶ **To open or close:** hold the center of air vent ① and turn it to the left (open) or right (closed) as far as it will go.
- ▶ **To set the airflow direction:** hold the center of air vent ① and move it up or down or to the left or right.

### ■ Adjusting the rear air vents

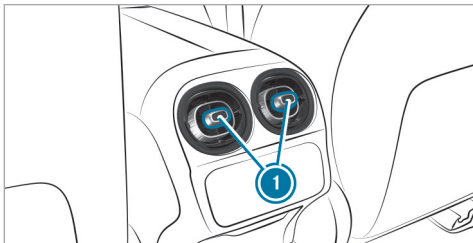

- ▶ **To open or close:** turn controller ❶ to the left or right as far as it will go.
- ▶ **To set the airflow direction:** hold the center of controller ❶ and move it up or down or to the left or right.

## Driving

### Notes on Mercedes-AMG vehicles

Observe the notes on the following topics in the Supplement, as you may otherwise fail to recognize dangers.

- ① The availability of certain functions depends on the equipment and model of the vehicle.
- Reduction of engine output and engine torque
- Emotion Start
- AMG Real Performance Sound
- RACE START
- AMG RIDE CONTROL
- AMG steering-wheel buttons

### Notes on plug-in hybrids

#### Notes on plug-in hybrid operation

**⚠ WARNING** Risk of chemical burns and poisoning from damaged high-voltage battery

If the housing of the high-voltage battery has been damaged, electrolyte and gases may leak out.

- ▶ Avoid contact with the skin, eyes or clothing.
- ▶ Immediately rinse electrolyte splashes off with water and seek medical attention straight away.

**⚠ DANGER** Risk of fire and explosion from excessive internal pressure of the high-voltage battery

In the event of a vehicle fire, flammable gas can escape and ignite.

- ▶ If there is an unusual smell, smoke or burn marks, stop the charging process immediately.

- ▶ Leave the danger zone immediately. Secure the danger area at a sufficient distance.
- ▶ Call the fire service.

**! NOTE** Mercedes-AMG vehicles

- ▶ Observe the notes in the Supplement. You could otherwise fail to recognize dangers.

The hybrid system combines a combustion engine with an electric motor.

Characteristics when the vehicle is at a standstill:

- The combustion engine is generally switched off.
- Idle speed occurs only in certain instances.

Characteristics when starting the vehicle:

- If the high-voltage battery is sufficiently charged, the vehicle can be started with the electric drive without the combustion engine (noiseless start).

- If the high-voltage battery for the electric drive system is not sufficiently charged or the vehicle conditions for a silent start are not met, the vehicle will start with the combustion engine.
- ① Depending on the system, it may happen that even though the high-voltage battery is charged, electric mode has restricted or no availability. Once the combustion engine has been operated for long enough and ambient conditions permit, electric mode is again available without restriction.

Characteristics with moderate power output requests:

- The combustion engine is switched off as often as possible during the journey.
- The vehicle can, depending on the drive program selected and the state of charge of the high-voltage battery, be accelerated electrically up to a speed of approximately 87 mph (140 km/h).

Characteristics with high power output requests:

- The electric motor supports the combustion engine (boost effect), e.g. when pulling away or accelerating.
- The high-voltage battery is discharging.

Characteristics when releasing the accelerator pedal during the journey:

- The electric motor is operated as a alternator when in overrun mode and during braking.
- The high-voltage battery is being charged.

Notes on electric mode:

- Vehicles with hybrid systems generate significantly less noise when stationary and when being driven than vehicles with combustion engines.
- When driving in electric mode the vehicle may not be heard by other road users due to the significantly reduced noise generated when driving and when at a standstill.

It is for this reason that the vehicle is equipped with a sound generator, which serves as

an acoustic vehicle alerting system (AVAS). This safety device is prescribed by law.

The external noise of the sound generator is perceptible in the vehicle interior when the vehicle is stationary and at low speeds and does not represent a malfunction.

- If not all of the vehicle conditions for electric mode are met, then the combustion engine is switched on.
- Performance restrictions in electric mode are possible due to the operating temperature of the high-voltage battery and drive system, the ambient temperature and aging of the high-voltage battery.
- In electric mode, the maximum output is not permanently available and may drop to the level of continuous output.

Notes on the acoustic vehicle alerting system:

- At a speed of up to approx. 19 mph (30 km/h), the sound generator generates stationary noise and speed-dependent driving noise.

- This helps other road users, particularly pedestrians and cyclists, to hear your vehicle better.
- When driving at speeds of 13 mph (20 km/h) or above, the acoustic vehicle alerting system will gradually switch off.

### Manually disconnecting the high-voltage on-board electrical system

**⚠ DANGER** Risk of death and fire due to modified and/or damaged components of the high-voltage on-board electrical system

The vehicle's high-voltage on-board electrical system is under high voltage. If you modify component parts in the vehicle's high-voltage on-board electrical system or touch damaged component parts, you may be electrocuted. In addition, modified and/or damaged components may cause a fire.

In the event of an accident or impact to the underbody, components of the high-voltage electrical system may be damaged although the damage is not visible.

- ▶ Never make any modifications to the high-voltage on-board electrical system.
- ▶ Do not switch on or use the vehicle if its high-voltage on-board electrical system components have been modified or damaged.
- ▶ Never touch damaged components of the high-voltage on-board electrical system.
- ▶ After an accident, do not touch any components of the high-voltage on-board electrical system.
- ▶ After an accident, have the vehicle transported away.
- ▶ Have the components of the high-voltage on-board electrical system checked at a qualified specialist workshop and replaced if necessary.

### Requirements

Disconnect the high-voltage on-board electrical system manually only in the following situations:

- The  restraint system warning lamp lights up in the driver's display, e.g. after an accident.
- The vehicle is badly damaged, e.g. after an accident, and the restraint system components have not been triggered.

### Operating the high-voltage disconnect device

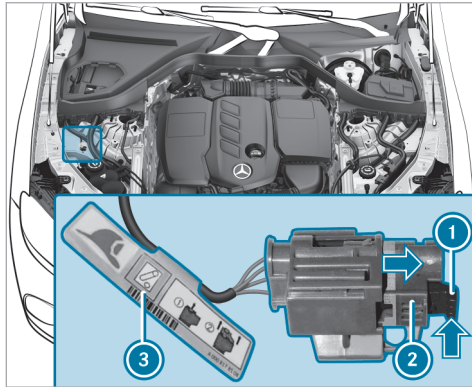

- ▶ Switch off the vehicle.
- ▶ Shift the transmission to position **P**.
- ▶ Apply the electric parking brake.
- ▶ Secure the vehicle against rolling away.
- ▶ Open the hood.

- ▶ Observe additional label **3** on high-voltage disconnect device **2**.
- ▶ Press release tab **1** in the direction of the arrow and pull it out.
- ▶ Pull high-voltage disconnect device **2** in the direction of the arrow until it engages. The high-voltage on-board electrical system is switched off.

All work on the hybrid drive system (including after the high-voltage on-board electrical system has been manually disconnected) may be performed only in a qualified specialist workshop.

### Switching on the power supply or the vehicle

**⚠ WARNING** Risk of accident and injury due to children left unattended in the vehicle

If you leave children unattended in the vehicle, they could, in particular:

- open doors, thereby endangering other persons or road users.

- get out and be struck by oncoming traffic.
- operate vehicle equipment and become trapped, for example.

In addition, the children could also set the vehicle in motion by, for example:

- releasing the parking brake.
- changing the gearbox position.
- starting the vehicle.

- ▶ Never leave children unattended in the vehicle.
- ▶ When leaving the vehicle, always take the key with you and lock the vehicle.
- ▶ Keep the key out of reach of children.

This also applies to the Digital Vehicle Key.

### Requirements

- The key is in the vehicle and is detected.
- **Vehicles with Digital Vehicle Key:** a Digital Vehicle Key with drive authorization is detected.
- The brake pedal is not depressed.

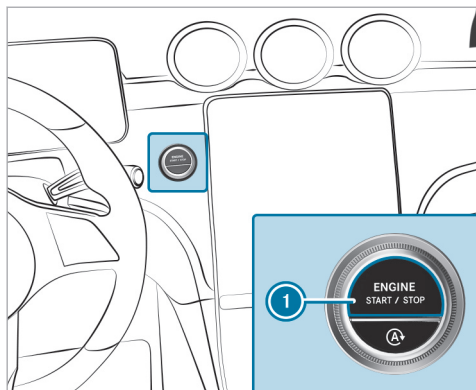

- ▶ **To switch on the power supply:** press button ① once.  
You can, for example, switch on the windshield wiper.

The power supply will be switched off again if the following conditions are met:

- You open the driver's door.
- You press button ① twice more.

- ▶ **To switch on the vehicle:** press button ① twice.  
Indicator and warning lamps will light up on the driver's display.

The vehicle will be switched off again if one of the following conditions is met:

- You do not start the vehicle within 15 minutes and the transmission is in position **P** or the electric parking brake is applied.
- You press button ① once.

### Starting the vehicle

#### Starting the vehicle with the start/stop button

- ⚠ **DANGER** Risk of death caused by exhaust gases

Combustion engines emit poisonous exhaust gases such as carbon monoxide. Inhaling these exhaust gases is hazardous to health and leads to poisoning.

- ▶ Never leave the engine or, if present, the auxiliary heating running in an enclosed space without sufficient ventilation.

- ⚠ **WARNING** Risk of fire due to flammable materials in the engine compartment or on the exhaust system

Flammable materials may ignite.

- ▶ Therefore, regularly check that there are no flammable foreign materials in the engine compartment or on the exhaust system.

#### Requirements

- The key is in the vehicle and is detected.
  - **Vehicles with Digital Vehicle Key:** a Digital Vehicle Key with drive authorization is detected.
- ▶ Shift the transmission to position **P** or **N**.
- ▶ depress the brake pedal and press button ① once.



- ▶ If the vehicle does not start: switch off non-essential consumer equipment and press button ❶ once.
- ▶ If the vehicle still does not start and the **Place the Key in the Marked Space See Operator's Manual** display message appears on the driver's display: start the vehicle with the key in the marked space (emergency operation mode) (→ page 167).

- ❶ You can switch off the vehicle while driving. To do this, press and hold button ❶ for about three seconds or press button ❶ three times within three seconds. Be sure to observe the safety notes concerning this under "Driving tips" (→ page 171).

Observe any information regarding display messages that may be shown on the driver's display.

### ■ Start the vehicle with the Digital Vehicle Key in the marked space (emergency operation mode)

#### Requirements

- The vehicle is equipped with the "Digital Vehicle Key" pre-installation.

- A suitable end device is activated as a Digital Vehicle Key.
- ❶ Mercedes-Benz recommends that you carry the emergency key in case of function restrictions.

If the vehicle does not start and the **Searching for Key in Stowage Tray or Digital Vehicle Key in Inductive Charging Bracket...** See Operator's Manual display message appears on the driver's display, you can start the vehicle in emergency operation mode.

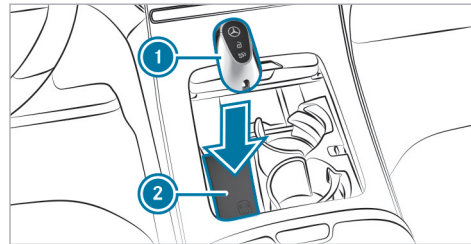

- ▶ Place key ❶ in stowage compartment ❷.

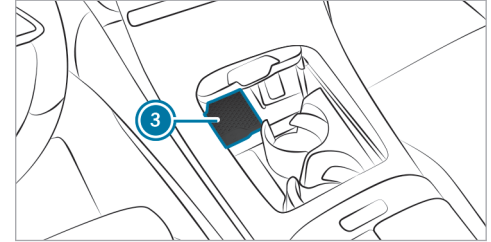

- ▶ Place the Digital Vehicle Key in marked space ❸.
- ▶ Depress the brake pedal and start the vehicle using the start/stop button. It may take a few seconds until the vehicle starts.
- ▶ When the **Key Not Detected** display message appears on the driver's display, press the Start/Stop button again.

### ■ Starting the vehicle with the key in the marked space (emergency operation mode)

If the vehicle does not start and the **Place the Key in the Marked Space See Operator's Manual** display message appears on the driver's display,

you can start the vehicle in emergency operation mode.

**Vehicles with Digital Vehicle Key:** If the vehicle does not start and the [Searching for Key in Stowage Tray or Digital Vehicle Key in Inductive Charging Bracket...](#) See [Operator's Manual](#) display message appears on the driver's display, you can start the vehicle in emergency operation mode.

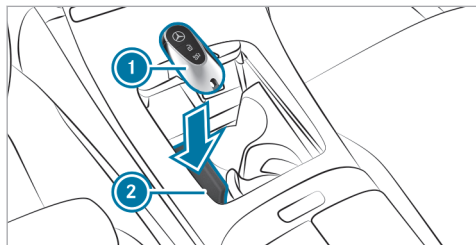

- ▶ Make sure that marked space ② is empty.
  - ▶ Remove key ① from the key ring.
  - ▶ Place key ① on the symbol in marked space ②.
- The vehicle will start after a short time.

If you remove key ① from marked space ②, the vehicle can still be driven. For further engine starts, however, key ① must be located on the symbol in marked space ② during the entire trip.

- ▶ Have key ① checked at a qualified specialist workshop.

#### If the vehicle does not start:

- ▶ Place key ① in marked space ② and leave it there.
- ▶ Depress the brake pedal and start the vehicle using the start/stop button.

① You can switch on the power supply or the vehicle with the start/stop button.

Observe any information regarding display messages that may be shown on the driver's display.

## Starting the vehicle via Remote Online Services

### Cooling or heating the vehicle interior before starting the journey

Ensure the following before starting the engine:

- The legal stipulations in the area where your vehicle is parked allow engine starting via smartphone.
- It is safe to start and run the engine where your vehicle is parked.
- The fuel tank is sufficiently full.
- The starter battery is sufficiently charged.

### Charging the starter battery before starting the journey

You can receive a message on your smartphone when the state of charge of the starter battery is low. You can then start the vehicle with the smartphone to charge the battery. The vehicle is automatically switched off after ten minutes.

Ensure the following before starting the engine:

- The legal stipulations in the area where your vehicle is parked allow engine starting via smartphone.

- It is safe to start and run the engine where your vehicle is parked.
- The fuel tank is sufficiently full.

### Starting the vehicle (Remote Online)

**⚠ WARNING** Risk of crushing or entrapment due to unintentional starting of the engine

Limbs could be crushed or trapped if the engine is started unintentionally during service or maintenance work.

- ▶ Always secure the engine against unintentional starting before carrying out maintenance or repair work.



#### Requirements

- park position **P** is selected.
- the anti-theft alarm system is not activated.
- the panic alarm is not activated.
- the hazard warning light system is switched off.
- the hood is closed.
- the doors are closed and locked.
- the windows and sliding sunroof are closed.

- ▶ Start the vehicle using the smartphone. After every vehicle start, the engine runs for ten minutes.

You can carry out a maximum of two consecutive starting attempts. You must start the vehicle with the key before trying to start the vehicle again with the smartphone.

You can switch off the vehicle at any time as follows:

- Via the smartphone app
- By pressing the  or  button on the key
- ⓘ Further information can be found in the smartphone app.

#### Securing the engine against starting before carrying out maintenance or repair work:

- ▶ Switch on the hazard warning light system or unlock the doors.
- ▶ Open a side window or the sliding sunroof.

### Notes on breaking-in a new vehicle

To preserve the engine during the first 1000 miles (1500 km):

- Drive at varying road speeds and engine speeds.
- No faster than 85 mph (140 km/h).
- Drive the vehicle in drive mode **C** or **E**.
- Shift to the next higher gear at the very latest when the needle reaches the last third before the red area in the tachometer.
- Do not shift down manually in order to brake.
- Avoid overstraining the vehicle, e.g. driving at full throttle.
- Do not depress the accelerator pedal past the pressure point (kickdown).
- Only increase the engine speed gradually and accelerate the vehicle to full speed after 1000 miles (1500 km).

This also applies when the engine or parts of the drivetrain have been replaced.

Please also observe the following breaking-in notes:

- In certain handling and driving safety systems, the sensors adjust automatically while a certain distance is being driven after the vehicle has been delivered or after repairs. Full system effectiveness is only reached when this teaching-in process has concluded.
- Brake pads, brake disks and tires that are either new or have been replaced achieve optimum braking effect and grip only after the vehicle has been driven several hundred kilometers. Compensate the reduced braking effect by applying greater force to the brake pedal.

### Notes on optimized acceleration

If all necessary requirements and activation conditions are fulfilled, the best possible acceleration can be achieved from a standstill.

Do not use optimized acceleration on public roads. Individual wheels could spin and you could lose control of the vehicle. There is an increased risk of skidding and/or accident.

Be sure to observe the safety notes and information on ESP® (→ page 225).

### Pulling away with optimized acceleration

**⚠ WARNING** Risk of skidding and accidents due to the wheels spinning

If you pull away using optimized acceleration, individual wheels can spin and the vehicle can skid.

There is an increased risk of skidding and accidents, especially when ESP® is switched off!

- ▶ Make sure that there are no persons or obstacles in the vicinity of the vehicle.

### Requirements

- the vehicle is broken in (→ page 169).
- the vehicle and tires are in good condition.
- the roadway has a high-grip surface.
- the engine and transmission are at normal operating temperature.

**!** **NOTE** Increased wear due to optimized acceleration

When pulling away with optimized acceleration, all components of the drivetrain are subjected to a very high load.

This can lead to increased component wear.

- ▶ Do not always pull away with optimized acceleration.

- ▶ Engage the **[D]** drive position (→ page 191).
- ▶ Move the steering wheel to the straight-ahead position.
- ▶ Select the drive program **[S]** (→ page 187).
- ▶ Deactivating ESP® (→ page 226).
- ▶ Depress and hold the brake pedal firmly with your left foot.
- ▶ With your right foot, fully depress the accelerator pedal.

- ▶ After no more than five seconds, take your left foot quickly off the brake, but keep the accelerator pedal depressed. The vehicle will pull away at maximum acceleration.
- ▶ Switch on ESP® once the acceleration procedure is complete.

#### Ending optimized acceleration

- ▶ Remove your foot from the accelerator pedal.
  - ▶ Reactivate ESP®.
- ⓘ After you pull away with optimized acceleration, components of the drivetrain can become very hot, which means that optimized acceleration values may only be reached again after a few minutes.

#### Notes on driving

**⚠ WARNING** Risk of accident due to objects in the driver's footwell

Objects in the driver's footwell may impede pedal travel or block a depressed pedal.

This jeopardizes the operating and road safety of the vehicle.

- ▶ Stow all objects in the vehicle securely so that they cannot get into the driver's footwell.
- ▶ Always install the floor mats securely and as prescribed in order to ensure that there is always sufficient room for the pedals.
- ▶ Do not use loose floor mats and do not place floor mats on top of one another.

**⚠ WARNING** Risk of accident due to incorrect footwear

Incorrect footwear includes, for example:

- Shoes with platform soles
- Shoes with high heels
- Slippers

There is a risk of an accident.

- ▶ Always wear suitable footwear so that you can operate the pedals safely.

**⚠ WARNING** Risk of accident if the vehicle is switched off while driving

If you switch off the vehicle while driving, safety functions are restricted or no longer available.

This may affect the power steering system and the brake force boosting, for example.

You will need to use considerably more force to steer and brake, for example.

- ▶ Do not switch off the vehicle while driving.

**⚠ DANGER** Risk of death caused by exhaust gases

Combustion engines emit poisonous exhaust gases such as carbon monoxide. Inhaling these exhaust gases is hazardous to health and leads to poisoning.

- ▶ Never leave the engine or, if present, the auxiliary heating running in an enclosed space without sufficient ventilation.

**⚠ WARNING** Risk of skidding and of an accident due to shifting down on slippery road surfaces

If you shift down on slippery road surfaces to increase the engine braking effect, the drive wheels may lose traction.

- ▶ Do not shift down on slippery road surfaces to increase the engine braking effect.

**⚠ DANGER** Risk of fatal injury due to poisonous exhaust gases

If the tailpipe is blocked or sufficient ventilation is not possible, poisonous exhaust gases such as carbon monoxide may enter the vehicle. This is the case, for example, if the vehicle gets stuck in the snow.

- ▶ Keep the tailpipe and the area around the vehicle free from snow when the engine or the stationary heater is running.

- ▶ Open a window on the side of the vehicle facing away from the wind to ensure an adequate supply of fresh air.

**⚠ WARNING** Risk of accident and injury due to being under the influence of alcohol and drugs while driving

Drinking and driving and/or taking drugs and driving are very dangerous combinations. Even a small amount of alcohol or drugs can affect your reflexes, perceptions and judgment.

The possibility of a serious or even fatal accident are greatly increased when you drink or take drugs and drive.

- ▶ Do not drink or take drugs and drive or allow anyone to drive who has been drinking or taking drugs.

**⚠ WARNING** Risk of accident due to the brake system overheating

If you leave your foot on the brake pedal when driving, the brake system may overheat.

This increases the braking distance and the brake system can even fail.

- ▶ Never use the brake pedal as a footrest.
- ▶ Do not depress the brake pedal and the accelerator pedal at the same time while driving.

**! NOTE** Engine damage due to excessively high engine speeds

The engine will be damaged if you drive with the engine in the overrevving range.

- ▶ Do not drive with the engine in the overrevving range.

**! NOTE** Wearing out the brake linings by continuously depressing the brake pedal

- ▶ Do not depress the brake pedal continuously whilst driving.
- ▶ To use the braking effect of the engine, shift to a lower gear in good time.

**!** **NOTE** Damage to the drivetrain and engine when pulling away

- ▶ Do not warm up the engine while the vehicle is stationary. Pull away immediately.
- ▶ Avoid high engine speeds and driving at full throttle until the engine has reached its operating temperature.

**!** **NOTE** Damage to the catalytic converter due to non-combusted fuel

The engine is not running smoothly and is misfiring.

Non-combusted fuel may get into the catalytic converter.

- ▶ Only depress the accelerator pedal slightly.
- ▶ Have the cause rectified immediately at a qualified specialist workshop.

**!** **NOTE** Reduced battery life due to frequent short-distance trips

The 12 V battery may not be sufficiently charged when the vehicle is used only for short-distance trips. This reduces the life of the battery.

- ▶ Drive longer distances regularly to charge the battery.

**!** **NOTE** Vehicle damage due to failure to observe the maximum permissible clearance height

If the vehicle height exceeds the maximum permissible clearance height, the roof and other vehicle parts may be damaged.

- ▶ Please observe the maximum clearance height indicated.
- ▶ If the vehicle exceeds the permissible clearance height, do not drive in.
- ▶ Take the modified vehicle height into account in the case of roof superstructures or other carrier systems.

**i** Bear in mind that all the speed values stated in this Operator's Manual are approximate and are subject to a certain tolerance.

#### **Notes on driving with a roof load, trailer or fully laden vehicle**

When driving with a loaded roof luggage rack or trailer as well as with a fully laden or fully occupied vehicle, your vehicle's driving and steering characteristics will change.

You should bear the following in mind:

- Do not exceed the permissible roof load and towing capacity. Also observe the information in the Technical Data.
- Distribute the roof load and the load inside the vehicle evenly, placing heavy objects at the bottom. Also comply with the notes on loading the vehicle (→ page 113).
- Drive carefully, and avoid abrupt starts, braking and steering as well as rapid cornering.

#### **Advice on driving on salt-strewn roads**

The braking effect is limited on salt-strewn road surfaces.

You should therefore observe the following notes:

- Salt build-up on the brake disks and brake pads can cause the braking distance to increase considerably or result in one-sided braking.
- Maintain a much greater safety distance to the vehicle in front.

Remove salt build-up as follows:

- Brake occasionally, paying attention to the traffic conditions.
- Carefully depress the brake pedal at the end of a journey and when starting the next journey.

### Notes on hydroplaning

Hydroplaning can take place if a certain depth of water has built up on the road surface.

Observe the following notes during heavy precipitation or in conditions in which hydroplaning may occur:

- Reduce your speed.
- Avoid tire ruts.
- Avoid sudden steering movements.

- Brake carefully.

**i** Also observe the notes on regularly checking wheels and tires (→ page 413).

### Notes on driving through water on the road

Water ingress can damage the engine, electrics and transmission.

Water can also enter the air intake of the engine and cause engine damage.

Observe the following notes if you have to drive through water:

- Observe the maximum permissible depth for driving through water (→ page 454).
- Drive at walking pace at most; water may otherwise enter the vehicle interior or engine compartment.
- Vehicles in front or oncoming vehicles can create waves that may exceed the maximum permissible depth of water.

The braking effect of the brakes is reduced after you have driven through water. Brake carefully, paying attention to the traffic conditions, until braking effect has been fully restored.

### Function of rear axle steering

---

The rear axle steering is an electromechanical auxiliary steering on the rear axle which adjusts the steering of the rear wheels according to the position of the front wheels, depending on the speed. This results in greater maneuverability and improved driving stability for the vehicle.

Rear axle steering has the following characteristics:

- reduced steering effort and turning circle resulting in reduced parking effort
- more direct steering resulting in improved control of the vehicle
- improved cornering of the vehicle

Observe the notes on snow chains and snow chain mode (→ page 414).



### Notes on off-road driving

**⚠ WARNING** Risk of accident if you do not keep to line of fall on inclines

If you drive at an angle or turn on an incline, the vehicle could slip sideways, tip and roll-over.

- ▶ Always drive on inclines in the line of fall (straight up or down) and do not turn.

**⚠ WARNING** Risk of fire caused by flammable material on hot exhaust system components

Flammable material such as leaves, grass or twigs may ignite if they come into contact with hot parts of the exhaust system.

- ▶ When driving on an unpaved road or off-road, check the vehicle underside regularly.
- ▶ In particular, remove trapped plant parts or other flammable material.
- ▶ If there is damage, consult a qualified specialist workshop immediately.

When driving off-road, sand, mud and water or water mixed with oil may get into the brakes. This may lead to a reduction in braking effect or total brake failure as a result of increased wear. The braking characteristics will vary depending on the material that has entered the system. Clean the brakes after driving off-road. If you then notice reduced braking effect or hear scraping noises, have the brake system checked at a qualified specialist workshop. Adapt your driving style to the changed braking characteristics.

**! NOTE** Damage caused by driving over obstacles

The vehicle can be damaged by:

- Driving onto high curbs or unpaved roads.
  - Quickly driving over obstacles such as curbs, speed bumps or potholes.
  - Heavy objects hitting the underbody or chassis components.
- ▶ Do not drive over obstacles that could damage the vehicle.

- ▶ Check the vehicle regularly for damage during off-road driving.
- ▶ Adjust the vehicle speed to suit the road surface conditions.
- ▶ If there is damage, consult a qualified specialist workshop immediately.

**🔥 ENVIRONMENTAL NOTE** Environmental damage due to non-observance of prohibition signs

Environmental protection has priority. Treat nature with respect.

- ▶ Be sure to observe prohibition signs.

- ① The vehicle is designed for easily negotiable and moderate off-road terrain. When driving off-road, make sure there is sufficient ground clearance. The high-voltage battery in particular can be damaged by bottoming out or by impacts against the underbody. Please also observe the notes on operating safety (→ page 25).

### Checklist before driving off-road

Check the following points before driving off-road:

- Fuel level
- Engine oil level: fill engine oil to the maximum level to ensure full gradeability (→ page 376).
- Tire-change tool kit and spare wheel
- Tires and wheels

 Further information about special all-terrain tires for retrofitting can be obtained from a qualified specialist workshop.

The off-road menu in the multimedia system can support you when driving off-road. Familiarize yourself with its displays and equipment-dependent setting options before driving off-road (→ page 339).

### Off-road driving

Read this section before driving your vehicle off-road. Practice by driving over more gentle off-road terrain first.

- Observe the notes on the cross-country ABS (→ page 224).

- Select the  (→ page 187) drive program before driving off-road.
- Always keep the engine running and in gear when driving on downhill gradients and slopes. Observe the notes on driving in mountainous terrain.
- Do not drive on unknown terrain that is not easily visible and stay on marked routes.
- Always keep the doors and windows closed while the vehicle is in motion.
- Deactivate Active Distance Assist DISTRONIC and cruise control.
- Adapt your driving style to the terrain.
- Do not use the HOLD function on steep downhill or uphill gradients with slippery or loose surfaces.

### Driving on sand

When driving on sand, also observe the following instructions:

- Select a higher vehicle level.
- Shift to a lower gear.

- Drive quickly to overcome the rolling resistance. Otherwise the vehicle's wheels could become stuck in loose ground.
- Drive in the tracks of other vehicles if possible. Make sure that the following prerequisites are met:
  - The tire ruts are not too deep.
  - The sand is firm enough.
  - The ground clearance is sufficient.

### Fording

Also observe the following information when fording:

- Drive no faster than 6 mph (10 km/h).
- Observe the maximum permissible fording depth (→ page 454).
- Switch off automatic climate control (→ page 155).
- Ensure that a bow wave does not form as you drive.
- Do not stop in the water and do not switch off the engine. Ensure the ECO start/stop function is switched off (→ page 178).

### Driving in mountainous terrain

Also observe the following information when driving in mountainous terrain:

- Observe the values of the angle of approach/ departure and of the maximum gradient climbing ability (→ page 454).
- Avoid high engine speeds.
- Use the braking power of the engine when driving downhill.
- Shift to a lower gear on uphill gradients and on long, steep downhill gradients.
- Activate DSR before driving downhill, if necessary (→ page 241).

### Checklist after driving off-road

Driving off-road places greater demands on your vehicle than driving on normal roads. Check the entire vehicle for damage and foreign bodies every time after driving off-road. Foreign bodies in the wheels or drivetrain can lead to imbalances and therefore vibrations.

- If the  driving mode is selected: select another driving mode.
- Deactivate DSR.

- Lower the vehicle level again to a level suitable to the road conditions, e.g. to the normal level.
- Apply the brakes to dry them after fording.
- Check that the service brake is working normally after a long downhill stretch.
- Clean the following components every time after driving off-road:
  - license plate number
  - headlamps and tail lamps
  - tires, wheels and wheel arches
  - underbody
- After driving through sand, mud, water or gravel, have the following components checked and cleaned:
  - brake disks and brakepads
  - tires and wheels
  - axle joints

### ECO start/stop function

#### ■ ECO start/stop function

- ❗ **Plug-in hybrid:** the function is not available.
- ❗ Depending on the engine, the ECO start/stop function is not available in all drive programs. Observe the status display in the driver's display for this.

The engine will be switched off automatically in the following situations if all vehicle conditions for an automatic engine stop are met:

- You brake the vehicle to a standstill in transmission position **D** or **N**.
- You depress the brake pedal when traveling at a low speed.

If the system has detected one of the following situations, the engine will not stop:

- You stop at a stop sign and there is no vehicle in front of you.
- The vehicle that stopped in front of you sets off again.
- You maneuver, turn the steering wheel sharply or engage reverse gear.

- ① If the system detects an intelligent stop inhibitor, e.g. a stop sign, the engine will not stop. If you activate the HOLD function or engage park position **P**, the engine can be switched off in spite of an intelligent stop inhibitor.

The engine will restart automatically in the following cases:

- You engage transmission position **D** or **R**.
- You depress the accelerator pedal.
- The vehicle requires an automatic engine start.
- You release the brake pedal.
- You release the brake pedal on a downhill gradient and the vehicle does not roll.
- The vehicle rolls on a downhill gradient and does not automatically enter glide mode at 15 mph (20 km/h).

ECO start/stop function symbols on the driver's display:

- The **A** symbol (green) appears when the vehicle is at a standstill: the engine was switched off by the ECO start/stop function.

- The **A** symbol (yellow) appears when the vehicle is at a standstill: not all vehicle conditions for an engine stop have been met.
- Neither the **A** symbol nor the **A** symbol appears when the vehicle is at a standstill: an intelligent stop inhibitor, e.g. a stop sign, has been detected.
- The **A<sup>OFF</sup>** symbol appears: the ECO start/stop function is deactivated or there is a malfunction.

If the engine was switched off by the ECO start/stop function and you leave the vehicle, a warning tone will sound and the engine will not be restarted. In addition, the following display message will appear on the driver's display:

#### Vehicle is Ready to Drive Switch Off Vehicle Before Exiting

If you do not switch off the vehicle, it will automatically be switched off after three minutes.

### Switching the ECO start/stop function on/off

**!** **NOTE** Mercedes-AMG vehicles

▶ Observe the notes in the Supplement. You could otherwise fail to recognize dangers.

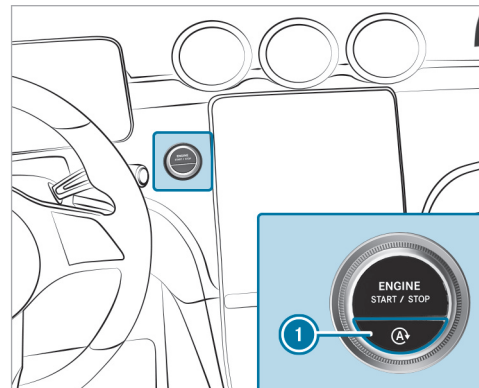

- ▶ Press button ①.  
A display will appear on the driver's display when you switch the ECO start/stop function on/off.

- ①  will be continuously shown on the driver's display while the ECO start/stop function is deactivated.

### ECO display function

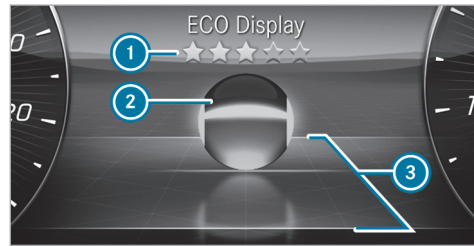

The ECO display shows an evaluation of your driving style on the driver's display depending on the situation. This enables you to check the efficiency of your driving style and adjust it if necessary. The **ECO Display** menu shows ball ② that will roll for-

wards or backwards on a stylized road in the direction of travel according to the driving characteristics.

Above and below the road, lines mark the area for an efficient driving style ③. Ball ② will light up in green if it is rolling within these lines. Outside the lines, the ball will light up in orange.

The ECO display assesses the following criteria for an economical driving style:

- coasting at the right times
- consistent speed
- moderate acceleration

The overall assessment of your driving style "from start" is indicated using stars ①. It starts with five empty stars, which you can fill one after the other if you drive efficiently. When all five stars are filled, a glow will appear in the background.

- ① You can call up the **ECO Display** function via the **Classic** menu (→ page 302).

### ECO Assist function (vehicles with 48 V on-board electrical system)

For plug-in hybrids, note the ECO Assist information (→ page 182).

- ① ECO Assist is active only in drive programs **E** and **C**.

ECO Assist analyzes data for the vehicle's expected route. This allows the system to optimally adjust the driving style for the route ahead, save fuel and recuperate. If the system detects an event ahead and the vehicle nears the event, ECO Assist will calculate the optimum speed for maximum fuel economy and recuperative energy based on the distance, speed and downhill gradient.

If the deceleration provided by ECO Assist is not sufficient, you must also brake with the service brake. This is especially the case if, for example, you pull away again in slow-moving traffic and the distance to the vehicle in front is very short.

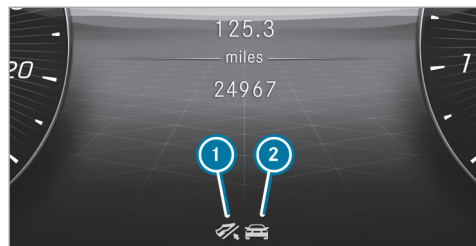

- ① "Foot off the accelerator" recommendation
- ② Route event ahead







If a route event ahead or a vehicle driving in front is detected which requires an adjustment to your driving style to ensure greater efficiency, corresponding symbol ① and the  symbol will be displayed in gray.

If you release the accelerator pedal, the  symbol will turn green and recuperation in overrun mode will be initiated. If the deceleration is not sufficient, also apply the service brake. If ECO Assist intervenes for a route event ahead (not for a vehicle in front) and you then press the accelerator pedal again, you end ECO Assist's control.

The ECO Assist display is hidden again in the following cases:

- You do not react to the ECO Assist recommendation for a long time.
- You press the accelerator pedal while ECO Assist is intervening for a route event ahead (not for a vehicle in front).
- ECO Assist cannot identify any further recommendations from the route ahead.

In addition to a vehicle in front , ECO Assist can detect the following route events ② depending on the vehicle's equipment:

-  Traffic circle
-  Sharp bend
-  Intersection
-  T-intersection
-  Downhill gradient
-  Speed limit

- ① In drive program , ECO Assist reacts only to the "Vehicle in front" route event .

### System limits

If the calculated route is adhered to when route guidance is active, ECO Assist will operate with greater accuracy. The basic function is also available without active route guidance. Not all information and traffic situations can be foreseen. The quality depends on the map data.

ECO Assist is only an aid. The driver is responsible for keeping a safe distance from the vehicle in front, for vehicle speed and for braking in good time.

The system may be impaired or may not function in the following situations:

- If there is poor visibility, e.g. due to insufficient illumination of the road, highly variable shade conditions, rain, snow, fog or heavy spray.
- If there is glare, e.g. from oncoming traffic, direct sunlight or reflections.
- If the windshield is dirty in the vicinity of the multifunction camera.
- If the multifunction camera is fogged up, damaged or obscured.

- If road signs are hard to detect, e.g. due to dirt, snow or insufficient lighting, or because they are obscured.
- If the digital road map of the navigation system has incorrect or outdated information.
- If signs are ambiguous, e.g. road signs in roadworks or in adjacent lanes.
- If the radar sensors are dirty or obscured.
- When you drive on roads with steep uphill or downhill gradients.
- If there are narrow vehicles in front, such as bicycles or motorcycles.

### Regenerative brake system (plug-in hybrid)

#### Function of the regenerative brake system

Depending on the selected recuperation level, the electric motor is operated as an alternator when in overrun mode and during braking in order to charge the high-voltage battery while driving. As soon as you take your foot off the accelerator pedal when the vehicle is in motion and in transmission position **D**, recuperation in overrun mode is initiated.

The higher the recuperation, the more sharply the vehicle is braked when coasting and the more electrical energy is fed into the high-voltage battery.

The deceleration in overrun mode may not be sufficient depending on the driving conditions. Decelerating to a standstill is not possible. Also brake with the service brake if necessary. Always adapt your speed to the driving conditions and keep a sufficient distance.

The recuperative brake system has the following characteristics:

- supports braking with electronically controlled brake force boosting
  - converts the kinetic energy of the vehicle into electric energy
- i** If you brake hard, the mechanical brake is also used. This means that the maximum recuperative energy cannot be recovered. The more you drive and brake in an anticipatory manner, the more efficiently energy can be recuperated.

#### System limits

The braking effect of the electric motor during recuperation in overrun mode may be reduced or may not be available at all in the following situations:

- when the high-voltage battery charge level increases
- if the high-voltage battery is not yet at a normal operating temperature

In these cases, the desired deceleration is set by the brake control system.

#### Manually setting recuperative deceleration

**!** NOTE Mercedes-AMG vehicles

► Observe the notes in the Supplement. You could otherwise fail to recognize dangers.

- i** In drive programs **H**, **B** and **EL**, you can use the steering wheel paddle shifters to adjust the intensity of recuperation in overrun mode.

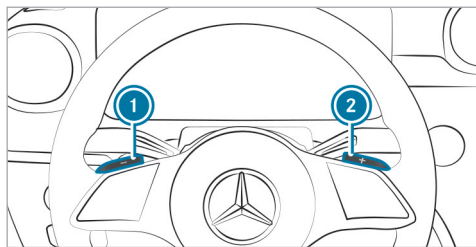

The following recuperation levels are available:

- **D** **AUTO** Intelligent and anticipatory recuperation with ECO Assist (→ page 182)
- **D** **+** No recuperation: the vehicle rolls freely
- **D** Normal recuperation
- **D** **-** Increased recuperation: powerful deceleration in overrun mode, e.g. for driving downhill

Standard setting:

- **D** **AUTO**: if the ECO Assist function is activated in the multimedia system (→ page 184).
- **D**: if the ECO Assist function is deactivated in the multimedia system.

- **D** **AUTO** will be available only if the ECO Assist function is activated in the multimedia system and if the function of the radar sensors is not impaired. Also observe the information on vehicle sensors and cameras (→ page 222).

▶ **To increase recuperation:** briefly pull paddle shifter **1**.

▶ **To reduce recuperation:** briefly pull paddle shifter **2**.

▶ **Standard setting:** pull and hold paddle shifter **1** or **2** or engage transmission position **D** again.

- When the vehicle is started again, the standard setting will also be set.

The driver's display shows the currently selected recuperation level next to the transmission position display.

### ECO Assist (plug-in hybrid)

#### ECO Assist function

- The following function depends on the equipment and the country.

ECO Assist analyzes data for the vehicle's expected route. This allows the system to help optimally adjust your driving style for the route ahead, save fuel and recuperate. If the system detects an event ahead and the vehicle nears the event, ECO Assist will calculate the optimum speed for maximum fuel economy and recuperative energy based on the distance, speed and downhill gradient.

If the deceleration provided by ECO Assist is not sufficient, you must also brake with the service brake. This is especially the case if, for example, you pull away again in slow-moving traffic and the distance to the vehicle in front is very short.

The function is active under the following conditions:

- The function is activated in the multimedia system (→ page 184).
- The **D** **AUTO** recuperation level is selected (→ page 181).
- **M** manual gearshifting is not activated.
- Drive program **S** or  is not selected.



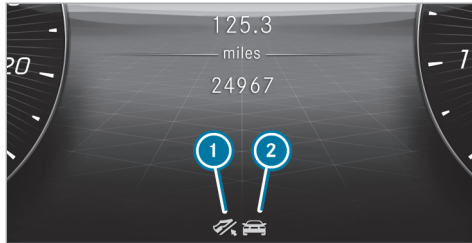

- ① "Foot off the accelerator" recommendation
- ② Route event ahead

If a route event that can be dealt with more efficiently by adjusting your driving style is detected ahead, corresponding symbol ② and the  symbol will be displayed in gray.







If you release the accelerator pedal, the  symbol will turn green and recuperation in over-run mode will be initiated. If the deceleration is not sufficient, also apply the service brake.

If ECO Assist makes adjustments for a route event ahead and you step on the accelerator pedal, ECO Assist control is terminated. This does not apply in the case of a vehicle in front.

The ECO Assist display is hidden again in the following cases:

- You do not react to the ECO Assist recommendation for a long time.
- You press the accelerator pedal while ECO Assist is intervening for a route event ahead. This does not apply in the case of a vehicle in front.
- ECO Assist cannot identify any further recommendations from the route ahead.

In addition to a vehicle in front , ECO Assist can detect the following route events ② depending on the vehicle's equipment:

-  Traffic circle
-  Sharp bend
-  Intersection
-  T-intersection
-  Downhill gradient
-  Speed limit

### System limits

If the calculated route is adhered to when route guidance is active, ECO Assist will operate with greater accuracy. The basic function is also available without active route guidance. Not all information and traffic situations can be foreseen. The quality depends on the map data.

ECO Assist is only an aid. The driver is responsible for keeping a safe distance from the vehicle in front, for vehicle speed and for braking in good time.

The system may be impaired or may not function in the following situations:

- If there is poor visibility, e.g. due to insufficient illumination of the road, highly variable shade conditions, rain, snow, fog or heavy spray.
- If there is glare, e.g. from oncoming traffic, direct sunlight or reflections.
- If the windshield is dirty in the vicinity of the multifunction camera.
- If the multifunction camera is fogged up, damaged or obscured.

- If road signs are hard to detect, e.g. due to dirt, snow or insufficient lighting, or because they are obscured.
- If the digital road map of the navigation system has incorrect or outdated information.
- If signs are ambiguous, e.g. road signs in roadworks or in adjacent lanes.
- If the radar sensors are dirty or obscured.
- When you drive on roads with steep uphill or downhill gradients.
- If there are narrow vehicles in front, such as bicycles or motorcycles.

### ■ Activating or deactivating ECO Assist

Multimedia system:



→  ► Settings ► Assistance  
► Driving

- Activate or deactivate the function.

### Function of the route-based operating-mode strategy (plug-in hybrid)

 The following function is country-dependent and available only in conjunction with an integrated navigation system.

The route-based operating-mode strategy is active under the following conditions:

- Drive program  is selected .
- The **Route Based** option is selected for drive program  in the **DYNAMIC SELECT** menu (→ page 187).
- Route guidance is active.
- The state of charge of the high-voltage battery is sufficient.

If the function is active, data on the further course of the route is evaluated. This includes e.g. road type, speed limitations and altitude data.

The hybrid system then adapts the operating strategy to the further course of the route:

- Use of electrical energy and the combustion engine are adapted.

- State of charge of the high-voltage battery is controlled accordingly.
- Electrical energy is reserved especially for electric mode, e.g. urban route sections or low emission zones.
- The vehicle automatically selects the operating mode.

### Function of the haptic accelerator pedal (plug-in hybrid)

The haptic accelerator pedal has an additional pressure point followed by increased pedal resistance to help you drive in all-electric mode.

Characteristics of the additional pressure point:

- Available only in drive program 
- Is used when the electric motor power availability display (POWER) is full
- Indicates the maximum available electric performance

The subsequently increased pedal resistance indicates that the journey is being continued with the combustion engine.

**DYNAMIC SELECT****Function of DYNAMIC SELECT****!** NOTE Mercedes-AMG vehicles

- ▶ Observe the notes in the Supplement. You could otherwise fail to recognize dangers.

DYNAMIC SELECT makes the quick selection of a drive program possible in accordance with the current driving situation or the desired vehicle characteristics. You can select from the following drive programs.

**i** Depending on the engine and equipment, the vehicle has different drive programs.

The drive program selected appears in the driver's display.

**I\*** Individual

- Individual settings (→ page 187)
- Individual settings (plug-in hybrid)

**S** Sport

- The maximum drive output is available

- Sporty driving
- Sporty, but with an emphasis on stability
- Enables a sporty driver to adopt a more active driving style
- Only suitable for good road conditions, a dry road surface and a clear stretch of road

**H** Hybrid (plug-in hybrid)

- Comfortable and economical driving
- Balance between traction and stability
- Recommended for all road conditions
- Full development of all intelligent hybrid functions
- Adjustable recuperation in overrun mode
- The selection of the matching drive type by the hybrid system depends on the driving conditions and the distance

**C** Comfort

- Comfortable and economical driving
- Balance between traction and stability
- Recommended for all road conditions

**EL** Electric (plug-in hybrid)

- Electric mode – driving without the combustion engine is possible up to approx. 87 mph (140 km/h)
- Adjustable recuperation in overrun mode
- Adaptation of Active Distance Assist DISTRONIC for electric mode
- Depending on the equipment, the maximum set speed for cruise control and Active Distance Assist DISTRONIC can be limited to the maximum electrically drivable speed
- Activation of the combustion engine via the pressure point of the accelerator pedal (kick-down)

**B** Battery Hold (plug-in hybrid)

- Prioritized maintenance of the state of charge of the high-voltage battery, e.g. for subsequent journeys in the inner city/low emission zones
- The selection of the matching drive type by the hybrid system depends on the driving conditions and the distance
- Adjustable recuperation in overrun mode

**E** Eco

- Particularly economical driving
- Balance between traction and stability
- Recommended for all road conditions

 Offroad

- For driving off-road, e.g. on dirt tracks, loose surfaces, gravel or sand, as well as on difficult, uneven terrain, where there are no firm road surfaces and over rocky terrain
- Intervenes later if there is oversteering or understeering, thus improving traction
- Not suitable for use on public roads
- Can be selected up to a maximum of 62 mph (100 km/h)
- From 68 mph (110 km/h): switches to **C**
- **Plug-in hybrid:**
  - from 68 mph (110 km/h): switches to **H** and lowers the vehicle to normal level
  - driving in hybrid or electric mode, depending on a sufficient condition of charge of

the high-voltage battery and the setting in the multimedia system (→ page 187)

- i** The ESP® settings in drive programs **E** and **C** are designed for stability. Therefore, choose one of these drive programs especially when transporting roof loads, in trailer operation and when the vehicle is fully loaded or fully occupied.

**Plug-in hybrid:** this also applies for drive programs **H**, **EL** and **B**.

Depending on the drive program, the following systems will change their characteristics:

- Drive
  - engine and transmission management
  - Active Distance Assist DISTRONIC
  - availability of Glide mode
- ESP®
- Steering

Notes on the roof load display

Certain drive programs and ESP® settings are unsuitable for transporting a roof load.

If one of these drive programs is set or selected, the  symbol is shown as a warning. When this symbol is shown, the selected drive program is not suitable for transporting a load on the roof.



The following drive programs are affected:

- Drive program **S** Sport
- Drive program **I\*** Individual with the ESP® setting Sport

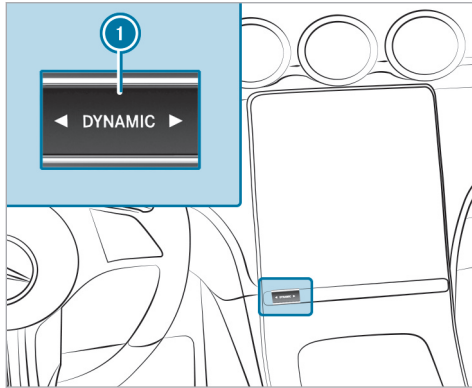
## Selecting the drive program



- ▶ Press DYNAMIC SELECT button ① on the left or right. The drive program selected appears in the driver's display.

- ① In drive program , some driving systems are restricted in their function or not available. When selecting drive program , a

confirmation prompt therefore appears on the central display before the drive program is activated.

- ① **Plug-in hybrid:** in drive program , you can switch between hybrid and electric mode via the multimedia system (→ page 187).

## Configuring DYNAMIC SELECT in the multimedia system

Multimedia system:

- ▶  ▶ Settings ▶ Vehicle
- ▶ DYNAMIC SELECT

### Setting drive program I



- ▶ Select  Individual.
- ▶ Select and set a category.
- ① A sporty ESP mode can be set in conjunction with a sporty suspension mode.

### Setting the H drive program (plug-in hybrid)

- ▶ Select Hybrid.

- ▶ Select **Route Based** or **Standard**.

If route guidance is active and the **Route Based** option has been activated, the electrical energy is distributed intelligently over the entire route. In built-up areas, electric mode is preferred, while on the motorway the combustion engine is used.

With the **Standard** option, the vehicle drives in its standard drive program ( **Electric** or  **Hybrid**). There is no distribution of electrical energy over the entire route. The high-voltage battery is exhausted and the vehicle is then driven by the combustion engine.

### Switching the reset display on/off

- ▶ Switch **Request at Start** on or off.

- ① This function must be activated for each user profile separately. Only when this function is activated will the drive program and ECO start/stop setting for the previous journey be saved for the respective user profile.

**Function on:** the next time the vehicle is started a prompt appears asking whether the last active drive program should be restored. If the ECO start/stop function was deactivated, an additional

prompt appears asking if the function should remain deactivated.

-  The prompt appears only if the previously active settings deviate from the standard settings.

**Function off:** the next time the vehicle is started the  drive program is set automatically. The ECO start/stop function is activated automatically.

#### Switching the reset display on/off (plug-in hybrid)

-  Switch **Request at Start** on or off.

-  This function must be activated for each user profile separately. The drive program for the respective user profile of the last driver is only stored if this function is activated.

**Function on:** the next time the vehicle is started a prompt appears asking whether the last active drive program should be restored.

-  The prompt appears only if the previously active settings deviate from the standard settings.

**Function off (plug-in hybrid):** if the  drive program was the last one active, and all requirements

for the drive program are fulfilled, it will be selected automatically the next time the vehicle is started. If another drive program was active, then the  drive program is set automatically.

#### Displaying vehicle data

Multimedia system:





-  Select **Vehicle**.  
The vehicle data is displayed.

#### Displaying engine data

Multimedia system:







-  Select **Engine**.  
The engine data is displayed.
-  The actual maximum values that can be achieved for engine output and engine torque may deviate from the certified values within the country-specific guidelines for permissible tolerances (basis: UN-ECE No. 85 or country-specific guidelines).

Variables that can influence this are, for example:

- Sea level
- Fuel quality
- Outside temperature
- Operating temperature of the engine

Adjust your driving style accordingly.

The  warning lamp in the driver's display is on until the engine has reached operating temperature.

-  The values displayed serve only as orientation. The values for engine output and engine torque shown on the central display may deviate from the actual values.
-  The  warning lamp to show the power output limitation after starting the vehicle is not available in all vehicle models.

### Calling up the fuel consumption indicator

Multimedia system:



Select **Consumption**.

The current and average fuel consumption will be displayed.

### Automatic transmission

#### DIRECT SELECT lever

##### Function of the DIRECT SELECT lever

**⚠ WARNING** Risk of accident due to incorrect gearshifting

If the engine speed is higher than the idle speed and you engage the transmission position **D** or **R**, the vehicle may accelerate sharply.

▶ If you engage the transmission position **D** or **R** when the vehicle is at a standstill, always depress the brake pedal firmly and do not accelerate at the same time.

**⚠ WARNING** Risk of accident and injury due to children left unattended in the vehicle

If you leave children unattended in the vehicle, they could, in particular:

- open doors, thereby endangering other persons or road users.
- get out and be struck by oncoming traffic.
- operate vehicle equipment and become trapped, for example.

In addition, the children could also set the vehicle in motion by, for example:

- releasing the parking brake.
- changing the gearbox position.
- starting the vehicle.

- ▶ Never leave children unattended in the vehicle.
- ▶ When leaving the vehicle, always take the key with you and lock the vehicle.
- ▶ Keep the key out of reach of children.

Use the DIRECT SELECT lever to switch the transmission position. The current transmission position will be shown on the driver's display.

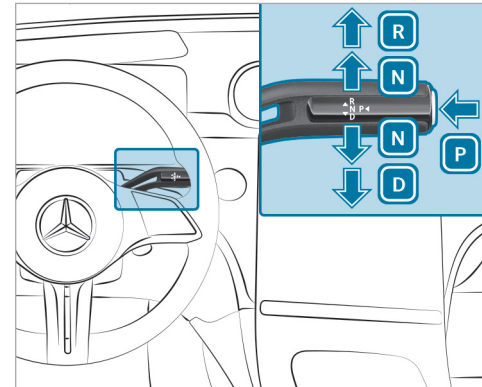

- P** Park position
- R** Reverse gear
- N** Neutral
- D** Drive position

### Engaging reverse gear R

- ▶ Depress the brake pedal and push the DIRECT SELECT lever upwards past the first point of resistance.

### Engaging neutral N

- ▶ Depress the brake pedal and push the DIRECT SELECT lever up or down to the first point of resistance.
- ⓘ To shift into neutral **N** with the vehicle switched on, push the selector lever up or down for several seconds to the first point of resistance.

Subsequently releasing the brake pedal will allow you to move the vehicle freely, e.g. to push it or tow it away.

**Proceed as follows if you want the automatic transmission to remain in neutral **N**, even if the vehicle is switched off or the driver's door is opened:**

- ▶ Depress the brake pedal and engage neutral **N** when the vehicle is at a standstill.
- ▶ Release the brake pedal.
- ▶ Switch off the vehicle.

The **Risk of Vehicle Rolling Away N Activated Manually No Automatic Change to P** message appears in the driver's display.

- ⓘ If you then exit the vehicle leaving the key in the vehicle, the automatic transmission remains in neutral **N**.

The park position **P** is automatically re-engaged as soon as one of the following conditions is met:

- You switch to transmission position **D** or **R**.
- You press the button **P**.

### Engaging park position P

**!** **NOTE** Damage due to engaging park position **P** while the vehicle is rolling

If you shift the transmission into park position **P** while the vehicle is rolling, the transmission may be damaged.

- ▶ If the vehicle is rolling, do not open a door.
- ▶ Only engage park position **P** when the vehicle is stationary.

- ▶ Observe the notes on parking the vehicle (→ page 213).

- ▶ Depress the brake pedal until the vehicle comes to a standstill.

- ▶ When the vehicle is stationary, press button **P**.

When the transmission position display shows **P**, the park position is engaged. If the transmission position display **P** is not shown, apply the parking brake and secure the vehicle to prevent it from rolling away.

- ⓘ Depending on the situation, it may take a short time until **P** is engaged. Therefore, always pay attention to the transmission position display.

Park position **P** will be engaged automatically if one of the following conditions is met:

- You switch the stationary vehicle off in transmission position **D** or **R**.
- You open the driver's door when the vehicle is stationary in transmission position **D** or **R**.



- When the vehicle is rolling, you switch it off in transmission position **D** or **R** and bring it to a standstill.
  - When the vehicle is rolling, you shift to transmission position **N**, bring the vehicle to a standstill and open the driver's door when the vehicle is stationary.
  - Engaging park position **P** automatically is required by the vehicle.
- i** To maneuver with an open driver's door, open the driver's door while the vehicle is stationary and engage transmission position **D** or **R** again.

### Engaging drive position D

- ▶ Depress the brake pedal and push the DIRECT SELECT lever down past the first point of resistance.

When the automatic transmission is in transmission position **D**, it will shift gears automatically. This depends, among other things, on the following factors:

- The selected drive program
- The position of the accelerator pedal

- The driving speed

### Manual gearshifting

#### **!** NOTE Mercedes-AMG vehicles

- ▶ Observe the notes in the Supplement. You could otherwise fail to recognize dangers.

- i** For plug-in hybrids, observe the information regarding the regenerative brake system (→ page 181).

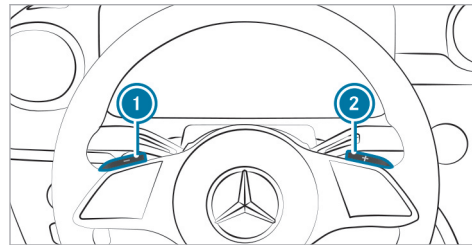

When the automatic transmission is shifted to position **D**, you can manually shift it with the

steering wheel paddle shifter. If permitted, the automatic transmission will shift to a higher or lower gear depending on which steering wheel paddle shifter is pulled.

You have two options for manually shifting the automatic transmission:

- temporary setting
- permanent setting

The gears will shift automatically when manual shifting is deactivated.

#### Temporary setting:

- ▶ **To activate:** pull steering wheel paddle shifter

**1** or **2**.

Manual shifting will be activated for a short time. The transmission position display will show **M** and the current gear.

- i** How long manual shifting stays activated depends on various factors.

Manual shifting can be deactivated automatically in the following cases:

- When the drive program is changed
- When the vehicle is restarted

- When transmission position **D** is engaged again
- Driving style

▶ **To shift up:** pull steering wheel paddle shifter **2**.

▶ **To shift down:** pull steering wheel paddle shifter **1**.

▶ **To deactivate:** pull steering wheel paddle shifter **2** and hold it in place. The transmission position display will show **D**.

**i** You can also activate or deactivate manual shifting permanently in the multimedia system.

### Permanently activating or deactivating manual gearshifting

Multimedia system:

→ **Settings** ▶ **Vehicle** ▶ **Driving**

▶ Permanently switch the function on or off.

### Gearshift recommendation

The gearshift recommendation assists you in adopting an economical driving style.



▶ When gearshift recommendation **1** appears on the driver's display, shift to the recommended gear.

### Using kickdown

▶ **Maximum acceleration:** depress the accelerator pedal beyond the point of resistance.

To protect against engine overrev, the automatic transmission will shift up to the next gear when maximum engine speed has been reached.

### Glide mode function

**!** **NOTE** Mercedes-AMG vehicles

▶ Observe the notes in the Supplement. You could otherwise fail to recognize dangers.

With an anticipatory driving style, Glide mode helps you to reduce fuel consumption.

Glide mode is characterized by the following:

- The combustion engine is switched off depending on the driving situation. All of the vehicle functions remain active.
- Transmission position display **D** is shown in green.

Glide mode is activated if the following conditions are met:

- Drive program **E** is selected.

- The speed is within a suitable range.
- The road's course is suitable, e.g. no steep uphill or downhill inclines or tight bends.
- There is no trailer hitched up to the trailer hitch, and no bicycle rack attached.
- The state of charge of the battery is sufficient.
- You do not depress the accelerator or brake pedal (except for light brake applications).

**i** Glide mode can also be activated if you have selected the "Eco" setting for the drive system in drive program .

Glide mode is deactivated again if one of the conditions is no longer met.

Glide mode can also be prevented by the following parameters:

- Incline
- Downhill gradient
- Temperature
- Height
- Speed
- Operating condition of the engine

- Road and traffic conditions

### Function of the 4MATIC

4MATIC ensures that all four wheels are driven. Together with ESP® and 4ETS, 4MATIC improves the traction of your vehicle whenever a driven wheel spins due to insufficient traction.

If you fail to adapt your driving style, 4MATIC can neither reduce the risk of an accident nor override the laws of physics. 4MATIC cannot take account of road, weather and traffic conditions. 4MATIC is only an aid. You are responsible especially for maintaining a safe distance from the vehicle in front, for vehicle speed, for braking in good time and for staying in lane.

**i** In wintry driving conditions, the maximum effect of 4MATIC can only be achieved if you use winter tires (M+S tires), with snow chains if necessary.

## Refueling

### Refueling the vehicle

**⚠ WARNING** Risk of fire or explosion from fuel

Fuels are highly flammable.

- ▶ Fire, open flames, smoking and creating sparks must be avoided.
- ▶ Before refueling, switch off the vehicle and, if installed, the stationary heater, and leave them switched off during refueling.

**⚠ WARNING** Risk of injury from fuels

Fuels are poisonous and hazardous to your health.

- ▶ Do not swallow fuel or let it come into contact with skin, eyes or clothing.
- ▶ Do not inhale fuel vapor.
- ▶ Keep children away from fuel.

- ▶ Keep doors and windows closed during the refueling process.

If you or other people come into contact with fuel, observe the following:

- ▶ Immediately rinse fuel off your skin with soap and water.
- ▶ If fuel comes into contact with your eyes, immediately rinse them thoroughly with clean water. Seek medical attention immediately.
- ▶ If you swallow fuel, seek medical attention immediately. Do not induce vomiting.
- ▶ Change immediately out of clothing that has come into contact with fuel.

**⚠ WARNING** Risk of fire and explosion due to electrostatic charge

Electrostatic charge can ignite fuel vapor.

- ▶ Before you open the fuel filler cap or take hold of the pump nozzle, touch the metallic vehicle body.
- ▶ To avoid creating another electrostatic charge, do not get into the vehicle again during the refueling process.

**!** **NOTE** Damage caused by the wrong fuel

Vehicles with a gasoline engine:

Even small amounts of the wrong fuel could result in damage to the fuel system, the engine and the emission control system.

- ▶ Refuel only with low-sulfur spark-ignition engine fuel.

This fuel may contain up to 10 % ethanol. Your vehicle is E10-compatible.

Never refuel with one of the following fuels:

- Diesel
- Gasoline with more than 10% ethanol by volume (e.g. E15, E85, E100)

- Gasoline with more than 3% methanol by volume (e.g. M15, M30, M85, M100)
- Gasoline with metallic additives

If you have accidentally refueled with the wrong fuel:

- ▶ Do not switch on the vehicle.
- ▶ Consult a qualified specialist workshop.

**!** **NOTE** Do not use diesel to refuel vehicles with a gasoline engine

If you have accidentally refueled with the wrong fuel:

- Do not switch on the vehicle. Otherwise fuel can enter the engine.

Even small amounts of the wrong fuel could result in damage to the fuel system and the engine. The repair costs are high.

- ▶ Consult a qualified specialist workshop.
- ▶ Have the fuel tank and fuel lines drained completely.

**!** **NOTE** Damage to the fuel system due to overfilling the fuel tank

- ▶ Only fill the fuel tank until the pump nozzle switches off.

If too much fuel has been added due, for example, to a faulty filling pump:

- ▶ Do not switch on the vehicle.
- ▶ Consult a qualified specialist workshop.

**!** **NOTE** Fuel may spray out when you remove the fuel pump nozzle

- ▶ Only fill the fuel tank until the pump nozzle switches off.

#### Requirements

- The vehicle is unlocked.
- **Plug-in hybrid with a gasoline engine:** the fuel tank was vented before refueling (→ page 196).

Observe the notes on service fluids and fuel.

Only refuel with fuel that has at least the octane rating specified in the information label in the fuel filler flap. Otherwise, engine output may be reduced and fuel consumption increased.

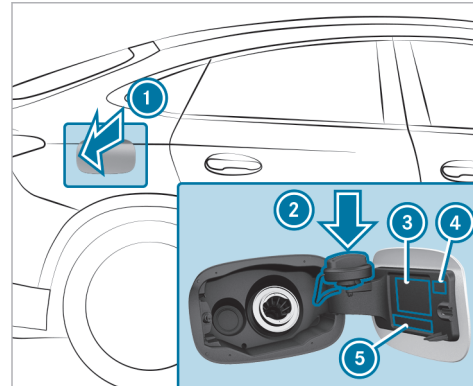

- ① Fuel filler flap
- ② Bracket for fuel filler cap
- ③ Tire pressure table

- ④ QR code for rescue card
- ⑤ Fuel type

⑥ **Plug-in hybrid with a gasoline engine:** the fuel filler flap will open automatically after the fuel tank has been vented (→ page 196).

- ▶ Press the center rear area of fuel filler flap ①.
- ▶ Turn the fuel filler cap counter-clockwise and remove it.
- ▶ Insert the fuel filler cap into bracket ② from above.
- ▶ Completely insert the pump nozzle into the tank filler neck, hook in place and refuel.
- ▶ Only fill the fuel tank until the pump nozzle switches off.
- ▶ Replace the cap on the filler neck and turn clockwise until it engages audibly.
- ▶ Close fuel filler flap ①.

### Depressurizing the fuel tank (plug-in hybrid with gasoline engine)

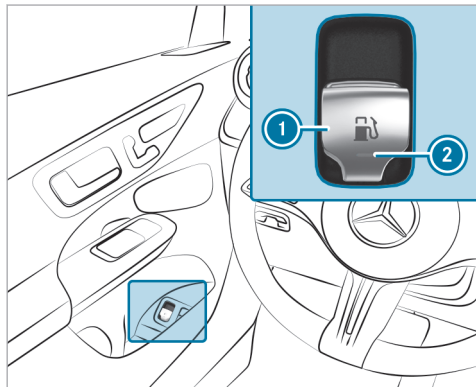

- ▶ Pull switch ① once briefly. Indicator lamp ② will flash and the **Please Wait Depressurizing Fuel Tank** message will appear on the driver's display. When the fuel tank is depressurized, indicator lamp ② will light up continuously.

The **Fuel Tank Is Depressurized Ready for Refueling** message will appear on the driver's display and the fuel filler flap will open automatically.

- ① Depressurizing the fuel tank may take several minutes.

The fuel tank can be depressurized only if the conditions described above are fulfilled. Otherwise, drive the vehicle at least 1/3 mile (0.5 km) and repeat the process.

- ① In the following situations, there is a malfunction:
  - Indicator lamp ② flashes initially and then goes out.
  - The yellow engine diagnostics warning lamp  lights up.

**!** **NOTE** Damage to the fuel filler flap when opening it

If an attempt is made to open a fuel filler flap that is not unlocked, the fuel filler flap or the opening mechanism may be damaged.

- ▶ Only refuel when the fuel filler flap has opened automatically.

### Charging the high-voltage battery (plug-in hybrid)

#### Notes on charging the high-voltage battery

**!** **NOTE** High-voltage battery damage due to leaving the vehicle idle for lengthy periods of time

Lithium-ion batteries experience a natural self-discharge.

Exhaustive discharging can therefore occur if the vehicle is idle for several months. This can damage the high-voltage battery.

- ▶ To avoid damage, please observe the following recommendations when handling the high-voltage battery.

**!** **NOTE** Accelerated aging of the high-voltage battery due to not observing the following recommendations

As a result of its basic characteristics, the storage capacity of and the amount of energy available from the high-voltage battery decreases over the course of its life. Due to this, both the maximum electrical range that can be achieved by the vehicle and its maximum electrical output can be impaired.

The following factors could accelerate the aging of the high-voltage battery:

- A high condition of charge, especially if the vehicle is idle for a lengthy period of time
- Frequent rapid charging with direct current (mode 4)
- Leaving the vehicle idle for lengthy periods at high ambient temperatures

► To avoid accelerated aging, please observe the following recommendations when handling the high-voltage battery.

**!** **NOTE** Damage to the drive system when the high-voltage battery is charged at extreme altitudes

The drive system may be damaged if you charge the high-voltage battery at extreme altitudes more than 13123.36 ft (4000 m) above sea level.

Continuing the journey may then no longer be possible.

► Avoid charging processes at extreme altitudes.

Recommendations when handling the high-voltage battery:

- Charge the high-voltage battery with direct current (mode 4) only if necessary.
- If leaving the vehicle idle for lengthy periods, park up the vehicle with a high-voltage battery charge level between 25% and 30%. Do not keep the high-voltage battery continuously connected to power supply equipment.

- If leaving the vehicle idle for lengthy periods of time avoid, if possible, high ambient temperatures.
- Check the high-voltage battery's charge level every six weeks (→ page 212).
- Charge the high-voltage battery if the charge level is below 15%.
- Do not disconnect the 12 V battery even if the vehicle is left idle for a lengthy period. Otherwise, the condition of the vehicle's high-voltage battery cannot be monitored.
- If the high-voltage battery is used only with low charge levels, fully charge the high-voltage battery every six months.

Depending on the equipment, your vehicle is installed with one of the following vehicle sockets:

- Type 1 for AC charging (mode 2/3)
- Type Combo 1 for AC charging (mode 2/3) and DC charging (mode 4)

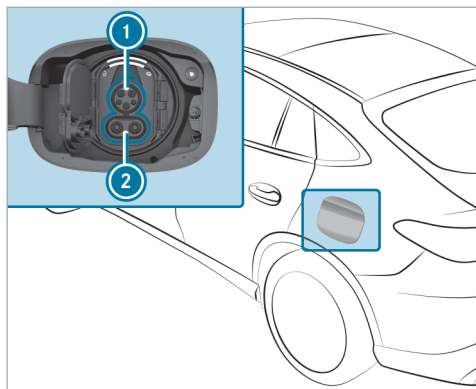

Example: Combo 1 vehicle socket

- ❶ Socket for charging with alternating current
- ❷ Socket extension for charging with direct current
- ❶ **i** When a CCS (Combined Charging System) charging cable is used to charge with direct current, both areas of the vehicle socket are covered by the charging cable connector.

Charging options for the high-voltage battery (mode 2, 3 or 4):

- Charging through recuperation while the vehicle is in motion
- Charging with alternating current when stationary:
  - at a mains socket (mode 2)
  - at a wallbox or charging station (mode 3)
- Charging with direct current when stationary:
  - at a rapid charging station (mode 4)

Depending on the country-specific vehicle equipment and your vehicle's charging cable, single phase AC charging is also possible.

Observe the different grid requirements of your current location when charging. Use only charging cables that conform to the grid requirements. Consult a qualified electrician or your local grid operator if you have any questions.

It is recommended that you charge the high-voltage battery at a wallbox or charging station due to the improved charging performance and better charging efficiency offered.

### System limits

The power output of the high-voltage battery may be impaired by the following:

- High or low outside temperatures
- Electrical auxiliary consumers in the vehicle being switched on, e.g. operating the air conditioning system
- Extended periods without charging

The charging time or charging power of the high-voltage battery may be increased by the following:

- High or low outside temperatures
- A low or high state of charge of the high-voltage battery
- The maximum available charge current of the charging facility

### Stowing the charging cable

Always stow the vehicle's charging cable in the charging cable bag provided, and secure the charging cable bag in the trunk or cargo compartment with the included retaining strap. Otherwise,



the charging cable bag with the charging cable will not be sufficiently secured.



Example: charging cable bag in the trunk/cargo compartment

As delivered, charging cable bag ① with retaining strap ② is located in the trunk or cargo compartment. To secure the charging cable bag, the retaining strap must be attached to cargo tie-

down ring ③. Do not use bag hooks to attach the retaining strap.

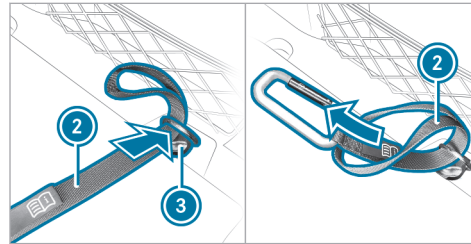

- ▶ Feed the loop end of retaining strap ② through cargo tie-down ring ③ into the trunk or cargo compartment.
- ▶ Feed the end with the snap hook through the loop of retaining strap ②.



- ▶ Tighten retaining strap ② so that the knot around cargo tie-down ring ③ is tight and secure.
- ▶ Hook the snap hook of retaining strap ② in a tie-down eye of charging cable bag ①.

### Notes on charging the high-voltage battery at the mains socket (mode 2)

**⚠ DANGER** Risk of fatal injury from incorrectly installed component parts

Connecting the charging cable to a mains socket using incorrectly installed component parts could cause a fire or an electric shock, for example.

- ▶ Only connect the charging cable to a mains socket that:
  - has been properly installed and
  - has been inspected by a qualified electrician
- ▶ For safety reasons, only use the charging cable supplied with the vehicle or an original Mercedes-Benz charging cable.
- ▶ Purchase these parts at an authorized Mercedes-Benz Center and obtain advice there.

Mercedes-Benz thoroughly tests these original charging cables for their suitability for high-voltage charging of your vehicle.

- ▶ Never use a damaged charging cable.
- ▶ Do not use:
  - extension cables
  - extension reels
  - multiple sockets
- ▶ Never use socket adapters to connect the charging cable to the mains socket. The only exception being if the adapter has been tested and approved by the manufacturer for charging the high-voltage battery of an electric vehicle.
- ▶ Observe the safety notes in the operating instructions for the socket adapter.

Only the following charging cables may be used:

- the charging cable supplied with the vehicle.
- a charging cable that has been approved for the vehicle.

The charging process can vary depending on the power supply equipment. The charging times when charging the high-voltage battery at the mains socket are considerably longer than when charging at a wallbox or charging station.

When doing so, always observe the local information.

Do not leave the charging cable controls hanging loose from a mains socket.

Do not lift the controls by the following component parts:

- the charging cable connector
- the mains plug

When charging, protect the charging cable control element from excessive heat such as direct sunlight. Otherwise, the charging process may be canceled.

### Notes on charging the high-voltage battery at a wallbox or charging station (mode 3)

**⚠ DANGER** Risk of fatal injury from incorrectly installed component parts

Connecting the charging cable to the vehicle using incorrectly installed components could cause a fire or an electric shock, for example.

- ▶ Only connect the charging cable to a wallbox if:
  - The wallbox has been properly installed
  - The wallbox has been inspected by a qualified electrician
  - The charging cable is not damaged
- ▶ Do not extend the charging cable.
- ▶ Do not use adapters.
- ▶ Observe the safety notes in the operating instructions for the wallbox.

**⚠ DANGER** Risk of fatal injury due to damaged components

Connecting the vehicle to a charging station using damaged component parts could cause a fire or an electric shock, for example.

- ▶ Perform a visual check of the charging station for obvious defects, for example damage to the housing or charging cable connection.
- ▶ Never use damaged charging cables.
- ▶ Do not use an extension for the charging cable.
- ▶ Do not use adapters.
- ▶ Always observe the safety instructions on the charging station.

Most charging stations must be activated before the charging process, e.g. using an RFID card or via Plug-and-Charge. Observe the on-site operator's instructions for the charging station and the notes on Mercedes me Charge (see the vehicle's Digital Operator's Manual).

The amount of energy dispensed for the charging process, shown by the charging station, may be higher than the amount of energy actually absorbed by the high-voltage battery. This is the result of different levels of charging losses and is described as recharge efficiency. Charging losses occur, for example, due to heat that builds up when the vehicle is charging or from auxiliary consumers that are switched on. Further information on recharge efficiency can be obtained at a qualified specialist workshop.

### Notes on charging the high-voltage battery at a rapid charging station (mode 4)

**⚠ DANGER** Risk of fatal injury due to damaged components

Connecting the vehicle to a charging station using damaged component parts could cause a fire or an electric shock, for example.

- ▶ Perform a visual check of the charging station for obvious defects, for example damage to the housing or charging cable connection.

- ▶ Never use damaged charging cables.
- ▶ Do not use an extension for the charging cable.
- ▶ Do not use adapters.
- ▶ Always observe the safety instructions on the charging station.

**⚠ DANGER** Risk of fatal injuries when carrying out maintenance work during the charging process

During the charging process, the high-voltage on-board electrical system is under high voltage.

- ▶ Do not perform any maintenance work during the charging process.

Most charging stations must be activated before the charging process, e.g. using an RFID card or via Plug-and-Charge. Observe the on-site operator's instructions for the charging station and the notes on Mercedes me Charge (see the vehicle's Digital Operator's Manual).

The amount of energy dispensed for the charging process, shown by the charging station, may be higher than the amount of energy actually absorbed by the high-voltage battery. This is the result of different levels of charging losses and is referred to as charging efficiency. Charging losses occur, for example, due to heat that builds up when the vehicle is charging or from auxiliary consumers that are switched on. Further information on charging efficiency can be obtained at a qualified specialist workshop.

#### Setting the maximum permissible charging current for charging at a mains socket

**!** **NOTE** Overloading the mains socket due to excessive charging current

If the charging current is too high, the fuse could be tripped or the external mains supply could overheat.

- ▶ Ensure that the external mains supply has been designed to handle the charging current provided.

- ▶ For safety reasons, only use the charging cable supplied with the vehicle or an original Mercedes-Benz charging cable. Mercedes-Benz thoroughly tests these original charging cables for their suitability for high-voltage charging of your vehicle.
- ▶ Purchase these parts at a Mercedes-Benz service center and obtain advice there.
- ▶ Check the maximum charging current using the charging capacity shown on the driver's display.

The charging cable supplied is set to a country-specific maximum charging current value. When charging abroad, the maximum value may exceed the permitted value for that country.

- ▶ Before charging at a mains socket, have the maximum permissible charging current for the relevant mains socket or the building inspected by a qualified electrician.
- ▶ When abroad, observe the country-specific laws when charging.

If you have questions concerning the charging current or if there is a malfunction, please contact a qualified specialist workshop.

### Overview of the charging cable operating unit

The charging cable operating unit shows the current status of the charging process.

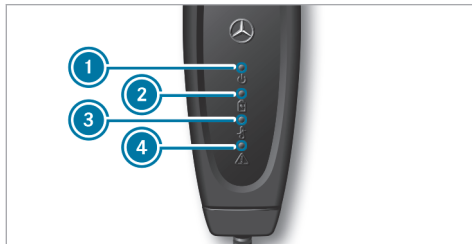

- ① Supply voltage indicator
- ② Charging process indicator
- ③ Temperature monitor indicator
- ④ Safety system indicator

### Supply voltage indicator ①

Display	Meaning
Lights up white	The supply voltage is connected.

### Charging process indicator ②

Display	Meaning
Flashes green	The high-voltage battery is charging.

### Temperature monitor indicator ③

Display	Meaning
Lights up red	The green LED flashes simultaneously: overtemperature – the charging performance is reduced. The green LED does not flash: overtemperature – the charging process is stopped.
Flashes red	Overtemperature at the mains plug – the charging process is stopped.

**Safety system indicator ④**

Display	Meaning
Flashes red	Charging cable malfunction – cannot carry out the charging process, reset the charging cable operating unit.
Lights up red	White LED is off: power supply malfunction – cannot carry out the charging process, replace the mains socket.  White LED is on: vehicle malfunction – cannot carry out the charging process, reset the charging cable operating unit.

When all four displays light up, the charging cable operating unit performs a self-test.

If temperature monitor ③ indicates a malfunction, it may help to protect the charging cable from direct sunlight.

**To reset the charging cable operating unit:** if safety system ④ indicates a charging cable malfunction or a vehicle malfunction, first reset the charging cable operating unit. To do this, disconnect the charging cable from the vehicle and from the mains socket and wait for approximately five seconds. If the malfunction persists after the charging cable is reconnected, charging at the mains socket is not possible. The charging cable must be replaced or the vehicle plug must be checked at a qualified specialist workshop, depending on the indicator.

#### Functions of the indicator lamps on the vehicle socket

The socket flap is centrally locked and unlocked together with the vehicle.

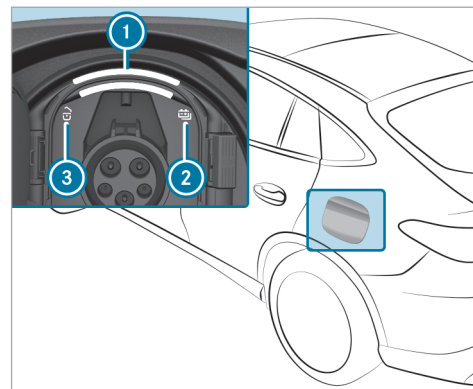



Example: Combo 1 vehicle socket

- ① Socket lamp
- ② Charging process indicator lamp
- ③ Locking status indicator lamp





The upper arch of socket lamp ① is used for the lighting and flashes or lights up as with indicator lamp ③. The lower arch is used for the status

display and flashes or lights up as with indicator lamp ②.

### Overview of the locking status

Locking status ③	Display	Meaning
	Lights up white	Vehicle socket unlocked, insert or remove charging cable
	Flashes white	Malfunction during locking or unlocking

### Overview of the charging process status

Status of the charging process ②	Display	Meaning
	Flashes orange	Connection is being established
	Flashes green	Active energy flow
	Lights up orange (for approx. 60 s)	Interruption in charging
	Lights up green (for approx. 60 s)	Charging process completed
	Flashes red (for approx. 90 s)	Vehicle malfunction; charging is not possible

### Starting the alternating current charging process (mode 2/3)

**⚠ DANGER** Risk of death when charging at a damaged socket

The charging process uses high voltage. If the charging cable, the vehicle socket or the mains socket are damaged, you could receive an electric shock.

- ▶ Only use an undamaged charging cable.
- ▶ Avoid mechanical damage such as crushing, abrading or driving over the cable.
- ▶ Have a damaged vehicle socket replaced at a qualified specialist workshop as soon as possible.
- ▶ Never connect the charging cable to a damaged vehicle socket.

**!** **NOTE** Damage due to overheating of charging cable and charge port

During the charging process, the charging cable and charge port can heat up within the permissible limits.

The permissible limit values are influenced by the following factors:

- the power supply system and the charging cable are not damaged
- the instructions for handling the charging cable and the control element on the charging cable have been observed

▶ If the charging cable or charge port becomes too hot, have the power supply system checked.

**!** **NOTE** Damaged or dirty vehicle socket when the socket flap is open

▶ Always keep the socket cover and the socket flap closed when there is no charging cable connected. This protects the vehicle socket from dirt and damage.

▶ Make sure that the socket cover is closed properly before closing the socket flap. This can otherwise result in damage which may prevent the socket flap from being opened again.

**!** **NOTE** Damage to the vehicle socket or the charging cable connector due to incorrect handling

Do not use excessive force (maximum 67.4 lbf (300 N)) to insert the charging cable connector into the vehicle socket as far as it will go. You may otherwise damage the vehicle socket, the charging cable connector or their contacts.

▶ If you feel there is increased resistance, pull the charging cable connector out of the socket and reinsert it.

#### Requirements

- The transmission is in position **P**.
- The vehicle is unlocked or the vehicle is locked and the distance between the key and the vehicle is no greater than 3 ft (1 m).

- The charging cable is not taut.

Depending on the equipment, your vehicle is installed with one of the following vehicle sockets:

- Type 1 for charging with alternating current (mode 2/3)
- Type Combo 1 for charging with alternating current (mode 2/3) and charging with direct current (mode 4)



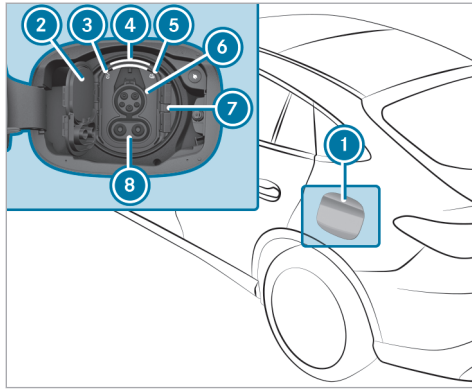

Example: Combo 1 vehicle socket

- ▶ Press the center rear section of socket flap ① and swing the socket flap forwards and open.

The  indicator lamp ③ and upper status display ④ light up white.

- ① Socket flap ① can also be opened via the multimedia system (→ page 337).

If socket flap ① cannot be opened despite the vehicle being unlocked, the charge socket flap can be opened by emergency release (→ page 211).

- ▶ Press catch ⑦ to the right and fold up socket cover ②.
- ① Vehicles with a vehicle socket combo require only connection ⑥ for the charging cable connector. Open only the upper part of socket cover ②.
- ▶ To charge at a mains socket, insert the mains plug into the mains socket of the external power source as far as it will go.
- ▶ Insert the charging cable connector into vehicle socket connection ⑥ to the stop. If the wallbox/charging station is not equipped with a charging cable, insert the plug of the vehicle's charging cable into the wallbox/charging station socket to the stop. Make sure that the charging cable is not taut when inserted.

The  indicator lamp ⑤ and lower status display ④ flash orange and, as soon as the high-voltage battery is charged, green.

When the charging cable is connected to the vehicle, the vehicle cannot be started or moved.

At the start of the charging process, the charge level display is shown in the driver's display with a charging prediction. The charging prediction refers to the time at which the high-voltage battery will be fully charged.

- ① Depending on the temperature, the fan and battery cooling system may audibly switch on during the charging process.
- ① If the vehicle is idle for lengthy periods and connected to the mains supply, the high-voltage battery will be recharged automatically as needed or when electrical consumers are activated (e.g. the pre-entry climate control).

- The vehicle is equipped with an electrical fuse, which protects it against overvoltage in the mains supply. This electrical fuse may trip during severe thunderstorms, for example, and may cause the fuse in the building to trip or may interrupt the charging process. These functions protect the vehicle.

After the fuse in the building is switched on again, the charging process resumes automatically. Following an interruption in the power supply without the fuse in the building being tripped, it may take up to ten minutes for charging to resume automatically.

### Ending the alternating current charging process (mode 2/3)

#### Requirements

- The vehicle is unlocked or the vehicle is locked and the distance between the key and the vehicle is no greater than 3 ft (1 m).

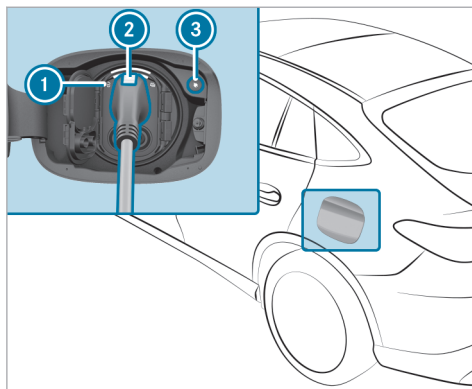



Example: Combo 1 vehicle socket

- Vehicles equipped with a type 1 vehicle socket for AC charging have no charging interruption button ③.



- Combo 1 vehicle socket:** press charging interruption button ②.

The charging process is ended. The  indicator lamp ① lights up white. The vehicle socket is unlocked.

- If charging interruption button ③ is inoperative, you can alternatively unlock the vehicle with the vehicle key or centrally from the inside to terminate the charging process. If the vehicle socket is unlocked for around 30 seconds, the  ① indicator lamp will light up white.
- The charging process can also be ended via the multimedia system for a Combo vehicle socket type (→ page 337).

- Vehicle socket type 1:** Unlock the vehicle with the vehicle key or centrally from the inside. The charging process is ended. The  indicator lamp ① lights up white. The vehicle socket is unlocked.

- Press and hold button ② on the charging cable connector and remove the charging cable connector from the vehicle socket.

- ❗ If you cannot remove the charging cable connector, repeat the unlocking procedure. If the charging cable connector is still locked, contact a qualified specialist workshop.
- ▶ Close the socket cover and the socket flap.
- ❗ After the charging cable connector has been disconnected, the  indicator lamp  on the vehicle socket remains lit for some time before switching off.

### Starting the direct current charging process (mode 4)

**⚠ DANGER** Risk of death when charging at a damaged socket

The charging process uses high voltage.

If the charging cable, the vehicle socket or the mains socket are damaged, you could receive an electric shock.

- ▶ Only use an undamaged charging cable.
- ▶ Avoid mechanical damage such as crushing, abrading or driving over the cable.

- ▶ Have a damaged vehicle socket replaced at a qualified specialist workshop as soon as possible.
- ▶ Never connect the charging cable to a damaged vehicle socket.

**❗ NOTE** Damage due to overheating of charging cable and charge port

During the charging process, the charging cable and charge port can heat up within the permissible limits.

The permissible limit values are influenced by the following factors:

- the power supply system and the charging cable are not damaged
- the instructions for handling the charging cable and the control element on the charging cable have been observed
- ▶ If the charging cable or charge port becomes too hot, have the power supply system checked.

**❗ NOTE** Damaged or dirty vehicle socket when the socket flap is open

- ▶ Always keep the socket cover and the socket flap closed when there is no charging cable connected. This protects the vehicle socket from dirt and damage.
- ▶ Make sure that the socket cover is closed properly before closing the socket flap. This can otherwise result in damage which may prevent the socket flap from being opened again.

**❗ NOTE** Damage to the vehicle socket or the charging cable connector due to incorrect handling

Do not use excessive force (maximum 67.4 lbf (300 N)) to insert the charging cable connector into the vehicle socket as far as it will go. You may otherwise damage the vehicle socket, the charging cable connector or their contacts.

- ▶ If you feel there is increased resistance, pull the charging cable connector out of the socket and reinsert it.

### Requirements

- The transmission is in position **P**.
- The vehicle is unlocked or the vehicle is locked and the distance between the key and the vehicle is no greater than 3 ft (1 m).
- The charging cable is not taut.

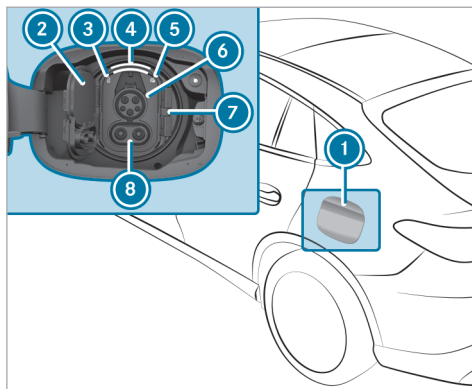

- ▶ Press the center rear section of socket flap **1** and swing the socket flap forwards and open. The indicator lamp **3** and upper status display **4** light up white.
- i** Socket flap **1** can also be opened via the multimedia system (→ page 337).

- ▶ Press catch **7** to the right and fold up socket cover **2**.

**i** The CCS charging cable connector requires connections **6** and **8**. Therefore, it is necessary to open both parts of socket cover **2**.

- ▶ Insert the CCS charging cable connector into the vehicle socket to the stop. Make sure that the charging cable is not taut when inserted.

The indicator lamp **5** and lower status display **4** flash orange and, as soon as the high-voltage battery is charged, green.

When the charging cable is connected to the vehicle, the vehicle cannot be started or moved.

At the start of the charging process, the charge level display is shown in the driver's display with a charging prediction. The charging prediction refers to the time at which the high-voltage battery will be fully charged.

- i** Depending on the temperature, the fan and battery cooling system may audibly switch on during the charging process.



- ❗ If the vehicle is idle for lengthy periods and connected to the mains supply, the high-voltage battery will be recharged automatically as needed or when electrical consumers are activated (e.g. the pre-entry climate control).

### Ending the direct current charging process (mode 4)

#### Requirements

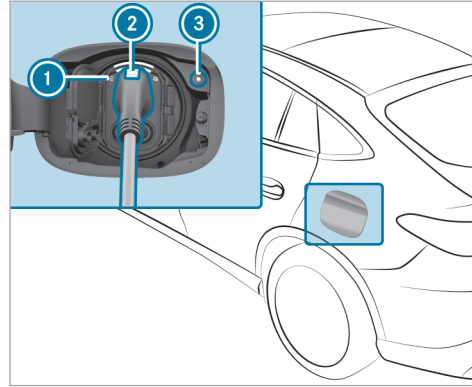
- The vehicle is unlocked or the vehicle is locked and the distance between the SmartKey and the vehicle is no greater than 3 ft (1 m).



- ▶ Press charging interruption button ③. The charging process is ended.  indicator lamp ① will light up white. The vehicle socket will be unlocked.
- ❗ You can alternatively unlock the vehicle with the vehicle SmartKey or centrally from the inside to terminate the charging process only if charging interruption button ③ is inoperative. If  indicator lamp ① then lights up

white, the vehicle socket will be unlocked for around 30 seconds.

- ❗ The charging process can also be ended via the multimedia system (→ page 337).
- ▶ Press and hold button ② on the charging cable connector and remove the charging cable connector from the vehicle socket.
- ❗ If you cannot remove the charging cable connector, unlock the vehicle and repeat the unlocking procedure. If the charging cable connector is still locked, contact a qualified specialist workshop.
- ▶ Close the socket cover and the socket flap.
- ❗ After the charging cable connector has been disconnected, left  indicator lamp ① on the vehicle socket will remain lit for some time before switching off.

### Emergency release of the socket flap

If the socket flap cannot be opened due to a malfunction, an emergency release of the socket flap can be performed for the charging process.

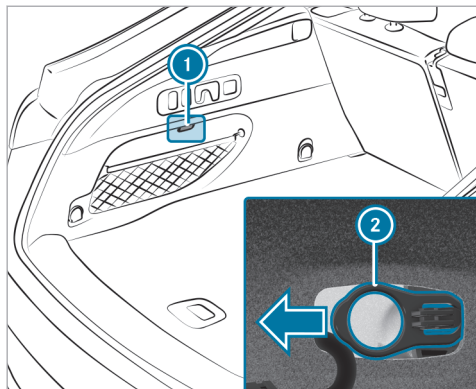

- ▶ Press in the catch spring of interior lamp ① with a suitable object, e.g. a screwdriver, and carefully prise the interior lamp out of the load compartment trim.
- ▶ Pull emergency release ② in the direction of the arrow. The socket flap of the vehicle socket swings open.

- ▶ Guide the connecting cables of interior lamp ① back behind the load compartment trim, laterally position interior lamp ① and snap it into the load compartment trim.
  - ▶ Start the alternating current charging process (→ page 205).
- or
- ▶ Start the direct current charging process (→ page 209).

### Function of the charge level display on the driver's display

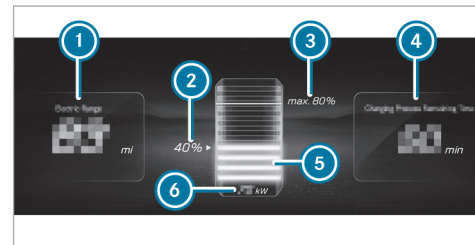

- ① Remaining range at current state of charge
- ② Current state of charge of the high-voltage battery
- ③ Maximum state of charge (depending on the setting)
- ④ Time remaining until completely charged (until the selected maximum state of charge is reached)
- ⑤ Dynamic charge level display
- ⑥ Current charging capacity

- ① Specified remaining range ① may vary due to different factors, e.g. driving style or topography.

When the vehicle is connected to the mains supply and is switched off, the driver's display will show the charge level display for approximately two minutes.

- ② The value of current charging capacity ② may differ from the display on the charging station.

## Parking

### Parking the vehicle

**⚠ WARNING** Risk of accident and injury caused by an insufficiently secured vehicle rolling away

If the vehicle is not securely parked sufficiently, it can roll away in an uncontrolled way even at a slight downhill gradient.

- ▶ On uphill or downhill gradients, turn the front wheels so that the vehicle rolls towards the curb if it starts moving.
- ▶ Apply the parking brake.
- ▶ Switch the transmission to position **P**.

**⚠ WARNING** Risk of fire caused by hot exhaust system parts

Flammable materials such as leaves, grass or twigs may ignite.

- ▶ Park the vehicle so that no flammable material can come into contact with hot vehicle components.
- ▶ In particular, do not park on dry grassland or harvested grain fields.

**⚠ WARNING** Risk of accident and injury due to children left unattended in the vehicle

If you leave children unattended in the vehicle, they could, in particular:

- open doors, thereby endangering other persons or road users.
- get out and be struck by oncoming traffic.
- operate vehicle equipment and become trapped, for example.

In addition, the children could also set the vehicle in motion by, for example:

- releasing the parking brake.
- changing the gearbox position.
- starting the vehicle.

- ▶ Never leave children unattended in the vehicle.
- ▶ When leaving the vehicle, always take the key with you and lock the vehicle.
- ▶ Keep the key out of reach of children.

This also applies to the Digital Vehicle Key.

**NOTE** Damage to the vehicle due to it rolling away

▶ Always secure the vehicle against rolling away.

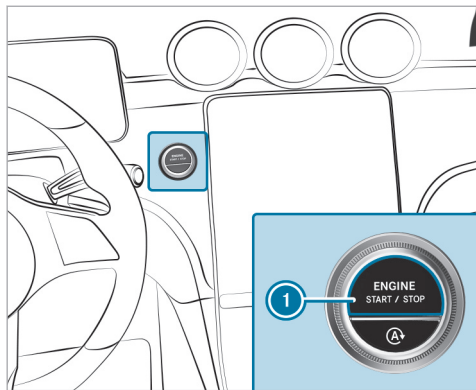

▶ Bring the vehicle to a standstill by depressing the brake pedal.

- ▶ On uphill or downhill gradients, turn the front wheels so that the vehicle rolls towards the curb if it starts moving.
- ▶ Apply the electric parking brake.
- ▶ Engage transmission position **[P]** in a stationary vehicle with the brake pedal applied (→ page 190).
- ▶ Switch off the vehicle by pressing button ①.
- ▶ Release the service brake slowly.
- ▶ Get out of the vehicle and lock it.

① When you park the vehicle, you can still operate the side windows and the panoramic sliding sunroof for approximately four minutes if the driver's door is closed.

#### Automatic vehicle shut-off when locking

Your vehicle is equipped with automatic engine shut-off.

When you leave the vehicle ready to drive, the vehicle will be turned off when locked under the following conditions:

- The ignition is switched on or the engine is running.

- Transmission position **[P]** is engaged.
- The driver's door is closed.
- **In addition, one of the following conditions must be fulfilled:**
  - The vehicle is locked using the vehicle key.
  - **Vehicles with KEYLESS-GO:** the vehicle is locked with KEYLESS-GO on the door handle of a closed door.
  - **Vehicles with KEYLESS-GO:** the vehicle is locked via the locking button in the tailgate.

① The engine will continue to run if the vehicle is not locked as described after it has been left. In this case, switch off the vehicle manually.

#### Automatic switch-off of the vehicle after a period of time (depending on equipment)

When the engine is running, the following display message appears in the driver's display when leaving the vehicle or after a certain time stopped in transmission position **[P]**: **Vehicle Ready to Drive Shutdown Occurs When Locked or Automatically in XX Mins**



The vehicle will then automatically switch off after a total of 20 minutes of time stopped.

**i** To avoid automatic switch-off after the time has elapsed, confirm the corresponding message in the central display of the multimedia system.

In the following cases, the engine continues to run:

- if the vehicle is not locked as described after leaving it
- if the automatic switch-off is not displayed by the display message
- if, once the time has elapsed, the automatic switch-off has been deactivated via the corresponding message in the central display

In this case, switch off the vehicle manually.

## Garage door opener

### ■ Programming buttons for the garage door opener

**▲ DANGER** Risk of death caused by exhaust gases

Combustion engines emit poisonous exhaust gases such as carbon monoxide. Inhaling these exhaust gases is hazardous to health and leads to poisoning.

- ▶ Never leave the engine or, if present, the auxiliary heating running in an enclosed space without sufficient ventilation.

**▲ WARNING** Risk of injury by becoming trapped when opening and closing a garage door

When you operate or program a garage door with an integrated garage door opener, persons can become trapped or struck by the garage door if they stand within its range of movement.

- ▶ Always make sure that nobody is within the range of the garage door's movement.

Only operate the following doors using the garage door opener:

- Doors with a safety stop and reversing feature
- Doors which conform to the current U.S. safety standards

Before programming the garage door opener, park the vehicle outside the garage. Make sure that the vehicle is switched on but not started.

#### Requirements

- The vehicle has been parked outside the garage or outside the range of movement of the door.
  - The vehicle is switched on.
  - The vehicle has not been started.
- i** The garage door opener function is always available when the vehicle is switched on.

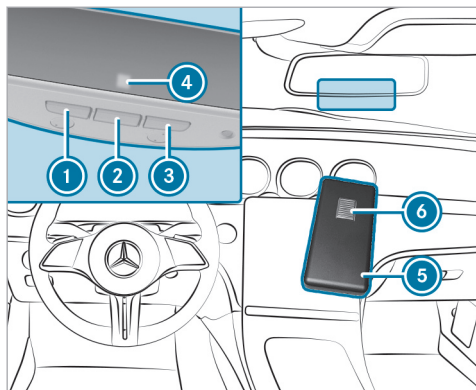

- ▶ Check if the transmitter frequency of the remote control has the frequency range of 280 to 868 MHz.

Radio equipment approval number:

- NZLMUAHL5 (USA)
- 4112A-MUAHL5 (Canada)

- ▶ Press and hold button ①, ② or ③ that you wish to program. Indicator lamp ④ flashes yellow.
- ⓘ It can take up to 20 seconds before the indicator lamp flashes yellow.
- ▶ Release the previously pressed button. Indicator lamp ④ continues to flash yellow.
- ▶ Point remote control ⑤ from a distance of 0.4 in (1 cm) to 3 in (8 cm) towards button ①, ② or ③.
- ▶ Press and hold button ⑥ of remote control ⑤ until one of the following signals appears:
  - Indicator lamp ④ lights up green continuously. Programming is complete.
  - Indicator lamp ④ flashes green. Programming was successful. Additionally, synchronization of the rolling code with the door system must be carried out.
- ▶ If indicator lamp ④ does not light up or flash green: repeat the procedure.
- ▶ Release all of the buttons.

- ⓘ The remote control for the door drive is not included in the scope of delivery of the garage door opener.

### ▶ Synchronizing the rolling code

#### Requirements

- The door system uses a rolling code.
- The vehicle must be within range of the garage door or door drive.
- The vehicle as well as persons and objects are located outside the range of movement of the door.
- ▶ Press the program button on the door drive unit. Initiate the next step within approximately 30 seconds.
- ▶ Press previously programmed button ①, ② or ③ repeatedly until the door closes. When the door closes, programming is completed.
- ⓘ Please also read the operating instructions for the door drive.

### Troubleshooting when programming the remote control

- ▶ Check if the transmitter frequency of remote control ⑤ is supported.
  - ▶ Replace the batteries in remote control ⑤.
  - ▶ Hold remote control ⑤ at various angles from a distance of 0.4 in (1 cm) to 3 in (8 cm) front of the inside rearview mirror. You should test every position for at least 25 seconds before trying another position.
  - ▶ Hold remote control ⑤ at the same angles at various distances in front of the inside rearview mirror. You should test every position for at least 25 seconds before trying another position.
  - ▶ On remote controls that transmit only for a limited period, press button ⑥ on remote control ⑤ again before transmission ends.
  - ▶ Angle the antenna line of the garage door opener unit toward the remote control.
- ⓘ It is possible that older garage doors cannot be operated using the remote control in the inside rearview mirror even after you have

successfully performed the measures described above. If this is the case, contact the HomeLink® Hotline.

- ⓘ Support and additional information on programming:
- on the toll free HomeLink® Hotline on 1-800-355-3515
  - on the Internet at <https://www.homelink.com/mercedes>

### Opening or closing the garage door

#### Requirements

- The corresponding button is programmed to operate the door.
- ▶ Press and hold buttons ①, ② or ③ until the door opens or closes.
  - ▶ If the indicator lamp ④ flashes yellow after approx. 20 seconds: Press the previously pressed button again and keep it pressed until the door opens or closes.

### Clearing the garage door opener memory

- ▶ Press and hold buttons ① and ③. Indicator lamp ④ lights up yellow.
- ▶ If indicator lamp ④ flashes green: release buttons ① and ③. The entire memory has been deleted.

### Electric parking brake

#### Function of the electric parking brake (applying automatically)

**⚠ WARNING** Risk of accident and injury due to children left unattended in the vehicle

If you leave children unattended in the vehicle, they could, in particular:

- open doors, thereby endangering other persons or road users.
- get out and be struck by oncoming traffic.
- operate vehicle equipment and become trapped, for example.

In addition, the children could also set the vehicle in motion by, for example:

- releasing the parking brake.
- changing the gearbox position.
- starting the vehicle.

- ▶ Never leave children unattended in the vehicle.
- ▶ When leaving the vehicle, always take the key with you and lock the vehicle.
- ▶ Keep the key out of reach of children.

This also applies to the Digital Vehicle Key.

**The electric parking brake is applied if the transmission is in position **P** and one of the following conditions is fulfilled:**

- The vehicle is switched off.
- The seat belt tongue is not inserted in the seat belt buckle of the driver's seat and the driver's door is opened.

**i** To prevent application: pull the handle of the electric parking brake (→ page 219).

**In the following situations, the electric parking brake is also applied:**

- The HOLD function is keeping the vehicle stationary.
- Active Parking Assist is keeping the vehicle stationary.
- Active Distance Assist DISTRONIC is bringing the vehicle to a standstill.
- **In addition, one of the following conditions must be fulfilled:**
  - The vehicle is switched off.
  - The seat belt tongue is not inserted in the seat belt buckle of the driver's seat and the driver's door is opened.
  - There is a system malfunction.
  - The power supply is insufficient.
  - The vehicle is stationary for a lengthy period.

When the electric parking brake is applied, the red **PARK** (USA) or **(P)** (Canada) indicator lamp lights up in the driver's display.

**i** The electric parking brake is not automatically applied if the vehicle is switched off by the ECO start/stop function.

### **Function of the electric parking brake (releasing automatically)**

The electric parking brake is released when the following conditions are fulfilled:

- The driver's door is closed.
- The vehicle has been started.
- The transmission is in position **D** or **R** and you depress the accelerator pedal or you shift from transmission position **P** to **D** or **R** when on level ground.
- If the transmission is in position **R**, the tail-gate must be closed.
- The seat belt tongue is inserted into the seat belt buckle of the driver's seat.

If the seat belt tongue is not inserted into the seat belt buckle of the driver's seat, one of the following conditions must be fulfilled:

- You shift from transmission position **P**.
- or

- You have previously driven at speeds greater than 2 mph (3 km/h).

When the electric parking brake is released, the red **PARK** (USA) or **(P)** (Canada) indicator lamp in the driver's display goes out.

### ■ Applying/releasing the electric parking brake manually

#### Applying

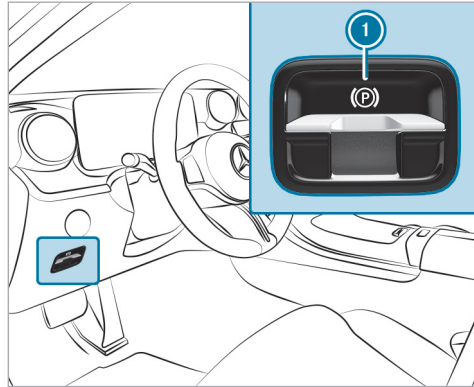

▶ Push handle ①.  
The red **PARK** (USA) or **(P)** (Canada) indicator lamp lights up in the driver's display.

- ① The electric parking brake is only securely applied if the red **PARK** (USA) or **(P)** (Canada) indicator lamp is lit continuously.

#### Releasing

▶ Switch on the vehicle.  
▶ Pull handle ①.  
The red **PARK** (USA) or **(P)** (Canada) indicator lamp in the driver's display goes out.

### ■ Emergency braking

▶ Press and hold handle ①.  
As long as the vehicle is in motion, the **Release Parking Brake** message is displayed and the red **PARK** (USA) or **(P)** (Canada) indicator lamp flashes.

When the vehicle has been braked to a standstill, the electric parking brake is applied. The red **PARK** (USA) or **(P)** (Canada) indicator lamp lights up in the driver's display.

### Information on collision detection on a parked vehicle

If a collision is detected on the locked vehicle when the tow-away alarm is activated and collision detection is switched on, you will receive a message in the multimedia system when the vehicle is switched on.

You will receive information about the following points:

- The area of the vehicle that may have been damaged.
- The force of the impact.

The following situation can lead to inadvertent activation:

- The parked vehicle is moved, for example, in a two-story garage.

- ① Deactivate the tow-away alarm in order to prevent inadvertent activation. If you deactivate the tow-away alarm, collision detection will also be deactivated.

You can permanently deactivate collision detection via the multimedia system (→ page 220).

- ❗ If the battery is severely discharged, the function for detecting a collision on a parked vehicle is automatically deactivated to facilitate the next engine start.

### System limits

Detection may be restricted in the following situations:

- the vehicle is damaged without impact, for example, if an outside mirror is torn off or the paint is damaged by a key
  - an impact occurs at low speed
  - the electric parking brake is not applied
- ❗ You are responsible for your vehicle. Convince yourself that your vehicle is free of damage and roadworthy.

### Setting collision detection for a parked vehicle

Multimedia system:

➤  ➤ Settings ➤ Vehicle  
➤ Open/Close ➤ Vehicle Protection

- Activate or deactivate the function via [Collision Notification](#).

- ❗ A maximum of three incidents can be registered. Up to 15 photos will be taken for every incident. In the event of another incident, the photos of the first incident will be overwritten if they have not been deleted already.

### Activating/deactivating collision photos

Note the possibility of legal restrictions in some countries regarding automatic recording of the vehicle's surroundings.

- Activate or deactivate [Collision Photos](#).

### Transferring the collision photos with the Mercedes me App

- Select [Upload Collision Photos](#).
- Select [Upload Automatically](#).

- Scan the QR code generated on the central display with the Mercedes me App. The collision photos will then be uploaded to Mercedes me in encrypted form.

- ❗ Any device that has scanned the QR code can be used to view the collision photos in the Mercedes me App.

### Copying collision photos to a USB flash drive

- Connect a USB flash drive .
- Select [Manage Collision Photos](#).
- Select [Copy \(USB\)](#).  
All collision photos will be copied to the USB flash drive.

- ❗ To ensure secure operation, only use USB storage devices formatted with FAT32 or exFAT.

### Deleting collision photos

- Select [Manage Collision Photos](#).
- Select [Delete](#).  
All collision photos will be deleted.

### Notes on parking the vehicle for an extended period

If you leave the vehicle parked for longer than six weeks, it may suffer damage through disuse.

The 12 V battery may also be impaired or damaged by heavy discharging.

- ① Further information can be obtained at a qualified specialist workshop.

### Standby mode (extension of the starter battery's period out of use)

#### ■ Standby mode function

- ① This function is not available for all models.

If standby mode is activated, energy loss will be minimized during extended periods of non-operation.

Standby mode is characterized by the following:

- The starter battery is preserved.
- The maximum non-operational time appears in the driver's display.
- The connection to online services is interrupted.

If the following conditions are fulfilled, standby mode can be activated or deactivated using the multimedia system:

- The vehicle is switched on.
- The vehicle has not been started.

Exceeding the vehicle's displayed non-operational time may cause inconvenience; i.e. it cannot be guaranteed that the starter battery will reliably start the vehicle.

Charge the starter battery in the following situations:

- The vehicle's non-operational time has to be extended.
- The starter battery charge level is insufficient for standby mode.
- ① Standby mode is automatically deactivated when the vehicle is switched on.

#### ■ Activating/deactivating standby mode (parking up the vehicle)

##### Requirements

- The power supply is switched on.

- The vehicle is not switched on.

Multimedia system:

➔  ➔ Settings ➔ Vehicle

➔ Other Functions

▶ Activate or deactivate **Standby Mode**.

### Driving and driving safety systems

#### Driving systems and your responsibility

Your vehicle is equipped with driving systems that assist you in driving, parking and maneuvering the vehicle. The driving systems are only aids. They are not a substitute for you paying attention to your surroundings and do not relieve you of your responsibility pertaining to road traffic law. The driver is always responsible for maintaining a safe distance to the vehicle in front, for vehicle speed, for braking in good time and for staying in lane. Pay attention to the traffic conditions at all times and intervene when necessary. Be aware of the limitations regarding the safe use of these systems.

Driving systems can neither reduce the risk of an accident if you fail to adapt your driving style nor override the laws of physics. They cannot always take into account road, weather or traffic conditions.

- ❶ Some driving systems can regulate or limit the speed to a previously set value. Draw attention to the stored speed when changing drivers.

### Information on vehicle sensors and cameras

Some driving and driving safety systems use cameras as well as radar or ultrasonic sensors to monitor the area in front of, behind or next to the vehicle.

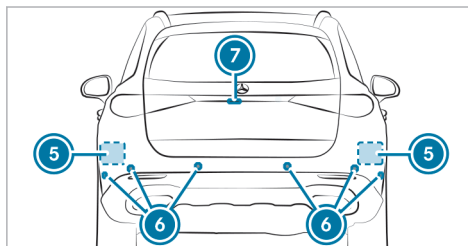
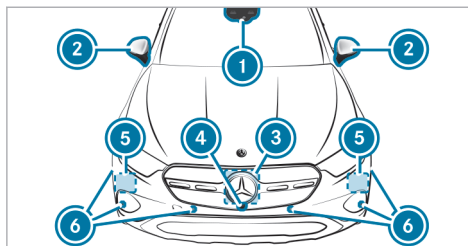

- ❶ Multifunction camera
- ❷ Cameras in the outside mirrors
- ❸ Front radar
- ❹ Front camera

- ❺ Corner radars
- ❻ Ultrasonic sensors
- ❼ Rear-view camera

**⚠ WARNING** Risk of accident due to restricted detection performance of vehicle sensors and cameras

If the area around vehicle sensors or cameras is covered, damaged or dirty, certain driving and safety systems cannot function correctly. There is a risk of an accident.

- ▶ Keep the area around vehicle sensors or cameras clear of any obstructions and clean.
- ▶ Have damage to the bumper, radiator grille or stone chipping in the area of the front and rear windows repaired at a qualified specialist workshop.

Particularly, keep the areas around the sensors and cameras free of dirt, ice or slush (→ page 383). The sensors and cameras must not be covered and the detection ranges around them must be kept free. Do not attach additional



license plate bracket, advertisements, stickers, foils or foils to protect against stone chippings in the detection range of the sensors and cameras. Make sure that there are no overhanging loads protruding into the detection range.

If there is damage to a bumper or the radiator grill, or after an impact, have the function of the sensors checked at a qualified specialist workshop. Have damage or stone chipping in the area of the cameras on the front and rear windows repaired at a qualified specialist workshop.

**i** The rear-view camera can extend and retract automatically for the purpose of calibration, even though there is no camera image in the display.

### Overview of driving systems and driving safety systems

- ABS (→ page 224)
- BAS (→ page 224)
- ESP® (→ page 225)
- ESP® Crosswind Assist (→ page 226)
- ESP® trailer stabilization (→ page 226)
- EBD (→ page 227)
- STEER CONTROL (→ page 227)
- HOLD function (→ page 227)
- Hill Start Assist (→ page 228)
- Valet Service Mode (→ page 229)
- Beginner Driver Mode (→ page 229)
- ATTENTION ASSIST (→ page 230)
- Cruise control (→ page 231)
- Traffic Sign Assist (→ page 256)
- Traffic light view (→ page 260)

### Driving Assistance Package

**i** The availability of some functions or sub-functions of the Driving Assistance Package is equipment- or country-specific. The range of functions in your Driving Assistance Package may differ from the functions listed here. The functions Active Distance Assist DISTRONIC, Active Blind Spot Assist, Active Brake Assist, Active Lane Keeping Assist and Active Emergency Stop Assist are also availa-

ble without the Driving Assistance Package, albeit with restricted functionality.

- Active Distance Assist DISTRONIC (→ page 233)
- Active Speed Limit Assist (→ page 238)
- Route-based speed adaptation (→ page 239)
- DSR (→ page 241)
- Active Brake Assist (→ page 250)
- Active Steering Assist (→ page 242)
- Active Emergency Stop Assist (→ page 245)
- Active Lane Change Assist (→ page 246)
- Active Stop-and-Go Assist (→ page 240)
- Blind Spot Assist and Active Blind Spot Assist with exit warning (→ page 261)
- Active Lane Keeping Assist (→ page 264)
- PRE-SAFE® Impulse Side (→ page 48)

### Parking Package

- i** The availability of individual functions is country- and equipment-dependent.
- Rear-view camera (→ page 267)

## 224 Driving and parking

- 360° camera (→ page 269)
- Parking Assist PARKTRONIC (→ page 276)
- Active Parking Assist (→ page 280)
- Memory Parking Assist (country-dependent) (→ page 288)
- Trailer Maneuvering Assist (→ page 292)

### Function of ABS

The Anti-lock Brake System (ABS) regulates the brake pressure in critical driving situations:



- During braking, for instance, at maximum full-stop braking or if there is insufficient tire traction, the wheels are prevented from locking.
- Vehicle steerability while braking is ensured.

If ABS intervenes when braking, you will feel a pulsing in the brake pedal. The pulsating brake pedal can be an indication of hazardous road conditions and can serve as a reminder to take extra care while driving.

### System limits

- ABS is active from speeds of approx. 3 mph (5 km/h).
- ABS may be impaired or may not function if a malfunction has occurred and the yellow  ABS warning lamp lights up continuously after the vehicle is started.

### Function of off-road ABS

 Off-road ABS is activated automatically when you select the  drive program.

Off-road ABS is specially adapted for driving off-road:

- The front wheels lock cyclically during braking.
- The braking distance is shortened due to the digging-in effect.

### System limits

- Off-road ABS functions at speeds below 25 mph (40 km/h).
- If off-road ABS intervenes, the ability to steer may be restricted.

### Function of BAS

 **WARNING** Risk of an accident caused by a malfunction in BAS (Brake Assist System)

If BAS is malfunctioning, the braking distance in an emergency braking situation is increased.

 Depress the brake pedal with full force in emergency braking situations. ABS prevents the wheels from locking.

The Brake Assist System (BAS) supports your emergency braking situation with additional brake force.

If you depress the brake pedal quickly, BAS is activated:

- BAS automatically boosts the brake pressure.
- BAS can shorten the braking distance.
- ABS prevents the wheels from locking.

The brakes will function as usual once you release the brake pedal. BAS is deactivated.

## Function of ESP®

**⚠ WARNING** Risk of skidding if ESP® is deactivated

If you deactivate ESP®, ESP® cannot carry out vehicle stabilization.

▶ ESP® should only be deactivated in the following situations.

**! NOTE** Mercedes-AMG vehicles

▶ Observe the notes in the Supplement. You could otherwise fail to recognize dangers.

The Electronic Stability Program (ESP®) can monitor and improve driving stability and traction in the following situations within physical limits:

- When you pull away on wet or slippery roads.
- When you brake.

If the vehicle deviates from the direction desired by the driver, ESP® can stabilize the vehicle by intervening in the following ways:

- Applying the brakes to one or more wheels.
- Adapting the engine output according to the situation.

When ESP® is deactivated, the  warning lamp will light up continuously:

- Driving stability will no longer be improved.
- The drive wheels could spin.
- ETS/4ETS traction control will still be active.

**i** When ESP® is deactivated, you will still be assisted by ESP® when braking.

When the  warning lamp flashes, at least one wheel has reached its grip limit:

- Adapt your driving style to suit the current road and weather conditions.
- Do not deactivate ESP®.
- Depress the accelerator pedal only as far as is necessary when pulling away.

Deactivate ESP® in the following situations to improve traction:

- When using snow chains.
- In deep snow.
- On sand or gravel.

**i** Spinning the wheels will cause them to dig in to the surface, thereby enhancing traction.

If the  warning lamp lights up continuously, ESP® is not available due to a malfunction.

Observe the following information:

- Warning and indicator lamps (→ page 531)
- Display messages (→ page 457)

## ETS/4ETS

ETS/4ETS (Electronic Traction System) traction control is part of ESP® and makes it possible to pull away and accelerate on a slippery roads.

If you select the  drive program, a special ETS/4ETS system specifically suited to off-road terrain will automatically be activated.

ETS/4ETS can improve the vehicle's traction by intervening in the following ways:

- The brakes will be applied to the drive wheels individually if they spin.
- More drive torque will be transferred to the wheel or wheels with traction.

#### Influence of drive programs on ESP®

The drive programs enable ESP® to adapt to different weather and road conditions as well as the driver's preferred driving style. Depending on the selected drive program, the appropriate ESP® mode will be activated (→ page 187).

#### Function of ESP® Crosswind Assist

ESP® Crosswind Assist detects sudden gusts of side wind and helps the driver to keep the vehicle in the lane:

- ESP® Crosswind Assist is active at vehicle speeds between approx. 50 mph (80 km/h) and 125 mph (200 km/h) when driving straight ahead or cornering slightly.

- The vehicle is stabilized by means of individual brake application on one side.

#### Function of ESP® trailer stabilization

**⚠ WARNING** Risk of accident in poor road and weather conditions

In poor road and weather conditions, the trailer stabilization cannot prevent lurching of the vehicle/trailer combination. Trailers with a high center of gravity may tip over before ESP® detects this.

- ▶ Always adapt your driving style to suit the current road and weather conditions.

When you are driving with a trailer, ESP® can stabilize your vehicle if the trailer begins to swerve from side to side:

- ESP® trailer stabilization will be active at speeds above 40 mph (65 km/h).
- Slight swerving is reduced by means of a targeted, individual brake application on one side.

- In the event of severe swerving, the operating energy output will also be reduced and the brakes will be applied to all wheels.

ESP® trailer stabilization may be impaired or may not function if:

- The trailer is not connected correctly or is not detected properly by the vehicle.

#### Activating/deactivating ESP® (Electronic Stability Program)

Multimedia system:



**!** **NOTE** Mercedes-AMG vehicles

- ▶ Observe the notes in the Supplement. You could otherwise fail to recognize dangers.

- ▶ Select **ESP**.
- ▶ Select **On** or **Off**.

ESP® is deactivated if the ESP® OFF warning lamp  lights up continuously on the driver's display.

Observe any information on warning lamps and display messages which may be shown on the driver's display.

### Function of EBD

Electronic Brakeforce Distribution (EBD) is characterized by the following:

- Monitoring and regulating the brake pressure on the rear wheels.
- Improved driving stability when braking, especially on bends.

### Function of STEER CONTROL

STEER CONTROL assists you by transmitting a noticeable steering force to the steering wheel in the direction required for vehicle stabilization.

This steering recommendation is given in the following situations:

- both right wheels or both left wheels are on a wet or slippery road surface when you brake
- the vehicle starts to skid

### System limits

STEER CONTROL may be impaired or may not function in the following situations:

- ESP® is deactivated.
- ESP® is malfunctioning.
- The steering is malfunctioning.

If ESP® is malfunctioning, you will be assisted further by the power steering.

### HOLD function

#### ■ HOLD function

The HOLD function holds the vehicle at a standstill without requiring you to depress the brake pedal, e.g. while waiting in traffic.

The HOLD function is only an aid. The responsibility for the vehicle safely standing still remains with the driver.

### System limits

The HOLD function is only intended to provide assistance when driving and is not a sufficient means of safeguarding the vehicle against rolling away when stationary.

- The incline must not be greater than 30%.

### ■ Activating/deactivating the HOLD function

**⚠ WARNING** Risk of an accident due to the HOLD function being active when you leave the vehicle

If the vehicle is only braked with the HOLD function it could, in the following situations, roll away:

- If there is a malfunction in the system or in the power supply.
- If the HOLD function is deactivated by depressing the accelerator pedal or brake pedal, e.g. by a vehicle occupant.

- ▶ Always secure the vehicle against rolling away before you leave it.

### Requirements

- The vehicle is stationary.
- The driver's door is closed or the seat belt on the driver's side is fastened.
- The vehicle has been started or has been automatically switched off by the ECO start/stop function.
- The electric parking brake is released.
- Active Distance Assist DISTRONIC is deactivated.
- The transmission is in position **D**, **R** or **N**.

### Activating the HOLD function

- ▶ Depress the brake pedal, and after a short time quickly depress further until the **HOLD** display appears in the driver's display.
- ▶ Release the brake pedal.

### Deactivating the HOLD function

- ▶ Depress the accelerator pedal to pull away.
- or

- ▶ Depress the brake pedal until the **HOLD** display disappears from the driver's display.

The HOLD function is deactivated in the following situations:

- Active Distance Assist DISTRONIC is activated.
- The transmission is shifted to position **P**.
- The vehicle is secured with the electric parking brake.

In the following situations, the vehicle is held by transmission position **P** and/or by the electric parking brake:

- The seat belt is unfastened and the driver's door is opened.
- The vehicle is switched off.
- There is a system malfunction.
- The power supply is insufficient.

In addition, the **Brake Immediately** message may appear in the driver's display and a horn tone may sound at regular intervals.

- ▶ Immediately depress the brake pedal firmly until the warning message disappears. The HOLD function is deactivated.
- ▶ Additionally secure the vehicle against rolling away.

### Function of Hill Start Assist

**▲ WARNING** Risk of accident and injury due to the vehicle rolling away

After a short time, Hill Start Assist no longer holds the vehicle.

- ▶ Swiftly move your foot from the brake pedal to the accelerator pedal. Do not leave the vehicle when it is being held by Hill Start Assist.

Hill Start Assist will hold the vehicle for a short time when you pull away on a hill in the following circumstances:

- The transmission is in position **D** or **R**.
- The electric parking brake is released.

This will give you enough time to move your foot from the brake pedal to the accelerator pedal and depress it before the vehicle begins to roll away.

## Valet service mode

### Function of the valet service mode

 This function is an on-demand feature (→ page 24).

In valet service mode, the vehicle acceleration is limited to reduce the risk of damage to and improper use of the vehicle when it is handed over to third parties.

Valet service mode is characterized by the following:

- Power output is reduced.
- In principle, a maximum speed of 81 mph (130 km/h) can be reached.
- The sporty drive programs and the  drive program are not available.
- ESP® cannot be deactivated.
- Profiles that are still logged in are logged out and unprotected profiles are secured.



### Activating or deactivating valet service mode

#### Requirements

- For activation: the vehicle is stationary.
- For deactivation: park position  is engaged.

Multimedia system:

  **» Apps » Valet service mode**

- ▶ Activate or deactivate the function. If valet service mode is activated, an indicator lamp on the driver's display will light up.
-  Alternatively, valet service mode can be activated or deactivated via the Mercedes me connect app. Further information on Mercedes me connect (→ page 357)
-  Valet service mode is protected from deactivation by third parties only in combination with Mercedes me connect. If the vehicle is connected to Mercedes me connect, only the profile that activated the mode or the established main user can deactivate it again.
-  Valet service mode will remain active even following a change of profile or after the vehicle

is switched on or off, and must be deliberately deactivated by the authorized user.

## Beginner driver mode

### Function of the beginner driver mode

 This function is an on-demand feature (→ page 24).

In beginner driver mode, the vehicle acceleration is limited to increase safety for inexperienced drivers.

Beginner driver mode is characterized by the following:

- Power output is reduced.
- In principle, a maximum speed of 81 mph (130 km/h) can be reached.
- The sporty drive programs and the  drive program are not available.
- ESP® cannot be deactivated.

### Activating/deactivating beginner driver mode

#### Requirements

- For activation: the vehicle is stationary.

- For deactivation: park position **P** is engaged.

Multimedia system:

→  **Apps** **» Beginner driver mode**

- ▶ Activate or deactivate the function. If beginner driver mode is activated, an indicator lamp on the driver's display will light up.
- ① Alternatively, beginner driver mode can be activated or deactivated via the Mercedes me connect app. Further information on Mercedes me connect (→ page 357)
- ① Beginner driver mode is protected from deactivation by third parties only in combination with Mercedes me connect. If the vehicle is connected to Mercedes me connect, only the profile that activated the mode or the established main user can deactivate it again.
- ① Beginner driver mode will remain active even following a change of profile or after the vehicle is switched on or off, and must be deliberately deactivated by the authorized user.

## ATTENTION ASSIST

### Function of ATTENTION ASSIST

ATTENTION ASSIST helps you on long, monotonous journeys, e.g. on highways and trunk roads. If indicators of fatigue or increasing lapses in concentration on the part of the driver are detected, the system will suggest taking a break.

ATTENTION ASSIST is only an aid. It cannot always detect fatigue or lapses in concentration in time. The system is not a substitute for a well-rested and attentive driver. On long journeys, take regular breaks in good time that allow for adequate recuperation.

You can choose between two settings:

- **Standard:** normal system sensitivity.
- **Sensitive:** higher system sensitivity. The driver is warned earlier and the attention level detected by ATTENTION ASSIST is adapted accordingly.

If drowsiness or increasing lapses in concentration are detected, the **ATTENTION ASSIST: Take a Break!** warning appears on the driver's display. You can acknowledge the message and take a

break where necessary. If you do not take a break and ATTENTION ASSIST continues to detect increasing lapses in concentration, you will be warned again after a minimum of 15 minutes.



The following information is displayed on the driver's display:

- The length of the journey since the last break
- The attention level determined by ATTENTION ASSIST.

The more segments **①** of the circle displayed, the higher the detected attention level. Fewer segments **①** are displayed in the circle as the attention level decreases.



If ATTENTION ASSIST is unable to calculate the attention level and cannot issue a warning, the **System Suspended** message appears.

If a warning is shown on the driver's display, the MBUX multimedia system offers to search for a rest area. You can select a rest area and start navigation to this rest area.

When you restart the vehicle, ATTENTION ASSIST is automatically switched on. The last selected sensitivity level remains stored.

### System limits

ATTENTION ASSIST is active in the speed range between 37 mph (60 km/h) and 124 mph (200 km/h).

If the system is not available due to a fault, the ATTENTION ASSIST warning lamp  will light up permanently on the driver's display

Particularly in the following situations, ATTENTION ASSIST only functions in a restricted manner and warnings may be delayed or not occur:

- If you have been driving for less than approximately 30 minutes.

- If the road condition is poor (uneven road surface or potholes).
- If there is a strong crosswind.
- If you adopt a sporty driving style (high cornering speeds or high rates of acceleration).
- If the Steering Assist function of Active Distance Assist DISTRONIC is active.
- If the clock is set to the incorrect time.
- If you change lanes and vary your speed frequently in active driving situations.

Also observe any information regarding display messages that may be displayed on the driver's display.

The ATTENTION ASSIST drowsiness or alertness assessment is reset and restarted when continuing the journey in the following situations:

- You switch off the vehicle.
- You unfasten your seat belt and open the driver's door (e.g. to change drivers or take a break).

### Setting ATTENTION ASSIST

Multimedia system:

  **» Settings » Assistance**  
**» Assistance » ATTENTION ASSIST**

### Setting the sensitivity

- ▶ Select  next to **ATTENTION ASSIST**.
- ▶ Select **Standard** or **Sensitive**.

### Speed control cruise control

#### Function of cruise control

Cruise control regulates the speed to the value selected by the driver.

If you accelerate to overtake, for example, the stored speed is not deleted. If you remove your foot from the accelerator pedal after overtaking, cruise control will resume speed regulation back to the stored speed.

You can store any speed from 15 mph (20 km/h) up to the maximum design speed.

Observe the notes on driving systems and your responsibility; you may otherwise fail to recognize dangers (→ page 221).

**Mercedes-AMG vehicles:** cruise control is available up to a maximum speed of 155 mph (250 km/h).

#### Displays on the driver's display

 **Gray:** cruise control is selected but not yet active, or temporarily passive.

 **Green:** cruise control is active.

A stored speed is shown under the  display and is indicated in the speedometer.

#### System limits

Cruise control may be unable to maintain the stored speed on uphill gradients. The stored speed is resumed when the gradient evens out.

Change to a lower gear in good time for long and steep downhill gradients. Take particular note of this when driving a laden vehicle. By doing so, you will make use of the braking effect of the engine. This relieves the load on the brake system and prevents the brakes from overheating and wearing too quickly.

Do not use cruise control in the following situations:

- In traffic situations which require frequent changes of speed, e.g. in heavy traffic, on winding roads
- On slippery roads. Accelerating can cause the drive wheels to lose traction and the vehicle could then skid.
- When visibility is poor

#### Operating cruise control

**⚠ WARNING** Risk of accident due to stored speed

If you call up the stored speed and this is lower than your current speed, the vehicle decelerates.

▶ Take into account the traffic situation before calling up the stored speed.

#### Requirements

- Cruise control is selected.
- ESP® must be activated, but not intervening.

- The vehicle speed is at least 15 mph (20 km/h).
- The transmission is in position **D**.

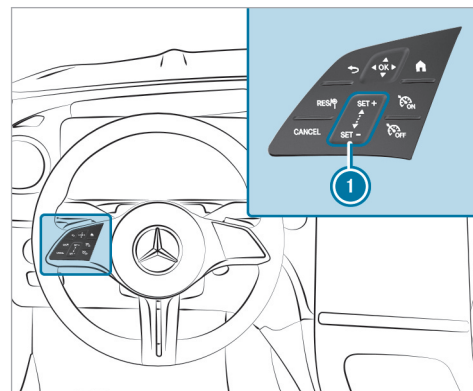

Steering wheel control panel for cruise control



Adopts the stored/detected speed



Deactivates cruise control









Control panel for increasing/decreasing speed



Activates cruise control



Deactivates cruise control

### Activating cruise control

- ▶ Press .

### Activating cruise control

- ▶ Press or on control panel ①. The current speed will be stored and maintained by the vehicle.

or

- ▶ Press .
- The last stored speed will be called up and maintained by the vehicle.
- If the last stored speed has previously been deleted, the current vehicle speed will be stored.

- ① When you switch off the vehicle, the last speed stored will be deleted.

### Increasing/decreasing the stored speed

- ▶ To increase the stored speed: swipe upwards from the bottom of control panel ①.
  - The stored speed will be increased by 1 mph (1 km/h).
- ▶ To decrease the stored speed: swipe downwards from the top of control panel ①.
  - The stored speed will be decreased by 1 mph (1 km/h).

or

- ▶ Briefly press or on control panel ①. The stored speed will be increased or decreased to the following values depending on the unit:

- **mph:** the next value ending in 5
- **km/h:** the next value ending in 0

or

- ▶ Accelerate the vehicle to the desired speed.
- ▶ Press on control panel ①.

### Adopting a detected speed

If cruise control is activated and Traffic Sign Assist has detected a traffic sign with a maximum

permissible speed and this is displayed on the driver's display:

- ▶ Press .
- The maximum permissible speed shown by the traffic sign will be stored and the vehicle will maintain that speed.

### Deactivating cruise control

- ▶ Press .

### Deactivating cruise control

- ▶ Press .

- ① If you brake or deactivate ESP® or if ESP® intervenes, cruise control will be deactivated.

## Active Distance Assist DISTRONIC

### Function of Active Distance Assist DISTRONIC

- ① Active Distance Assist DISTRONIC as described for vehicles without the Driving Assistance package is an on-demand feature (country-dependent) (→ page 24).

Active Distance Assist DISTRONIC maintains the set speed on free-flowing roads. If vehicles are

detected ahead, the set distance is maintained, if necessary until the vehicle comes to a standstill. The vehicle accelerates or brakes depending on the distance to the vehicle in front and the set speed. The speed and distance to the vehicle in front are set and saved using the steering wheel.

Available speed range:

- **Vehicles without Driving Assistance Package:**  
15 mph (20 km/h) - 100 mph (160 km/h)
- **Vehicles with Driving Assistance Package:**  
15 mph (20 km/h) - 130 mph (210 km/h)

Other features of Active Distance Assist DISTRONIC:

- Adjusts the driving style depending on the selected drive program (energy-saving, comfortable or dynamic) (→ page 185)
- Initiates acceleration to the stored speed if the turn signal indicator is switched on to change to the overtaking lane
- **Vehicles with Driving Assistance Package:**
  - Reacts to stationary vehicles detected in the urban speed range (except bicycles and motorcycles)

- Takes one-sided overtaking restrictions on highways or multi-lane roads with separate roadways into account (country-dependent)

**i** In the DYNAMIC SELECT menu, it is possible to set the driving mode of the Active Distance Assist DISTRONIC. Depending on the selected drive program, the driving behavior will be energy-saving, comfortable or dynamic. In the Active Distance Assist menu, the driving style can be permanently set to Comfort or Dynamic (→ page 240).

**Vehicles with Active Parking Assist and Driving Assistance Package:** if Active Distance Assist DISTRONIC has braked the vehicle to a standstill, it can automatically follow the vehicle in front when it drives off again within 30 seconds if the system detects that the driver is holding the steering wheel. If a critical situation is detected in the surrounding area when driving off, such as a person in the vehicle path, a visual and acoustic warning is given indicating that the driver must now take control of the vehicle. The vehicle is not accelerated any further.

Observe the notes on driving systems and your responsibility; you may otherwise fail to recognize dangers (→ page 221).

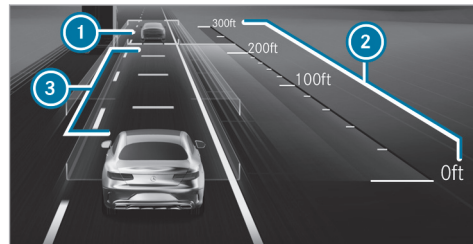

Display on the driver's display in the menu **Assistance**

- ① Vehicle in front
- ② Distance indicator
- ③ Specified distance set

Vehicle detected in front ① is highlighted in green. It may also be in the lane to the left of your vehicle in situations where overtaking on the right is not permitted, for example on highways.

**Permanent status display**

**Gray:** Active Distance Assist DISTRONIC selected but not yet active.





**Green speedometer, gray vehicle:** Active Distance Assist DISTRONIC active, speed set.







**Green:** Active Distance Assist DISTRONIC active and vehicle detected.

The stored speed is shown under the permanent status display and highlighted on the speedometer. When Active Distance Assist DISTRONIC is passive, the status display is grayed out.

If the speed of the vehicle in front or the speed adjustment is less than the stored speed due to the route event ahead, the segments in the speedometer light up.

When the specified distance set  is increased or reduced, the  display briefly appears.

-  The green  vehicle symbol will be displayed cyclically when the vehicle is ready to drive.
-  If you depress the accelerator pedal beyond the setting of the Active Distance Assist

DISTRONIC, the system is switched to passive mode. The following message appears briefly on the driver's display  **Suspended**.

**System limits**

The system may be impaired or may not function in the following instances:

- In snow, rain, fog, heavy spray, direct sunlight or greatly varying ambient light, or if there is glare.
- If the windshield in the area of the camera is dirty, fogged up, damaged or covered.
- If the radar sensors are dirty or covered.
- In parking garages or on roads with steep uphill or downhill gradients.
- If there are narrow vehicles in front, such as bicycles or motorcycles.

In addition, on slippery roads, braking or accelerating can cause one or several wheels to lose traction and the vehicle could then skid.

Do not use Active Distance Assist DISTRONIC in these situations.



**WARNING** Risk of accident from acceleration or braking by Active Distance Assist DISTRONIC

Active Distance Assist DISTRONIC may accelerate or brake in the following cases, for example:

- If the vehicle pulls away using Active Distance Assist DISTRONIC.
  - If the stored speed is called up and is considerably faster or slower than the currently driven speed.
  - If Active Distance Assist DISTRONIC no longer detects a vehicle in front or does not react to relevant objects.
- ▶ Always carefully observe the traffic conditions and be ready to brake at all times.
- ▶ Take into account the traffic situation before calling up the stored speed.

**⚠ WARNING** Risk of accident due to insufficient deceleration by Active Distance Assist DISTRONIC

Active Distance Assist DISTRONIC brakes your vehicle with up to 50% of the possible deceleration. If this deceleration is not sufficient, Active Distance Assist DISTRONIC alerts you with a visual and acoustic warning.

- ▶ Adjust your speed and maintain a suitable distance from the vehicle in front.
- ▶ Brake the vehicle yourself and/or take evasive action.

**⚠ WARNING** Risk of accident if detection function of Active Distance Assist DISTRONIC is impaired

Active Distance Assist DISTRONIC does not react or has a limited reaction:

- when driving on a different lane or when changing lanes

- to pedestrians, animals, bicycles or stationary vehicles, or unexpected obstacles
- to complex traffic conditions
- to oncoming vehicles and crossing traffic

As a result, Active Distance Assist DISTRONIC may neither give warnings nor intervene in such situations.

- ▶ Always observe the traffic conditions carefully and react accordingly.

### ■ Operating Active Distance Assist DISTRONIC

#### Requirements

- The electric parking brake is released.
- ESP® is activated and is not intervening.
- The transmission is in position **D**.
- All the doors are closed.
- The check on the radar sensor system has been completed successfully.
- Snow Chain Mode is not active (→ page 414).
- DSR is deactivated (→ page 242).

- Drive program  is deactivated (→ page 185).

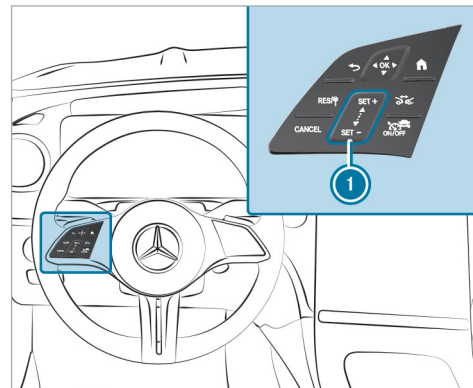

Adopts the stored/detected speed  
Deactivates Active Distance Assist DISTRONIC



Control panel for increasing/  
decreasing speed



Increases/decreases the specified distance



Activates/deactivates Active Distance Assist DISTRONIC

- ▶ **To operate Active Distance Assist DISTRONIC:** press the respective button with only one finger or swipe on the control panel.

#### Activates/deactivates Active Distance Assist DISTRONIC

- ▶ Press

#### Activating Active Distance Assist DISTRONIC

- ▶ **To activate without a stored speed:** press on the upper section or on the lower section of control panel or press . Remove your foot from the accelerator pedal.

or

- ▶ **To activate with a stored speed:** press . Remove your foot from the accelerator pedal. The last stored speed will be called up and maintained by the vehicle.

If the stored speed has been deleted, the current vehicle speed will be stored.

#### Increasing or reducing the speed

- ▶ To increase the stored speed: swipe upwards from the bottom of control panel .
  - The stored speed will be increased by 1 mph (1 km/h).
- ▶ To decrease the stored speed: swipe downwards from the top of control panel .
  - The stored speed will be decreased by 1 mph (1 km/h).

or

- ▶ Briefly press on the upper section or on the lower section of control panel . The stored speed will be increased or reduced by 5 mph (10 km/h).

or

- ▶ Accelerate the vehicle to the desired speed.
- ▶ Press on the upper section of control panel .

#### Adopting the limit speed shown on the driver's display

- ▶ To activate Active Distance Assist DISTRONIC: press , or .

- ▶ To accept the displayed speed limit: press .

The limit speed shown on the driver's display will be adopted as the stored speed. The vehicle will adapt its speed to that of the vehicle in front, but only up to the stored speed, or will limit its speed accordingly.

- A speed limit shown on the driver's display will be adopted only during travel, not when the vehicle is stationary.



#### Pulling away with Active Distance Assist DISTRONIC

- ▶ Activate Active Distance Assist DISTRONIC and remove your foot from the brake pedal.
- ▶ Press .

or

- ▶ Depress the accelerator pedal briefly and firmly.  
The functions of Active Distance Assist DISTRONIC will still be active.

#### Reducing or increasing the specified distance from the vehicle in front

- ▶ Press .  
The  indicator will appear. The specified distance will be reduced by one level.  
If the lowest level is already selected, the selection will jump to the highest level.

#### Deactivates Active Distance Assist DISTRONIC

**▲ WARNING** Risk of an accident due to Active Distance Assist DISTRONIC being active when you leave the driver's seat

If you leave the driver's seat while the vehicle is being braked by Active Distance Assist DISTRONIC only, the vehicle can roll away.

- ▶ Always deactivate Active Distance Assist DISTRONIC and secure the vehicle to prevent it from rolling away before you leave the driver's seat.

- ▶ Press **CANCEL**.

**i** If you brake or deactivate ESP® or if ESP® intervenes, Active Distance Assist DISTRONIC will be deactivated.

#### Function of Active Speed Limit Assist

If a change in speed limit is detected and the automatic adoption of speed limits is switched on, this will automatically be adopted as the stored speed (→ page 240). Speed limits below 12 mph (20 km/h) will not be adopted.

The vehicle's speed will be adjusted when the vehicle is level with the traffic sign at the latest. In the case of signs indicating entry into an urban area, the speed will be adapted according to the speed permitted within the urban area. The speed limit indicator on the driver's display will always be updated when the vehicle is level with the traffic sign.

If you are driving on a German freeway and there is no speed limit, the system will use the speed stored for a stretch of road with no speed limit as the set speed. If you do not alter the stored speed on a stretch of road with no speed limit, the rec-

ommended speed of 80 mph (130 km/h) will be adopted.

If you have put Active Distance Assist DISTRONIC into passive mode by pressing the accelerator pedal, only speed limits that are higher than the set speed will be adopted.

The maximum permissible speed does not take the road condition and current weather and traffic conditions into account. Adjust your speed accordingly as and when necessary.

Observe the notes on driving systems and your responsibility; you may otherwise fail to recognize dangers (→ page 221).

#### System limits

The system limits of Traffic Sign Assist apply to the detection of traffic signs (→ page 256).

Speed limits below 12 mph (20 km/h) will not automatically be adopted by the system as the stored speed. Temporary speed restrictions (e.g. for a certain time or due to weather conditions) cannot be properly detected by the system.

Adjust your speed in these situations.



**⚠ WARNING** Risk of accident due to adjustment of speed by Active Speed Limit Assist.

The speed adopted by the Active Speed Limit Assist may be too high or incorrect in individual cases:

- At limit speeds below 12 mph (20 km/h)
- In wet or foggy conditions
- ▶ Ensure that the speed being driven always complies with the traffic laws.
- ▶ Adjust the speed being driven to the current traffic and weather conditions.

### ■ Function of route-based speed adaptation

When Active Distance Assist DISTRONIC is activated, the vehicle speed will be adapted accordingly to the route events ahead. Depending on the drive program selected, the vehicle will negotiate a route event ahead in an energy-saving, comfortable or dynamic manner. When the route event has been passed, the vehicle will accelerate again to the stored speed. The set distance to the vehicle

in front, vehicles detected ahead and speed restrictions ahead will be taken into account.

Route-based speed adaptation can be activated in the multimedia system (→ page 240).

The following route events will be taken into account:

- Bends
- Traffic circles
- T-intersections
- Turns and exits
- Traffic jams ahead (only with Live Traffic)

Also, the speed will be reduced if the turn signal indicator is switched on and one of the following situations is detected:

- Turning off at intersections
- Driving in slowing-down lanes
- Driving in lanes adjacent to slowing-down lanes

The driver is responsible for choosing the right speed and observing other road users. This applies in particular to intersections, traffic circles

and traffic lights, as route-based speed adaptation does not brake the vehicle to a standstill.

When route guidance is active, the first speed adjustment will be carried out automatically. If the turn signal indicator is switched on, the selected route will be confirmed and further speed adjustment will be activated.

Speed adjustment will be canceled in the following cases:

- If the turn signal indicator is switched off before the route event and it is therefore assumed that the route event is not relevant to the driver
- If the driver depresses the accelerator or brake pedal during the process

### System limits

Route-based speed adaptation does not take right of way regulations into account. The driver is responsible for complying with road traffic regulations and driving at a suitable speed.

In difficult conditions, the speed selection made by the system may not always be suitable. This applies to the following situations, for example:

- The road's course is not clearly visible
- Road narrowing
- Varying maximum permissible speeds in individual lanes, e.g. at toll stations
- Wet road surfaces, snow or ice
- If transport equipment, such as a trailer or bicycle rack, is attached to the trailer hitch and the electrical connection has been correctly established.

The driver will need to intervene accordingly in these situations.

**⚠ WARNING** Risk of accident in spite of route-based speed adaptation

Route-based speed adaptation can malfunction or be temporarily unavailable in the following situations:

- If the driver does not follow the calculated route
  - If map data is not up-to-date or available
  - In the event of roadworks
  - In bad weather or road conditions
  - If the accelerator pedal is depressed
  - In the event of electronically displayed speed limitations
- ▶ Adapt the speed to the traffic situation.

### Setting Active Distance Assist DISTRONIC driving styles

#### Requirements

- Active Distance Assist DISTRONIC is activated.

Multimedia system:

→  ▶ Settings ▶ Assistance  
▶▶ Driving ▶▶ Active Distance Assist

#### Selecting a driving style

- ▶ Select **Based on DYNAMIC SELECT**, **Dynamic** or **Comfortable**.

- ⓘ Further information about Active Distance Assist DISTRONIC (→ page 236).

#### Setting speed adjustment

- ▶ Select **Adopt Speed Limit** or **Route-based Speed Adaptation**.

When these functions are active, the vehicle speed will be adjusted depending on the route events ahead.

- ⓘ If one of the following systems is activated, the detected speed can be manually adopted as the speed limit:
- Active Distance Assist DISTRONIC
  - Variable limiter
- ⓘ Further information on speed adjustment (→ page 239).

#### Function of Active Stop-and-Go Assist

Active Stop-and-Go Assist helps you when in traffic jams on multi-lane roads with separate roadways by automatically pulling away within up to 60 seconds and with moderate steering maneuvers. It orients itself using the vehicle in front and lane markings. Active Stop-and-Go Assist auto-

matically maintains a safe distance from the vehicle in front and vehicles cutting in.

Active Stop-and-Go Assist requires you, as the driver, to keep your hands on the steering wheel at all times so that you are able to intervene at any time to correct the course of the vehicle and keep it in lane.

Observe the notes on driving systems and your responsibility; you may otherwise fail to recognize dangers (→ page 221).

Active Stop-and-Go Assist activates automatically when all the following conditions are met:

- You are in a traffic jam on a highway or high-speed major road.
- Active Distance Assist DISTRONIC is activated and active (→ page 236).
- Active Steering Assist is activated and active (→ page 244).
- You are traveling no faster than 35 mph (60 km/h).

When Active Stop-and-Go Assist is active the  status display appears on the driver's display.

### System limits

The system limitations of Active Distance Assist DISTRONIC and Active Steering Assist apply to Active Stop-and-Go Assist (→ page 242).

## DSR (Downhill Speed Regulation)

### Function of DSR

DSR is an aid to assist you when driving downhill. It keeps the speed of travel at the selected target speed. The steeper the downhill gradient, the greater the DSR braking effect on the vehicle. On flat stretches of road and uphill gradients, DSR brakes the vehicle minimally or not at all.

When DSR is activated and the transmission is in position **D**, **R** or **N**, DSR controls the driving speed. The target speed can be set to a value between 1 mph (2 km/h) and 11 mph (18 km/h). By braking or accelerating, you can drive at a higher or lower speed than the target speed at any time.

DSR will be switched off automatically

- if you are driving at a speed greater than 28 mph (45 km/h)

- if you change the drive program

The  Off message will appear on the driver's display. The status indicator on the driver's display will go out. You will also hear a warning tone.

 DSR will remain active in drive program .

### Information on DSR

 **WARNING** Risk of skidding and accident when DSR is activated on slippery road surfaces

If the driven speed and the target speed differ, the wheels may lose traction.

 Take into account the road surface and the difference between the driving speed and target speed before activating DSR.

Observe the notes on driving systems and your responsibility; you may otherwise fail to recognize dangers (→ page 221).

You are always responsible for keeping control of the vehicle and for assessing whether the downhill gradient can be negotiated. Depending on road surface and tires, DSR may not always be able to

keep to the target speed. Select a target speed suitable for the environmental conditions and also apply the brakes yourself if required.

### ■ Activating or deactivating DSR (Downhill Speed Regulation)

#### Requirements

- You are driving at 24 mph (40 km/h) or slower.  
If the vehicle speed is too high, the **Max. speed 40 km/h** message appears on the driver's display.
- Active Distance Assist DISTRONIC, cruise control and the variable limiter are switched off.

Multimedia system:

→  » Settings » Assistance

- Select .  
A status display appears on the driver's display when the function is activated.

### ■ Changing the target speed

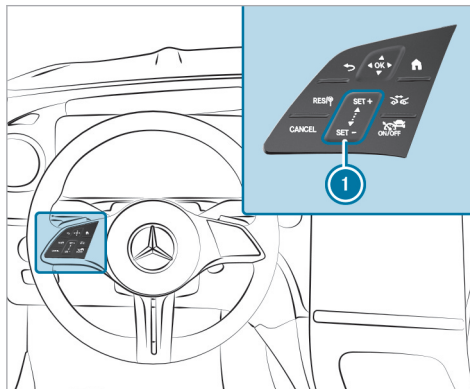



- To increase the target speed:** swipe upwards from the bottom of control panel ①.
  - The target speed will be increased by 1 mph (1 km/h).

or

- Press and hold  at the top of control panel ①.  
The target speed will be increased in 1-mph (1-km/h) increments.
- To reduce the target speed:** swipe downwards from the top of control panel ①.
  - The target speed will be reduced by 1 mph (1 km/h).

or

- Press and hold  at the bottom of control panel ①.  
The target speed will be reduced in 1-mph (1-km/h) increments.  
The set target speed will be shown  next to the status display on the driver's display.

### Active Steering Assist

#### ■ Function of Active Steering Assist



Active Steering Assist is only available up to a speed of 130 mph (210 km/h). The system helps you to stay in the center of the lane by means of moderate steering interventions. Depending on the vehicle's speed, Active Steering Assist uses



the vehicles ahead and lane markings as a reference.

- ① Depending on the country, Active Steering Assist can use the surrounding traffic as a reference in the lower speed range. If necessary, Active Steering Assist can then also provide assistance outside the center of the lane.

If the detection of lane markings and vehicles ahead is impaired, Active Steering Assist switches to passive mode. The system provides no support in this case.

#### Permanent status display on the driver's display

-  **Gray:** activated and passive
-  **Green:** activated and active
-  **Red, flashing:** prompt to the driver to actively confirm or transition from active to passive status, system limit detected

- ① During the transition from active to passive status, the  symbol is shown as enlarged and flashing. Once the system is passive, the  symbol is shown as gray on the driver's display.

#### Touch detection

The driver is required to keep their hands on the steering wheel at all times and be able to intervene at any time to correct the course of the vehicle and keep it in lane. The driver must expect a change from active to passive mode or vice versa at any time.



If the system detects that the driver has not steered the vehicle for a considerable period of time or has removed their hands from the steering wheel, a visual warning is given first. Display ① appears on the driver's display. If the driver still does not steer the vehicle, or gives no confirmation to the system, a warning tone sounds in addition to the visual warning message.

If the driver does not react to this warning for a considerable period, an emergency stop is initiated (→ page 245).

The warning is not issued or is stopped as soon as the system detects that the driver is touching the steering wheel.

Touch detection may be limited or may not function if there is no direct contact between hand and steering wheel, e.g. if you are wearing gloves or if there is a steering wheel cover on the steering wheel.

If Active Steering Assist detects that a system limit has been reached, a visual warning is issued and a warning tone sounds.

Observe the notes on driving systems and your responsibility; you may otherwise fail to recognize dangers (→ page 221).

#### System limits

Active Steering Assist has a limited steering torque for lateral guidance. In some cases, the steering intervention is not sufficient to keep the vehicle in the lane.

The system may be impaired or may not function in the following instances:

- Visibility is poor, e.g. due to snow, rain, fog, heavy spray, greatly varying ambient light or strong shadows on the road.
- There is glare, e.g. from oncoming traffic, direct sunlight or reflections.
- Insufficient road illumination.
- The windshield is dirty, fogged up, damaged or covered in the vicinity of the camera, e.g. by a sticker.
- No, or several, unclear lane markings are present for one lane, or the markings change quickly, for example, in construction areas or at intersections.
- The lane markings are worn away, dark or covered up, e.g. by dirt or snow.
- If the distance to the vehicle in front is too short and thus the lane markings are not detected.
- The road is narrow and winding.
- There are obstacles in the lane or projecting out into the lane, such as object markers.

- If transport equipment, for example a trailer or bicycle rack, is attached to the trailer hitch and the electrical connection has been correctly established.

The system does not provide assistance in the following situations:

- On very tight bends and when turning.
- When crossing intersections.
- At traffic circles or toll stations.
- When actively changing lane without switching on the turn signal indicator.
- When the tire pressure is too low.

**⚠ WARNING** Risk of accident if Active Steering Assist unexpectedly stops functioning

If the system limits of Active Steering Assist are reached there is no guarantee that the system will remain active or will keep the vehicle in lane.

- ▶ Always keep your hands on the steering wheel and observe the traffic carefully.

- ▶ Always steer the vehicle paying attention to traffic conditions.

**⚠ WARNING** Risk of accident if Active Steering Assist unexpectedly intervenes

The detection of lane markings and objects may malfunction and cause unexpected steering interventions.

- ▶ Steer according to traffic conditions.

### ■ Activating/deactivating Active Steering Assist

#### Requirements

- ESP® is activated, but is not intervening.
- Active Distance Assist DISTRONIC is activated.

Multimedia system:

➤  ➤ Settings ➤ Assistance

➤ Driving

▶ Activate or deactivate **Active Steering Assist**.

### Function of Active Emergency Stop Assist

Active Emergency Stop Assist monitors the steering wheel and the accelerator and brake pedals. If the system detects a lack of driver activity and the vehicle threatens to leave its lane, a warning can be issued and an emergency stop initiated.

**Vehicles without Driving Assistance Package:** The system is available from a speed of approx. 37 mph (60 km/h).

**Vehicles with Driving Assistance Package:** If Active Steering Assist is switched off, the system is available from a speed of approx. 37 mph (60 km/h).

If the vehicle is threatening to leave its lane, a warning is issued in the following cases:

- The driver does not touch the steering wheel for an extended period of time or no steering movement can be measured for an extended period of time (depending on the vehicle equipment).
- Neither the accelerator nor the brake pedal is being depressed.

- ① Vehicles with Driving Assistance Package:** If Active Steering Assist is switched on and active, only the steering wheel is monitored by the system. If the driver does not touch the steering wheel for an extended period of time, a warning may be given despite pedal actuation.
- Also observe the instructions on touch detection as part of Active Steering Assist (→ page 242).



Active Emergency Stop Assist issues the following warnings in order:

- Display **①** appears on the driver's display.

- In addition to display **①**, a warning tone sounds.
- The message **Initiating Emergency Stop** appears on the driver's display, a continuous warning tone sounds, the vehicle no longer accelerates and, if necessary, slight belt tensioning is carried out.
- The vehicle speed is reduced in increments until it is at a standstill. Sharp brake impulses are also produced.

- ① Vehicles with Driving Assistance Package:** If Active Distance Assist DISTRONIC is active and the driver unfastens their seat belt and opens the driver's door, an emergency stop can be initiated immediately.

### Vehicles with Driving Assistance Package:

Depending on the country, a lane change to the adjacent lane is carried out, if possible. It is possible only to change across one lane and only into the outer lane, and not onto the hard shoulder.

When automatic braking is initiated, Active Distance Assist DISTRONIC is deactivated. Depending on the country, the hazard warning light system is also switched on.

When the vehicle has been brought to a standstill:

- The vehicle is secured with the electric parking brake.
- The vehicle is unlocked.
- If possible, an emergency call is placed to the Mercedes-Benz emergency call center.

Before automatic braking is initiated, you can cancel Active Emergency Stop Assist by steering.

You can cancel the intervention by Active Emergency Stop Assist after automatic braking is initiated through one of the following actions:

- Accelerating or braking: the emergency stop is canceled, but the warning message, warning tone and power steering remain active.
- Steering: power-assisted steering is canceled, the warning message and warning tone remain active and the vehicle continues to be braked.

- ⓘ Active Emergency Stop Assist can initiate an emergency stop a maximum of three times within a driving cycle. After that, Active Steering Assist and Active Emergency Stop Assist are disabled until the vehicle has been restarted.



### System limits

For the detection of vehicles and other obstacles, observe the system limits of the following functions:

- Active Distance Assist DISTRONIC (→ page 233)
- Active Steering Assist (→ page 242)
- Active Lane Change Assist (→ page 246)
- Active Lane Keeping Assist (→ page 264)
- Active Brake Assist (→ page 250)

### Vehicles without Driving Assistance Package:

Active Emergency Stop Assist is inactive in the following cases:

- Active Lane Keeping Assist has reached a system limit.
-  Active Lane Keeping Assist is deactivated (white status display).
-  Active Lane Keeping Assist is not operational (gray status display).

### Active Lane Change Assist

#### Function of Active Lane Change Assist

Active Lane Change Assist helps the driver with changing lanes and is activated when the driver indicates briefly.

For this, the following conditions must be fulfilled:

- You are driving on a highway or high-speed major road.
- The vehicle's speed is between approximately 40 mph (65 km/h) and 110 mph (180 km/h).
- The neighboring lane is separated by a dashed lane marking.
- No vehicle or obstacle is detected in the adjacent lane.
- Active Lane Change Assist is selected in the multimedia system.
- Active Distance Assist DISTRONIC and Active Steering Assist are switched on and active.



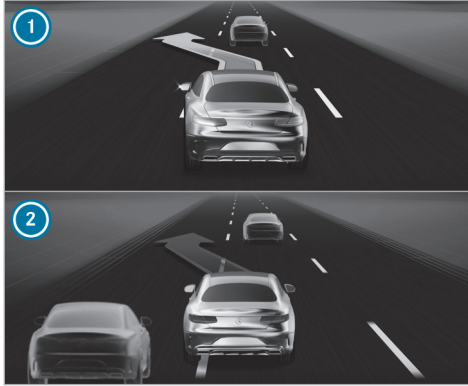



Indicator on the driver's display on the menu **Assistance**

- ① Green arrow: lane change initiated
- ② Red arrow: lane change canceled

When Active Lane Change Assist is available, the  indicator will appear along with green arrows on the driver's display. If the system has been activated but is not currently available, the

 indicator will appear along with grey arrows on the driver's display.

If no vehicle or obstacle is detected in the adjacent lane and a lane change is permitted, the lane change will begin after the driver has indicated briefly. The lane change will be shown to the driver with a flashing green arrow next to the  steering wheel symbol. Green arrow ① will be displayed in the appropriate adjacent lane on the driver's display on the **Assistance** menu. A message reading **Lane Change to the Left**, for example, will also appear.

If a lane change is not possible directly after the driver has activated the turn signal indicator because an obstacle has been detected, for example, the arrow will also flash in green next to the steering wheel symbol . The neighboring lane will continue to be monitored. When the lane becomes clear, a lane change will be carried out and a message reading **Lane Change to the Left**, for example, will appear on the driver's display. When the green arrows stop flashing, activate the lane change again.

Active Lane Change Assist can be canceled in various situations, including the following:

- Change in the surrounding conditions (e.g. detected obstacle).
- The driver steers too sharply or in the opposite direction.
- The driver moves the turn signal indicator in the opposite direction.
- Active Distance Assist DISTRONIC or Active Steering Assist is deactivated.
- The vehicle cannot make the lane change as planned.

Cancellation of Active Lane Change Assist will be displayed as follows:

- The arrow in the selected direction of travel turns red.
- A corresponding message will also appear on the driver's display.
- In certain circumstances, a warning tone will sound.

**▲ WARNING** Risk of accident when changing lane to an occupied adjacent lane

Lane Change Assist cannot always clearly detect if the adjacent lane is free.

The lane change might be initiated although the adjacent lane is not free.

- ▶ Before changing lanes, make sure that the neighboring lane is free and there is no danger to other road users.
- ▶ Monitor the lane change.

**▲ WARNING** Risk of accident if Lane Change Assist unexpectedly stops functioning

If the system limitations for Lane Change Assist have been reached, there is no guarantee that the system will remain active.

Lane Change Assist cannot then assist you by applying steering torque.

- ▶ Always monitor the lane change and keep your hands on the steering wheel. Observe the traffic conditions and steer and/or brake if necessary.

**Automatic Lane Change**

Automatic Lane Change is a sub-function of Active Lane Change Assist. It can assist the driver in deciding when a lane change is appropriate and in executing it.

**▲ WARNING** Risk of accident due to incorrectly triggered lane change

The system cannot always clearly recognize all situations in which a lane change is appropriate.

The system can initiate a lane change even though the traffic situation is not suitable or the neighboring lane is not available, not usable or occupied.

- ▶ Always monitor the traffic situation.
- ▶ If necessary, cancel the lane change by holding the steering wheel or countersteering slightly and return the vehicle to its own lane.

You can cancel a lane change initiated by the system at any time by holding the steering wheel or

countersteering slightly and returning the vehicle to its own lane.

For an Automatic Lane Change, the following conditions must be met:

- The conditions for activating Active Lane Change Assist are fulfilled.
- Automatic Lane Change is activated in the multimedia system.
- You are driving on a freeway in a country where the function is available.
- The road you are currently driving on allows lane changes (e.g. there are no tight bends).
- The vehicle speed is between approximately 40 mph (65 km/h) and 85 mph (140 km/h).

Active Lane Change Assist can initiate an automatic lane change in various situations, including the following:

- The set desired speed of Active Distance Assist DISTRONIC cannot be reached due to a slower vehicle in front.
- There is little traffic and the set desired speed of Active Distance Assist DISTRONIC can also be reached in a slower lane.

- A lane change is necessary to follow the set route in the navigation system or the road you are currently driving on. The lane change may take place before the request to do so appears in the navigation system.
- The system detects that the lane you are driving in will end soon.
- You are in the lane furthest to the right.

In particular, Active Lane Change Assist will not execute Automatic Lane Change in the following situations:

- If the vehicle is already in a lane that it should use to follow the set route in the navigation system.
- On some route sections, no lane change will be made to the lanes furthest to the right.
- The system detects that the neighboring lane will end soon.
- If Automatic Lane Change has been canceled by the driver, no lane change in that direction will be initiated for a certain time.
- If the driver has initiated a lane change in one direction or has changed lanes manually, no



lane change in the opposite direction will be initiated for a certain time.

The same abort conditions apply to Automatic Lane Change as to driver-initiated lane changes with Active Lane Change Assist.

In addition, Automatic Lane Change can be canceled in the following circumstances in particular:

- The system detects a road work site marked off by traffic cones in the vehicle's own lane or in the neighboring lane during the lane change.
- The system detects that the reason for the lane change no longer exists.

#### Indicator on the driver's display

When Automatic Lane Change is turned on, the **Automatic Lane Change On** message will appear. When Automatic Lane Change is available, the  indicator will appear in green instead of the  indicator. If Automatic Lane Change is available but not all conditions to activate the function are currently met, the **A** symbols will be shown in grey. If the system deems it advisable to change lanes and needs to adjust the traveled speed to

do so, the green **A** will flash on the side to which a lane change is to be made.

When Automatic Lane Change starts, for example, the **Lane Change to the Left** message will appear and a warning tone will sound.

When Automatic Lane Change is canceled, the **A** on the side to which a lane change should be made will turn red. Additional warning messages may also appear and another warning tone may sound in certain situations.

#### System limits

The system limits of Active Steering Assist apply to Active Lane Change Assist (→ page 242).

The system may also be impaired or may not function in the following situations:

- The sensors are damaged, covered or dirty (→ page 222).
- The exterior lighting shows a defect.
- The system does not detect a suitable road, such as on tight bends.
- The vehicle is at a road work site.

Automatic Lane Change may not function or may be impaired in the following situations in particular and could lead to lane changes being initiated incorrectly:

- The vehicle is at a road work site and/or the system has detected a road work site marked off by traffic cones.
  - The system can no longer detect the lane marking correctly.
  - It is raining heavily.
  - Another vehicle changes to the same lane at the same time (e.g. when the vehicle is passing an on-ramp).
- i** The Active Lane Change Assist sensors will adjust automatically while a certain distance is being driven after the vehicle has been delivered. Active Lane Change Assist will be unavailable during this teach-in process, and no arrows will be displayed next to the Active Steering Assist symbol .

Observe the notes on driving systems and your responsibility; you may otherwise fail to recognize dangers (→ page 221).

### Setting Active Lane Change Assist

Multimedia system:

 **Settings** **Assistance**  
**Driving** **Active Lane Change Assist**

- ▶ Select **Active Lane Change Assist**.
- ▶ Choose between the **On** and **Off** setting options.
- ▶ Choose between the **On**, **Also Automatically** and **Off** setting options.

The **Also Automatically** setting option can also be switched on and off on the quick-access menu.

- i** If **Active Steering Assist** has been switched off, it will not be possible to operate **Active Lane Change Assist**.

### Active Brake Assist

#### Function of Active Brake Assist

Active Brake Assist consists of the following functions:

- Collision warning
- Autonomous braking function

- Situation-dependent brake force boosting
- **Vehicles with Driving Assistance Package and Active Steering Assist:** Evasive Steering Assist
- **Vehicles with Driving Assistance Package:** Evasive Steering Assist
- **Vehicles with Driving Assistance Package:** Intersection start-off function

Active Brake Assist can help you to minimize the risk of a collision with vehicles, cyclists or pedestrians or to reduce the effects of such a collision.

If Active Brake Assist has detected a risk of collision, a warning tone sounds and the distance warning lamp  lights up.

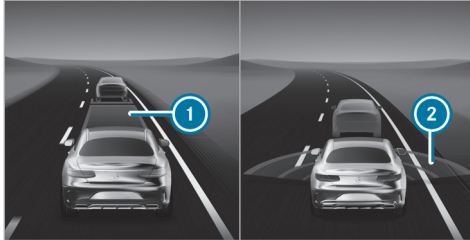

Display on the driver's display in the **Assistance** menu

In the **Assistance** menu, an insufficient distance to the vehicle in front ① is displayed in red. If you further reduce the distance, the vehicle in front is also highlighted in red. When the system detects a risk of collision, red radar waves ② will appear in front of your vehicle.

**i Vehicles with PRE-SAFE®:** depending on the country, an additional haptic warning will occur in the form of slight, repeated tensioning of the seat belt on the driver's side.

If you do not react to the warning, autonomous braking may be initiated in critical situations.

In particularly critical situations, Active Brake Assist can also initiate autonomous braking directly. In this case, the distance warning lamp  and the warning tone will occur at the same time as the brake application.

If you apply the brakes yourself in a critical situation or apply the brakes during autonomous braking, situation-dependent brake force boosting will occur. The brake pressure increases up to maximum full-stop braking if necessary.



If autonomous braking or situation-dependent brake force boosting has occurred, pop-up ① will appear on the driver's display and then automatically disappear after a short time.

If the autonomous braking function or situation-dependent brake force boosting is triggered, additional preventive measures for occupant protection (PRE-SAFE®) may also be initiated.

**⚠ WARNING** Risk of an accident caused by limited detection performance of Active Brake Assist

Active Brake Assist cannot always clearly identify objects and complex traffic situations.

In such cases, Active Brake Assist might:

- Give a warning or brake without reason
- Not give a warning or not brake

Active Brake Assist is only an aid. The driver is responsible for maintaining a sufficiently safe distance to the vehicle in front, vehicle speed and for braking in good time.

- ▶ Always pay careful attention to the traffic situation; do not rely on Active Brake Assist alone.
- ▶ Be prepared to brake or swerve if necessary.

If Active Brake Assist is deactivated or the functions are restricted, e.g. due to activation of another driving system, the Active Brake Assist warning lamp  will appear on the driver's display.

If the system is unavailable due to dirty or damaged sensors or due to a malfunction, or if the functions are restricted, the Active Brake Assist warning lamp  will appear on the driver's display.

Also observe the system limits of Active Brake Assist.

The individual subfunctions are available in the following speed ranges:

### Collision warning

The collision warning can assist you in the following situations from approximately 4 mph (7 km/h) with an intermittent warning tone and the distance warning lamp .

Vehicles without Driving Assistance Package:

- At speeds up to approximately 155 mph (250 km/h) when approaching vehicles ahead

- At speeds up to approximately 50 mph (80 km/h) when approaching stationary vehicles, pedestrians walking in the direction of travel and cyclists ahead
- At speeds up to approximately 43 mph (70 km/h) when approaching crossing pedestrians and cyclists
- At speeds up to approximately 37 mph (60 km/h) when approaching stationary pedestrians and cyclists

Vehicles with Driving Assistance Package:

- At speeds up to approximately 155 mph (250 km/h) when approaching vehicles ahead
- At speeds up to approximately 75 mph (120 km/h) when approaching crossing vehicles, pedestrians and cyclists
- At speeds up to approximately 62 mph (100 km/h) when approaching stationary vehicles
- At speeds up to approximately 50 mph (80 km/h) when approaching cyclists ahead

- At speeds up to approximately 43 mph (70 km/h) when approaching stationary pedestrians and cyclists

### Autonomous braking function

From a speed of approximately 4 mph (7 km/h), the autonomous braking function may intervene in the following situations:

Vehicles without Driving Assistance Package:

- At speeds up to approximately 155 mph (250 km/h) when approaching vehicles ahead
- At speeds up to approximately 50 mph (80 km/h) when approaching cyclists ahead, pedestrians walking in the direction of travel and stationary vehicles
- At speeds up to approximately 43 mph (70 km/h) when approaching crossing pedestrians and cyclists

Vehicles with Driving Assistance Package:

- At speeds up to approximately 155 mph (250 km/h) when approaching vehicles ahead
- At speeds up to approximately 75 mph (120 km/h) when approaching crossing vehicles, pedestrians and cyclists

- At speeds up to approximately 62 mph (100 km/h) when approaching stationary vehicles
- At speeds up to approximately 50 mph (80 km/h) when approaching cyclists ahead
- At speeds up to approximately 43 mph (70 km/h) when approaching stationary pedestrians and cyclists

#### **Situation-dependent brake force boosting**

From a speed of approximately 4 mph (7 km/h), situation-dependent brake force boosting may intervene in the following situations.

Vehicles without Driving Assistance Package:

- At speeds up to approximately 155 mph (250 km/h) when approaching vehicles ahead
- At speeds up to approximately 50 mph (80 km/h) when approaching cyclists ahead, pedestrians walking in the direction of travel and stationary vehicles
- At speeds up to approximately 43 mph (70 km/h) when approaching crossing pedestrians and cyclists

- At speeds up to approximately 37 mph (60 km/h) when approaching stationary pedestrians and cyclists

Vehicles with Driving Assistance Package:

- At speeds up to approximately 155 mph (250 km/h) when approaching vehicles ahead
- At speeds up to approximately 75 mph (120 km/h) when approaching crossing vehicles, pedestrians and cyclists
- At speeds up to approximately 62 mph (100 km/h) when approaching stationary vehicles
- At speeds up to approximately 50 mph (80 km/h) when approaching cyclists ahead
- At speeds up to approximately 43 mph (70 km/h) when approaching stationary pedestrians and cyclists

#### **Canceling a brake application by Active Brake Assist**

You can cancel a brake application by Active Brake Assist at any time:

- by fully depressing the accelerator pedal or with kickdown.
- by releasing the brake pedal.

Active Brake Assist may cancel the brake application when one of the following conditions is fulfilled:

- You maneuver to avoid the obstacle.
- There is no longer a risk of collision.
- An obstacle is no longer detected in front of your vehicle.

#### **Reaction to oncoming road users (only vehicles with Driving Assistance Package)**

Active Brake Assist can also react to detected oncoming road users:

- Reaction up to a speed of approximately 62 mph (100 km/h)
- Warning for oncoming road users via warning tone and distance warning lamp 

- Autonomous brake application in order to reduce the severity of an accident

### Intersection start-off function (vehicles with Driving Assistance Package only)

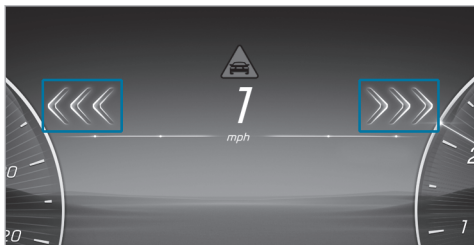

If a risk of collision with crossing vehicles is detected when you are pulling away or driving at walking pace, three red arrows pointing in the direction of the crossing road user together with the distance warning lamp  will light up one after the other on the driver's display. If the situation is particularly critical, the arrows will flash. A warning tone will also sound. If you do not react to the warning in critical situations, acceleration may be restricted or autonomous braking may be

initiated. Autonomous braking can also prevent the vehicle from pulling away and hold it at a standstill. In particularly critical situations, Active Brake Assist can also initiate autonomous braking directly. In this case, the distance warning lamp  and the warning tone will occur at the same time as the brake application.

If autonomous braking or situation-dependent brake force boosting has occurred, a pop-up will appear on the driver's display and then automatically disappear after a short time.

In the **Late** setting of Active Brake Assist, the purely visual warning level and the limitation of possible acceleration will be deactivated. If the situation is particularly critical, a visual warning can still be issued, a warning tone can be emitted and autonomous braking may be initiated.

### Evasive Steering Assist

#### **WARNING** Risk of accident despite Evasive Steering Assist

Evasive Steering Assist cannot always recognize objects or complex traffic situations clearly.

Moreover, the steering support provided by Evasive Steering Assist is not sufficient to avoid a collision.

- ▶ Always pay careful attention to the traffic situation; do not rely on Evasive Steering Assist alone.
- ▶ Be prepared to brake or swerve if necessary.
- ▶ End the support by actively steering in non-critical situations.
- ▶ Drive at an appropriate speed if there are pedestrians close to the path of your vehicle.



Evasive Steering Assist has the following characteristics:

- Detection of pedestrians, cyclists and vehicles.
- Assistance through power-assisted steering if a swerving maneuver is detected.
- Activation by an abrupt steering movement during a swerving maneuver.
- Assistance during swerving and straightening of the vehicle.
- Reaction from a speed of approximately 12 mph (20 km/h) up to a speed of approximately 68 mph (110 km/h).

Steering support from Evasive Steering Assist can be canceled at any time by countersteering.

### System limits

Full system performance is not yet available for a short time after switching on the vehicle or after driving off. As long as the functions are restricted, the Active Brake Assist warning lamp  may also be shown on the driver's display. Depending on the environmental conditions, it may take a

few minutes before full system performance is available.

The system may be impaired or may not function, particularly in the following situations:

- In snow, rain, fog, heavy spray, direct sunlight or greatly varying ambient light, or if there is glare.
- If the sensors are dirty, fogged up, damaged or covered. (→ page 222)
- If the sensors are impaired due to interference from other radar sources, e.g. strong radar reflections in parking garages.
- If a loss of tire pressure or a defective tire has been detected and displayed.
- In complex traffic situations where objects cannot always be clearly identified.
- If pedestrians, cyclists or vehicles move quickly into the sensor detection range.
- If road users are hidden by other objects or are located close to other objects.
- If the typical outline of a pedestrian or cyclist cannot be distinguished from the background.

- If a pedestrian or cyclist is not detected as such, e.g. due to special clothing or other objects.
- If the driver's seat belt is not fastened.
- On bends with a tight radius.

### Setting Active Brake Assist

#### Requirements

- The vehicle is switched on.



Multimedia system:

  **» Settings » Assistance**  
**» Collision Avoidance**

 Activate or deactivate the function.

 It is recommended that you always leave Active Brake Assist activated.

When Active Brake Assist is deactivated, the distance warning function, the collision warning, the autonomous braking function and Evasive Steering Assist will be deactivated.

 If Active Brake Assist is deactivated, the  symbol will appear on the status bar of the driver's display, and the system will be reactivated the next time the vehicle is started.

### Setting the time of the warnings

- ▶ Select  next to **Active Brake Assist**.
- ▶ Select **Early**, **Medium** or **Late**.

### Traffic Sign Assist

#### Function of Traffic Sign Assist

- ① This function is an on-demand feature (→ page 24).

Traffic Sign Assist detects the traffic signs with the multifunction camera and compares them with the information on the digital road map of the navigation system. It assists you by displaying detected speed limits and overtaking restrictions on the driver's display. The maximum permissible speed can also be shown on the head-up display.

The system can issue a warning when you exceed the maximum permissible speed.

In some countries, the system can provide you with further functions and can warn you when you are approaching pedestrian crossings or when you are about to drive past stop signs or red lights unintentionally.

The camera can also detect and analyze traffic signs with a restriction indicated by an additional sign (e.g. when wet).

Traffic Sign Assist portrays only selected signs on the driver's display. Actual traffic signs and speed limits have priority over traffic signs and speed limits shown on the driver's display.

#### Notes on trailer operation

- ① Also observe the notes on towing a trailer (→ page 296).

If a trailer or bicycle rack is connected correctly, the query about the trailer type and its maximum permissible speed will appear on the central display (→ page 299).

It is the driver's responsibility to manually adjust the maximum permissible speed in the **small or large trailer** category.

In particular, the country-specific laws must be taken into account, e.g. regarding the:

- maximum design speed or maximum permissible speed
- gross vehicle weight rating with or without towing vehicle

- required number of years holding a corresponding driver's license
- type and condition of the road currently being traveled on
- weather conditions

The maximum permissible speed adapted to the car/trailer combination can be transferred to manual or automatic speed adoption during a journey (equipment-dependent).

The system can take relevant additional signs for speed limits and clear traffic rules pertaining to the road category into account for the car/trailer combination (country-dependent).

No maximum permissible speed can be selected for a bicycle rack in the multimedia system. When using a bicycle rack, observe the specifications for the maximum permissible speed in the manufacturer's operating instructions.

Also observe the following information:

- select a speed adapted to the traffic, surroundings and weather conditions
- observe actual traffic signs

- observe applicable traffic rules and regulations

Observe the notes on driving systems and your responsibility; you may otherwise fail to recognize dangers (→ page 221).

### Displays on the driver's display

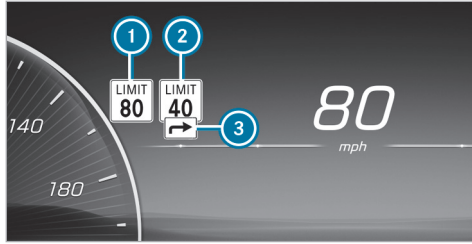

- ① Permissible speed
- ② Permissible speed when there is a restriction
- ③ Additional sign with restriction

The system can show up to two traffic signs on the driver's display simultaneously. The system always prioritizes displaying speed limits. No more

than one traffic sign with a maximum permissible speed can be shown on the head-up display. If two speed signs are shown on the driver's display, e.g. when restrictions are detected, the value of left-hand speed limit ① is always transmitted to cruise control or Active Distance Assist DISTRONIC for adoption and is shown on the head-up display.

Important information from other systems can lead to the traffic signs fading out for a short time.

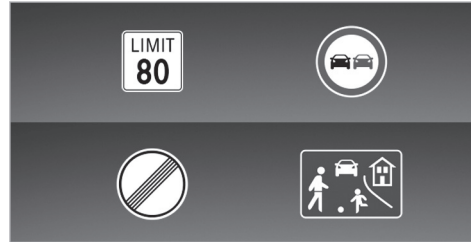

Examples of traffic signs which can be displayed

Traffic Sign Assist can detect and display the following traffic signs ①:

- Speed limitations
- End of the speed limit
- Overtaking restrictions
- Play streets
- Recommended speeds

Traffic Sign Assist can detect the following additional signs ③ and, if necessary, analyze the relevance of the restrictions using other vehicle sensors:

- When wet
- Slippery road surfaces
- In fog
- Temporary restrictions
- Exits
- Restrictions for car/trailer combinations

Traffic Sign Assist also uses data from the digital street map in the navigation system. When you leave or enter a municipality or change roads, on a highway on- or off-ramp, for example, or after

you turn at an intersection, the display on the driver's display can thus be updated without a traffic sign having been detected.

- ① Regularly update the digital road map of the navigation system to enable Traffic Sign Assist to work optimally.

Depending on vehicle equipment and country, the system can also display speed restrictions ahead on the driver's display and on the head-up display. The driver's display can also show the distance to an upcoming lower limit speed. For this purpose, information from the digital road map of the navigation system is used. The **Assistance** menu can also display a dynamic visualization of the speed limits ahead.

If Traffic Sign Assist cannot determine the currently applicable maximum permissible speed (e.g. due to missing signs), the following display appears on the driver's display:



Traffic Sign Assist is not available in all countries. If the vehicle is in a country where Traffic Sign Assist is not supported, this is displayed continuously.

If Traffic Sign Assist is temporarily or permanently unavailable due to a technical fault or if the windshield is dirty, the Traffic Sign Assist warning lamp  will appear on the driver's display.

- ① Please also note the information on the display messages of Traffic Sign Assist (→ page 457).

#### Warning when the maximum permissible speed is exceeded

The system can warn you if you unintentionally exceed the maximum permissible speed. Depending on the country, you can set in the multimedia system by how much the maximum permitted speed may be exceeded before a warning is given. You can switch off the warning or set whether the warning should be visual (by flashing the traffic sign on the driver's display) or visual and audible. The selected setting is confirmed by an indication on the driver's display.

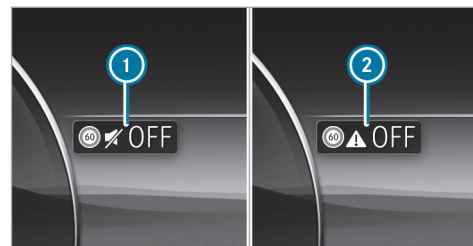

- ① Warning only visual
- ② Warning off

- ① The type, duration and deployment thresholds of the speed warning as well as the possibility of setting the deployment thresholds from which the warning is to be triggered are subject to the country-specific legislation of the country in which the vehicle is delivered.

#### Additional functions of Traffic Sign Assist (country-specific)

**Warning for no-entry signs:** Traffic Sign Assist can warn you if you drive the wrong way down a sec-

tion of road, for example on highway on-ramps or one-way streets.

**Warning at pedestrian crossings:** if you approach pedestrian crossings, provided that pedestrians are in the danger zone or are moving towards it, Traffic Sign Assist can warn you up to a speed of approximately 44 mph (70 km/h).

**Warning at stop signs:** Traffic Sign Assist can warn you up to a speed of approximately 44 mph (70 km/h) if you are about to drive past a stop sign unintentionally. For this to be possible, the signs must be clear, for example if the system detects more than one stop sign, or a stop sign can be confirmed using the digital navigation map. No warning can be issued if several different signs are detected.

**Warning at red lights:** Traffic Sign Assist can warn you up to a speed of approximately 44 mph (70 km/h) if you are about to drive through a red light unintentionally.

For this to happen, the following conditions must be met:

- Several traffic lights have been detected.
- All traffic lights detected are red.

- At least one of the red traffic lights detected is on the front passenger side beside the vehicle's own lane.
- The traffic lights are in the following sequence (from top to bottom): red, yellow, green.

**i** You can activate or deactivate the warning function in the Traffic Sign Assist menu under [Further Warnings](#) (→ page 260).

#### System limits

The system may be impaired or may not function particularly in the following situations:

- If visibility is poor, e.g. due to insufficient illumination of the road, highly variable shade conditions, rain, snow, fog, swirling dust or heavy spray.
- If there is glare, e.g. from oncoming traffic, direct sunlight or reflections.
- If there is dirt on the windshield in the vicinity of the multifunction camera or if the camera is fogged up, damaged or obscured.
- If the traffic signs are difficult to see because, for example, they are dirty, obscured, faded,

iced over, damaged, inconveniently positioned, insufficiently illuminated or distorted.

- Active traffic signs with LED displays may not be detected correctly or at all due to technical factors, such as transmission frequency.
- If the information on the navigation system's digital map is incorrect, incomplete or out of date.
- If the signs, road markings or road layout are ambiguous, e.g. in the case of traffic signs in construction sites, at exits and driveways, in the case of adjacent lanes or parallel roads, in the case of pedestrian crossing markings at traffic lights
- If the signage or road markings do not comply with the standard
- If the signage, road markings or road guidance is country-specific and deviates from the route guidance of the navigation system, e.g. in or after road works
- After sharp turns and tight bends, when traffic signs are outside the camera's field of vision.
- If you overtake vehicles with traffic signs which are affixed or attached to them.

- If you are using transport equipment secured to the vehicle with a trailer coupling, such as a bicycle rack, restrictions for car/trailer combinations may be considered valid if applicable.

### ■ Setting Traffic Sign Assist

Multimedia system:

→  » Settings » Assistance  
» Assistance » Traffic Sign Assist

### Activating or deactivating the speed warning

- ▶ Switch off **Speed Limit Warning**.  
Following country-specific legislation, the speed warning will remain off until the next time the vehicle is switched on or off and the driver's door is opened (depending on the equipment).

### Change the type of speed warning

- ▶ Change the warning to **Visual** or **Visual & Audible**.

### Setting the warning threshold

This value determines the speed at which a warning is issued when exceeded.

- ▶ Set the desired speed under **Warning Threshold**.

### Activating or deactivating further functions of Traffic Sign Assist

- ▶ Switch **Further Warnings** on or off.  
The available functions are switched on or off.

### Set the type of warning for other functions

- ▶ Select **Visual** or **Visual & Audible**.

### Traffic light view

#### ■ Information about the traffic light view

The traffic light view supports the driver when waiting in front of a red light by displaying the camera image on the central display. The camera image is displayed when the driver is the first vehicle in front of the red light and faded out when the vehicle drives off.

#### ■ Displaying traffic light view

#### Requirements:

- The **Traffic Light View** option is switched on .
- A traffic light view is available.



Multimedia system:

→  » Settings » Assistance  
» Assistance » Traffic Light View

 This function is not available in all countries.

If the vehicle is in first position at a traffic light, the camera image with traffic light view is shown on the central display.

When the vehicle pulls away, the camera image is faded out.

- ▶ Activate  or deactivate  **Traffic Light View**.

### Using other available functions

- ▶ Select .
- ▶ Select **On Request** or **Automatic**.  
If **On Request** is set and a traffic light view is available, the **Tap Here for Traffic Light View** message is displayed. The camera image is shown after confirmation of the message.  
When **Automatic** is set, the camera image is automatically displayed when the traffic light view is available.

## Blind Spot Assist and Active Blind Spot Assist

### Function of Blind Spot Assist and Active Blind Spot Assist with exit warning

Blind Spot Assist and Active Blind Spot Assist use radar sensors to monitor the area up to 130 ft (40 m) behind and 10 ft (3 m) next to your vehicle.

The system can detect vehicles traveling at speeds of approximately 8 mph (12 km/h) and above and issue a warning if they move into the monitoring range.

Status indicator on the driver's display



**Grey:** the system is activated but inoperative.



**Green:** the system is activated and operational.

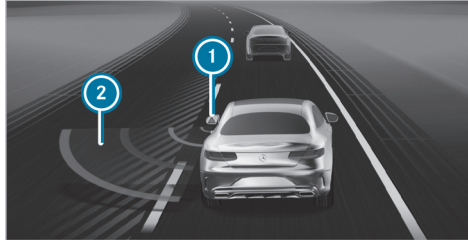

Indicator on the driver's display on the **Assistance** menu

- ① Warning lamp on the outside mirror
- ② Red radar waves

If a vehicle is detected at speeds above approximately 8 mph (12 km/h) and this vehicle enters the warning range immediately afterwards, the warning lamp on the corresponding outside mirror will light up red. On the **Assistance** menu, the lamp on outside mirror ① will also light up red, and the lane in which the vehicle is detected will be hatched out.

If a vehicle is detected in the warning range and you switch on the turn signal indicator in the cor-

responding direction, a double warning tone will sound once and the warning lamp on the corresponding outside mirror will flash red. Red radar waves ② will be displayed next to your vehicle on the assistant display.

If the turn signal indicator remains on, the indicator on the outside mirror will flash for all other detected vehicles, but no further warning tone will sound. If you overtake a vehicle quickly, no warning will be given.

① **Vehicles with active ambient lighting:** If **Warning Support** is activated, the warning will also be highlighted by the ambient lighting (→ page 143).

Observe the notes on driving systems and your responsibility; you may otherwise fail to recognize dangers (→ page 221).



**WARNING** Risk of accident despite Blind Spot Assist

Blind Spot Assist does not react to vehicles approaching and overtaking you at a greatly different speed.

Blind Spot Assist cannot warn drivers in this situation.

- ▶ Always pay careful attention to the traffic situation and maintain a safe distance at the side of the vehicle.

#### **▲ WARNING** Risk of accident despite Active Blind Spot Assist

Active Blind Spot Assist does not react to the following:

- if you overtake a vehicle too closely so that it is in the blind spot area
- if vehicles traveling at a much faster speed approach and then overtake

Active Blind Spot Assist may not give warnings or intervene in such situations.

- ▶ Always pay careful attention to the traffic situation and maintain a safe distance at the side of the vehicle.

#### **Exit warning**

The exit warning is an additional function of Blind Spot Assist and Active Blind Spot Assist and can

warn vehicle occupants attempting to leave a stationary vehicle about approaching vehicles.

#### **▲ WARNING** Risk of accident despite exit warning

The exit warning neither reacts to stationary objects nor to persons or road users approaching you at a greatly differing speed.

The exit warning cannot warn drivers in these situations.

- ▶ Always pay particular attention to the traffic situation when opening the doors and make sure there is sufficient clearance.

If a vehicle is detected in the monitoring range, the red warning lamp on the corresponding outside mirror will light up.

If a vehicle occupant pulls the door handle on the side of the warning, a warning tone will sound twice and the ambient lighting on the respective door and the warning lamps on the corresponding outside mirror will flash red.

**i** **Vehicles with ambient lighting or active ambient lighting:** the **Warning Support** of the ambient lighting can be activated and deactivated (→ page 143).

**i** Warning Support may differ depending on the equipment and may vary according to the setting.

This exit warning is available only when Blind Spot Assist or Active Blind Spot Assist is active.

After the vehicle is switched off, the exit warning will continue to function for a few minutes. When the outside mirror warning lamp flashes three times, the exit warning is no longer available.

The exit warning is only an aid and not a substitute for the attention of vehicle occupants. The responsibility for opening and closing the doors and for leaving the vehicle remains with the vehicle occupants.

#### **System limits**

Blind Spot Assist and Active Blind Spot Assist may be limited in the following situations, in particular:

- if there is dirt on the sensors or the sensors are obscured



- in poor visibility, e.g. due to fog, heavy rain or snow
- if there are narrow vehicles, e.g. bicycles or motorbikes
- if the road has very wide or narrow lanes
- if vehicles are not driving in the middle of their lanes

Warnings may be issued in error if you are driving close to crash barriers or similar continuous lane borders. Always make sure that there is sufficient distance to the side for other traffic or obstacles.

Warnings may be interrupted if you drive alongside long vehicles, such as trucks, for a prolonged time.

Blind Spot Assist and Active Blind Spot Assist will not be operational when reverse gear is engaged.

Blind Spot Assist and Active Blind Spot Assist will not be operational if transport equipment, such as a trailer or bicycle rack, is attached to the trailer hitch and the electrical connection has been correctly established.

Additionally, the exit warning may be limited in the following situations:

- when the sensors are blocked by adjacent vehicles in narrow parking spaces
- when people are approaching the vehicle
- in the event of stationary or slowly moving objects

#### Function of the brake application of Active Blind Spot Assist

- ① The brake application function is available only for vehicles with a Driving Assistance Package.

If Active Blind Spot Assist detects a risk of a side impact in the monitoring range, a course-correcting brake application is carried out. This is designed to help you avoid a collision.

The course-correcting brake application is available in the speed range between approximately 20 mph (30 km/h) and approximately 125 mph (200 km/h).

#### **⚠ WARNING** Risk of accident despite brake application of Active Blind Spot Assist

A course-correcting brake application cannot always prevent a collision.

- ▶ Always steer, brake or accelerate yourself, especially if Active Blind Spot Assist warns you or makes a course-correcting brake application.
- ▶ Always maintain a safe distance at the sides.



If a course-correcting brake application occurs, the red warning lamp flashes in the outside mirror and a warning tone sounds. In addition, display

① indicating the danger of a side collision appears on the driver's display.

In rare cases, the system may make an inappropriate brake application. This brake application may be canceled at any time by steering slightly in the opposite direction or accelerating.

### System limits

Note the system limits of Active Blind Spot Assist; you may otherwise fail to recognize dangers (→ page 261).

Either a course-correcting brake application appropriate to the driving situation or none at all may occur in the following situations in particular:

- Vehicles or obstacles, e.g. crash barriers, are located on both sides of your vehicle.
- A vehicle approaches too closely at the side.
- You have adopted a sporty driving style with high cornering speeds.
- You brake or accelerate significantly.
- A driving safety system intervenes, e.g. ESP® or Active Brake Assist.
- ESP® is deactivated.

- A loss of tire pressure or a defective tire is detected.
- Transport equipment (e.g. a trailer or bicycle rack) is attached to the trailer hitch and the electrical connection has been correctly established.

### ■ Activating/deactivating Blind Spot Assist or Active Blind Spot Assist

Multimedia system:

→  » Settings » Assistance  
» Collision Avoidance

▶ Switch **Active Blind Spot Assist** on or off.

### Active Lane Keeping Assist

#### ■ Function of Active Lane Keeping Assist

Active Lane Keeping Assist monitors the area in front of your vehicle by means of the multifunction camera (→ page 222) and can warn you before you leave your lane unintentionally. The system can guide you back into your lane by means of a course-correcting steering intervention and will also issue a warning via haptic feedback through the steering wheel. Active Lane Keeping Assist is

available in the speed range between 37 mph (60 km/h) and 124 mph (200 km/h).

The system can intervene in the following situations:

- Active Lane Keeping Assist detects a lane marking.
- One of your front wheels goes over a lane marking.

If you activate the turn signal indicator, no steering intervention will occur on the corresponding side.

If you leave the lane without activating the turn signal indicator, but danger of a collision with a moving obstacle is detected in your lane, no steering intervention will occur.

**Vehicles with Blind Spot Assist or Driving Assistance Package:** if the system detects an obstacle, such as another vehicle in the adjacent lane, steering intervention will occur regardless of the turn signal indicator.



Indicator ❶ will appear on the driver's display and a warning tone will sound in the following situations:

- A steering intervention by Active Lane Keeping Assist lasts longer than approximately ten seconds.
- The system carries out two or more steering interventions within approximately three minutes without any steering intervention from the driver.

In the Active Lane Keeping Assist settings, you can set the sensitivity of the system and the level of support. Additionally, you can set whether the

system should react to broken lane markings or only continuous lane markings (→ page 267).

If ATTENTION ASSIST has detected indications of fatigue, the most sensitive setting will automatically be selected (→ page 230).

#### Status displays for Active Lane Keeping Assist



**White:** Active Lane Keeping Assist is deactivated.

If ESP® is deactivated or a tire pressure loss warning is displayed, Active Lane Keeping Assist will automatically be deactivated.



**Yellow:** there is a malfunction. Please also observe the display messages.



**Gray:** Active Lane Keeping Assist is activated, but not operating.



**Green:** Active Lane Keeping Assist is activated and operating. If the system is operational on only one side, the lane marking will be shown in green on the corresponding side.



**Red:** Active Lane Keeping Assist has guided you back into your lane with a course-

correcting steering intervention. The status display will flash if there is also a haptic warning in the steering wheel. The lane marking will be shown in red only on the side for which there is a warning.

**Vehicles without Driving Assistance Package:** if both lane markings are simultaneously shown in red on the status indicator, Active Lane Keeping Assist has initiated an emergency stop (→ page 245).



Indicator on the driver's display on the [Assistance](#) menu

If the front wheel of the vehicle drives over a detected lane marking, this will be highlighted red on the **Assistance** menu on the driver's display.

**i Vehicles with active ambient lighting:** If **Warning Support** is activated, the Active Lane Keeping Assist warning will also be accompanied by ambient lighting (→ page 143).

### System limits

In the following situations, a lane-correcting steering intervention may not occur but rather a warning may be given on the steering wheel, depending on the situation:

- You clearly and actively steer, brake or accelerate.
- If a driving safety system intervenes, such as ESP®, Active Brake Assist or Active Blind Spot Assist.
- If you have adopted a sporty driving style with high cornering speeds or high rates of acceleration.
- If transport equipment, for example a trailer or bicycle rack, is attached to the trailer hitch

and the electrical connection has been correctly established.

The system may be impaired or may not function particularly in the following situations:

- If there is poor visibility, e.g. due to insufficient illumination of the road, highly variable shade conditions, rain, snow, fog or heavy spray.
- If there is glare, e.g. from oncoming traffic, the sun or reflections.
- If there is dirt on the windshield in the vicinity of the multifunction camera or if the camera is fogged up, damaged or obscured.
- If there is dirt on the bumper in the area of the radar sensors, or if they are damaged or obscured.
- If there are no lane markings, or several unclear lane markings are present for one lane, e.g. around roadworks.
- If the lane markings are worn, dark or covered.
- If the distance to the vehicle in front is too short and thus the lane markings cannot be detected.

- If the lane markings change quickly, e.g. lanes branch off, cross one another or merge.
- If the road is very narrow and winding.

Observe the notes on driving systems and your responsibility; you may otherwise fail to recognize dangers (→ page 221).

### ■ Activating/deactivating Active Lane Keeping Assist

Multimedia system:

-  » **Settings** » **Assistance**  
» **Collision Avoidance**  
» **Active Lane Keeping Assist**  
▶ Activate or deactivate the function.

Alternatively, Active Lane Keeping Assist can be activated and deactivated via the  quick vehicle access.

**i** The settings after engine start are country-specific.

### Setting Active Lane Keeping Assist

Multimedia system:

-  » Settings » Assistance
- » Collision Avoidance
- » Active Lane Keeping Assist

### Setting the sensitivity

- ▶ Select .
- ▶ Select **Early**, **Med.** or **Late**.

The last selected setting will be adopted the next time the vehicle is started.

- ⓘ The standard setting for this function is dependent on the country.

### Activating or deactivating assistance on dashed lane markings

- ▶ Select **Advanced Support**.

The last selected setting will be adopted the next time the vehicle is started.

- ⓘ The standard setting for this function is dependent on the country.

- ⓘ This function must be activated in vehicles without Driving Assistance Package, so that Emergency Stop Assist is fully available. Further information on Emergency Stop Assist (→ page 245)

### Rear view camera

#### Function of the rear-view camera

The rear-view camera is only an aid. It is not a substitute for your attention to the surroundings. The responsibility for safe maneuvering and parking remains with you. Make sure that no persons, animals, objects etc. are in the maneuvering area while you are maneuvering and parking.

- ⓘ The area behind the vehicle will be displayed as a mirror image, as in the inside rear-view mirror.

The following camera views are available on the central display:

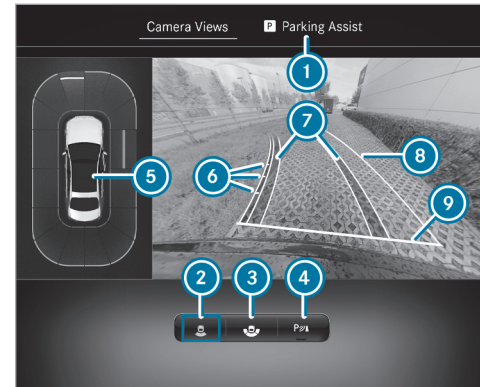

Camera Views menu (top view)

- ① Parking Assistance menu
- ② Rear-view camera with top view
- ③ Wide-angle view
- ④ Activating/deactivating Parking Assist PARKTRONIC (→ page 279)
- ⑤ Warning display of Parking Assist PARKTRONIC (→ page 276)

- ⑥ Guide lines at a distance of approximately 1.6 ft (0.5 m), 3.3 ft (1.0 m), 5 ft (1.5 m) and 9.9 ft (3.0 m) from the rear area
- ⑦ Lane marking the course the tires will take with the current steering movement (dynamic)
- ⑧ Area that will be driven over based on the current steering movement (dynamic)
- ⑨ Guide line at a distance of approximately 1.0 ft (0.3 m) from the rear area
- ① When Active Parking Assist is active, lane markings ⑦ will be displayed in green (→ page 280).



Wide-angle view

- ⑤ Warning display of Parking Assist PARKTRONIC (→ page 276)

#### System limits

If the system is not ready for operation, the **System Inoperative** message will appear on the central display.

The rear-view camera will not function or will function only partially in the following situations:

- You are driving forwards at a speed greater than approximately 10 mph (16 km/h).
  - The tailgate is open.
  - The weather conditions are poor (e.g. heavy rain, snow, fog, storm or spray).
  - The ambient light is poor (e.g. at night or if light is shining into the camera).
  - The camera lens is obstructed, dirty or fogged up. Observe the notes on cleaning the rear-view camera (→ page 383).
  - The camera or rear of your vehicle is damaged. In this case, have the camera and its position and setting checked at a qualified specialist workshop.
- ① Do not use the rear-view camera in these types of situations. You could otherwise injure others or collide with objects when parking the vehicle.

The field of vision and other functions of the camera system may be restricted due to additional

attachments on the vehicle (e.g. license plate bracket or bicycle rack).

- ❗ The contrast of the display may be impaired by direct sunlight or by other light sources (e.g. when you are driving out of a garage). In this case, pay particular attention.
- ❗ Have the display repaired or replaced if, for example, pixel errors considerably restrict its use.

Also observe the information on vehicle sensors and cameras (→ page 222).

### 360° camera

#### Function of the 360° camera

The 360° camera is a system that consists of four cameras which cover the immediate surroundings of the vehicle. The cameras assist you when you are parking, for example, or at exits with reduced visibility.

The 360° camera includes the following cameras and evaluates their images:

- Rear view camera
- Front camera

- Two outside mirror cameras

The cameras are only an aid and may show a distorted view of obstacles, show them incorrectly or not show them at all. They are not a substitute for your attention to the surroundings. The responsibility for safe maneuvering and parking remains with you. Make sure that there are no persons, animals or objects etc., in the maneuvering area while maneuvering and parking.

The following camera views are available on the central display:

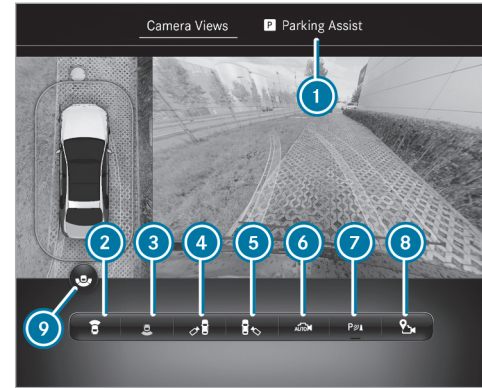

#### Camera Views menu overview

- ① Menu **Parking Assistance**
- ② Top view with image from the front camera
- ③ Top view with image from the rear view camera
- ④ 3D view, left-hand side of the vehicle
- ⑤ 3D view, right-hand side of the vehicle
- ⑥ 3D auto view

- ⑦ To activate/deactivate Parking Assist PARKTRONIC (→ page 279)
- ⑧ To set the GPS activation point (→ page 275)
- ⑨ To switch between standard and wide-angle view
- ⓘ In all views, the Parking Assist PARKTRONIC warning display is shown (→ page 276).

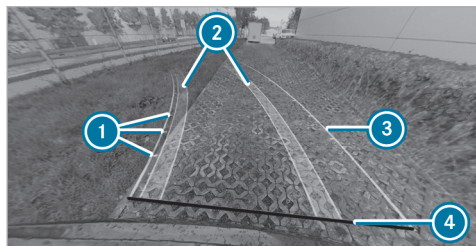

Function of the guide lines

- ① Guide lines at a distance of approximately 1.6 ft (0.5 m), 3.3 ft (1.0 m), 5 ft (1.5 m) and 9.9 ft (3.0 m) from the rear area
- ② Lane marking the course the tires will take with the current steering angle (dynamic)

- ③ Driven surface depending on the current steering angle (dynamic)
- ④ Guide line at a distance of approximately 1.0 ft (0.3 m) from the rear area
- ⓘ When Active Parking Assist is active, lanes and guide lines are displayed in green instead of yellow (→ page 280).

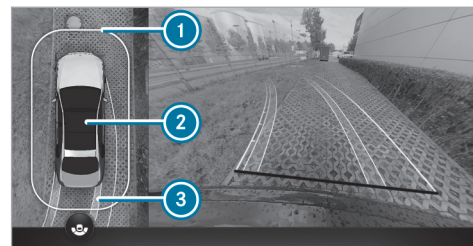

Top view with image from the front or rear view camera

- ① Warning display of Parking Assist PARKTRONIC (→ page 276)
- ② Your vehicle from above
- ③ Lane indicating the route the vehicle will take at the current steering angle

**⚠ WARNING** Risk of accidents due to objects not being displayed or being displayed in a distorted manner

Due to the projection of the cameras, objects in the 3D views may be strongly distorted or not displayed at all.



- ▶ Make sure that there are no persons, animals or objects etc., in the maneuvering area while maneuvering and parking.



3D view, left/right-hand side of the vehicle

- ① Display of Parking Assist PARKTRONIC (→ page 276)

In the 3D view, left/right-hand side of the vehicle, the virtual camera moves to the respective side of the vehicle. When you change the transmission position, the view is automatically adapted.

- ⓘ The area behind the vehicle is **not** displayed as a mirror image as is usual in the 3D views.

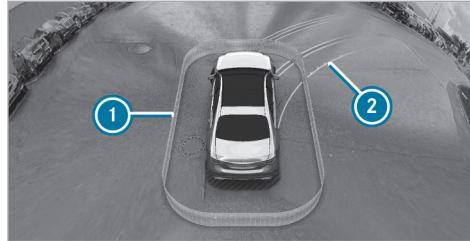

3D auto view

- ① Display of Parking Assist PARKTRONIC (→ page 276)
- ② Guide lines

In the 3D auto view, the virtual camera moves to the standard perspective, facing forward from the rear above the roof. The view changes automatically when approaching obstacles.

If you touch the touchscreen, the view changes to the 3D view with free rotation. You can turn, tilt and zoom the views by touch.



Wide-angle view

- ① Display of Parking Assist PARKTRONIC (→ page 276)
- ② To switch between standard and wide-angle view

If you select trailer view and no trailer is coupled to the vehicle, the following display appears:

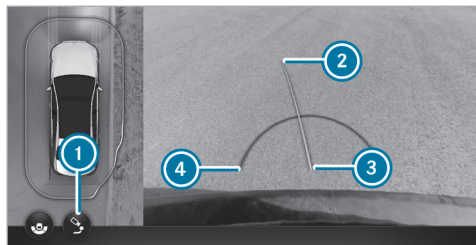

#### Trailer view

- ① To switch between standard and trailer view
  - ② Yellow guide line, locating aid
  - ③ Ball head of the trailer hitch
  - ④ Red guide line at a distance of approximately 1.0 ft (0.3 m) from the ball head of the trailer hitch
- ⓘ In trailer mode, the guide lines are shown at the level of the trailer hitch.

When the electrical connection is established between the vehicle and the trailer, the display changes to the side camera view.

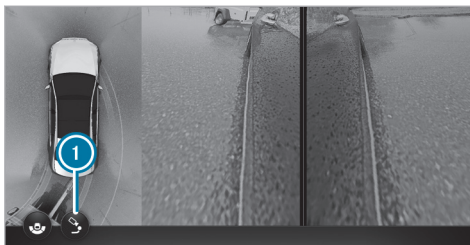

#### Side view from the outside mirror cameras in trailer view

- ① To switch between standard and trailer view

#### System limits

If the system is not ready for operation, the **System Inoperative** message will appear on the central display.

**⚠ WARNING** Risk of accident due to restrictions in the function of the 360° camera

If the function of the 360° camera is restricted, there is a risk of collision with people or objects.

- ▶ Do not use the 360° camera in the event of function restrictions.
- ▶ Make sure that there are no persons, animals or objects etc., in the maneuvering area while maneuvering and parking.

The 360° camera will not function or will only partially function in the following situations:

- You are driving forwards at a speed greater than approximately 10 mph (16 km/h).
- The doors are open.
- An outside mirror is not completely folded out.
- The tailgate is open.
- The weather conditions are poor, e.g. heavy rain, snow, fog, storm or spray.
- The ambient light is poor, e.g. at night or if light is shining into the camera.
- The camera lens is obstructed, dirty or fogged up. See the notes on cleaning the 360° camera (→ page 383).
- If cameras or vehicle components in which the cameras are installed are damaged. In this event, have the cameras, their positions and

their setting checked at a qualified specialist workshop.

For technical reasons, the standard height of the vehicle may be altered if the vehicle is carrying a heavy load and can result in inaccuracies in the guide lines and in the display of the generated images.

The field of vision and other functions of the camera system may be restricted due to additional attachments on the vehicle, e.g. license plate bracket or bicycle rack.

- ❗ The contrast of the display may be impaired by abrupt, direct sunlight or by other light sources, e.g. when you are driving out of a garage. In this case, pay particular attention.
- ❗ Have the display repaired or replaced if, for example, pixel errors considerably restrict its use.

Also observe the information on vehicle sensors and cameras (→ page 222).

#### ■ Off-road function of the 360° camera

The 360° camera can support you with different views when driving off-road.

The following views are available:

- Transparent hood
- Front view
- Rear view

To call up the function, call up the off-road menu in the multimedia system (→ page 339).

- ❗ Active Parking Assist and the maneuvering assistant functions are not available in the  drive program. Parking Assist PARKTRONIC is available in all drive programs when it is switched on. Please also note the system limits of the respective functions.

#### Transparent hood

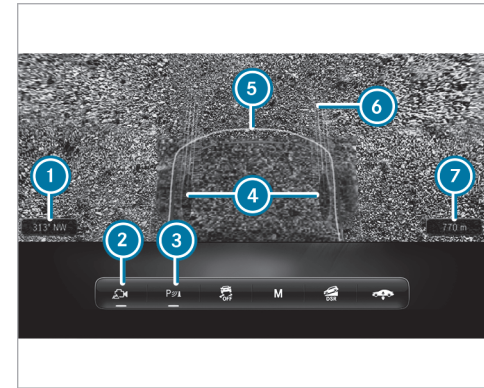

Transparent hood displays (example)

- ❶ Point of the compass
- ❷ Switches the camera perspective on or off
- ❸ Switches PARKTRONIC on or off (→ page 276)
- ❹ Position of the wheels
- ❺ Area under the hood

- ⑥ Lane indicating the route the vehicle will take at the current steering angle
- ⑦ Altitude above sea level

If the off-road menu is open in the central display and button ② is switched on, the transparent hood view is automatically displayed in transmission position **D**.

The transparent hood view shows a virtual image of the area directly in front of the bumper, in front of the tires and under the hood. In addition, the current lane is displayed. The transparent hood can assist you when driving in difficult terrain, e.g. on rocky or uneven ground.

The hatched area under the hood ⑤ was captured and recorded by the front camera. As soon as the area has been crossed by the vehicle, it is faded in. If the vehicle has not been moved for some time, the recorded area is displayed in gray-scale and faded out.

### Front and rear view

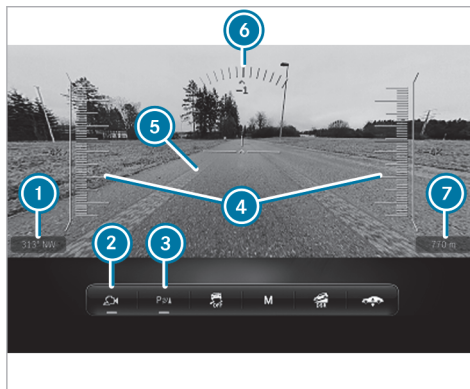

Display of front and rear view (example)

- ① Point of the compass
- ② Switches the camera perspective on or off
- ③ Switches PARKTRONIC on or off (→ page 276)
- ④ Slope indicator

- ⑤ Lane indicating the route the vehicle will take at the current steering angle
- ⑥ Inclination indicator
- ⑦ Altitude above sea level
- i Note that the area between the vehicle and up to approx. 40 in (1 m) in front of the vehicle is not displayed. The slope and inclination indicators are shown only in the front view.

If the vehicle is traveling faster than approx. 5 mph (8 km/h) the view automatically changes from transparent hood view to front view. If the vehicle is traveling at a speed greater than approximately 12 mph (20 km/h) - 19 mph (30 km/h) (depending on the drive program), the camera image will be closed.

When you engage reverse gear, the image from the rear-view camera is automatically displayed.

### System limits

The area under the hood may not be displayed correctly in the following situations:

- When it is raining

- When it is dark
- When shadows fall on the area recorded by the camera

Observe the instructions on the function of the 360° camera as well as its system limits, otherwise you may not recognize dangers (→ page 269).

### Calling up the 360° camera views using the button

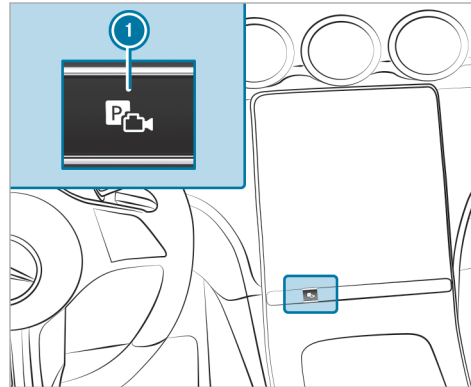

- ▶ Press button ①.
- ▶ Select **Camera Views** menu.
- ▶ Select the desired view in the multimedia system (→ page 269).

### Selecting a view for the 360° camera (reverse gear)

- ▶ Engage reverse gear.
- ▶ Select the desired view in the multimedia system (→ page 269).

### 360° Camera with GPS - managing activation positions

Multimedia system:

- ▶ ▶ **Settings** ▶ **Assistance**
- ▶ **Camera**

### Renaming an activation position

- ① You can determine activation positions in the **Camera Views** menu. (→ page 269)
- ▶ Select for the desired activation position.
- ▶ Select **Edit**.
- ▶ Enter a name and confirm.  
The activation position is saved under the new name.

### Deleting an activation position

- ▶  Select for the desired activation position.
- ▶ Select **Delete Entry**.
- ▶ Confirm the prompt.  
The activation position is deleted.

### Opening the camera cover

Multimedia system:

- ▶  ▶ **Settings** ▶ **Assistance**
- ▶ **Camera**
- ▶ Select **Open Camera Cover**.

- ▶  The camera cover closes automatically after some time or after the vehicle is switched on or off.

### Parking Assist PARKTRONIC

#### Function of Parking Assist PARKTRONIC

Parking Assist PARKTRONIC is an electronic parking assistance system that monitors the area surrounding your vehicle and shows you the distance between the vehicle and a detected obstacle visually and audibly.

The passive side impact protection also warns you of obstacles to the side. These must be detected beforehand by the sensors in the front or rear bumper while you are driving by them. If you steer in the direction of a detected obstacle and there is a risk of a lateral collision, a warning is issued.

The passive side impact protection can be activated and deactivated via the multimedia system (→ page 279).

In order for front or rear obstacles to the side to be displayed, the vehicle must first travel a distance of at least half a vehicle length. Once the vehicle has traveled one vehicle length, obstacles on all sides can be shown.

Parking Assist PARKTRONIC is only an aid. It is not a substitute for your attention to the surroundings. The responsibility for safe maneuvering and parking remains with you. Make sure that there are no persons, animals or objects in the maneuvering area while maneuvering and parking in/exiting parking spaces.

### Displays in the central display

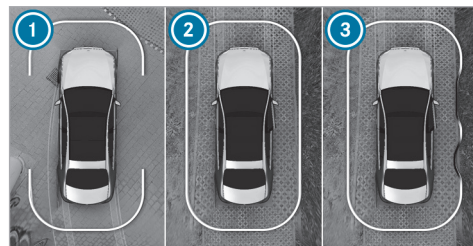

Vehicles with 360° camera

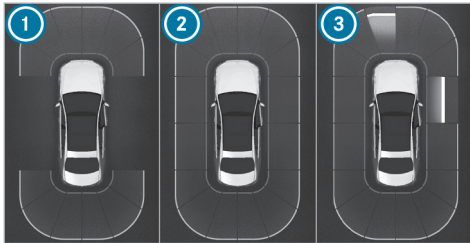

Vehicles with rear-view camera

- ① Front and rear ready for display
- ② All sides ready for display
- ③ All sides ready for display and obstacle detected

As soon as Parking Assist PARKTRONIC is ready for display, the respective areas ① to ③ of the display are shown in blue.

The color of the display changes depending on the distance to the detected obstacle:

- **Blue:** > 3.3 ft (1 m) (no obstacles detected)
- **Yellow:** approximately 3.3 ft (1 m) - 2.3 ft (0.7 m)

- **Orange:** approximately 2.3 ft (0.7 m) - 1.3 ft (0.4 m)
- **Red:** <1.3 ft (0.4 m)

**Vehicles with 360° camera:** the boundary line shifts dynamically depending on the position and distance of the obstacles detected.

Depending on the distance to the obstacle detected, an intermittent warning tone also sounds. You can set the timing of the warnings in the multimedia system. In the **Warn Early** setting, the system warns you from a distance of 3.3 ft (1 m), in the standard setting only from 1.3 ft (0.4 m).



Vehicles with 360° camera



Vehicles with rear-view camera

If you are not in the [Camera & Parking](#) menu and an obstacle in the vehicle path is detected, pop-up window ❶ appears on the central display if the following requirements are met:

- **Vehicles without Active Parking Assist:** when driving no faster than 8 mph (12 km/h).

- **Vehicles with Active Parking Assist:** when driving no faster than 11 mph (18 km/h).

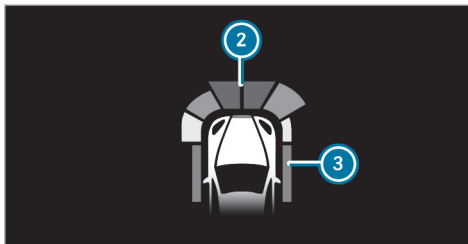

Optionally, obstacles detected by Parking Assist PARKTRONIC from a distance of approximately 3.3 ft (1.0 m) in front ❷ and 2.3 ft (0.7 m) on the sides ❸ can also be displayed on the head-up display.

#### System limits

Parking Assist PARKTRONIC does not necessarily take into account the following obstacles:

- Obstacles below the detection area, e.g. persons, animals or objects.
- Obstacles above the detection area, e.g. projecting loads, overhangs or loading ramps on trucks.
- Pedestrians or animals approaching the vehicle from the side.
- Objects placed next to the vehicle

Obstacles on the sides are not shown in the following situations, for example:

- You park the vehicle and switch it off.
- You open the doors.

After the engine is restarted, obstacles must be detected again by driving past them before a new warning can be issued.

Also observe the system limits of the following systems:

- Rear-view camera (→ page 267)
- 360° camera (→ page 269)

Observe the information on vehicle sensors and cameras; otherwise the system cannot function properly (→ page 222).



**Vehicles with towbar:** If a transport device, e.g. trailer or bicycle carrier, is attached to the towbar and the electrical connection is correctly established, PARKTRONIC Parking Assist is deactivated for the rear zone.

### Problems with Parking Assist PARKTRONIC

If the Parking Assist PARKTRONIC display lights up red for approximately three seconds then goes out, and the  symbol appears on the driver's display, the system may have been deactivated due to signal interference. Start the vehicle again and check if Parking Assist PARKTRONIC is working at a different location.

If a warning tone also sounds, it may be due to one of the following causes:

- **The sensors are dirty:** clean the sensors (→ page 383).
- **Parking Assist PARKTRONIC has been deactivated due to a malfunction:** restart the vehicle. If the problem persists, consult a qualified specialist workshop.

### Activating/deactivating Parking Assist PARKTRONIC

**!** **NOTE** Vehicle damage during parking or maneuvering due to objects at close range

Parking Assist PARKTRONIC may not detect certain objects close to the vehicle.

- ▶ When parking or maneuvering, look out in particular for objects that are underneath or above the sensors, e.g. flower pots or drawbars. Otherwise, the vehicle or other objects could be damaged.

### Requirements

- The camera menu is open.
  - Or: the PARKTRONIC pop-up window appears.
- ▶ Tap  on the central display.

If the indicator lamp is lit, Parking Assist PARKTRONIC is active. If the indicator lamp does not light up or the symbol  is displayed, Parking Assist PARKTRONIC is not active.

- ① Parking Assist PARKTRONIC is automatically activated when the vehicle is started.

Alternatively, Parking Assist PARKTRONIC can be activated or deactivated in the quick access menu.

### Setting the warning tones of Parking Assist PARKTRONIC

Multimedia system:

- ▶  ▶ Settings ▶ Assistance
- ▶ ▶ Parking ▶ PARKTRONIC

### Adjusting warning tones

- ▶ Select **Set Warning Tones**.
- ▶ Set the desired level under **Volume** or **Tone Pitch**.

### Activating/deactivating audio fadeout

- ▶ **Audio Fadeout** select and **Audio Fade for Warnings** switch on or off.

The volume of the currently playing media source is reduced during a Parking Assist PARKTRONIC warning tone.

or

▶ **Audio Fadeout** select and **Audio Fadeout When in R** switch on or off.

The volume of the currently playing media source is reduced when reverse gear is engaged.

### Setting the time of the warnings

- ▶ Select **Time of Warning**.
- ▶ Set the desired warning time for **Front** or **Rear**.
- ▶ Switch **Side Warning** on or off.

## Active Parking Assist

### Function of Active Parking Assist

Active Parking Assist is an electronic parking assistance system, which uses ultrasound with the assistance of the rear-view camera and 360° camera. When you are driving forwards at a speed of up to approximately 22 mph (35 km/h), the system will automatically measure parking spaces on both sides of the vehicle.

Active Parking Assist is only an aid. It is not a substitute for your attention to the surroundings. The responsibility for safe maneuvering and parking

remains with you. Make sure that no persons, animals or objects etc. are in the maneuvering area.

Active Parking Assist offers the following functions:

Vehicles with rear-view camera

- Parking in parking spaces parallel to the road
- Backing up into parking spaces perpendicular to the road

Any parking space can be selected. The vehicle will be parked in reverse.

Vehicles with 360° camera

- Parking in parking spaces parallel to the road
- Parking in parking spaces perpendicular to the road (optionally either forwards or in reverse)
- Parking in parking spaces that can be detected as such only due to markings (at the roadside, for example)
- Exiting parking spaces if you have parked using Active Parking Assist

Any parking space can be selected. Depending on the location of the parking space, the parking

direction (forwards or in reverse) can also be selected as desired.

If Active Parking Assist is available, the **[P]** message will appear on the driver's display. When the system detects parking spaces, **[P]** will appear. The arrows show on which side of the road free parking spaces are located. These will then be shown on the central display.

When Active Parking Assist is activated, the turn signals will be activated based on the calculated path of your vehicle. When you are entering or exiting a parking space, the procedure will be assisted by acceleration, braking, steering and gear changes.

To start the parking procedure, press the **[P]** button (→ page 282).

Active Parking Assist will be canceled in the following situations:

- You press the **[P]** button again.
- You begin steering.
- You engage park position **[P]**.
- You apply the electric parking brake.
- ESP® intervenes.

- You open the driver's door.

### System limits

Active Parking Assist will not be available in drive program  or if the exterior lighting is malfunctioning.

Also observe the limits of the following systems:

- Rear-view camera (→ page 267)
- 360° camera (→ page 269)

Objects that are above or below the detection range of Active Parking Assist, e.g. protruding loads, overhangs or loading ramps of trucks or boundaries of parking spaces, will not be detected when the parking space is measured. These will also then not be taken into account when the parking procedure is calculated. In some circumstances, Active Parking Assist may therefore guide you into the parking space prematurely or brake too late.

Certain environmental conditions, such as snow-fall or heavy rain, may lead to a parking space being measured inaccurately. Parking spaces that are partially occupied by trailer drawbars might not be identified as such or be measured incor-

rectly. Use Active Parking Assist only on level, high-grip ground.

**⚠ WARNING** Risk of accident due to objects located above or below the detection range of Active Parking Assist

If there are objects above or below the detection range, the following situations may arise:

- Active Parking Assist may steer too early.
- The vehicle may not stop in front of these objects.

There is a danger of collision!

- ▶ In these situations, do not use Active Parking Assist.

Active Parking Assist can also display unsuitable parking spaces, e.g. parking spaces in which parking is not permitted or parking spaces on unsuitable surfaces.

Do not use Active Parking Assist in the following situations:

- In extreme weather conditions such as ice, packed snow or in heavy rain.

- When transporting a load that protrudes beyond the vehicle.
- If the parking space is on a steep incline.
- When snow chains are installed.
- When a trailer or bicycle rack is attached.
- Directly after a tire change or when spare tires are installed.
- If the tire pressure is too low or too high.
- On steep inclines of more than approximately 15%.

## Parking with Active Parking Assist

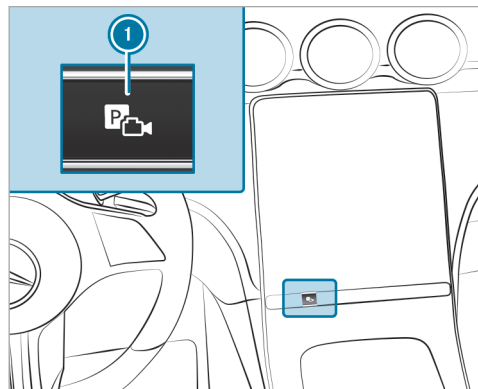

- ▶ Press button ①.

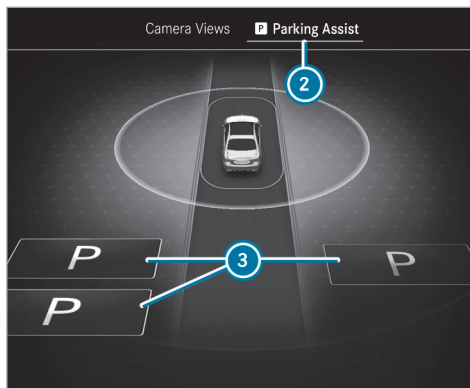

Parking assistance menu (example)

- ▶ Select the ② **Parking Assistance** menu.

Parking spaces ③ detected by the system will be shown on the central display.

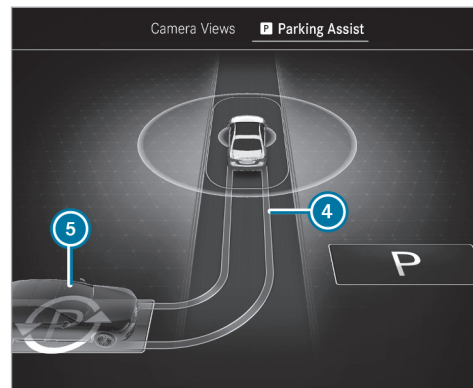

Parking assistance menu (example)

When the vehicle is stationary, indicated vehicle path ④ into currently selected parking space ⑤ will also appear.

- ▶ If a parking space is displayed: stop the vehicle.
- ▶ If necessary, select another parking space.

- ▶ **Vehicles with 360° camera:** to change the parking direction, tap the selected parking space again.
- ▶ **To start the parking procedure:** press button ① again.
- ▶ Take your hands off the steering wheel. The vehicle will drive into the selected parking space.

The turn signal indicator will be switched on automatically when the parking procedure begins. You are responsible for selecting the turn signal indicator in accordance with the traffic conditions. If necessary, select the turn signal indicator accordingly.

**⚠ WARNING** Risk of accident due to vehicle swinging out while parking or pulling out of a parking space

While parking or exiting a parking space, the vehicle swings out and can drive onto areas of the oncoming lane.

This could cause you to collide with objects or other road users.

- ▶ Pay attention to objects and other road users.
- ▶ Where necessary, stop the vehicle or cancel the parking procedure with Active Parking Assist.

On completion of the parking procedure, a display message reading **Active Parking Assist Finished** will appear.

- ▶ Secure the vehicle against rolling away. When required by legal requirements or local conditions: turn the wheels towards the curb.
- ① You can stop the vehicle and change the transmission position during the parking procedure. The system will then calculate a new vehicle path. If no new vehicle path is available, the transmission position can be changed again or the process can be canceled.



Immediate parking via the **Camera Views** menu

- ▶ Select the **Camera Views** menu.
- ▶ When the vehicle is stationary and in transmission position **R**, and symbol ⑥ appears on the camera image: press button ① again. The parking procedure will be initiated for the detected parking space.
- ① The parking space and parking direction cannot be changed in the case of immediate parking.

## Exiting a parking space with Active Parking Assist

### Requirements

- The vehicle is equipped with a 360° camera.
- The vehicle has been parked with Active Parking Assist.

- ▶ Start the vehicle.

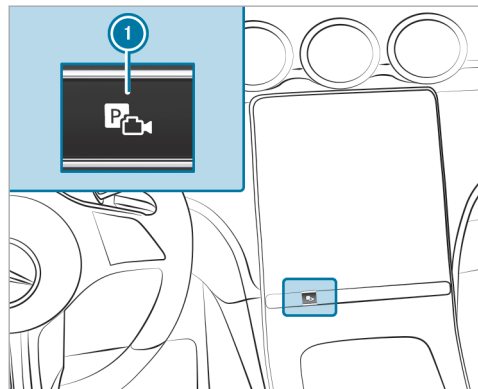

- ▶ Press button ①.

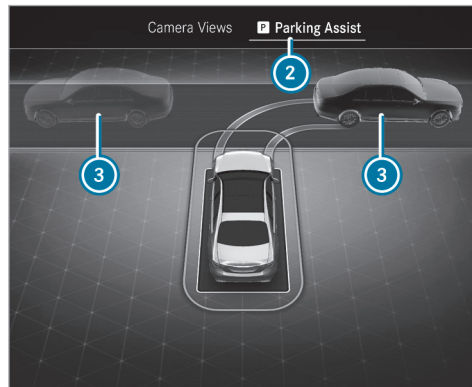

Parking assistance menu (example)

- ▶ Select the **Parking Assistance** ② menu.
- ▶ If necessary, change your direction of exit ③.
- ▶ **To start exiting the parking space:** press button ① again.

- ▶ If necessary, change the transmission position. Observe any messages displayed on the driver's display and central display. The vehicle will move out of the parking space.

The turn signal indicator will automatically be switched on when the process of exiting a parking space begins and switched off when it is completed. You are responsible for selecting the turn signal indicator in accordance with the traffic conditions. If necessary, select the turn signal indicator accordingly.

After the parking space has been exited, a warning tone and the  **Active Parking Assist Finished: Take Control of Vehicle** message will prompt you to take control of the vehicle. You will need to accelerate, brake, steer and change gear yourself again.

If you do not react to the prompt to take control of the vehicle, the system will apply the brakes to bring the vehicle to a standstill.

### Pausing Active Parking Assist

You can interrupt the parking or exiting procedure of Active Parking Assist by performing one of the following actions, for example:

- ▶ Depress the brake pedal.
- ▶ Open the front passenger door, a rear door, the tailgate or the hood.
- ▶ Apply the electric parking brake or activating the HOLD function.
- ▶ **To resume the parking or exiting procedure:** gently depress the accelerator pedal.

**i** If the electric parking brake was applied before Active Parking Assist was activated, depress the accelerator pedal lightly to start the parking or exiting procedure.

Check the area around your vehicle again before resuming a paused parking procedure. Check again that there are no persons, animals or objects in the maneuvering range. Also observe the system limitations of Active Parking Assist.

### Automatic braking function of Active Parking Assist

Persons or objects detected in the maneuvering range could cause the vehicle to brake sharply and interrupt the parking or exiting procedure. The vehicle will then be held at a standstill. If you

depress the accelerator pedal, the parking or exiting procedure is resumed.

Check the area around your vehicle again before resuming the parking or exiting procedure. Check again that there are no persons, animals or objects in the maneuvering range. Also observe the system limitations of Active Parking Assist.

### Maneuvering assistance

#### Function of Drive Away Assist

Drive Away Assist can reduce the severity of an impact when the vehicle is pulling away. If the system detects an obstacle in the direction of travel, the vehicle's speed will briefly be reduced to approximately 1 mph (2 km/h).

A risk of a collision may arise in the following situations, for example:

- If the driver mixes up the accelerator and brake pedals.
- If the driver engages an incorrect gear.
- If the driver depresses the accelerator pedal with too much force.

Drive Away Assist will be active under the following conditions:

- If the vehicle was stationary and the transmission position was changed to **R** or **D**.
- If the vehicle has rolled less than approximately 3.3 ft (1.0 m) since being at a standstill.
- If the detected obstacle is less than approximately 3.3 ft (1.0 m) away.

The **Drive-away Assist** can be deactivated or activated on the **Maneuvering Assistance** menu (→ page 288).

If a critical situation is detected, the  symbol will appear in red in the selected view on the **Camera & Parking** menu.

**i** If Drive Away Assist is not available, the  symbol will appear in grey. If the **Camera & Parking** menu is not opened on the central display, the symbol and pop-up of Parking Assist PARKTRONIC will both appear.

Drive Away Assist is only an aid. It is not a substitute for your attention to the surroundings. The responsibility for safe maneuvering and parking

remains with you. Make sure that no persons, animals, objects etc. are in the maneuvering area.

**⚠ WARNING** Risk of accident caused by limited detection performance of Drive Away Assist

Drive Away Assist cannot always clearly identify objects and traffic situations.

- ▶ Always pay careful attention to the traffic situation; do not rely on Drive Away Assist alone.
- ▶ Be prepared to brake or swerve as necessary, provided the traffic situation permits and that it is safe to take evasive action.

### System limits

Drive Away Assist is not available in drive program



The system limits of Active Parking Assist apply (→ page 280).

The performance of Drive Away Assist will be restricted on uphill gradients.

If a transport device (e.g. trailer or bicycle carrier) is attached to the hitch and the electrical connection is correctly established, Drive Away Assist will not be available when the vehicle is backing up.

### ■ Cross traffic warning function

The cross traffic warning can warn you of crossing traffic when you are exiting a parking space. The radar sensors in the bumper also monitor the area adjacent to the vehicle.

The cross traffic warning will be active in the following circumstances:

- **Warning for Cross Traffic, Rear:** the vehicle is backing up at a speed slower than approximately 6 mph (10 km/h).
- **Warning for Cross Traffic, Front:** the vehicle is driving forwards at a speed slower than approximately 6 mph (10 km/h) and the camera image is shown on the central display (→ page 275).

The **Warning for Cross Traffic, Front** can be deactivated or activated on the **Maneuvering Assistance** (→ page 288) menu.

If a critical situation is detected, the  symbol will appear in red in the selected view on the **Camera & Parking** menu.

### Warning for Cross Traffic, Rear

- The vehicle brakes can be applied automatically when crossing traffic is detected.
- If the **Camera & Parking** menu is not open and a critical situation is detected, a warning will appear on the central display together with the PARKTRONIC Parking Assist pop-up.

### Warning for Cross Traffic, Front

- If Active Parking Assist is active, the vehicle brakes can be applied automatically when crossing traffic is detected.
- If Active Parking Assist is not active but the **Camera & Parking** menu is open, a warning will appear.
- If the **Camera & Parking** menu is not open, the system will not be able to react to crossing traffic.

The cross traffic warning is only an aid and not a substitute for your attention to the surroundings.



The responsibility for safe maneuvering and parking remains with you. Make sure that no persons, animals, objects etc. are in the maneuvering area.

**⚠ WARNING** Risk of accident caused by limited detection performance of the cross traffic warning

The cross traffic warning cannot always clearly identify objects and traffic situations.

- ▶ Always pay careful attention to the traffic situation; do not rely on the cross traffic warning alone.
- ▶ Be prepared to brake or swerve as necessary, provided the traffic situation permits and that it is safe to take evasive action.

### System limits

**i** If the cross traffic warning is not available, the  symbol will appear in grey.

The cross traffic warning is not available in drive program .

The system limits of Active Parking Assist apply (→ page 280).

If the radar sensors are obstructed by vehicles or other objects, detection will not be possible.

The cross traffic warning will not be available in the following situations:

- On inclines
- **Warning for Cross Traffic, Rear:** if transport equipment (e.g. trailer or bicycle rack) is attached to the hitch and the electrical connection is correctly established.

### Close-range braking function

The close-range braking function can prevent collisions with pedestrians when the vehicle is backing up at slow speeds. If the rear-view camera detects a person in the vehicle's path, the brakes can be applied to bring the vehicle to a standstill.

The close-range braking function may intervene in the following circumstances:

- The vehicle is backing up at a speed slower than 6 mph (10 km/h).
- The camera image is shown on the central display (→ page 275).

Close-range braking can be deactivated or activated on the **Maneuvering Assistance** menu (depending on the country) (→ page 288).

If the close-range braking function is triggered, the  symbol will appear in red in the selected view on the **Camera & Parking** menu.

**i** If close-range braking is not available, the  symbol will appear in grey.

The close-range braking function is only an aid. It is not a substitute for your attention to the surroundings. The responsibility for safe maneuvering and parking remains with you. Make sure that no persons, animals, objects etc. are in the maneuvering area.

**⚠ WARNING** Risk of accident caused by limited detection by the maneuvering brake function

The maneuvering brake function cannot always clearly detect people. Other obstacles are not detected by the function.

In these cases, the function may brake unnecessarily or not brake at all.

- ▶ Always pay careful attention to the traffic situation; do not rely on the maneuvering brake function alone.
- ▶ Be ready to brake.

### System limits

Close-range braking is not available in drive program .

Observe the system limits of the following functions:

- Active Parking Assist (→ page 280)
- 360° camera (→ page 269)
- Rear-view camera (→ page 267)

The close-range braking function will not be available in the following situations:

- On inclines
- If transport equipment (e.g. a trailer or bicycle rack) is attached to the trailer hitch and the electrical connection has been correctly established.

### Activating/deactivating maneuvering assistant

Multimedia system:

  **» Settings** **» Assistance**  
**» Parking**

- ① This function is an on-demand feature (→ page 24).
- ① Activating/deactivating the maneuvering assistant function is not available in all countries.

▶ Select **Maneuvering Assistance**.

▶ Activate or deactivate the desired maneuvering assistant.

### Memory Parking Assist

#### Function of Memory Parking Assist

Memory Parking Assist can park your vehicle in a previously stored parking space. You can store parking procedures with a total distance of up to 550 yds (500 m) (110 yds (100 m) per parking or exiting procedure).

During parking or exiting, the system can travel a previously stored path of up to approximately

110 yds (100 m) to or out of the desired parking space, for example, from the driveway entrance into the garage.

Within a radius of approx. 165 yds (150 m), only one parking or exiting procedure can be recorded.

Only use Memory Parking Assist on private property. Use on public roads, e.g. in public parking spaces, is not permitted.

Memory Parking Assist is only an aid. It is not a substitute for your attention to the surroundings. The responsibility for safe maneuvering and parking remains with you. Make sure that no persons, animals or objects etc. are in the vehicle path.

#### System limits

Observe the system limitations of Active Parking Assist (→ page 280).

**⚠ WARNING** Risk of accident due to objects located above or below the detection range of Memory Parking Assist

If there are objects above or below the detection range, the following situations may arise:

- Memory Parking Assist may steer too early.
- The vehicle may not stop in front of these objects.

This result in a collision.

- ▶ In these situations, do not use Memory Parking Assist.

Objects located above or below the detection range of Memory Parking Assist may not be detected during the parking procedure.

Objects including drawbars of parked trailers that protrude into the parking space may not be detected.

Do not use Memory Parking Assist in the following situations, for example:

- In extreme weather conditions such as ice, packed snow or in heavy rain.
- When transporting a load that protrudes beyond the vehicle.
- If the parking space is on a steep downhill or uphill gradient.
- When snow chains are installed.

### ■ Recording a parking procedure using Memory Parking Assist

#### Requirements

- The entire route is, for example, within the bounds of your own property and not on public roads.
- The system needs reference points in the surroundings to orient itself, such as fences, walls or trees. Therefore, after you start the vehicle, you will need to drive for a certain distance first. If not enough reference points are detected in the surrounding area, no new route can be recorded.

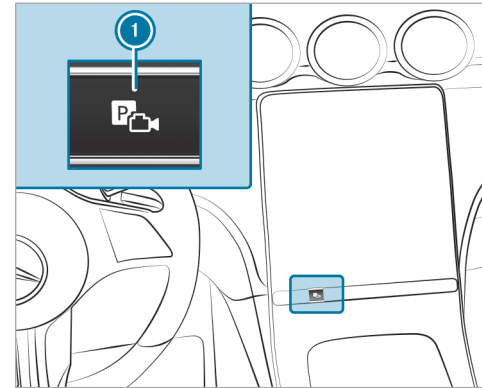

- ▶ Press button ①. The **Camera & Parking** view will open on the central display.



- ▶ Select menu ② **Memory Parking Assist**.
  - ▶ Brake the vehicle to a standstill at the desired starting point of the assisted parking procedure, e.g. a driveway entrance.
  - ▶ **To start recording:** tap on ③.
- ① If not all conditions for a recording are met, symbol ③ will be greyed out.

- ▶ Park the vehicle in the desired parking space. Do not exceed 5 mph (8 km/h).
  - ▶ **To stop recording:** stop the vehicle and tap on ③ again. The recording will be stored.
- ① You can delete and rename stored parking procedures in the Memory Parking Assist settings.

### ■ Parking with Memory Parking Assist

#### Requirements

- A parking procedure has been recorded.

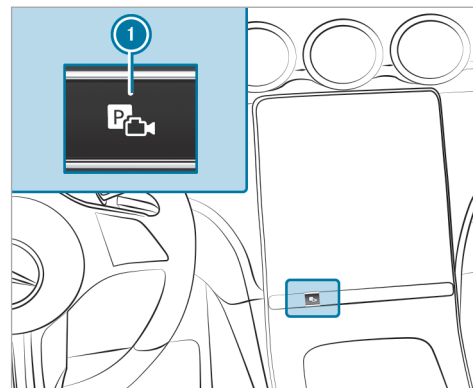

- ▶ Press button ①. The **Camera & Parking** view will open on the central display.



- ▶ Select menu **Memory Parking Assist** ②.
- ▶ Brake the vehicle to a standstill at the starting point of the stored parking procedure.
- ▶ **To start the parking procedure:** press .
- ▶ Select the stored parking procedure from the list.

▶ Follow the instructions on the central display. The vehicle will drive into the selected parking space.

ⓘ The turn signal indicator will not be switched on automatically. You are responsible for engaging the turn signal indicator in accordance with the traffic conditions.

▶ Once the parking procedure is complete, safeguard the vehicle against rolling away.

#### Exiting a parking space with Memory Parking Assist

##### Requirements

- The exiting procedure was recorded together with the respective parking procedure and stored separately within one driving cycle.
- The vehicle was parked using Memory Parking Assist.

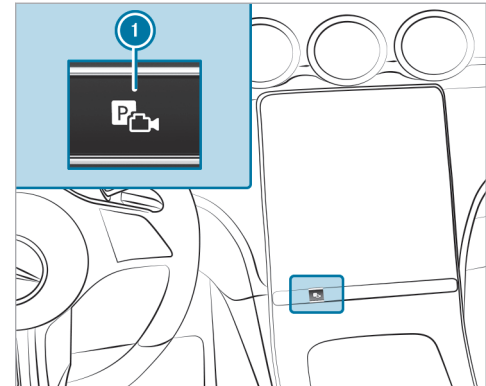

- ▶ Press button ①. The **Camera & Parking** view will open on the central display.



- ▶ Select the **Memory Parking Assist** menu ②.

### Starting the exiting procedure

- ▶ Press .
- ▶ Confirm the saved exiting procedure.
- ▶ Follow the instructions on the central display. The vehicle will drive the recorded route.

① The turn signal indicator will not be switched on automatically. You are responsible for engaging the turn signal indicator in accordance with the traffic conditions.

- ▶ Take control of the vehicle after the exiting procedure has been completed.

### Setting Memory Parking Assist

Multimedia system:

- ▶  ▶ **Settings** ▶ **Assistance**
- ▶ **Parking** ▶ **Memory Parking Assist**

### Renaming a recording

- ▶ Select **Memory Parking Assist**.
- ▶ Select  next to the desired recording.
- ▶ Enter a name and confirm with **OK**.

### Deleting a recording

- ▶ Select **Memory Parking Assist**.
- ▶ Select  next to the desired recording. The selected recording will be deleted.

### Deleting all recordings

- ▶ Select **Memory Parking Assist**.

- ▶ Select **Delete All Tracks**.

① Alternatively, you can delete all data in Memory Parking Assist by resetting the multimedia system (→ page 332).

### Trailer Maneuvering Assist

#### Function of Trailer Maneuvering Assist

① This function is an on-demand feature (→ page 24).

**⚠ WARNING** Risk of accident due to unsuitable trailers

Trailers with a steered axle or a fifth wheel cannot be used with Trailer Maneuvering Assist.

Due to this, the trailer cannot be maneuvered in the desired direction and you can cause a collision or the trailer can rollover.

- ▶ Only use Trailer Maneuvering Assist with trailers with fixed drawbars and axles.

**▲ WARNING** Risk of accidents due to unsuitable hitching devices

Trailer hitches without a ball head, such as a Hensley hitch or a pintle hitch, as well as any hitch adapters or multiple hitch ball mounts, **cannot** be guided by Trailer Maneuvering Assist.

This will prevent the trailer from maneuvering in the desired direction and you may cause a collision or the trailer may roll over.

- ▶ Use Trailer Maneuvering Assist only with a trailer hitch with a ball head.
- ▶ Use Trailer Maneuvering Assist only with a trailer hitch without additional attachments, such as a weight distribution system or sway control.
- ▶ Use Trailer Maneuvering Assist only with a trailer with a drawbar that has no additional attachments or superstructures.
- ▶ Use Trailer Maneuvering Assist only with a hitch ball mount. The use of an additional hitch adapter or hitch ball mount is not permitted.

**▲ WARNING** Danger of accident due to incorrect taught values for the ball head position

If after changing the trailer, ball neck or changing the ball head position the values for the ball head position are **not** reset and a calibration drive is carried out again, Trailer Maneuvering Assist will not function properly. This will prevent the trailer from maneuvering in the desired direction and you may cause a collision.

- ▶ After changing the trailer, the ball neck or the ball head position, do not use Trailer Maneuvering Assist without carrying out a calibration drive again.
- ▶ After changing the trailer, the ball neck or the ball head position, reset the taught-in values.
- ▶ Then, carry out a calibration drive to teach in the values of the new ball head position.

Information on resetting the taught-in values for the ball head position and on the calibration drive (→ page 299).

**! NOTE** Damage due to overhanging loads in front or drawbar installations

The vehicle and the trailer may be damaged during maneuvering due to overhanging loads at the front of the trailer or drawbar installations.

- ▶ Pay attention to overhanging loads or drawbar installations while maneuvering.

Trailer Maneuvering Assist assists you when backing up with a trailer. Using the rear-view camera, it monitors the articulation angle between the vehicle and trailer and adjusts it to a specified value. Trailer Maneuvering Assist also limits your speed.

For Trailer Maneuvering Assist to function properly, a calibration drive must be carried out for the trailer and ball neck used and if the ball head position is changed. During the calibration drive, the current ball head position is taught (→ page 299).

Trailer Maneuvering Assist is only an aid. It is not a substitute for your attention to the surroundings. Responsibility for safe maneuvering and parking remains with you. Make sure that there are no persons, animals or objects in the maneuvering area while maneuvering and parking in / exiting parking spaces.

You can either enter the articulation angle value directly via the multimedia system or use a straightening maneuver or the 90° maneuver. When carrying out a straightening maneuver, the system calculates the articulation angle automatically and straightens the vehicle/trailer combination to the trailer's current direction.

Observe the notes on towing a trailer (→ page 296).

### System limits

Observe the system limits of the following functions:

- Active Parking Assist (→ page 280)
- 360° Camera (→ page 269)
- Rear-view camera (→ page 267)

The system may be impaired or may not function in the following situations:

- The gradient is greater than approximately 15 %.
- The height of the ball head above level ground is less than 13.8 in (0.35 m) or more than 21.6 in (0.55 m)

### ■ Using Trailer Maneuvering Assist

#### Requirements

- The vehicle has been started and is stationary.
- A trailer is selected in the **Vehicle** menu (→ page 299).
- A trailer has been detected.
- A calibration drive has been performed with the trailer and ball neck used and the current ball head position (→ page 299).
- A drive in a straight line has been performed to calibrate Trailer Maneuvering Assist in compliance with the instructions on the central display (→ page 299).
- The gradient is less than approximately 15 %.
- The tailgate is closed.

- The electric parking brake has not been applied.
- The driver's seat belt is fastened.

**i** To ensure that Trailer Maneuvering Assist works properly, reset the taught-in values for the ball head position each time the trailer, ball neck and ball head position have been changed. Then perform a calibration drive again. Information on resetting and the calibration drive (→ page 299).



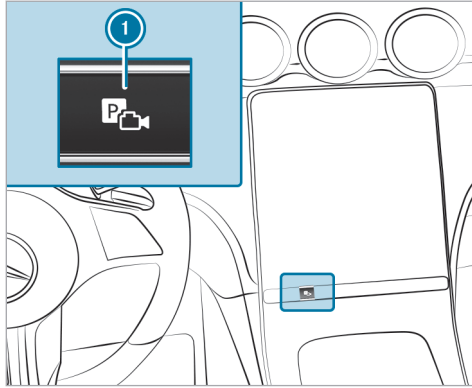

- ▶ Engage reverse gear **R**.
- ▶ Press button **1**.  
The camera image is shown in the central display.

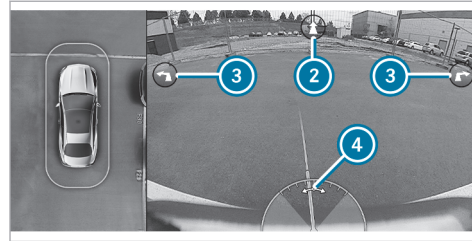

- ▶ **i** The picture is an example only and is shown without a trailer.

You can select various maneuvers in the Trailer Maneuvering Assist menu. The maneuvers available depend on the current articulation angle and length of the trailer.

- ▶ To adjust the articulation angle: select **4**. On the central display, swipe the entire area of the camera image to the left or right to change the articulation angle.

or

- ▶ To activate the straightening maneuver: select **2**.  
The system calculates the articulation angle in such a way that the direction of the trailer at the time of activation is maintained. There is a short countersteering movement of the trailer while the vehicle is reversed, which then guides it back to the desired line. In this way, the vehicle is aligned straight with the trailer and, at the same time, the direction of the trailer is maintained.

or

- ▶ To activate the 90° maneuver:
  - Align the vehicle in the same direction (line) as the trailer.
  - Select (left or right) **3**.

The system will calculate the articulation angle in such a way that a trailer can be maneuvered into a space perpendicular to the vehicle using the smallest possible angle. After the maneuver, the vehicle is aligned again in the direction of the trailer.

- ▶ Accelerate and brake as required.

- ① The maximum articulation angle depends on the length of the trailer. This is calculated by the system by driving the vehicle forwards, including cornering. Before the length of the trailer has been calculated, the maximum articulation angle is approximately 23°. The longer the trailer is, the higher the maximum articulation angle is (max. approximately 60°).
- ① Pay attention to your surroundings and be ready to brake at all times.

### Trailer hitch

#### Notes on trailer operation

**!** NOTE Mercedes-AMG vehicles

- ▶ Observe the notes in the Supplement. You could otherwise fail to recognize dangers.

**!** WARNING Risk of accident due to unsuitable ball neck

If you install an unsuitable ball neck, the trailer hitch and the rear axle may be overloaded.

This can significantly impair the driving characteristics and the trailer may become loose. There is a risk of fatal injury.

- ▶ Only install a ball neck that complies with the permissible dimensions and is designed for the requirements of trailer operation.
- ▶ Do not modify the ball neck or the trailer hitch.

The values approved by the manufacturer can be found on the identification plates and in the "Technical data" section under "Trailer hitch" for the towing vehicle (→ page 455).

**!** WARNING Risk of accident due to vehicle/trailer combination swerving

If you drive too fast in trailer operation, the vehicle/trailer combination may start to swerve.

This could cause you to lose control of the vehicle/trailer combination. The vehicle/trailer combination may even rollover.

- ▶ Under no circumstances should you try to straighten the vehicle/trailer combination by increasing your speed.
- ▶ Reduce the speed and do not countersteer.
- ▶ Brake if necessary.

**!** NOTE Damage to the engine resulting from overheating

- ▶ If you subsequently have a trailer coupling retrofitted, depending on the vehicle type, changes to the engine cooling system may be required.

In the case of retrofitting a trailer coupling, please observe the attachment points on the vehicle frame.

The installation of a trailer hitch is only permissible if a trailer load is specified in your vehicle documents. If this is not the case, the vehicle is not approved for trailer operation.

Further information can be obtained at a qualified specialist workshop.

Please observe the manufacturer's operating instructions for the trailer coupling if a detachable trailer coupling is used.

Couple and uncouple the trailer carefully. If you do not couple the trailer to the towing vehicle correctly, the trailer could become detached.

Observe the following notes on the tongue weight:

- do not use a tongue weight that exceeds or falls below the permissible tongue weight
- use a tongue weight as close as possible to the maximum tongue weight

Do not exceed the following values:

- Permissible trailer load
- Permissible rear axle load of the towing vehicle
- Permissible gross mass of the towing vehicle
- Permissible gross mass of the trailer
- Maximum permissible speed of the trailer

Ensure the following before starting a journey:

- the tire pressure on the rear axle of the towing vehicle is set for a maximum load

- the lighting of the connected trailer is operational

In the event of increased rear axle load, the vehicle/trailer combination may not exceed a maximum speed of 62 mph (100 km/h) for reasons concerning the operating permit. This also applies in countries in which the permissible maximum speed for car/trailer combinations is above 62 mph (100 km/h).

#### Attaching the ball neck

**⚠ WARNING** Risk of accident and injury due to incorrectly installed ball neck

If the ball neck is not properly mounted and secured, it may come loose along with the trailer while the vehicle is in motion and endanger other road users. There is a risk of fatal injuries.

- ▶ Mount and secure the ball neck as described in the installation instructions of the ball neck manufacturer.

- ▶ With the ball neck mounted, always make sure it is properly secured before commencing a journey.

#### Attaching the ball neck

- ▶ Secure the vehicle against rolling away.
- ▶ Remove cover cap ❶ from the ball neck mount in the direction of the arrow.
- ▶ Store cover cap ❶ such that it cannot move around.
- ▶ Comply with the installation instructions of the ball neck manufacturer.

Observe the notes on loading the vehicle.

- ❶ To ensure that the Trailer Maneuvering Assist functions properly, the taught-in values for the ball head position must be reset after each change of trailer, ball neck, or ball head position. A calibration drive must then be performed again. Information on resetting and the calibration drive (→ page 299).

### Coupling up/uncoupling a trailer

The trailer will only be correctly detected by the vehicle if the following conditions are fulfilled:

- the trailer is connected correctly
  - the trailer lighting system is in working order
- i** Before using Trailer Maneuvering Assist and after each change of trailer, a calibration drive must be carried out with the ball neck being used (→ page 299).

A correctly connected trailer influences, among other things, the functions of the following systems:

- ESP® trailer stabilization
- Trailer Maneuvering Assist
- Active Lane Keeping Assist
- Parking Assist PARKTRONIC
- Active Parking Assist
- Blind Spot Assist
- Active Blind Spot Assist
- Drive Away Assist
- Cross traffic warning

- Maneuvering brake function
- Rear view camera
- 360° camera

**Vehicles without level control system:** the ball head height will change depending on the vehicle's load. In this case, use a trailer with a height-adjustable drawbar.

### Coupling up a trailer

**!** **NOTE** Damage to the starter battery due to full discharge

Charging the trailer battery using the power supply of the trailer can damage the starter battery.

- ▶ Do not use the vehicle's power supply to charge the trailer battery.

Information about a suitable ball neck for Mercedes-Benz vehicles can be obtained from a qualified specialist workshop, e.g. an authorized Mercedes-Benz Center.

- ▶ Secure the vehicle against rolling away.

- ▶ Remove the cover cap from the ball neck mount and store it in a safe place (→ page 297).
- ▶ Position the trailer on a level surface behind the vehicle and couple it up to the vehicle.
- ▶ Establish the electrical connection between the vehicle and the trailer.

- i** Accessories can be connected to the permanent power supply up to 180 W, and to the power supply that is switched on via the ignition lock.

### Decoupling a trailer

**!** **WARNING** Risk of being crushed and becoming trapped when uncoupling a trailer

When uncoupling a trailer with an engaged inertia-activated brake, your hand may become trapped between the vehicle and the trailer drawbar.

- ▶ Do not uncouple trailers with an engaged overrun brake.

**!** **NOTE** Damage during uncoupling with an engaged overrun brake

The vehicle may be damaged if you uncouple with an engaged overrun brake.

- ▶ Do not uncouple trailers with an engaged overrun brake.

- ▶ Secure the vehicle against rolling away.
- ▶ Disconnect the electrical connection between the vehicle and the trailer.
- ▶ Uncouple the trailer.
- ▶ Remove the ball neck and, in doing so, observe the installation instructions from the ball neck manufacturer.
- ▶ Place the cover cap on the ball neck mount.



### Selecting a trailer type

Multimedia system:

→ →  ▶ Settings ▶ Vehicle ▶ Driving  
▶ Trailer Type

### Making settings for a trailer

The settings in this menu enable the calculation of a route suitable for the selected trailer and optimize the calculated arrival time. Plus, depending on the vehicle's equipment, the maximum speed shown in the instrument cluster will be accordingly adjusted as well as being taken into account when adopting speeds.

- ▶ Select the desired trailer type.
- ▶ Select the maximum permissible speed of the set trailer.
-  No maximum speed can be entered for the bicycle rack.
- ▶ **To save changes:** select **Confirm**.
-  When contact with the trailer socket is established (trailer/rear bicycle rack), a menu automatically appears on the display.

The following selections are available:

- Bicycle rack
- Small trailer
- Large trailer

### Calibrating a trailer coupling

- ▶ Select **Trailer Coupling Was Changed** to start calibration for the new ball head position.
- ▶ **To save changes:** select **Confirm**.
- ▶ Switch on Trailer Maneuvering Assist and follow the corresponding instructions on the central display.  
If the **Activated: Trailer Maneuvering Assist** message is shown, calibration is complete and Trailer Maneuvering Assist can be used.

### Vehicle towing instructions

The vehicle is not suitable for the use of tow bar systems that are used for flat towing or dinghy towing, for example. Attaching and using tow bar systems can result in damage to the vehicle. When you are towing a vehicle with tow bar systems, safe driving characteristics cannot be guar-

### 300 Driving and parking

---

anted for the towing vehicle or the towed vehicle.  
The vehicle-trailer combination may swerve from side to side.

**!** **NOTE** Mercedes-AMG E Performance

▶ Observe the notes in the Supplement.  
You could otherwise fail to recognize dangers.

The Mercedes-AMG E Performance model is not available in all countries.

Observe the following information:

- Permitted towing methods (→ page 404)
- **Plug-in hybrid:** Permitted towing methods (→ page 404)
- The notes on towing with both axles on the ground (→ page 405)

### Notes on the driver display

**⚠ WARNING** Risk of accident if the driver display fails

If the driver display has failed or is malfunctioning, function restrictions in systems relevant to safety cannot be detected.

The operating safety of your vehicle may be impaired.

- ▶ Drive on carefully.
- ▶ Have the vehicle checked immediately at a qualified specialist workshop.

**! NOTE** Mercedes-AMG vehicles

- ▶ Observe the notes in the Supplement. You could otherwise fail to recognize dangers.

If the operating safety of your vehicle is impaired, park the vehicle immediately and safely. Contact a qualified specialist workshop.

The driver display shows the following basic information:

- Speed and engine speeds
- Fuel level and coolant temperature
- Indicator and warning lamps

Additional functions available include the following:

- Different menus, e.g. for assistance and navigation
- Status displays for the driving systems
- Display messages
- Information on speed, **Consumption** and range
- Power meter level and state of charge of the high-voltage battery
- Indicator and warning lamps

Some menu content and settings can be customized.

### Operating the driver's display

**⚠ WARNING** Risk of distraction from information systems and communications equipment

If you operate information systems and communication devices integrated in the vehicle when driving, you could be distracted from the traffic situation. This could also cause you to lose control of the vehicle.

- ▶ Only operate this equipment when the traffic situation permits.
- ▶ If you cannot be sure of this, stop the vehicle whilst paying attention to road and traffic conditions and operate the equipment with the vehicle stationary.

Observe the legal requirements for the country in which you are currently driving when operating the driver's display.

### Scrolling on the menu bar

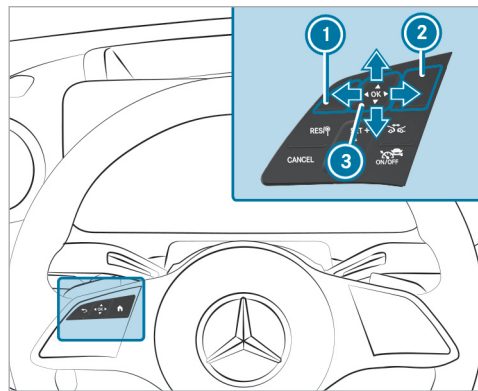

- ① Back button
- ② Main menu button
- ③ Touch Control

The content on the driver's display is controlled using the control elements on the left side of the steering wheel. You can use Touch Control ③ to navigate vertically and horizontally by swiping with

one finger. Confirm your selection by pressing the Touch Control.

- ① To operate Touch Control ③ in the most effective way, use the tip of your thumb if possible. You can also set the sensitivity of the Touch Control on the central display .
- ▶ Briefly press main menu button ② .
- ▶ Select a menu by swiping to the left or right on Touch Control ③ .
- ▶ **To confirm:** press Touch Control ③ .

### Driver display menus

#### Notes on menus on the driver's display

**⚠ WARNING** Risk of distraction from information systems and communications equipment

If you operate information systems and communication devices integrated in the vehicle when driving, you could be distracted from the traffic situation. This could also cause you to lose control of the vehicle.

- ▶ Only operate this equipment when the traffic situation permits.
- ▶ If you cannot be sure of this, stop the vehicle whilst paying attention to road and traffic conditions and operate the equipment with the vehicle stationary.

Observe the legal requirements for the country in which you are currently driving when operating the driver's display.

The following menu can be called up via the menu bar on the driver's display:

- Understated
- Sport
- Classic
- Navigation
- Assistance
- Offroad (vehicles with 4MATIC)
- Service

On some of these menu, you can choose between different display content on the center display area.



On most of the menus, you can use **Options** to configure further settings for the menu-specific display content.

You can find further information about the possible settings and selections on the menus in the Digital Operator's Manual.

### Calling up displays on the Sport menu (plug-in hybrid)

Driver's display:



The **Sport** menu provides additional information about the operating energy output as well as the recuperated output of the vehicle.

- When you call up the **Sport** menu on the menu bar of the driver's display, the menu color setting will automatically be applied to the MBUX multimedia system.

**To call up the menu:** press the left-hand Touch Control.



- Display range of recuperated power (recuperation)
- Display range of the output
- Additional display range of the output

### Head-up Display

#### Function of the head-up display

The head-up display projects various content into the driver's field of vision, for example.

You can use the head-up display menu bar to select various contexts, e.g.:

- Minimal

- Sport
- Standard
- Offroad (vehicles with 4MATIC)
- ECO display (depending on model and equipment) (→ page 179)
- Settings
- Head-up display on/off

The following image shows an example of the head-up display. You can choose what content is displayed (→ page 304).

### Head-up display content with navigation (9x3°)

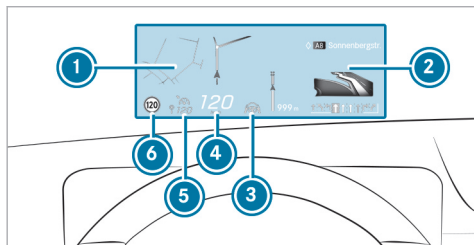

- ① Navigation instructions
- ② Navigation instructions (distance to the next route event)
- ③ Steer Assist status
- ④ Current speed
- ⑤ Set speed in the driving system (e.g. cruise control)
- ⑥ Detected traffic signs (Traffic Sign Assist)

When you receive a call, the  **Call Waiting** message will appear on the head-up display and the driver's display.

### System limits

Visibility is particularly influenced by the following conditions:

- Seat position
- Image position setting
- Ambient light
- Wet road surfaces
- Objects on the display cover
- Polarization in sunglasses

### Operating the head-up display

#### Selecting display content of the head-up display via the menu bar of the driver's display

- ▶ Press the  main menu button on the left.
- ▶ **To select the menu bar of the head-up display:** swipe upwards on the left-hand Touch Control.





#### Switching between display content on the head-up display

- ▶ Swipe to the left or right on the left-hand Touch Control. A preview of the selected display content will appear on the head-up display.
- ▶ **To confirm:** press the  button.

#### Switching back to the driver's display

- ▶ Press the  or  button.

### Setting the position and brightness

- ▶ Swipe to the left or right on the left-hand Touch Control and select **Settings** on the menu bar of the head-up display.
- ▶ Press the left-hand Touch Control. The current position and brightness settings will be displayed as graphics on the head-up display as well as on the driver's display.
- ▶ **To adjust the position:** swipe upwards or downwards on the left-hand Touch Control.
- ▶ **To adjust the brightness:** swipe to the left or right on the left-hand Touch Control. The settings configured for position and brightness will be saved automatically.
- ▶ Press the  or  button to exit the settings.

### Switching the head-up display on/off

Driver's display:



#### Switching on

- ▶ Swipe upwards on the left-hand Touch Control.
- ▶ Press the left-hand  Touch Control.

#### Switching off

- ▶ Swipe upwards on the left-hand Touch Control.
- ▶ Swipe on the left-hand Touch Control and select **Head-up Display**.
- ▶ Press the left-hand  Touch Control.

### Vehicles with a 48 V on-board electrical system

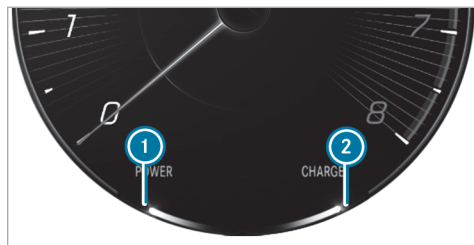

- ① Electric drive support
- ② Recuperation behavior of the electric motor
- ⓘ Due to various system limits, the values displayed may temporarily differ slightly from the actual value.

### Function of the power meter



- ① Start of the POWER display range
- ② End of the POWER display range
- ③ Current state of charge of the high-voltage battery
- ④ Maximum recovered energy
- ⑤ Start of the display range of the recovered energy

The power meter has the following functions:

- In electric mode, area ① – ② shows what percentage of the electrical drive is currently being used. The combustion engine is switched on at a percentage of 100%. In boost

mode, the electrical power assistance of the drive is displayed.







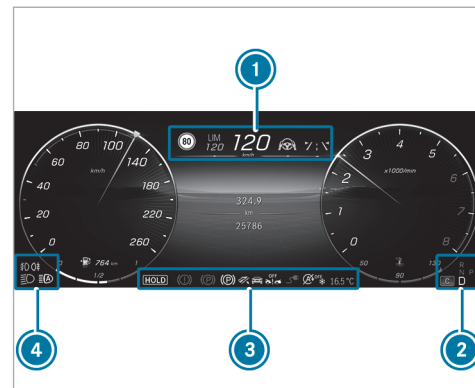







- The area ④ – ⑤ shows the recuperation and charging behavior using the combustion engine.
- ⓘ Due to various system limits, displayed value ④ may temporarily differ slightly from the actual value.

### Overview of status displays on the driver's display



The status displays for the driving and driving safety systems can be found in display sections ① to ④.



- ⬇️ Pedestrian detection (only on assistant display)
- P Active Parking Assist is available (→ page 282)
- ⌂ P Active Parking Assist has recognized a parking space (→ page 282)
- OFF P Parking Assist PARKTRONIC deactivated (→ page 279)

-  Cruise control (→ page 231)
-  Active Distance Assist DISTRONIC (→ page 233)
-  Specified distance for Active Distance Assist DISTRONIC (→ page 233)
-  Active Brake Assist switched off (→ page 255)
-  Active Brake Assist impaired or not functioning (→ page 255)
-  Active Steering Assist (→ page 242)
-  Active Lane Change Assist (→ page 246)
-  Active Lane Keeping Assist (→ page 264)
-  Active Blind Spot Assist (only on assistant display) (→ page 263)
-  Plug-in hybrid operation activated
-  Haptic accelerator pedal (→ page 182, 184, 179)
-  ECO start/stop function (→ page 177)
-  HOLD function (→ page 227)
-  Adaptive Highbeam Assist (→ page 139)

Adaptive Highbeam Assist Plus  
(→ page 140)

-  Active Stop-and-Go Assist (→ page 240)
-  Slippery road surface warning

**Vehicles with Traffic Sign Assist:** detected instructions and traffic signs (→ page 256)

### Notes on operating safety

For your own safety, always observe the following points when operating mobile communications equipment and especially your voice control system:

- Observe the legal requirements for the country in which you are driving.
- If you use the voice control system in an emergency your voice can change and your telephone call, e.g. an emergency call, can thereby be delayed.
- Familiarize yourself with the voice control system functions before starting the journey.

#### The voice control system does not replace the Operator's Manual.

The answers from the voice control system do not provide the complete scope of information contained in the Operator's Manual. The voice control system also does not give detailed warning or damage information. Therefore read the Operator's Manual so that you are fully informed about the functions and the safe operation of the vehicle.

### Operation

#### Function of the MBUX Voice Assistant

Using the MBUX Voice Assistant, vehicle functions and various areas of the MBUX multimedia system can be operated by voice input, e.g. Navigation or Telephone. The MBUX Voice Assistant is operational about half a minute after switching on the vehicle and can be operated from all seats (depending on the special equipment).

#### Conducting a dialog

##### Requirements:

- Voice activation is activated in the multimedia system (→ page 309).
- For corrections during output, the **Speak During Voice Output** option must be activated in the multimedia system (→ page 309).

##### Starting a dialog

- ▶ Say **Hey Mercedes** to activate the MBUX Voice Assistant.

or

- ▶ Press the  button on the multifunction steering wheel.

A wave appears in the MBUX multimedia system. The dialog can be started.

For the dialog with the MBUX Voice Assistant, you can use complete sentences of colloquial language as voice commands. Voice activation can also be combined directly with a voice command, e.g. **Hey Mercedes, how warm is it outside?**

##### Interrupting the dialog

- ▶ During the dialog say **Pause**. The dialog is interrupted.
- ▶ Say **Hey Mercedes** to continue the dialog.

##### Correcting an entry

- ▶ During the dialog say **Correction**.
- or
- ▶ Interrupt the system's voice output.

##### Changing dialog level

- ▶ During the dialog, say **Back**. The MBUX Voice Assistant jumps back to the previous dialog step.

- ▶ During the dialog, say From the beginning again.  
The MBUX Voice Assistant jumps to the highest dialog level.

### Navigating in the selection list

If a voice command does not achieve a clear result, a selection list is shown.

- ▶ Say the line number or the content to select an entry or to have further details shown.
- ▶ Say **Next page** or **Previous page** to browse the selection list.

### Calling up help

- ▶ **For information about the MBUX Voice Assistant:** say Hey Mercedes, what can you do?
- ▶ **Current application:** say Help.  
You will receive suggestions and information about operation of MBUX Voice Assistant for the current application.
- ▶ **Specific function:** call up the voice command for the required function, for example with Hey Mercedes, I need help with the radio.

- ▶ **Digital Operator's Manual:** say Show me the Operator's Manual.  
The full extent of the Digital Operator's Manual is available on the central display when the vehicle is stationary.

### Overview of the operable functions of the MBUX Voice Assistant

You can use the MBUX Voice Assistant to operate the following functions depending on the vehicle equipment:

- Telephone
- Text messages and e-mails
- Navigation
- Radio and media
- Vehicle functions
- Online functions

Full functionality of the voice control system is only available for you with activation of online voice control (→ page 309).

### Information on the language setting

You can change the language of the MBUX Voice Assistant via the system language settings (→ page 332). If the set system language is not supported by the MBUX Voice Assistant, English will be selected.

### Setting functions of MBUX Voice Assistant using the multimedia system

Multimedia system:

- ▶  ▶ Settings ▶ System
- ▶ ▶ Voice Assistant

### Switching voice activation of MBUX Voice Assistant on or off

- ▶ Select **Hey Mercedes**.  
When the function is active, the Hey Mercedes voice command can activate the dialog.

### Switching direct commands on or off

- ▶ Select .

- ▶ Activate or deactivate the function. If the function is active, some commands can be used without Hey Mercedes, for example Next track.

#### Switching voice activation for individual seats on or off

- ▶ Select .
- ▶ Switch the function for the desired seats on or off.

#### Switching voice interruption on or off

- ▶ Select [More Settings](#).
- ▶ Select [Speak During Voice Output](#). If the function is active, a command can be interjected during voice output of the system.

#### Switching proactivity on or off

- ▶ Select [More Settings](#).
- ▶ Select the desired situation, e.g. [Profile Activation](#) or [Don't Forget Your Phone](#). When the function is active, the voice assistant proactively provides information in specific situations.

#### Activating or deactivating online voice control

- ▶  Online voice control is activated at the factory.
- ▶ Select [Online Voice Control](#).
- ▶ Activate or deactivate the function. If the function is activated and a Mercedes me user account is linked to the vehicle, additional results are available through the provision of external information, e.g. information on POIs. By clicking the symbol in the wave, more information about the online voice control can be displayed.

#### Activating or deactivating contacts for online use

- ▶ Select [Contacts for Online Use](#). When the function is active, contacts will be found more easily and accurately using voice input.

#### Using MBUX Voice Assistant effectively

##### Notes on optimum use of MBUX Voice Assistant

- The MBUX Voice Assistant is operational half a minute after switching on the vehicle and can

be operated from all seats, depending on the equipment installed. The system recognizes from which seat the command was spoken and performs actions according to the seat position.

- When a dialog is ended, the MBUX Voice Assistant continues to be active for as long as the wave is displayed in the multimedia system. You can say another voice command without saying **Hey Mercedes**.
- Using the direct command [Change language to English](#), the system language can be changed to English without **Hey Mercedes**. Direct commands must be activated for this.
- If a user profile has been stored and is active, the MBUX Voice Assistant can make suggestions based on the habits of the user. If the voice commands are not clear, the system selects an action. The action can be corrected with a new voice command.

Say **Hey Mercedes**, load my personal profile, to activate the profile. The user's voice must first be learned by the system and assigned to a profile.



Further information on user profiles .

- With the MBUX Voice Assistant, incoming calls can be accepted or rejected without the keyword **Hey Mercedes**.

### Information on the MBUX online voice assistant

The online voice control facilitates recognition and thanks to external information makes additional results available.



Therefore, Mercedes-Benz recommends that you activate online voice control (→ page 309).

You will need a Mercedes me user account for this. If you do not yet have a user account you have to create one and connect it with your vehicle .

Then call up your Mercedes me user account. The Mercedes me services are shown and can be activated .

By clicking on the symbols displayed in the wave, further information on the online status is displayed.

When online voice control is active, additional functions are available such as:

- Weather
  - General knowledge
  - Public holidays and school holidays
  - Smarthome
  - Messages
  - Time, date and time zones
  - Pocket and currency calculator
  - Football results and fixture lists
  - Share prices
  - Calendar
  - ChitChat
  - Horoscope
  - Geo Quiz
-  The availability of these functions is country and equipment-dependent.
-  Text content is taken from Wikipedia in accordance with the CC BY-SA 3.0 license.

### Essential voice commands

#### Notes on voice commands

It is not necessary to use exact voice commands to call up a specific function. The MBUX Voice Assistant also understands you when you use your colloquial speech. Some examples are listed below. For some languages however these examples are only available to a limited extent.

Examples of voice commands:

- Navigation (→ page 311)
- Telephone (→ page 312)
- Radio and TV (→ page 312)
- Media player (→ page 312)
- Messages (→ page 312)
- Vehicle functions (→ page 313)
- Online functions (→ page 314)

#### Examples of navigation voice commands

You can operate the navigation system using the MBUX Voice Assistant. The following list offers just a small selection of the possible navigation

commands. You will receive additional suggestions if you say **Help** for navigation.

- Drive me home.
- Where is the nearest service station?
- Is there a service area along the route?
- Set Covent Garden as intermediate destination.
- Cancel the route guidance.
- Show my last destination.
- I want to buy juice.
- Search for an Asian restaurant, but not Japanese, in South London.

### Examples of telephone voice commands

You can operate phones connected with MBUX multimedia system the using the MBUX Voice Assistant. The following list offers just a small selection of the possible telephone commands. You will receive additional suggestions if you say **Help** for phone.

- Call Peter Miller on the mobile phone.
- Dial 0711 17 0.

- Call my father.
- Accept call
- Reject call
- Search for the contact Peter Miller.
- Switch to address book
- Show me the incoming calls.
- Switch the phone

### Examples of radio and TV voice commands

Depending on the vehicle equipment, you can operate the radio and TV using the MBUX Voice Assistant. The following list offers just a small selection of the possible radio or TV voice commands. You will receive additional suggestions if you say **Help** for radio or **Help** for TV.

- Play the radio station Heart FM.
- Next station.
- Previous station.
- Show me the list of radio stations
- Save the station
- What am I listening to?

### Examples of media voice commands

You can operate connected media sources and online music using the MBUX Voice Assistant. The following list offers just a small selection of the possible media voice commands. You will receive additional suggestions if you say **Help** for media or **Help** for player.

- Play Michael Jackson.
- Play "Yellow Submarine" by the Beatles.
- Next track.
- Previous track.
- Play similar track.
- Repeat this track.
- Switch on random playback.
- Mute the music.
- Switch to USB.

### Examples of message voice commands

Messages can be created, edited and listened to using the MBUX Voice Assistant. The following list offers just a small selection of the possible mes-

sage commands. You will receive additional suggestions if you say **Help for messaging**.

- Write a text message to Jane Doe: When will the next meeting take place?
- Show me my new e-mails.
- Write an e-mail to Jane Doe.
- Read me my new text messages.
- Show all new text messages.
- Write an e-mail to John Doe in English

### Examples of vehicle voice commands

You can operate vehicle settings and vehicle functions using the MBUX Voice Assistant. The following list offers just a small selection of the possible vehicle voice commands.

- ① If no seat is mentioned for commands, the action is carried out automatically for the seat from which the command was spoken or for the function which is closest to that seat.
- Switch the seat heating to level 2.
- My feet are cold.
- Start the Refresh program.

- Switch the massage function on.
- I would like to set the ambient light to blue
- Switch on the reading lamp.
- Turn off the rear passenger compartment light.
- Open all the windows.
- Switch the driver display to 3D.
- How fast can I drive here?
- Tell me my next service appointment
- How warm is it outside?

Information about the vehicle can also be requested:

- Information about individual items of the vehicle equipment
  - Hey Mercedes, which massage program do you have?
  - Hey Mercedes, do I have Blind Spot Assist?
  - Hey Mercedes, where is the warning triangle?

- Information about functioning of the systems and components installed in the vehicle
  - Hey Mercedes, what is DISTRONIC?
  - Hey Mercedes, what do I need ESP for?
  - Hey Mercedes, what is MBUX?
- Information about operating the systems and components installed in the vehicle
  - Hey Mercedes, how do I connect my smartphone?
  - Hey Mercedes, how can I turn on the high beam?
  - Hey Mercedes, how do I stop the ionization function?

You can also use the vehicle voice commands to directly call up the menus for the plug-in hybrid settings and operate the corresponding vehicle functions.

- "Display the energy flow."
- "Switch to charging settings."
- "Activate pre-entry climate control."
- "Where is the nearest charging station?"

- "How far can I still drive?"
- "Set the departure time to tomorrow morning at 8 am."

### Examples of online functions

---

Depending on the country, language and vehicle equipment, additional functions are available when online voice control is active. The system accesses external information and can, as a result, answer general knowledge questions and make calculations, for example.

- Is the sun shining in Manchester?
- Is it raining at my location?
- What are the skiing conditions on the Zugspitze?
- What's the time in Sydney now?
- In which country do you pay with dollars?
- How many Swiss francs make 25 euros?
- How long now until the holidays?
- What day is it tomorrow?
- What is 20% of 29?

- What does my horoscope say?
- What is the price of Mercedes-Benz Group shares?
- Let's play Geo Quiz.
- I'm bored.
- Who is the current prime minister?
- What do you know about the Globe Theatre in London?
- Who painted the picture "The Scream"?
- What's the status in the Premier League?
- Create a calendar entry tomorrow at 9 am.
- What's my next task?
- Tell me a joke.
- How many languages do you speak?
- What is your favorite animal?
- Are there any updates?
- Is the light still on in the kitchen?
- Switch off all the devices in my house.
- Please set the temperature in the living room to 24 degrees.

### Direct command examples

---

With direct commands, some functions can be operated without first saying the voice command **Hey Mercedes**. To use direct commands, the function must be activated in the multimedia system (→ page 309).

- Next TV channel
- Previous TV channel
- Next radio station
- Previous radio station
- Next station
- Previous station
- Next track
- Previous track
- Start dashcam recording
- Stop dashcam recording
- Show the map
- Map 3D view
- Map 2D view
- Align map to north
- Align map in direction of travel

- Show all routes
- Show traffic
- Navigate to work
- Navigate home
- Listen to guidance instructions
- Cancel route guidance
- Change language to English

## Overview and operation

### Notes on the MBUX multimedia system

**⚠ WARNING** Risk of distraction from information systems and communications equipment

If you operate information systems and communication devices integrated in the vehicle when driving, you could be distracted from the traffic situation. This could also cause you to lose control of the vehicle.

- ▶ Only operate this equipment when the traffic situation permits.
- ▶ If you cannot be sure of this, stop the vehicle whilst paying attention to road and traffic conditions and operate the equipment with the vehicle stationary.

You must observe the legal requirements for the country in which you are currently driving when operating the multimedia system. Depending on the equipment, the scope of function and product designation of your MBUX multimedia system may differ from the description and

images in this Operator's Manual. For example, route guidance with augmented reality is not available in all equipment variants.



**! NOTE** Increased surface temperature due to direct sunlight on the central display

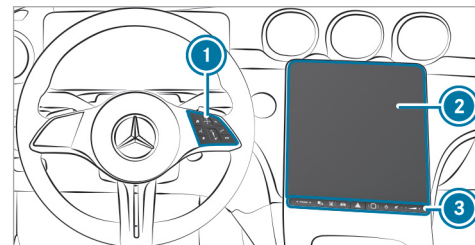

The surface of the central display is very dark. If the display is exposed to direct sunlight, the surface can become very hot.

- ▶ If the central display has been exposed to direct sunlight, allow it to cool down before touching it for a long time.

## Overview of the MBUX multimedia system



- 1 Touch Control and control panel for the MBUX multimedia system  
MBUX stands for Mercedes-Benz User Experience.
  - Operating Touch Control
- 2 Central display with touch functionality
  - Home screen overview
  - Operating the touchscreen
- 3 Switch panel with:
  -  Fingerprint sensor
  -  Switches the MBUX multimedia system on or off

-  Switches sound on or off
-  Adjusts the volume

Further operating options:

- Conducting a dialog with the MBUX Voice Assistant.
-  You can find further information about operation as well as about applications and services in the Digital Operator's Manual.

### Anti-theft protection

This device is equipped with technical provisions to protect it against theft. Further information on anti-theft protection can be obtained at an authorized Mercedes-Benz Center.

### Zero layer

#### ■ Function of the zero layer

-  Your software can be upgraded to a more current version at a later date.

The zero layer provides you with dynamic content from the MBUX multimedia system and is used to quickly access and control the applications you

use. When you select  on the central display, the digital map with the applications appears in the lower display area. Compared to the home screen with a classic menu, the steps required to call up the applications are reduced. You can switch between the zero layer and the home screen with a classic menu.

The applications can be hidden from the display area and shown again.

The zero layer provides the following modules and applications:

- Navigation module
  - In the expanded view you can, for example, display the route overview, switch on the display of traffic information and make settings for [View](#) (map), [Messages & Acoustic Signals](#), [Route](#).
- Entertainment (media, radio) and telephone
  - When the lower display area is shown, the entertainment sources are always displayed.
  - A mobile phone must be connected to the MBUX multimedia system for the phone to be displayed.

- Active applications

The lower display area shows an active message program, for example.

- Suggestions

Suggestions are displayed on the lower display area based on context and your user behavior. Here are a few examples:

- Latest calls
- Active message programs
- Vehicle functions
- Online voice applications

The applications are first displayed in a reduced view. By tapping on them, you can operate them or open the associated menu (expanded view).

A long press on a suggestion opens a context menu in which further functions are available.

The learning function can be switched on and off for the options .

## Overview zero layer

### Digital map and user-specific applications (example)



- ① Navigation module (reduced view)
- ② Enters a destination  
Searching for parking
- ③ Calls up the Control Center (pull the bar down)

- ④ Status line
- ⑤ Calls up user profile settings
- ⑥ Content sharing menu (if available)
- ⑦ Telephone

Requirement for phone: the mobile phone is connected to the MBUX multimedia system.

- ⑧ Entertainment sources (media, radio)
- ⑨ 

Press briefly: shows all applications (→ page 319)

Press and hold: calls up the home screen with classic menu

- ⑩ Route monitor  
e.g. route list, lane recommendations, toll stations, 3D image of the upcoming driving maneuver

The zero layer shows the digital map and the user-specific applications.

The following user-specific applications are displayed in the lower display area:

- Suggestions

Requirement: suggestions are activated (→ page 326).

- Active applications  
e.g. a message program
- Telephone ⑦
- Entertainment sources ⑧
- Online voice applications

The lower display area can be hidden and shown (→ page 319).

#### Information about entertainment sources

You can operate the applications in the reduced view or in the menu (expanded view) (→ page 319).

Examples:

- Control a media source, e.g. pause/play, next track, set a station
- Select tracks from the current playlist or stations from the station list
- Select a media source

The media source must be connected to the MBUX multimedia system.



### Information about the telephone

To use the functions, the mobile phones must be connected to the MBUX multimedia system.

Requirement for suggestions: the **Calls & Messages** option is activated in the suggestions.

Examples:

- Answer a call and call a missed call  
The missed calls are displayed for the mobile phones connected to the MBUX multimedia system.
- Display contacts and call list and call a contact
- Use voice functions
- Suggest contacts  
The contacts are suggested for the mobile phones connected to the MBUX multimedia system. No contacts are suggested for the mobile phones that are linked to another user profile.
- Write messages to contacts (suggestion)
- Connect a device via the device manager (suggestion)

### Information about active applications

The following functions are available:

- Operating the massage program
- Raising or lowering the vehicle level

### Suggestions for comfort and vehicle functions as well as navigation

Requirement: the **Comfort, Vehicle** and **Navigation** options are activated in the suggestions.

- Operating the massage program  
For example, the multimedia system suggests a program at a certain time.
- Opening the tailgate  
Requirement: the vehicle is equipped with trunk lid convenience closing.
- Setting the vehicle level
- Making heating settings
- Activating/deactivating Parking Assist PARKTRONIC
- Selecting previous destinations and destinations from favorites

### Suggestions for online voice applications

Requirement: the **Online Voice Services** option is activated in the suggestions.

The suggested voice applications are made available online and are based on your previous voice inputs.

Examples:

- What will the weather be like tomorrow?
- Play the messages.
- Start geoquiz.
- Open the garage door.

### Calling up and operating the zero layer

#### Calling up the zero layer



When the vehicle has been switched on, the zero layer is displayed with the digital map. Navigation is active.

▶ **From another application:** press the  button on the right side of the steering wheel.

or



▶ Tap on .

### Operating applications in the reduced view (examples)

- ▶ **Media:** to play the previous or next track, tap  or .
- ▶ **To answer a call or call a missed call:** tap on the contact. After the connection has been established, the call functions are available.
- ▶ **To end a call:** tap on the contact again.
- ▶ **To reply to message:** tap on a message and dictate the message via the MBUX Voice Assistant.
- ▶ **To start a message program:** tap on the application and start the message program.
- ▶ **To select a previous destination:** tap on the application and select one of the previous destinations.
- ▶ **To select a destination from the favorites:** tap on the application and select the destination.

### Hiding and showing the display area with applications

- ▶ **To hide:** pull the applications down.

- ▶ **To show:** pull the bar above  upwards.
- or
- ▶ Select .
- or
- ▶ Press the  button on the steering wheel on the right.

### Navigation module (expanded view)

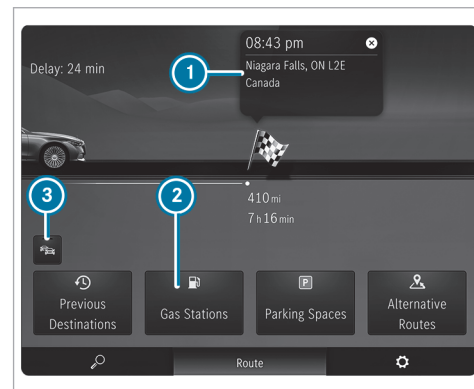

Example: route guidance is active

- ① Destination
- ② Searches for a gas station
- ③ Switches traffic information display on or off
- ▶ Tap on the navigation module (→ page 318).
- ▶ Select **Route** in the lower menu bar.

### Operating a menu in the lower display area (example: active message program)

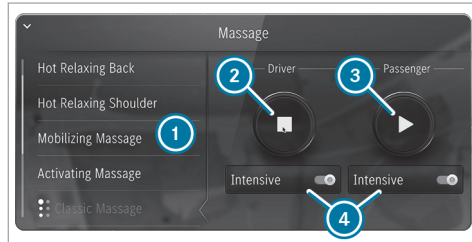

- ① Selects a message program
  - ② Starts/stops a message program for the driver
  - ③ Starts/stops a message program for the front passenger
  - ④ Sets the message program intensity for the driver's or front passenger seat
- ▶ Tap on the application.  
The expanded view of the application is displayed.
- ▶ **To close the menu:** select .



### Opening and closing the context menu for a suggestion

- ▶ Press and hold on a suggestion.  
The context menu opens and shows the **No Longer Suggest** option, for example.
- ▶ **To close:** swipe downwards.



### Removing a suggestion from the display area

- ▶ Swipe the suggestion upwards.

### Showing all applications

- ▶ Press  briefly.  
Available applications are displayed. The global search is available.
- ▶ **To hide applications:** briefly press  again.



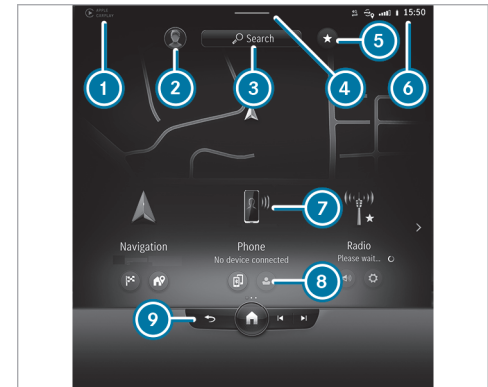

### Switching between zero layer and home screen with classic menu

- ▶ Long press on .
- ▶ **To return to the zero layer:** press and hold on .

### Home screen overview



- ① Status line
- ② Calls up user profile settings and switches user
- ③ Uses the global search
- ④ Calls up the Control Center: pull the bar down
- ⑤ Calls up favorites
- ⑥ Displays in the status line

- ⑦ Calls up applications
- ⑧ Quick-access to application
- ⑨ Global menu
-  Calls up previous menu
-  Press and hold: switches between home screen and zero layer
-  Previous track or previous radio station
-  Next track or next radio station
- ⓘ During a telephone call, the call duration is displayed in global menu ⑨.







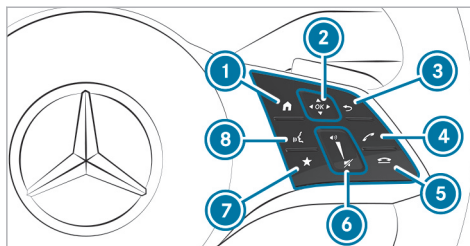

The following functions are called up in the Control Center:

- Notifications Center
- Favorites
- Vehicle quick-access



## Operating the MBUX multimedia system

### Using Touch Control



- ①  Shows the home screen
- ② Touch Control
  -     swipe in the direction of the arrow (navigate)
  -  Press (confirm)
- ③  Returns to the previous display
- ④  Makes or accepts a call
- ⑤  Rejects or ends a call
- ⑥ To increase volume: swipe upwards  
To reduce volume: swipe down

 To switch off the sound: press

- ⑦  Calls up favorites
- ⑧  Starts the MBUX voice assistant

You can navigate through menus and lists via the touch-sensitive surface of Touch Control ② using a **single-finger swipe**, e.g.:

- ▶ **To enter a character:** select a character using the keyboard and press on Touch Control ②.
- ▶ **To select a menu option:** scroll in a list and press Touch Control ②.
- ▶ **To move the digital map:** swipe in any direction.

## Using the touchscreen

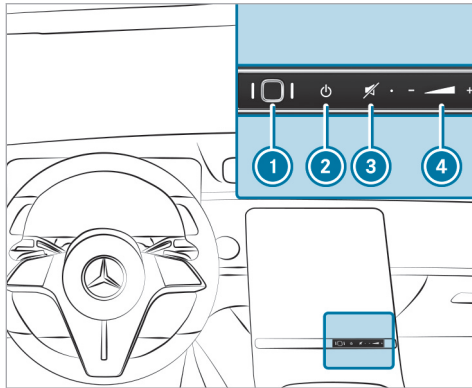

Example: Control elements under the central display

- ① Fingerprint sensor
- ② Switches the MBUX multimedia system on or off
- ③ Switches the mute function on/off

- ④ Adjusts the volume  
Press  $\square$  or  $\square$  or swipe over the button
- ▶ **To select a menu item or entry:** tap on a symbol or an entry.
- ▶ **To increase the map scale:** tap twice quickly with one finger.
- ▶ **To reduce the map scale:** tap with two fingers.
- ▶ **To enter characters with the keypad:** tap on a button.
- ▶ **To navigate in menus:** swipe up, down, left or right.
- ▶ **To use handwriting to enter characters:** write the character with one finger on the touchscreen.
- ▶ **To zoom in and out of the map:** move two fingers together or apart.
- ▶ **To enlarge or reduce the size of a section of a website:** move two fingers together or apart.
- ▶ **To turn the digital map:** turn counter-clockwise or clockwise using two fingers.

- ▶ **To move the digital map:** touch the touchscreen and move your finger in any direction.
- ▶ **To save the destination in the digital map:** touch the touchscreen and hold until a message is shown.
- ▶ **To set the volume on a scale:** touch the touchscreen and move the finger to the left or right.
- ▶ **To call up a global menu in the applications:** touch the touchscreen and hold until the **Options** menu appears.

## Function of the MBUX Voice Assistant

**⚠ WARNING** Risk of distraction from information systems and communications equipment

If you operate information systems and communication devices integrated in the vehicle when driving, you could be distracted from the traffic situation. This could also cause you to lose control of the vehicle.

- ▶ Only operate this equipment when the traffic situation permits.
- ▶ If you cannot be sure of this, stop the vehicle whilst paying attention to road and traffic conditions and operate the equipment with the vehicle stationary.

For your own safety, always observe the following points when operating mobile communications equipment and especially your voice control system:

- Observe the legal requirements for the country in which you are driving.
- If you use the voice control system in an emergency your voice can change and your telephone call, e.g. an emergency call, can thereby be delayed.
- Familiarize yourself with the voice control system functions before starting the journey.

Using the MBUX Voice Assistant, vehicle functions and various areas of the MBUX multimedia system can be operated by voice input. The MBUX Voice Assistant is operational approximately half a minute after switching on the vehicle and can be

operated from all seats. Further information and examples of voice commands can be found in the Digital Operator's Manual.

You can use the MBUX Voice Assistant to operate the following functions depending on the vehicle equipment:

- Telephone
- Text messages and e-mails
- Navigation
- Radio and media
- Vehicle functions
- Online functions

Full functionality of the voice control system is only available for you with activation of online voice control.

### Conducting a dialog

#### Starting a dialog

- ▶ Say "Hey Mercedes" to activate the MBUX Voice Assistant. Voice activation must be switched on in the multimedia system.

or

- ▶ Press the  button on the multifunction steering wheel.

A blue line appears in the MBUX multimedia system. The dialog can be started.

For the dialog with the MBUX Voice Assistant, you can use complete sentences of colloquial language as voice commands. Voice activation can also be directly combined with a voice command, e.g. "Hey Mercedes, how fast can I drive?"

#### Calling up help

- ▶ **For information about the MBUX Voice Assistant:** say "Hey Mercedes, what can you do?"
- ▶ **Digital Operator's Manual:** "Show me the Operator's Manual". The full extent of the Digital Operator's Manual is available when the vehicle is stationary.

#### Operating functions (examples)

- ▶ **To operate the navigation:** "Search for an Asian restaurant, but not Japanese, in South Manhattan."
- ▶ **To operate the phone:** "Call my father."

- ▶ **To change the system language to English (short command):** "Change language to English".
- ▶ **To operate the radio:** "Show me the list of radio stations."
- ▶ **To operate media:** "Switch on random playback."
- ▶ **To operate vehicle functions:** "Switch the seat heating to level 2."
- ▶ **To operate online functions:** "What's the time in Sydney?"
- ▶ **To ask a question about the vehicle:** "Do I have Blind Spot Assist?"

### Information on users, suggestions and favorites

**⚠ WARNING** Risk of becoming trapped during adjustment of the driver's seat after calling up a driver profile

Selecting a user profile may trigger an adjustment of the driver's seat to the position saved under the user profile. You or other vehicle occupants could be injured in the process.

- ▶ Make sure that when the position of driver's seat is being adjusted using the multimedia system, no people or body parts are in the seat's range of movement.

If there is a risk of someone becoming trapped, immediately stop the adjustment process by:

- ▶ a) Pressing the warning message on the central display.
- or
- ▶ b) Pressing a position button of the memory function or a seat adjustment switch in the driver's door.
- The adjustment process is stopped.

The driver's seat is equipped with an anti-entrapment feature.

If the driver's door is open, the driver's seat will **not** be set after calling up the driver's profile.

### User profiles and user-specific content

Prerequisites for the vehicle owner:

- You have a Mercedes me user account.

- You have a Mercedes me PIN.
  - You have agreed to the terms of use.
  - The vehicle is linked to a Mercedes me user account.
- i** If one of the pre-requisites listed is missing or if no user profile has been selected, the data described in the following section will be saved in the vehicle as the standard setting. Standard settings can be changed by all vehicle users.

User profiles save personal settings. If the vehicle is used by several people, a person can change their profile settings without changing the settings of other users.

You can individualize a user profile in the vehicle using the set-up assistant or using the settings in your user profile. Some settings, e.g. the Mercedes me PIN and a profile photo are made in the Mercedes me App or in the Mercedes me Portal.

User-specific content and applications with personal data are protected by different levels of security. To access protected content, the

Mercedes me PIN and, depending on the vehicle equipment, biometric sensors can be used.

- ❶ The security level is set by the multimedia system and calculated from the combination of all sensor inputs. Some security levels cannot be turned off.
- ❷ When a user profile is activated, the following personalized comfort systems, for example, can be adjusted or their settings loaded:
  - Seat
  - Ambient light
  - Outside mirrors
  - Roller sunblinds
  - Climate control settings

If the user profile is activated when driving, the driver's seat position will not be adjusted.

Depending on the vehicle equipment you can, as a user, save the following settings, for example:

- Driver's seat, steering wheel and mirror settings
- Climate control
- Ambient lighting

- Radio (including station list)
- Suggestions and favorites

### Suggestions

The vehicle can learn the habits of the driver. It then makes suggestions regarding navigation destinations, phone numbers and music preferences. The requirements for that are the selection of a user, your consent to the recording of data and sufficient collected data.

### Favorites

Favorites offer you quick access to frequently used applications. 100 favorites are available in total.

### Configuring users, suggestions and favorites

#### Requirements:

- The vehicle is stationary.

Multimedia system:



### Adding a user

- ▶ Select **+** **Add User**.  
A QR code is loaded.
- ▶ Scan the displayed QR code with the Mercedes me App or any QR code scanner on a mobile device. If the Mercedes me App is not yet installed on your mobile device, you will be directed to the store of your mobile device.
- ▶ Follow the directions in the app.  
The vehicle is connected with your Mercedes me user account. This automatically creates your user profile in the vehicle.  
You will be informed when your user profile is available.  
When the vehicle is stationary, the set-up assistant starts automatically after user selection.

### Protecting user-specific content and applications

If you add a new user, access protection is already activated for the user profile. The



Mercedes me PIN and, depending on the vehicle equipment, biometric sensors are available for access. Biometric sensors in the vehicle must be taught in. The authentication process then takes all taught-in and available sensors into account.

The following user-specific content and applications are protected, for example:

- User selection and user profile settings
  - Biometric sensors
    - The teaching-in of biometric sensors is protected.
  - Suggestions
    - The data and determination of the most probable navigation destinations, media sources, radio stations, contacts and messages are protected.
  - ENERGIZING COACH
    - The recorded health data and their evaluation are protected.
  - Mercedes me connect store
    - The purchase of services is protected.
- ▶ Switch **Protect Content** on or off.

▶ Switch **Access Protection** on or off.

- ① When access protection is switched off, your user profile can be accessed and changed from every vehicle seat.
- ① Access protection is switched on or off on a vehicle-specific basis.

### Setting up, editing and deleting biometric recognition

The biometric data models are saved in the sensors in the vehicle. If recognition has been taught-in, this sensor serves as a contributory factor for authentication on the multimedia system.

- ▶ Select **Protect Content**.
- ▶ Select **Fingerprint Recognition** or **Voice Recognition**.
- ① If necessary, authenticate yourself on the multimedia system.

### Setting up fingerprint recognition

- ▶ Place and lift your finger several times on the fingerprint sensor under the touchscreen . The finger is scanned. If the scanning procedure is successful, a message appears on the central display. You can unlock your user pro-

file and protected applications with your finger print.

### Setting up voice recognition

- ▶ Speak the sentence shown on the central display and follow the voice assistant's instructions. If the voice recognition was successful, a message appears on the central display. You can unlock your user profile.
- ① Avoid background or disturbing noises during voice recognition.

### Deleting biometric data

- ▶ Tap on  , for example, behind **Fingerprint Recognition**.
- ▶ Select **Yes**.

### Selecting a user

- ① When you call up your driver profile, the driver's seat and the steering wheel can be set. You can cancel the setting process with the following actions:
  - Press **Tap Here to Cancel** message on the central display.

- Press one of the seat operating buttons in the driver's door.

▶ Select **Change User**.

▶ Select a user.

▶ When requested to do so, authenticate with the Mercedes me PIN or a taught-in biometric characteristic.

The user profile is loaded and activated.

**i** If you select **Continue Without Selecting a User**, no specific settings for the user profile are loaded.

### Configuring and deleting suggestions

▶ Select .

▶ Select **Settings**.

▶ Select **System**.

▶ Select **Suggestions**.

▶ Select .

▶ Switch the options on or off individually. If an option is switched on and sufficient data has been gathered, personalized suggestions based on your user behavior will be offered to you on the zero layer. These are, for example,

navigation destinations visited, phone numbers dialed as well as suggestions based on your music preferences.

▶ **To delete collected suggestions:** select .

▶ Select **Yes**.

The suggestions are reset.

### Adding favorites from categories

▶ Select .

▶ Select .

▶ Select .

▶ Select  **Create New Favorite**.

▶ Select the category.

▶ Select a favorite.

## System settings

### Overview of the system settings menu

In the system settings menu, you can make settings in the following menus and control elements:

- Display

- Display brightness
- Control elements
  - Keyboard language and handwriting recognition
  - Sensitivity of Touch Control
- MBUX voice assistant
- MBUX Interior Assistant
- Sound
  - Entertainment
  - Navigation and traffic announcements
  - Telephone
- Data protection
- Connectivity
  - Wi-Fi, Bluetooth®
- Time & date
- Language
- Units for distance
- System PIN
- Suggestions
- Software update

- System reset

### Overview of software updates

Important software updates may be necessary for the security of your multimedia system's data. Install these updates, or else the security of your multimedia system cannot be ensured.

The multimedia system displays a corresponding message when a software update is available.

If the **Automatic Online Update** option is active, software updates are downloaded automatically. If the option is deactivated, you will be informed of new software updates once. The software updates are available for downloading for a limited period of time.

Carrying out a software update:

- You can start software updates via the communication module.
- You can start software updates via a Wi-Fi hotspot.
- You can start map updates from an external medium.

- ① Online software updates cannot be performed via external Wi-Fi hotspots that are encrypted via TKIP.
- ① If the WLAN hotspot requires logging in via the browser, once the connection is successfully established the browser will open in order to start the update. To start the download follow the instructions in the browser.
- ① To complete software updates via the communication module, the vehicle must be connected with the Internet and a Mercedes me user account.
- ① To complete software updates via Wi-Fi, the vehicle must be connected to an external Wi-Fi hotspot.

A software update consists of three steps:

- Downloading or copying of the data required for installation
- Installation of the downloaded software update
- Activation of the downloaded software update

- ① It may be necessary to restart the MBUX multimedia system after completion of a software update.
- ① While some software updates are being downloaded, the multimedia system cannot be operated and the vehicle functions may be restricted.
- ① Some software updates require a safe vehicle status for the installation to be completed. They can only be carried out in a safely parked vehicle with the vehicle switched off.

**For software updates requiring a safe vehicle status:** when the last installation step is reached, a message appears on the central display after the vehicle is switched off. Follow the step-by-step instructions on the central display to complete the installation.

There are software updates that can only be installed when the vehicle is safely parked, there are no more people in the vehicle and the vehicle is locked.

### Availability of the driver and central display

During the installation of software updates, it is not possible to use the vehicle, central display

and driver display. You may receive the following display message when an installation is running:

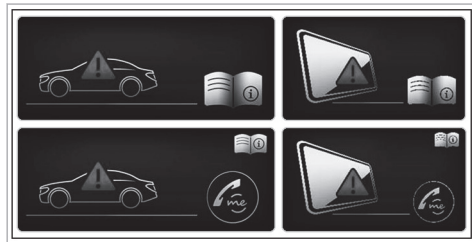

- ❗ The display message does not appear every time a software update is installed.

In rare cases, an error can occur during the installation. The multimedia system automatically attempts to restore the previous version.

If it is not possible to restore the previous version, the display message shown above appears every time the vehicle is started.

#### Failure of the driver display

If the driver display fails or there is a malfunction, you may not recognize limitations in the functions

of systems relevant to safety or the speed display, for example. The operating safety of the vehicle may be impaired. Drive on carefully and have the vehicle checked at a qualified specialist workshop immediately (→ page 481).

Further information about software updates can be found at <https://me.secure.mercedes-benz.com>

#### Failure of the central display

If the central display fails or the display message shown above is shown continuously, several systems such as the reversing camera, Parking Assist PARKTRONIC or climate control are no longer available. Drive on carefully and consult a specialist workshop as soon as possible.

#### Setting up a Wi-Fi hotspot

##### Requirements

- The Wi-Fi function is activated on the multimedia system and the communication device to be connected.

- The communication device to be connected supports at least one of the types of connection described.

The connection types shown depend on the device to be connected. The function must be supported by the multimedia system and by the device to be connected. The type of connection must be selected on the multimedia system and on the device to be connected.

- ❗ Some functions may first need to be activated on the communication device being connected. More detailed information can be found in the manufacturer's operating instructions.
- ❗ The use of the vehicle data tariff by external devices is not available in all countries.

Multimedia system:

→ » Settings » System  
» Internet and Bluetooth

- ❗ The availability of the functions is dependent on the country.

▶ Select **Wi-Fi**.

The controller is to the right: Wi-Fi is switched on.

When the Wi-Fi function is switched on, you can connect the multimedia system with external hotspots or make it available as a hotspot for external devices.

When the Wi-Fi function is switched off, it is not possible to establish a hotspot connection.

- i** Depending on the vehicle equipment, you can purchase a data package directly from a mobile phone network provider via the Mercedes me Store. To be able to use the data package, you conclude a separate contract with a mobile phone network provider via the Mercedes me Store, which can be terminated at any time and for which there are no costs. This contract is a prerequisite for using the services from the previously purchased package. The availability of this option is dependent on the country. If the data package option is not available or can be upgraded, you can purchase data volume directly from the mobile phone network provider for a fee.
- i** The use of the vehicle data tariff by external devices is not available in all countries.

### Using the multimedia system as a Wi-Fi hotspot

- ▶ Select **MBUX Hotspot**.
- ▶ Select one of the following connection options.

#### Connecting using a QR code

Requirement: an app for scanning the QR code is installed on the device being connected.

Alternatively: the device being connected has an integrated QR code scanner (see the manufacturer's operating instructions).

- ▶ Scan the QR code shown.
- ▶ The Wi-Fi connection is established.

#### Connecting using a security key

- ▶ Select the vehicle from the device to be connected. The vehicle is displayed with the **MBUX XXXXX** network name.
- ▶ Enter the security key shown on the device to be connected.
- ▶ Confirm the entry.

### Generating a new security key

- ▶ Select the **Generate New Security Key** option in the **MBUX Hotspot** menu.
- ▶ Confirm the prompt with **Yes**.  
A new security key is generated.

A connection will be established with the newly created security key.

- i** When a new security key is generated, all existing Wi-Fi connections are then disconnected. If the Wi-Fi connections are re-established, the new security key must be entered.

### Using a mobile communication device as a Wi-Fi hotspot (tethering)

- i** This function is country-dependent.
- ▶ Select the **Manage Internet Access** option in the **Internet and Bluetooth** menu.
- i** The Wi-Fi function on the mobile phone and Internet access via Wi-Fi must be activated (see the manufacturer's operating instructions).
- ▶ Select **Search for Access**.
- ▶ Select the network.

▶ Log in to the Wi-Fi network.  
or

▶ Select the mobile phone with the  Wi-Fi symbol.

ⓘ With external Wi-Fi hotspots, which are encrypted via TKIP, online software updates cannot be carried out via the external Wi-Fi hotspot.

### System language

#### Notes on the system language

This function allows you to determine the language for the menu displays and the navigation announcements. The selected language affects the characters available for entry. The navigation announcements are not available in all languages. If a language is not available, the navigation announcements will be in English.

#### Setting the language

Multimedia system:

➔  ➔ Settings ➔ System  
➔ Language

#### Setting the system language

A list of the available system languages is shown.

▶ Select a language.  
The system language is switched to the selected language.

#### Resetting the multimedia system (reset function)

**⚠ WARNING** Risk of accident due to failure of central display functions

While the multimedia system is reset, its functions, such as the rear view camera, are not available.

▶ Only reset the multimedia system when the vehicle is stationary.

#### Requirements:

- The vehicle is switched on.
- The vehicle is stationary.

Multimedia system:

➔  ➔ Settings ➔ System ➔ Reset

When resetting the system, personal data and settings are deleted, for example:

- Connected devices
  - Individual user profiles
  - Biometric data
- ⓘ The data used and saved in the multimedia system by the driver assistance systems is deleted.

▶ Select **Reset**.  
A query appears asking if the system should really be reset.

▶ Select **Yes**.  
The multimedia system is reset to the factory settings. The multimedia system is restarted after the system reset.

ⓘ Due to data protection, as well as the function of individual driving systems and driving safety systems, it is a requirement to carry out a complete system reset before selling the vehicle or transferring it to a third party, or after use as a hire car.

## AMG TRACK PACE

### Function of AMG TRACK PACE

**i** This function is an on-demand feature and can be activated via Mercedes me after you purchase your vehicle. The Digital Operator's Manual contains further information on Mercedes me and on-demand features.

With AMG TRACK PACE, the driving characteristics on race tracks can be analyzed and optimized. You can drive previously saved race tracks (e.g. the Hockenheimring), or record and save new tracks. The lap times set will be stored for every track. These can be analyzed and compared with other lap times to achieve the best possible race results. Additionally, acceleration and braking operations can be measured and stored.



**Note:** Use AMG TRACK PACE only on closed circuits away from public roads. Adapt your driving style to your personal skill level and environmental conditions. As the driver, you are solely responsible for driving your vehicle. Park your vehicle safely before operating the application.

### Setting Track Race



Multimedia system:

↳ TRACK PACE ▶▶ Track Race

#### Recording a new track

- ▶ Select  **New Track** .
- ▶ Select  **Start Record**. at the desired starting point.  
The track recording starts at this point.

During track recording, sectors can be set to divide up the track.



- ▶  Select **Set Sector**.
- ▶ Select  **Stop Recording** to end track recording or cross the starting line again.
- ▶ Confirm the prompt with **Yes**.
- ▶ Select the weather.

- i** The temperature is determined automatically.
- ▶ Enter a name.
- ▶ Press  to confirm.  
The track is saved under the name entered.

### Searching by track name



- ▶ Select  **Search** .
- ▶ Enter the track name.  
Tracks with the searched name are displayed.

### Measuring time on a saved track

- ▶  Select **All tracks**.
- ▶ Select the desired track.
- ▶ Select .
- ▶ Select **Start Time Recording** if you are already at the starting line.

or



- ▶ Select **Navigate to** for navigation to the starting line.  
Timing begins automatically when the starting line has been crossed.

- i** When  is selected, the track display can be switched to AR. In addition, it is possible to switch to the telemetry display by selecting .
- ▶ Select  **Stop timekeeping** to end timekeeping.

- ▶ Confirm the prompt with **OK**.
- ▶ Select the weather.
- ▶ Select **Yes** to save the times driven for this track.



### Showing readings during Track Race

The following readings can be shown:

- Tire temperature
  - Miniature map
  - Sector overview
  - Engine data
  - G-force display
  - Lap overview
- ▶ Select  **Start Time Recording** .
  - ▶ Select .
  - ▶ Drag the desired display from the grid on the left or right edge of the central display. The readings are shown during the Track Race.

By selecting  on the active display, you can deactivate this.

### Displaying the analysis

- ▶  Select **All tracks**.  
An overview of all the driven tracks appears.
  - ▶ Select a track.
  - ▶ Select a session.
- The following data are displayed:
- Lap and sector times
  - Average and top speed
  - Driver
  - Vehicle
  - Date
  - Weather
- ▶ Select **Add Recording** to use a different session as a reference value.
  - ▶ Select  to return to the overview.
  - ▶ Select **Diagram**.
  - ▶ Set the desired parameters. The analysis is displayed.

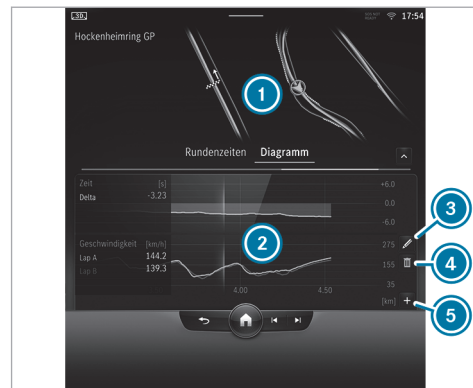



- ① Lap overview
  - ② Parameter overview
  - ③ Editing parameters
  - ④ Deleting parameters
  - ⑤ Adding new parameters
- ⓘ The following values can be set for the parameters, for example:
- speed





- Longitudinal/lateral acceleration
- Steering angle
- Engine speed
- Engine oil/tire temperature

Based on the analysis, you can check and optimize the driving behavior for any position on the track.

### Exporting tracks (USB)

- ▶ Select  **Tracks** .  
An overview of all stored tracks appears.
- ▶ Select the desired track.
- ▶ Select options  for the desired track.
- ▶ Select **Export Track to...**  
The selected track can be exported to a USB storage device connected to the vehicle.

### Editing tracks and recordings

- ▶ Select  **Tracks** .
- ▶ Select the desired track.
- ▶ Select options  for the desired track.
- ▶ Select **Rename** or **Delete**.

or

- ▶ Select a track.
- ▶ Highlight the desired recording.
- ▶ Select  options.
- ▶ Select **Export to...** or **Delete**.

### Setting Drag Race

Multimedia system:

↳ TRACK PACE ▶▶ Drag Race

### Measuring acceleration

- ▶ Select  **Drag race options**.
- ▶ Select **Acceleration**.
- ▶ Set a starting speed or select **Automatic**.  
Measurement will begin as soon as the specified starting speed has been reached.
- ▶ Set a target speed.  
Measurement will stop as soon as the specified target speed has been reached.
- ▶ Start off and begin the measurement.  
Measurement will begin when the vehicle accelerates.

You can stop measurement early by interrupting the acceleration procedure.

### Quarter-mile race

- ▶ Select  **Drag race options**.
- ▶ Select **Quarter Mile**.
- ▶ Set a target distance.  
Measurement will stop as soon as the specified target distance has been reached.
- ▶ Start off and begin the measurement.  
Measurement will begin when the vehicle accelerates. Timing will run until the target distance or a maximum of one mile has been traveled.

You can stop measurement early by interrupting the acceleration procedure.

### Measuring braking

- ▶  **Drag Race options**
- ▶ Select **Braking**.
- ▶ Set a starting speed or select **Automatic**.
- ▶ Start off and begin the measurement.

- ▶ Brake to a standstill. Measurement is incremental, in steps of 6 mph (10 km/h) to a standstill. If the braking procedure is started e.g. at a speed of 98 mph (157 km/h), measurement will start as soon as 93 mph (150 km/h) has been reached

### Storing and calling up measured values

If a measurement is completed or canceled, a prompt will appear asking whether the measurement should be saved.

- ▶ Confirm the prompt with **OK** to save.

### Calling up saved measurements

- ▶  Select **History**.
- ▶ Select **Acceleration**, **Quarter Mile** or **Braking**.
- ▶ Select a measurement. The desired measurement will be displayed in detail.

or

- ▶ Delete a measurement.

### Calling up the telemetry display

Multimedia system:

- ▶  **TRACK PACE** ▶▶ **Telemetry**

The telemetry display shows current vehicle data as a digital value and as a diagram. Up to four parameters can be selected to be shown on the display.

For example:

- Engine speed
  - Wheel angle
  - Speed
  - Steering angle
- ▶ Set the desired parameters.
  - ▶ Set the time. The set parameters will be evaluated for the selected time on the diagram.

### Configuring AMG TRACK PACE

#### Requirements

To connect a mobile device to the TRACK PACE app:

- The TRACK PACE app is installed on the mobile end device.
- The mobile end device is connected to the multimedia system via Wi-Fi.

Multimedia system:

- ▶  **TRACK PACE** ▶▶ 

### Connect mobile device via the TRACK PACE app

The TRACK PACE app makes it possible to record videos and to synchronize them with stored tracks.

- ▶ Select **TRACK PACE App**.
- ▶ Select **Authorize a New Device**.
- ▶ Start the TRACK PACE app on the device to be connected.
- ▶ Select **Next** and confirm the authorization prompt. A four-digit code is shown on the central display.
- ▶ Enter the code on the smartphone. The device is authorized.

### De-authorizing the mobile device

- ▶ Select **TRACK PACE App**.
- ▶ Select a device.
- ▶ Confirm the message prompt with Yes. The device is de-authorized.

### Setting the TRACK PACE display on the head-up display and driver's display

- ▶ Select **IC and HUD Contents**.
- ▶ Activate or deactivate the desired contents. The contents on the head-up display and the driver's display are adapted.
- ⓘ For further information on the Head-up Display (→ page 303).
- ⓘ Further information about the driver's display (→ page 301).

### Setting acoustic feedback

- ▶ Select **Acoustic Feedback**. A scale with values from 0 to 10 is shown.
- ▶ Select a setting.

### Displaying statistics

- ▶ Select **TRACK PACE Statistics**. Statistics on the current user profile are displayed. The following data are displayed:
  - Driving time
  - Track driven
  - Recorded tracks
  - Recorded Track Races
  - Laps recorded
  - Recorded Drag Races
  - Maximum design speed

### Activating the ambient light

If this function is active, the vehicle interior is lit in red or green depending on delta time.

- ▶ Select **Ambient Light**.
- ▶ Activate or deactivate the function.

### Adjusting the dashcam

If the vehicle is equipped with a dashcam, it can be used in AMG TRACK PACE.

- ▶ Select **Dashcam**.
- ▶ Select **Track Race** or **Drag Race** and activate **Activate Recording**.
- ▶ You can set which overlay is to be used in the recorded video under **Video Overlay Content**.

### Activating boost strategy

This function is used to increase performance on a race track and is available only in the  drive program.

- ▶ Select **boost strategy**.
- ▶ Activate or deactivate the function.
- ⓘ The function is not available for all vehicle models.

## Plug-in hybrid settings

### Configuring the charging settings

Multimedia system:

  ▶▶ Hybrid ▶▶ Charging

### Setting the charging program

- ▶ Select **Home**, **Work** or **Standard**.

- ❗ The Standard charging program is automatically activated when the vehicle has been switched on or off.

### Opening the socket flap

- ▶ Press **Open socket flap**.  
The socket flap opens and can be closed again by hand. When the socket flap is open and a vehicle plug is inserted and locked, charging can be terminated by pressing the **End charging and unlock** button that is then available.
- ❗ The availability of this function is dependent on the vehicle's equipment.

### Unlocking the charging cable (mode 3 or 4)

When the function is active, the charging cable is unlocked when the maximum state of charge is reached.

- ▶ Select **Home** or **Work**.
- ▶ Activate or deactivate **Unlock Charging Cable**.

### Activating or deactivating location-based charging

- ▶ Select **Charging Program, Home** or **Charging Program, Work**.

- ▶ Activate or deactivate **Select Based on Location**.

When the function is activated, the vehicle's current position is saved as one of the selected options. When the address is reached again, a brief query appears as to whether the respective charging program should be selected.

### Setting the departure time

- ▶ Select **Next Departure Time**.

The following charging times can be selected:

- Individual charging times
- A **Week Profile**

### Setting an individual departure time

- ▶ Select **Add New Time** and set the desired departure time.

or

- ▶ Select  and adapt an existing departure time.

### Setting repeat days

- ▶ Select **Add New Time** and set the desired departure time.

- ▶ Mark the relevant weekdays for which the departure time is to apply and confirm with **OK**.

or

- ▶ Select  and edit existing repeat days.

### Setting the maximum state of charge

- ▶ Select **Maximum State of Charge**.

- ▶ Set the desired percentage.  
The high-voltage battery is charged up to the set percentage as a maximum.

- ❗ The percentage can be set in increments of 10%.
- ❗ As soon as the maximum state of charge is reached, a notification is shown on the central display that the charging process is completed and the journey may be continued. The maximum state of charge can be saved in the Home and Work charging programs. In the Standard charging program, the setting is automatically reset to a state of charge of 100% after the vehicle has been switched on or off.

## Overview of the energy flow display in the multimedia system

The active components of the hybrid system are highlighted on the energy flow display. The energy flow between the individual components is shown in color.

The components displayed are:

- State of charge of the high-voltage battery
- Combustion engine
- Energy flow
- High-voltage battery

The energy flow is shown in different colors depending on the operating status:

- **White:** constant energy flow
- **Red:** high energy flow (boost effect)
- **Green:** low-emission energy flow in the case of recuperation, electric mode and charging the high-voltage battery

## Calling up the energy flow display

Multimedia system:



Info

▶ Select **Energy Flow**.

The energy flow in the vehicle will be displayed.

Information on the status of the hybrid system and the current state of charge of the high-voltage battery will be displayed in addition to the energy flow.

## Off-road menu

### Off-road menu overview in the multimedia system

The **Off-road** menu provides an overview of the most important, relevant data for off-road driving. The content is displayed in different tiles that can be changed with directional arrows or swipes. In addition, this menu contains buttons for quick access to certain vehicle functions relevant to off-road operation.

Displayed data are, for example:

- Artificial horizon



- Compass
- Altitude
- Steering angle of the front and rear wheels
- Torque and power
- Tire pressure and temperature
- Transparent hood

## Setting the off-road menu in the multimedia system

Multimedia system:



### Setting displays in the central display

▶ Press  ,  or on the display itself to jump to the next display.

### Quick access: switching Parking Assist PARKTRONIC on or off

▶ Press  to switch the function on or off.

① Further information on Parking Assist PARKTRONIC (→ page 276).

**Quick access: switching ESP® (Electronic Stability Program) on or off**

- ▶ Press  to switch the function on or off.
- ❶ Further information on ESP (→ page 225).

**Quick access: switching manual shifting on or off**

- ▶ Press  to switch the function on or off.
- ❶ Additional information on manual shifting (→ page 191).

**Quick access: switching DSR (Downhill Speed Regulation) on or off**

- ▶ Press  to switch the function on or off.
- ❶ Further information on DSR (→ page 241).

**Quick access: setting the vehicle level**

- ▶ Press  to raise or lower the vehicle.
- ❶ Additional information about vehicle level .
- ❶ The availability of individual functions depends on the country and equipment.

**Navigation and traffic****Notes on navigation****Route guidance with augmented reality**

**⚠ WARNING** Risk of accident and injury as a result of distraction, incorrect depiction or wrong interpretation of the display

The camera image of the augmented reality display is not suitable as a guide for driving.

- ▶ Always keep an eye on the actual traffic situation.
- ▶ Avoid extended observation of the camera image.

**⚠ WARNING** Risk of accident and injury due to imprecise positioning of additional information

The additional information from the augmented reality display may be inaccurate and is not a substitute for observing and assessing the actual driving situation.

- ▶ Always keep an eye on the actual traffic situation when carrying out all driving maneuvers.

**Switching navigation on**

Multimedia system:



- ▶ Alternatively, press the  button on the steering wheel on the right (→ page 322). The zero layer with the digital map is displayed.

## Navigation overview

### Digital map



#### ① Navigation module (reduced view)

Route guidance active:

The navigation module shows the information relevant to the route in the zoomed-out view, e.g. the destination or a traffic delay

Ends the current route guidance

Tapping opens the navigation module in the expanded view with the **Route**

- ② Destination entry
  - ③ Searches for a parking space
  - ④ Map orientation  and set map type
  - ⑤ Current vehicle position (vehicle symbol or arrow)
  - ⑥ Display area with entertainment sources, phone, active applications and suggestions
  - ⑦ Navigation window shows the next driving maneuver (zoomed out view) or the route monitor (zoomed in view)
- Route guidance active: route monitor shows, e.g. route sections, upcoming driving maneuvers with lane recommendations, destination, traffic delays, toll stations, 3D images at freeway exits, online content

Switches off navigation announcements

Switches on navigation announcements

The following map orientations ④ are available:

- 2D and to the north
- 2D and direction of travel

- 3D and direction of travel
- Map with complete route
- ① If the map is moved, the map switches between 3D direction of travel and 2D north orientation.

The following map types ④ are available:

- Daytime display
- Night-time display
- Satellite map
- ① If you notice a problem with the digital map you can report this under <https://mapfeedback.here.com/#/report>.

### Navigation module (expanded view)

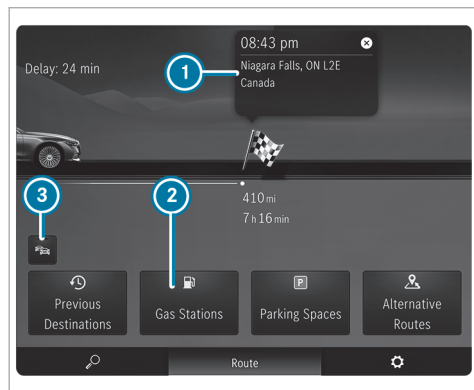

Example: route guidance is active

- ① Destination
- ② Searches for a gas station
- ③ Switches traffic information display on or off

### Overview of the toll system

❗ The toll system is optional equipment and is not available in all vehicles.

Debiting of toll charges at freeway toll gates is facilitated with an electronic payment system.

The toll system uses RFID (Radio Frequency Identification) for data transfer between the control unit and the toll station.

The toll system is initially switched off at the factory.

The control unit is in the vehicle glove box.

In order to be able to use the toll system, it must have been registered by the customer and activated by the service provider:

- Activate the toll system in the settings of the MBUX multimedia system or on the control unit.
- There are two ways to register and activate:
  - In the Mercedes me App, register the unit identification number of the control unit and activate the toll system.

- Alternatively, you can register and activate via the **Toll Service** app.

Activation of the toll system can take up to 48 hours after registration.

When the toll system is activated, the automatic detection of the number of vehicle occupants is initially switched off at the factory. The number of vehicle occupants is preset with one person.

The following applies for roads on which toll charges are dependent on the number of vehicle occupants:

- If the automatic detection of the number of vehicle occupants is switched off, the number of vehicle occupants must be selected manually. This ensures correct toll accounting.
- The number of vehicle occupants can be transmitted automatically. In the process, the number of seat belts worn is determined.

If the number of detected persons does not correspond with the number of persons actually in the vehicle, the number of persons must be manually selected.



The standard setting of one person does not need to be changed for roads which require toll payment regardless of the number of vehicle occupants.

The toll system enables the payment of toll charges in many states of the USA.

**i** In Mexico, for example, the toll system can be registered and activated for journeys to the USA.

#### Notes on use

- You can only use the toll system once registration and activation are complete.
- Drive at the prescribed vehicle speed in the toll lane.
- Mercedes-Benz recommends operation using the MBUX multimedia system. Alternatively, this can also be done on the control unit in the glove box.
- For safety reasons, entries should be made while the vehicle is stationary.
- For further information, please consult the Mercedes me App or an authorized Mercedes-Benz Center.

Or call 1-800-FOR-MERCEDES (in the USA) or 1-800-387-0100 (in Canada).

For information on how to register and activate the toll system, see the Digital Operator's Manual.

### Destination entry

#### Requirements:

- **For the online search:**
  - There is an Internet connection.
  - Mercedes me connect is available.
  - You have set up a user account in the Mercedes me Portal.
  - The vehicle is connected with the user account and you have accepted the terms of use.
  - Further information can be found at: <https://www.mercedes.me>
  - The service is available.
  - The service has been activated at an authorized Mercedes-Benz Center.

Multimedia system:



Example: entering a POI or address

- 1 Input line with current entry
- 2 Search result
- 3 Selects destination input, displays further destination inputs with double arrow
- 4 Deletes an entry

- ⑤ Adopts the search result in the input line and continues the search
- ⑥ Deletes the last character entered
- ⑦ Hides the keypad
- ⑧ Switches to handwriting recognition
- ⑨ Starts the MBUX voice assistant
- ⑩ Sets the written language
- ⑪ Switches to digits and special characters
- ⑫ Switches to upper-case or lower-case letters

▶ Enter the destination in ①. The entries can be made in any order. The search results are displayed in a list.

- ① Online search results for POIs may contain additional information, for example opening times and prices. The information is provided by an online map service. This online function is not available in all countries.
  - ② You can enter a destination as a three-word address from what3words. This option is not available in all countries.
- ▶ Hide the keyboard with **[OK]**.

- ▶ Select the destination in the list. The route is calculated.
- ① Observe the notes on the MBUX multimedia system (→ page 316).

### Calculating a route and using settings for route guidance



Detailed display with a route (example)

- ① Calls up alternative routes
- ② Adds an intermediate destination to the route and recalculates the route
- ③ Sets intermediate destination as new destination and calculates new route

- ④ Selects a point of interest in the vicinity of the destination
- ⑤ Address of the intermediate destination

After selection of a destination the route is calculated.

- ▶ Select one of the options.

#### Calling up alternative routes

- ▶ Select **Routes**.
- ▶ Select an alternative route.



#### Starting route guidance (there is no route yet)

- ▶ Select  **Let's Go!**.

#### Calling up the detailed display with destination address

- ▶ Pull the bar between ② and ③ upwards. Depending on the destination selection and availability, online content, for example ratings and weather information, is shown.

If the destination is in a different time zone, a message is displayed.

- ▶ **To share a destination:** select  **Share**. This option allows you to scan the displayed QR code.
- ▶ **To save a destination as a favorite:** select  **Favorite** and then an option.
- ▶ **To call up an Internet address:** if a web address is available, select **www**.
- ▶ **To call the destination:** if a telephone number is available, select **Call**.

#### Searching for POIs in the vicinity of the destination shown

- ▶ Select **In The Vicinity**.
- ▶ Search using categories, enter a search entry or search for a personal POI .

#### Selecting a route type

- ▶ In the navigation module (expanded view), select  (→ page 341).
- ▶ Select **Route**. The route is calculated as a fast route with a short journey time. Trailer mode is available if a trailer has been coupled with the vehicle. If available, you can select online routes. Traffic

announcements for the route are taken into account via **Reroute Based on Traffic** .

- ① Trailer mode and online routes are not available in all countries and for all vehicles.

#### Calculating alternative routes

- ▶ In the navigation module (expanded view), select .
- ▶ Select **View**.
- ▶ Activate **Route Overview after Start**. Alternative routes are calculated for every route.

#### Selecting alternative routes

- ① If **Route Overview after Start** has been switched on and a route has been calculated, the function is available.
- ▶ In the navigation module (expanded view), select **Alternative Routes**.
- ▶ When the alternative routes have been calculated, display the route in the navigation window by swiping to the right or left.
- ▶ Select **Start**.

### Activating a commuter route

① A user profile has been created and **Allow Destination Suggestions** has been activated in the user options (→ page 326). Route guidance is not active.

▶ In the navigation module (expanded view), select .

▶ Select **Route**.

▶ Activate **Activate Commuter Route**.

The navigation system automatically detects that the vehicle is on a commuter route.

For the daily commuter route, traffic events on the route are also reported when driving without active route guidance.

▶ **To select or delete a commuter route:** select **Start** or .

### Avoiding or using route sections, e.g. highways or ferries

▶ In the navigation module (expanded view), select .

▶ Select **Route**.

▶ Select **Avoid Options**.

▶ Activate or deactivate the avoid option.

### Activating route guidance with augmented reality

▶ In the navigation module (expanded view), select .

▶ Select **View**.

▶ Select **Augmented Reality Video**.

▶ Activate or deactivate **Augmented Reality Video**.

The camera's video image is shown on the central display before a turning maneuver. The video image includes additional information.

### Showing property information for route guidance with augmented reality

Road guidance with augmented reality is activated.

▶ In the navigation module (expanded view), select .

▶ Select **View**.

▶ Select **Augmented Reality Video**.

▶ Activate **Street Names** and **House Numbers**. During route guidance, the activated options are shown as additional information in the camera image.

### Using map functions

Multimedia system:



#### Increasing map scale

▶ When the map is shown, tap twice quickly with one finger on the central display.

or

▶ Move two fingers apart on the central display.

#### Decreasing map scale

▶ Tap with two fingers on the central display.

or

▶ Move two fingers together on the central display.

#### Moving the map

▶ When the map is displayed, swipe in any direction with one finger on the central display.

- ▶ **To reset the map to the current vehicle position:** select  **Center** .

### Selecting map orientation

- ▶ Tap repeatedly on the  compass symbol on the map.

The map orientations changes in this order:

- The 2D map view is displayed so that north is always at the top.
- The 2D map view is aligned to the direction of travel.
- The 3D map view is aligned to the direction of travel.
- The map shows the complete route.

### Using services

#### Requirements:

- There is an Internet connection.
- Mercedes me connect is available.
- You have set up a user account in the Mercedes me Portal.

- The vehicle is connected to a user account and you have accepted the conditions of use for the service.  
Further information can be found at: <https://www.mercedes.me>
- The service is available.
- The service has been activated at an authorized Mercedes-Benz Center.

Multimedia system:



### Showing traffic information

- ▶ In the navigation module (expanded view), select  (→ page 341).
- ▶ Select **View**.
- ▶ Activate **Traffic**.
- ▶ Activate **Traffic Incidents** and **Free Flowing Traffic**.  
Traffic incidents, for example roadworks, local area reports (e.g. fog) and warning messages, are shown on the route.

The traffic delay is displayed for the current route. The smallest value for the display for traffic delays is a minute.

### Displaying hazard warnings

If hazard warnings are available these can be shown as symbols on the map. The display depends on the settings for the **Traffic Incidents** option.

- ▶ In the navigation module (expanded view), select  (→ page 341).
- ▶ Switch **Traffic Incidents** on or off.  
If the option is activated, all of the symbols are shown.  
If the option is deactivated, the symbols are only shown when there is a hazard warning.  
The following hazards may be shown on the map:
  - Accidents and breakdowns
  - Slippery roads, fog, crosswinds and heavy rain
  - Hazards reported manually
  - Vehicle with active hazard warning light

- Roadworks
- Additional hazards (if available)

### Displaying online map contents

- ▶ In the navigation module (expanded view), select .
- ▶ Select **View**.
- ▶ Switch on an online service, e.g. **Weather**. Current weather information is displayed on the navigation map, e.g. temperature or cloud cover.  
The service information is not shown in all map scales, e.g. weather symbols.

### Parking service

**!** **NOTE** Damage to the vehicle due to not observing the maximum permitted headroom clearance

If the vehicle height is greater than the maximum permitted headroom clearance, the roof and other parts of the vehicle may be damaged.



- ▶ Observe the signposted headroom clearance.
- ▶ If the vehicle height is greater than the permitted headroom clearance, do not enter.
- ▶ Observe the changed vehicle height with add-on roof equipment.

**!** **NOTE** Vehicle damage due to failure to observe local information and parking conditions

The data is based on the information provided by the respective service providers.

Mercedes-Benz does not guarantee the accuracy of the information provided in relation to the car park or parking area.

- ▶ Always observe the local information and conditions.

-  This service is not available in all countries.
- ▶ In the navigation module (expanded view), select  and switch on **Parking**.

- ▶ Tap on **P** on the map.  
or

- ▶ In the route overview, select **P** **Parking Spaces**.
- ▶ Select the search position and search filter, e.g. **Near Destination** and **Parking Garages**. The map shows car parks suited to the selected settings.
- ▶ Select a parking option.  
The map shows the parking options in the vicinity.

The following information is shown (if available):

- Destination address, distance from current vehicle position and arrival time
- Information on the parking garage/car park

For example, opening times, parking charges, current occupancy, maximum parking time, **maximum access height**.

The maximum access height shown by the parking service does not replace the need

for observation of the actual circumstances.

- Available payment options (Mercedes pay, coins, bank notes, cards)
- Details on parking tariffs
- Number of available parking spaces
- Payment method (e.g. at parking meters)
- Services/facilities at the parking option
- Telephone number

▶ Calculate the route (→ page 344).

### Notes on the dashcam

**!** **NOTE** Risk of legal consequences due to violation of legal regulations and data protection provisions

You are legally responsible for operation and use of the dashcam functions.

The legal requirements relating to operation and use of the dashcam can vary depending

on the country in which the dashcam is operated.

This function is not permitted in all countries.

- ▶ Before using the dashcam, read up on the content of the legal regulations, in particular the data protection requirements in the respective country of use.
- ▶ Observe the legal regulations, in particular the data protection requirements.

- ① Observe the following instructions for safe operation:
  - Only use FAT32 or exFAT formatted USB storage devices.
  - Use USB-IF certified USB storage devices. USB-IF is a non-profit corporation and stands for USB Implementers Forum. Based on the USB specification, USB-IF certifies, for example, USB versions, corresponding cables and plugs as well as energy supply processes via the USB interface.

- USB storage devices may be damaged if often or permanently overwritten at high speed. Mercedes-Benz recommends a high-quality external SSD drive.

The abbreviation SSD stands for Solid State Drive.

- ① The file size and therefore the duration of single recording is limited by the limitations of the USB flash drive format. So FAT32 formatted USB flash drives do not allow files larger than 4 GB, for example. When the file size is reached, the recording stops and you receive a notification.
- ① The following functions are available in the Gallery app:
  - Switching write protection on or off
  - Deleting video files

### Selecting a USB device for a video recording with the dashcam

#### Requirements:

- At least one USB device is connected with the multimedia system .

Multimedia system:

→  ▶▶ Apps ▶▶ Dashcam

- ▶ Select the USB symbol.
- ▶ Select the USB device.
- ⓘ When USB devices contain multiple partitions, recorded video files are not always displayed in the recording list. Mercedes-Benz recommends that you use USB devices with one partition.

### Starting or stopping loop recording with the dashcam

#### Requirements:

- For recording and saving a video file: a USB device is connected with the multimedia system.
- The vehicle is switched on.

Multimedia system:

→  ▶▶ Apps ▶▶ Dashcam

- ▶ If several USB devices are connected with the multimedia system, select a USB device (→ page 349). If no USB device is selected, a selection is made automatically when recording starts.
- ▶ **To select the recording mode:** select **Loop Recording**. **Loop Recording** records several short video files. When the memory is full, recording is continued automatically. In doing so, other files will be overwritten starting with the oldest file.
- ▶ **To start:** select **Start Recording**. The length of the recording is shown. The **Do not remove the storage medium during recording. Before removing the storage medium, eject it first.** message appears. The video file is stored on the USB device.
- ▶ **To end:** select **End Recording**.
- ⓘ In some countries, geo-coordinates (longitude and latitude) are shown in the video image.

For technical reasons, the geo-coordinates may show greater inaccuracies.

A report may appear in the following cases:

- The camera is not functional, the **Camera Unavailable** message appears. Have the camera checked in an authorized Mercedes-Benz Center.
- If the country border indication has been switched on.
- If an outdoor recording is started with the camera app during a dashcam recording, the dashcam recording pauses and resumes automatically after the camera recording is finished. A notification to this effect is displayed.



## Telephone

### Telephony

#### Notes on telephony

- ⚠ WARNING** Risk of distraction from operating integrated communication equipment while the vehicle is in motion

If you operate communication equipment integrated in the vehicle when driving, you could be distracted from the traffic situation. This could also cause you to lose control of the vehicle.

- ▶ Only operate this equipment when the traffic situation permits.
- ▶ If you cannot be sure of this, stop the vehicle whilst paying attention to road and traffic conditions and operate the equipment with the vehicle stationary.

- ⚠ WARNING** Risk of accident from operating mobile communication equipment while the vehicle is in motion

Mobile communication devices distract the driver from the traffic situation. This can also cause the driver to lose control of the vehicle.

- ▶ As a driver, only operate mobile communication devices when the vehicle is stationary.
- ▶ As a vehicle occupant, use mobile communication devices only in the designated area, e.g. in the rear passenger compartment.

You must observe the legal requirements for the country in which you are currently driving when operating the multimedia system and mobile communication equipment in the vehicle.

- ⚠ WARNING** Risk of injury due to objects being stowed incorrectly

If objects in the vehicle interior are stowed incorrectly, they can slide or be thrown around

and hit vehicle occupants. In addition, cup holders, open stowage spaces and mobile phone receptacles cannot always retain all objects within.

There is a risk of injury, particularly in the event of sudden braking or a sudden change in direction.

- ▶ Always stow objects so that they cannot be thrown around in such situations.
- ▶ Always make sure that objects do not protrude from stowage spaces, parcel nets or stowage nets.
- ▶ Close the lockable stowage spaces before starting a journey.
- ▶ Always stow and secure heavy, hard, pointed, sharp-edged, fragile or bulky objects in the trunk/cargo compartment.

Observe the additional information on stowing mobile communications devices correctly:

- Loading the vehicle (→ page 113)

**Bluetooth® connection:**

The menu view and the available functions in the telephone menu are in part dependent on the Bluetooth® profile of the connected mobile phone. If the mobile phone supports all the following Bluetooth® profiles, the full range of features is available:

- PBAP (Phone Book Access Profile)
  - The contacts on the mobile phone are shown automatically on the multimedia system.
- MAP (Message Access Profile)
  - The mobile phone message functions can be used on the multimedia system.
- HFP (hands-free profile)
  - Wireless telephony is available on the multimedia system.
- SAP (SIM Access Profile)
  - The car telephone has access to the SIM card data and dials into the mobile phone network via the exterior antenna.

Irrespective of this, Bluetooth® audio functionality can be used with any mobile radio unit.

For information on the range of functions of the mobile radio unit to be connected, see the manufacturer's operating instructions.

**Network connection:**

The following cases can lead to the call being disconnected while the vehicle is in motion:

- You switch into a transmission/reception station, in which no communication channel is free.
- The SIM card used is not compatible with the network available
- A mobile phone with "Twincard" is logged into the network with the second SIM card at the same time

The multimedia system supports calls in HD Voice® for improved speech quality. A requirement for this is that the mobile phone and the mobile phone network provider of the person you are calling support HD Voice®.

Depending on the quality of the connection, the voice quality may fluctuate.

Further information can be obtained from an authorized Mercedes-Benz Center or at: <https://www.mercedes-benz.com/connect>.

## Telephone menu overview

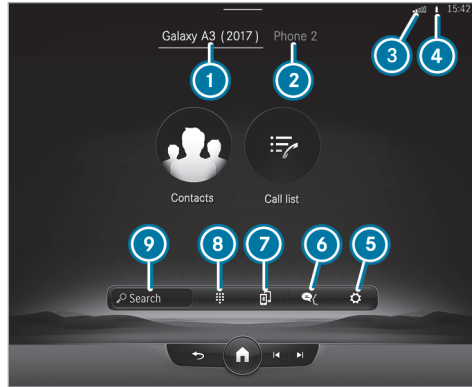

- 1 Bluetooth® device name of the currently connected mobile phone/of the mobile phone
- 2 Bluetooth® device name of the currently connected mobile phone/of the mobile phone (two phone mode)
- 3 Signal strength of the mobile phone network
- 4 Battery status of the connected mobile phone

- 5 Options
- 6 Messages
- 7 Calls up devices
- 8 Numerical pad
- 9 Starts contact search

## Telephony operating modes overview

Depending on your equipment, the following telephony operating modes are available:

- A mobile phone is connected to the multimedia system via Bluetooth®.
- Two mobile phones are connected with the multimedia system via Bluetooth® (two phone mode).
  - You can use all the functions of the multimedia system with both mobile phones.

## Connecting a mobile phone

### Requirements

- Bluetooth® is activated on the mobile phone (see the manufacturer's Operator's Manual).
- Bluetooth® is activated on the multimedia system.

Multimedia system:

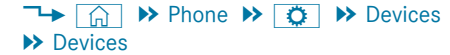

## Searching for a mobile phone

- ▶ Select **Connect New Device**.

## Connecting a mobile phone

- ▶ Select a mobile phone.  
A code is displayed in the multimedia system and on the mobile phone.
- ▶ If both codes match, confirm the code on the mobile phone.

## Functions in the telephony menu

In the telephony menu you have the following functions, for example:

- Making calls, e.g.:
  - Accepting a call
  - **End Call**
  - Answering a call with a message
  - **Conference**
  - Accepting or rejecting a waiting call

- Managing contacts, e.g.:
  - Downloading mobile phone contacts
  - Managing the format of a contact's name
  - Deleting favorites
- Receiving and sending messages, e.g.:
  - Using the read-aloud function
  - Dictating a new message

## Mercedes me Apps

### Mercedes me calls

#### ■ Making a call via the overhead control panel

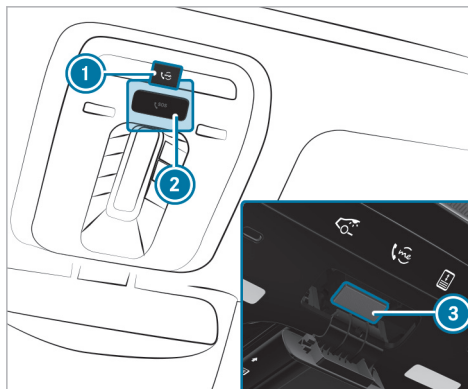

- ① me button for service or information calls
- ② SOS button cover
- ③ SOS button (emergency call system)

#### Making a Mercedes me call

- ▶ Press me button ①.

#### Making an emergency call

- ▶ To open the cover of SOS button ②, press it briefly.
- ▶ Press and hold SOS button ③ for at least one second.

If a Mercedes me call is active, an emergency call can still be triggered. This has priority over all other active calls.

#### ■ Information about the Mercedes me call using the me button

A call to the Mercedes-Benz Customer Center has been initiated via the me button in the overhead control panel or the multimedia system (→ page 354).

Using the voice dialog system you access the desired service:

- Accident and Breakdown Management
- Mercedes-Benz Customer Center for general information about the vehicle

You can find information on the following topics:

- Activation of Mercedes me connect
- Operating the vehicle
- Nearest authorized Mercedes-Benz Center
- Other products and services from Mercedes-Benz

Data is transferred during the connection to the Mercedes-Benz Customer Center (→ page 356).

### ■ Calling the Mercedes-Benz Customer Center using the multimedia system

#### Requirements

- Access to a GSM network is available.
- The contract partner's GSM network coverage is available in the respective region.
- The vehicle must be switched on so that vehicle data can be transferred automatically.

Multimedia system:



#### ▶ Call Mercedes me connect.

After confirmation, the multimedia system sends the required vehicle data. The data transfer is shown in the display.

Then you can select a service and be connected to a specialist at the Mercedes-Benz Customer Center.

### ■ Calling the Mercedes-Benz Customer Center after automatic accident or breakdown detection

#### Requirements:

- The vehicle has detected an accident or breakdown situation (→ page 219).
- The vehicle is stationary.
- The hazard warning lights are switched on.

**i** This function is not available in all countries.

The vehicle can detect accident or breakdown situations under certain circumstances.

Requirements for collision detection in the context of accident recovery:

- The vehicle is equipped with an anti-theft alarm system (ATA) (code 551).
- The vehicle is equipped with the interior protection (code 882).
- The vehicle is equipped with the Anti-Theft Protection Package (code P54).
- The collision detection service with theft notification has been activated on Mercedes me connect.

If a collision is detected when the tow-away protection is armed on a locked vehicle, you will receive a notification in the multimedia system when you switch the vehicle on.

The message informs you about the potentially affected area of the vehicle and the strength of the collision.

In the event an accident or breakdown is detected, the emergency guide shows safety notes in the multimedia system display. This may take a few seconds.

- ⓘ The availability of collision detection depends on the vehicle.

After quitting the emergency guide display on the multimedia system, a prompt appears asking whether you would like to get support from the Mercedes-Benz Customer Center.

▶ Select **Call**.

- After your agreement, or if the Mercedes me connect service "Accident and Breakdown Management" is active, the vehicle data is transferred automatically (→ page 358).
- The Mercedes-Benz Customer Center takes your call and organizes the breakdown and accident assistance.

You may be charged for these services.

- ⓘ Depending on the severity of the accident, an automatic emergency call can be initiated. This has priority over all other active calls (→ page 362).
- ⓘ In addition, if the Mercedes me connect service "Telediagnosics" is active, a similar prompt can appear after a delay in the event

of a breakdown. If you are already in contact with the Mercedes-Benz Customer Center or have already received support, this prompt can be ignored or declined.

- ⓘ If you answer the prompt for support from the Mercedes-Benz Customer Center with **Call Later**, the message will be hidden and appear again later. The prompt triggered by the Mercedes me connect service "Telediagnosics", can either be confirmed or declined. After being declined, this will not be shown again.

### ■ Arranging a service appointment via a Mercedes me call

If you have activated the maintenance management service, relevant vehicle data is transferred automatically to the Mercedes-Benz Customer Center. You will then receive individual recommendations regarding the maintenance of your vehicle.

Regardless of whether you have consented to the maintenance management service, the multimedia system reminds you after a certain amount of

time that a service is due. A prompt appears asking if you would like to make an appointment.

- ▶ **To arrange a service appointment:** select **Call**. After your consent, the vehicle data is transferred and the Mercedes-Benz Customer Center takes your preferred appointment date. The information is then sent to your desired service outlet.

This will contact you to confirm the appointment and if necessary consult about the details.

- ⓘ If you select **Call Later** after the service message appears, the message is hidden and reappears at a later time.

### ■ Data transferred during a Mercedes me call

If you initiate a service call using Mercedes me, data is transferred to enable targeted advice and an efficient service.

The following requirements must be fulfilled for the transfer of the data:

- The vehicle is switched on.
- The required data transfer technology is supported by the mobile phone network provider.

- The quality of the mobile connection is sufficient.

Multi-stage transfer depends on the following factors:

- Reason for the initiation of the call
- The available mobile phone transmission technology
- The activated Mercedes me connect services
- The service selected in the voice control system

**i** The scope of the data transmitted depends on the vehicle model and vehicle equipment. For technical reasons, not all data is available at all times.

#### **Data transfer if Mercedes me connect services are not activated**

If no Mercedes me connect services are activated, the following data is transferred:

- Vehicle identification number
- Time of the call
- Reason for the initiation of the call

- Confirmation of the data protection prompt
- Country indicator of the vehicle
- Set language for the multimedia system
- Telephone number of the communication platform installed in the vehicle

If a call is made for a service appointment via the service reminder, the following data is also transmitted:

- Current mileage and maintenance data

If a call is made after automatic accident or breakdown detection using the multimedia system, the following data is also transmitted:

- Current mileage and maintenance data
- Current vehicle location

If Accident and Breakdown Management is called via the voice control system, the following data can also be called up from the vehicle by the Mercedes-Benz Customer Center:

- Current vehicle location

#### **Data processing**

The data transmitted within the scope of the call is deleted from the processing system after the call is finished, in so far as this data is not being used for other activated Mercedes me connect services.

The incident-specific data is processed and stored in the Mercedes-Benz Customer Center and, if required to process the incident, forwarded to the service partner authorized by the Mercedes-Benz Customer Center. Take note of the data protection information on the Mercedes me Internet page <https://www.mercedes.me> or in the recorded message immediately after calling the Mercedes-Benz Customer Center.

**i** The recorded message is not available in every country.

#### **Mercedes me connect**

##### **Information on Mercedes me connect**

Mercedes me connect consists of multiple services.

You can use the following services via the multimedia system and the overhead control panel, for example:

- Accident and Breakdown Management (me button or situation-dependent display in the multimedia system)
- Mercedes-Benz Emergency Call System (automatic emergency call and SOS button)

The Mercedes me connect Accident and Breakdown Management and the Mercedes-Benz emergency call center are available to you around the clock.

The me button and the SOS button can be found on the vehicle's overhead control panel (→ page 354).

You can also call the Mercedes-Benz Customer Center using the multimedia system (→ page 355).

Please note that Mercedes me connect is a Mercedes-Benz service. In emergencies, first call the national emergency services using the standard national emergency service telephone numbers. In emergencies, you can also use the

Mercedes-Benz emergency call system (→ page 362).

Please note the Mercedes me connect terms of use and the data protection information for Mercedes me connect. You can find these in your Mercedes me user account.

Further information about Mercedes me connect services can be obtained in the Mercedes me Portal: <https://me.secure.mercedes-benz.com>

### ■ Information on Mercedes me connect Accident and Breakdown Management

ⓘ Accident and Breakdown Management is not available in every country. Contact an authorized Mercedes-Benz Center to find out whether this function is available in your country.

The Accident and Breakdown Management can include the following functions:

- Supplement to the Mercedes-Benz emergency call system (→ page 362)

If necessary, the contact person at the Mercedes-Benz emergency call center forwards the call to Mercedes me connect Acci-

dent and Breakdown Management. Forwarding the call is however not possible in all countries.

- Breakdown assistance by a technician on location and/or the towing away of the vehicle to the nearest authorized Mercedes-Benz Center

You may be charged for these services.

- Addition to the emergency guide after automatic accident or breakdown detection (→ page 355)

In the event of a breakdown or accident, further vehicle data is sent which enables optimal support by the Mercedes-Benz Customer Center and the authorized service partner or breakdown assistance.

- Addition to the Mercedes me connect service Telediagnosics

With the Telediagnosics function, specific wear and failure reports are recorded by the service provider, in so far as these can be clearly interpreted and are available through the monitoring of components that are subject to diagnostics.



If your vehicle detects a breakdown or threat of a breakdown, you may be prompted via the multimedia system to contact the Mercedes-Benz Customer Center for further help. This prompt in the multimedia system only appears when the vehicle is stationary.

- ① These services are subject to technical restrictions such as the mobile phone coverage, mobile network quality and the ability of the processing systems to interpret the transferred data. In some circumstances, this can result in delays or the failure of the information to appear in the multimedia system.

Please note that the service and breakdown call is a Mercedes-Benz service. In emergencies, be sure to contact the usual national emergency number first or use the Mercedes-Benz emergency call system (→ page 361).

More information about Mercedes me connect services can be obtained in the Mercedes me Portal: <https://me.secure.mercedes-benz.com>

### ■ Data transferred during Mercedes me connect call services

The data transferred during a Mercedes me connect call depends on:

- The reason for initiation of the call
- The service that is selected in the voice control system
- The activated Mercedes me connect services

You can find out which data is transferred when using the services in the currently valid Mercedes me connect terms of use and the data protection information for Mercedes me connect. You can find these in your Mercedes me user account.

### Overview of the Mercedes me & Apps menu

When you log in with a user account to the Mercedes me Portal, then services and offers from Mercedes-Benz will be available to you.

For more information consult an authorized Mercedes-Benz Center or visit the Mercedes me Portal: <https://me.secure.mercedes-benz.com>

- ① Make sure you always keep the Mercedes me Apps updated.

You can call up the menu using **Apps** in the multimedia system.

In the **Apps** menu, the following options can be available:

- Connecting the vehicle with the **Mercedes me** user account
- Deleting a connection between a user account **Mercedes me** and the vehicle
- Calling up the Mercedes me services
- Calling up apps such as In-Car Office or the web browser depending on availability

## Web browser overview



- ① Previous website
- ② Next website
- ③ Update
- ④ URL
- ⑤ Adds/removes bookmarks
- ⑥ Options
- ⑦ Settings

① Under **[...]** you have the following options:

- **Tabs**
- **Bookmarks & History**
- **Reading Mode**
- **Share Link**
- **Share Content**
- **Request Mobile Website**

① Websites cannot be shown while the vehicle is in motion.

## Overview of Smartphone Integration

With Smartphone Integration, you can use certain functions on your mobile phone via the multimedia system display.

Only one mobile phone at a time can be connected via Smartphone Integration to the multimedia system. Also for use with two phone mode with Smartphone Integration, only one additional mobile phone can be connected using Bluetooth® with the multimedia system.

The full range of functions for Smartphone Integration is only possible with an internet connec-

tion. The appropriate application must be downloaded on the mobile phone to use Smartphone Integration. The mobile phone must be switched on and connected to the multimedia system via the USB port using a suitable cable.

Apps for Smartphone Integration:

- Apple CarPlay® (wireless connection via Bluetooth® also possible)
- Android Auto (wireless connection via Bluetooth® also possible)

① For safety reasons, the first activation of Apple CarPlay® or Android Auto on the multimedia system must be carried out when the vehicle is stationary with the parking brake.

You can start Smartphone Integration using the **Devices** menu.

You can end Smartphone Integration via the **Devices** or by disconnecting the connecting cable between the mobile phone and multimedia system.

- ⓘ Mercedes-Benz recommends disconnecting the connection via the device manager or the connecting cable only when the vehicle is stationary.

#### Overview of transferred vehicle data

When using Smartphone Integration, certain vehicle data is transferred to the mobile phone. This enables you to get the best out of selected mobile phone services. Vehicle data is not directly accessible.

The following system information is transmitted:

- Software release of the multimedia system
- System ID (anonymized)

The transfer of this data is used to optimize communication between the vehicle and the mobile phone.

To do this, and to assign several vehicles to the mobile phone, a vehicle identifier is randomly generated.

This has no connection to the vehicle identification number (VIN) and is deleted when the multimedia system is reset (→ page 332).

The following driving status data is transmitted:

- Transmission position engaged
- Distinction between parked, standstill, rolling and driving
- Day/night mode of the driver's display
- Drive type

The transfer of this data is used to alter how content is displayed to correspond to the driving situation.

The following position data is transmitted:

- Coordinates
- speed
- Compass direction
- Acceleration direction

The mobile phone uses this data to improve the accuracy of navigation, for example, when driving through a tunnel.

### Mercedes-Benz emergency call system

#### Information on the Mercedes-Benz emergency call system

Your vehicle is equipped with the Mercedes-Benz emergency call system ("eCall"). This feature can help save lives in the event of an accident. eCall in no way replaces assistance provided from dialing 911.

Mercedes-Benz eCall only functions in areas where mobile phone coverage is available from the wireless service providers. Insufficient network coverage from the wireless service providers may result in an emergency call not being transmitted.

eCall is a standard feature in your Mercedes-Benz vehicle. In order to function as intended, the system relies on the transmission of data detailed in the Transmitted Data section that follows.

To disable eCall, a customer must visit an authorized Mercedes-Benz Service department to deactivate the vehicle's communication module.

Deactivation of this module prevents the activation of any and all Mercedes me connect serv-

ices. After the deactivation of eCall, automatic emergency call and manual emergency call will not be available.

The vehicle must be switched on before an automatic emergency call can be made.

- ① eCall is activated at the factory.
- ① eCall can be deactivated by an authorized Mercedes-Benz dealer. Please note that in the event ownership of the vehicle is transferred to another owner in its deactivated state, eCall will remain deactivated unless the new owner visits an authorized Mercedes-Benz dealership to reactivate the system.

### Overview of the Mercedes-Benz emergency call system

eCall can help to reduce the time between an accident and the arrival of emergency services at the site of the accident. It helps locate an accident site in places that are difficult to access. However, even if a vehicle is equipped with eCall, this does not mean the system is ON. As such, eCall does not replace dialing 911 in the event of an accident.

An emergency call can be made automatically or manually.

Only make emergency calls if you or others are in need of rescue. Do not make an emergency call in the event of a breakdown or a similar situation.

#### Messages on the display

SOS NOT READY: the vehicle is not on or eCall not available.

During an active emergency call, <schar> appears in the display.

You can find more information on the regional availability of eCall at: <https://www.mercedes-benz-mobile.com/extra/ecall/>

- ① If there is a malfunction of the emergency call system, the loudspeakers, microphone, air bag or the SOS button, for example, are faulty.

You can recognize a malfunction in the emergency call system by the following displays:

- A corresponding message will also appear in the driver's display.
- The SOS button lights up red continuously.

### Triggering an automatic Mercedes-Benz emergency call

#### Requirements:

- The vehicle is switched on.
- The starter battery is sufficiently charged.

The Mercedes-Benz emergency call system triggers an emergency call automatically in the following cases:

- After activation of the restraint systems such as air bags or Emergency Tensioning Devices after an accident
- After an automatically initiated emergency stop by Active Emergency Stop Assist

The emergency call has been made:

- A voice connection is made to the Mercedes-Benz emergency call center.
- A message with accident data is transmitted to the Mercedes-Benz emergency call center.

The Mercedes-Benz emergency call center can transmit the vehicle position data to one of the emergency call centers.

The SOS button in the overhead control panel flashes until the emergency call is finished.

It is not possible to immediately end an automatic emergency call.

If no connection can be made to the emergency services either, a corresponding message appears in the media display.

- ▶ Dial the local emergency number on your mobile phone.

If an emergency call has been initiated:

- Remain in the vehicle if the road and traffic conditions permit you to do so until a voice connection is established with the emergency call center operator.
- Based on the call, the operator decides whether it is necessary to call rescue teams and/or the police to the accident site.
- If no vehicle occupant answers, an ambulance is sent to the vehicle immediately.

### Triggering a manual Mercedes-Benz emergency call

- ▶ **To use the SOS button in the overhead control panel:** press the SOS button at least one second long (→ page 354).

or

- ▶ **To use voice control:** use the voice commands of the MBUX Voice Assistant.

The emergency call has been made:

- A voice connection is made to the Mercedes-Benz emergency call center.
- A message with accident data is transmitted to the Mercedes-Benz emergency call center. The Mercedes-Benz emergency call center can transmit the vehicle position data to one of the emergency call centers.
- Remain in the vehicle if the road and traffic conditions permit you to do so until a voice connection is established with the emergency call center operator.
- Based on the call, the operator decides whether it is necessary to call rescue teams and/or the police to the accident site.

If no connection can be made to the emergency services, a corresponding message appears in the central display.

- ▶ Dial the local emergency number on your mobile phone.

### Ending an unintentionally triggered manual Mercedes-Benz emergency call

- ▶ Select <schar> on the multifunction steering wheel. Depress button for several seconds.

### Data transfer of the Mercedes-Benz emergency call system

In the event of an automatic or manual emergency call the following data is transmitted, for example:

- Vehicle's GPS position data
- GPS position data on the route (a few hundred meters () before the incident)
- Direction of travel
- Vehicle identification number
- Vehicle drive type
- Number of people detected in the vehicle

## 364 MBUX multimedia system

---

- Whether Mercedes me connect is available or not
- Whether the emergency call was initiated manually or automatically
- Time of the accident
- Language setting on the multimedia system

Data transmitted is vehicle information. For any questions about the collection, use and sharing of the eCall system data, please contact MBUSA's Customer Assistance Center at 800-FOR-MERC.

For Canada, please contact MBC's Customer Assistance Center at 1-800-387-0100.









Customer requests for covered information should be submitted via the same channels.





For accident clarification purposes, the following measures can be taken up to an hour after the emergency call has been initiated:

- The current vehicle position can be determined.
- A voice connection to the vehicle occupants can be established.

## Radio &amp; media

## Overview of the symbols and functions in the media menu

Symbol	Designation	Function
	Play	Select to start or continue playback.
	Rest	Select to pause the playback.
	Repeat a track	Select to repeat the current track or the active playlist. <ul style="list-style-type: none"> <li>• Select once: the active playlist is repeated.</li> <li>• Select twice: the current track is repeated.</li> <li>• Select three times: the function is deactivated.</li> </ul>
	Random playback	Select to play back the tracks in random order.
	Skip forwards/back	Select to skip to the next or to the previous track.
	Additional options	Select to show additional options.
	Categories	Select to show and search through available categories such as playback lists, albums or artists.
	Search	Select to search in the active menu. You can search for artists, genres or moods, for example.







Symbol	Designation	Function
	Settings	Select to make settings.
	Home	Select to return to the home screen.
	Messaging	Select to call up messaging.
	Full screen	Select to switch to full screen mode.

The following functions and settings are available in the **Media** menu:

- Connecting external data storage media with the multimedia system (e.g. using USB or Bluetooth®)
- Playing back audio or video files



### Overview of the symbols and functions in the radio menu

Symbol	Designation	Function
	Home	Select to return to the home screen.
	Messaging	Select to call up messaging.
	Skip forwards/back	Select to skip to the next or to the previous station.
	Settings	Select to have further options shown. The setting options are country-dependent.
HD	HD radio™	Select to switch the HD Radio™ function on or off. This function is not available in all countries.
	Station list	Select to have the station list shown.
	Search	Select to search in the active menu. You can search for artists, genres or moods, for example.

#### Additional functions of the satellite radio



SIRIUS XM® satellite radio offers more than 175 digital-quality radio channels providing commercial-free music, sports, news and entertainment,

for example. SIRIUS XM® satellite radio employs a fleet of high-performance satellites to broadcast around the clock throughout the USA and Canada. The satellite radio program is available for a

monthly fee. Information about this can be obtained from a Sirius XM® Service Center and at <https://www.siriusxm.com> (USA).

 Sirius, XM and all related marks and logos are trademarks of Sirius XM Radio Inc. and its

subsidiaries. All other marks, channel names and logos are the property of their respective owners. All rights reserved.

Symbol	Designation	Function
	Settings	The following additional settings are available in the satellite radio menu: <ul style="list-style-type: none"> <li>• Activate child safety lock to lock channels with adult content</li> <li>• Set alarm program for music and sport alerts</li> <li>• Create TuneMix lists to listen to music seamlessly</li> </ul>
	Play	Select to start or continue playback.
	Rest	Select to pause the playback.

Depending on the frequency band selected, different functions are available to you.

Select the desired frequency band in the radio menu head runner.

### Setting up satellite radio

#### Requirements:

- Satellite radio equipment is available.
- Registration with a satellite radio provider has been completed.

- If registration is not included when purchasing the system, your credit card details will be required to activate your account.

Multimedia system:



- ▶ Select **Service Information**.  
The service information screen appears showing the radio ID and the current subscription status.
  - ▶ Establish a telephone connection.
  - ▶ Follow the service staff's instructions.  
The activation process may take up to ten minutes.
- i** You can also have the satellite service activated online. To do so, please visit <https://www.siriusxm.com> (USA) or <https://www.siriusxm.ca> (Canada).

## Music and sport alerts

Multimedia system:



### Setting music and sport alerts

This function enables you to program an alert for your favorite artists, tracks or sporting events. Music alerts can be saved whilst a track is being played and sport alerts can be saved during a live game. You can also specify sport alerts via the menu option. The system then continuously searches through all the channels.

- ▶ Set a music or sports alert, to be informed of matches in the live program.

### Activating messages for a category

- ▶ Select a category and activate .

### Adding messages for a category

- ▶ Select a category and add a message .
- ▶ Select **Artist Alerts** or **Song Alerts** in the dialog window.  
The message is set for the activated  track and artist. If a match is found, a prompt

appears asking whether you wish to change to the station.

### Deleting messages in a category

- ▶ Select a category, mark the desired messages and delete .
- or
- ▶ Do not mark any messages and delete all entries .

## Sound settings

### Overview of functions in the sound menu

The setting options and functions available depend on the sound system installed. You can find out which sound system is installed in your vehicle in the Digital Operator's Manual.

### Standard sound system

The following functions are available:

- Equalizer
  - Treble, mid-range and bass
- Balance and fader
- Volume

### 370 MBUX multimedia system

---

- Automatic adjustment

## ASSYST PLUS service interval display

### Function of the ASSYST PLUS service interval display

The ASSYST PLUS service interval display on the driver's display provides information on the remaining time or distance before the next service due date.

You can hide this service display using the  back button on the steering wheel.

Depending on how the vehicle is used, the ASSYST PLUS service interval display may shorten the service interval, e.g. in the following cases:

- Mainly short-distance driving
- When the engine is often left idling for long periods
- In the event of frequent cold start phases

Mercedes-Benz recommends avoiding such operating conditions.

You can obtain information concerning the servicing of your vehicle from a qualified specialist workshop, e.g. an authorized Mercedes-Benz Center.

### Displaying the service due date

Driver's display:



The next service due date is displayed.

▶ **To exit the display:** press the  back button on the steering wheel.

Bear in mind the following related topic:

- Operating the driver's display (→ page 301).

### Information on regular maintenance work

**!** **NOTE** Premature wear through failure to observe service due dates

Maintenance work which is not carried out at the right time or incompletely can lead to increased wear and damage to the vehicle.

- ▶ Adhere to the prescribed service intervals.
- ▶ Always have the prescribed maintenance work carried out at a qualified specialist workshop.

### Notes on special service requirements

The prescribed service interval is based on normal operation of the vehicle. Have the maintenance work carried out more often than prescribed if operating conditions are difficult or the vehicle is subject to increased stress.

The ASSYST PLUS service interval display is only an aid. It is the responsibility of the driver of the vehicle to have maintenance work carried out more often than prescribed due to actual operating conditions and/or stresses.

Examples of arduous operating conditions:

- Regular city driving with frequent intermediate stops
- Mainly short-distance driving
- Frequent operation in mountainous terrain or on poor road surfaces
- When the engine is often left idling for long periods
- Operation in particularly dusty conditions and/or if air-recirculation mode is frequently used

In these or similar operating conditions, have the interior air filter, air filter, engine oil and oil filter, for example, changed more frequently. If subject to increased stress, check the tires more. Further information can be obtained at a qualified specialist workshop.

### Battery disconnection periods

The ASSYST PLUS service interval display can calculate the service due date only when the battery is connected.

- ▶ Display and note down the service due date on the driver's display before disconnecting the battery (→ page 371).

### Maintenance Management

#### Notes about Maintenance Management

If the Maintenance Management service is activated, relevant data is automatically transferred to the Mercedes-Benz customer center.

The customer center transmits the data to the service partner that you have entered on the

Mercedes me website at: <http://www.mercedes.me>. You will then receive individual recommendations regarding the maintenance of your vehicle.

- ① The calculation of the optimal transmission time of the maintenance request to the service partner is subject to technical limitations that may cause the maintenance recommendation to be perceived as too early or too late or not to be made at all. In this case, you can conveniently arrange a maintenance appointment with the customer center via the maintenance reminder in the multimedia system.
- ① Maintenance Management and the maintenance reminder in the multimedia system are not available in every country. Contact an authorized Mercedes-Benz Center to find out whether this function is available in your country.

### Data transferred when using Maintenance Management

When the service is activated, relevant data is automatically transferred to determine the required scope of maintenance as well as malfunction detection and malfunction rectification.

Details on data transfer can be found in the data protection information for the Mercedes me connect services. These can be found at: <https://www.mercedes.me> under "My Mercedes me account", "Terms of use".

- ① Maintenance Management and the maintenance reminder in the multimedia system are not available in every country.

### Telediagnosis

#### Notes about Telediagnosis

- ① This service is not available in all countries. The vehicle can detect if certain wear parts need to be replaced or if malfunctions have occurred in vehicle systems. If the Telediagnosis service is activated, relevant data is automatically transmitted to the manufacturer. If fault conditions are

detected by the vehicle system self-diagnosis, the system transmits recommendations for action to the Mercedes-Benz customer center depending on the fault detected. The customer center transmits the data to the service partner that you have entered on the Mercedes me website at: <http://www.mercedes.me>.

For selected faults, the notification that a malfunction has been detected may appear in the multimedia system with a request to contact the Mercedes-Benz customer center. From this message, a call can be made directly to the customer center for assistance.

- ❶ The transmission of a notification to the multimedia system depends on the country, vehicle model and equipment and requires a fast data connection, over which the service provider has no influence.
- ❷ Reliable fault detection is subject to technical limitations. Therefore, only a limited selection of faults can be detected and recommendations for action transmitted to the customer center and the service partners. Mercedes-Benz AG is continuously working on the expansion of this service. The fault detection

depends on the country, vehicle model and equipment.

#### Data transferred when using Telediagnosics

When the service is activated, relevant data is automatically transferred to determine the required scope of maintenance as well as malfunction detection and malfunction rectification.

Details on data transfer can be found in the data protection information for the Mercedes me connect services. These can be found at: <https://www.mercedes.me> under "My Mercedes me account", "Terms of use".

- ❶ The scope of the transmitted data depends on the vehicle model and its equipment. For technical reasons, not all data is available at all times.

## Engine compartment

### Opening and closing the hood

**⚠ DANGER** Risk of fatal injuries when carrying out maintenance work during the charging process

During the charging process, the high-voltage on-board electrical system is under high voltage.

- ▶ Do not perform any maintenance work during the charging process.

**⚠ WARNING** Risk of accident due to driving with the hood unlocked

The hood may open and block your view.

- ▶ Never release the hood when driving.
- ▶ Before every trip, ensure that the hood is locked.

**▲ WARNING** Risk of accident and injury when opening and closing the hood

The hood may suddenly drop into the end position.

There is a risk of injury for anyone in the hood's range of movement.

- ▶ Do not open or close the hood if there is a person in the hood's range of movement.

**▲ WARNING** Risk of burns when opening the hood

If you open the hood in the event of an overheated engine or fire in the engine compartment, the following situations may occur:

- You may come into contact with hot gases.
  - You may come into contact with other escaping hot operating fluids.
- ▶ Before opening the hood, allow the engine to cool down.

- ▶ In the event of a fire in the engine compartment, keep the hood closed and call the fire service.

**▲ WARNING** Risk of injury due to moving parts

Components in the engine compartment may continue to run or start unexpectedly even when the drive system is switched off.

Observe the following if you must open the hood:

- ▶ Switch off the vehicle.
- ▶ Never touch the danger zones surrounding moving components, e.g. the rotation area of the fan.
- ▶ Remove jewellery and watches.
- ▶ Keep items of clothing and hair away from moving parts.

**▲ WARNING** Risk of injury from touching live components

The ignition system and the fuel injection system operate with a high voltage. You could receive an electric shock.

- ▶ Never touch components of the ignition system or fuel injection system when the vehicle is switched on.

The live components include the following, for example:

- Ignition coils
- Fuel injectors
- Electric lines to the ignition coils and the fuel injectors

**▲ WARNING** Risk of burns from hot component parts in the engine compartment

Certain component parts in the engine compartment can be very hot, e.g. the engine, the cooler and parts of the exhaust system.



- ▶ Allow the engine to cool down and only touch component parts described in the following.

**⚠ WARNING** Risk of injury from using the windshield wipers when the hood is open

If the windshield wipers start moving when the hood is open, you could be trapped by the wiper linkage.

- ▶ Always switch off the windshield wipers and the vehicle first if you need to open the hood.

### Opening the hood

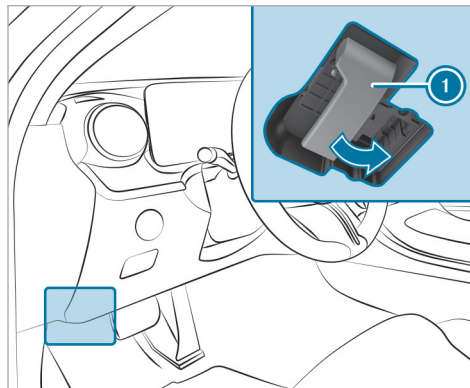

- ▶ To release the hood, pull on handle ①.

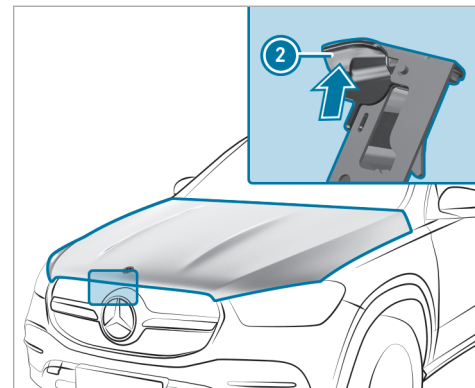

- ▶ Push handle ② of the hood catch upwards and lift the hood until it opens automatically.

### Closing the hood

**!** **NOTE** Damage to the hood due to pressing the hood closed with your hand

If the hood is closed manually, there is a risk of dents.

▶ Do not close the hood manually.

- ▶ Lower the hood to a height of around 12 in (30 cm) and then allow it to fall, applying a little force as you let it go.
- ▶ If the hood can still be lifted slightly, open the hood again and close it with a little more force until it engages correctly.

## Engine oil

### ■ Checking the engine oil level using the driver's display

#### Requirements

- The engine has been warmed up.
- The vehicle is parked on a level surface.
- The engine is running at idle speed.
- The hood is closed.

Determining the engine oil level can take up to 30 minutes with a normal driving style and even longer with an active driving style.

Driver's display:



The engine oil level is shown.

One of the following messages will appear on the driver's display:

- **Engine Oil Level Measuring Now...**: the engine oil level cannot be determined yet.
- ▶ Repeat the request after a maximum of 30 minutes' driving.
- **Engine Oil Level OK** and the bar display for indicating the engine oil level on the driver's display is green and is between "min" and "max": the engine oil level is correct.
- **Engine Oil Level Refill 1,0 liq.gal.** and the bar display for indicating the engine oil level on the driver's display is yellow and is below "min":
- ▶ Add 1.1 US qt (1 l) of engine oil.
- **Engine Oil Level Reduce** and the bar display for indicating the engine oil level on the driver's display is yellow and is above "max":

- ▶ Drain off any excess engine oil that has been added. To do so, consult a qualified specialist workshop.

- **For Engine Oil Level Switch on Vehicle**

- ▶ Switch on the vehicle to check the engine oil level.

- **Engine Oil Level System Inoperative**: The oil level sensor is defective or not connected.

- ▶ Consult a qualified specialist workshop.

- **Engine Oil Level System Currently Unavailable**

- ▶ Close the hood.

### ■ Topping up engine oil

**▲ WARNING** Risk of burns from hot component parts in the engine compartment

Certain component parts in the engine compartment can be very hot, e.g. the engine, the cooler and parts of the exhaust system.

- ▶ Allow the engine to cool down and only touch component parts described in the following.

**! WARNING** Risk of fire and injury from engine oil

If engine oil comes into contact with hot component parts in the engine compartment, it may ignite.

- ▶ Make sure that no engine oil is spilled next to the filler opening.
- ▶ Allow the engine to cool off and thoroughly clean the engine oil from component parts before starting the vehicle.

**! NOTE** Engine damage caused by an incorrect oil filter, incorrect oil or additives

- ▶ Do not use engine oils or oil filters which do not correspond to the specifications explicitly prescribed for the service intervals.
- ▶ Follow the instructions on the service interval display for changing the engine

oil and observe the prescribed change intervals.

- ▶ Do not use additives.

**! NOTE** Damage caused by adding too much engine oil

Excessive engine oil can damage the engine or the catalytic converter.

- ▶ Have excess engine oil removed in a qualified specialist workshop.

- ① Depending on driving style, the vehicle consumes up to 0.9 US qt (0.8 liters) of oil per 600 miles (1,000 km). The oil consumption may also be higher than this when the vehicle is new or if you frequently drive at high engine speeds.

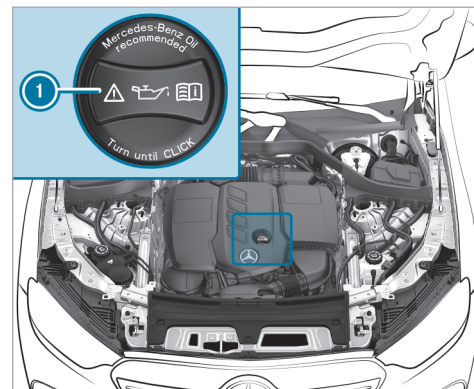

- ▶ Turn cap ① counter-clockwise and remove it.
- ▶ Add engine oil.
- ▶ Replace cap ① and turn it clockwise until it engages.
- ▶ Check the oil level again (→ page 376).

### Checking the coolant level

**⚠ WARNING** Risk of burns from hot component parts in the engine compartment

Certain component parts in the engine compartment can be very hot, e.g. the engine, the cooler and parts of the exhaust system.

- ▶ Allow the engine to cool down and only touch component parts described in the following.

**⚠ WARNING** Risk of scalding from hot coolant

If you open the cap, you could scald yourself.

- ▶ Allow the engine to cool down before opening the cap.
- ▶ When opening the cap, wear protective gloves and safety glasses.
- ▶ Open the cap slowly to release pressure.

- ▶ Have the coolant checked or refilled only at a qualified specialist workshop.

### Refilling the windshield washer system

**⚠ WARNING** Risk of injury due to moving parts

Components in the engine compartment may continue to run or start unexpectedly even when the drive system is switched off.

Observe the following if you must open the hood:

- ▶ Switch off the vehicle.
- ▶ Never touch the danger zones surrounding moving components, e.g. the rotation area of the fan.
- ▶ Remove jewellery and watches.
- ▶ Keep items of clothing and hair away from moving parts.

**⚠ WARNING** Risk of burns from hot component parts in the engine compartment

Certain component parts in the engine compartment can be very hot, e.g. the engine, the cooler and parts of the exhaust system.

- ▶ Allow the engine to cool down and only touch component parts described in the following.

**⚠ WARNING** - Risk of fire and injury from windshield washer concentrate

Windshield washer concentrate is highly flammable. It could ignite if it comes into contact with hot engine component parts or the exhaust system.

- ▶ Make sure that no windshield washer concentrate spills out next to the filler opening.

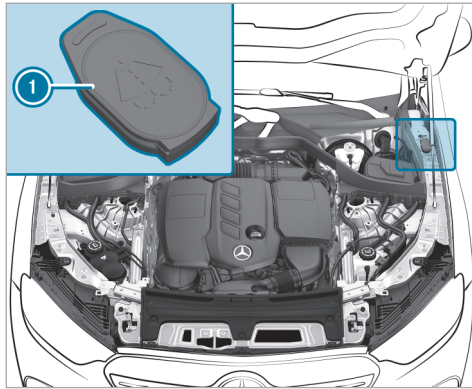

- ▶ Open cap ① by the tab.
- ▶ Add washer fluid.
- ① Further information about the windshield washer fluid (→ page 452).

### Keeping the air/water duct free

- ▶ Keep the area between the hood and the windshield free of deposits, e.g. ice, snow or leaves.

### Cleaning and care

#### Information on washing the vehicle in a car wash

**⚠ WARNING** Risk of accident due to reduced braking effect after washing the vehicle

The braking effect is reduced after washing the vehicle.

- ▶ After the vehicle has been washed, brake carefully while paying attention to the traffic conditions until the braking effect has been fully restored.

#### **!** NOTE Damage from automatic braking

If one of the following functions is activated, the vehicle will brake automatically in certain situations:

- Active Brake Assist
- Active Distance Assist DISTRONIC
- HOLD function
- Active Parking Assist

To avoid damage to the vehicle, switch off these systems, e.g. when towing or using a car wash.

#### **!** NOTE Damage due to unsuitable car wash

- ▶ Before driving into a car wash make sure that the car wash is suitable for the vehicle dimensions.
- ▶ Ensure there is sufficient ground clearance between the underbody and the guide rails of the car wash.

► Ensure that the clearance width of the car wash, in particular the width of the guide rails, is sufficient.

To avoid damage to your vehicle when using a car wash, ensure the following beforehand:

- Active Distance Assist DISTRONIC is deactivated.
- the HOLD function is switched off.
- the 360° Camera or the reversing camera is switched off.
- the side windows and sliding sunroof are completely closed.
- the outside mirrors are folded in.
- the blower for the ventilation and heating is switched off.
- the windshield wiper switch is in position **0**.
- the key is at a minimum distance of 10 ft (3 m) away from the vehicle. Otherwise the tailgate could open unintentionally.  
This also applies to the Digital Vehicle Key.
- for car washes with a conveyor system:

- Neutral **N** is engaged.
- If you would like to leave the vehicle while it is being washed, make sure the key is located in the vehicle. The park position **P** is otherwise automatically engaged.

**i** If, after the car wash, you remove the wax from the windshield and wiper rubbers, this will prevent smearing and reduce wiper noise.

#### Automatic car wash mode

In car wash mode, the vehicle is prepared for driving into the automatic car wash. Car wash mode can be activated up to a speed of 12 mph (20 km/h) (→ page 381).

When car wash mode is activated, the **Automatic Car Wash Mode Active** message will appear on the driver's display. The following adjustments will be made:

- The outside mirrors are folded in.
- To prevent the windshield washer system from starting up automatically, the rain sensor is deactivated.

- 
- The rear window wiper is deactivated.
- Parking Assist PARKTRONIC is deactivated.
- Active Brake Assist will be deactivated if necessary.
- **Vehicles with 360° Camera:** the front image is activated after approx. eight seconds.
- **Vehicles with HANDS-FREE ACCESS:** kick detection will be deactivated.

If one of the settings cannot be selected, this is displayed by a **X** behind the respective setting.

Pressing **Switch Off** will cancel car wash mode. Above a speed of 12 mph (20 km/h), car wash mode will be automatically deactivated.

You can also switch off car wash mode via the MBUX multimedia system (→ page 381).

The following settings will be reset when car wash mode is deactivated:

- The outside mirrors are folded out.
- The rain sensor is activated.
-

- The rear window wiper is activated.
- Parking Assist PARKTRONIC is reset to the previously selected setting.
- Active Brake Assist is activated if necessary.
- **Vehicles with 360° Camera:** the front image is deactivated at speeds above 11 mph (18 km/h).
- **Vehicles with HANDS-FREE ACCESS:** kick detection will be activated.

### Activating/deactivating car wash mode

#### Requirements

- The vehicle is stationary.
- The vehicle is switched on.

Multimedia system:

→  » Settings » Vehicle » Driving

#### Activating automatic car wash mode

- ▶ Select **Automatic Car Wash Mode**.
- ▶ Select **Activate**.

If one of the settings cannot be selected, this is shown by a  next to the respective setting.

- ⓘ For an overview of the settings made when activating automatic car wash mode (→ page 379).

#### Deactivating automatic car wash mode

- ▶ Select **Switch Off**.  
The automatic car wash settings are reset.
- ⓘ Car wash mode is automatically deactivated as soon as a speed of 12 mph (20 km/h) is exceeded.

### Information on using a power washer

 **WARNING** Risk of an accident when using power washers with round-spray nozzles

The water jet can cause externally invisible damage.

Components damaged in this way may unexpectedly fail.

- ▶ Do not use a power washer with round-spray nozzles.

- ▶ Have damaged tires or chassis parts replaced immediately.

To avoid damage to your vehicle when using a power washer, ensure the following:

- the key is at a minimum distance of 10 ft (3 m) away from the vehicle. Otherwise the tailgate could open unintentionally.  
This also applies to the Digital Vehicle Key.
- Keep a minimum distance of 11.8 in (30 cm) from the vehicle.
- **Vehicles with decorative foil:** parts of your vehicle are covered with decorative foil. Maintain a minimum distance of 27.6 in (70 cm) between the foiled parts of the vehicle and the power washer nozzle. Move the power washer nozzle around when cleaning your vehicle. The water temperature of the power washer must not exceed 140°F (60°C).
- Observe the information on the correct distance in the operating instructions of the equipment manufacturer.
- Do not direct the nozzle of the power washer directly at sensitive parts, e.g. tires, gaps,

electrical component parts, batteries, illuminants or louvers.

### Washing the vehicle by hand

**!** NOTE Engine damage due to water ingress

▶ Take care not to point the water jet directly towards the air inlet grille below the hood.

Observe the relevant legal requirements (e.g. in some countries, washing by hand is permitted only in specially designated wash bays).

- ▶ Use a mild cleaning agent (e.g. car shampoo).
  - ▶ Do not use an acidic cleaning agent.
  - ▶ Wash the vehicle with lukewarm water using a soft car sponge. When doing so, do not expose the vehicle to direct sunlight.
  - ▶ Carefully hose the vehicle off with water and dry using a chamois.
- i** Observe the notes on the care of car parts (→ page 383).

### Notes on paintwork/matte finish paintwork care

To avoid damaging the paintwork and interfering with the driving assistance systems, please observe the following notes:

#### Paint

- Insect remains: soak with insect remover and rinse off the treated areas afterwards.
- Bird droppings: soak with water and rinse off afterwards.
- Tree resin, oils, fuels and greases: remove by rubbing gently with a cloth soaked in petroleum ether or lighter fluid.
- Coolant and brake fluid: remove with a damp cloth and clean water.
- Tar stains: use tar remover.
- Wax: use silicone remover.
- Do not attach stickers, films or similar materials. Only have film attached to the bumper at a qualified specialist workshop.
- Remove dirt immediately, where possible. Do not use acidic solutions and acidic cleaning agents.

#### Matte finish

- Only use care products approved for Mercedes-Benz.
- Do not attach stickers, films or similar materials. Only have film attached to the bumper at a qualified specialist workshop.
- Do not polish the vehicle or the light-alloy wheels.
- Only use car washes that correspond to the latest engineering standards.
- Do not use a car wash program with a final hot wax treatment.
- Do not use paint cleaners, buffing or polishing products, gloss preservers, e.g. wax.

In the event of paintwork damage:

- Always have paintwork repairs carried out at a qualified specialist workshop.
- Make sure the radar sensors function (→ page 222).



### Notes on cleaning decorative films

Observe the "Notes on paintwork/matte finish paintwork care" (→ page 382). They also apply to matte decorative films.

Observe the notes on cleaning decorative films to avoid damage.

#### Cleaning

- For cleaning, use plenty of water and a mild cleaning agent without additives or abrasive substances (e.g. a car shampoo approved for Mercedes-Benz).
- Do not use an acidic cleaning agent.
- Remove dirt as soon as possible. Avoid rubbing too hard in order not to damage the decorative film irreparably.
- If there is dirt on the finish or if the decorative film is dull: use the paint cleaner recommended and approved for Mercedes-Benz.
- Insect remains: soak with insect remover and rinse off the treated areas afterwards.
- Bird droppings: soak with water and rinse off afterwards.

- To prevent water stains, dry a film-wrapped vehicle with a soft, absorbent cloth after every car wash.

#### Avoiding damage to the decorative film

- The service life and color of decorative films are impaired by:
  - Sunlight
  - Temperature (e.g. hot air blower)
  - Weather conditions
  - Stone chippings and dirt
  - Chemical cleaning agents
  - Oily products
- Do not use polish on matte decorative film. Polishing will have the effect of shining the film-wrapped surface.
- Do not treat matte or structured decorative films with wax. Permanent stains may occur.

Scratches, corrosive deposits, areas affected by corrosion and damage caused by incorrect care cannot always be completely repaired. In this case, contact a qualified specialist workshop.

You can obtain more information on care and cleaning agents from the manufacturer.

In the case of film-wrapped surfaces, visual differences may occur between the surfaces that were not protected by a decorative film after a decorative film has been removed.

- ① Have work or repairs to decorative films carried out at a qualified specialist workshop (e.g. at an authorized Mercedes-Benz Center).

### Notes on cleaning and care of vehicle parts

**⚠ WARNING** Risk of entrapment if the windshield wipers are switched on while the windshield is being cleaned

If the windshield wipers are set in motion while you are cleaning the windshield or wiper blades, you can be trapped by the wiper arm.

- ▶ Always switch off the windshield wipers and the vehicle before cleaning the windshield or wiper blades.

**!** **NOTE** Damage caused by acidic cleaning agents

▶ Do not use acidic cleaning agents. Otherwise, the surfaces could be damaged.

To avoid damage to the vehicle, observe the notes on cleaning and care of the following car parts:

#### Wheels and rims

- Use water and acid-free alloy wheel cleaners.
- Do not use acidic alloy wheel cleaners to remove brake dust. This could damage wheel bolts and brake components.
- To avoid corrosion of the brake discs and pads, drive the vehicle for a few minutes after cleaning before parking it. The brake discs and pads will warm up and dry out.

#### Windows

**!** **NOTE** Damage to electronic components due to excess fluids

When cleaning the windows from the inside, fluids such as cleaning agents or water may

run down and get behind trim parts of the vehicle interior and cause damage to electronic components.

- ▶ Use cleaning agents as sparingly as possible.
- ▶ Immediately absorb any excess fluids.

- Clean the windows inside and outside with a damp cloth and with a cleaning agent recommended for Mercedes-Benz.
- Do not use dry cloths or abrasive or solvent-based cleaning agents to clean the insides of windows.
- i** After changing the wiper blades or treating the vehicle with wax, clean the windshield thoroughly with cleaning agents recommended for Mercedes-Benz. Failure to observe the application instructions may result in damage, smear marks or glare spots.
- i** Remove external fogging or dirt on the windshield in front of the multifunction camera. Otherwise, driving systems and driving safety systems may be impaired or not available (→ page 222).

#### Wiper blades

- Move the wiper arms into the replacement position (→ page 144).
- With the wiper arms folded out, clean the wiper blades with a damp cloth.
- i** Make sure that the wiper blades are coated. The coating may leave residue on a cloth. Do not rub the wiper blades excessively or clean them too often.

#### Exterior lighting

- Clean the lenses with a wet sponge and mild cleaning agent (e.g. car shampoo).
- Use only cleaning agents or cleaning cloths that are suitable for plastic lenses.

#### Vehicle socket (high-voltage battery)

- Use clean water and a soft cloth to clean the vehicle socket.
- Do not use power washers or cleaning agents, such as soap.

### Sensors

- Clean the sensors in the front and rear part of the vehicles with car shampoo, plenty of water and a soft cloth (→ page 222).
- When using a power washer, maintain a minimum distance of 11.8 in (30 cm).

### Running boards

- Use water and acid-free cleaning agents.
- Do not clean the aluminum trim inserts of the running board with alkaline or acidic cleaning agents such as wheel cleaners. Do not use acidic wheel cleaners to remove brake dust. The aluminum trim inserts could otherwise be damaged.

### Cameras

- Open the camera cover with the multimedia system (→ page 276).
  - Use clean water and a soft cloth to clean the camera lenses.
  - Do not use a power washer.
- i** Remove external fogging or dirt on the windshield in front of the multifunction camera. Otherwise, driving systems and driving safety

systems may be impaired or not available (→ page 222).

### Trailer hitch

- Observe the notes on care in the trailer hitch manufacturer's operating instructions.
  - Do not clean the ball neck with a power washer or solvent.
  - Remove traces of rust on the ball (e.g. using a wire brush).
  - Remove dirt with a lint-free cloth.
  - After cleaning, lightly oil or grease the ball head.
- i** Before using trailers with anti-torsional coupling, observe the manufacturer's operating instructions.

### Notes on care of the interior

**⚠ WARNING** Risk of injury from plastic parts breaking off after the use of solvent-based care products

Care and cleaning products containing solvents can cause surfaces in the cockpit to become porous. When the airbags are deployed, plastic parts may break away.

- ▶ Do not use any care or cleaning products containing solvents to clean the cockpit.

**⚠ WARNING** Risk of injury or fatal injuries from bleached seat belts

Bleaching or dyeing seat belts can severely weaken them.

This can, for example, cause seat belts to tear or fail in an accident.

- ▶ Never bleach or dye seat belts.

**!** **NOTE** Property damage due to disinfectants

The interior includes a number of sensitive surfaces such as displays, plastics and leather.

Disinfectants can contain alcohol and other substances that penetrate and damage surfaces. Technology behind buttons and displays can also be damaged.

▶ Do not use disinfectant on interior surfaces.

To avoid damage to the vehicle, observe the following notes on cleaning and care:

#### Seat belts

- Clean with lukewarm and soapy water.
- Do not use chemical cleaning agents.
- Do not dry by heating them to over 176°F (80°C) or exposing them to direct sunlight.

#### Display

- Switch off the display and let it cool down.

- Clean the surface carefully with a microfiber cloth and a suitable display care product (TFT-LCD).
- Do not use any other agents.

#### Head-up display

- Clean with a soft, non-static, lint-free cloth.
- Do not use cleaning agents.

#### Plastic trim

- Clean with a damp microfiber cloth.
- For heavy soiling: Use a cleaner recommended for Mercedes-Benz.
- Do not attach stickers, films or similar materials.
- Do not allow cosmetics, insect repellent or sun cream to come in contact with the plastic trim.

#### Real wood and trim elements

- Clean with a microfiber cloth.
- Black piano-lacquer look: clean with a damp cloth and soapy water.
- For heavy soiling: Use a cleaner recommended for Mercedes-Benz.

- Do not use solvent-based cleaning agents, polishes or waxes.

#### Headliner

- Clean with a brush or dry shampoo.

#### Carpet

- Use a carpet and textile cleaning agent recommended for Mercedes-Benz.

#### Steering wheels made of imitation leather

- Use a damp cotton cloth and a 1% soap solution to clean the entire steering wheel. Do not spot clean.
- Use cleaning and care products recommended for Mercedes-Benz.
- Do not use a microfiber cloth.
- Do not use oil-based cleaning and care products.

#### Steering wheel made of genuine leather or DINAMICA

**!** **NOTE** Damage caused by wrong cleaners

▶ Do not use solvent-based cleaning agents such as tar remover or wheel

cleaner; neither should you use polishes or waxes. Otherwise you may damage the finish.

- Clean with a damp cloth and a 1% soapy water solution and then wipe with a dry cloth.
  - For heavy soiling: Use a cleaner recommended for Mercedes-Benz.
  - Leather care: Use a leather care agent that has been recommended for Mercedes-Benz.
  - Do not allow the leather to become too damp.
  - Do not use a microfiber cloth.
- i** Leather is a natural product. It has natural surface properties, such as differences in structure, marks caused by growth and injury or subtle color differences. These surface properties are characteristics of leather and not material defects. Leather is also subject to a natural aging process during which the surface properties change.

#### Genuine leather seat covers

- Vacuum up dirt such as crumbs or dust and then clean the seat covers with a damp cotton

cloth and wipe down with a dry cloth. Regularly clean the seat covers.

- For heavy soiling: use a leather care agent recommended for Mercedes-Benz aftercare.
  - Leather care: Use a leather care agent that has been recommended for Mercedes-Benz.
  - Do not use a microfiber cloth.
  - Do not allow the leather to become too damp.
  - Do not use oil-based cleaning and care products.
- i** Leather is a natural product. It has natural surface properties, such as differences in structure, marks caused by growth and injury or subtle color differences. These surface properties are characteristics of leather and not material defects. Leather is also subject to a natural aging process during which the surface properties change. Waves or wrinkling in the seat cover may occur due to the stress on the seat; this is caused by the natural leather material. Regular cleaning and care of the leather reduces soiling, wear marks and aging damage and thus significantly extends its life

span. Clothing that can leave stains (e.g. jeans) may discolor the leather.

#### DINAMICA seat covers

- Vacuum up dirt such as crumbs or dust and then use a damp cloth to clean.
- Do not use a microfiber cloth.

#### Imitation leather seat covers

- Vacuum up dirt such as crumbs or dust and then use a damp cotton cloth and a 1% soap solution to clean the entire seat cover. Do not spot clean.
- Use cleaning and care products recommended for Mercedes-Benz.
- Do not use a microfiber cloth.
- Do not use oil-based cleaning and care products.

#### Cloth seat covers

- Vacuum up dirt such as crumbs or dust and then use a damp microfiber cloth and a 1% soap solution to clean the entire seat cover. Do not spot clean.

### 388 Maintenance and care

---

- Use cleaning and care products recommended for Mercedes-Benz.
- Do not use oil-based cleaning and care products.

## Emergency

## Removing the safety vest

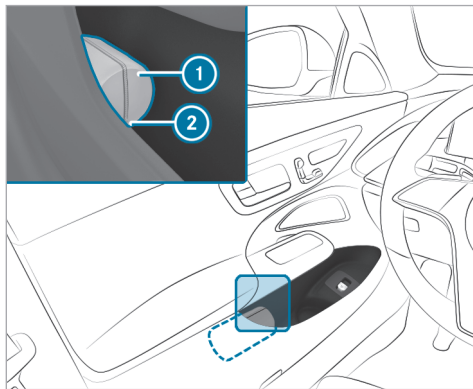

There is a safety vest compartment in the stowage compartments of all doors for storing a safety vest.

- ▶ To remove: pull out safety vest bag ① by loop ②.

- ▶ Open safety vest bag ① and pull out the safety vest.
- ▶ To stow: fold the reflective safety jacket, roll it up and stow it in safety jacket bag ①.
- ▶ Slide safety jacket bag ① along the lower edge of the armrest into the safety jacket compartment. Meanwhile, ensure that loop ② hangs out well within reach.

- ① Remove a new reflective safety jacket from its packaging material before sliding it into the safety jacket compartment. The packaging material may otherwise cause it to slip out or make removing it difficult. Observe the legal requirements in each country.

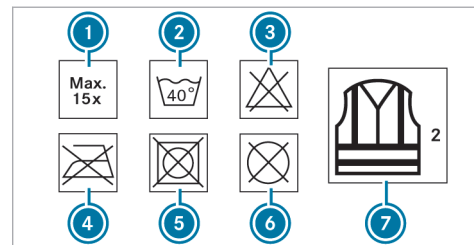

- ① Maximum number of washes
- ② Maximum wash temperature
- ③ Do not bleach
- ④ Do not iron
- ⑤ Do not tumble dry
- ⑥ Do not dry clean
- ⑦ Class 2 safety vest

The requirements defined by the legal standard are only fulfilled if the safety vest is the correct size and is fully closed.

Replace the safety vest in the following cases:

- The reflective strips are damaged or dirty

- The maximum permissible number of washes is exceeded
- The fluorescence has faded, e.g. due to continuous exposure to sunlight.

Dispose of the safety vest in an environmentally responsible manner:

- To do so, contact your local waste disposal company.

### Warning triangle

#### ■ Removing the warning triangle

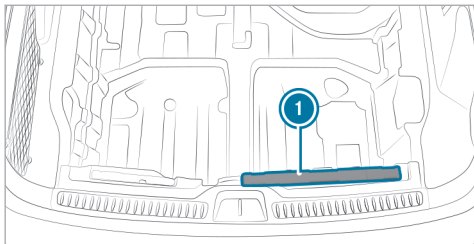

Warning triangle ① is located under the cargo floor in the loading sill when the vehicle is delivered.

- ▶ Remove warning triangle ①.

#### ■ Setting up the warning triangle

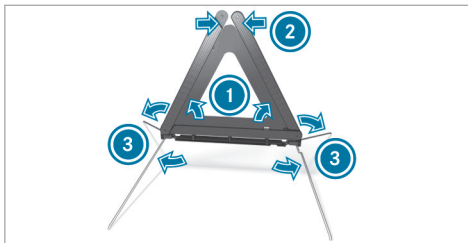

- ▶ Fold side reflectors ① upwards to form a triangle and attach at the top using upper press-stud ②.
- ▶ Fold legs ③ down and out to the side.

### First-aid kit (soft-sided) overview

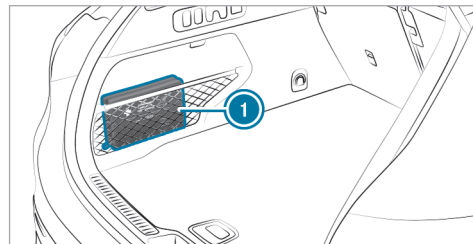

First-aid kit (soft sided) ① is in the cargo compartment in the left-hand stowage net.

### Flat tire

#### Notes on flat tires

**⚠ WARNING** Risk of accident due to a flat tire

A flat tire severely affects the driving characteristics as well as steering and braking.

**Tires without run-flat characteristics:**



- ▶ Do not drive on with a flat tire.
- ▶ Change the flat tire immediately with an emergency spare wheel or spare wheel. Alternatively, consult a qualified specialist workshop.

#### Tires with run-flat characteristics:

- ▶ Observe the information and warning notes on MOExtended tires (run-flat tires).

In the event of a flat tire, you have the following options depending on your vehicle's equipment:

- **Vehicles with a TIREFIT kit:** you can seal the tire so that it is possible to continue your journey for a short period of time. To do this, use the TIREFIT kit (→ page 392).
- **Vehicles with Mercedes me connect:** you can make a call for breakdown assistance via the overhead control panel in the case of a breakdown (→ page 354).
- **All vehicles:** change the wheel (→ page 436).

- ❗ The emergency spare wheel is available only in certain countries (→ page 441). Vehicles equipped with MOExtended tires are not equipped with a TIREFIT kit at the factory. It is therefore recommended that you additionally equip your vehicle with a TIREFIT kit if you mount tires on your vehicle that do not feature run-flat characteristics, e.g. winter tires. A TIREFIT kit may be obtained from a qualified specialist workshop.

**Vehicles with a Mercedes-Benz emergency call system that are not equipped with a TIREFIT kit:** in the event of a flat tire, contact the Customer Assistance Center for the Mercedes-Benz emergency call system .

#### TIREFIT kit storage location

##### Plug-in hybrid

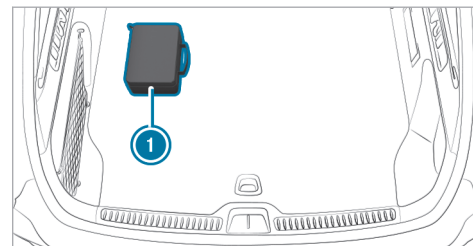

TIREFIT kit ❶ is located on the left-hand side of the cargo compartment when the vehicle is delivered.

##### Not plug-in hybrid

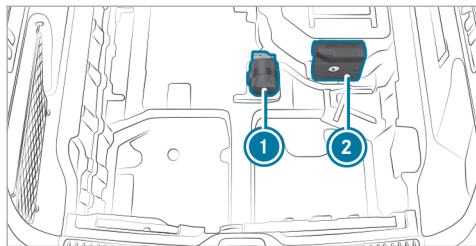

- ① Tire sealant bottle
- ② Tire inflation compressor

The TIREFIT kit is located under the cargo floor when the vehicle is delivered.

Depending on the vehicle version, the TIREFIT kit may be located elsewhere in the cargo compartment.

- ① Depending on the power category (LK), the tire inflation compressor weighs as follows:
  - LK1 – 12 V/10 A, 120 W, 1.8 lbs (0.8 kg)
  - LK2 – 12 V/15 A, 180 W, 2 lbs (0.9 kg)

You can find information on the power category (LK) and/or electrical data on the back of the tire inflation compressor. The tire inflation compressor is maintenance-free. If there is a malfunction, please contact a qualified specialist workshop.

### Using the TIREFIT kit

#### Requirements

- Tire sealant bottle and tire inflation compressor are ready for use (→ page 391).
- TIREFIT sticker is present.
- Gloves are present.

TIREFIT kit storage location: (→ page 391)

You can use TIREFIT tire sealant to seal perforation damage of up to 0.16 in (4 mm), particularly in the tire tread. You can use TIREFIT in outside temperatures down to -4 °F (-20 °C).

#### ⚠ WARNING Risk of accident when using tire sealant

The tire sealant may be unable to seal the tire properly, especially in the following cases:

- There are large cuts or punctures in the tire (larger than damage previously mentioned)
- The wheel rims have been damaged
- After journeys with very low tire pressure or with flat tires

- ▶ Do not continue driving.
- ▶ Consult a qualified specialist workshop.

#### ⚠ WARNING Risk of injury and poisoning from tire sealant

The tire sealant is harmful and causes irritation. Do not allow it to come into contact with the skin, eyes or clothing, and do not swallow it. Do not inhale tire sealant fumes. Keep the tire sealant away from children.

If you come into contact with the tire sealant, observe the following:

- ▶ Rinse off the tire sealant from your skin immediately using water.
- ▶ If tire sealant gets into your eyes, thoroughly rinse out the eyes using clean water.
- ▶ If tire sealant has been swallowed, immediately rinse out the mouth thoroughly and drink plenty of water. Do not induce vomiting and seek medical attention immediately.
- ▶ Change out of any clothes contaminated with tire sealant immediately.
- ▶ If allergic reactions occur, seek medical attention immediately.

**1** **NOTE** Overheating due to the tire inflation compressor running too long

- ▶ Do not run the tire inflation compressor for longer than ten minutes without interruption.

Comply with the manufacturer's safety notes on the sticker on the tire inflation compressor.

Have the tire sealant bottle replaced at a qualified specialist workshop every five years.

- ▶ Do not remove any foreign bodies that have entered the tire.

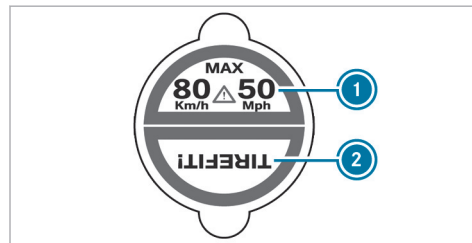

- ▶ Affix part ① of the TIREFIT sticker to the instrument cluster within the driver's field of vision.
- ▶ Affix part ② of the TIREFIT sticker near the valve on the wheel with the defective tire.

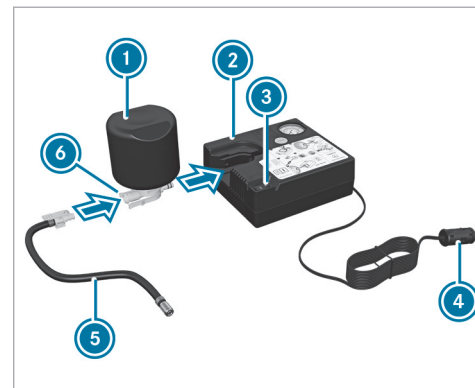

- ▶ Pull plug ④ with the cable and hose ⑤ out of the tire inflation compressor housing.
- ▶ Push the plug of hose ⑤ into flange ⑥ of tire sealant bottle ① until the plug engages.
- ▶ Insert tire sealant bottle ① head downwards into recess ② of the tire inflation compressor.

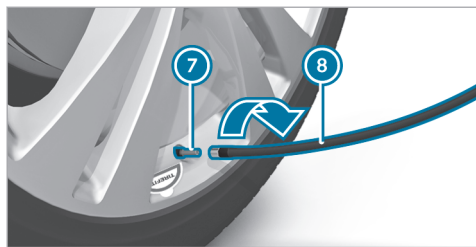

- ▶ Remove the valve cap from valve ⑦ on the defective tire.
- ▶ Screw filling hose ⑧ onto valve ⑦.
- ▶ Insert plug ④ into a 12 V socket in your vehicle.
- ▶ Switch on the vehicle.
- ▶ Press on and off switch ③ on the tire inflation compressor.

The tire inflation compressor will be switched on. The tire will be inflated. First, tire sealant will be pumped into the tire. The pressure may briefly rise to approximately 500 kPa (5 bar / 73 psi).

#### Do not switch off the tire inflation compressor during this phase!

- ▶ Let the tire inflation compressor run for a maximum of ten minutes.  
The tire should then have attained a tire pressure of at least 200 kPa (2.0 bar / 29 psi).

If tire sealant leaks out, make sure you clean the affected area as quickly as possible. It is preferable to use clean water.

If you get tire sealant on your clothing, have it cleaned as soon as possible with perchloroethylene.

#### If, after ten minutes, a tire pressure of 200 kPa (2.0 bar / 29 psi) has not been attained:

- ▶ Switch off the tire inflation compressor.
- ▶ Unscrew the filling hose from the valve of the defective tire.

Please note that tire sealant may leak out when you unscrew the filling hose.

- ▶ Drive forwards or in reverse very slowly for approximately 33 ft (10 m).

- ▶ Pump up the tire again.  
After a maximum of ten minutes, the tire pressure must be at least 200 kPa (2.0 bar / 29 psi).

#### ⚠ WARNING Risk of accident due to the specified tire pressure not being achieved

If the specified tire pressure is not achieved after the specified time, the tire is too badly damaged. The tire sealant cannot repair the tire in this instance.

The braking characteristics as well as the driving characteristics may be greatly impaired.

- ▶ Do not continue driving.
- ▶ Consult a qualified specialist workshop.

#### If, after ten minutes, a tire pressure of 200 kPa (2.0 bar / 29 psi) has been attained:

#### ⚠ WARNING Risk of accident from driving with sealed tires

A tire temporarily sealed with tire sealant impairs the handling characteristics and is not suitable for higher speeds.

- ▶ Adapt your driving style accordingly and drive carefully.
- ▶ Do not exceed the maximum speed limit with a tire that has been repaired using tire sealant.

- ▶ Observe the maximum permissible speed of 50 mph (80 km/h) for a tire sealed with tire sealant.
- ▶ Affix the upper section of the TIREFIT sticker to the instrument cluster in a location where it will be easily seen by the driver.

**!** **NOTE** Staining caused by leaking tire sealant

After use, excess tire sealant may leak out from the filling hose.

- ▶ Therefore, place the filling hose in the plastic bag that contained the TIREFIT kit.

**🔥 ENVIRONMENTAL NOTE** Environmental pollution caused by environmentally irresponsible disposal

Tire sealant contains pollutants.

- ▶ Have the tire sealant bottle disposed of professionally, e.g. at an authorized Mercedes-Benz Center.

- ▶ Switch off the tire inflation compressor.
- ▶ Unscrew the filling hose from the valve of the defective tire.
- ▶ Stow the tire sealant bottle and the tire inflation compressor.
- ▶ Pull away immediately.
- ▶ Stop driving after approximately ten minutes and check the tire pressure using the tire inflation compressor.  
The tire pressure must now be at least 130 kPa (1.3 bar/19 psi).

**⚠️ WARNING** Risk of accident due to the specified tire pressure not being attained

If the specified tire pressure is not reached, the tire is too badly damaged. The tire sealant cannot repair the tire in this instance.

The braking and driving characteristics may be greatly impaired.

- ▶ Do not continue driving.
- ▶ Consult a qualified specialist workshop.

In cases such as the one mentioned above, contact an authorized Mercedes-Benz Center. Or call 1-800-FOR-MERCEDES (in the USA) or 1-800-387-0100 (in Canada).

- ▶ Correct the tire pressure if it is still at least 130 kPa (1.3 bar/19 psi). See the Tire and Loading Information placard on the B-pillar on the driver's side or the tire pressure table in the fuel filler flap for values.
- ▶ **To increase the tire pressure:** switch on the tire inflation compressor.

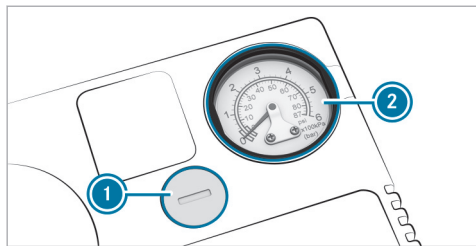

- ▶ **To reduce the tire pressure:** press pressure release button ① next to manometer ②.
- ▶ When the tire pressure is correct, unscrew the filling hose from the valve of the sealed tire.
- ▶ Screw the valve cap onto the valve of the sealed tire.

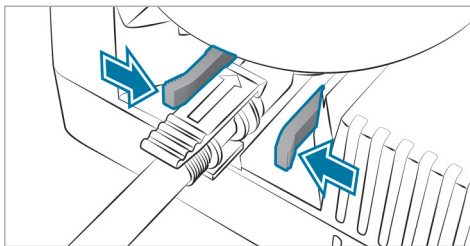

- ▶ Pull the tire sealant bottle out of the tire inflation compressor. Press the locking tabs on the yellow cap together to do this. The filling hose stays on the tire sealant bottle.
- ▶ Drive to the nearest qualified specialist workshop and have the tire, tire sealant bottle and filling hose replaced there.

### Battery (vehicle)

#### Notes on the 12 V battery

**⚠ WARNING** Risk of an accident due to work carried out incorrectly on the battery

Work carried out incorrectly on the battery can, for example, lead to a short circuit. This can restrict functions relevant for safety systems and impair the operating safety of your vehicle.

You could lose control of the vehicle in the following situations in particular:

- When braking
  - In the event of abrupt steering maneuvers and/or when the vehicle's speed is not adapted to the road conditions
- ▶ In the event of a short circuit or a similar incident, contact a qualified specialist workshop immediately.
  - ▶ Do not drive on.
  - ▶ Always have work on the battery carried out at a qualified specialist workshop.

- Further information on ABS (→ page 224)
- Further information on ESP® (→ page 225)

For safety reasons, Mercedes-Benz recommends that you use only batteries that have been approved for your vehicle by Mercedes-Benz.

#### All vehicles except vehicles with lithium-ion batteries

**⚠ WARNING** Risk of explosion due to electrostatic charge

Electrostatic charge can ignite the highly explosive gas mixture in the battery.

- ▶ To discharge any electrostatic charge that may have built up, touch the metal vehicle body before handling the battery.

The highly flammable gas mixture is created while the battery is charging and during jump-starting.

**⚠ WARNING** Danger of chemical burns from the battery acid

Battery acid is caustic.

- ▶ Avoid contact with the skin, eyes or clothing.
- ▶ Do not lean over the battery.
- ▶ Do not inhale battery gases.
- ▶ Keep children away from the battery.
- ▶ Immediately rinse battery acid off thoroughly with plenty of clean water and seek medical attention immediately.

#### All vehicles

**🔥 ENVIRONMENTAL NOTE** Environmental damage due to improper disposal of batteries



Batteries contain pollutants. It is illegal to dispose of them with the household rubbish.



Dispose of batteries in an environmentally responsible manner.

Take discharged batteries to a qualified specialist workshop or to a collection point for used batteries.

If you have to disconnect the 12 V battery, contact a qualified specialist workshop.

Observe the safety notes and protective measures when handling batteries.



Risk of explosion if the 12 V battery is used improperly.



Fire, open flames and smoking are prohibited when you are handling the battery. Avoid creating sparks.



Electrolyte or battery acid is corrosive. Avoid contact with the skin, eyes or clothing. Wear suitable protective clothing, especially gloves, an apron and a safety mask. Immediately rinse electrolyte or acid splashes off with clean water. Consult a doctor immediately.



Do not place heavy objects on the surface of the battery or use the battery to support a person in any way.



Wear eye protection.



Keep children away.



Observe this Operator's Manual.

Observe the following if you are intending not to use the vehicle for an extended period of time:

- **If available:** activate standby mode (→ page 221).
- Alternatively: connect the battery to a battery charger approved by Mercedes-Benz or consult a qualified specialist workshop to disconnect the battery.

### Notes on the 48 V battery

**⚠ WARNING** Risk of an accident due to work carried out incorrectly on the battery

Work carried out incorrectly on the battery can, for example, lead to a short circuit. This

can restrict functions relevant for safety systems and impair the operating safety of your vehicle.

You could lose control of the vehicle in the following situations in particular:

- When braking
  - In the event of abrupt steering maneuvers and/or when the vehicle's speed is not adapted to the road conditions
- ▶ In the event of a short circuit or a similar incident, contact a qualified specialist workshop immediately.
- ▶ Do not drive on.
- ▶ Always have work on the battery carried out at a qualified specialist workshop.

- Further information on ABS (→ page 224)
- Further information on ESP® (→ page 225)



**ENVIRONMENTAL NOTE** Environmental damage due to improper disposal of batteries



Batteries contain pollutants. It is illegal to dispose of them with the household trash.



**Li-ion** Dispose of batteries in an environmentally responsible manner. Take discharged batteries to a qualified specialist workshop or to a collection point for used batteries.

Have any work on the 48 V battery carried out exclusively at a qualified specialist workshop.

Comply with safety notes and take protective measures when handling batteries.



Risk of explosion if the 48 V battery is used improperly.



The surface of the 48 V battery may be hot.





Fire, naked flames and smoking are prohibited when handling the battery. Avoid creating sparks.



Electrolyte or battery acid is corrosive. Avoid contact with the skin, eyes or clothing. Wear suitable protective clothing, in particular gloves, an apron and a face mask. Immediately rinse off splashes of electrolyte or acid with plenty of clean water. Consult a doctor immediately.



Do not place heavy objects on the surface of the battery or use the battery to support a person in any way.



Do not perform any work on the battery. Always have any work on the battery carried out at a qualified specialist workshop. Do not disconnect the battery yourself. Do not remove the battery yourself. Do not attempt to open the battery.



Keep children away.



Wear safety glasses.



Observe this Operator's Manual.

Observe the following if you do not intend to use the vehicle over an extended period of time:

- **If available:** activate standby mode (→ page 221).

#### Notes on the high-voltage battery

**⚠ DANGER** Risk of fire and explosion from excessive internal pressure of the high-voltage battery

In the event of a vehicle fire, flammable gas can escape and ignite.

- ▶ If there is an unusual smell, smoke or burn marks, stop the charging process immediately.
- ▶ Leave the danger zone immediately. Secure the danger area at a sufficient distance.
- ▶ Call the fire service.

Observe the notes on charging the high-voltage battery (→ page 196).



Risk of explosion.



Fire, open flames and smoking are prohibited when you are handling the battery. Avoid creating sparks.



Electrolyte or battery acid is corrosive. Avoid contact with the skin, eyes or clothing. Wear suitable protective clothing, especially gloves, an apron and a safety mask. Immediately rinse electrolyte or acid splashes off with clean water. Consult a doctor immediately.



Wear safety glasses.



Keep children away.



Observe this Operator's Manual.

## Notes on starting assistance and charging the 12 V battery

### All vehicles

When charging the battery and during starting assistance, always use the jump-start connection point in the engine compartment.

**NOTE** Damage to the battery due to over-voltage

When charging using a battery charger without a maximum charging voltage, the battery or the on-board electronics may be damaged.

- ▶ Only use battery chargers with a maximum charging voltage of 14.8 V.

**WARNING** Risk of explosion due to igniting hydrogen gas

If you cause a short circuit or sparks occur, the hydrogen gas may ignite when a battery is charging.

- ▶ Ensure that the positive terminal of a connected battery does not come into contact with vehicle parts.
- ▶ Never place metal objects or tools on a battery.
- ▶ When connecting and disconnecting the battery, always observe the sequence of battery terminals described.
- ▶ When jump starting, take care to connect only battery terminals of identical polarity.
- ▶ When jump starting, always observe the sequence described for connecting and disconnecting the jumper cables.
- ▶ Do not connect or disconnect the battery terminals when the engine is running.

**WARNING** Risk of explosion due to a mixture of explosive gases

A mixture of explosive gases can escape from the battery during charging and jump starting.

- ▶ Fire, open flames, smoking and creating sparks must be avoided.
- ▶ Make sure that there is sufficient ventilation.
- ▶ Do not stand over the battery.

**WARNING** Risk of explosion from a frozen battery

A discharged battery may freeze at temperatures slightly above or below freezing point.

During starting assistance or battery charging, battery gas can be released.

- ▶ Always allow a battery to thaw before charging it or performing starting assistance.

If, at low temperatures, the indicator lamps/warning lamps in the instrument cluster do not light up, it is highly likely that the discharged battery has frozen. In this case, you may neither charge the battery nor jump-start the vehicle.

The service life of a battery that has been thawed may be drastically reduced. The starting charac-

teristics can be impaired, particularly at low temperatures.

We recommend having the thawed-out battery inspected at a qualified specialist workshop.

### Plug-in hybrid

If your vehicle has been started with starting assistance, it may not be possible to use the electric drive for approximately 30 minutes.

Starting assistance is not considered to be a normal operating condition.

### All vehicles

**!** **NOTE** Damage caused by numerous or extended attempts to start the engine

Numerous or extended attempts to start the engine may damage the catalytic converter due to non-combusted fuel.

▶ Avoid numerous and extended attempts to start the engine.

Observe the following points during starting assistance and when charging the battery:

- Use only undamaged jumper cables / charging cables with a sufficient cross-section and insulated terminal clamps.
- Non-insulated parts of the terminal clamps must not come into contact with other metal parts while the jumper cable / charging cable is connected to the battery / jump-start connection point.
- The jumper cables / charging cables must not come into contact with any parts that may move when the engine is running
- Always make sure that neither you nor the battery is electrostatically charged.
- Keep away from fire and open flames.
- Do not lean over a battery.

Also observe the following points when charging the battery:

- Use only chargers tested and approved for Mercedes-Benz.
- Read the operating instructions for the charger before charging the battery.

Also observe the following points during starting assistance:

- Starting assistance may only be provided using vehicles, batteries or other jump start devices with a nominal voltage of 12 V.
- The vehicles must not touch each other.
- **Vehicles with a gasoline engine:** only jump-start your vehicle when the engine and exhaust system are cold.

### Starting assistance and charging the 12 V battery

#### Preparing starting assistance/charging

- ▶ Secure the vehicle by applying the electric parking brake.
- ▶ Shift the transmission to position **P**.
- ▶ Switch off the vehicle and all electrical consumers.
- ▶ Open the hood.

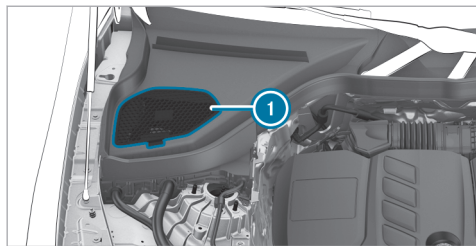

- ▶ Open cover ① of the jump-start connection point.

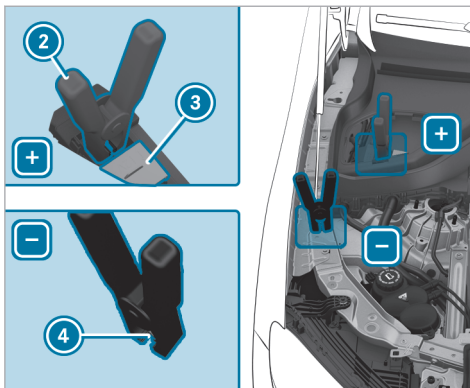

- ▶ Open cover ③ of positive contact ② on the jump-start connection point.

#### Starting assistance

- ▶ Connect positive terminal ② on your vehicle to positive terminal of the donor battery using the jumper cable. Always begin with positive clamp ② on your own vehicle first.

- ▶ Start the engine of the donor vehicle and run it at idling speed.
- ▶ Connect the negative terminal of the donor battery to ground point ④ of your vehicle using the jumper cable. Begin with the donor battery first.
- ▶ Start the engine of your own vehicle.
- ▶ Let the engines run for several minutes.
- ▶ Before disconnecting the jumper cables, switch on an electrical consumer in your own vehicle, e.g. the rear window defroster or the lighting.

When the starting assistance procedure is complete:

- ▶ Remove the jumper cables from ground point ④ first and the negative terminal of the donor battery, then from positive contact ② and the positive terminal of the donor battery. Begin each time with the contacts on your own vehicle first.
- ▶ Close cover ③ of positive terminal ② after removing the jumper cables.

- ▶ Close cover ①.

If your vehicle has been started with starting assistance, it may not be possible to use the electric drive for approximately 30 minutes.

Further information can be obtained at a qualified specialist workshop.

### Charging

- ▶ Connect positive contact ② on the vehicle to the positive terminal of the charger using the charging cable. Always begin with positive contact ② on the vehicle.
- ▶ Connect the negative terminal of the charger and ground point ④ on the vehicle with the charging cable. Start with the charger.
- ▶ Start the charging process.

When the charging process is complete:

- ▶ Remove the charging cable from ground point ④ first and the negative terminal of the charger, then from positive contact ② and the positive terminal of the charger. Begin each time with the contacts on the vehicle.

- ▶ After removing the charging cable, close cover ③ of positive contact ②.

- ▶ Close cover ①.

Further information can be obtained at a qualified specialist workshop.

### Replacing the 12 V battery

- ▶ Observe the notes on the 12 V battery (→ page 396).

Mercedes-Benz recommends that you have the 12 V battery replaced at a qualified specialist workshop, e.g. at an authorized Mercedes-Benz Center.

Observe the following notes if you want to replace the battery yourself:

- Always replace a faulty battery with a battery that meets the specific vehicle requirements. The vehicle is equipped with an AGM (Absorbent Glass Mat) technology battery or a lithium-ion battery. Full vehicle functionality is guaranteed only with an AGM or lithium-ion battery. For safety reasons, Mercedes-Benz recom-

mends that you use only batteries that have been tested and approved for your vehicle by Mercedes-Benz.

- Use detachable parts such as vent hoses, elbow fittings or terminal covers from the battery to be replaced.
- Make sure that the vent hose is always connected to the original opening on the side of the battery. Install any existing or supplied cell caps. Otherwise, gases or battery acid could escape.
- Make sure that detachable parts are reconnected in the same way.

**Tow starting or towing away****Permitted towing methods****! NOTE** Damage from automatic braking

If one of the following functions is activated, the vehicle will brake automatically in certain situations:

- Active Brake Assist
- Active Distance Assist DISTRONIC
- HOLD function
- Active Parking Assist

To avoid damage to the vehicle, switch off these systems, e.g. when towing or using a car wash.

Mercedes-Benz recommends transporting your vehicle in the case of a breakdown, rather than towing it away.

For towing with both axles on the ground, use a tow rope or tow rod. Do not use tow bar systems.

**! NOTE** Damage to the vehicle due to towing away incorrectly

▶ Observe the instructions and notes on towing away.

**Towing with a raised axle:** towing should be performed by a towing company.

**Vehicles with rear wheel drive****Permitted towing methods**

Both axles on the ground	Yes, for a maximum of 31 miles (50 km) at 31 mph (50 km/h)
Front axle raised	No
Rear axle raised	Yes, if the steering wheel is fixed in the center position with a steering wheel lock

**4MATIC vehicles****Permitted towing methods**

Both axles on the ground	Yes, for a maximum of 31 miles (50 km) at 31 mph (50 km/h)
Front axle raised	No
Rear axle raised	No

**Permitted towing methods (plug-in hybrid)**

Mercedes-Benz recommends transporting your vehicle in the case of a breakdown, rather than towing it away.

For towing with both axles on the ground, use a tow rope or tow rod. Do not use tow bar systems.

**!** **NOTE** Damage to the vehicle due to towing away incorrectly

- ▶ Observe the instructions and notes on towing away.

Observe the information on towing and transporting the vehicle in the vehicle Operator's Manual.

In the following situations, only transporting the vehicle is permitted:

- The driver's display is not working
- The  **Towing Not Permitted See Operator's Manual** display message appears on the driver's display.

**Exception:** If the vehicle is located in a danger zone, it can be recovered from the danger zone despite the  **Towing Not Permitted See Operator's Manual** display message or the display not working. It must not be towed further than 55 yd (50 m) with both axles on the ground. A towing speed of 6 mph (10 km/h) must not be exceeded. Beyond these limits, only transporting is permitted.

#### Vehicles with rear wheel drive

##### Permitted towing methods

Both axles on the ground	Yes, for a maximum of 31 miles (50 km) at 31 mph (50 km/h), only forwards with the driver in the vehicle
Front axle raised	No
Rear axle raised	Yes, if the steering wheel is fixed in the center position with a steering wheel lock

#### 4MATIC vehicles

##### Permitted towing methods

Both axles on the ground	Yes, for a maximum of 31 miles (50 km) at 31 mph (50 km/h), only forwards with the driver in the vehicle
Front axle raised	No
Rear axle raised	No

#### Towing the vehicle with both axles on the ground

- ▶ Observe the notes on the permitted towing methods.
- ▶ Make sure that the battery is connected and charged.

Observe the following points when the battery is discharged:

- the vehicle cannot be started.
- the electric parking brake cannot be released or applied

- **Vehicles with automatic transmission:** the transmission cannot be shifted to position **N** or **P**.

**i** **Vehicles with automatic transmission:** if the transmission cannot be shifted to position **N** or if the display does not show anything, transport the vehicle (→ page 407). A towing vehicle with lifting equipment is required for vehicle transportation.

**!** **NOTE** Damage due to towing away at excessively high speeds or over long distances

The drivetrain could be damaged when towing at excessively high speeds or over long distances.

- ▶ A towing speed of 30 mph (50 km/h) must not be exceeded.
- ▶ A towing distance of 30 miles (50 km) must not be exceeded.

**!** **WARNING** Risk of accident when towing a vehicle which is too heavy

If the vehicle to be tow-started or towed away is heavier than the permissible gross mass of your vehicle, the following situations can occur:

- The towing eye may become detached.
- The vehicle/trailer combination may swerve or rollover.

▶ Before tow-starting or towing away, check if the vehicle to be tow-started or towed away exceeds the permissible gross mass.

If a vehicle has to be tow-started or towed away, its permissible gross mass must not exceed the permissible gross mass of the towing vehicle.

- ▶ Information on the permissible gross mass of the vehicle can be found on the vehicle identification plate (→ page 445).
- ▶ **Vehicles with automatic transmission:** do not open the driver's door or front passenger

door; the transmission otherwise automatically shifts to position **P**.

- ▶ Install the towing eye (→ page 408).
- ▶ Fasten the towing device.

**!** **NOTE** Damage due to incorrect connection of the tow bar

▶ Only connect the tow rope or tow bar to the towing eyes.

- ▶ Deactivate the automatic locking mechanism (→ page 80).
- ▶ Do not activate the HOLD function.
- ▶ Deactivate the tow-away alarm (→ page 96).
- ▶ Deactivate Active Brake Assist (→ page 255).
- ▶ **Vehicles with automatic transmission:** shift to position **N**.
- ▶ Release the electric parking brake.



**⚠ WARNING** Risk of accident due to limited safety-related functions during the towing process

Safety-related functions are limited or no longer available in the following situations:

- The vehicle is switched off.
- The brake system or power steering system is malfunctioning.
- The energy supply or the on-board electrical system is malfunctioning.

When your vehicle is towed away, significantly more effort may be required to steer and brake than is normally required.

- ▶ Use a tow bar.
- ▶ Make sure that the steering wheel can move freely before towing the vehicle away.

**! NOTE** Damage due to excessive tractive power

If you pull away sharply, the tractive power may be too high and the vehicles could be damaged.

- ▶ Pull away slowly and smoothly.

### Loading the vehicle for transport

**Plug-in hybrid:** vehicles should be transported only by professional recovery companies.

- ▶ Observe the notes on towing away (→ page 405).
- ▶ Connect the towing device to the towing eye in order to load the vehicle.
- ⓘ You can also attach the tow bar to the trailer hitch.
- ▶ Shift the automatic transmission to position **N**.
- ⓘ The automatic transmission may be locked in position **P** in the event of damage to the

electrics. To shift to **N**, provide the on-board electrical system with power (→ page 401).

- ▶ Load the vehicle onto the transporter.
- ▶ Shift the automatic transmission to position **P**.
- ▶ Use the electric parking brake to secure the vehicle against rolling away.
- ▶ Secure the vehicle only by the wheels.

### 4MATIC vehicles

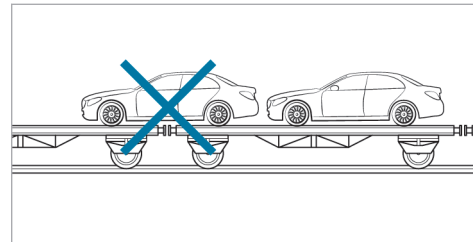

- ▶ Make sure that the front and rear axles come to rest on the same transportation vehicle.

**!** **NOTE** Damage to the drive train due to incorrect positioning of the vehicle

▶ Do not position the vehicle above the connection point of the transport vehicle.

### Towing eye storage location

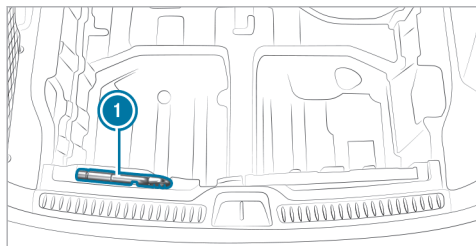

Towing eye ① is located under the cargo floor in the load sill.

### Installing/removing the towing eye

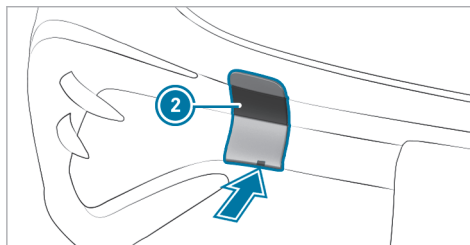

AMG Line

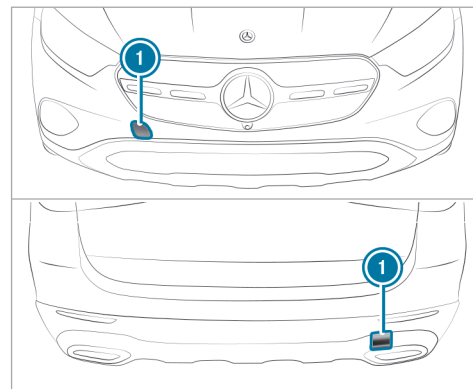

All other vehicles

▶ **AMG Line:** press the mark on cover ① on the rear bumper inward and remove the cover. Use a suitable object, e.g. a screwdriver, to pry off cover ② on the front bumper from underneath. Take the cover from the opening, but do not remove it.

- ▶ **All other vehicles:** press the mark on cover ① inward and remove.
- ▶ Screw in the towing eye clockwise to the stop.

**Vehicles with a trailer hitch:** vehicles with a trailer hitch do not have a fixture at the back for the towing eye. Connect the tow bar to the trailer hitch.

- ▶ After removing the towing eye, engage cover ① in the bumper.

**!** **NOTE** Damage to the vehicle due to incorrect use of the towing eye or trailer hitch

When a towing eye or trailer hitch is used to recover a vehicle, the vehicle may be damaged in the process.

- ▶ Only use the towing eye or trailer hitch to tow away or tow start the vehicle.
- ▶ Do not use the towing eye or trailer hitch to tow the vehicle during recovery.

## Tow-starting the vehicle

### Vehicles with automatic transmission

**!** **NOTE** Damage to the automatic transmission due to tow starting

The automatic transmission may be damaged in the process of tow starting vehicles with automatic transmission.

- ▶ Vehicles with automatic transmission must not be tow started.

- ▶ Vehicles with automatic transmissions must not be tow-started.

## Electrical fuses

### Notes on electrical fuses

**!** **WARNING** Risk of accident and injury due to overloaded lines

If you manipulate or bridge a faulty fuse or if you replace it with a fuse with a higher amperage, the electric line could be overloaded.

This could result in a fire.

- ▶ Always replace faulty fuses with specified new fuses containing the correct amperage.

**!** **NOTE** Damage due to incorrect fuses

Using incorrect fuses can result in damage to electrical components or systems or their functions being considerably restricted.

- ▶ Use only fuses approved for Mercedes-Benz with the respective specified fuse rating.

Blown fuses must be replaced with fuses of the same rating, which you can recognize by the color and the label. The fuse ratings and further information to be observed can be found in the fuse assignment diagram.

**Fuse assignment diagram:** on the fuse box in the cargo compartment (→ page 412).

**NOTE** Damage or malfunctions caused by moisture

Moisture may cause damage to the electrical system or cause it to malfunction.

- ▶ When the fuse box is open, make sure that no moisture can enter the fuse box.
- ▶ When closing the fuse box, make sure that the seal of the lid is positioned correctly on the fuse box.

If the newly inserted fuse also blows, have the cause traced and rectified at a qualified specialist workshop.

Ensure the following before replacing a fuse:

- The vehicle is secured against rolling away.
- All electrical consumers are switched off.
- The vehicle is switched off.

The electrical fuses are located in various fuse boxes:

- Fuse box on the driver's side of the engine compartment (→ page 410)

- Fuse box on the driver's side of the cockpit (→ page 411)
- Fuse box in the front passenger footwell (→ page 411)
- Fuse box in the cargo compartment (→ page 412)

### Opening and closing the fuse box in the engine compartment

#### Requirements

- A dry cloth and a screwdriver are available.

Observe the notes on electrical fuses (→ page 409).

#### Opening

**WARNING** Risk of injury from using the windshield wipers when the hood is open

If the windshield wipers start moving when the hood is open, you could be trapped by the wiper linkage.

- ▶ Always switch off the windshield wipers and the vehicle first if you need to open the hood.

- ▶ Open the hood (→ page 373).

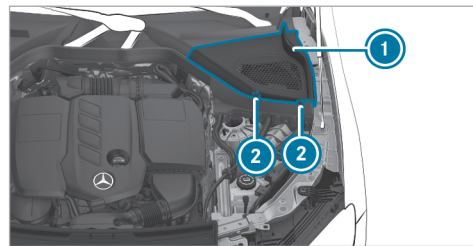

- ▶ Turn both retaining clips (2) on cover (1) on the driver's side a quarter-turn clockwise.
- ▶ Fold cover (1) upwards.

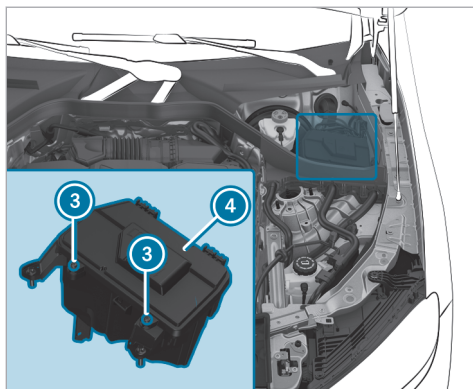

- ▶ Remove any existing moisture from the fuse box using a dry cloth.
- ▶ Loosen screws ③ and remove fuse box lid ④ from the top.

#### Closing

- ▶ Check whether the seal is positioned correctly in lid ④.

- ▶ Insert lid ④ into the bracket at the rear of the fuse box.
- ▶ Fold down lid ④ of the fuse box and tighten screws ③.
- ▶ Fold down cover ①.
- ▶ Turn both retaining clips ② on cover ① a quarter-turn counter-clockwise.
- ▶ Close the hood.

#### Opening and closing the fuse box in the cockpit

##### Requirements

- Observe the notes on electrical fuses (→ page 409).

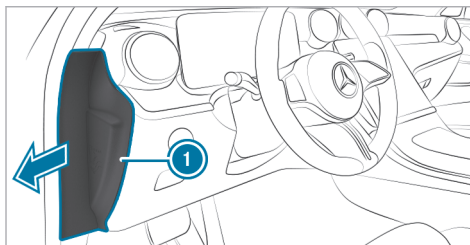

The fuse box is under a cover on the side of the driver's side of the cockpit.

- ▶ Open cover ① in the direction of the arrow and remove it.

Mercedes-Benz recommends you have the fuse box opened at an authorized Mercedes-Benz Center.

#### Opening and closing the fuse box in the front passenger footwell

##### Requirements

- Observe the notes on electrical fuses (→ page 409).

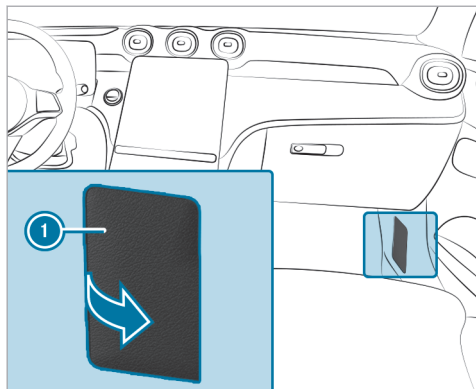

- ▶ **To open:** fold out and remove cover ❶.
- ▶ **To close:** reinsert cover ❶.

### Opening and closing the fuse box in the cargo compartment

#### Requirements

Observe the notes on electrical fuses  
(→ page 409).

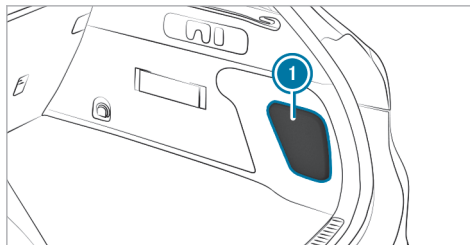

- ▶ Remove cover ❶.

The fuse assignment diagram is located at the side of the fuse box.

### Notes on noise or unusual handling characteristics

Make sure there are no vibrations, noises or unusual handling characteristics when the vehicle is in motion. This may indicate that the wheels or tires are damaged. Hidden tire damage could also be causing the unusual handling characteristics.

If you suspect that a tire is defective, reduce your speed immediately and have the tires and wheels checked at a qualified specialist workshop.

### Notes on regularly inspecting wheels and tires

**⚠ WARNING** Risk of injury through damaged tires

Damaged tires can cause tire pressure loss.

- ▶ Check the tires regularly for signs of damage and replace any damaged tires immediately.

**⚠ WARNING** Risk of hydroplaning due to insufficient tire tread

Insufficient tire tread will result in reduced tire grip.

In heavy rain or slush the risk of hydroplaning is increased, in particular where speed is not adapted to suit the conditions.

- ▶ Thus, you should regularly check the tread depth and the condition of the tread across the entire width of all tires.

Minimum tread depth for:

- Summer tires:  $\frac{1}{8}$  in (3 mm)
- M+S tires:  $\frac{1}{6}$  in (4 mm)

- ▶ For safety reasons, replace the tires before the legally-prescribed limit for the minimum tread depth is reached.

Carry out the following checks on all wheels regularly, at least once a month or as required, for example, prior to a long journey or driving off-road:

- Check the tire pressure (→ page 414).

- Visually inspect wheels and tires for damage.
- Check the valve caps.
- Visually inspect the tire tread depth and the tire contact surface across the entire width.  
The minimum tread depth for summer tires is  $\frac{1}{8}$  in (3 mm) and for winter tires  $\frac{1}{6}$  in (4 mm).

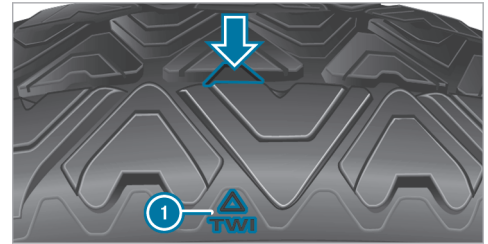

Six marks ① show where the bar indicators (arrow) are integrated into the tire tread. They are visible once a tire tread depth of approximately  $\frac{1}{16}$  in (1.6 mm) has been reached.

### Notes on snow chains

**⚠ WARNING** Risk of accident due to incorrectly installed snow chains

If you have installed snow chains on the front wheels, they may drag against the vehicle body or chassis components.

- ▶ Never install snow chains on the front wheels.
- ▶ Only install snow chains on the rear wheels in pairs.

**ℹ NOTE** Damage to components of the vehicle body or chassis due to mounted snow chains

If you mount snow chains to the front wheels of 4MATIC vehicles, you may damage components of the vehicle body or chassis.

- ▶ Only mount snow chains to the rear wheels of 4MATIC vehicles.

Observe the following notes when using snow chains:

- Snow chains are only permissible for certain wheel/tire combinations. You can obtain information about this from an authorized Mercedes-Benz Service Center.
  - For safety reasons, only use snow chains that have been specifically approved for your vehicle by Mercedes-Benz, or snow chains with the same quality standard.
  - Comply with the installation instructions of the snow chain manufacturer.
  - If snow chains are installed, the maximum permissible speed is 30 mph (50 km/h).
  - **Vehicles with Active Parking Assist:** do not use Active Parking Assist when snow chains are installed.
- i** You can deactivate ESP® to pull away (→ page 226). This allows the wheels to spin, achieving an increased driving force.

### Activating or deactivating snow chain mode

Multimedia system:



▶ Activate or deactivate **Snow Chain Mode**.

When the function is active, the vehicle behaves as if snow chains were installed. For example, the maximum steering movement of the rear wheels is limited and the turning circle is thus increased.

Additionally, parts of the driving and driving safety systems are not available when snow chain mode is active.

### Tire pressure

#### Notes on tire pressure

**⚠ WARNING** Risk of accident due to insufficient or excessive tire pressure

Underinflated or overinflated tires pose in particular the following risks:

- The tires can burst.



- The tires can wear excessively and/or unevenly.
  - The driving characteristics as well as the steering and braking characteristics may be greatly impaired.
- ▶ Comply with the recommended tire pressures and check the tire pressure of all tires, including the spare wheel, regularly:
- Monthly
  - When the load changes
  - Before embarking on a longer journey
  - If operating conditions change, e.g. off-road driving
- ▶ Adjust the tire pressure, if necessary.

Tire pressure which is too high or too low can:

- Shorten the service life of the tires.
- Cause increased tire damage.
- Adversely affect driving characteristics and thus driving safety, e.g. due to hydroplaning.

**▲ WARNING** Risk of accident due to too low a tire pressure

Tires with pressure that is too low can overheat and burst as a consequence.

In addition, they also suffer from irregular wear, which can significantly impair the braking properties and the handling characteristics.

- ▶ Avoid excessively low tire pressure.

Tire pressure which is too low can cause:

- Tire defects as a result of overheating
- Impaired handling characteristics
- Irregular wear
- Increased fuel consumption

**▲ WARNING** Risk of accident due to too high a tire pressure

Tires with excessively high pressure can burst.

In addition, they also suffer from irregular wear, which can significantly impair the brak-

ing properties and the handling characteristics.

- ▶ Avoid excessively high tire pressures.

Tire pressure which is too high can cause:

- Increased braking distance
- Impaired handling characteristics
- Irregular wear
- Impaired driving comfort
- Susceptibility to damage

**▲ WARNING** Risk of accident due to repeated pressure drop in the tires

The wheels, valves or tires could be damaged. Too low a tire pressure can lead to the tires bursting.

- ▶ Examine the tires for foreign objects.
- ▶ Check whether the tire has a puncture or the valve has a leak.
- ▶ If you are unable to rectify the damage, contact a qualified specialist workshop.

You can find information on the recommended tire pressures for the vehicle's factory-installed tires on the following labels:

- Tire and Loading Information placard on the B-pillar of your vehicle (→ page 420).
- Tire pressure table on the inside of the fuel filler flap (→ page 416).

Observe the maximum tire pressure (→ page 426).

Use a suitable pressure gauge to check the tire pressure. The outer appearance of a tire does not permit any reliable conclusion about the tire pressure.

Only correct tire pressure when the tires are cold. Conditions for cold tires:

- The vehicle has been parked with the tires out of direct sunlight for at least three hours.
- The vehicle has traveled less than 1 mile (1.6 km).

The vehicle's tires heat up when driving. As the temperature of the tires increases, so too does the tire pressure.

**Vehicles with a tire pressure monitoring system:** you can also see the tire pressure in the driver's display (→ page 418).

The tire pressure recommended for increased load/speed in the tire pressure table can affect the ride comfort.

**⚠ WARNING** Risk of accident due to unsuitable accessories on tire valves

If you mount unsuitable accessories onto tire valves, the tire valves may be overloaded and malfunction, which can cause tire pressure loss.

▶ Only screw standard valve caps or valve caps specifically approved by Mercedes-Benz for your vehicle onto the tire valve.

#### Notes on trailer operation

Always inflate the rear axle tires to the recommended tire pressure on the tire pressure table for increased load.

#### Tire pressure table

The tire pressure table is on the inside of the fuel filler flap.

**i** The data shown in the images is example data.

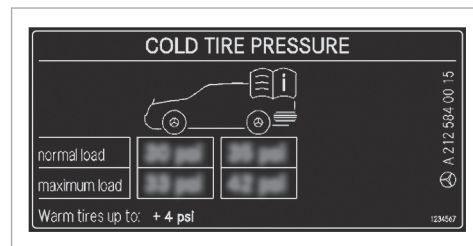

The tire pressure table shows the recommended tire pressure for all tires approved for this vehicle. The recommended tire pressure apply for cold tires under various operating conditions, i.e. loading and/or speed of the vehicle.

If one or more tire sizes precede a tire pressure, the following tire pressure information is only valid for those tire sizes and their respective load condition.

The load conditions "partially laden" and "fully laden" are defined in the table for different numbers of passengers and amounts of luggage. The actual number of seats may differ from this.

		kPa		psi	
R18	Icon: 1 person, 1 suitcase				
	Icon: 2 people, 2 suitcases				
	Icon: 3 people, 3 suitcases				
R19	Icon: 1 person, 1 suitcase				
	Icon: 2 people, 2 suitcases				
	Icon: 3 people, 3 suitcases				
M+S	Icon: 1 person, 1 suitcase				
	Icon: 2 people, 2 suitcases				
	Icon: 3 people, 3 suitcases				

Some tire pressure tables only show the rim diameter instead of the complete tire size, e.g. **R18**. The rim diameter is part of the tire size and can be found on the tire side wall (→ page 427).

- Tire and Loading Information placard (→ page 420)
- Maximum tire pressures (→ page 426)

### Checking the tire pressure manually

- ▶ Read the tire pressure recommended for the current operating conditions from the tire and loading information placard or the tire pressure table. Observe the notes on tire pressure.
- ▶ Remove the valve cap of the tire to be checked.
- ▶ Press the tire pressure gauge securely onto the valve.
- ▶ Read the tire pressure.
- ▶ If the tire pressure is lower than the recommended value, increase the tire pressure to the recommended value.
- ▶ If the tire pressure is higher than the recommended value, release air. To do so, press down the metal pin in the valve, e.g. using the tip of a pen. Then check the tire pressure again using the tire pressure gauge.

- ▶ Screw the valve cap onto the valve.

Further related subjects:

- Notes on tire pressure (→ page 414)
- Tire pressure table (→ page 416)
- Tire and loading information placard (→ page 420)

### Tire pressure monitoring system

#### Function of the tire pressure monitor

**⚠ DANGER** Risk of accident due to incorrect tire pressure

Each tire, including the spare (if provided), should be checked monthly when cold and inflated to the inflation pressure recommended by the vehicle manufacturer on the vehicle placard or tire inflation pressure label. (If your vehicle has tires of a different size than the size indicated on the vehicle placard or tire inflation pressure label, you should determine the proper tire inflation pressure for those tires.)

As an added safety feature, your vehicle has been equipped with a tire pressure monitoring system (TPMS) that illuminates a low tire pressure telltale when one or more of your tires is significantly under-inflated. Accordingly, when the low tire pressure telltale illuminates, you should stop and check your tires as soon as possible, and inflate them to the proper pressure. Driving on a significantly under-inflated tire causes the tire to overheat and can lead to tire failure. Under-inflation also reduces fuel efficiency and tire tread life, and may affect the vehicle's handling and stopping ability. Please note that the TPMS is not a substitute for proper tire maintenance, and it is the driver's responsibility to maintain correct tire pressure, even if under-inflation has not reached the level to trigger illumination of the TPMS low tire pressure telltale.

Your vehicle has also been equipped with a TPMS malfunction indicator to indicate when the system is not operating properly. The TPMS malfunction indicator is combined with the low tire pressure telltale. When the system

detects a malfunction, the telltale will flash for approximately one minute and then remain continuously illuminated. This sequence will continue upon subsequent vehicle start-ups as long as the malfunction exists.

When the malfunction indicator is illuminated, the system may not be able to detect or signal low tire pressure as intended. TPMS malfunctions may occur for a variety of reasons, including the installation of replacement or alternate tires or wheels on the vehicle that prevent the TPMS from functioning properly.



The system uses a tire pressure sensor to check the pressure and temperature of the tires fitted on the vehicle.

The tire pressure and tire temperature appear on the driver's display.

If there is a substantial pressure loss or if the tire temperature is excessive, you will be warned with display messages (→ page 525) or the  warning lamp on the driver's display (→ page 549).

The tire pressure monitor is only an aid. It is the driver's responsibility to set the tire pressure to the recommended cold tire pressure suitable for the operating situation.

In most cases, the tire pressure monitor will automatically update the new reference values after you have changed the tire pressure. You can, however, also update the reference values by restarting the tire pressure monitor manually (→ page 419).

### System limits

The system may be impaired or may not function particularly in the following situations:

- incorrect reference values were taught in
- sudden pressure loss caused by a foreign object penetrating the tire, for example
- there is a malfunction caused by another radio signal source

### ■ Checking the tire pressure with the tire pressure monitoring system

#### Requirements

- The vehicle is switched on.

Driver's display:

→  » Service

▶ Press **OK** to confirm.

One of the following displays appears:

- Current tire pressure of each wheel:



- **Tire pressure displayed after driving for a few minutes:** current values are not yet known to the system. The pressure/temperature values for each tire will be displayed as soon as they are known to the system.
- **Tire Pressure Monitor Active:** the teach-in process of the system is not yet complete. The tire pressures are already being monitored.

▶ Compare the current tire pressure with the recommended tire pressure for the current operating condition (→ page 416). Additionally, observe the notes on cold tires (→ page 414).

ⓘ The values displayed in the driver's display may deviate from those of the tire pressure gauge as they refer to sea level. At high elevations, the tire pressure values indicated by a tire pressure gauge are higher than those shown in the driver's display.

Bear in mind the following related topic:

- Notes on tire pressure (→ page 414)

### Restarting the tire pressure monitoring system

#### Requirements

- The recommended tire pressure is correctly set for the respective operating condition on each of the four wheels (→ page 414).

Restart the tire pressure monitoring system in the following situations:

- The tire pressure has changed.

- The wheels or tires have been changed or newly installed.

Driver's display:

→  » Service

▶ Select **Tire Pressure** and press **OK** to confirm.

▶ Swipe downwards on Touch Control on the steering wheel.

The **Use current pressures as new reference values?** message is shown on the driver's display.

▶ Select **Yes** and confirm the restart with **OK**. The **Tire Pressure Monitor Restarted** message is shown on the driver's display.

Current warning messages are deleted and the  yellow warning lamp goes out.

After driving for a few minutes, the system checks whether the current tire pressures are within the specified range. The current tire pressures are then accepted as reference values and monitored.

If the tire pressure levels are not within the specified range, the **Please Correct Tire Pressure** message appears.

Bear in mind the following related topic:

- Notes on tire pressure (→ page 414)

### Loading the vehicle

#### Notes on the Tire and Loading Information placard

**⚠ WARNING** Risk of accident from overloaded tires

Overloaded tires may overheat and burst as a consequence. Overloaded tires can also impair the steering and handling characteristics and lead to brake failure.

- ▶ Observe the load rating of the tires.
- ▶ The load rating must be at least half the permissible axle load of the vehicle.
- ▶ Never overload the tires by exceeding the maximum load.

The Tire and Loading Information placard is on the B-pillar on the driver's side of the vehicle.

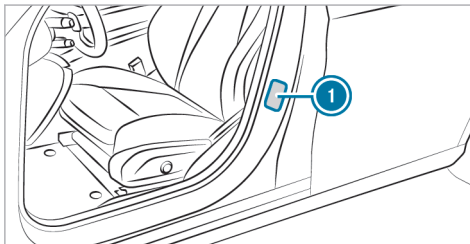

① Tire and Loading Information placard

TIRE AND LOADING INFORMATION		RENSEIGNEMENTS SUR LES PNEUS ET LE CHARGEMENT	
SEATING CAPACITY NOMBRE DE PLACES	TOTAL 7	FRONT AVANT	2
MIDDLE MI	3	REAR ARRIERE	2
The combined weight of occupants and cargo should never exceed Le poids total des occupants et du chargement ne doit jamais dépasser		XXX kg or XXX lbs.*	
TIRE PNEU	SIZE DIMENSIONS	COLD TIRE PRESSURE PRESSION DES PNEUS À FROID	SEE OWNER'S MANUAL FOR ADDITIONAL INFORMATION
FRONT AVANT	255/40 ZR18 99Y XL	200 KPA, 29 PSI	VOIR LE MANUEL DE L'USAGER POUR PLUS DE RENSEIGNEMENTS
REAR ARRIERE	285/35 ZR18 101Y XL	200 KPA, 29 PSI	
SPARE DE SECOURS	175/55-18 95P	420 KPA, 60 PSI	

① The data shown in the illustration is example data.

The Tire and Loading Information placard shows the following information:

- Maximum number of seats ② according to the maximum number of people permitted to travel in the vehicle.

- Maximum permissible load ③ comprises the gross weight of all vehicle occupants, load and luggage.
- Recommended tire pressures ① for cold tires. The recommended tire pressures are valid for the maximum permissible load and up to the maximum permissible vehicle speed.

Please also note:

- Information on permissible weights and loads on the vehicle identification plate (→ page 445).
- Information on tire pressure on the tire pressure table (→ page 416).

Further related subjects:

- Determining the maximum permissible load (→ page 421)
- Notes on tire pressure (→ page 414)

### Steps for Determining Correct Load Limit

The following steps have been developed as required of all manufacturers under Title 49, Code of U.S. Federal Regulations, Part 575, pursuant to

the "National Traffic and Motor Vehicle Safety Act of 1966".

- ▶ (1): Locate the statement "The combined weight of occupants and cargo should never exceed XXX kg or XXX lbs." on your vehicle's placard.
- ▶ (2): Determine the combined weight of the driver and passengers that will be riding in your vehicle.
- ▶ (3): Subtract the combined weight of the driver and passengers from XXX kg or XXX lbs.
- ▶ (4): The resulting figure equals the available amount of cargo and luggage load capacity. For example, if the "XXX" amount equals 1,400 lbs. and there will be five 150 lb passengers in your vehicle, the amount of available cargo and luggage load capacity is 650 lbs. (1,400 - 750 (5 x 150) = 650 lbs.)
- ▶ (5): Determine the combined weight of luggage and cargo being loaded on the vehicle. That weight may not safely exceed the available cargo and luggage load capacity calculated in Step 4.

- ▶ (6): If your vehicle will be towing a trailer, load from your trailer will be transferred to your vehicle. Consult this manual to determine how this reduces the available cargo and luggage load capacity of your vehicle.

- ① Not all vehicles are permitted to tow a trailer. Towing a trailer is only permitted if a trailer-hitch is installed. Please consult an authorized Mercedes-Benz dealer if you have any questions about towing a trailer with your vehicle.

Even if you have calculated the total load carefully, you should still make sure that the maximum permissible gross weight and the maximum gross axle weight rating of your vehicle are not exceeded. Details can be found on the vehicle identification plate.

- ▶ Have your loaded vehicle – including driver, occupants and load – weighed on a vehicle weighbridge. The measured values may not exceed the maximum permissible values stated on the vehicle identification plate.

## 422 Wheels and tires

Further related subjects:

- Calculation example for determining the maximum load (→ page 422)
- Tire and Loading Information placard (→ page 420)
- Tire pressure table (→ page 416)
- Vehicle identification plate (→ page 445)

### Calculation example for determining the maximum load

The following table shows examples of how to calculate total and load capacities with varying seating configurations and different numbers and sizes of occupants. The following examples use a maximum load of 1500 lbs (680 kg). **This is for**

**illustration purposes only.** Make sure you are using the actual load limit for your vehicle stated on your vehicle's Tire and Loading Information placard (→ page 420).

The higher the weight of all the occupants, the smaller the maximum load for luggage.

### Step 1

	Example 1	Example 2
Combined maximum weight of occupants and load (data from the Tire and Loading Information placard)	1500 lbs (680 kg)	1500 lbs (680 kg)



## Step 2

	Example 1	Example 2
Number of people in the vehicle (driver and occupants)	5	1
Distribution of the occupants	Front: 2 Rear: 3	Front: 1
Weight of occupants	Occupant 1: 150 lbs (68 kg) Occupant 2: 180 lbs (82 kg) Occupant 3: 160 lbs (73 kg) Occupant 4: 140 lbs (63 kg) Occupant 5: 120 lbs (54 kg)	Occupant 1: 200 lbs (91 kg)
Total weight of all occupants	750 lbs (340 kg)	200 lbs (91 kg)

## Step 3

	Example 1	Example 2
Permissible load (maximum gross vehicle weight rating from the Tire and Loading Information placard minus the gross weight of all occupants)	$1500 \text{ lbs (680 kg)} - 750 \text{ lbs (340 kg)} = 750 \text{ lbs (340 kg)}$	$1500 \text{ lbs (680 kg)} - 200 \text{ lbs (91 kg)} = 1300 \text{ lbs (589 kg)}$

## Tire labeling

### Overview of tire labeling

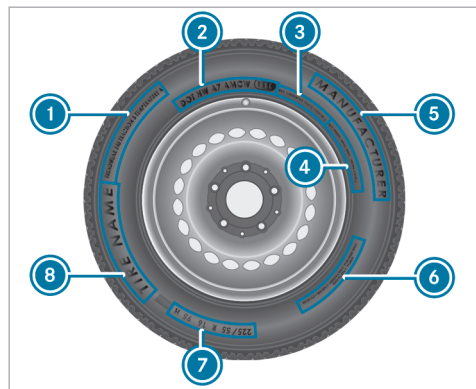

- ① Uniform Tire Quality Grading Standards
- ② DOT (Department of Transportation), (TIN) Tire Identification Number
- ③ Maximum tire load (→ page 426)
- ④ Maximum tire pressure (→ page 426)

- ⑤ Manufacturer
- ⑥ Tire characteristics (→ page 427)
- ⑦ Tire size designation, load-bearing capacity, speed rating and load index (→ page 427)
- ⑧ Tire name
- ⓘ The data shown in the illustration is example data.

### Tire quality grading

In accordance with the US Department of Transportation's "Uniform Tire Quality Grading Standards," tire manufacturers are required to grade their tires on the basis of the following three performance factors:

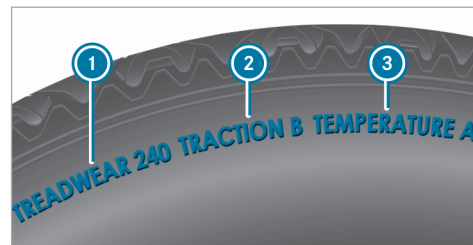

- ① Tread wear grade
- ② Traction grade
- ③ Temperature grade
- ⓘ The data shown in the illustration is example data.
- ⓘ The classification is not legally stipulated for Canada, but it is generally stated.

### Tread wear grade

The treadwear grade is a comparative rating based on the wear rate of the tire when tested under controlled conditions on a specified government test course. For example, a tire graded 150 would wear one and one-half (1 1/2) times as

well on the government course as a tire graded 100.

The relative performance of tires depends upon the actual conditions of their use, however, and may depart significantly from the norm due to variations in driving habits, service practices and differences in road characteristics and climate.

### Traction grade

**⚠ DANGER** Risk of accident due to inadequate traction

The traction grade assigned to this tire is based on straight-ahead braking traction tests.

- ▶ Always adapt your driving style and drive at a speed to suit the prevailing traffic and weather conditions.

**! NOTE** Damage to the drivetrain from wheelspin

- ▶ Avoid wheelspin.

The traction grades, from highest to lowest, are AA, A, B, and C. Those grades represent the tire's ability to stop on wet pavement as measured under controlled conditions on specified government test surfaces of asphalt and concrete. A tire marked C may have poor traction performance.

### Temperature grade

**⚠ WARNING** Risk of accident from tire overheating and tire failure

Excessive speed, underinflation, or excessive loading, either separately or in combination, can cause excessive heat build-up and possible tire failure.

- ▶ Observe the recommended tire pressure.
- ▶ Regularly check the pressure of all the tires.
- ▶ Adjust the tire pressure, if necessary.

The temperature grades are A (the highest), B, and C, representing the tire's resistance to the generation of heat and its ability to dissipate heat when tested under controlled conditions on a specified indoor laboratory test wheel. Sustained

high temperature can cause the material of the tire to degenerate and reduce tire life, and excessive temperature can lead to sudden tire failure. The grade C corresponds to a level of performance which all passenger car tires must meet under the Federal Motor Safety Standard No. 109. Grades B and A represent higher levels of performance on the laboratory test wheel than the minimum required by law.

### DOT, Tire Identification Number (TIN)

US tire regulations stipulate that every tire manufacturer or retreader must imprint a TIN in or on the side wall of each tire produced.

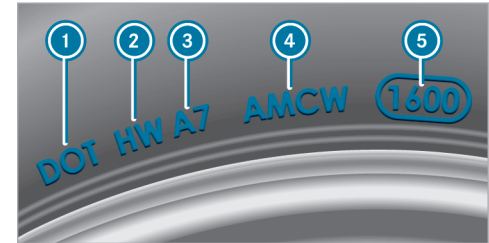

① The data shown in the illustration is example data.

The TIN is a unique identification number to identify tires and comprises the following:

- **DOT (Department of Transportation):** tire symbol marks ① indicating that the tire complies with the requirements of the US Department of Transportation.
- **Manufacturer identification code:** manufacturer identification code ② contains details of the tire manufacturer. New tires have a code with two symbols. Retreaded tires have a code with four symbols. Further information on retreaded tires (→ page 431).
- **Tire size:** identifier ③ describes the tire size.
- **Tire type code:** tire type code ④ can be used by the manufacturer as a code to describe specific characteristics of the tire.
- **Manufacturing date:** manufacturing date ⑤ provides information about the age of a tire. The 1st and 2nd positions represent the calendar week and the 3rd and 4th positions state the year of manufacture (e.g. "3208" represents the 32nd week of 2008).

### Information on the maximum tire load

**⚠ WARNING** Risk of accident from overloaded tires

Overloaded tires may overheat and burst as a consequence. Overloaded tires can also impair the steering and handling characteristics and lead to brake failure.

- ▶ Observe the load rating of the tires.
- ▶ The load rating must be at least half the permissible axle load of the vehicle.
- ▶ Never overload the tires by exceeding the maximum load.

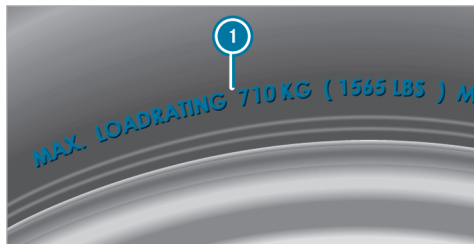

① The data shown in the illustration is example data.

Maximum tire load ① is the maximum permissible weight for which the tire is approved.

Do not overload the tires by exceeding the specified load limit. The maximum permissible load can be found on the vehicle's Tire and Loading Information placard on the B-pillar on the driver's side (→ page 420).

### Specifications for maximum tire pressure

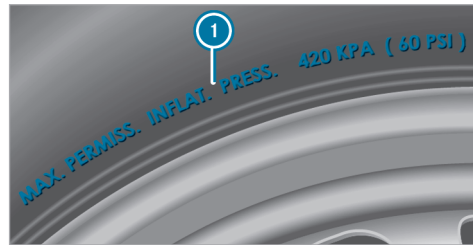

① The data shown in the illustration is example data.

Never exceed maximum tire pressure ❶ specified for the tire. Always observe the recommended tire pressure for your vehicle when adjusting the tire pressure (→ page 416).

### Information on tire characteristics

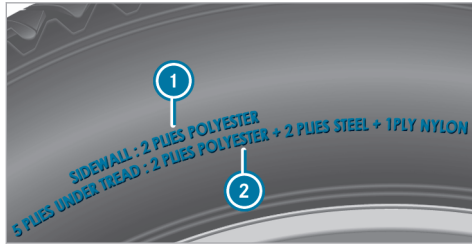

❶ The data shown in the illustration is example data.

This information describes the type of tire cord and the number of layers in side wall ❶ and under tire tread ❷.

### Tire size designation, load-bearing capacity, speed rating and load index

**⚠ WARNING** Risk of injury through exceeding the specified tire load-bearing capacity or the permissible speed rating

Exceeding the specified tire load rating or the permissible speed rating may lead to tire damage and to the tires bursting.

- ▶ Therefore, only use tire types and sizes approved for your vehicle model.
- ▶ Observe the tire load rating and speed rating required for your vehicle.

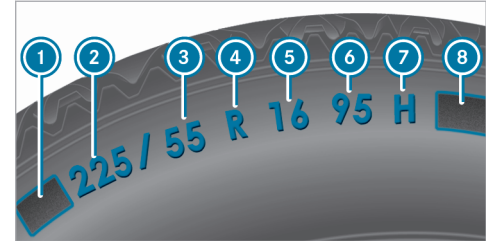

- ❶ First letter(s)
- ❷ Nominal tire width in millimeters
- ❸ Aspect ratio in %
- ❹ Tire code
- ❺ Rim diameter
- ❻ Load-bearing index
- ❼ Speed rating
- ❽ Load index

❶ The data shown in the illustration is example data.

Information about reading tire data can be obtained from any qualified specialist workshop.

**First letter(s) 1:**

- Without: passenger vehicle tires according to European manufacturing standards.
- "P": passenger vehicle tires according to US manufacturing standards.
- "LT": light truck tires according to US manufacturing standards.
- "T": compact emergency spare wheels with high tire pressure that are only designed for temporary use in an emergency.

**Aspect ratio 3:**

Ratio between tire height and tire width in percent (tire height divided by tire width).

**Tire code 4 (tire type):**

- "R" radial tire
- "D": bias ply tire
- "B": bias belted tires
- "ZR": radial tire with a maximum speed above 149 mph (240 km/h) (optional)

**Rim diameter 5:**

The diameter of the bead seat (not the diameter of the rim flange). The rim diameter is specified in inches (in).

**Load-bearing index 6:**

Numerical code that specifies the maximum load-bearing capacity of a tire (e.g. "91" corresponds to 1,356 lbs (615 kg)).

The load-bearing capacity of the tire must be at least half the gross axle weight rating of your vehicle. Do not overload the tires by exceeding the specified load limit.

See also:

- Maximum permissible load on the Tire and Loading Information placard (→ page 420)
- Maximum tire load (→ page 426)
- Load index

**Speed rating 7:**

Specifies the approved maximum speed of the tire.

- i** An electronic speed limiter prevents your vehicle from exceeding a speed of 130 mph (210 km/h).

Make sure that your tires have the required speed rating. You can obtain information on the required speed rating from an authorized Mercedes-Benz Center.

**Summer tires**

Index	Speed rating
Q	up to 100 mph (160 km/h)
R	up to 106 mph (170 km/h)
S	up to 112 mph (180 km/h)
T	up to 118 mph (190 km/h)
H	up to 130 mph (210 km/h)
V	up to 149 mph (240 km/h)
W	up to 168 mph (270 km/h)
Y	up to 186 mph (300 km/h)

Index	Speed rating
ZR...Y <sup>1</sup>	up to 186 mph (300 km/h)
ZR...(..Y) <sup>1</sup>	over 186 mph (300 km/h)
ZR <sup>1</sup>	over 149 mph (240 km/h)

- Specifying the speed rating as the "ZR" index in tire code ④ is optional for tires up to 186 mph (300 km/h).
- If your tire code ④ includes "ZR" and there is no speed rating ⑦, find out what the maximum speed is from the tire manufacturer.
- If load-bearing index ⑥ and speed rating ⑦ are in brackets, the maximum speed rating of your tire is above 186 mph (300 km/h). To find out the maximum speed, ask the tire manufacturer.

<sup>1</sup> "ZR" stated in the tire code.

<sup>2</sup> Or "M+S"  " for winter tires.

### All-weather tires and winter tires

Index	Speed rating
Q M+S <sup>2</sup>	up to 100 mph (160 km/h)
T M+S <sup>2</sup>	up to 118 mph (190 km/h)
H M+S <sup>2</sup>	up to 130 mph (210 km/h)
V M+S <sup>2</sup>	up to 149 mph (240 km/h)

Winter tires bear the  snowflake symbol and fulfill the requirements of the Rubber Manufacturers Association (RMA) and the Rubber Association of Canada (RAC) regarding the tire traction on snow.

### Load index ⑧:

- No specification given: standard load (SL) tire
- "XL" or "Extra Load": extra load tire or reinforced tire
- "Light Load": light load tire

- "C", "D", "E": a load range that depends on the maximum load that the tire can carry at a certain pressure

### Definition of terms for tires and loading

**Tire structure and characteristics:** describes the number of layers or the number of rubber-coated belts in the tire contact surface and the tire wall. These are made of steel, nylon, polyester and other materials.

**Bar:** metric unit for tire pressure. 14.5038 pounds per square inch (psi) and 100 kilopascal (kPa) is the equivalent of one bar.

**DOT (Department of Transportation):** DOT-marked tires fulfill the requirements of the U.S. Department of Transportation.

**Average weight of the vehicle occupants:** the number of vehicle occupants for which the vehicle is designed, multiplied by 150 lb (68 kg).

**Uniform Tire Quality Grading Standards:** a uniform standard to grade the quality of tires with regard

to tread quality, tire traction and temperature characteristics. The quality grading assessment is made by the manufacturer following specifications from the U.S. government. The quality grade of a tire is printed on the side wall of the tire.

**Recommended tire pressure:** the recommended tire pressure is the tire pressure specified for the tires mounted on the vehicle at the factory.

The tire and information placard contains the recommended tire pressure for cold tires, the maximum permissible load and the maximum permissible vehicle speed.

The tire pressure table contains the recommended tire pressure for cold tires under various operating conditions, i.e. loading and/or speed of the vehicle.

**Increased vehicle weight due to optional equipment:** the combined weight of all standard and optional equipment available for the vehicle, regardless of whether it is actually installed on the vehicle or not.

**Rim:** the part of the wheel on which the tire is installed.

**GAWR (Gross Axle Weight Rating):** the GAWR is the maximum gross axle weight rating. The actual load on an axle must never exceed the gross axle weight rating. The gross axle weight rating can be found on the vehicle identification plate on the B-pillar on the driver's side.

**Speed rating:** the speed rating is part of the tire identification. It specifies the speed range for which a tire is approved.

**GVW (Gross Vehicle Weight):** the gross vehicle weight comprises the weight of the vehicle including fuel, tools, the spare wheel, any accessories installed, occupants, luggage and the trailer nose-weight, if applicable. The gross vehicle weight must not exceed the gross vehicle weight rating GVWR as specified on the vehicle identification plate on the B-pillar on the driver's side.

**GVWR (Gross Vehicle Weight Rating):** the GVWR is the maximum permitted gross weight of the fully laden vehicle (weight of the vehicle including all accessories, occupants, fuel, luggage and the trailer drawbar noseweight if applicable). The gross vehicle weight rating is specified on the vehicle identification plate on the B-pillar on the driver's side.

**Maximum weight of the laden vehicle:** the maximum weight is the sum of the curb weight of the vehicle, the weight of the accessories, the maximum load and the weight of optional equipment installed at the factory.

**Kilopascal (kPa):** metric unit for tire pressure. 6.9 kPa corresponds to 1 psi. Another unit for tire pressure is bar. 100 kilopascal (kPa) equals 1 bar.

**Load index:** in addition to the load-bearing index, the load index may also be printed on the side wall of the tire. This specifies the load-bearing capacity of the tire more precisely.

**Curb weight:** the weight of a vehicle with standard equipment including the maximum capacity of fuel, oil and coolant. It also includes the air conditioning system and optional equipment if these are installed on the vehicle, but does not include passengers or luggage.

**Maximum tire load:** the maximum tire load is the maximum permissible weight in kilograms or lbs for which a tire is approved.

**Maximum permissible tire pressure:** maximum permissible tire pressure for one tire.



**Maximum load on one tire:** maximum load on one tire. This is calculated by dividing the maximum axle load of one axle by two.

**PSI (pounds per square inch):** standard unit of measurement for tire pressure.

**Aspect ratio:** ratio between tire height and tire width in percent.

**Tire pressure:** the pressure inside the tire which applies an outward force to every square inch of the tire. The tire pressure is specified in pounds per square inch (psi), in kilopascals (kPa) or in bar. The tire pressure should only be corrected when the tires are cold.

**Cold tire pressure:** the tires are cold when the vehicle has been parked for at least 3 hours without direct sunlight on the tires or the vehicle has been driven for less than 1 mile (1.6 km).

**Tire contact surface:** the part of the tire that comes into contact with the road.

**Tire bead:** the purpose of the tire bead is to ensure that the tire sits securely on the wheel rim. There are several wire cores in the tire bead to prevent the tire from changing length on the wheel rim.

**Side wall:** the part of the tire between the tread and the tire bead.

**Weight of optional equipment:** the combined weight of the optional equipment weighing more than the replaced standard parts and more than 5 lbs (2.3 kg). This optional equipment, such as high-performance brakes, level control system, a roof luggage rack or high-performance batteries, is not included in the curb weight and the weight of the accessories.

**TIN (Tire Identification Number):** a unique identification number which can be used by a tire manufacturer to identify tires, for example, in a product recall, and thus identify the purchasers. The TIN is made up of the manufacturer's identity code, tire size, tire type code and the manufacturing date.

**Load-bearing index:** the load-bearing index is a code that contains the maximum load-bearing capacity of a tire.

**Traction:** traction is the grip resulting from friction between the tires and the road surface.

**Wear indicator:** narrow bars (tread wear bars) that are distributed over the tire contact surface. If the

tire tread is level with the bars, the wear limit of 1/16 in (1.6 mm) has been reached.

**Distribution of vehicle occupants:** distribution of vehicle occupants over designated seat positions in a vehicle.

**Maximum permissible payload weight:** nominal load and luggage load plus 150 lb (68 kg) multiplied by the number of seats in the vehicle.

## Changing a wheel

### Notes on selecting, mounting and replacing tires

**!** **NOTE** Mercedes-AMG vehicles

▶ Observe the notes in the Supplement. You could otherwise fail to recognize dangers.

**⚠** **WARNING** Risk of accident due to incorrect wheel and tire dimensions

If wheels and tires of the wrong size are installed, the service brakes or components in the

brake system and in the wheel suspension may be damaged.

- ▶ Always replace wheels and tires with ones that fulfill the specifications of the original part.

For wheels, pay attention to the following:

- Designation
- Type

For tires, pay attention to the following:

- Designation
- Manufacturer
- Type

**⚠ WARNING** Risk of injury through exceeding the specified tire load-bearing capacity or the permissible speed rating

Exceeding the specified tire load rating or the permissible speed rating may lead to tire damage and to the tires bursting.

- ▶ Therefore, only use tire types and sizes approved for your vehicle model.
- ▶ Observe the tire load rating and speed rating required for your vehicle.

**! NOTE** Vehicle and tire damage caused by non-approved tire types and sizes

For safety reasons, only use tires, wheels and accessories which have been specially approved by Mercedes-Benz for your vehicle.

These tires are specially adapted to the active safety systems, such as ABS, ESP® and 4MATIC, and marked as follows:

- MO = Mercedes-Benz Original
- MOE = Mercedes-Benz Original Extended (tires with run-flat characteristics for certain wheels only)
- MO1 = Mercedes-Benz Original (only certain AMG tires)

Otherwise, certain properties, such as driving characteristics, vehicle noise emissions, consumption, etc. could be adversely affected.

Furthermore, other tire sizes could result in the tires rubbing against the body and axle components when loaded. This could result in damage to the tire or the vehicle.

Only use tires, wheels and accessories that have been checked and recommended by Mercedes-Benz.

**! NOTE** Risk to driving safety from retreaded tires

Retreaded tires are neither tested nor recommended by Mercedes-Benz, since previous damage cannot always be detected on retreaded tires.

For this reason driving safety cannot be guaranteed.

- ▶ Do not use used tires if you have no information about their previous usage.

- !** **NOTE** Possible wheel and tire damage when driving over obstacles

Large wheels have a smaller section width. As the section width decreases, the risk of wheels and tires being damaged when driving over obstacles increases.

- ▶ Avoid obstacles or drive especially carefully.
- ▶ Reduce your speed when driving over curbs, speed bumps, manhole covers and potholes.
- ▶ Avoid particularly high curbs.

- !** **NOTE** Possible wheel and tire damage when parking on curbs or in potholes

Parking on curbs or in potholes can damage the wheels and tires.

- ▶ Only park on as level a surface as possible.
- ▶ Avoid curbs and potholes when parking.

- !** **NOTE** Damage to electronic components due to the use of mounting tools

**Vehicles with a tire pressure monitoring system:** there are electronic components in the wheel.

Using mounting tools in the area of the valve may damage the electronic components.

- ▶ Tire mounting tools should not be used in the area of the valve.
- ▶ Always have tires changed at a qualified specialist workshop.

- !** **NOTE** Damage to summer tires at low ambient temperatures

At low ambient temperatures, tears could form when driving with summer tires, causing permanent damage to the tires.

- ▶ At temperatures below 45 °F (7 °C) use  M+S tires.

Accessory parts which are not approved for your vehicle by Mercedes-Benz, or which are not used correctly, can impair the operating safety.

Before purchasing and using non-approved accessories, visit a qualified specialist workshop and inquire about:

- Suitability
- Legal stipulations
- Factory recommendations

- !** **WARNING** Risk of accidents with sports tires

The special tire tread in combination with the optimized tire compound means that the risk of skidding or hydroplaning on wet roads is increased.

In addition, the tire grip is greatly reduced at a low outside temperature and tire running temperature.

- ▶ Switch on ESP<sup>®</sup> and adapt your driving style accordingly.
- ▶ Use  M+S tires at outside temperatures of less than 45°F (7°C).
- ▶ Only use tires suitable for the intended use.

Observe the following when selecting, mounting and replacing tires:

- Furthermore, the use of certain tire types in certain regions and areas of operation can be highly beneficial.
- Only use tires and wheels of the same type (summer tires, winter tires, MOExtended tires) and the same make.
- Only mount wheels of the same size on both sides of an axle (left and right).

It is only permissible to mount a different wheel size in the event of a flat tire in order to drive to the specialist workshop.

- **Vehicles with a tire pressure monitoring system:** All mounted wheels must be equipped with functioning sensors for the tire pressure monitoring system.
- At temperatures below 45 °F (7 °C), use winter tires or all-season tires marked  M+S for all wheels.

Winter tires provide the best possible grip in wintry road conditions.

- For M+S tire, only use tires with the same tread.
- Observe the maximum permissible speed for the M+S tire used.  
If the tire's maximum speed is below that of the vehicle, this must be indicated by an appropriate label in the driver's field of vision.
- Break in new tires at moderate speeds for the first 60 miles (100 km).
- Replace the tires after six years at the latest, regardless of wear.
- **When replacing with tires that do not feature run-flat characteristics:** Vehicles with MOExtended tires are not equipped with a TIREFIT kit at the factory. Equip the vehicle with a TIREFIT kit after replacing the tires with tires that do not feature run-flat characteristics, e.g. winter tires.

For more information on wheels and tires, contact a qualified specialist workshop.

Be sure to also observe the following further related subjects:

- Notes on tire pressure (→ page 414)

- Tire and Loading Information placard (→ page 420)
- Tire size designation, load-bearing capacity, speed rating and load index (→ page 427)
- Tire pressure table (→ page 416)
- Notes on the emergency spare wheel (→ page 441)

#### Notes on rotating tires

 **WARNING** Risk of injury through different wheel sizes

Rotating the front and rear wheels can severely impair the driving characteristics. The wheel brakes or suspension components may also be damaged.

 Rotate front and rear wheels only if the wheels and tires are of the same dimensions.

Observe the instructions and safety notes on "Changing a wheel" (→ page 431).

The wear patterns on the front and rear tires differ:

- front tires wear more on the tire shoulder
- rear tires wear more in the center of the tire

Do not drive with tires that have too little tread depth. This significantly reduces traction on wet roads (hydroplaning).

On vehicles that have the same front and rear wheel size, rotate the tires according to the intervals in the tire manufacturer's warranty book in your vehicle documents. If this is not available, rotate the tires every 3,000 to 6,000 miles (5,000 to 10,000 km), depending on the wear. Ensure that the direction of rotation is maintained.

### Notes on storing wheels

When storing wheels, observe the following notes:

- After removing wheels, store them in a cool, dry and preferably dark place.
- Protect the tires from contact with oil, grease or fuel.

### Overview of the tire-change tool kit

Apart from some country-specific variants, vehicles are not equipped with a tire-change tool kit. For more information on which tire-changing tools are required and approved for performing a wheel change on your vehicle, consult a qualified specialist workshop.

Required tire-changing tools may include, for example:

- Jack
- Chock
- Lug wrench
- Alignment bolt

Tire-change tool kit ① is located under the cargo floor.

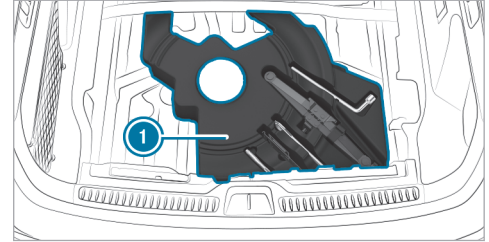

The tire-change tool kit includes the following:

- Jack
- Lug wrench
- Wheel studs
- Extension attachment for wheel studs, if necessary (depending on vehicle version)
- Folding chock
- Ratchet wrench
- Alignment bolt

### Preparing the vehicle for a wheel change

#### Requirements:

- The vehicle is not on a slope.
  - The vehicle is on solid, non-slippery and level ground.
  - The required tire-change tool kit is available.
- i** If your vehicle is not equipped with the tire-change tool kit, consult a qualified specialist workshop to find out about suitable tools.
- ▶ Apply the electric parking brake manually.
  - ▶ Move the front wheels to the straight-ahead position.
  - ▶ Shift the transmission to position **P**.
  - ▶ Switch off the vehicle.
  - ▶ Make sure that the vehicle cannot be started.
  - ▶ Place chocks or other suitable items under the front and rear of the wheel that is diagonally opposite the wheel you wish to change.
  - ▶ Unload the vehicle.

### Removing and installing the wheel trim/hub caps

#### Requirements

- The vehicle is prepared for a wheel change (→ page 436).

#### Plastic hub cap

##### To remove:

- ▶ Turn the center cover of the hub cap counter-clockwise and remove the hub cap.

##### To install:

- ▶ Make sure that the center cover of the hub cap is turned counter-clockwise.
- ▶ Position the hub cap and turn the center cover clockwise until the hub cap engages physically and audibly.

### Aluminum hub cap

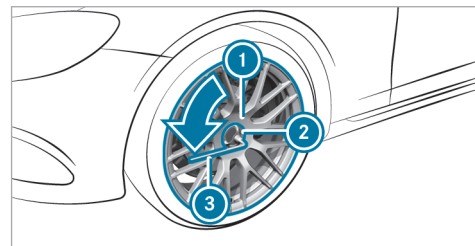

##### To remove:

- ▶ Position socket **2** from the tire-change tool kit on hub cap **1**.
- ▶ Position wheel wrench **3** on socket **2**.
- ▶ Using wheel wrench **3**, turn hub cap **1** counter-clockwise and remove it.

##### To install:

- ▶ Follow the instructions above in reverse order.
- i** **Specified tightening torque:** 18 lb-ft (25 Nm).

## Raising the vehicle when changing a wheel

### Requirements

- There are no persons in the vehicle.
- The vehicle has been prepared for a wheel change (→ page 436).
- The wheel trims and hub caps have been removed (→ page 436).

### Important notes on using the jack:

- Use only a vehicle-specific jack that has been approved by Mercedes-Benz to raise the vehicle.
- The jack is only designed for raising and holding the vehicle for a short time while a wheel is being changed and not for maintenance work under the vehicle.
- The jack must be placed on a firm, flat and non-slip surface. If necessary, use a large, flat, load-bearing, non-slip underlay.
- The foot of the jack must be positioned vertically under the jack support point.

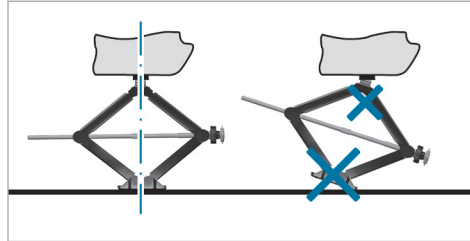

### Rules of conduct when the vehicle is raised:

- Never place your hands or feet under the vehicle.
- Never lie under the vehicle.
- Do not start the vehicle and do not release the electric parking brake.
- Do not open or close any doors or the tailgate.

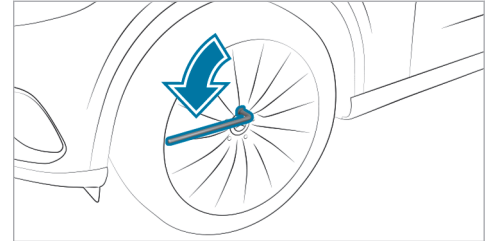

- ▶ Using the lug wrench, loosen the wheel bolts on the wheel you wish to change by about one full turn. Do not unscrew the screws completely.

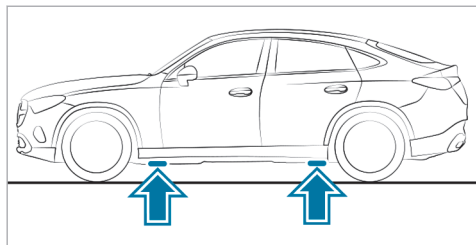

Position of the jack support points

**!** **NOTE** Mercedes-AMG vehicles

- ▶ Observe the notes in the Supplement. You could otherwise fail to recognize dangers.

**!** **WARNING** Risk of injury from incorrect positioning of the jack

If you do not position the jack correctly at the appropriate jacking point of the vehicle, the jack could tip with the vehicle raised.

- ▶ Only position the jack at the appropriate jacking point of the vehicle. The base of

the jack must be positioned vertically under the jacking point of the vehicle.

**!** **NOTE** Damage to the vehicle due to the jack

If you do not position the jack at the jack support points provided for this purpose, you could damage your vehicle.

- ▶ Only position the jack at the jack support points provided for this purpose.

- ▶ Take the ratchet out of the tire-change tool kit and place it on the hexagon nut of the jack so that the letters "AUF" are visible.

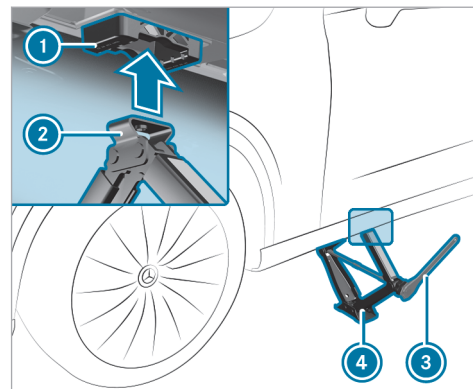

- ▶ Position support ② of jack ④ on jack support point ①.
- ▶ Turn ratchet ③ clockwise until support ② sits completely on jack support point ① and the base of the jack lies evenly on the ground.
- ▶ Turn ratchet ③ until the tire is raised a maximum of 1.2 in (3 cm) from the ground.
- ▶ Loosen and remove the wheel (→ page 439).



## Removing a wheel

### Requirements

- The vehicle is raised (→ page 437).

**!** NOTE Mercedes-AMG vehicles

- Observe the notes in the Supplement. You could otherwise fail to recognize dangers.

When changing a wheel, avoid applying any force to the brake discs, as this could impair the level of comfort when braking.

**!** NOTE Damage to the wheels' plastic elements when changing a wheel

Plastic elements on wheels may be damaged when removing and repositioning the wheel.

- Do not raise the wheels by the plastic elements when removing and repositioning.

**!** NOTE Damage to threading from dirt on wheel bolts

- Do not place wheel bolts in sand or on a dirty surface.

- Unscrew the uppermost wheel bolt completely.

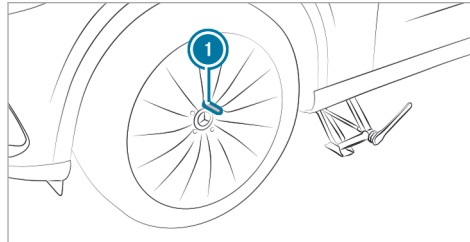

- Screw centering pin ① into the thread instead of the wheel bolt.
- Unscrew the remaining wheel bolts completely.
- Remove the wheel.
- Install the new wheel (→ page 439).

## Installing a new wheel

### Requirements

- The wheel to be changed is removed and the centering pin is screwed in (→ page 439).

**!** NOTE Mercedes-AMG vehicles

- Observe the notes in the Supplement. You could otherwise fail to recognize dangers.

**!** WARNING Risk of accident from losing a wheel

Oiled, greased or damaged wheel bolt/wheel nut threads or wheel hub/wheel mounting bolt threads can cause the wheel bolts/wheel nuts to come loose.

- Never oil or grease the threads.
- In the event of damage to the threads, contact a qualified specialist workshop immediately.
- Have the damaged wheel bolts or damaged hub threads replaced.

- ▶ Do not continue driving.

- ▶ Observe the information on the choice of tires (→ page 431).

For tires with a specified direction of rotation, an arrow on the side wall of the tire indicates the correct direction of rotation. Observe the direction of rotation when installing.

- ! **NOTE** Damage to the wheels' plastic elements when changing a wheel

Plastic elements on wheels may be damaged when removing and repositioning the wheel.

- ▶ Do not raise the wheels by the plastic elements when removing and repositioning.

- ▶ Slide the wheel to be mounted onto the centering pin and push it on.

- ! **WARNING** Risk of injury from tightening wheel bolts and nuts

If you tighten the wheel bolts or wheel nuts when the vehicle is raised, the jack could tip.

- ▶ Only tighten wheel bolts or wheel nuts when the vehicle is on the ground.

- ▶ Be sure to observe the instructions and safety notes on "Changing a wheel" (→ page 431).
- ▶ For safety reasons, only use wheel bolts which have been approved by Mercedes-Benz and for the wheel in question.

- ! **NOTE** Damage to paintwork of the wheel rim when screwing in the first wheel bolt

If the wheel has too much play when screwing in the first wheel bolt, the wheel rim paint can be damaged.

- ▶ Press the wheel firmly against the wheel hub when screwing in the first wheel bolt.

- ▶ Tighten the wheel bolts evenly in a diagonal pattern in the order indicated until they are finger-tight.

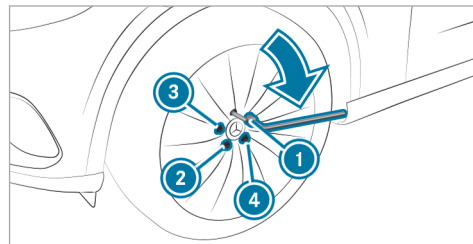

- ▶ Unscrew and remove the centering pin.
- ▶ Tighten the last wheel bolt until it is finger-tight.
- ▶ Lower the vehicle (→ page 440).

#### Lowering the vehicle after a wheel change

##### Requirements

- The new wheel has been installed (→ page 439).

**!** **NOTE** Risk of vehicle jack becoming trapped by the AIRMATIC system

If the AIRMATIC system has released air when raising the vehicle, the jack can become trapped when the vehicle is lowered.

- ▶ Start the engine. This adapts the vehicle level.
- ▶ Remove the jack from under the vehicle.

▶ **To lower the vehicle:** place the ratchet onto the hexagon nut of the jack so that the letters "AB" are visible and turn counter-clockwise.

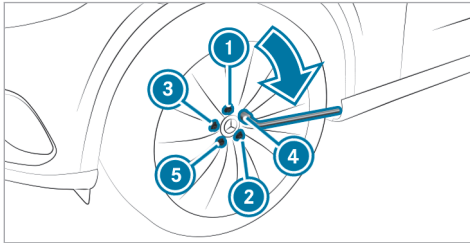

- ▶ Tighten the wheel bolts evenly in a diagonal pattern in the order indicated ① to ⑤ with an initial maximum force of 59 lb-ft (80 Nm).
- ▶ Tighten the wheel bolts evenly in a diagonal pattern in the order indicated ① to ⑤ with the specified tightening torque of 111 lb-ft (150 Nm).

**!** **WARNING** Risk of accident due to incorrect tightening torque

The wheels could come loose if the wheel bolts or wheel nuts are not tightened to the prescribed torque.

- ▶ Ensure that the wheel bolts or wheel nuts are tightened to the prescribed tightening torque.
- ▶ If you are not sure, do not move the vehicle. Contact a qualified specialist workshop and have the tightening torque checked immediately.

▶ Check the tire pressure of the newly installed wheel and adjust it if necessary.

① The following does not apply if the new wheel is an emergency spare wheel.

▶ **Vehicles with a tire pressure monitoring system:** restart the tire pressure monitoring system (→ page 419).

### Emergency spare wheel

#### Notes on the emergency spare wheel

**!** **WARNING** Risk of accident caused by incorrect wheel and tire dimensions

The wheel or tire sizes and the tire type of the emergency spare wheel or spare wheel and the wheel to be replaced may differ. The emergency spare wheel or spare wheel can significantly impair driving characteristics of the vehicle.

To prevent hazardous situations:

- ▶ Drive carefully.
- ▶ Never install more than one emergency spare wheel or spare wheel that differs in size.

- ▶ Only use an emergency spare wheel or spare wheel briefly.
- ▶ Do not deactivate ESP®.
- ▶ Have the emergency spare wheel or spare wheel of a different size replaced at the nearest qualified specialist workshop. The new wheel must have the correct dimensions.

Observe the following notes on installing an emergency spare wheel:

- The maximum permissible speed with an emergency spare wheel installed is 50 mph (80 km/h).
- Do not install the emergency spare wheel with snow chains.
- Replace the emergency spare wheel after six years at the latest, regardless of wear.
- Use the wheel bolts that are included with the emergency spare wheel.
- Check the tire pressure of the emergency spare wheel when it is installed. Correct the pressure as necessary.

- ❗ The specified tire pressure is stated on the label of the emergency spare wheel.
- ❗ **Vehicles with a tire pressure monitoring system:** if an emergency spare wheel is installed, the tire pressure monitoring system cannot function reliably. For a few minutes after an emergency spare wheel is installed, the system may still display the tire pressure of the removed wheel. Only restart the system again when the emergency spare wheel has been replaced with a new wheel.

Be sure to also observe the following further related subjects:

- Notes on tire pressure (→ page 414)
- Tire and Loading Information placard (→ page 420)
- Tire pressure table (→ page 416)
- Notes on installing tires (→ page 431)
- Installing an emergency spare wheel (→ page 436)

### Notes on technical data

#### **!** NOTE Mercedes-AMG vehicles

- ▶ Observe the notes in the Supplement. You could otherwise fail to recognize dangers.

The data stated only applies to vehicles with standard equipment. You can obtain further information from an authorized Mercedes-Benz Center.

### Vehicle electronics

#### Two-way radios

#### **|** Notes on installing two-way radios

#### **!** WARNING Risk of accident due to improper work on two-way radios

If two-way radios are manipulated or retrofitted incorrectly, the electromagnetic radiation from the two-way radios can interfere with the vehicle electronics and jeopardize the operating safety of the vehicle.

- ▶ You should have all work on electrical and electronic components carried out at a qualified specialist workshop.

#### **!** WARNING Risk of accident due to improper operation of two-way radios

If you use two-way radios in the vehicle improperly, their electromagnetic radiation can disrupt the vehicle's electronics. This is the case in the following situations, in particular:

- The two-way radio is not connected to an exterior antenna.
- The exterior antenna is installed incorrectly or is not a low-reflection antenna.

This could jeopardize the operating safety of the vehicle.

- ▶ Have the low-reflection exterior antenna installed at a qualified specialist workshop.

- ▶ When operating two-way radios in the vehicle, always connect them to the low-reflection exterior antenna.

#### **!** NOTE Invalidation of the operating permit due to failure to comply with the instructions for installation and use

The operating permit may be invalidated if the instructions for installation and use of two-way radios are not observed.

- ▶ Only use approved frequency bands.
- ▶ Observe the maximum permissible output power in these frequency bands.
- ▶ Only use approved antenna positions.

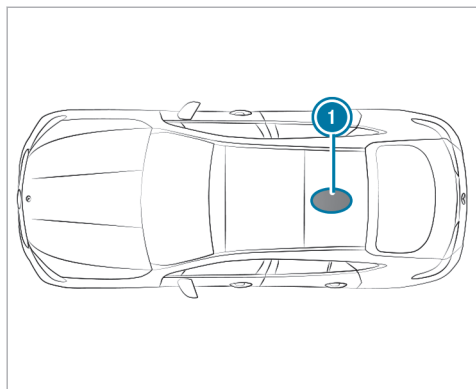

Vehicles without panoramic sliding sunroof

① Rear roof area

On vehicles with a panoramic sliding sunroof, installing an antenna is not permitted.

Use Technical Specification ISO/TS 21609 (Road Vehicles - "EMC guidelines for installation of aftermarket radio frequency transmitting equip-

ment") when retrofitting two-way radios. Comply with the legal requirements for detachable parts.

If your vehicle has fittings for two-way radio equipment, use the power supply and antenna connectors provided in the pre-installation. Observe the manufacturer's supplements when installing.

#### ■ Two-way radio transmission output

The maximum transmission output (PEAK) at the base of the antenna must not exceed the values in the following table.

#### Frequency band and maximum transmission output

Frequency band	Maximum transmission output
2 m frequency band 144-174 MHz	50 W
Terrestrial Trunked Radio (TETRA) 380-460 MHz	10 W

Frequency band	Maximum transmission output
Two-way radio 2G	2 W
Two-way radio 3G/4G/5G	0.5 W

The following can be used in the vehicle without restrictions:

- two-way radios with a maximum transmission output of 100 mW
- two-way radios with transmitter frequencies in the 380-410 MHz frequency band and a maximum transmission output of 2 W (TETRA)
- mobile phones (2G/3G/4G/5G)

There are no restrictions regarding the position of the antenna on the outside of the vehicle for the following frequency bands:

- Terrestrial Trunked Radio (TETRA)
- 2G/3G/4G/5G

## Radio regulations

### Regulatory radio identification and specific notes

Manufacturer information about radio-based vehicle components can be found using the key phrase "Regulatory information" in the Digital Operator's Manual in the vehicle, on the Internet and in the app.

Further information and updates are available at the following web address:

[https://  
regulatoryradioinformation.corpinter.net/us](https://regulatoryradioinformation.corpinter.net/us)



### Information about the specific absorption rate (SAR)

Information on the specific absorption rate (SAR) can be found under the key word "Regulatory

information" in the vehicle's Digital Operator's Manual, on the Internet and in the app.

Further information and updates are available at the following web address:

[https://  
regulatoryradioinformation.corpinter.net/us](https://regulatoryradioinformation.corpinter.net/us)



## Vehicle identification plate, VIN and engine number overview

### Vehicle identification plate

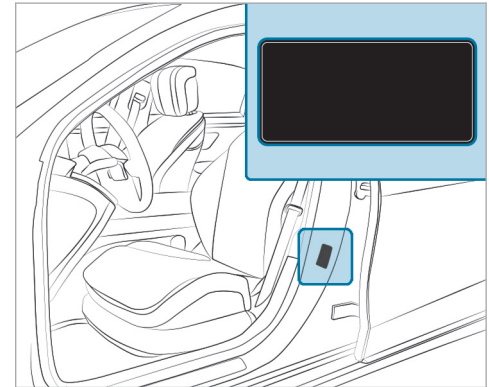

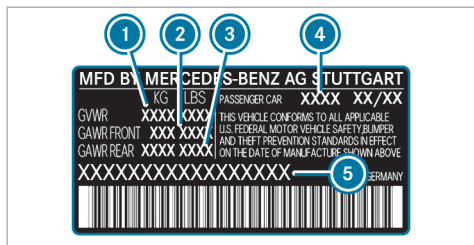

Vehicle identification plate (USA only)

- ① Maximum permissible gross vehicle mass
- ② Maximum permissible front axle load
- ③ Maximum permissible rear axle load
- ④ Paint code
- ⑤ VIN (vehicle identification number)

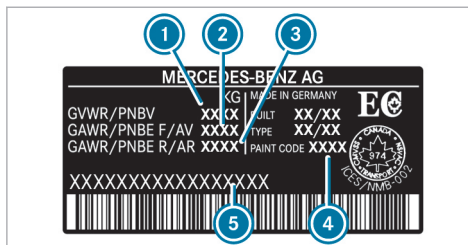

Vehicle identification plate (Canada only)

- ① Maximum permissible gross vehicle mass
- ② Maximum permissible front axle load
- ③ Maximum permissible rear axle load
- ④ Paint code
- ⑤ VIN (vehicle identification number)

The maximum permissible gross vehicle weight is made up of the vehicle weight, all vehicle occupants, the fuel and the load. The maximum gross axle weight rating is the maximum weight that can be carried on one axle (front- or rear axle).

Do not exceed the maximum permissible gross vehicle weight or the maximum gross axle weight rating for the front- or rear axle.

### VIN below the front right-hand seat

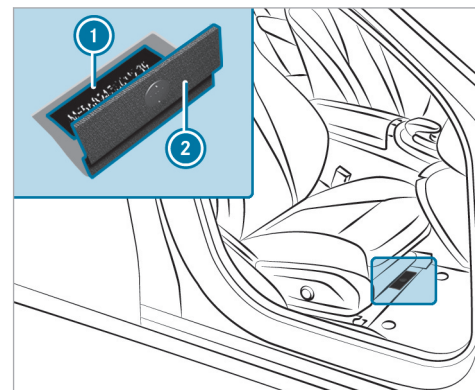

- ① Imprinted VIN (vehicle identification number)
- ② Floor covering



### Additional plates

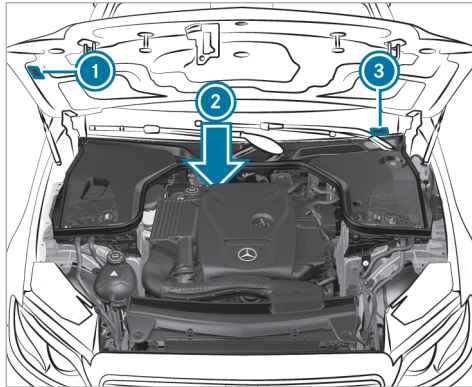

- ① Plate with information about emissions testing, including confirmation of emissions guidelines at the U.S. federal level as well as for California
- ② Engine number stamped into the crankcase
- ③ VIN (vehicle identification number) as a label at the lower edge of the windshield

### Operating fluids

#### Notes on operating fluids

**!** NOTE Mercedes-AMG vehicles

- ▶ Observe the notes in the Supplement. You could otherwise fail to recognize dangers.

**⚠** WARNING Risk of injury due to harmful operating fluids

Operating fluids can be toxic.

- ▶ When using, storing and disposing of operating fluids, observe the imprints on the respective original containers.
- ▶ Always keep operating fluids in the sealed original container.
- ▶ Always keep children away from operating fluids.



**ENVIRONMENTAL NOTE** Pollution of the environment due to irresponsible disposal of operating fluids

Incorrect disposal of operating fluids can cause considerable damage to the environment.

- ▶ Dispose of operating fluids in an environmentally responsible manner.

Operating fluids include the following:

- Fuels
- Lubricants
- Coolant
- Brake fluid
- Windshield washer fluid
- Climate control system refrigerant

Only use products approved by Mercedes-Benz. Damage caused by the use of products that have not been approved is not covered by the Mercedes-Benz warranty or goodwill gestures.

The operating fluids approved by Mercedes-Benz can be identified by the following inscriptions on the container:

- MB-Freigabe (e.g. MB-Freigabe 229.51)
- MB-Approval (e.g. MB-Approval 229.51)

Further information on approved operating fluids:

- in the Mercedes-Benz Specifications for Operating Fluids by entering the designation
  - At <https://operatingfluids.mercedes-benz.com>
- At a qualified specialist workshop

**⚠ WARNING** Risk of fire or explosion from fuel

Fuels are highly flammable.

- ▶ Fire, open flames, smoking and creating sparks must be avoided.
- ▶ Before and during refueling, switch off the vehicle and, if installed, the stationary heater.

**⚠ WARNING** Risk of injury from fuels

Fuels are poisonous and hazardous to your health.

- ▶ Do not swallow fuel or let it come into contact with skin, eyes or clothing.
- ▶ Do not inhale fuel vapor.
- ▶ Keep children away from fuel.
- ▶ Keep doors and windows closed during the refueling process.

If you or other people come into contact with fuel, observe the following:

- ▶ Immediately rinse fuel off your skin with soap and water.
- ▶ If fuel comes into contact with your eyes, immediately rinse them thoroughly with clean water. Seek medical attention immediately.
- ▶ If you swallow fuel, seek medical attention immediately. Do not induce vomiting.

- ▶ Change immediately out of clothing that has come into contact with fuel.

Flexible-fuel vehicles can be refueled with the following fuel types:

- premium-grade unleaded gasoline
- E85 fuel
- a mixture of E85 fuel and premium-grade unleaded gasoline

Flexible-fuel vehicles can be identified by the **Ethanol up to E85** sticker on the inside of the fuel filler flap.

Depending on the country, the fuels you can use in your vehicle may differ from the information in the Operator's Manual. The fuels that have been approved for your vehicle can be found on the instruction label on the inside of the fuel filler flap.

## Fuel

### Information on fuel quality for vehicles with gasoline engines

Observe the notes on operating fluids (→ page 447).

#### **!** NOTE Damage caused by the wrong fuel

Even small amounts of the wrong fuel could result in damage to the fuel system, the engine and the emission control system.

- ▶ Refuel only with low-sulfur spark-ignition engine fuel.

This fuel may contain up to 10% ethanol by volume. Your vehicle is suitable for use with E10 fuel.

Never refuel with one of the following fuels:

- diesel
- gasoline with more than 10% ethanol by volume, e.g. E15, E85, E100
- gasoline with more than 3% methanol by volume, e.g. M15, M30, M85, M100

- gasoline with metallic additives

If you have accidentally refueled with the wrong fuel:

- ▶ Do not switch on the vehicle.
- ▶ Consult a qualified specialist workshop.

If the available fuel is not sufficiently low in sulfur, it may produce unpleasant odors.

Only refuel with fuel that has at least the octane number specified in the information label in the fuel filler flap (→ page 193).

Never refuel using gasoline with an even lower RON.

#### **!** NOTE Premature engine wear through unleaded regular gasoline

Impairment of the longevity and performance of the engine.

If unleaded premium grade gasoline is unavailable and you have to refuel using unleaded regular gasoline:

- ▶ Only fill the fuel tank to half full with unleaded regular gasoline and refill as soon as possible with unleaded premium grade gasoline.
- ▶ Do not drive at the maximum design speed.
- ▶ Avoid sudden acceleration and engine speeds over 3000 rpm.

Further information on fuel is available in the following locations:

- At a gas station
- At a qualified specialist workshop
- On the <https://www.mbusa.com> (USA only)

### Information on additives in gasoline (vehicles with gasoline engine)

Observe the notes on operating fluids (→ page 447).

**!** **NOTE** Damage from use of unsuitable additives

Even small amounts of the wrong additive may lead to malfunctions occurring.

- ▶ Only add cleaning additives recommended by Mercedes-Benz to the fuel.

Mercedes-Benz recommends that you use brand-name fuels with additives.

In some countries, the fuel available may not have sufficient additives. Deposits could build up in the fuel injection system as a result. In this case, in consultation with a qualified specialist workshop (e.g. an authorized Mercedes-Benz Service Center), mix the fuel with the cleaning additive recommended by Mercedes-Benz. Observe the notes and mixing ratios indicated on the tank.

### ■ Tank content and fuel reserve

#### Total fuel tank capacity

Model	Total capacity
GLC 300 4MATIC	16.4 gal (62.0 liters)

#### Fuel tank reserve

Model	of which reserve fuel
GLC 300 4MATIC	1.8 gal (7.0 liters)

#### Engine oil

##### ■ Notes on engine oil

Observe the notes on operating fluids (→ page 447).



**!** **NOTE** Engine damage caused by an incorrect oil filter, incorrect oil or additives

- ▶ Do not use engine oils or oil filters other than those which meet the specifications necessary for the prescribed service intervals.
- ▶ Do not alter the engine oil or oil filter in order to achieve longer change intervals than prescribed.
- ▶ Do not use additives.
- ▶ Have the engine oil changed after the prescribed intervals.

Mercedes-Benz recommends having the oil changed at a qualified specialist workshop.

Only use engine oils approved for your vehicle by Mercedes-Benz.

## ■ Engine oil quality and filling capacity

### Engine oil specification

Model	MB-Freigabe or MB-Approval
GLC 300 4MATIC	229.71, 229.72

Use only the SAE 0W-20 viscosity class engine oils.

1) Recommended for the lowest possible fuel consumption (lowest SAE viscosity class in each case; observe possible restrictions of the approved SAE viscosity classes).

To achieve the lowest possible fuel consumption, it is recommended to use the engine oil specifications marked in the table with the lowest SAE viscosity class. Observe any possible restrictions of the approved SAE viscosity classes.

### Engine oil filling capacity

Model	Capacity
GLC 300 4MATIC	6.3 US qt (6.0 liters)

The specified filling capacity refers to an oil change with the oil filter.

### Notes on brake fluid

Observe the notes on operating fluids (→ page 447).

**⚠ WARNING** Risk of an accident due to vapor pockets forming in the brake system

The brake fluid constantly absorbs moisture from the air. This lowers the boiling point of the brake fluid. If the boiling point is too low, vapor pockets may form in the brake system when the brakes are applied hard.

This causes the braking effect to be impaired.

- ▶ Have the brake fluid renewed at the specified intervals.

Have the brake fluid regularly replaced at a qualified specialist workshop.

Only use a brake fluid approved by Mercedes-Benz according to MB-Freigabe or MB-Approval 331.0.

## Coolant

### ■ Notes on coolant

Observe the notes on operating fluids (→ page 447).

**⚠ WARNING** - Risk of fire and injury from antifreeze

If antifreeze comes into contact with hot component parts in the engine compartment, it may ignite.

- ▶ Allow the engine to cool down before adding antifreeze.
- ▶ Make sure that no antifreeze spills out next to the filler opening.
- ▶ Thoroughly clean off any antifreeze from component parts before starting the vehicle.

**! NOTE** Damage caused by incorrect coolant

- ▶ Only use coolant that has been premixed with the required antifreeze protection.

Information on coolant is available at the following locations:

- In the Mercedes-Benz Specification for Operating Fluids 320.1
  - At <https://operatingfluids.mercedes-benz.com>
- At a qualified specialist workshop

**!** **NOTE** Overheating at high outside temperatures

If an inappropriate coolant is used, the cooling system is not sufficiently protected against overheating and corrosion at high outside temperatures.

- ▶ Only use coolant approved for Mercedes-Benz.
- ▶ Observe the instructions in the Mercedes-Benz Specifications for Operating Fluids 320.1.

Have the coolant regularly replaced at a qualified specialist workshop.

Proportion of antifreeze concentrate in the cooling system:

- A minimum of 50% (antifreeze protection down to about -35°F (-37°C))
- A maximum of 55% (antifreeze protection down to -49°F (-45°C))

### ■ Coolant filling capacity

Engine cooling circuit (filling capacity with heating)

Model	Capacity
GLC 300 4MATIC	14.8 US qt (14.0 liters)

### Notes on windshield washer fluid

Observe the notes on operating fluids (→ page 447).

**!** **WARNING** - Risk of fire and injury from windshield washer concentrate

Windshield washer concentrate is highly flammable. It could ignite if it comes into contact with hot engine component parts or the exhaust system.

- ▶ Make sure that no windshield washer concentrate spills out next to the filler opening.

**!** **NOTE** Damage to the exterior lighting due to unsuitable windshield washer fluid

Unsuitable windshield washer fluid may damage the plastic surface of the exterior lighting.

- ▶ Only use windshield washer fluid which is also suitable for use on plastic surfaces, e.g. MB SummerFit or MB WinterFit.

**!** **NOTE** Blocked spray nozzles caused by mixing windshield washer fluids

▶ Do not mix MB SummerFit and MB WinterFit with other windshield washer fluids.

Do not use distilled or de-ionised water. Otherwise, the fill level sensor may be triggered erroneously.

Recommended windshield washer fluid:

- Above freezing point: e.g. MB SummerFit
- Below freezing point: e.g. MB WinterFit

For the correct mixing ratio, refer to the information on the antifreeze container.

Mix washing water with windshield washer fluid all year round.

## Refrigerant

### Notes on refrigerant

Observe the notes on operating fluids (→ page 447).

**!** **NOTE** Damage due to incorrect refrigerant

If a non-approved refrigerant is used, the climate control system may be damaged.

▶ Use only R-1234yf refrigerant.

**!** **NOTE** Damage to the climate control system due to incorrect refrigerant compressor oil

- ▶ Only use refrigerant compressor oil that has been approved by Mercedes-Benz.
- ▶ Do not mix the approved refrigerant compressor oil with a different refrigerant compressor oil.

Work on the climate control system may be carried out only at a qualified specialist workshop. All applicable regulations, as well as SAE standard J639, must be adhered to.

The information label for the climate control system regarding the refrigerant type and the refrigerant compressor oil (PAG oil) is located on the inside of the hood.

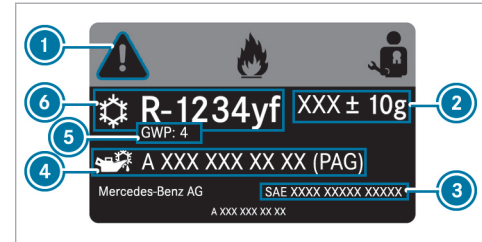

Information label

- ① Hazard and service warning symbols
- ② Refrigerant filling capacity
- ③ Applicable standards
- ④ PAG oil part number
- ⑤ GWP (Global Warming Potential) of the refrigerant used
- ⑥ Refrigerant type

Symbols ① indicate the following:

- Possible dangers
- Maintenance work to be carried out at a qualified specialist workshop

## Filling capacity for refrigerant and PAG oil

### Refrigerant filling capacity

Model	
GLC 300 4MATIC	21.2 ± 0.4 oz (600 ± 10 g)

### Filling capacity for PAG oil

Model	
GLC 300 4MATIC	2.8 ± 0.4 oz (80 ± 10 g)

## Vehicle data

### Vehicle dimensions

The heights specified may vary as a result of the following factors:

- Tires
- Load
- Condition of the suspension
- Optional equipment

### Vehicle dimensions

GLC 300 4MATIC	
Vehicle length	187.6 in (4764 mm)
Vehicle width including exterior mirrors	81.7 in (2076 mm)
Vehicle height	64.0 in (1625 mm)
Wheelbase	113.7 in (2888 mm)
Turning radius	38.71 ft (11.8 m)
Maximum ground clearance	8.1 in (207 mm)
Minimum ground clearance	7.1 in (180 mm)

### Weights and loads

Bear in mind that items of optional equipment increase the curb weight and reduce the payload. Vehicle-specific weight information can be found on the vehicle identification plate.

### Off-road driving

Also observe the notes on driving off-road, ascents and fording water (→ page 175).

### Fording water

**!** **NOTE** Damage caused by water when fording

Water can enter the engine compartment and vehicle interior in the following cases:

- The maximum permissible fording depth is exceeded when traveling through standing water.
  - A bow wave forms during fording.
  - Water accumulates when fording.
- ▶ Do not exceed the maximum permissible fording depth.
- ▶ Drive slowly through water.
- ▶ When driving through flowing water, be aware that the permissible fording depth is lower due to the accumulation of water.



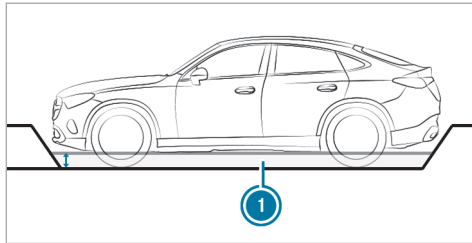

The maximum permissible fording depth ① in ready-to-drive loading condition is 11.8 in (30 cm).

Ready-to-drive loading means:

- Full fuel tank
- All fluids are topped up
- With driver

#### Notes on the angle of approach/departure

The specified values are maximum values for vehicles that are in roadworthy condition.

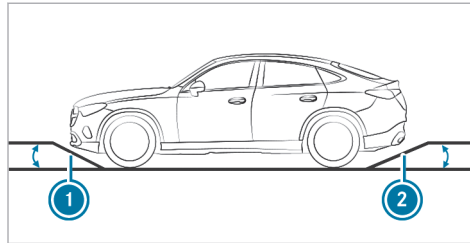

#### Angle of approach/departure

Model	① front	② Rear
GLC 300 4MATIC	22.6°	22.3°

#### Trailer hitch

##### General notes on the trailer hitch

Modifications to the cooling system may be necessary, depending on the vehicle model. Retrofitting a trailer hitch is permissible only if a trailer load is specified in your vehicle documents.

Further information can be obtained at a qualified specialist workshop.

Observe the information and notes on the trailer hitch (→ page 296).

#### Mounting dimensions

Missing values were not available at time of going to print.

#### Overhang dimension length

Model	
GLC 300 4MATIC	

#### Towing capacity

① The drawbar load is not included in the towing capacity.

The values for the **trailer load, braked** apply with a minimum start-off gradeability of 12 %.

Missing values were not available at time of going to print.

**Towing capacity, braked****Model**

GLC 300 4MATIC

**Towing capacity, unbraked****Model**

GLC 300 4MATIC

**Maximum trailer hitch tongue weight -and load capacity**

**!** NOTE Damage caused by the trailer coming loose

If the tongue weight used is too low, the trailer may come loose.

- ▶ The tongue weight must not be below 110.2 lbs (50 kg).
- ▶ Use a tongue weight that is as close as possible to the maximum permissible tongue weight.

**!** NOTE Damage caused by the bicycle rack coming loose

When using a bicycle rack, both the maximal tongue weight and the maximal load capacity should be observed.

- ▶ Do not exceed the permissible load capacity.

Missing values were not available at time of going to print.

**Tongue weight**

Model	Maximum tongue weight
GLC 300 4MATIC	

**Load capacity**

Model	Maximum load
GLC 300 4MATIC	

**Gross axle weight rating for the rear axle (trailer operation)**

Missing values were not available at time of going to print.

**Axle load when towing trailer**

Model	Axle load
GLC 300 4MATIC	

## Display messages

### Introduction



#### Information about display messages



Display messages appear on the driver's display.

Display messages with graphical symbols are simplified in the Operator's Manual and may differ from the symbols on the driver's display. The driver's display shows high-priority display messages in red. Certain display messages are accompanied by a warning tone.

Please act in accordance with the display messages and follow the additional notes in the Operator's Manual.

For some display messages, symbols will also be shown:

-  Further information
-  Hide display message

With the left-hand Touch Control, you can select the respective symbol by swiping to the left or right. Pressing  displays further information on the central display. Press the  symbol to hide the display message.

Display messages to be acknowledged can be hidden by pressing the back button  or with the left-hand Touch Control. The display messages will then be stored in the message memory.

Rectify the cause of a display message as quickly as possible.

High-priority display messages cannot be hidden. The driver's display will show these display messages continuously until the cause of the display message has been rectified.

#### Calling up saved display messages

Driver's display:

##### Service

The **Message Memory: XX** message appears on the driver's display.

- ▶ Scroll through the display messages by swiping upwards or downwards on the left-hand Touch Control.
- ▶ **To exit the display:** press the  back button.

## Occupant safety

Display messages	Possible causes/consequences and ► Solutions
 <p data-bbox="144 381 413 433">Restraint System Malfunction Service Required</p>	<p data-bbox="476 288 1005 314">* The restraint system is malfunctioning (→ page 42).</p> <div data-bbox="500 332 1646 449" style="border: 1px solid gray; padding: 5px;"> <p data-bbox="506 339 1212 366"><b>▲ WARNING</b> Risk of injury due to malfunctions in the restraint system</p> <p data-bbox="513 381 1578 408">Components in the restraint system may be activated unintentionally or not deploy as planned in an accident.</p> <ul data-bbox="513 415 1474 442" style="list-style-type: none"> <li data-bbox="513 415 1474 442">▶ Have the restraint system checked and repaired immediately at a qualified specialist workshop.</li> </ul> </div> <p data-bbox="495 467 635 494"><b>Plug-in hybrid:</b></p> <div data-bbox="500 508 1646 746" style="border: 1px solid gray; padding: 5px;"> <p data-bbox="506 519 1193 545"><b>▲ DANGER</b> Risk of death due to the restraint system malfunctioning</p> <p data-bbox="513 560 1609 608">Components in the restraint system may be activated unintentionally or not deploy as intended in an accident. In the event of an accident, the high-voltage on-board electrical system may not be deactivated as intended.</p> <p data-bbox="513 622 1600 670">You may receive an electric shock if you touch the damaged components of the high-voltage on-board electrical system.</p> <ul data-bbox="513 681 1474 739" style="list-style-type: none"> <li data-bbox="513 681 1474 708">▶ Have the restraint system checked and repaired immediately at a qualified specialist workshop.</li> <li data-bbox="513 715 1060 739">▶ After an accident, switch off the vehicle immediately.</li> </ul> </div>

## Display messages



Front Left Malfunction  
Service Required (Example)

## Possible causes/consequences and ► Solutions

\* The restraint system is malfunctioning (→ page 42).

**⚠ WARNING** Risk of injury due to malfunctions in the restraint system

Components in the restraint system may be activated unintentionally or not deploy as planned in an accident.

- Have the restraint system checked and repaired immediately at a qualified specialist workshop.

**Plug-in hybrid:****⚠ DANGER** Risk of death due to the restraint system malfunctioning

Components in the restraint system may be activated unintentionally or not deploy as intended in an accident. In the event of an accident, the high-voltage on-board electrical system may not be deactivated as intended.

You may receive an electric shock if you touch the damaged components of the high-voltage on-board electrical system.

- Have the restraint system checked and repaired immediately at a qualified specialist workshop.
- After an accident, switch off the vehicle immediately.

Display messages	Possible causes/consequences and ► Solutions
 <p data-bbox="144 342 391 420">Left Window Airbag Malfunction Service Required (Example)</p>	<p data-bbox="476 249 1001 275">* The restraint system is malfunctioning (→ page 42).</p> <div data-bbox="500 291 1646 436" style="border: 1px solid gray; padding: 5px;"> <p data-bbox="506 298 1411 327"><b>▲ WARNING</b> Risk of injury or fatal injury due to a malfunction in the window curtain airbag</p> <p data-bbox="506 339 1578 389">The window curtain airbag might be triggered unintentionally or might not be triggered at all in the event of an accident.</p> <p data-bbox="506 401 1530 426">► Have the window curtain airbag checked and repaired immediately at a qualified specialist workshop.</p> </div>
<p data-bbox="144 453 426 526">Front Passenger Airbag Disabled See Operator's Manual</p>	<p data-bbox="476 453 1646 526">* The front passenger air bag and the front passenger knee air bag have been disabled even though an adult or a person of adult build is on the front passenger seat. If additional forces are applied to the seat, the weight the system detects may be too low.</p> <div data-bbox="500 541 1646 749" style="border: 1px solid gray; padding: 5px;"> <p data-bbox="506 549 1319 578"><b>▲ WARNING</b> Risk of injury or fatal injury due to a disabled front passenger airbag</p> <p data-bbox="506 590 1633 640">If the front passenger airbag is disabled, the front passenger airbag will not be deployed in the event of an accident and cannot perform its intended protective function.</p> <p data-bbox="506 652 1604 702">A person in the front passenger seat could then, for example, come into contact with the vehicle's interior, especially if the person is sitting too close to the cockpit.</p> <p data-bbox="506 714 1541 739">► Make sure, both before and during the journey, that the status of the front passenger airbag is correct.</p> </div> <ul data-bbox="495 767 1304 866" style="list-style-type: none"> <li data-bbox="495 767 1215 792">► Stop the vehicle immediately in accordance with the traffic conditions.</li> <li data-bbox="495 800 1215 825">► Make sure that no objects are trapped under the front passenger seat.</li> <li data-bbox="495 833 1304 866">► Check the status of the automatic front passenger air bag shutoff (→ page 44).</li> </ul>

Display messages	Possible causes/consequences and ► Solutions
<p>Front Passenger Airbag Enabled See Operator's Manual</p>	<p>► If necessary, consult a qualified specialist workshop immediately.</p> <p>* The front passenger air bag and the front passenger knee air bag will be enabled while the vehicle is in motion in the following situations:</p> <ul style="list-style-type: none"> <li>• even when a child, a small adult or an object weighing less than the system weight threshold is located on the front passenger seat</li> <li>• even when the front passenger seat is not occupied</li> </ul> <p>The system may detect objects or forces that are adding to the weight applied to the seat.</p> <div style="border: 1px solid black; padding: 5px; margin: 10px 0;"> <p><b>⚠ WARNING</b> Risk of injury or death when using a child restraint system while the front passenger airbag is enabled</p> <p>If you secure a child in a child restraint system on the front passenger seat and the front passenger airbag is enabled, the front passenger airbag can deploy in the event of an accident. The child could be struck by the airbag.</p> <p>► Ensure, both before and during the journey, that the status of the front passenger airbag is correct.</p> <p>NEVER use a rearward facing child restraint on a seat protected by an ACTIVE AIRBAG in front of it, DEATH or SERIOUS INJURY to the CHILD can occur.</p> </div> <p>► Stop the vehicle immediately in accordance with the traffic conditions.</p> <p>► Make sure that no objects are trapped under the front passenger seat.</p>



## 462 Display messages and warning/indicator lamps



Display messages	Possible causes/consequences and ► Solutions
	<ul style="list-style-type: none"><li>► Check the status of the automatic front passenger air bag shutoff (→ page 44).</li><li>► If necessary, consult a qualified specialist workshop immediately.</li></ul>
Occupant Presence Reminder Inoperative	<ul style="list-style-type: none"><li>* The occupant presence reminder is malfunctioning</li><li>► Consult a qualified specialist workshop.</li></ul>
 <p>Do Not Leave People or Animals in the Vehicle</p>	<ul style="list-style-type: none"><li>* The occupant presence reminder suspects that there are persons or animals in the rear passenger compartment of the vehicle.</li><li>► Do not leave any persons or animals behind when leaving the vehicle.</li></ul>

## SmartKey

Display messages	Possible causes/consequences and ► Solutions
 <p>Obtain a New Key</p>	<ul style="list-style-type: none"><li>* Have the key replaced.</li><li>► Consult a qualified specialist workshop.</li></ul>



Display messages	Possible causes/consequences and ► Solutions
 <p data-bbox="194 336 397 367">Replace Key Battery</p>	<p data-bbox="517 248 831 274">* The key battery is discharged.</p> <ul style="list-style-type: none"> <li data-bbox="545 279 914 305">► Replace the battery (→ page 73).</li> </ul>
 <p data-bbox="194 481 443 533">Key Not Detected (white display message)</p>	<p data-bbox="517 393 859 419">* The key is currently undetected.</p> <ul style="list-style-type: none"> <li data-bbox="545 424 1016 450">► Change the location of the key in the vehicle.</li> <li data-bbox="545 455 803 481">► Try to start the vehicle.</li> <li data-bbox="545 486 1432 518">► If the key is still not detected, place it in the slot for starting with the key (→ page 167).</li> <li data-bbox="545 523 748 549">► Start the vehicle.</li> </ul>
 <p data-bbox="194 657 462 709">Key Not Detected (red display message)</p>	<p data-bbox="517 569 1404 595">* The key can no longer be detected during a journey and may no longer be in the vehicle.</p> <p data-bbox="545 600 1191 626">If the key is no longer in the vehicle and you switch off the vehicle:</p> <ul style="list-style-type: none"> <li data-bbox="545 631 924 657">• You can no longer start the vehicle.</li> <li data-bbox="545 663 942 688">• You cannot centrally lock the vehicle.</li> </ul> <ul style="list-style-type: none"> <li data-bbox="545 709 933 735">► Ensure that the key is in the vehicle.</li> </ul> <p data-bbox="545 761 1034 787">If the key is in the vehicle and is still not detected:</p> <ul style="list-style-type: none"> <li data-bbox="545 792 1265 818">► Stop the vehicle immediately in accordance with the traffic conditions.</li> <li data-bbox="545 823 1312 854">► Place the key in the slot for starting the engine with the key (→ page 167).</li> </ul>

Display messages	Possible causes/consequences and ► Solutions
	<p>The key battery is weak or discharged.</p> <ul style="list-style-type: none"><li>► Check the battery using the indicator lamp (→ page 71).</li><li>► Replace the key battery, if necessary (→ page 73).</li></ul>
 <p>Initializing Key Please Wait</p>	<ul style="list-style-type: none"><li>* The vehicle is processing in order to teach in the new key.<ul style="list-style-type: none"><li>► Wait until processing is complete.</li></ul></li></ul>
 <p>Don't Forget Your Key</p>	<ul style="list-style-type: none"><li>* A warning tone will also sound. This message reminds you to take your key with you when you leave the vehicle.</li></ul>
<p>Place the Key in the Marked Space See Operator's Manual</p>	<ul style="list-style-type: none"><li>* Key detection is malfunctioning.<ul style="list-style-type: none"><li>► Change the location of the key in the vehicle.</li><li>► Place the key in the slot for starting the engine with the key (→ page 167).</li></ul></li></ul>

Display messages	Possible causes/consequences and ► Solutions
<p>Searching for Key in Stowage Tray or Digital Vehicle Key in Inductive Charging Bracket... See Operator's Manual</p>	<ul style="list-style-type: none"> <li>* The key was not detected.               <ul style="list-style-type: none"> <li>► Place the key in the storage compartment (→ page 167).</li> </ul> <p>If the key is still not detected:</p> <ul style="list-style-type: none"> <li>► Consult a qualified specialist workshop.</li> </ul> </li> <li>* The Digital Vehicle Key has not been detected.               <ul style="list-style-type: none"> <li>► Place the Digital Vehicle Key in the stowage space (→ page 167).</li> </ul> <p>If the Digital Vehicle Key is still not detected:</p> <ul style="list-style-type: none"> <li>► Consult a qualified specialist workshop.</li> </ul> </li> </ul>
<div data-bbox="205 563 362 647" data-label="Image"> </div> <p>Key Not Detected</p>	<ul style="list-style-type: none"> <li>* The SmartKey or the Digital Vehicle Key is currently undetected.               <ul style="list-style-type: none"> <li>► Change the location of the SmartKey or the Digital Vehicle Key in the vehicle.</li> <li>► Try to start the vehicle.</li> <li>► If the SmartKey is still not detected, place the SmartKey in the marked space (→ page 167).</li> <li>► If the Digital Vehicle Key is still not detected, place the Digital Vehicle Key in the marked space (→ page 167).</li> <li>► Start the vehicle.</li> </ul> </li> </ul>

## Display messages



Key Not Detected Place  
Digital Vehicle Key in  
Mobile Phone Cradle

## Possible causes/consequences and ► Solutions

\* The SmartKey or the Digital Vehicle Key are no longer detected during a journey and may no longer be in the vehicle.

If the SmartKey or the Digital Vehicle Key is no longer in the vehicle and you switch off the vehicle:

- You can no longer start the vehicle.
- You cannot centrally lock the vehicle.

► Ensure that the SmartKey or the Digital Vehicle Key is in the vehicle.

If the SmartKey or the Digital Vehicle Key is in the vehicle and is still not detected:

- Stop the vehicle immediately in accordance with the traffic conditions.
- Place the SmartKey in the marked space (→ page 167).
- Place the Digital Vehicle Key in the stowage space (→ page 167).

The SmartKey battery is weak or discharged.



- Check the battery using the indicator lamp (→ page 71).
- Replace the SmartKey battery, if necessary (→ page 73).



The condition of charge of the rechargeable battery of the end device with the Digital Vehicle Key is too low.

- Immediately charge the rechargeable battery of the Digital Vehicle Key end device.

Otherwise, it may not be possible to restart the vehicle after it has been switched off.





If the SmartKey or the Digital Vehicle Key is still not detected:

Display messages	Possible causes/consequences and ► Solutions
 <p data-bbox="194 383 425 429">Replace SmartKey See Operator's Manual</p>	<ul style="list-style-type: none"> <li data-bbox="545 248 960 274">► Consult a qualified specialist workshop.</li> <li data-bbox="526 290 1432 315">* If the Digital Vehicle Key is not renewed, the vehicle cannot be unlocked/locked or started.               <ul style="list-style-type: none"> <li data-bbox="545 326 1136 352">► The system automatically renews the Digital Vehicle Key.</li> <li data-bbox="545 352 1561 378">► When the renewal is complete, the message disappears and the Digital Vehicle Key is available again.</li> </ul> </li> </ul>
 <p data-bbox="194 549 443 574">Take SmartKey With You</p>	<ul style="list-style-type: none"> <li data-bbox="526 461 1690 507">* A warning tone will also sound. This message reminds you to take your SmartKey with you when you leave the vehicle. This also applies to the Digital Vehicle Key.</li> </ul>
 <p data-bbox="194 694 462 740">Digital Vehicle Key Charge Device</p>	<ul style="list-style-type: none"> <li data-bbox="526 600 1598 626">* The condition of charge of the rechargeable battery of the end device with the Digital Vehicle Key is too low.               <ul style="list-style-type: none"> <li data-bbox="545 631 1386 657">► Immediately charge the rechargeable battery of the Digital Vehicle Key end device.</li> </ul> </li> </ul>

Display messages	Possible causes/consequences and ► Solutions
 <p data-bbox="144 339 415 365">Initializing Key Please Wait</p>	<ul style="list-style-type: none"> <li>* The vehicle is processing in order to teach in the new Digital Vehicle Key.                             <ul style="list-style-type: none"> <li>► Wait until processing is complete.</li> </ul> </li> </ul>
 <p data-bbox="144 479 386 529">Key Does Not Belong to Vehicle</p>	<ul style="list-style-type: none"> <li>* The vehicle cannot be unlocked/locked or started.                             <ul style="list-style-type: none"> <li>► Use the Digital Vehicle Key belonging to the vehicle.</li> </ul> </li> </ul>

## Lights

Display messages	Possible causes/consequences and ► Solutions
 <p data-bbox="144 774 304 824">Check Left Low Beam (example)</p>	<ul style="list-style-type: none"> <li>* The corresponding light source is malfunctioning.                             <ul style="list-style-type: none"> <li>► Drive on carefully.</li> <li>► Consult a qualified specialist workshop immediately.</li> </ul> </li> <li>ⓘ LED light sources: the display message for the corresponding light appears only when all the light-emitting diodes in the light are faulty.</li> </ul>



Display messages	Possible causes/consequences and ► Solutions
 <p data-bbox="194 341 443 393">Malfunction See Operator's Manual</p>	<p data-bbox="517 248 924 274">* The exterior lighting is malfunctioning.</p> <ul data-bbox="545 279 970 310" style="list-style-type: none"> <li data-bbox="545 279 970 310">► Consult a qualified specialist workshop.</li> </ul>
 <p data-bbox="194 507 443 559">Automatic Driving Lights Inoperative</p>	<p data-bbox="517 419 1145 445">* The light sensor for automatic driving lights is malfunctioning.</p> <ul data-bbox="545 450 970 481" style="list-style-type: none"> <li data-bbox="545 450 970 481">► Consult a qualified specialist workshop.</li> </ul>
 <p data-bbox="194 673 415 704">Switch On Headlights</p>	<p data-bbox="517 585 988 611">* You are driving without low-beam headlamps.</p> <ul data-bbox="545 616 1081 647" style="list-style-type: none"> <li data-bbox="545 616 1081 647">► Turn the light switch to the  or <b>AUTO</b> position.</li> </ul>
 <p data-bbox="194 813 369 844">Switch Off Lights</p>	<p data-bbox="517 725 1155 751">* You are leaving the vehicle and the lights are still switched on.</p> <ul data-bbox="545 756 988 787" style="list-style-type: none"> <li data-bbox="545 756 988 787">► Turn the light switch to the <b>AUTO</b> position.</li> </ul>

Display messages	Possible causes/consequences and ► Solutions
DIGITAL LIGHT Functions Limited	<p>* The DIGITAL LIGHT system is malfunctioning. The lighting system will continue to work even without the functions of the DIGITAL LIGHT system.</p> <p>► Consult a qualified specialist workshop.</p>
Adaptive Highbeam Assist Currently Unavailable See Operator's Manual	<p>* Adaptive Highbeam Assist is temporarily unavailable. The system limits have been reached (→ page 139). Once the cause of the problem is no longer present, the system will be available again. The <a href="#">Adaptive Highbeam Assist Now Available</a> display message will appear.</p> <p>► Drive on.</p> <p>► Operate the high beam manually until Adaptive Highbeam Assist is available again.</p>
Adaptive Highbeam Assist Inoperative	<p>* Adaptive Highbeam Assist is malfunctioning.</p> <p>► Drive on or</p> <p>► Stop the vehicle in accordance with the traffic conditions and restart the vehicle.</p> <p>► If the display message does not disappear: consult a qualified specialist workshop.</p> <p>► Until then, operate the high beam manually.</p>
Adaptive Highbeam Assist Plus Currently Unavailable See Operator's Manual	<p>* Adaptive Highbeam Assist Plus is temporarily unavailable. The system limits have been reached (→ page 140). Once the cause of the problem is no longer present, the system will be available again. The <a href="#">Adaptive Highbeam Assist Plus Now Available</a> display message will appear.</p>



Display messages	Possible causes/consequences and ► Solutions
	<ul style="list-style-type: none"> <li>► Drive on.</li> <li>► Operate the high beam manually until Adaptive Highbeam Assist Plus is available again.</li> </ul>
Adaptive Highbeam Assist Plus Inoperative	<p>* Adaptive Highbeam Assist Plus is malfunctioning.</p> <ul style="list-style-type: none"> <li>► Drive on.</li> </ul> <p>or</p> <ul style="list-style-type: none"> <li>► Stop the vehicle in accordance with the traffic conditions and restart the vehicle.</li> <li>► If the display message does not disappear: consult a qualified specialist workshop.</li> <li>► Until then, operate the high beam manually.</li> </ul>
Hazard Warning Light Malfunction	<p>* The hazard warning lamp switch is malfunctioning.</p> <ul style="list-style-type: none"> <li>► Consult a qualified specialist workshop.</li> </ul>



Climate control

Display messages	Possible causes/consequences and ► Solutions
 <p data-bbox="144 381 421 461">Currently Not Available Charging of the High-voltage Battery Not Completed</p>	<p data-bbox="473 288 1326 313">* The high-voltage battery is charging. Pre-entry climate control cannot be switched on.</p> <ul style="list-style-type: none"> <li data-bbox="495 322 1276 348">► Wait until the charging process has achieved a minimum condition of charge.</li> </ul>
 <p data-bbox="144 578 399 657">Currently Not Available Charge High-voltage Bat- tery</p>	<p data-bbox="473 484 1448 510">* The charge of the high-voltage battery is too low. Pre-entry climate control cannot be switched on.</p> <ul style="list-style-type: none"> <li data-bbox="495 519 986 544">► Charge the high-voltage battery (→ page 196).</li> </ul>
 <p data-bbox="144 774 408 854">Pre-entry Climate Control Available Again via Smart- Key after Vehicle Start</p>	<p data-bbox="473 681 1511 707">* You have attempted to switch on pre-entry climate control more than twice with the vehicle switched off.</p> <ul style="list-style-type: none"> <li data-bbox="495 715 975 767">► Start the vehicle for ten seconds. Pre-entry climate control is operational again.</li> </ul>

Display messages	Possible causes/consequences and ► Solutions
 <p data-bbox="194 341 471 445">Pre-entry Climate Control via SmartKey Currently Not Available. High-voltage Battery Low</p>	<ul style="list-style-type: none"><li data-bbox="526 248 1496 274">* The charge of the high-voltage battery is too low. Pre-entry climate control cannot be switched on.<ul style="list-style-type: none"><li data-bbox="545 279 1589 336">► Charge the high-voltage battery (→ page 196). When the high-voltage battery is sufficiently charged, pre-entry climate control will be operational again.</li></ul></li></ul>



### Drive system

Display messages	Possible causes/consequences and ► Solutions
 <p data-bbox="194 688 462 740">Towing Not Permitted See Operator's Manual</p>	<ul style="list-style-type: none"><li data-bbox="526 595 1339 657">* The drive system is malfunctioning.<ul style="list-style-type: none"><li data-bbox="545 626 1339 657">► Have the vehicle transported only using a transporter or trailer (→ page 404).</li></ul></li></ul>

Display messages	Possible causes/consequences and ► Solutions
 <p data-bbox="144 342 408 391">Acoustic Presence Indicator Inoperative</p>	<ul style="list-style-type: none"> <li>* The sound generator (acoustic vehicle warning system) is malfunctioning. No vehicle noises are being produced. The vehicle may not be heard by other road users.               <ul style="list-style-type: none"> <li>► Drive with particular care.</li> <li>► Consult a qualified specialist workshop.</li> </ul> </li> </ul>
 <p data-bbox="144 511 408 536">Charger Cable Connected</p>	<ul style="list-style-type: none"> <li>* You cannot pull away while the charging cable is connected.               <ul style="list-style-type: none"> <li>► Disconnect the charging cable from the vehicle.</li> </ul> </li> </ul>
<p data-bbox="144 557 408 632">Not Possible to Unlock Charging Cable See Operator's Manual</p>	<ul style="list-style-type: none"> <li>* The charging cable connector cannot be removed from the charging station's socket.               <ul style="list-style-type: none"> <li>► Press the EMERGENCY OFF switch on the charging station.</li> </ul> <p data-bbox="495 643 1092 668">If the charging cable connector cannot be removed after that:</p> <ul style="list-style-type: none"> <li>► Request service personnel from the operator of the charging station via the emergency call button or the emergency numbers attached to the charging station.</li> </ul> </li> </ul>
<p data-bbox="144 743 395 819">Vehicle Currently Not Charging... Charging Station Fault</p>	<ul style="list-style-type: none"> <li>* A malfunction has occurred in the charging station or the RFID card is not recognized.               <ul style="list-style-type: none"> <li>► Start the charging process at a different charging station.</li> <li>or</li> <li>► Have the RFID card checked to ensure it is functioning.</li> </ul> </li> </ul>

Display messages	Possible causes/consequences and ► Solutions
Charging Mode Currently Unavailable Try Again or Change Charging Mode	<ul style="list-style-type: none"> <li>* A temporary malfunction has occurred in the charging station.               <ul style="list-style-type: none"> <li>► Wait until the malfunction has passed.</li> <li>or</li> <li>► Start the charging process at a different charging station.</li> </ul> </li> </ul>
Charging Fault Change Charging Mode See Operator's Manual	<ul style="list-style-type: none"> <li>* A temporary malfunction has occurred in the charging station.               <ul style="list-style-type: none"> <li>► Wait until the malfunction has passed.</li> <li>or</li> <li>► Start the charging process at a different charging station.</li> </ul> </li> </ul>
AC Charging Inoperative Service Required	<ul style="list-style-type: none"> <li>* The charging process cannot be started due to a malfunction.               <ul style="list-style-type: none"> <li>► Consult a qualified specialist workshop.</li> </ul> </li> </ul>
DC Charging Inoperative Service Required	<ul style="list-style-type: none"> <li>* The charging process cannot be started due to a malfunction.               <ul style="list-style-type: none"> <li>► Consult a qualified specialist workshop.</li> </ul> </li> </ul>
Only Electric Drive Available Power Limited	<ul style="list-style-type: none"> <li>* The fuel tank is empty and the combustion engine is switched off. The output of your vehicle is limited because you are driving in electric mode.               <ul style="list-style-type: none"> <li>► Refuel immediately.</li> </ul> <p>Subsequently, there may be temporary restrictions in the availability of electric mode over a driving distance of 31 mi (50 km).</p> <p>If there is fuel in the vehicle, there is a malfunction with the combustion engine.</p> </li> </ul>



Display messages	Possible causes/consequences and ► Solutions
<p>"Electric" Drive Program Currently Unavailable</p>	<ul style="list-style-type: none"> <li>► Consult a qualified specialist workshop.</li> </ul> <p>* The state of charge of the high-voltage battery or the ambient conditions are not sufficient for the Electric drive program.</p> <ul style="list-style-type: none"> <li>► Drive on and observe the notes on plug-in hybrid operation (→ page 162).</li> <li>or</li> <li>► Charge the high-voltage battery (→ page 196).</li> </ul>
<p>Reduced Drive System Performance See Operator's Manual</p>	<p>* The drive system switches to emergency operation mode due to a malfunction.</p> <ul style="list-style-type: none"> <li>► Drive on carefully.</li> <li>► Consult a qualified specialist workshop.</li> </ul>
<p>Preparing Drive System...</p>	<p>* The insulation of the drive system is being tested. This process can last for up to ten seconds.</p>
<div style="border: 1px solid black; padding: 5px; width: fit-content;">  </div> <p>Battery Overheated Stop! Everyone Get Out! Outdoors if Possible</p>	<p>* <b>Plug-in hybrid:</b> the high-voltage battery has overheated. There is a risk of fire.</p> <ul style="list-style-type: none"> <li>► Stop the vehicle immediately in accordance with the traffic conditions.</li> <li>► If possible, stop the vehicle in the open air and ensure that all vehicle occupants get out.</li> <li>ⓘ Supporting vehicle functions may activate automatically, e.g. air-recirculation mode as part of climate control.</li> <li>► Do not continue driving.</li> <li>► If smoke is present, leave the danger zone and call the fire service immediately.</li> <li>► Consult a qualified specialist workshop even if there are no external signs of a fire.</li> </ul>

Display messages	Possible causes/consequences and ► Solutions
 <p data-bbox="194 336 323 362">Malfunction</p>	<ul style="list-style-type: none"> <li data-bbox="517 248 1201 274">* The drive system is malfunctioning. A warning tone will also sound.</li> <li data-bbox="545 279 970 305">► Consult a qualified specialist workshop.</li> </ul>
 <p data-bbox="194 481 397 533">Malfunction Service Required</p>	<ul style="list-style-type: none"> <li data-bbox="517 393 887 419">* The drive system is malfunctioning.</li> <li data-bbox="545 424 970 450">► Consult a qualified specialist workshop.</li> </ul>
 <p data-bbox="194 647 471 730">Have High-Voltage System Checked See Operator's Manual</p>	<ul style="list-style-type: none"> <li data-bbox="517 559 1081 585">* A function restriction has occurred in the drive system.</li> <li data-bbox="545 590 970 616">► Consult a qualified specialist workshop.</li> </ul>
<p data-bbox="194 751 471 828">Service Required Do Not Change Transmission Position</p>	<ul style="list-style-type: none"> <li data-bbox="517 756 1478 782">* The transmission is malfunctioning. It is no longer possible to change the transmission position.</li> <li data-bbox="545 787 1700 839">► If transmission position <b>D</b> is selected, consult a qualified specialist workshop and do not change the transmission position.</li> <li data-bbox="545 844 1155 870">► For all other transmission positions, park the vehicle safely.</li> </ul>

Display messages	Possible causes/consequences and ► Solutions
Do Not Restart Vehicle Service Required	<ul style="list-style-type: none"> <li>► Consult a qualified specialist workshop or breakdown service.</li> </ul> <p>* It is not possible to restart the drive system due to a malfunction.</p> <ul style="list-style-type: none"> <li>► Do not switch off the drive system; drive on to the nearest qualified specialist workshop.</li> </ul>
 <p>Drive Power and Range Reduced See Operator's Manual</p>	<p>* A malfunction has occurred in the high-voltage battery. Output and range will be severely restricted.</p> <ul style="list-style-type: none"> <li>► Switch the vehicle off and lock it.</li> <li>► After waiting for a short time, unlock the vehicle and start it again.</li> </ul> <p>If the display message appears again:</p> <ul style="list-style-type: none"> <li>► Drive on carefully.</li> <li>► Fully charge the high-voltage battery (→ page 196).</li> </ul> <p>If the output and range are still reduced, there is a malfunction in the drive system.</p> <ul style="list-style-type: none"> <li>► Drive on carefully.</li> <li>► Consult a qualified specialist workshop.</li> </ul>
Cannot Start Vehicle See Operator's Manual	<p>* It is not possible to start the vehicle. A malfunction has occurred in the drive system.</p> <ul style="list-style-type: none"> <li>► Switch the vehicle off and lock it.</li> <li>► After waiting for a short time, unlock the vehicle and start it again.</li> </ul>



Display messages	Possible causes/consequences and ► Solutions
<p>Drive Malfunction Achievable Speed Limited Stop Soon</p>	<ul style="list-style-type: none"> <li>► If the display message appears again and the vehicle does not start, consult a qualified specialist workshop.</li> </ul> <p>* The drive system is malfunctioning. The maximum vehicle speed is restricted. The drive system will shut off within a few kilometers.</p> <ul style="list-style-type: none"> <li>► Stop the vehicle immediately in accordance with the traffic conditions and switch off the drive system. Do not continue driving.</li> <li>► Do not tow the vehicle; stop towing if necessary.</li> <li>► Consult a qualified specialist workshop.</li> </ul>
<p>Drive Malfunction Achievable Speed Severely Limited See Operator's Manual</p>	<p>* The drive system is malfunctioning. The maximum vehicle speed is restricted.</p> <ul style="list-style-type: none"> <li>► Consult a qualified specialist workshop.</li> </ul>
<div data-bbox="205 607 362 687" data-label="Image"> </div> <p>Malfunction</p>	<p>* The drive system is malfunctioning. The output of your vehicle is restricted.</p> <ul style="list-style-type: none"> <li>► Consult a qualified specialist workshop.</li> </ul>
<div data-bbox="205 746 362 827" data-label="Image"> </div> <p>Stop Switch Off Vehicle</p>	<p>* The drive system is malfunctioning.</p> <ul style="list-style-type: none"> <li>► Stop the vehicle immediately in accordance with the traffic conditions and switch off the drive system. Do not continue driving.</li> <li>► Do not tow the vehicle; stop towing if necessary.</li> </ul>

Display messages	Possible causes/consequences and ► Solutions
 <p data-bbox="144 381 380 430">Performance Extremely Limited</p>	<ul style="list-style-type: none"> <li data-bbox="495 249 916 273">► Consult a qualified specialist workshop.</li> <li data-bbox="476 288 1646 436">* The drive system is outside the normal operating temperature range, e.g. due to extremely low or high outside temperatures. The output is severely restricted. Once the operating temperature of the drive system returns to normal, the full output will be available again. The display message will disappear.</li> <li data-bbox="476 446 1374 470">* If the drive system power output is still reduced, there is a malfunction in the drive system. <ul style="list-style-type: none"> <li data-bbox="495 480 704 504">► Drive on carefully.</li> <li data-bbox="495 514 916 538">► Consult a qualified specialist workshop.</li> </ul> </li> </ul>
 <p data-bbox="144 647 417 697">Please Wait Depressurizing Fuel Tank</p>	<ul style="list-style-type: none"> <li data-bbox="476 555 1624 605">* <b>Vehicles with gasoline engine:</b> The pressure in the fuel tank is reduced before the fuel filler flap is opened. This pressure reduction can take up to 15 minutes.</li> </ul>
 <p data-bbox="144 815 417 865">Fuel Tank Is Depressurized Ready for Refueling</p>	<ul style="list-style-type: none"> <li data-bbox="476 723 1465 746">* <b>Vehicles with gasoline engine:</b> The pressure in the fuel tank is released and the fuel filler flap opens.</li> </ul>

Display messages	Possible causes/consequences and ► Solutions
 <p data-bbox="194 341 452 388">Tank Ventilation Malfunction Service Required</p>	<ul style="list-style-type: none"> <li>* <b>Vehicles with gasoline engine:</b> There is a malfunction in the fuel system.               <ul style="list-style-type: none"> <li>► Consult a qualified specialist workshop.</li> </ul> </li> </ul>



## Vehicle



Display messages	Possible causes/consequences and ► Solutions
	<ul style="list-style-type: none"> <li>* The driver's display is inoperative due to a failed software update. The display message will be shown every time the engine is started.</li> </ul> <div style="background-color: #f0f0f0; padding: 5px; margin-top: 10px;"> <p><b>⚠ WARNING</b> Risk of accident if the driver display fails</p> <p>If the driver display has failed or is malfunctioning, function restrictions in systems relevant to safety cannot be detected.</p> <p>The operating safety of your vehicle may be impaired.</p> <ul style="list-style-type: none"> <li>► Drive on carefully.</li> <li>► Have the vehicle checked immediately at a qualified specialist workshop.</li> </ul> </div>

Display messages	Possible causes/consequences and ► Solutions
	<p>If the operating safety of your vehicle is impaired, park the vehicle immediately and safely. Contact a qualified specialist workshop.</p> <p><b>Plug-in hybrid:</b></p> <div data-bbox="495 344 1646 487" style="border: 1px solid gray; padding: 5px;"> <p><b>▲ WARNING</b> Risk of accident due to failure of the driver display</p> <p>In the event that the driver display fails or malfunctions, you will not recognize function restrictions affecting systems relevant to safety. This may impair operating safety.</p> <p>► Park the vehicle safely as soon as possible and notify a qualified specialist workshop.</p> </div> <p>If the driver's display fails, you may not recognize function restrictions affecting systems relevant to safety or the speed display, for example. The operating safety of the vehicle may be impaired (→ page 329).</p> <p>► Have the vehicle checked by a qualified specialist workshop immediately.</p>
<p>Cannot Start Vehicle See Operator's Manual</p>	<p>* The vehicle cannot be started.</p> <ul style="list-style-type: none"> <li>► Switch the vehicle off and switch it back on.</li> <li>► If the display message still appears, consult a qualified specialist workshop.</li> </ul> <p>* <b>Vehicles with 48 V on-board electrical system:</b> the state of charge of the 48 V battery is too low. You can no longer start the vehicle.</p> <ul style="list-style-type: none"> <li>► Switch off electrical consumers that are not required.</li> <li>► Connect a suitable charger approved for Mercedes-Benz with sufficient charging power to the jump-start connection point of the 12 V battery (→ page 401). The 48 V battery is charged via the voltage converter in the vehicle.</li> </ul>



Display messages	Possible causes/consequences and ► Solutions
<p>Vehicle Ready to Drive Shutdown Occurs When Locked or After a Few Minutes</p>	<ul style="list-style-type: none"> <li>* You are leaving the vehicle in a ready-to-drive state.               <ul style="list-style-type: none"> <li>► Get out of the vehicle, secure it against rolling away and take the key with you.</li> <li>► If you do not leave the vehicle, switch off the electrical consumers, e.g. the seat heating. Otherwise, the 12-V battery may discharge and starting the engine may be possible only with the help of a second battery (starting assistance).</li> </ul> </li> </ul>
<p>Vehicle Ready to Drive Shutdown Occurs When Locked or Automatically in XX Mins</p>	<ul style="list-style-type: none"> <li>* You are about to leave the vehicle and the engine is running. The vehicle will switch off automatically in 20 minutes.               <ul style="list-style-type: none"> <li>► To prevent the vehicle from switching off automatically, confirm the message in the central display of the multimedia system.</li> </ul> </li> <li>* You are in the vehicle. Park position <b>P</b> is engaged and the engine is running. After a certain time of being at a standstill, this display message will appear in the driver's display. The vehicle will then be automatically switched off after a total parked time of 20 minutes.               <ul style="list-style-type: none"> <li>► To prevent the vehicle from switching off automatically, confirm the message in the central display of the multimedia system.</li> </ul> </li> </ul>
<p>Head-up Display Currently Unavailable See Operator's Manual</p>	<ul style="list-style-type: none"> <li>* The head-up display is temporarily unavailable. Possible causes are:               <ul style="list-style-type: none"> <li>• malfunctions in the power supply</li> <li>• signal interference</li> </ul> <ul style="list-style-type: none"> <li>► Stop in accordance with the traffic conditions and switch the vehicle off and on again.</li> <li>► If the display message still appears, consult a qualified specialist workshop.</li> </ul> </li> </ul>



Display messages	Possible causes/consequences and ► Solutions
<p>Head-up Display Inoperative</p>	<p>* The head-up display has an internal error.</p> <ul style="list-style-type: none"> <li>► Consult a qualified specialist workshop.</li> </ul>
<p>Head-up Display Brightness Currently Reduced See Operator's Manual</p>	<p>* The brightness of the head-up display is reduced. Possible causes:</p> <ul style="list-style-type: none"> <li>• Dirt on the windshield in the camera's field of vision</li> <li>• Faulty exterior brightness signals</li> </ul> <ul style="list-style-type: none"> <li>► Switch on the windshield wipers.</li> <li>► Clean the windshield if necessary.</li> <li>► Switch the vehicle off and switch it back on</li> <li>► If the display message still appears, consult a qualified specialist workshop.</li> </ul>
 <p>Steering Malfunction Drive Carefully Service Required</p>	<p>* A power steering malfunction has occurred. Steering characteristics may be impaired as a result.</p> <ul style="list-style-type: none"> <li>► Drive on carefully.</li> <li>► Consult a qualified specialist workshop.</li> </ul>

Display messages	Possible causes/consequences and ► Solutions
 <p data-bbox="195 342 449 418">Steering Malfunction Increased Physical Effort See Operator's Manual</p>	<p data-bbox="524 249 1018 275">* The power steering assistance is malfunctioning.</p> <div data-bbox="550 291 1696 441" style="border: 1px solid gray; padding: 5px;"> <p data-bbox="559 298 1273 324"><b>▲ WARNING</b> Risk of an accident due to altered steering characteristics</p> <p data-bbox="559 339 1604 365">If the power assistance of the steering fails partially or completely, you will need to use more force to steer.</p> <ul style="list-style-type: none"> <li data-bbox="559 376 1036 401">▶ If safe steering is possible, drive on carefully.</li> <li data-bbox="559 407 1175 433">▶ Visit or consult a qualified specialist workshop immediately.</li> </ul> </div>
 <p data-bbox="195 550 460 625">Steering Malfunction Stop Immediately See Operator's Manual</p>	<p data-bbox="524 456 1267 482">* The steering is malfunctioning. Steering capability is significantly impaired.</p> <div data-bbox="550 498 1696 671" style="border: 1px solid gray; padding: 5px;"> <p data-bbox="559 505 1180 531"><b>▲ WARNING</b> Risk of accident if steering capability is impaired</p> <p data-bbox="559 547 1437 572">If the steering does not function as intended, the vehicle's operating safety is jeopardized.</p> <ul style="list-style-type: none"> <li data-bbox="559 583 1641 635">▶ Pull over and stop the vehicle safely as soon as possible, paying attention to road and traffic conditions. Do not continue driving under any circumstances.</li> <li data-bbox="559 645 981 671">▶ Consult a qualified specialist workshop.</li> </ul> </div>
 <p data-bbox="195 785 432 840">Rear Axle Steering Currently Malfunctioning</p>	<p data-bbox="524 692 1384 717">* The rear axle steering is temporarily unavailable. The turning circle may become wider.</p> <ul style="list-style-type: none"> <li data-bbox="543 728 1369 754">▶ Stop the vehicle in accordance with the traffic conditions and restart the vehicle.</li> </ul> <p data-bbox="543 780 962 806">If the display message does not disappear:</p> <ul style="list-style-type: none"> <li data-bbox="543 816 759 842">▶ Drive on carefully.</li> <li data-bbox="543 847 966 873">▶ Consult a qualified specialist workshop.</li> </ul>

Display messages	Possible causes/consequences and ► Solutions
 <p>Rear Axle Steering Malfunction Service Required</p>	<p>* The rear axle steering is malfunctioning. The rear axle has no steering capability. The steering wheel may be at an angle when you drive in a straight line.</p> <ul style="list-style-type: none"> <li>► Adapt your speed and drive on carefully.</li> <li>► Consult a qualified specialist workshop immediately.</li> </ul>
 <p>Rear Axle Steering Malfunction Stop Immediately</p>	<p>* The rear axle steering is malfunctioning. The rear axle has no steering capability. The steering wheel may be tilted considerably when you drive in a straight line. Depending on the steering wheel's tilted position, the steering wheel will also vibrate and a continuous warning tone will sound.</p> <div style="background-color: #e0e0e0; padding: 5px; border: 1px solid #ccc;"> <p><b>⚠ WARNING</b> Risk of accident if steering capability is impaired</p> <p>If the steering does not function as intended, the vehicle's operating safety is jeopardized.</p> <ul style="list-style-type: none"> <li>► Pull over and stop the vehicle safely as soon as possible, paying attention to road and traffic conditions. Do not continue driving under any circumstances.</li> <li>► Consult a qualified specialist workshop.</li> </ul> </div> <ul style="list-style-type: none"> <li>► When stopping, bear the enlarged vehicle width in mind.</li> </ul>





Display messages	Possible causes/consequences and ► Solutions
<p>Snow Chain Mode Maximum Speed Exceeded</p>	<ul style="list-style-type: none"> <li>* The maximum permissible speed for snow chain mode has been exceeded.               <ul style="list-style-type: none"> <li>► Drive more slowly.</li> </ul> </li> </ul>
	<ul style="list-style-type: none"> <li>* At least one door is open.               <ul style="list-style-type: none"> <li>► Close all doors.</li> </ul> </li> </ul>
	<ul style="list-style-type: none"> <li>* The hood is open.               <div style="border: 1px solid black; padding: 5px; margin-top: 10px;"> <p><b>▲ WARNING</b> Risk of accident due to driving with the hood unlocked</p> <p>The hood may open and block your view.</p> <ul style="list-style-type: none"> <li>► Never release the hood when driving.</li> <li>► Before every trip, ensure that the hood is locked.</li> </ul> </div> <ul style="list-style-type: none"> <li>► Stop the vehicle immediately in accordance with the traffic conditions.</li> <li>► Close the hood.</li> </ul> </li> </ul>
	<ul style="list-style-type: none"> <li>* The tailgate is open.               <div style="border: 1px solid black; padding: 5px; margin-top: 10px;"> <p><b>▲ DANGER</b> Risk of exhaust gas poisoning</p> <p>Combustion engines emit poisonous exhaust gases such as carbon monoxide. Exhaust gases can enter the vehicle interior if the tailgate is open when the engine is running, especially if the vehicle is in motion.</p> </div> </li> </ul>

Display messages	Possible causes/consequences and ► Solutions
	<ul style="list-style-type: none"> <li>► Always switch off the engine before opening the tailgate.</li> <li>► Never drive with the tailgate open.</li> </ul> <p>► Close the tailgate.</p>
 <p>Rear Left Backrest Not Latched (example)</p>	<ul style="list-style-type: none"> <li>* The seat backrest of the corresponding seat is not engaged.</li> <li>► Fold the seat backrest back until it engages.</li> </ul>
 <p>Add Washer Fluid</p>	<ul style="list-style-type: none"> <li>* The washer fluid level in the washer fluid reservoir has dropped below the minimum.</li> <li>► Add washer fluid (→ page 378).</li> </ul>
<p>Windshield Wiper Malfunction</p>	<ul style="list-style-type: none"> <li>* The windshield wiper is malfunctioning.</li> <li>► Restart the vehicle.</li> </ul> <p>If the display message still appears:</p> <ul style="list-style-type: none"> <li>► Consult a qualified specialist workshop.</li> </ul>

## Engine

Display messages	Possible causes/consequences and ► Solutions
<p>To Switch Off Vehicle Press and Hold Start/Stop Button for at Least 3 Sec- onds or Press 3 Times</p>	<p>* You have pressed the start/stop button while the vehicle is in motion.</p> <ul style="list-style-type: none"> <li>► Information about switching off the vehicle while driving (→ page 166).</li> </ul>
<div data-bbox="205 418 362 503" data-label="Image"> </div> <p>Check Coolant Level See Operator's Manual</p>	<p>* The coolant level is too low.</p> <div data-bbox="550 459 1698 544" data-label="Complex-Block" style="border: 1px solid gray; padding: 5px;"> <p><b>!</b> <b>NOTE</b> Engine damage due to insufficient coolant</p> <ul style="list-style-type: none"> <li>► Avoid long journeys with insufficient coolant.</li> </ul> </div> <ul style="list-style-type: none"> <li>► Add coolant (→ page 378).</li> <li>► Have the engine cooling system checked at a qualified specialist workshop.</li> </ul>
<div data-bbox="205 641 362 723" data-label="Image"> </div> <p>Coolant Stop Switch Off Vehicle</p>	<p>* The coolant is too hot.</p> <ul style="list-style-type: none"> <li>► Stop immediately in accordance with the traffic conditions and switch off the vehicle.</li> </ul>

Display messages	Possible causes/consequences and ► Solutions
	<p><b>▲ WARNING</b> Risk of burns when opening the hood</p> <p>If you open the hood in the event of an overheated engine or fire in the engine compartment, the following situations may occur:</p> <ul style="list-style-type: none"> <li>• You may come into contact with hot gases.</li> <li>• You may come into contact with other escaping hot operating fluids.</li> </ul> <p>► Before opening the hood, allow the engine to cool down.</p> <p>► In the event of a fire in the engine compartment, keep the hood closed and call the fire service.</p> <p>► Wait until the engine has cooled down.</p> <p>► Make sure that the air supply to the radiator is not obstructed.</p> <p>► Avoiding high loads on the engine, drive to the nearest qualified specialist workshop. In doing so, ensure that the coolant temperature display remains below the red marking.</p>
 <p>Fuel Reserve</p>	<p>* The fuel supply has dropped into the reserve range.</p> <p>► Refuel.</p>

Display messages	Possible causes/consequences and ► Solutions
 <p data-bbox="194 336 397 367">Fuel Filler Cap Open</p>	<ul style="list-style-type: none"> <li data-bbox="526 248 1219 274">* The fuel filler cap is not closed correctly or the fuel system is leaking.               <ul style="list-style-type: none"> <li data-bbox="545 279 813 305">► Close the fuel filler cap.</li> <li data-bbox="545 310 1432 341">► <b>If the fuel filler cap was already properly closed:</b> consult a qualified specialist workshop.</li> </ul> </li> </ul>

### Transmission

Display messages	Possible causes/consequences and ► Solutions
<p data-bbox="194 512 462 564">Shift to P Only When Vehicle Is Stationary</p>	<ul style="list-style-type: none"> <li data-bbox="526 512 1265 538">* It is possible to select the park position <b>P</b> only if the vehicle is stationary.               <ul style="list-style-type: none"> <li data-bbox="545 543 896 569">► Depress the brake pedal to stop.</li> <li data-bbox="545 574 1284 606">► Shift the transmission to park position <b>P</b> when the vehicle is stationary.</li> </ul> </li> </ul>
<p data-bbox="194 626 425 678">Depress Brake to Shift from P</p>	<ul style="list-style-type: none"> <li data-bbox="526 626 1598 652">* You have attempted to shift the transmission out of park position <b>P</b> and into another transmission position.               <ul style="list-style-type: none"> <li data-bbox="545 657 822 683">► Depress the brake pedal.</li> <li data-bbox="545 688 1071 720">► Select transmission position <b>D</b>, <b>R</b> or neutral <b>N</b>.</li> </ul> </li> </ul>
<p data-bbox="194 740 443 813">To Deselect P or N Depress Brake and Start Vehicle</p>	<ul style="list-style-type: none"> <li data-bbox="526 740 1690 787">* You have attempted to shift the transmission out of park position <b>P</b> or neutral <b>N</b> and into another transmission position.               <ul style="list-style-type: none"> <li data-bbox="545 792 822 818">► Depress the brake pedal.</li> <li data-bbox="545 823 748 854">► Start the vehicle.</li> </ul> </li> </ul>

## 492 Display messages and warning/indicator lamps

Display messages	Possible causes/consequences and ► Solutions
Depress Brake to Shift to D or R	<ul style="list-style-type: none"> <li>► Change the transmission position.</li> </ul> <p>* You have attempted to select transmission position <b>D</b> or <b>R</b>.</p> <ul style="list-style-type: none"> <li>► Depress the brake pedal.</li> <li>► Select transmission position <b>D</b> or <b>R</b>.</li> </ul>
Depress Brake to Shift to R	<p>* You have attempted to select transmission position <b>R</b>.</p> <ul style="list-style-type: none"> <li>► Depress the brake pedal.</li> <li>► Select transmission position <b>R</b>.</li> </ul>
Service Required Apply Parking Brake to Park	<p>* A malfunction has occurred in the emergency power supply to park position <b>P</b>.</p> <ul style="list-style-type: none"> <li>► Consult a qualified specialist workshop.</li> <li>► Until then, always select park position <b>P</b> manually before you switch off the vehicle.</li> <li>► Before leaving the vehicle, apply the electric parking brake.</li> </ul>
Risk of Vehicle Rolling Away Driver's Door Open Position P Not Selected	<p>* The driver's door is not fully closed and transmission position <b>D</b>, <b>R</b> or neutral <b>N</b> is selected.</p> <p>The vehicle may roll away.</p> <ul style="list-style-type: none"> <li>► Select park position <b>P</b> when switching off the vehicle.</li> </ul>
Risk of Vehicle Rolling Away Apply Parking Brake When Parking	<p>* The transmission is malfunctioning. Park position <b>P</b> cannot be selected.</p> <ul style="list-style-type: none"> <li>► Park the vehicle safely.</li> <li>► Use the electric parking brake to secure the vehicle against rolling away.</li> </ul>





Display messages	Possible causes/consequences and ► Solutions
<p>Risk of Vehicle Rolling Away N Activated Manually No Automatic Change to P</p>	<ul style="list-style-type: none"> <li>► On gradients, turn the front wheels so that the vehicle will roll towards the curb if it starts moving.</li> </ul> <p>* While the vehicle was at a standstill or driving at very low speed, neutral <b>[N]</b> was engaged with the engine running or the vehicle switched on.</p> <div style="border: 1px solid black; padding: 5px; margin: 5px 0;"> <p><b>[I]</b> <b>NOTE</b> Damage to the vehicle due to rolling away</p> <p>When the vehicle is switched off or the driver's door is opened, automatic engagement of park position <b>[P]</b> is deactivated.</p> <p>The vehicle may roll away.</p> <ul style="list-style-type: none"> <li>► Be ready to brake.</li> <li>► Do not leave the vehicle unattended.</li> </ul> </div> <ul style="list-style-type: none"> <li>► Depress the brake pedal until the vehicle comes to a standstill.</li> <li>► Engage park position <b>[P]</b> when the vehicle is stationary with the brake pedal depressed.</li> <li>► To continue driving with the brake pedal depressed, select transmission position <b>[D]</b> or <b>[R]</b>.</li> </ul>
<p>N Automatically Activated Please Shift to Transmission Position Again</p>	<p>* Neutral <b>[N]</b> was automatically engaged when the vehicle was rolling or being driven.</p> <ul style="list-style-type: none"> <li>ⓘ When you open the driver's door in neutral <b>[N]</b>, park position <b>[P]</b> will be engaged automatically.</li> <li>► Engage park position <b>[P]</b> when the vehicle is stationary with the brake pedal depressed.</li> <li>► To continue driving with the brake pedal depressed, select transmission position <b>[D]</b> or <b>[R]</b>.</li> </ul>





Display messages	Possible causes/consequences and ► Solutions
N is Engaged Shift to Desired Drive Range	<ul style="list-style-type: none"> <li>* The accelerator pedal was depressed while the vehicle was rolling or moving in neutral <b>N</b>.               <ul style="list-style-type: none"> <li>► To accelerate the vehicle, select transmission position <b>D</b> or <b>R</b>.</li> </ul> </li> </ul>
Reversing Not Possible Service Required	<ul style="list-style-type: none"> <li>* The transmission is malfunctioning. It is not possible to select transmission position <b>R</b>.               <ul style="list-style-type: none"> <li>► Consult a qualified specialist workshop.</li> </ul> </li> </ul>
Transmission Malfunction Stop	<ul style="list-style-type: none"> <li>* The transmission is malfunctioning. The transmission shifts to neutral <b>N</b> automatically.               <ul style="list-style-type: none"> <li>► Stop the vehicle immediately in accordance with the traffic conditions.</li> <li>► Depress the brake pedal.</li> <li>► Engage park position <b>P</b>.</li> <li>► Consult a qualified specialist workshop.</li> </ul> </li> </ul>
Service Required Do Not Change Transmission Position	<ul style="list-style-type: none"> <li>* The transmission is malfunctioning. It is no longer possible to change the transmission position.               <ul style="list-style-type: none"> <li>► If transmission position <b>D</b> is selected, consult a qualified specialist workshop and do not change the transmission position.</li> <li>► For all other transmission positions, park the vehicle safely.</li> <li>► Consult a qualified specialist workshop or breakdown service.</li> </ul> </li> </ul>
Auxiliary Battery Malfunction (white display message)	<ul style="list-style-type: none"> <li>* There is a malfunction in the auxiliary battery.               <ul style="list-style-type: none"> <li>► Consult a qualified specialist workshop.</li> <li>► Until then, always select park position <b>P</b> manually before you switch off the vehicle.</li> <li>► Before leaving the vehicle, apply the electric parking brake.</li> </ul> </li> </ul>





Display messages	Possible causes/consequences and ► Solutions
<p>Auxiliary Battery Malfunction (red display message)</p>	<p>* There is a malfunction in the auxiliary battery.</p> <ul style="list-style-type: none"> <li>► Consult a qualified specialist workshop.</li> <li>► Until then, always select park position <b>P</b> manually before you switch off the vehicle.</li> <li>► Before leaving the vehicle, apply the electric parking brake.</li> </ul>

## Brakes





Display messages	Possible causes/consequences and ► Solutions
<div style="border: 1px solid black; padding: 5px; text-align: center; width: 80px; margin: 0 auto;"> <p><b>PARK</b></p> </div> <p>(USA only)</p> <div style="border: 1px solid black; padding: 5px; text-align: center; width: 80px; margin: 5px auto;">  </div> <p>(Canada only)</p> <p>Parking Brake See Operator's Manual</p>	<p>* The yellow  indicator lamp is lit. The electric parking brake is malfunctioning.</p> <p><b>To apply:</b></p> <ul style="list-style-type: none"> <li>► Switch the vehicle off and switch it back on.</li> <li>► Apply the electric parking brake manually (→ page 219).</li> </ul> <p>If it is not possible to apply the electric parking brake:</p> <ul style="list-style-type: none"> <li>► Consult a qualified specialist workshop.</li> <li>► Where necessary, also secure the parked vehicle against rolling away.</li> </ul> <p>* The yellow  indicator lamp and the red <b>PARK</b> (USA only) or  (Canada only) indicator lamp are lit. The electric parking brake is malfunctioning.</p> <p><b>To release:</b></p>

Display messages	Possible causes/consequences and ► Solutions
	<ul style="list-style-type: none"><li>► Switch the vehicle off and switch it back on.</li><li>► Release the electric parking brake manually (→ page 219).</li></ul> or <ul style="list-style-type: none"><li>► Release the electric parking brake automatically (→ page 218).</li></ul> If it is still not possible to release the electric parking brake: <ul style="list-style-type: none"><li>► Do not continue driving. Consult a qualified specialist workshop.</li></ul> * The yellow  indicator lamp is lit and the red  (USA only) or  (Canada only) indicator lamp is flashing. The electric parking brake is malfunctioning. The electric parking brake could not be applied or released. <ul style="list-style-type: none"><li>► Switch the vehicle off and switch it back on.</li></ul> <b>To apply:</b> <ul style="list-style-type: none"><li>► Release and then apply the electric parking brake manually (→ page 219).</li></ul> <b>To release:</b> <ul style="list-style-type: none"><li>► Apply and then release the electric parking brake manually.</li></ul> If the electric parking brake cannot be applied or the red  (USA only) or  (Canada only) indicator lamp continues to flash: <ul style="list-style-type: none"><li>► Do not continue driving. Consult a qualified specialist workshop.</li><li>► Where necessary, also secure the parked vehicle against rolling away.</li></ul>

Display messages	Possible causes/consequences and ► Solutions
	<p>* The yellow  indicator lamp is lit and the red  (USA only) or  (Canada only) indicator lamp flashes for approximately ten seconds after the electric parking brake has been applied or released. It then remains lit or goes out. The electric parking brake is malfunctioning.</p> <p><b>If the state of charge is too low:</b></p> <ul style="list-style-type: none"><li>► Charge the 12 V battery.</li></ul> <p><b>To apply:</b></p> <ul style="list-style-type: none"><li>► Apply the electric parking brake manually.</li></ul> <p>If it is not possible to apply the electric parking brake:</p> <ul style="list-style-type: none"><li>► Consult a qualified specialist workshop.</li><li>► Where necessary, also secure the parked vehicle against rolling away.</li></ul> <p><b>To release:</b></p> <ul style="list-style-type: none"><li>► If the conditions for automatic release are fulfilled and the electric parking brake is not released automatically, release the electric parking brake manually (→ page 219).</li></ul> <p>If it is still not possible to release the electric parking brake:</p> <ul style="list-style-type: none"><li>► Do not continue driving. Consult a qualified specialist workshop.</li></ul>

Display messages	Possible causes/consequences and ► Solutions
<div data-bbox="155 252 310 332" data-label="Image"></div> <p data-bbox="155 342 255 366">(USA only)</p> <div data-bbox="155 379 310 458" data-label="Image"></div> <p data-bbox="155 469 284 493">(Canada only)</p> <p data-bbox="149 503 371 527">Release Parking Brake</p>	<p data-bbox="473 249 1356 273">* The red <b>PARK</b> indicator lamp (USA only) or <b>(P)</b> indicator lamp (Canada only) is flashing.</p> <p data-bbox="495 283 1055 307">The electric parking brake is applied while you are driving:</p> <ul data-bbox="500 318 1493 379" style="list-style-type: none"> <li data-bbox="500 318 1493 341">• A condition for automatic release of the electric parking brake has not been fulfilled (→ page 218).</li> <li data-bbox="500 352 1369 376">• You are performing emergency braking using the electric parking brake (→ page 219).</li> </ul> <ul data-bbox="495 394 1234 455" style="list-style-type: none"> <li data-bbox="495 394 1234 418">► Check the conditions for automatic release of the electric parking brake.</li> <li data-bbox="495 428 957 452">► Release the electric parking brake manually.</li> </ul>
<div data-bbox="155 559 310 639" data-label="Image"></div> <p data-bbox="155 649 255 673">(USA only)</p> <div data-bbox="155 685 310 765" data-label="Image"></div> <p data-bbox="155 775 284 799">(Canada only)</p> <p data-bbox="149 810 408 857">Switch on Vehicle to Release the Parking Brake</p>	<p data-bbox="473 556 1153 580">* The red <b>PARK</b> (USA only) or <b>(P)</b> (Canada only) indicator lamp is lit.</p> <p data-bbox="495 590 1332 614">You have attempted to release the electric parking brake with the vehicle switched off.</p> <ul data-bbox="495 624 741 648" style="list-style-type: none"> <li data-bbox="495 624 741 648">► Switch on the vehicle.</li> </ul>



Display messages	Possible causes/consequences and ► Solutions
<div data-bbox="205 249 362 332" data-label="Image"> </div> <div data-bbox="192 339 301 366" data-label="Text"> <p>(USA only)</p> </div> <div data-bbox="205 377 362 459" data-label="Image"> </div> <div data-bbox="192 467 332 494" data-label="Text"> <p>(Canada only)</p> </div> <div data-bbox="192 499 386 526" data-label="Text"> <p>Brake Immediately</p> </div>	<ul style="list-style-type: none"> <li>* A malfunction has occurred while the HOLD function was activated.           <ul style="list-style-type: none"> <li>A horn may also sound at regular intervals.</li> <li>You cannot start the vehicle system.</li> </ul> </li> <li>► Immediately depress the brake pedal firmly until the display message disappears.           <ul style="list-style-type: none"> <li>You cannot start the vehicle system again.</li> </ul> </li> </ul>
<div data-bbox="205 555 362 638" data-label="Image"> </div> <div data-bbox="192 645 301 672" data-label="Text"> <p>(USA only)</p> </div> <div data-bbox="205 682 362 765" data-label="Image"> </div> <div data-bbox="192 772 332 799" data-label="Text"> <p>(Canada only)</p> </div> <div data-bbox="192 804 436 852" data-label="Text"> <p>Malfunction See Operator's Manual</p> </div>	<ul style="list-style-type: none"> <li>* The brake force boosting function is impaired.           <ul style="list-style-type: none"> <li>The hill start assist may be impaired.</li> </ul> </li> </ul> <div data-bbox="547 629 1705 780" style="border: 1px solid gray; padding: 5px;"> <p><b>⚠ WARNING</b> Risk of an accident due to a brake system malfunction</p> <p>If the brake system is malfunctioning, braking characteristics may be impaired.</p> <ul style="list-style-type: none"> <li>► Drive on carefully.</li> <li>► Have the brake system checked immediately at a qualified specialist workshop.</li> </ul> </div>

Display messages	Possible causes/consequences and ► Solutions
 <p>(USA only)</p>  <p>(Canada only)</p> <p>Malfunction Stop</p>	<p>* The brake force boosting function is impaired and the braking characteristics may be affected.</p> <p><b>▲ WARNING</b> Risk of accident and injury if brake force boosting is malfunctioning</p> <p>If brake force boosting is malfunctioning, increased brake pedal force may be necessary for braking. The braking characteristics may be impaired. The braking distance can increase in emergency braking situations.</p> <ul style="list-style-type: none"><li>► Stop in a safe location immediately. Do not continue driving.</li><li>► Consult a qualified specialist workshop.</li></ul>
 <p>(USA only)</p>  <p>(Canada only)</p> <p>Check Brake Fluid Level</p>	<p>* There is insufficient brake fluid in the brake fluid reservoir.</p> <p><b>▲ WARNING</b> Risk of an accident due to low brake fluid level</p> <p>If the brake fluid level is too low, the braking effect and the braking characteristics may be impaired.</p> <ul style="list-style-type: none"><li>► Pull over and stop the vehicle safely as soon as possible, paying attention to road and traffic conditions. Do not continue driving under any circumstances.</li><li>► Consult a qualified specialist workshop.</li><li>► Do not add brake fluid.</li></ul>

Display messages	Possible causes/consequences and ► Solutions
<p>Check Brake Pads See Operator's Manual</p>	<p>* The brakepads have reached the wear limit.            ► Consult a qualified specialist workshop.</p>



### Driving and driving safety systems



Display messages	Possible causes/consequences and ► Solutions
<div data-bbox="203 450 360 533" data-label="Image"> </div> <div data-bbox="203 538 360 621" data-label="Image"> </div> <p>Currently Unavailable See Operator's Manual</p>	<p>* ABS and ESP<sup>®</sup> are temporarily unavailable.            Other driving systems and driving safety systems (e.g. BAS) may also be temporarily unavailable.            The brake system will continue to operate normally. Braking distance may increase in an emergency braking situation.</p> <div data-bbox="545 564 1690 606" data-label="Text"> <p><b>⚠ WARNING</b> Risk of skidding if ABS and ESP<sup>®</sup> are malfunctioning</p> </div> <p>The wheels may lock during braking and ESP<sup>®</sup> does not perform any vehicle stabilization.            The steerability and braking characteristics are heavily impaired and the braking distance may increase. In addition, other driving safety systems are switched off.</p> <ul style="list-style-type: none"> <li>► Drive carefully on a suitable stretch of road, making slight steering movements at a speed above 19 mph (30 km/h).</li> <li>► If the display message does not disappear, consult a qualified specialist workshop immediately. Drive carefully.</li> </ul>

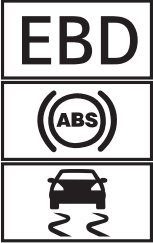

Display messages	Possible causes/consequences and ► Solutions
 <p data-bbox="144 425 417 474">Inoperative See Operator's Manual</p>	<p data-bbox="476 249 1641 346">* ABS and ESP® are malfunctioning. Other driving systems and driving safety systems (e.g. BAS) may also be malfunctioning. The brake system will continue to operate normally. Braking distance may increase in an emergency braking situation.</p> <div data-bbox="500 363 1646 581" style="border: 1px solid gray; padding: 5px;"> <p data-bbox="506 370 1166 399"><b>▲ WARNING</b> Risk of skidding if ABS and ESP® are malfunctioning</p> <p data-bbox="513 415 1387 439">The wheels may block during braking and ESP® does not perform any vehicle stabilization.</p> <p data-bbox="513 449 1600 498">The steerability and braking characteristics are heavily impaired and the braking distance may increase. In addition, other driving safety systems are switched off.</p> <ul data-bbox="513 508 1289 570" style="list-style-type: none"> <li data-bbox="513 508 722 532">► Drive on carefully.</li> <li data-bbox="513 542 1289 570">► Have ABS and ESP® checked immediately at a qualified specialist workshop.</li> </ul> </div>
 <p data-bbox="144 692 408 740">Currently Unavailable See Operator's Manual</p>	<p data-bbox="476 598 1350 660">* ESP® is temporarily unavailable. Other driving systems and driving safety systems (e.g. BAS) may also be malfunctioning.</p> <div data-bbox="500 678 1646 850" style="border: 1px solid gray; padding: 5px;"> <p data-bbox="506 685 1060 714"><b>▲ WARNING</b> Risk of skidding if ESP is malfunctioning®</p> <p data-bbox="513 730 1618 779">If ESP® is malfunctioning, ESP® cannot carry out vehicle stabilization. In addition, other driving safety systems are switched off.</p> <ul data-bbox="513 789 1563 841" style="list-style-type: none"> <li data-bbox="513 789 1563 841">► Drive carefully on a suitable stretch of road, making slight steering movements at a speed above 19 mph (30 km/h).</li> </ul> </div>





Display messages	Possible causes/consequences and ► Solutions
	<ul style="list-style-type: none"> <li>► If the display message does not disappear, consult a qualified specialist workshop immediately. Drive carefully.</li> </ul>
 <p data-bbox="195 427 469 477">Inoperative See Operator's Manual</p>	<p data-bbox="524 335 778 363">* ESP® is malfunctioning.</p> <p data-bbox="543 370 1400 398">Other driving systems and driving safety systems (e.g. BAS) may also be malfunctioning.</p> <p data-bbox="543 406 1692 434">The brake system will continue to operate normally. Braking distance may increase in an emergency braking situation.</p> <div data-bbox="543 446 1713 490" style="background-color: #e0e0e0; padding: 5px;"> <p data-bbox="556 456 1114 484"><b>▲ WARNING</b> Risk of skidding if ESP® is malfunctioning</p> </div> <p data-bbox="561 498 1670 552">If ESP® is malfunctioning, ESP® cannot carry out vehicle stabilization. In addition, other driving safety systems are switched off.</p> <ul style="list-style-type: none"> <li>► Drive on carefully.</li> <li>► Have ESP® checked at a qualified specialist workshop.</li> </ul>

Display messages	Possible causes/consequences and ► Solutions
 <p data-bbox="144 511 417 560">Inoperative See Operator's Manual</p>	<p data-bbox="476 249 1350 311">* EBD, ABS and ESP® are malfunctioning. Other driving systems and driving safety systems (e.g. BAS) may also be malfunctioning.</p> <div data-bbox="500 329 1648 547" style="border: 1px solid gray; padding: 5px;"> <p data-bbox="506 339 1221 365"><b>▲ WARNING</b> Risk of skidding if EBD, ABS and ESP® are malfunctioning</p> <p data-bbox="513 381 1391 407">The wheels may block during braking and ESP® does not perform any vehicle stabilization.</p> <p data-bbox="513 417 1600 469">The steerability and braking characteristics are heavily impaired and the braking distance may increase. In addition, other driving safety systems are switched off.</p> <ul style="list-style-type: none"> <li data-bbox="513 479 722 505">► Drive on carefully.</li> <li data-bbox="513 515 1313 541">► Have the brake system checked immediately at a qualified specialist workshop.</li> </ul> </div>
 <p data-bbox="144 677 181 703">Off</p>	<p data-bbox="476 588 1541 614">* The HOLD function is deactivated because the vehicle is slipping or a condition for activation is not fulfilled.</p> <ul style="list-style-type: none"> <li data-bbox="495 624 1578 650">► Reactivate the HOLD function later or check the activation conditions for the HOLD function (→ page 227).</li> </ul>
<p data-bbox="144 729 417 781">Restricted Mode Activated Drive Power Reduced</p>	<ul style="list-style-type: none"> <li data-bbox="476 729 1319 755">* The valet service mode is activated. Vehicle acceleration is restricted (→ page 229).</li> <li data-bbox="476 765 1341 791">* The beginner driver mode is activated. Vehicle acceleration is restricted (→ page 229).</li> </ul>

Display messages	Possible causes/consequences and ► Solutions
 <p data-bbox="194 341 471 393">ATTENTION ASSIST: Take a Break!</p>	<ul style="list-style-type: none"> <li>* ATTENTION ASSIST has detected fatigue or an increasing lack of concentration on the part of the driver (→ page 230).               <ul style="list-style-type: none"> <li>► If necessary, take a break.</li> </ul> </li> </ul>
 <p data-bbox="194 512 286 538">--- mph</p>	<ul style="list-style-type: none"> <li>* Cruise control cannot be activated as not all activation conditions are fulfilled.               <ul style="list-style-type: none"> <li>► Observe the activation conditions for cruise control (→ page 232).</li> </ul> </li> </ul>
<p data-bbox="194 559 462 585">Cruise Control Inoperative</p>	<ul style="list-style-type: none"> <li>* Cruise control is malfunctioning.               <ul style="list-style-type: none"> <li>► Consult a qualified specialist workshop.</li> </ul> </li> </ul>
<p data-bbox="194 637 378 663">Cruise Control Off</p>	<ul style="list-style-type: none"> <li>* Cruise control has been deactivated.               <ul style="list-style-type: none"> <li>If there is an additional warning tone, cruise control has been deactivated automatically (→ page 231).</li> </ul> </li> </ul>
<p data-bbox="194 709 425 787">Traffic Sign Assist Currently Unavailable See Operator's Manual</p>	<ul style="list-style-type: none"> <li>* Traffic Sign Assist is temporarily unavailable.               <ul style="list-style-type: none"> <li>Once the cause of the problem is no longer present, the system will be available again.</li> <li>► Continue driving in compliance with traffic regulations.</li> </ul> </li> </ul>
<p data-bbox="194 818 462 870">Traffic Sign Assist Inoperative</p>	<ul style="list-style-type: none"> <li>* Traffic Sign Assist is malfunctioning.               <ul style="list-style-type: none"> <li>► Continue driving in compliance with traffic regulations.</li> </ul> </li> </ul>



Display messages	Possible causes/consequences and ► Solutions
	<p>or</p> <ul style="list-style-type: none"><li>► Stop the vehicle in accordance with the traffic conditions and restart the vehicle.</li><li>► If the display message does not disappear: consult a qualified specialist workshop.</li></ul>
 <p>Not in Curr. Drive Prog.</p>	<ul style="list-style-type: none"><li>* DSR is not available in the currently selected drive program.</li><li>► Change the drive program.</li></ul>
 <p>Inoperative</p>	<ul style="list-style-type: none"><li>* DSR is malfunctioning.</li><li>► Consult a qualified specialist workshop.</li></ul>
 <p>Do Not Exceed 25 mph</p>	<ul style="list-style-type: none"><li>* The maximum permissible speed of 25 mph (40 km/h) for DSR has been exceeded.</li><li>► Drive more slowly.</li></ul>

## Driver assistance systems

Display messages	Possible causes/consequences and ► Solutions
 <p>--- mph</p>	<ul style="list-style-type: none"> <li>* Active Distance Assist DISTRONIC cannot be activated as not all activation conditions are fulfilled.               <ul style="list-style-type: none"> <li>► Comply with the activation conditions of Active Distance Assist DISTRONIC (→ page 236).</li> </ul> </li> </ul>
 <p>Suspended</p>	<ul style="list-style-type: none"> <li>* If you depress the accelerator pedal beyond the setting of Active Distance Assist DISTRONIC, the system will switch to passive mode (→ page 233).</li> </ul>
 <p>Off</p>	<ul style="list-style-type: none"> <li>* Active Distance Assist DISTRONIC was deactivated. If a warning tone also sounds, Active Distance Assist DISTRONIC has deactivated automatically (→ page 236).</li> </ul>
<p>Active Distance Assist Currently Unavailable See Operator's Manual</p>	<ul style="list-style-type: none"> <li>* Active Distance Assist DISTRONIC is temporarily unavailable. The ambient conditions are outside the system limits (→ page 233). As soon as the ambient conditions are within the system limits, the system will become available again.               <ul style="list-style-type: none"> <li>► Drive on carefully.</li> <li>or</li> </ul> </li> </ul>

Display messages	Possible causes/consequences and ► Solutions
	<p>► If the display message does not disappear, stop the vehicle in accordance with the traffic conditions and restart the vehicle.</p>
<p>Active Distance Assist Inoperative</p>	<p>* Active Distance Assist DISTRONIC is malfunctioning. Other driving systems and driving safety systems may also be malfunctioning.</p> <p>► Drive on carefully. or</p> <p>► Stop the vehicle in accordance with the traffic conditions and restart the vehicle. ► If the display message does not disappear: consult a qualified specialist workshop.</p>
<p>Active Distance Assist Now Available</p>	<p>* Active Distance Assist DISTRONIC is operational again.</p> <p>► Switch on Active Distance Assist DISTRONIC (→ page 236).</p>
<p>Active Brake Assist Functions Currently Limited See Operator's Manual</p>	<p>* For vehicles with the Driving Assistance Package, the following functions may be temporarily unavailable or only partially available:</p> <ul style="list-style-type: none"> <li>• Active Brake Assist with cross-traffic function</li> <li>• Evasive Steering Assist</li> <li>• PRE-SAFE® PLUS</li> </ul> <p><b>Vehicles with Blind Spot Assist:</b> PRE-SAFE® PLUS is temporarily unavailable. The ambient conditions are outside the system limits (→ page 250).</p> <p><b>Vehicles without the Driving Assistance Package:</b> Active Brake Assist is temporarily unavailable.</p>

Display messages	Possible causes/consequences and ► Solutions
	<p>► Drive on carefully. As soon as the ambient conditions are within the system limits, the system will become available again.</p> <p>or</p> <p>► If the display message does not disappear, stop the vehicle in accordance with the traffic conditions and restart the vehicle.</p>
<p>Active Brake Assist Functions Limited See Operator's Manual</p>	<p>* For vehicles with the Driving Assistance Package, the following functions may be temporarily unavailable or only partially available:</p> <ul style="list-style-type: none"> <li>• Active Brake Assist with cross-traffic function</li> <li>• Evasive Steering Assist</li> <li>• PRE-SAFE® PLUS</li> </ul> <p><b>Vehicles without the Driving Assistance Package:</b> Active Brake Assist is temporarily unavailable or only partially available.</p> <p>► Drive on carefully.</p> <p>or</p> <p>► Stop the vehicle in accordance with the traffic conditions and restart the vehicle.</p> <p>► If the display message does not disappear: consult a qualified specialist workshop.</p>
<p>Active Steering Assist Currently Unavailable See Operator's Manual</p>	<p>* Active Steering Assist is temporarily unavailable. The ambient conditions are outside the system limits (→ page 242). As soon as the ambient conditions are within the system limits, the system will become available again.</p>

Display messages	Possible causes/consequences and ► Solutions
	<ul style="list-style-type: none"> <li>► Drive on</li> <li>► Check the tire pressure if necessary.</li> </ul>
<p>Active Steering Assist Inoperative</p>	<p>* Active Steering Assist is malfunctioning. Active Distance Assist DISTRONIC remains available.</p> <ul style="list-style-type: none"> <li>► Drive on</li> </ul> <p>or</p> <ul style="list-style-type: none"> <li>► Stop the vehicle in accordance with the traffic conditions and restart the vehicle.</li> <li>► If the display message does not disappear: consult a qualified specialist workshop.</li> </ul>
	<p>* Active Steering Assist has reached the system limits (→ page 242). You have not steered independently for a considerable period of time.</p> <ul style="list-style-type: none"> <li>► Take over the steering and drive on in accordance with the traffic conditions.</li> </ul>
<p>Active Steering Assist Currently Unavailable Due to Multiple Emergency Stops</p>	<p>* Active Steering Assist is temporarily unavailable due to several emergency stops having been performed.</p> <ul style="list-style-type: none"> <li>► Take over the steering and stop in accordance with the traffic conditions.</li> <li>► Switch the vehicle off and switch it back on Active Steering Assist is available once more.</li> </ul>
 <p>Initiating Emergency Stop</p>	<p>* Your hands are not on the steering wheel. Active Steering Assist will initiate an emergency stop (→ page 242).</p> <ul style="list-style-type: none"> <li>► Put your hands on the steering wheel.</li> </ul> <p>Information on canceling an emergency stop (→ page 245).</p>



Display messages	Possible causes/consequences and ► Solutions
<p>Active Emergency Stop Assist Currently Unavailable See Operator's Manual</p>	<ul style="list-style-type: none"> <li>* Active Emergency Stop Assist is temporarily unavailable. The ambient conditions are outside the system limits (→ page 245). As soon as the ambient conditions are within the system limits, the system will become available again.               <ul style="list-style-type: none"> <li>► Drive on</li> <li>or</li> <li>► If the display message does not disappear, stop the vehicle in accordance with the traffic conditions and restart the vehicle.</li> </ul> </li> <li>* <b>Vehicles without the Driving Assistance Package:</b> Active Emergency Stop Assist is temporarily unavailable due to multiple emergency stops.               <ul style="list-style-type: none"> <li>► Take over the steering and stop in accordance with the traffic conditions.</li> <li>► Switch the vehicle off and switch it back on. Active Emergency Stop Assist is available once more.</li> </ul> </li> </ul>
<p>Active Emergency Stop Assist Inoperative</p>	<ul style="list-style-type: none"> <li>* Active Emergency Stop Assist is malfunctioning.               <ul style="list-style-type: none"> <li>► Drive on</li> <li>or</li> <li>► Stop the vehicle in accordance with the traffic conditions and restart the vehicle.</li> <li>► If the display message does not disappear: consult a qualified specialist workshop.</li> </ul> </li> </ul>

Display messages	Possible causes/consequences and ► Solutions
<a href="#">Active Lane Change Assist Currently Unavailable See Operator's Manual</a>	<p>* Active Lane Change Assist is temporarily unavailable. The ambient conditions are outside the system limits (→ page 246). As soon as the ambient conditions are within the system limits, the system will become available again.</p> <ul style="list-style-type: none"><li>► Drive on.</li><li>or</li><li>► If the display message does not disappear, stop the vehicle in accordance with the traffic conditions and restart the vehicle.</li></ul>
<a href="#">Active Lane Change Assist Inoperative</a>	<p>* Active Lane Change Assist is malfunctioning.</p> <ul style="list-style-type: none"><li>► Drive on.</li><li>or</li><li>► Stop the vehicle in accordance with the traffic conditions and restart the vehicle.</li><li>► If the display message does not disappear: consult a qualified specialist workshop.</li></ul>
<a href="#">Automatic Lane Change Currently Unavailable See Operator's Manual</a>	<p>* Active Lane Change Assist is temporarily unavailable. The ambient conditions are outside the system limits (→ page 246). As soon as the ambient conditions are within the system limits, the system will become available again.</p> <ul style="list-style-type: none"><li>► Drive on</li><li>or</li><li>► If the display message does not disappear, stop the vehicle in accordance with the traffic conditions and restart the vehicle.</li></ul>

Display messages	Possible causes/consequences and ► Solutions
Automatic Lane Change Inoperative	<p>* Active Lane Change Assist is malfunctioning.</p> <ul style="list-style-type: none"> <li>► Drive on</li> <li>or</li> <li>► Stop the vehicle in accordance with the traffic conditions and restart the vehicle.</li> <li>► If the display message does not disappear: consult a qualified specialist workshop.</li> </ul>
Active Stop & Go Assist Currently Unavailable See Operator's Manual	<p>* Active Stop-and-Go Assist is temporarily unavailable. Active Distance Assist DISTRONIC and Active Steering Assist are still available.</p> <p>The ambient conditions are outside the system limits (→ page 233).</p> <p>As soon as the ambient conditions are within the system limits, the system will become available again.</p> <ul style="list-style-type: none"> <li>► Drive on.</li> </ul>
Active Stop & Go Assist Inoperative See Operator's Manual	<p>* Active Stop-and-Go Assist is malfunctioning.</p> <p>Active Stop-and-Go Assist has been deactivated. Active Distance Assist DISTRONIC and Active Steering Assist are still available.</p> <ul style="list-style-type: none"> <li>► Drive on.</li> <li>or</li> <li>► Stop the vehicle in accordance with the traffic conditions and restart the vehicle.</li> <li>► If the display message does not disappear: consult a qualified specialist workshop.</li> </ul>



## 514 Display messages and warning/indicator lamps

Display messages	Possible causes/consequences and ► Solutions
<b>Blind Spot Assist Currently Unavailable</b> See Operator's Manual	<p>* Blind Spot Assist is temporarily unavailable. The system limits have been reached (→ page 261). Once the cause of the problem is no longer present, the system will be available again.</p> <ul style="list-style-type: none"><li>► Drive on.</li><li>or</li><li>► If the display message does not disappear, stop the vehicle in accordance with the traffic conditions and restart the vehicle.</li></ul>
<b>Blind Spot Assist Inoperative</b>	<p>* Blind Spot Assist or the exit warning is malfunctioning.</p> <ul style="list-style-type: none"><li>► Drive on.</li><li>or</li><li>► Stop the vehicle in accordance with the traffic conditions and restart the vehicle.</li><li>► If the display message does not disappear: consult a qualified specialist workshop.</li></ul>
<b>Blind Spot Assist Not Available When Towing Trailer</b> See Operator's Manual	<p>* When you establish the electrical connection to the trailer, Blind Spot Assist will be unavailable.</p> <ul style="list-style-type: none"><li>► Press the left-hand Touch Control and acknowledge the display message.</li></ul>
<b>Active Blind Spot Assist Currently Unavailable</b> See Operator's Manual	<p>* Active Blind Spot Assist is temporarily unavailable. The system limits have been reached (→ page 261). Once the cause of the problem is no longer present, the system will be available again.</p>

Display messages	Possible causes/consequences and ► Solutions
	<ul style="list-style-type: none"> <li>► Drive on.</li> <li>or</li> <li>► If the display message does not disappear, stop the vehicle in accordance with the traffic conditions and restart the vehicle.</li> </ul>
Active Blind Spot Assist Inoperative	<ul style="list-style-type: none"> <li>* Active Blind Spot Assist or the exit warning is malfunctioning.</li> <li>► Drive on.</li> <li>or</li> <li>► Stop the vehicle in accordance with the traffic conditions and restart the vehicle.</li> <li>► If the display message does not disappear: consult a qualified specialist workshop.</li> </ul>
Active Blind Spot Assist Not Available When Towing Trailer See Operator's Manual	<ul style="list-style-type: none"> <li>* When you establish the electrical connection to the trailer, Active Blind Spot Assist will be unavailable.</li> <li>► Press the left-hand Touch Control and acknowledge the display message.</li> </ul>
Active Lane Keeping Assist Currently Unavailable See Operator's Manual	<ul style="list-style-type: none"> <li>* Active Lane Keeping Assist is temporarily unavailable.</li> <li>The ambient conditions are outside the system limits (→ page 264).</li> <li>As soon as the ambient conditions are within the system limits, the system will become available again.</li> <li>► Drive on</li> </ul>
Active Lane Keeping Assist Inoperative	<ul style="list-style-type: none"> <li>* Active Lane Keeping Assist is malfunctioning.</li> </ul>

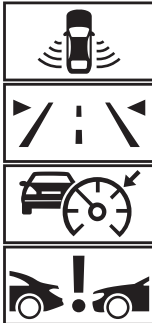
Display messages	Possible causes/consequences and ► Solutions
	<ul style="list-style-type: none"> <li>► Drive on</li> <li>or</li> <li>► Stop the vehicle in accordance with the traffic conditions and restart the vehicle.</li> <li>► If the display message does not disappear: consult a qualified specialist workshop.</li> </ul>
<p>Active Lane Keeping Assist Limited Range of Functions See Operator's Manual</p>	<p>* Active Lane Keeping Assist is available but restricted.</p> <ul style="list-style-type: none"> <li>► Drive on</li> <li>or</li> <li>► Stop the vehicle in accordance with the traffic conditions and restart the vehicle.</li> <li>► If the display message does not disappear: consult a qualified specialist workshop.</li> </ul>
<div style="border: 1px solid black; padding: 5px; display: inline-block;">  </div> <p>Initiating Emergency Stop</p>	<p>* Your hands are not on the steering wheel. The Active Lane Keeping Assist will initiate an emergency stop (→ page 264).</p> <ul style="list-style-type: none"> <li>► Put your hands on the steering wheel.</li> </ul> <p>Information on canceling an emergency stop (→ page 245).</p>

Display messages	Possible causes/consequences and ► Solutions
 <p data-bbox="194 595 443 647">Temporarily Unavailable Sensors Dirty</p>	<p data-bbox="526 248 1450 274">* Front and corner radar sensors (hereafter "sensors") are malfunctioning. Possible causes are:</p> <ul data-bbox="545 284 1201 378" style="list-style-type: none"> <li data-bbox="545 284 785 305">• The sensors are dirty</li> <li data-bbox="545 315 766 336">• Heavy rain or snow</li> <li data-bbox="545 347 1201 378">• Extended country driving without other traffic, e.g. in the desert</li> </ul> <p data-bbox="545 393 1690 445">Driving systems and driving safety systems may be malfunctioning or temporarily unavailable. The brake system, steering and drive system will continue to function normally.</p> <p data-bbox="545 455 757 481">► Drive on carefully.</p> <p data-bbox="545 502 1690 554">Once the causes of the problem are no longer present, the driving systems and driving safety systems will be available again and the corresponding symbols will be switched off.</p> <p data-bbox="545 564 960 590">If the display message does not disappear:</p> <ul data-bbox="545 600 1145 694" style="list-style-type: none"> <li data-bbox="545 600 1145 626">► Stop the vehicle in accordance with the traffic conditions.</li> <li data-bbox="545 631 1090 657">► Clean all sensor covers from outside (→ page 222).</li> <li data-bbox="545 663 766 688">► Restart the vehicle.</li> </ul>

Display messages	Possible causes/consequences and ► Solutions
 <p data-bbox="144 764 421 816">Camera View Reduced See Operator's Manual</p>	<p data-bbox="476 249 1188 270">* The view of the multifunction camera is restricted. Possible causes are:</p> <ul data-bbox="500 283 1618 401" style="list-style-type: none"> <li data-bbox="500 283 1215 304">• Dirt on the windshield in the field of vision of the multifunction camera</li> <li data-bbox="500 318 759 338">• Heavy rain, snow or fog</li> <li data-bbox="500 352 1618 401">• Fogging up of the windshield from inside or outside: in certain weather conditions, fog can form on the inside or outside of the windshield during cold times of year in particular.</li> </ul> <p data-bbox="495 418 1618 470">① This fog on the windshield will be removed automatically within a short time with the aid of a heater. The restriction is temporary.</p> <p data-bbox="495 480 1646 532">Driving systems and driving safety systems may be malfunctioning or temporarily unavailable. The brake system, steering and drive system will continue to function normally.</p> <ul data-bbox="495 542 1507 636" style="list-style-type: none"> <li data-bbox="495 542 704 563">► Drive on carefully.</li> <li data-bbox="495 577 1507 597">► In order to remove the fog from the outside, carry out a single wipe of the windshield (→ page 144).</li> <li data-bbox="495 611 1212 631">► In order to remove the fog from the inside, press  (→ page 156).</li> </ul> <p data-bbox="495 663 1646 714">Once the causes of the problem are no longer present, the driving systems and driving safety systems will be available again and the corresponding symbols will be switched off.</p> <p data-bbox="495 725 1313 745">If the display message does not disappear after a longer drive of around 15 minutes:</p> <ul data-bbox="495 759 1411 852" style="list-style-type: none"> <li data-bbox="495 759 1092 780">► Stop the vehicle in accordance with the traffic conditions.</li> <li data-bbox="495 793 1411 814">► Clean the windshield, especially in the position of the multifunction camera (→ page 222).</li> <li data-bbox="495 827 717 848">► Restart the vehicle.</li> </ul>



Display messages	Possible causes/consequences and ► Solutions
 <p data-bbox="194 512 443 564">Functions Limited When Towing Trailer</p>	<p data-bbox="517 248 1506 274">* When the trailer socket is occupied, some driving systems will be available only to a limited extent.</p> <ul style="list-style-type: none"> <li data-bbox="535 279 1302 310">► Drive carefully if you are towing a trailer or have the bicycle rack mounted.</li> </ul>
<p data-bbox="194 585 462 637">PRE-SAFE Inoperative See Operator's Manual</p>	<p data-bbox="517 585 988 611">* The PRE-SAFE® functions are malfunctioning.</p> <ul style="list-style-type: none"> <li data-bbox="535 616 970 647">► Consult a qualified specialist workshop.</li> </ul>
<p data-bbox="194 663 471 740">PRE-SAFE Pulse Side Inoperative See Operator's Manual</p>	<p data-bbox="517 663 1570 688">* The PRE-SAFE® Impulse Side system is malfunctioning or inoperative after having already been triggered.</p> <ul style="list-style-type: none"> <li data-bbox="535 694 970 725">► Consult a qualified specialist workshop.</li> </ul>
<p data-bbox="194 761 471 813">PRE-SAFE PLUS Inoperative See Operator's Manual</p>	<p data-bbox="517 761 1081 787">* There is a malfunction in the PRE-SAFE® PLUS system.</p> <ul style="list-style-type: none"> <li data-bbox="535 792 665 828">► Drive on</li> <li data-bbox="535 833 572 859">or</li> </ul>

## 520 Display messages and warning/indicator lamps

Display messages	Possible causes/consequences and ► Solutions
	<ul style="list-style-type: none"><li>► Stop the vehicle in accordance with the traffic conditions and restart the vehicle.</li><li>► If the display message does not disappear: consult a qualified specialist workshop.</li></ul>

### Parking assistance systems



Display messages	Possible causes/consequences and ► Solutions
<b>PARKTRONIC Inoperative</b> See Operator's Manual	<ul style="list-style-type: none"><li>* Parking Assist PARKTRONIC is malfunctioning. Once the cause of the problem is no longer present, the system will be available again.</li><li>► Continue driving while paying attention to the vehicle's surroundings.</li><li>or</li><li>► Stop the vehicle in accordance with the traffic conditions and restart the vehicle.</li><li>► If the display message still appears, consult a qualified specialist workshop.</li></ul>
<b>PARKTRONIC and Maneuvering Assistance Unavailable at Rear When Towing Trailer</b>	<ul style="list-style-type: none"><li>* If transport equipment, e.g. a trailer or bicycle rack, is attached to the trailer hitch and the electrical connection is correctly established, Parking Assist PARKTRONIC is not available when backing up. The rear maneuvering assistant is also unavailable in this situation.</li><li>► Press the left-hand Touch Control and acknowledge the display message.</li></ul>
<b>Active Parking Assist and PARKTRONIC Inoperative</b> See Operator's Manual	<ul style="list-style-type: none"><li>* Active Parking Assist and Parking Assist PARKTRONIC are malfunctioning. Once the cause of the problem is no longer present, the system will be available again.</li><li>► Continue driving while paying attention to the vehicle's surroundings.</li></ul>



Display messages	Possible causes/consequences and ► Solutions
	<p>or</p> <ul style="list-style-type: none"> <li>► Stop the vehicle in accordance with the traffic conditions and restart the vehicle.</li> <li>► If the display message still appears, consult a qualified specialist workshop.</li> </ul>
<p>Active Parking Assist Limited Availability of Maneuvering Assistance See Operator's Manual</p>	<ul style="list-style-type: none"> <li>* Active Parking Assist's maneuvering assistant is temporarily unavailable or only partially available.               <ul style="list-style-type: none"> <li>► Clean all sensors of the parking and camera system (→ page 383).</li> <li>► If the display message still appears, consult a qualified specialist workshop.</li> </ul> </li> </ul>



### Mercedes-Benz emergency call system

Display messages	Possible causes/consequences and ► Solutions
 <p>Inoperative</p>	<ul style="list-style-type: none"> <li>* The Mercedes-Benz emergency call system is malfunctioning. The Mercedes me connect system is also malfunctioning.               <ul style="list-style-type: none"> <li>► Consult a qualified specialist workshop.</li> </ul> </li> </ul>

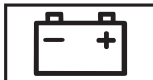
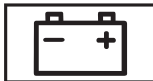
## Battery

Display messages	Possible causes/consequences and ► Solutions
 <p data-bbox="144 381 399 433">12 V On-board Electrical System Service Required</p>	<p data-bbox="469 288 1027 313">* The 12 V on-board electrical system is malfunctioning.</p> <ul style="list-style-type: none"> <li data-bbox="493 322 1036 348">► Consult a qualified specialist workshop immediately.</li> </ul>
 <p data-bbox="144 550 391 601">Stop Vehicle See Operator's Manual</p>	<p data-bbox="469 456 1299 482">* The 12 V battery is no longer being charged and the condition of charge is too low.</p> <div data-bbox="495 498 1646 619" style="border: 1px solid gray; padding: 5px;"> <p data-bbox="506 508 1073 534"><b>!</b> <b>NOTE</b> Possible engine damage if you continue driving</p> <ul style="list-style-type: none"> <li data-bbox="506 550 1033 576">► Do not continue driving under any circumstances.</li> <li data-bbox="506 584 935 610">► Consult a qualified specialist workshop.</li> </ul> </div> <ul style="list-style-type: none"> <li data-bbox="493 636 1631 687">► Stop the vehicle immediately in accordance with the traffic conditions. Do not continue driving under any circumstances.</li> <li data-bbox="493 696 746 722">► Switch off the vehicle.</li> <li data-bbox="493 730 916 756">► Consult a qualified specialist workshop.</li> </ul>



Display messages	Possible causes/consequences and ► Solutions
 <p data-bbox="194 341 434 388">Switch on vehicle to charge the 12 V battery</p>	<ul style="list-style-type: none"> <li data-bbox="517 248 1275 274">* The vehicle is off and the condition of charge of the 12 V battery is too low.               <ul style="list-style-type: none"> <li data-bbox="545 279 1099 305">► Switch off electrical consumers that are not required.</li> <li data-bbox="545 310 794 336">► Drive for 30–60 mins.</li> </ul> </li> <li data-bbox="545 347 572 367">or</li> <li data-bbox="545 378 1127 404">► Charge the 12 V battery when stationary (→ page 401).</li> <li data-bbox="545 409 1265 435">► <b>Plug-in hybrid:</b> Charge the vehicle at a charging station (→ page 196).</li> </ul>
 <p data-bbox="194 549 471 621">Stop Vehicle To Charge the 12 V Battery Do Not Switch Off Vehicle</p>	<ul style="list-style-type: none"> <li data-bbox="517 455 1025 481">* The state of charge of the 12 V battery is too low.               <ul style="list-style-type: none"> <li data-bbox="545 486 1506 512">► Stop the vehicle immediately in accordance with the traffic conditions. Do not continue driving.</li> <li data-bbox="545 523 831 549">► Leave the vehicle running</li> <li data-bbox="545 559 1007 585">► If the display message disappears: drive on.</li> <li data-bbox="545 590 1386 616">► If the display message does not disappear: consult a qualified specialist workshop.</li> </ul> </li> </ul>
 <p data-bbox="194 740 443 792">Stop Vehicle See Operator's Manual</p>	<ul style="list-style-type: none"> <li data-bbox="517 652 1071 678">* The 48 V on-board electrical system is malfunctioning.               <ul style="list-style-type: none"> <li data-bbox="545 683 1681 730">► Stop the vehicle immediately in accordance with the traffic conditions. Do not continue driving under any circumstances.</li> <li data-bbox="545 740 794 766">► Switch off the vehicle.</li> <li data-bbox="545 777 970 802">► Consult a qualified specialist workshop.</li> </ul> </li> </ul>

Display messages	Possible causes/consequences and ► Solutions
 <p data-bbox="144 342 402 418">Battery Overheated Stop! Everyone Get Out! Out- doors if Possible</p>	<ul style="list-style-type: none"> <li data-bbox="476 249 1018 273">* The 48 V battery is overheating. There is a risk of fire.               <ul style="list-style-type: none"> <li data-bbox="495 283 1215 307">► Stop the vehicle immediately in accordance with the traffic conditions.</li> <li data-bbox="495 318 1387 341">► If possible, stop the vehicle in the open air and ensure that all vehicle occupants get out.</li> <li data-bbox="495 352 1600 384">◉ Supporting vehicle functions may activate automatically, e.g. air-recirculation mode as part of climate control.</li> <li data-bbox="495 394 765 418">► Do not continue driving.</li> <li data-bbox="495 428 1300 452">► If smoke is present, leave the danger zone and call the fire service immediately.</li> <li data-bbox="495 463 1332 486">► Consult a qualified specialist workshop even if there are no external signs of a fire.</li> </ul> </li> </ul>
 <p data-bbox="144 598 391 646">48 V Battery See Opera- tor's Manual</p>	<ul style="list-style-type: none"> <li data-bbox="476 505 1208 563">* The 48 V on-board electrical system has function restrictions. Comfort functions, such as the climate control system, may be restricted. It is possible to continue driving.               <ul style="list-style-type: none"> <li data-bbox="495 605 1535 632">► If the display message remains active continuously, consult a qualified specialist workshop immediately.</li> </ul> </li> </ul>
 <p data-bbox="144 764 413 812">Please Wait Charging 48 V Battery...</p>	<ul style="list-style-type: none"> <li data-bbox="476 671 1637 819">* The 48 V battery is discharged. You have switched on the vehicle while the 12 V battery was being charged with a suitable charger or while another vehicle was providing starting assistance. The discharged 48 V battery is charged automatically via the voltage converter. After a few minutes, the <b>Starting Possible Again</b> display message will be shown on the driver's display.               <ul style="list-style-type: none"> <li data-bbox="495 791 698 819">► Start the vehicle.</li> </ul> </li> </ul>



Display messages	Possible causes/consequences and ► Solutions
	<ul style="list-style-type: none"> <li>► Drive the vehicle for a while to charge the 12 V battery and the 48 V battery after disconnecting the charger from the vehicle.</li> </ul> <p>If the <b>Starting Possible Again</b> display message does not appear after a few minutes:</p> <ul style="list-style-type: none"> <li>► Try to start the vehicle.</li> <li>► If the vehicle does not start, consult a qualified specialist workshop.</li> </ul>
<b>Starting Possible Again</b>	<ul style="list-style-type: none"> <li>* The 48 V battery has been charged automatically via the voltage converter.</li> <li>► Start the vehicle and drive for a while to charge the 12 V battery and the 48 V battery.</li> </ul>



### Tire pressure monitor

Display messages	Possible causes/consequences and ► Solutions
<b>Tire Pressure Monitor Currently Unavailable</b>	<ul style="list-style-type: none"> <li>* There is interference from a powerful radio signal source. As a result, no signals from the tire pressure sensor are being received. The tire pressure monitoring system is temporarily unavailable.</li> </ul> <p>The tire pressure monitoring system will restart automatically as soon as the cause has been rectified.</p> <ul style="list-style-type: none"> <li>► Drive on.</li> </ul>
<b>Tire Pressure Monitor Inoperative</b>	<ul style="list-style-type: none"> <li>* The tire pressure monitoring system is malfunctioning.</li> </ul>

Display messages	Possible causes/consequences and ► Solutions
	<p><b>▲ WARNING</b> There is a risk of an accident if the tire pressure monitoring system is malfunctioning</p> <p>The tire pressure monitoring system cannot issue a warning if there is pressure loss in one or more of the tires. Tires with insufficient tire pressure may impair the driving characteristics as well as steering and braking.</p> <p>► Have the tire pressure monitoring system checked at a qualified specialist workshop.</p>
<p>Tire Pressure Monitor Inoperative Tire Pressure Sensors Missing</p>	<p>* The wheels installed do not have suitable tire pressure sensors. The tire pressure monitoring system is deactivated.</p> <p>► Install wheels with suitable tire pressure sensors.</p>
 <p>Wheel Sensor(s) Missing</p>	<p>* There is no signal from the tire pressure sensor in at least one wheel. No pressure value is displayed for the affected tire.</p> <p>► Have the faulty tire pressure sensor replaced at a qualified specialist workshop.</p>
 <p>Check Tires</p>	<p>* The tire pressure in one or more tires has dropped significantly. The wheel position is displayed. A warning tone will also sound.</p> <p><b>▲ WARNING</b> Risk of an accident due to insufficient tire pressure</p> <ul style="list-style-type: none"> <li>• The tires can burst.</li> <li>• The tires can wear excessively and/or unevenly.</li> </ul>







Display messages	Possible causes/consequences and ► Solutions
	<ul style="list-style-type: none"> <li>• The driving characteristics as well as the steering and braking may be greatly impaired.</li> </ul> <p>You could then lose control of the vehicle.</p> <ul style="list-style-type: none"> <li>► Observe the recommended tire pressures.</li> <li>► Adjust the tire pressure if necessary.</li> </ul> <ul style="list-style-type: none"> <li>► Stop the vehicle in accordance with the traffic conditions.</li> <li>► Check the tire pressure (→ page 414) and the tires.</li> </ul>
 <p data-bbox="195 588 447 638">Please Correct Tire Pressure</p>	<p data-bbox="526 498 1690 547">* The tire pressure is too low in at least one of the tires, or the difference in tire pressure between the individual wheels is too great.</p> <ul style="list-style-type: none"> <li>► Check the tire pressure and add air, if necessary.</li> <li>► When the tire pressure is correct, restart the tire pressure monitor (→ page 419).</li> </ul>
 <p data-bbox="195 754 447 781">Warning Tire Malfunction</p>	<p data-bbox="526 664 1406 691">* The pressure in one or more tires has dropped suddenly. The wheel position is displayed.</p> <div data-bbox="550 705 1696 746" style="background-color: #e0e0e0; padding: 5px;"> <p data-bbox="559 712 1160 739">▲ <b>WARNING</b> Risk of an accident from driving with a flat tire</p> </div> <ul style="list-style-type: none"> <li>• The tires can overheat and be damaged.</li> <li>• The driving characteristics as well as the steering and braking characteristics may be greatly impaired.</li> </ul> <p data-bbox="559 829 972 856">You could then lose control of the vehicle.</p>

Display messages	Possible causes/consequences and ► Solutions
	<ul style="list-style-type: none"> <li>► Do not drive with a flat tire.</li> <li>► Do not exceed the maximum permissible driving distance in emergency mode and the maximum permissible speed with a flat MOExtended tire.</li> <li>► Observe the notes on flat tires.</li> </ul> <p>Notes on flat tires (→ page 390).</p> <ul style="list-style-type: none"> <li>► Stop the vehicle in accordance with the traffic conditions.</li> <li>► Check the tires.</li> </ul>
 <p>Tires Overheated</p>	<p>* At least one tire is overheating. The affected tires are displayed in red. At temperatures close to the limit value, the tires are displayed in yellow.</p> <p><b>▲ WARNING</b> Risk of an accident from driving with overheated tires</p> <p>Overheated tires can burst.</p> <ul style="list-style-type: none"> <li>► Reduce speed so that the tires cool down.</li> </ul>
 <p>Reduce Speed</p>	<p>* At least one tire is overheating. The affected tires are displayed in red. At temperatures close to the limit value, the tires are displayed in yellow.</p> <p><b>▲ WARNING</b> Risk of an accident from driving with overheated tires</p> <p>Overheated tires can burst.</p>

Display messages	Possible causes/consequences and ► Solutions
	<ul style="list-style-type: none"> <li>► Reduce speed so that the tires cool down.</li> </ul>

## Engine oil

Display messages	Possible causes/consequences and ► Solutions
 <p data-bbox="195 526 458 601">Check Engine Oil Level At Next Refueling (Add 1 Quart)</p>	<p data-bbox="524 433 1073 456">* The engine oil level has dropped to the minimum level.</p> <div data-bbox="547 474 1696 560" style="border: 1px solid gray; padding: 5px;"> <p data-bbox="556 484 1252 508"><b>!</b> NOTE Engine damage caused by driving with insufficient engine oil</p> <ul style="list-style-type: none"> <li>► Avoid long journeys with insufficient engine oil.</li> </ul> </div> <p data-bbox="543 578 1243 601">► When next refueling, add 1.1 US qt (1 l) of engine oil (→ page 376).</p> <p data-bbox="543 622 888 646">Notes on engine oil (→ page 450).</p>
 <p data-bbox="195 754 469 803">Engine Oil Level Reduce Oil Level</p>	<p data-bbox="524 660 846 684">* The engine oil level is too high.</p> <div data-bbox="547 702 1696 788" style="border: 1px solid gray; padding: 5px;"> <p data-bbox="556 712 1212 736"><b>!</b> NOTE Engine damage caused by driving with excess engine oil</p> <ul style="list-style-type: none"> <li>► Avoid long journeys with excess engine oil.</li> </ul> </div> <p data-bbox="543 806 1456 829">► Consult a qualified specialist workshop immediately and have the engine oil level reduced.</p>

Display messages	Possible causes/consequences and ► Solutions
 <p data-bbox="144 342 360 389">Engine Oil Level Stop Switch Off Vehicle</p>	<p data-bbox="476 249 785 273">* The engine oil level is too low.</p> <div data-bbox="500 291 1646 377"><p data-bbox="506 301 1201 325"><b>!</b> <b>NOTE</b> Engine damage caused by driving with insufficient engine oil</p><p data-bbox="506 342 1005 366">► Avoid long journeys with insufficient engine oil.</p></div> <ul data-bbox="495 394 1456 522" style="list-style-type: none"><li data-bbox="495 394 1456 418">► Stop the vehicle immediately in accordance with the traffic conditions. Do not continue driving.</li><li data-bbox="495 428 746 452">► Switch off the vehicle.</li><li data-bbox="495 463 990 486">► Add 1.1 US qt (1 l) of engine oil (→ page 376).</li><li data-bbox="495 497 787 521">► Check the engine oil level.</li></ul> <p data-bbox="495 539 835 563">Notes on engine oil (→ page 450).</p>
 <p data-bbox="144 677 397 724">Engine Oil Pressure Stop Switch Off Vehicle</p>	<p data-bbox="476 584 753 608">* The oil pressure is too low.</p> <div data-bbox="500 625 1646 711"><p data-bbox="506 636 1219 659"><b>!</b> <b>NOTE</b> Engine damage caused by driving with insufficient oil pressure</p><p data-bbox="506 677 957 701">► Avoid driving with insufficient oil pressure.</p></div> <ul data-bbox="495 729 1456 819" style="list-style-type: none"><li data-bbox="495 729 1456 753">► Stop the vehicle immediately in accordance with the traffic conditions. Do not continue driving.</li><li data-bbox="495 763 746 787">► Switch off the vehicle.</li><li data-bbox="495 797 916 821">► Consult a qualified specialist workshop.</li></ul>

Display messages	Possible causes/consequences and ► Solutions
 <p data-bbox="194 341 471 388">Engine Oil Level Cannot Be Measured</p>	<p data-bbox="517 248 1515 274">* The electrical connection to the oil level sensor has been interrupted or the oil level sensor is faulty.</p> <ul style="list-style-type: none"> <li data-bbox="535 279 970 305">► Consult a qualified specialist workshop.</li> </ul>

## Warning and indicator lamps

### Overview of indicator and warning lamps

Some systems will perform a self-test when the vehicle is switched on. Some indicator and warning lamps may briefly light up or flash. This behavior is non-critical. These indicator and warning lamps indicate a malfunction only if they light up or flash after the vehicle has been started or during a journey.



### Driver display





### Indicator and warning lamps

#### Occupant safety



 Restraint system (→ page 533)

-  Seat belt (→ page 533)
-  Occupant presence reminder (white) (→ page 533)
-  Occupant presence reminder (yellow) (→ page 533)



#### Drive system

-  Reduced power (→ page 535)
-  System error (→ page 535)
-  Electrical malfunction (→ page 535)





#### Vehicle

-  Power steering (yellow) (→ page 536)
-  Power steering (red) (→ page 536)





## 532 Display messages and warning/indicator lamps



-  Rear axle steering (yellow) (→ page 536)
-  Rear axle steering (red) (→ page 536)

### Engine









-  Coolant temperature (→ page 538)
-  Engine diagnosis (→ page 538)
-  Vehicles with a gasoline engine: engine operating temperature (→ page 538)
-  Electrical malfunction (→ page 538)
-  Reserve fuel with fuel filler flap location indicator (→ page 538)

### Braking

-  Electric parking brake (yellow) (→ page 542)
-  USA: electric parking brake (red) (→ page 542)
-  Canada: electric parking brake (red) (→ page 542)
-  USA: Recuperative Brake System (→ page 542)
-  Canada: brakes (yellow) (→ page 542)

-  USA: brakes (red) (→ page 542)
-  Canada: brakes (red) (→ page 542)

### Driving and driving safety systems

-  ABS (→ page 545)
-  ESP® (→ page 545)
-  ESP® OFF (→ page 545)
-  ATTENTION ASSIST (→ page 545)
-  Traffic Sign Assist (→ page 545)
-  Distance warning (→ page 545)
-  Active Brake Assist (→ page 545)
-  Active Brake Assist (→ page 545)
-  Active Brake Assist (→ page 545)





### Mercedes-Benz emergency call system

-  Mercedes-Benz emergency call system (→ page 549)



### Tire pressure monitoring system

-  Tire pressure monitoring system (→ page 549)

### Exterior lighting



-  Standing lights (→ page 133)
-  Low beam (→ page 133)
-  High beam (→ page 134)
-  Turn signal lights (→ page 134)
-  Rear fog light (→ page 133)

### Symbols on the central display

-  Drive Away Assist (→ page 285)
-  Rear cross traffic warning (→ page 286)
-  Maneuvering brake function (→ page 287)

## Occupant safety



Warning/indicator lamp	Possible causes/consequences and ► Solutions
 <p data-bbox="195 381 445 433">Restraint system warning lamp</p>	<p data-bbox="513 288 1175 339">* The restraint system red warning lamp is lit while the vehicle is on. The restraint system is malfunctioning (→ page 42).</p> <div data-bbox="532 360 1696 474" style="background-color: #f0f0f0; padding: 5px;"> <p data-bbox="541 365 1245 391">▲ <b>WARNING</b> Risk of injury due to malfunctions in the restraint system</p> <p data-bbox="541 407 1609 433">Components in the restraint system may be activated unintentionally or not deploy as planned in an accident.</p> <p data-bbox="541 438 1507 464">► Have the restraint system checked and repaired immediately at a qualified specialist workshop.</p> </div> <p data-bbox="528 490 668 515"><b>Plug-in hybrid:</b></p> <div data-bbox="532 536 1696 774" style="background-color: #f0f0f0; padding: 5px;"> <p data-bbox="541 541 1228 567">▲ <b>DANGER</b> Risk of death due to the restraint system malfunctioning</p> <p data-bbox="541 583 1683 635">Components in the restraint system may be activated unintentionally or not deploy as intended in an accident. In the event of an accident, the high-voltage on-board electrical system may not be deactivated as intended.</p> <p data-bbox="541 645 1633 697">You may receive an electric shock if you touch the damaged components of the high-voltage on-board electrical system.</p> <p data-bbox="541 707 1507 733">► Have the restraint system checked and repaired immediately at a qualified specialist workshop.</p> <p data-bbox="541 738 1097 764">► After an accident, switch off the vehicle immediately.</p> </div> <ul data-bbox="528 790 1073 884" style="list-style-type: none"> <li data-bbox="528 790 741 816">► Drive on carefully.</li> <li data-bbox="528 821 975 847">► Note the messages on the driver's display.</li> <li data-bbox="528 852 1073 884">► Consult a qualified specialist workshop immediately.</li> </ul>

Warning/indicator lamp	Possible causes/consequences and ► Solutions
 <p data-bbox="144 342 371 391">Seat belt warning lamp flashes</p>	<p data-bbox="463 249 1391 298">* The red seat belt warning lamp flashes and an intermittent warning tone sounds. The driver or front passenger has not fastened his/her seat belt while the vehicle is in motion.</p> <ul data-bbox="476 308 1009 394" style="list-style-type: none"><li data-bbox="476 308 857 334">► Fasten your seat belt (→ page 41).</li><li data-bbox="476 337 931 363">There are objects on the front passenger seat.</li><li data-bbox="476 366 1009 394">► Remove the objects from the front passenger seat.</li></ul>
 <p data-bbox="144 506 371 555">Seat belt warning lamp lights up</p>	<p data-bbox="463 415 1308 441">* The red seat belt warning lamp lights up for six seconds once the vehicle has started.</p> <p data-bbox="476 446 1411 498">In addition, an intermittent warning tone may sound. The red seat belt warning lamp reminds the driver and front passenger to fasten their seat belts.</p> <ul data-bbox="476 508 857 534" style="list-style-type: none"><li data-bbox="476 508 857 534">► Fasten your seat belt (→ page 41).</li></ul> <p data-bbox="476 550 1465 576">If you have placed objects on the front passenger seat, the red seat belt warning lamp may remain lit.</p>
 <p data-bbox="144 684 371 760">Occupant presence reminder warning lamp (white)</p>	<p data-bbox="463 591 1045 643">* The white occupant presence reminder warning lamp is lit. The occupant presence reminder is deactivated.</p> <ul data-bbox="476 653 1119 679" style="list-style-type: none"><li data-bbox="476 653 1119 679">► Switch on the occupant presence reminder, see (→ page 70).</li></ul>





Warning/indicator lamp	Possible causes/consequences and ► Solutions
 <p data-bbox="194 341 471 414">Occupant presence reminder warning lamp (yellow)</p>	<p data-bbox="508 248 1108 300">* The yellow occupant presence reminder warning lamp is lit. The occupant presence reminder is malfunctioning</p> <p data-bbox="526 305 979 336">► Note the messages on the driver's display.</p>



### Drive system

Warning/indicator lamp	Possible causes/consequences and ► Solutions
 <p data-bbox="194 652 471 704">Reduced warning lamp power</p>	<p data-bbox="508 559 979 611">* The yellow reduced-power warning lamp is on. Drive system power output is reduced.</p> <p data-bbox="526 616 979 647">► Note the messages on the driver's display.</p>
 <p data-bbox="194 813 471 865">System malfunction warning lamp</p>	<p data-bbox="508 720 1506 771">* The red system error warning lamp is lit while the vehicle is in a state of operational readiness <span style="border: 1px solid black; padding: 2px;">READY</span>.</p> <p data-bbox="526 777 979 808">► Note the messages on the driver's display.</p>

Warning/indicator lamp	Possible causes/consequences and ► Solutions
 <p data-bbox="144 342 421 392">Electrical malfunction warning lamp</p>	<p data-bbox="458 249 957 298">* The red electrical malfunction warning lamp is lit. There is a malfunction with the electrics.</p> <p data-bbox="476 308 925 334">► Note the messages on the driver's display.</p>

## Vehicle



Warning/indicator lamp	Possible causes/consequences and ► Solutions
 <p data-bbox="144 627 376 677">Power steering warning lamp (yellow)</p>	<p data-bbox="458 534 1188 583">* The yellow power steering warning lamp is lit while the vehicle is running. The power assistance or the steering itself is malfunctioning.</p> <p data-bbox="476 593 925 619">► Note the messages on the driver's display.</p>
 <p data-bbox="144 781 376 830">Power steering warning lamp (red)</p>	<p data-bbox="458 687 1160 736">* The red power steering warning lamp is lit while the vehicle is running. The power assistance or the steering itself is malfunctioning.</p> <div data-bbox="482 764 1644 802" style="background-color: #e0e0e0; padding: 5px;"> <p data-bbox="487 771 1114 797">▲ <b>WARNING</b> Risk of accident if steering capability is impaired</p> </div> <p data-bbox="487 808 1369 833">If the steering does not function as intended, the vehicle's operating safety is jeopardized.</p>



Warning/indicator lamp	Possible causes/consequences and ► Solutions
	<ul style="list-style-type: none"> <li>► Pull over and stop the vehicle safely as soon as possible, paying attention to road and traffic conditions. Do not continue driving under any circumstances.</li> <li>► Consult a qualified specialist workshop.</li> </ul> <p>► Note the messages on the driver's display.</p>
 <p>Rear axle steering warning lamp (yellow)</p>	<p>* The yellow rear axle steering warning lamp is lit while the vehicle is running. The rear axle steering is malfunctioning.</p> <p>► Note the messages on the driver's display.</p>
 <p>Rear axle steering warning lamp (red)</p>	<p>* The red rear axle steering warning lamp is lit while the vehicle is running. The rear axle steering is malfunctioning.</p> <p><b>⚠ WARNING</b> Risk of accident if steering capability is impaired</p> <p>If the steering does not function as intended, the vehicle's operating safety is jeopardized.</p> <ul style="list-style-type: none"> <li>► Pull over and stop the vehicle safely as soon as possible, paying attention to road and traffic conditions. Do not continue driving under any circumstances.</li> <li>► Consult a qualified specialist workshop.</li> </ul> <p>► Note the messages on the driver's display.</p>

## Engine

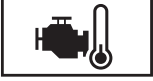

Warning/indicator lamp	Possible causes/consequences and ► Solutions
 <p data-bbox="144 381 413 408">Coolant warning lamp (red)</p>	<p data-bbox="462 288 1086 314">* The red coolant warning lamp is lit while the engine is running.</p> <p data-bbox="476 323 676 346">Possible causes are:</p> <ul data-bbox="484 358 927 520" style="list-style-type: none"> <li data-bbox="484 358 920 381">• The temperature sensor is malfunctioning</li> <li data-bbox="484 391 778 414">• The coolant level is too low</li> <li data-bbox="484 424 927 447">• The air supply to the radiator is obstructed</li> <li data-bbox="484 457 750 480">• The radiator fan is faulty</li> <li data-bbox="484 491 842 513">• The engine coolant pump is faulty</li> </ul> <p data-bbox="476 536 1611 563">If there is an additional warning tone, the coolant temperature has exceeded the maximum permissible temperature.</p> <div data-bbox="484 582 1646 835" style="border: 1px solid gray; padding: 5px;"> <p data-bbox="491 588 1005 615"><b>▲ WARNING</b> Risk of burns when opening the hood</p> <p data-bbox="495 627 1629 677">If you open the hood in the event of an overheated engine or fire in the engine compartment, the following situations may occur:</p> <ul data-bbox="502 689 1193 747" style="list-style-type: none"> <li data-bbox="502 689 949 712">• You may come into contact with hot gases.</li> <li data-bbox="502 723 1193 747">• You may come into contact with other escaping hot operating fluids.</li> </ul> <ul data-bbox="495 764 1459 822" style="list-style-type: none"> <li data-bbox="495 764 1079 787">► Before opening the hood, allow the engine to cool down.</li> <li data-bbox="495 797 1459 822">► In the event of a fire in the engine compartment, keep the hood closed and call the fire service.</li> </ul> </div> <p data-bbox="476 851 1581 878">► Stop immediately in accordance with the traffic conditions and switch off the vehicle. Do not continue driving.</p>

Warning/indicator lamp	Possible causes/consequences and ► Solutions
	<p>► Note the messages on the driver's display.</p> <p><b>If the coolant temperature display is at the lower end of the temperature scale:</b></p> <p>► Consult a qualified specialist workshop.</p> <p><b>If the coolant temperature display is at the upper end of the temperature scale:</b></p> <p>► Exit the vehicle and keep a safe distance from it until the engine has cooled down.</p> <p>► Check the coolant level (→ page 378).</p> <p>► Make sure that the air supply to the radiator is not obstructed.</p> <p>► Avoiding high loads on the engine, drive to the nearest qualified specialist workshop. In doing so, ensure that the coolant temperature display remains below the red area.</p>
 <p>Coolant warning lamp (yellow)</p>	<p>* The yellow coolant warning lamp is lit while the engine is running.</p> <p>Possible causes are:</p> <ul style="list-style-type: none"> <li>• The temperature sensor is malfunctioning</li> <li>• The charge air, transmission oil or battery cooling is faulty</li> <li>• The radiator shutters are blocked or defective</li> </ul> <p>► Avoiding high loads on the engine, drive to the nearest qualified specialist workshop.</p>





Warning/indicator lamp	Possible causes/consequences and ► Solutions
 <p data-bbox="144 342 417 366">Check Engine warning lamp</p>	<p data-bbox="463 249 1628 394">* The yellow Check Engine warning lamp is lit while the engine is running. A malfunction has occurred in the engine, the exhaust system or the fuel system. The emissions limit value may have been exceeded and the engine may be running in emergency operation mode. In some states, legal requirements stipulate that you must immediately consult a qualified specialist workshop as soon as the yellow Check Engine warning lamp lights up.</p> <p data-bbox="476 405 1289 428">► Have the vehicle checked as soon as possible at a qualified specialist workshop.</p>
 <p data-bbox="144 539 417 588">Electrical malfunction warning lamp</p>	<p data-bbox="463 446 957 495">* The red electrical malfunction warning lamp is lit. There is a malfunction in the electrics.</p> <p data-bbox="476 505 925 529">► Note the messages on the driver's display.</p>
 <p data-bbox="144 701 417 750">Engine operating temperature warning lamp</p>	<p data-bbox="463 608 1535 656">* <b>Vehicles with a gasoline engine:</b> after a cold start, the blue engine operating temperature warning lamp is on. Engine output and engine torque are reduced.</p> <p data-bbox="476 667 981 691">► Take this into consideration in your driving style.</p>



Warning/indicator lamp	Possible causes/consequences and ► Solutions
 <p>Fuel reserve warning lamp flashes</p>	<p>* The yellow fuel reserve warning lamp lights up while you are driving. There has been pressure loss in the fuel system. The fuel filler cap is not closed correctly or the fuel system is leaking.</p> <ul style="list-style-type: none"><li>► Close the fuel filler cap.</li></ul> <p>If the fuel filler cap has already been closed correctly:</p> <ul style="list-style-type: none"><li>► Consult a qualified specialist workshop.</li></ul>
 <p>Fuel reserve warning lamp lights up</p>	<p>* The yellow fuel reserve warning lamp lights up while the engine is running. The fuel supply has dropped into the reserve range.</p> <ul style="list-style-type: none"><li>► Refuel.</li></ul>

## Brakes



Warning/indicator lamp	Possible causes/consequences and ► Solutions
 <p>Electric parking brake indicator lamp (red) (USA only)</p>  <p>Electric parking brake indicator lamp (red) (Canada only)</p>  <p>Electric parking brake indicator lamp (yellow)</p>	<p>* The red electric parking brake indicator lamp flashes or is lit. The yellow electric parking brake indicator lamp is also lit in the event of a malfunction.</p> <ul style="list-style-type: none"><li>► Note the messages on the driver's display.</li></ul>







Warning/indicator lamp	Possible causes/consequences and ► Solutions
 <p>RBS warning lamp (USA only)</p>  <p>Brakes warning lamp (yellow) (Canada only)</p>	<p>*The yellow  warning lamp (USA only) or the yellow  brake warning lamp (Canada only) is lit while the vehicle is running.</p> <p><b>▲ WARNING</b> Risk of an accident due to a brake system malfunction</p> <p>If the brake system is malfunctioning, braking characteristics may be impaired.</p> <ul style="list-style-type: none"><li>► Drive on carefully.</li><li>► Have the brake system checked immediately at a qualified specialist workshop.</li></ul> <p>The Hill Start Assist may be malfunctioning.</p> <ul style="list-style-type: none"><li>► Adjust your speed and drive on carefully, leaving a suitable distance to the vehicle in front.</li><li>► If the driver's display shows a display message, observe it.</li><li>► Consult a qualified specialist workshop.</li></ul>



Warning/indicator lamp	Possible causes/consequences and ► Solutions
 <p>Brakes warning lamp (USA only)</p>  <p>Brakes warning lamp (Canada only)</p>	<p>* The red brake warning lamp is lit while the vehicle is running.</p> <p>Possible causes are:</p> <ul style="list-style-type: none"><li>• The brake force boosting is malfunctioning and the braking characteristics may be affected.</li><li>• There is insufficient brake fluid in the brake fluid reservoir.</li></ul> <p>► Note the messages on the driver's display.</p> <p><b>▲ WARNING</b> Risk of accident and injury if brake force boosting is malfunctioning</p> <p>If brake force boosting is malfunctioning, increased brake pedal force may be necessary for braking. The braking characteristics may be impaired. The braking distance can increase in emergency braking situations.</p> <ul style="list-style-type: none"><li>► Stop in a safe location immediately. Do not continue driving.</li><li>► Consult a qualified specialist workshop.</li></ul> <p><b>▲ WARNING</b> Risk of an accident due to low brake fluid level</p> <p>If the brake fluid level is too low, the braking effect and the braking characteristics may be impaired.</p> <ul style="list-style-type: none"><li>► Pull over and stop the vehicle safely as soon as possible, paying attention to road and traffic conditions. Do not continue driving under any circumstances.</li><li>► Consult a qualified specialist workshop.</li><li>► Do not add brake fluid.</li></ul>

## Driving and driving safety systems

Warning/indicator lamp	Possible causes/consequences and ► Solutions
 <p data-bbox="195 381 375 407">ABS warning lamp</p>	<p data-bbox="513 291 1136 339">* The yellow ABS warning lamp is lit while the vehicle is running. ABS is malfunctioning.</p> <p data-bbox="526 350 1112 376">If an additional warning tone sounds, EBD is malfunctioning.</p> <p data-bbox="526 386 1280 412">Other driving systems and driving safety systems may also be malfunctioning.</p> <p data-bbox="526 422 975 448">► Note the messages on the driver's display.</p> <div data-bbox="532 464 1707 676" style="border: 1px solid gray; padding: 5px;"> <p data-bbox="541 469 1252 495"><b>⚠ WARNING</b> There is a risk of skidding if EBD or ABS is malfunctioning</p> <p data-bbox="541 510 901 536">The wheels may lock during braking.</p> <p data-bbox="541 547 1668 595">The steerability and braking characteristics are heavily impaired and the braking distance may increase. In addition, other driving safety systems are switched off.</p> <ul style="list-style-type: none"> <li data-bbox="541 606 759 631">► Drive on carefully.</li> <li data-bbox="541 642 1350 668">► Have the brake system checked immediately at a qualified specialist workshop.</li> </ul> </div>
 <p data-bbox="195 785 463 811">ESP® warning lamp flashes</p>	<p data-bbox="513 695 1193 743">* The yellow ESP® warning lamp flashes while the vehicle is in motion. One or more wheels have reached their grip limit (→ page 225).</p> <p data-bbox="526 754 1188 780">► Adapt your driving style to suit the road and weather conditions.</p>

Warning/indicator lamp	Possible causes/consequences and ► Solutions
 <p>ESP® warning lamp lights up</p>	<p>* The yellow ESP® warning lamp is lit while the vehicle is running. ESP® is malfunctioning. Other driving systems and driving safety systems (e.g. BAS) may also be malfunctioning.</p> <p>► Note the messages on the driver's display.</p> <p><b>▲ WARNING</b> Risk of skidding if ESP® is malfunctioning</p> <p>If ESP® is malfunctioning, ESP® cannot carry out vehicle stabilization. In addition, other driving safety systems are switched off.</p> <ul style="list-style-type: none"> <li>► Drive on carefully.</li> <li>► Have ESP® checked at a qualified specialist workshop.</li> </ul>
 <p>ESP® OFF warning lamp</p>	<p>* The yellow ESP® OFF warning lamp is lit while the vehicle is running. ESP® is deactivated. Other driving systems and driving safety systems may also be inoperative.</p> <p><b>▲ WARNING</b> Risk of skidding when driving with ESP® deactivated</p> <p>ESP® does not act to stabilize the vehicle. The availability of further driving safety systems is also limited.</p> <ul style="list-style-type: none"> <li>► Drive on carefully.</li> <li>► Deactivate ESP® only for as long as the situation requires.</li> </ul>

Warning/indicator lamp	Possible causes/consequences and ► Solutions
	<p>If ESP® cannot be activated, ESP® is malfunctioning.</p> <ul style="list-style-type: none"> <li>► Have ESP® checked immediately at a qualified specialist workshop.</li> </ul> <p>► Observe the notes on deactivating ESP® (→ page 225).</p>
 <p>ATTENTION ASSIST warning lamp</p>	<p>* The ATTENTION ASSIST warning lamp is lit. ATTENTION ASSIST is malfunctioning.</p> <ul style="list-style-type: none"> <li>► Consult a qualified specialist workshop.</li> </ul>
 <p>Traffic Sign Assist warning lamp</p>	<p>* The Traffic Sign Assist warning lamp is lit. Traffic Sign Assist is malfunctioning.</p> <ul style="list-style-type: none"> <li>► Note the messages on the driver's display.</li> </ul>
 <p>Distance warning lamp</p>	<p>* The red distance warning lamp lights up while the vehicle is in motion. The distance to the vehicle in front is too small for the speed selected.</p> <p>If there is an additional warning tone, you are approaching an obstacle at too high a speed.</p> <ul style="list-style-type: none"> <li>► Be prepared to brake immediately.</li> <li>► Increase the distance.</li> </ul>

Warning/indicator lamp	Possible causes/consequences and ► Solutions
 <p data-bbox="144 384 417 433">Active Brake Assist warning lamp</p>	<p data-bbox="476 249 931 275">Function of Active Brake Assist (→ page 250).</p> <p data-bbox="476 291 1480 339">* The Active Brake Assist warning lamp is on. Due to dirty sensors or a malfunction, the system is not available or the range of functions is restricted.</p> <p data-bbox="476 353 925 379">► Note the messages on the driver's display.</p>
 <p data-bbox="144 544 417 593">Active Brake Assist warning lamp</p>	<p data-bbox="476 451 1498 534">* The Active Brake Assist warning lamp is on. The system is switched off or the range of functions has been automatically restricted. This may be the case if the driver is not wearing a seat belt or another driving system has been activated.</p> <p data-bbox="476 544 1064 570">► Observe the notes on Active Brake Assist (→ page 250).</p>
 <p data-bbox="144 705 417 754">Active Brake Assist warning lamp</p>	<p data-bbox="476 612 1415 695">* The Active Brake Assist warning lamp is on. After you drive off, the system's range of functions will be restricted due to the teach-in process. Depending on the ambient conditions, the teach-in process may take a few minutes.</p> <p data-bbox="476 705 1064 731">► Observe the notes on Active Brake Assist (→ page 250).</p>

### Mercedes-Benz emergency call system

Warning/indicator lamp	Possible causes/consequences and ► Solutions
 <p data-bbox="195 381 463 425">Mercedes-Benz emergency call system warning lamp</p>	<p data-bbox="519 288 1687 311">*The Mercedes-Benz emergency call system is malfunctioning. The Mercedes me connect system is also malfunctioning.</p> <ul style="list-style-type: none"> <li data-bbox="528 317 948 340">► Consult a qualified specialist workshop.</li> </ul>

### Tire pressure monitor

Warning/indicator lamp	Possible causes/consequences and ► Solutions
 <p data-bbox="195 668 478 712">Tire pressure monitoring system warning lamp flashes</p>	<p data-bbox="519 574 1665 622">*The yellow tire pressure monitor warning lamp (pressure loss/malfunction) flashes for approximately one minute and then remains lit.</p> <p data-bbox="528 627 1055 651">The tire pressure monitoring system is malfunctioning.</p> <div style="border: 1px solid gray; padding: 5px; margin-top: 10px;"> <p data-bbox="537 677 1517 701"><b>▲ WARNING</b> There is a risk of an accident if the tire pressure monitoring system is malfunctioning</p> <p data-bbox="547 716 1622 740">The tire pressure monitoring system cannot issue a warning if there is pressure loss in one or more of the tires.</p> <p data-bbox="547 745 1563 769">Tires with insufficient tire pressure may impair the driving characteristics as well as steering and braking.</p> <ul style="list-style-type: none"> <li data-bbox="547 785 1406 809">► Have the tire pressure monitoring system checked at a qualified specialist workshop.</li> </ul> </div>

Warning/indicator lamp



Tire pressure monitoring system warning lamp lights up

Possible causes/consequences and ► Solutions

\* The yellow tire pressure monitoring system warning lamp (pressure loss/malfunction) is lit.  
The tire pressure monitoring system has detected tire pressure loss in at least one of the tires.

**▲ WARNING** Risk of an accident due to insufficient tire pressure

- The tires can burst.
- The tires can wear excessively and/or unevenly.
- The driving characteristics as well as the steering and braking may be greatly impaired.

You could then lose control of the vehicle.

- Observe the recommended tire pressures.
- Adjust the tire pressure if necessary.

- Stop the vehicle in accordance with the traffic conditions.
- Check the tire pressure and the tires.



**1, 2, 3 ...**

(SmartKey) battery.....	73
4MATIC.....	193
<b>48 V on-board electrical system</b>	
Displays in the driver's display.....	305
Operating safety.....	25

**A****A/C function**

Activating/deactivating (MBUX).....	154
Activating/deactivating (operating unit).....	154

<b>ABS</b> .....	224
------------------	-----

**Acceleration**

Kickdown.....	192
Optimized acceleration.....	170

<b>Accelerator pedal</b> .....	184
--------------------------------	-----

<b>Accident prevention</b> .....	285
----------------------------------	-----

<b>Accident, emergency call</b> .....	362
---------------------------------------	-----

<b>Activating/deactivating the acoustic lock- ing verification signal</b> .....	72
---	----

**Active Blind Spot Assist**

Activating/deactivating.....	264
Brake application.....	263
Exit warning.....	261
Function.....	261
Trailer operation.....	263

**Active Brake Assist**

Function.....	250
Setting.....	255

**Active Distance Assist DISTRONIC**

Activating/deactivating.....	236
Active Emergency Stop Assist.....	245
Active Lane Change Assist.....	246
Active Speed Limit Assist.....	238
Calling up a speed.....	236
Function.....	233
Increasing/decreasing the speed.....	236
Route-based speed adaptation.....	239
Storing a speed.....	236

<b>Active Emergency Stop Assist</b> .....	245
---	-----

<b>Active headlamps</b> .....	136
-------------------------------	-----

**Active Lane Change Assist**

Activating/deactivating.....	250
Function.....	246

**Active Lane Keeping Assist**

Activating/deactivating.....	266
Function.....	264
Setting the sensitivity.....	267
Towing a trailer.....	264

<b>Active light function</b> .....	136
------------------------------------	-----

**Active Parking Assist**

Automatic braking function.....	285
Cross traffic warning.....	286
Drive Away Assist.....	285
Exiting a parking space.....	284
Function.....	280
Maneuvering brake function.....	287
Memory Parking Assist.....	288
Parking.....	282
Pausing.....	284

<b>Active Service System PLUS</b> .....	371
---	-----

<b>Active Speed Limit Assist</b> .....	238
--	-----

**Active Steering Assist**

Activating/deactivating.....	244
Active Emergency Stop Assist.....	245
Active Lane Change Assist.....	246
Function.....	242

<b>Active Stop-and-Go Assist</b> .....	240
--	-----

- Adaptive cruise control**..... 239
- Adaptive Highbeam Assist**  
 Activating/deactivating..... 140
- Adaptive Highbeam Assist Plus**  
 Activating/deactivating..... 141
- Additives**  
 Engine oil..... 450  
 Fuel..... 449
- After-sales service**..... 371
- Air bag**  
 Front air bag..... 55  
 Inflating..... 50  
 Overview..... 55  
 PASSENGER AIR BAG indicator lamp..... 44  
 Warning lamp..... 42
- Air conditioning menu**  
 Air distribution..... 155  
 Climate control..... 154  
 Rear passenger compartment climate control..... 155
- Air distribution**  
 Adjusting..... 152, 155  
 Setting..... 151
- Air inlet**..... 379
- Air pressure**..... 414
- Air vents**  
 Adjusting..... 160
- Air/water duct**..... 379
- Airflow**  
 Adjusting..... 152  
 Setting..... 151
- Alarm system**..... 94
- All-wheel drive**..... 193
- Alternative route**..... 344
- Ambient lighting**..... 143
- AMG TRACK PACE**  
 Configuring..... 336  
 Drag Race..... 335  
 Function..... 333  
 Telemetry display..... 336  
 Track Race..... 333
- Angle of approach/departure**..... 454
- Animals**..... 51
- Anti-collision**  
 Drive Away Assist..... 285
- Anti-lock braking system**..... 224
- Anti-theft alarm system**..... 94
- Anti-theft protection**  
 Immobilizer..... 94
- Anticipatory operating-mode strategy,**  
 Route-based..... 184
- Apps, Mercedes me**  
 Mercedes me calls..... 354  
 Mercedes me connect..... 357
- Assistance system**..... 223
- ASSYST PLUS**  
 Battery disconnection periods..... 372  
 Service interval display..... 371  
 Service requirements..... 371
- ATA**  
 Deactivating the alarm..... 95  
 Function..... 94  
 Interior protection..... 97  
 Interior protection function..... 96  
 Tow-away alarm function..... 95  
 Tow-away protection..... 96
- ATTENTION ASSIST**  
 Function..... 230

- Setting..... 231
- Attention assistant**..... 230
- Authorized Mercedes-Benz Service Center**..... 31
- Authorized workshop**..... 31
- Automatic car wash**..... 379, 380
- Automatic car wash mode**..... 381
- Automatic climate control**..... 155
- Automatic distance control**..... 233
- Automatic driving lights**..... 134
- Automatic emergency call**..... 362
- Automatic engine start/stop**..... 177
- Automatic front passenger air bag shutoff**  
 Function..... 46  
 Information (child restraint system on  
 the front passenger seat)..... 60  
 PASSENGER AIR BAG indicator lamp..... 44
- Automatic Lane Change**  
 Active Lane Change Assist..... 246
- Automatic measures after an accident**..... 49
- Automatic mirror folding function**..... 150
- Automatic seat adjustment**..... 104
- Automatic transmission**  
 DIRECT SELECT lever..... 189  
 Drive programs..... 185  
 DYNAMIC SELECT button..... 185  
 Engages neutral..... 190  
 Engaging drive position..... 191  
 Engaging reverse gear..... 190  
 Kickdown..... 192  
 Manual gear shifting..... 191  
 Oil temperature (driver's display)..... 303  
 Selecting park position..... 190  
 Steering wheel paddle shifters..... 191  
 Switching gears..... 189  
 Transmission position display..... 189  
 Transmission positions..... 189
- Autonomous braking**..... 250
- Axle load**  
 Towing a trailer..... 456
- B**
- Bag hook**..... 124
- Ball neck**  
 Installing..... 297
- BAS**..... 224
- Basic information**..... 39
- Battery**  
 High-voltage battery..... 399
- Battery (12 V battery)**  
 Charging..... 401  
 Notes..... 396  
 Notes (starting assistance and charg-  
 ing)..... 400  
 Replacing..... 403  
 Starting assistance..... 401
- Battery (48 V)**  
 Notes..... 398
- Battery (starter battery)**  
 charging, Remote Online..... 168
- Battery operation**..... 162
- Beginner driver mode**  
 Activating/deactivating..... 229  
 Function..... 229
- Belt**  
 Fastening..... 41  
 Notes on wearing correctly..... 41  
 Releasing..... 55  
 To adjust the height..... 41

<b>Bicycle rack</b>	
Load capacity.....	456
<b>Blind Spot Assist</b>	
Activating/deactivating.....	264
Function.....	261
<b>Bluetooth®</b>	
Connecting a mobile phone.....	353
<b>Boost pressure, current (driver's display).....</b>	303
<b>Brake Assist</b>	
Active Brake Assist.....	250
Brake Assist System.....	224
<b>Brake Assist System.....</b>	224
<b>Brake disks.....</b>	169
<b>Brake fluid.....</b>	451
<b>Brake force distribution.....</b>	227
<b>Brake pads.....</b>	169
<b>Brakes</b>	
ABS (Anti-lock Braking System).....	224
Active Brake Assist.....	250
BAS (Brake Assist System).....	224
Driving tips.....	171
EBD (Electronic Brakeforce Distribution).....	227

Electric parking brake.....	217
Handbrake.....	217
HOLD function.....	227
Limited braking effect (salt-treated roads).....	171
New/replaced brake pads/brake discs..	169
Notes on breaking in a new vehicle.....	169
Parking brake.....	217
Post-collision brake.....	49
Recuperation.....	181
<b>Braking assistance</b>	
Active Brake Assist.....	250
Brake Assist System.....	224
<b>Breakdown</b>	
Changing a wheel.....	436
Flat tire.....	390
Overview of aids.....	18
Tow-starting.....	409
Towing methods.....	405
Transporting the vehicle.....	407
<b>Breakdown (Roadside Assistance).....</b>	25

## C

<b>Calling the customer center for Mercedes-Benz.....</b>	355
<b>Calls</b>	
Mercedes me.....	354
Telephone menu.....	353
Using overhead control panel.....	354
<b>Camera</b>	
360° camera.....	269
Activating using GPS (reversing camera).....	275
Button.....	275
Care.....	383
Cleaning.....	383
Function.....	269
Information.....	222
Managing activation points.....	275
Off-road function.....	273
Opening the camera cover (rear view camera).....	276
Rear view camera.....	267
Select view.....	275
Transparent hood.....	273
<b>Car key.....</b>	71

**Car wash**

- Automatic car wash..... 379, 380
- Power washer..... 381
- Washing by hand..... 382

**Car-to-X-Communication**

- Display on map..... 347

**Care**

- Air/water duct..... 379
- Automatic car wash..... 379, 380
- Camera..... 383
- Decorative foil..... 383
- Display..... 385
- Exterior lighting..... 383
- Genuine wood/trim elements..... 385
- Head-up display..... 385
- Headliner..... 385
- Paint..... 382
- Plastic trim..... 385
- Power washer..... 381
- Running boards..... 383
- Seat belts..... 385
- Steering wheel..... 385
- Trailer hitch..... 383
- Vehicle interior..... 385
- Vehicle parts..... 383

**Vehicle socket for the high-voltage**

- battery..... 383
- Washing by hand..... 382
- Wheels/rims..... 383

**Cargo compartment cover**

- Extending/retracting..... 120
- Removing/installing..... 121

**Caring for plastic trim**

- ..... 385

**Caring for rims**

- ..... 383

**Central display**

- Operating..... 322

**Central locking system**

- Button..... 78
- SmartKey..... 72

**Change of address**

- ..... 25

**Change of ownership**

- ..... 25

**Changing a wheel**

- Preparation..... 436
- Raising the vehicle..... 437

**Charge level display**

- ..... 212

**Charge level/charge display**









- ..... 212

**Charging**





































- 12 V battery..... 401
- At time of departure..... 337
- Charge level display..... 212
- Charging cable control panel..... 203
- Charging station, mode 3..... 201
- Configuring weekly profile..... 337
- Emergency release of the socket flap..... 211
- Ending the charging process (alternating current, mode 2/3)..... 208
- Ending the charging process (direct current, mode 4)..... 211
- Indicator lamps on vehicle socket..... 204
- Mains socket, mode 2..... 200
- Maximum charging current (mains socket)..... 202
- Notes on charging the high-voltage battery..... 196
- Notes on the high-voltage battery..... 399
- Rapid charging station, mode 4..... 201
- Recuperation..... 181
- Starting the charging process (alternating current, mode 2/3)..... 205
- Starting the charging process (direct current, mode 4)..... 209
- Stowing the charging cable..... 198





































- USB port..... 116, 129
- Wallbox, mode 3..... 201
- Wirelessly charging a mobile phone..... 129
- Charging cable**
  - Control panel..... 203
  - Stowing..... 198
- Charging settings**..... 337
- Checking the coolant level**..... 378
- Child safety lock**
  - Rear door..... 68
  - Side windows (rear passenger compartment)..... 69
- Child seat**
  - Adjusting the vehicle seat..... 62
  - Basic instructions..... 56
  - Front passenger seat..... 60
  - Installing ISOFIX..... 65
  - Rearward-facing..... 62
  - Risks/dangers..... 58
  - Securing on the rear seat with the seat belt..... 67
  - Securing to the front passenger seat with the seat belt..... 67
  - The most important information in brief... 56
- Top Tether..... 66
- Children**
  - Avoiding dangers in the vehicle..... 58
  - Basic instructions..... 56
  - Special seat belt retractor..... 64
- Chock**..... 435
- Clean varnish**..... 382
- Cleaning**
  - Air/water duct..... 379
  - Automatic car wash..... 379, 380
  - Camera..... 383
  - Decorative foil..... 383
  - Genuine wood/trim elements..... 385
  - Paint..... 382
  - Power washer..... 381
  - Sensors..... 383
  - Vehicle interior..... 385
  - Vehicle parts..... 383
  - Vehicle socket for the high-voltage battery..... 383
  - Washing by hand..... 382
- Cleaning carpets**..... 385
- Cleaning seat covers**..... 385
- Climate control, Air conditioning system**
  - Activating/deactivating..... 153
  - Activating/deactivating (rear operating unit)..... 154
  - Activating/deactivating the A/C function (control panel)..... 154
  - Activating/deactivating the A/C function (MBUX)..... 154
  - Air distribution..... 151, 152
  - Air vents (front)..... 160
  - Air vents (rear passenger compartment)..... 161
  - Airflow..... 151, 152
  - Automatic control..... 155
  - Defrosting a window..... 154
  - Defrosting the windshield..... 151
  - Defrosting windows..... 156
  - Demisting the windshield..... 152
  - Filling capacity for refrigerant and PAG oil..... 454
  - Immediate pre-entry climate control..... 159
  - Notes..... 151
  - Operating unit..... 151, 152
  - Pre-entry climate control for departure time..... 158















- Pre-entry climate control when the vehicle is unlocked..... 157
- Rear passenger compartment operating unit..... 153
- Rear window defroster..... 151
- Rear window heating..... 152
- Refrigerant..... 453
- Residual heat..... 156
- Switching air-recirculation mode on/off..... 156
- Synchronization function..... 155
- Temperature..... 151, 152
- Ventilation with comfort opening..... 89
- COC papers, CERTIFICATE OF CONFORMITY**..... 443
- Cockpit**
- Instrument panel..... 6, 8
- Coffee cup symbol**..... 230
- Collision detection (parked vehicle)**
- Setting..... 219, 220
- Combination switch**
- Lights..... 134
- Windshield wipers..... 144
- Commuter route**..... 344
- Components relevant to radio regulation**
- Declaration of conformity..... 29
- Control elements**..... 23
- Convenience closing feature**..... 89
- Convenience opening**..... 89
- Coolant**
- Capacity..... 452
- Notes..... 451
- Cooling**..... 151, 152
- Copyright**
- License..... 38
- Copyrights**
- Trademarks..... 38
- Correct use**..... 31
- Cover**..... 90
- Cross traffic (warning)**..... 286
- Crosswind Assist**..... 226
- Cruise control**
- Activating/deactivating..... 232
- Calling up a speed..... 232
- Function..... 231
- Requirements:..... 232
- Setting a speed..... 232
- Storing a speed..... 232
- Cup holder**..... 125, 127
- Customer Assistance Center (CAC)**..... 32
- Customer Relations Department**..... 32
- D**
- Damage**
- Limited protection..... 51
- Dashcam**
- Notes..... 349
- Selecting a USB device..... 349
- Starting/stopping loop recording..... 350
- Data processing in the vehicle**..... 34
- Data protection rights**..... 37
- Data storage**
- Data protection rights..... 37
- Electronic control units..... 34
- Event Data Recorder..... 37
- MBUX multimedia system/Mercedes me connect..... 37
- Online services..... 36

- Daytime running lamps**, Daytime running lamp mode  
 Activating/deactivating..... 142
- Deactivating the alarm**..... 95
- Dealership**..... 31
- Declaration of conformity**  
 Components relevant to radio regulation.. 29
- Decorative foil**..... 383
- Definitions**  
 Tires and loading..... 429
- Defrost function**..... 154
- Deployed components**  
 Limited protection..... 51
- Deployment situations**..... 50
- Destination entry**..... 343
- Detecting inattentiveness**..... 230
- Diagnostics connection**..... 30
- DIGITAL LIGHT**  
 Activating/deactivating..... 138  
 Active headlamps..... 136  
 Adaptive Highbeam Assist..... 139  
 Adaptive Highbeam Assist Plus..... 140  
 Assistance functions..... 136  
 Dynamic low beam..... 136  
 Overview..... 136  
 Topographical compensation..... 136
- Digital Operator's Manual**..... 20
- Digital Vehicle Key**  
 Problem..... 77  
 Starting the vehicle..... 167  
 Unlocking/locking the vehicle..... 75
- Dinghy towing**  
 Pulling/towing..... 299
- Direct commands**  
 Voice commands for MBUX voice assistant..... 314
- DIRECT SELECT lever**  
 Automatic transmission..... 189  
 Engages neutral..... 190  
 Engaging drive position..... 191  
 Engaging park position automatically..... 190  
 Engaging reverse gear..... 190  
 Function..... 189  
 Gearshift recommendation..... 192  
 Manual gearshifting..... 191  
 Selecting park position..... 190
- Display**  
 Care..... 385
- Display (driver's display)**  
 Overview of displays..... 306
- Display message**  
 Calling up on driver display..... 457  
 Notes..... 457
- Display messages**  
 --- mph..... 507  
 --- mph..... 505  
 12 V On-board Electrical System Service Required..... 522  
 48 V Battery See Operator's Manual..... 524  
 Acoustic Presence Indicator Inoperative..... 474  
 Add Washer Fluid..... 488  
 ATTENTION ASSIST: Take a Break!..... 505  
 Automatic Driving Lights Inoperative..... 469



-  Battery Overheated Stop!  
Everyone Get Out! Outdoors if Possible..... 476, 524
-  BRAKE Brake Immediately..... 499
-  Camera View Reduced See Operator's Manual..... 518
-  Charger Cable Connected..... 474
-  BRAKE Check Brake Fluid Level..... 500
-  Check Coolant Level See Operator's Manual..... 489
-  Check Engine Oil Level At Next Refueling (Add 1 Quart)..... 529
-  Check Left Low Beam (example).. 468
-  Check Tires..... 526
-  Coolant Stop Switch Off Vehicle... 489
-  Currently Not Available Charge High-voltage Battery..... 472
-  Currently Not Available Charging of the High-voltage Battery Not Completed..... 472
-  Currently Unavailable See Operator's Manual..... 501
-  Currently Unavailable See Operator's Manual..... 502
-  Digital Vehicle Key Charge Device..... 467
-  Do Not Exceed 25 mph..... 506
-  Do Not Leave People or Animals in the Vehicle..... 462
-  Don't Forget Your Key..... 464
-  Drive Power and Range Reduced See Operator's Manual..... 478
-  Engine Oil Level Cannot Be Measured..... 531
-  Engine Oil Level Reduce Oil Level..... 529
-  Engine Oil Level Stop Switch Off Vehicle..... 530
-  Engine Oil Pressure Stop Switch Off Vehicle..... 530
-  Front Left Malfunction Service Required (Example)..... 459
-  Fuel Filler Cap Open..... 491
-  Fuel Reserve..... 490
-  Fuel Tank Is Depressurized Ready for Refueling..... 480
-  Functions Limited When Towing Trailer..... 519
-  Have High-Voltage System Checked See Operator's Manual..... 477
-  Initializing Key Please Wait..... 464
-  Initializing Key Please Wait..... 468
-  Initiating Emergency Stop..... 510, 516
-  Inoperative See Operator's Manual..... 502
-  Inoperative See Operator's Manual..... 503
-  EBD Inoperative See Operator's Manual..... 504
-  Inoperative..... 521

- |  |   |  |
|--|---|--|
|  Inoperative..... 506   |  Obtain a New Key..... 462   |  Rear Axle Steering Malfunction Service Required..... 486                     |
|  Key Does Not Belong to Vehicle... 468                                      |  Off..... 507  |  Rear Axle Steering Malfunction Stop Immediately..... 486                     |
|  Key Not Detected (red display message)..... 463                            |  HOLD Off..... 504   |  Rear Left Backrest Not Latched (example)..... 488                            |
|  Key Not Detected (white display message)..... 463                          |  PARK Parking Brake See Operator's Manual..... 495   |  Reduce Speed..... 528  |
|  Key Not Detected Place Digital Vehicle Key in Mobile Phone Cradle..... 466 |  Performance Extremely Limited.... 480   |  PARK Release Parking Brake..... 498  |
|  Key Not Detected..... 465  |  Please Correct Tire Pressure..... 527   |  Replace Key Battery..... 463   |
|  Left Window Airbag Malfunction Service Required (Example)..... 460         |  Please Wait Charging 48 V Battery..... 524  |  Replace SmartKey See Operator's Manual..... 467                              |
|  BRAKE Malfunction See Operator's Manual..... 499                           |  Please Wait Depressurizing Fuel Tank..... 480   |  Restraint System Malfunction Service Required..... 458                       |
|  Malfunction See Operator's Manual..... 469                                 |  Pre-entry Climate Control Available Again via SmartKey after Vehicle Start..... 472               |  Steering Malfunction Drive Carefully Service Required..... 484               |
|  Malfunction Service Required..... 477                                      |  Pre-entry Climate Control via SmartKey Currently Not Available. High-voltage Battery Low..... 473 |  Steering Malfunction Increased Physical Effort See Operator's Manual.... 485 |
|  BRAKE Malfunction Stop..... 500  |  Rear Axle Steering Currently Malfunctioning..... 485  |  Steering Malfunction Stop Immediately See Operator's Manual..... 485         |
|  Malfunction..... 479   |   |  Stop Switch Off Vehicle..... 479   |
|  Malfunction..... 477   |   |  |
|  Not in Curr. Drive Prog..... 506   |   |  |

-  Stop Vehicle See Operator's Manual..... 522
-  Stop Vehicle See Operator's Manual..... 523
-  Stop Vehicle To Charge the 12 V Battery Do Not Switch Off Vehicle..... 523
-  Suspended..... 507
-  Switch Off Lights..... 469
-  Switch On Headlights..... 469
-  Switch on vehicle to charge the 12 V battery..... 523
-  Switch on Vehicle to Release the Parking Brake..... 498
-  Take SmartKey With You..... 467
-  Tank Ventilation Malfunction Service Required..... 481
-  Temporarily Unavailable Sensors Dirty..... 517
-  Tires Overheated..... 528
-  Towing Not Permitted See Operator's Manual..... 473
-  Warning Tire Malfunction..... 527
-  Wheel Sensor(s) Missing..... 526
- "Electric" Drive Program Currently Unavailable..... 476
- AC Charging Inoperative Service Required..... 475
- Active Blind Spot Assist Currently Unavailable See Operator's Manual..... 514
- Active Blind Spot Assist Inoperative..... 515
- Active Blind Spot Assist Not Available When Towing Trailer See Operator's Manual..... 515
- Active Brake Assist Functions Currently Limited See Operator's Manual..... 508
- Active Brake Assist Functions Limited See Operator's Manual..... 509
- Active Distance Assist Currently Unavailable See Operator's Manual..... 507
- Active Distance Assist Inoperative..... 508
- Active Distance Assist Now Available..... 508
- Active Emergency Stop Assist Currently Unavailable See Operator's Manual..... 511
- Active Emergency Stop Assist Inoperative..... 511
- Active Lane Change Assist Currently Unavailable See Operator's Manual..... 512
- Active Lane Change Assist Inoperative... 512
- Active Lane Keeping Assist Currently Unavailable See Operator's Manual..... 515
- Active Lane Keeping Assist Inoperative... 515
- Active Lane Keeping Assist Limited Range of Functions See Operator's Manual..... 516
- Active Parking Assist and PARKTRONIC Inoperative See Operator's Manual..... 520

- Active Parking Assist Limited Availability of Maneuvering Assistance See Operator's Manual..... 521
- Active Steering Assist Currently Unavailable Due to Multiple Emergency Stops..... 510
- Active Steering Assist Currently Unavailable See Operator's Manual..... 509
- Active Steering Assist Inoperative..... 510
- Active Stop & Go Assist Currently Unavailable See Operator's Manual..... 513
- Active Stop & Go Assist Inoperative See Operator's Manual..... 513
- Adaptive Highbeam Assist Currently Unavailable See Operator's Manual..... 470
- Adaptive Highbeam Assist Inoperative.... 470
- Adaptive Highbeam Assist Plus Currently Unavailable See Operator's Manual..... 470
- Adaptive Highbeam Assist Plus Inoperative..... 471
- Automatic Lane Change Currently Unavailable See Operator's Manual..... 512
- Automatic Lane Change Inoperative..... 513
- Auxiliary Battery Malfunction (red display message)..... 495
- Auxiliary Battery Malfunction (white display message)..... 494
- Blind Spot Assist Currently Unavailable See Operator's Manual..... 514
- Blind Spot Assist Inoperative..... 514
- Blind Spot Assist Not Available When Towing Trailer See Operator's Manual..... 514
- Cannot Start Vehicle See Operator's Manual..... 478, 482
- Charging Fault Change Charging Mode See Operator's Manual..... 475
- Charging Mode Currently Unavailable Try Again or Change Charging Mode..... 475
- Check Brake Pads See Operator's Manual..... 501
- Cruise Control Inoperative..... 505
- Cruise Control Off..... 505
- DC Charging Inoperative Service Required..... 475
- Depress Brake to Shift from P..... 491
- Depress Brake to Shift to D or R..... 492
- Depress Brake to Shift to R..... 492
- DIGITAL LIGHT Functions Limited..... 470
- Do Not Restart Vehicle Service Required..... 478
- Drive Malfunction Achievable Speed Limited Stop Soon..... 479
- Drive Malfunction Achievable Speed Severely Limited See Operator's Manual..... 479
- Front Passenger Airbag Disabled See Operator's Manual..... 460

Front Passenger Airbag Enabled See Operator's Manual.....	461		
Hazard Warning Light Malfunction.....	471		
Head-up Display Brightness Currently Reduced See Operator's Manual.....	484		
Head-up Display Currently Unavailable See Operator's Manual.....	483		
Head-up Display Inoperative.....	484		
N Automatically Activated Please Shift to Transmission Position Again.....	493		
N is Engaged Shift to Desired Drive Range.....	494		
Not Possible to Unlock Charging Cable See Operator's Manual.....	474		
Occupant Presence Reminder Inoperative.....	462		
Only Electric Drive Available Power Limited.....	475		
		PARKTRONIC and Maneuvering Assistance Unavailable at Rear When Towing Trailer.....	520
		PARKTRONIC Inoperative See Operator's Manual.....	520
		Place the Key in the Marked Space See Operator's Manual.....	464
		PRE-SAFE Inoperative See Operator's Manual.....	519
		PRE-SAFE PLUS Inoperative See Operator's Manual.....	519
		PRE-SAFE Pulse Side Inoperative See Operator's Manual.....	519
		Preparing Drive System.....	476
		Reduced Drive System Performance See Operator's Manual.....	476
		Restricted Mode Activated Drive Power Reduced.....	504
		Reversing Not Possible Service Required.....	494
		Risk of Vehicle Rolling Away Apply Parking Brake When Parking.....	492
		Risk of Vehicle Rolling Away Driver's Door Open Position P Not Selected.....	492
		Risk of Vehicle Rolling Away N Activated Manually No Automatic Change to P.....	493
		Searching for Key in Stowage Tray or Digital Vehicle Key in Inductive Charging Bracket... See Operator's Manual.....	465
		Service Required Apply Parking Brake to Park.....	492
		Service Required Do Not Change Transmission Position.....	477, 494
		Shift to P Only When Vehicle Is Stationary.....	491
		Snow Chain Mode Maximum Speed Exceeded.....	487
		Starting Possible Again.....	525

- Tire Pressure Monitor Currently Unavailable..... 525
- Tire Pressure Monitor Inoperative..... 525
- Tire Pressure Monitor Inoperative Tire Pressure Sensors Missing..... 526
- To Deselect P or N Depress Brake and Start Vehicle..... 491
- To Switch Off Vehicle Press and Hold Start/Stop Button for at Least 3 Seconds or Press 3 Times..... 489
- Traffic Sign Assist Currently Unavailable See Operator's Manual..... 505
- Traffic Sign Assist Inoperative..... 505
- Transmission Malfunction Stop..... 494
- Vehicle Currently Not Charging... Charging Station Fault..... 474
- Vehicle Ready to Drive Shutdown Occurs When Locked or After a Few Minutes..... 483
- Vehicle Ready to Drive Shutdown Occurs When Locked or Automatically in XX Mins..... 483
- Windshield Wiper Malfunction..... 488
- Displaying road names/house numbers**..... 344
- Distance control**..... 233
- Distance warning**..... 250
- DISTRONIC**..... 233
- Door**
  - Child safety lock (rear door)..... 68
  - Emergency key..... 80
  - Opening (from the inside)..... 77
  - Unlocking (inside)..... 77
- Door operating unit**
  - Function seat..... 16
- DOT, Tire Identification Number (TIN)**..... 425
- Downhill Speed Regulation**..... 241
- Drag Race**..... 335
- Drinking and driving**..... 171
- Drive Away Assist**..... 285
- Drive position**..... 191
- Drive program display**..... 187
- Drive programs**
  - Selecting..... 187
- Driver's display, Instrument cluster**
  - 48 V on-board electrical system..... 305
  - Head-up display..... 303
  - Menus..... 302
  - Notes..... 301
  - Operating..... 301
  - Service due date..... 371
  - Status displays..... 306
  - Warning/indicator lamps..... 10, 531
- Driver's seat**
  - Adjusting (Seat Comfort)..... 99
  - Adjusting electrically..... 101
  - Easy entry and exit feature..... 110
  - Seat heating..... 106
- Driving off-road**..... 175
- Driving safety system**
  - ABS (Anti-lock Braking System)..... 224
  - Active Brake Assist..... 250
  - Active Lane Change Assist..... 246
  - Active Steering Assist..... 242
  - ATTENTION ASSIST..... 230

- BAS (Brake Assist System)..... 224  
 Blind Spot Assist / Active Blind Spot Assist..... 261  
 Cameras..... 222  
 Cruise control..... 231  
 EBD (Electronic Brakeforce Distribution)..... 227  
 ESP® (Electronic Stability Program)..... 225  
 Hill Start Assist..... 228  
 HOLD function..... 227  
 Off-road ABS..... 224  
 Overview..... 223  
 Radar and ultrasonic sensors..... 222  
 STEER CONTROL..... 227  
 Traffic Sign Assist..... 256  
 Trailer Maneuvering Assist..... 292  
 Your responsibility..... 221
- Driving system**..... 223
- Driving tips**
- Drinking and driving..... 171
  - General driving tips..... 171
  - Notes on breaking in a new vehicle..... 169
  - Off-road driving..... 175
  - Optimized acceleration..... 170
  - Rear axle steering..... 174
  - Recuperation..... 181
- Drowsiness detection**..... 230
- DSR**
- Activating/deactivating..... 242
  - Changing the target speed..... 242
  - Function..... 241
  - Notes..... 241
- Duplicate key**..... 75
- Dynamic handling control system**..... 225
- Dynamic low beam**
- Overview..... 136
- DYNAMIC SELECT**
- Calling up the fuel consumption indicator..... 189
  - Configuring drive program I..... 187
  - Displaying engine data..... 188
  - Displaying vehicle data..... 188
  - Drive program display..... 187
  - Drive programs..... 185
  - Function..... 185
  - Selecting the drive program..... 187
- E**
- E-mails**..... 312
- E10**..... 449
- Easy entry feature**
- Adjusting..... 111
  - Function..... 110
- Easy exit feature**
- Adjusting..... 111
  - Function..... 110
- EBD, Electronic Brakeforce Distribution**..... 227
- ECO Assist**
- 48 V on-board electrical system..... 179
  - Activating/deactivating..... 184
  - Plug-in hybrid..... 182
- ECO display**..... 179
- ECO start/stop button**
- Automatic engine start/stop..... 178
- ECO start/stop function**
- Automatic engine start..... 177
  - Automatic engine stop..... 177
  - Function..... 177
  - Switching off/on..... 178

- Electric drive**..... 162
- Electric parking brake**  
 Applying automatically..... 217  
 Emergency braking..... 219  
 Manually applying/releasing..... 219  
 Releasing automatically..... 218
- Electrical fuses**..... 409
- Electronic Stability Program**..... 225
- Emergency**  
 First-aid kit (soft sided)..... 390  
 Overview of aids..... 18  
 Reflective safety vest..... 389  
 Warning triangle..... 390
- Emergency braking**  
 Active Brake Assist..... 250  
 Brake Assist System..... 224  
 Carrying out..... 219  
 Electric parking brake/handbrake..... 217
- Emergency key**  
 Door..... 80  
 Tailgate..... 87
- Emergency operation mode**  
 Starting the vehicle..... 167
- Emergency release**  
 Socket flap..... 211
- Emergency shutoff (high-voltage on-board electrical system)**..... 164
- Emergency stop assistant**..... 245
- Emergency Tensioning Devices**  
 Inflating..... 50
- Energy flow display**  
 Function/notes..... 339
- Engine**  
 Emergency operation mode..... 167  
 Emergency start..... 409  
 Engine number..... 445  
 Jump-starting..... 400  
 Parking (start/stop button)..... 213  
 Starting (Digital Vehicle Key)..... 167
- Engine data**  
 Displaying..... 188  
 DYNAMIC SELECT..... 188
- Engine number**..... 445
- Engine oil, Oil**  
 Additives..... 450  
 Capacity..... 451  
 Checking the oil level using the driver display..... 376  
 MB-Freigabe or MB-Approval..... 451  
 Quality..... 451  
 Refilling..... 376  
 Temperature (driver's display)..... 303
- Engine oil temperature (driver's display)**..... 303
- Engine output, current (driver's display)**..... 303
- Environmentally friendly driving**..... 21
- ESC, Electronic Stability Control**..... 225
- ESP®**  
 Activating/deactivating..... 226  
 Crosswind Assist..... 226  
 Function..... 225  
 Trailer stabilization..... 226
- Event Data Recorder**..... 37
- Exit warning**  
 Blind Spot Assist / Active Blind Spot Assist..... 261
- Exiting a parking space**  
 Active Parking Assist..... 280  
 Drive Away Assist..... 285  
 PARKTRONIC..... 276



- Exterior lighting**  
 Care..... 383
- Exterior mirrors**  
 Parking position..... 149
- F**
- Factory settings**  
 MBUX reset function..... 332
- Favorites**..... 326
- Film coverings**  
 On camera/sensors..... 222
- First aid**  
 First-aid kit (soft sided)..... 390
- First-aid kit (soft sided)**..... 390
- Fitting accessories**  
 Limited protection..... 51
- Flat tire**  
 Changing a wheel..... 436  
 Notes..... 390  
 TIREFIT kit..... 392
- Flat towing**  
 Pulling/towing..... 299
- Floor mats**..... 131
- Fog lamp**..... 134
- Foil covering**  
 Radar and ultrasonic sensors..... 222
- Fording water**..... 454
- Free software**..... 38
- Frequencies**  
 Mobile phone..... 444  
 Two-way radio..... 444
- Front air bag**  
 Inflating..... 50
- Front headlamps**..... 133
- Front passenger air bag**  
 Disabling/enabling..... 45
- Front passenger air bag shutoff,**  
 PASSENGER AIR BAG OFF  
 Information (child restraint system on  
 the front passenger seat)..... 60
- Front passenger seat**  
 Adjusting (Seat Comfort)..... 99  
 Adjusting electrically..... 101
- Fuel**  
 Additives..... 449
- Depressurize the fuel tank (plug-in  
 hybrid with gasoline engine)..... 196
- E10..... 449
- Gasoline..... 449
- Quality (gasoline)..... 449
- Refilling..... 193
- Reserve..... 450
- Sulfur content..... 449
- Tank capacity..... 450
- Fuel consumption indicator**..... 189
- Fuel reserve**..... 450
- Function in the event of an accident**..... 50
- Function seat**..... 16
- Fuses**  
 Cargo compartment..... 412  
 Cockpit..... 411  
 Engine compartment..... 410  
 Fuse assignment diagram..... 409  
 Notes..... 409  
 Passenger footwell..... 411
- G**
- G-meter, Accelerometer**..... 303

- Garage door opener**  
 Clearing the memory..... 217  
 Opening/closing a door..... 217  
 Problem..... 217
- Garage door openers**  
 Programming buttons..... 215  
 Synchronizing the rolling code..... 216
- Gasoline**..... 449
- Gearshift**  
 DIRECT SELECT lever..... 189  
 Manual..... 191
- General driving tips**..... 171
- Genuine parts**..... 22
- Glide mode**..... 192
- Glove box**  
 Locking/unlocking..... 117
- Grab handles**..... 98
- H**
- Handbrake**..... 217
- Handling characteristics**  
 Unusual..... 413
- HANDS-FREE ACCESS**..... 84
- Haptic accelerator pedal, Pressure point**..... 184
- Hazard warning lights**..... 135
- Hazard warnings**  
 Car-to-X-Communication..... 347
- Head restraint**  
 Adjusting (rear passenger compartment)..... 103  
 Adjusting manually (front, 4-way)..... 102  
 Removing/installing (rear passenger compartment)..... 104
- Head-up display**  
 Care..... 385  
 Function..... 303  
 Memory function..... 112  
 Operating..... 304  
 Switching on/off..... 305
- Headlamp flashing**..... 134
- Headlamp range control**..... 136
- Headlamps**..... 133
- Heating**  
 Activating/deactivating..... 153  
 Center console..... 153
- Climate control..... 151, 152  
 Rear window..... 152  
 Seat..... 106  
 Steering wheel..... 109
- Help call**  
 Mercedes-Benz emergency call system.. 362
- High beam**..... 134
- High-voltage battery**  
 Charge level display..... 212  
 Charging at time of departure..... 337  
 Charging cable control panel..... 203  
 Charging station, mode 3..... 201  
 Configuring weekly profile..... 337  
 Ending the charging process (alternating current, mode 2/3)..... 208  
 Ending the charging process (direct current, mode 4)..... 211  
 Energy flow display..... 339  
 General notes on charging..... 196  
 Mains socket, mode 2..... 200  
 Maximum charging current (mains socket)..... 202  
 Notes..... 399  
 Rapid charging station, mode 4..... 201  
 Recuperation..... 181

- Starting the charging process (alternating current, mode 2/3)..... 205
- Starting the charging process (direct current, mode 4)..... 209
- Stowing the charging cable..... 198
- Wallbox, mode 3..... 201
- High-voltage on-board electrical system**
- Indicator lamps on vehicle socket..... 204
- Manual switch-off..... 164
- Operating safety..... 25
- Hill descent control**..... 241
- Hill Start Assist**..... 228
- HOLD function**
- Function..... 227
- Switching on/off..... 227
- Home screen**
- Central display..... 321
- Hood**
- Opening/closing..... 373
- I**
- Identification plate**
- Engine..... 445
- Refrigerant..... 453
- Vehicle..... 445
- Immediate pre-entry climate control**..... 159
- Immobilizer**..... 94
- Incorrect behavior by vehicle occupants**
- Limited protection..... 51
- Indicator/warning lamps**
- Driver's display..... 531
- PASSENGER AIR BAG..... 44
- Individual drive program**
- Configuring..... 187
- Inside rearview mirror**..... 148
- Installing**
- Snow chains..... 414
- Tires/wheels..... 439
- Instrument panel**
- Cockpit..... 6, 8
- Intelligent Light System**
- Activating/deactivating..... 138
- Interior lighting**
- Adjusting..... 142
- Ambient lighting..... 143
- Switch-off delay time..... 144
- Interior protection**..... 97
- Internet**
- Mercedes me connect..... 357
- Setting up a Wi-Fi hotspot..... 330
- Web browser..... 360
- ISOFIX child seat anchor**
- Installing..... 65
- J**
- Jack**
- Storage location..... 435
- Jump-start connection**..... 401
- K**
- Key**
- Problem..... 75
- Replacement key..... 75
- KEYLESS-GO**
- Deactivating..... 72
- Locking/unlocking the vehicle..... 78
- Problem..... 79
- Unlocking setting..... 72
- Kickdown**..... 192

Knee bag..... 55

## L

Lane Change Assist..... 246

Lane Keeping Assist..... 264

### Lane recognition

Active Lane Change Assist..... 246

Active Lane Keeping Assist..... 264

### Language

Notes..... 332

Setting..... 332

License plate (front)..... 29

License plate assembly (front)..... 29

Light switch..... 133

### Lighting

Dynamic low beam..... 136

Interior lighting..... 142

### Lights

Active headlamps..... 136

Adaptive Highbeam Assist..... 139

Adaptive Highbeam Assist Plus..... 140

Assistance functions..... 136

Automatic driving lights..... 134

Combination switch..... 134

DIGITAL LIGHT..... 136

Dynamic low beam..... 136

Hazard warning lights..... 135

High beam..... 134

Interior lighting..... 142

Locator lighting..... 142

Reading lamp..... 142

Rear fog light..... 134

Responsibility for lighting systems..... 133

Switch-off delay time..... 142

Switching on the daytime running

lamps..... 142

Switching the Intelligent Light System

on/off..... 138

Topographical compensation..... 136

Turn signals..... 134

Limited Warranty..... 33

Live Traffic Information..... 347

### Load capacity

Bicycle rack..... 456

### Load index

Tires..... 427

### Load protection net

Attaching..... 122

### Load-bearing capacity

Tires..... 427

### Loading

Bag hook..... 124

Definitions..... 429

Notes..... 113

Roof luggage rack..... 125

Tie-down eyes..... 123

Loading guidelines..... 113

Loading information table..... 420

Loads..... 113

Locator lighting..... 142

### Locking/unlocking

Automatic locking (MMS)..... 80

Digital Vehicle Key..... 75

Doors (from the inside)..... 77

Emergency key..... 80

KEYLESS-GO..... 78

### Load sound

PRE-SAFE® Sound..... 47

- Low-beam headlamps
  - Activating/deactivating..... 133
- Lubricants..... 447
- Luggage..... 113
- Luggage rack..... 113
- Lumbar support..... 102
- M**
- Maintaining safe distance**
  - Active Distance Assist DISTRONIC..... 236
- Maintaining the headliner**..... 385
- Maintaining the steering wheel**..... 385
- Maintenance**
  - Vehicle..... 24
- Maintenance Management**
  - Notes..... 372
  - Transferred data..... 372
- Malfunction**
  - Restraint system..... 42
- Malfunction message**
  - Driver's display..... 457
- Maneuvering**
  - Drive Away Assist..... 285
  - Maneuvering brake function..... 287
- Maneuvering assistant**
  - Activating/deactivating..... 288
  - Cross traffic warning..... 286
  - Drive Away Assist..... 285
  - Maneuvering brake function..... 287
- Maneuvering brake function**..... 287
- Maneuvering support**..... 286
- Manual gearshifting**
  - Activating/deactivating..... 192
- Map**
  - Displaying online map contents..... 347
  - Displaying weather information..... 347
  - Moving..... 346
  - Selecting the map orientation..... 346
  - Setting the map scale..... 346
- Map functions**..... 346
- Massage programs**..... 105, 106
- Maximum full-stop braking**..... 224
- Maximum load rating**..... 426
- Maximum permissible load**
  - Calculation example..... 422
  - Determining..... 421
- Maximum tire pressure**..... 426
- MBUX**
  - Dashcam..... 349
- MBUX multimedia system**
  - Activating/deactivating DSR..... 242
  - Activating/deactivating standby mode... 221
  - Calling up the zero layer..... 319
  - Drive programs..... 187
  - Factory setting..... 332
  - Home screen..... 321
  - Language settings..... 308, 323
  - Media..... 365
  - Memory Park Assist..... 292
  - Mercedes me & Apps..... 359
  - Notes..... 316
  - Operating the zero layer..... 319
  - Overview..... 316
  - Set collision detection..... 219, 220
  - Setting route-based speed adaptation.... 240
  - Snow chain mode..... 414
  - Standby mode function..... 221
  - Steering wheel heater / seat heating.... 109

- Telephone..... 351
- Touchscreen..... 322
- Zero layer..... 317
- MBUX Voice Assistant**
- E-mails..... 312
- Function..... 308, 323
- Language setting..... 309
- Media voice commands..... 312
- Online voice commands..... 314
- Online voice control..... 311
- Operable functions..... 309
- Operating safety..... 308
- Setting..... 309
- Speech quality..... 310
- Voice commands..... 311
- Voice prompting..... 308, 324
- Mechanical key**
- Inserting/removing..... 73
- Media**
- Overview of functions/symbols..... 365
- Medical aids**..... 31
- Memory function**
- Head-up display..... 112
- Outside mirrors..... 112
- Seat..... 112
- Steering wheel..... 112
- Memory Parking Assist**
- Exiting a parking space..... 291
- Function..... 288
- Parking..... 290
- Recording..... 289
- Setting..... 292
- Menus (driver's display)**
- Notes..... 302
- Sport..... 303
- Mercedes me App**
- Activating on-demand features..... 24
- Mercedes me Apps**..... 359
- Mercedes me calls**
- Arranging a service appointment..... 356
- Calling the Mercedes-Benz customer center after automatic accident/breakdown detection..... 355
- Calls via the overhead control panel..... 354
- Information..... 354
- Mercedes-Benz customer center..... 355
- Transferred data..... 356
- Mercedes me connect**
- Accident/Breakdown Management..... 358
- Information..... 357
- Transferred data..... 359
- Mercedes-AMG vehicles, Notes**..... 162
- Mercedes-Benz emergency call system,**
- Emergency call
- Automatic emergency call..... 362
- Data transfer..... 363
- Information..... 361
- Manual emergency call..... 363
- Overview..... 362
- Mercedes-Benz GenuineParts**..... 22
- Message memory**..... 457
- Messages**
- MBUX voice commands..... 312
- Mirror heater**..... 157
- Mirrors**
- Mirror folding function..... 150
- Outside mirrors..... 147
- Rearview mirror..... 148
- Mobile phone**
- Frequencies..... 444

- Maximum transmission output..... 444
- Notes on wireless charging..... 129
- Wireless charging (front)..... 130
- Model type**..... 445
- Modification**
  - Limited protection..... 51
- Multimedia system**..... 316
- N**
- Navigation**
  - Activating..... 340
  - Destination entry..... 343
  - MBUX voice commands..... 311
  - Notes..... 340
  - Overview..... 341
- Near-field communication (NFC)**
  - Locking/unlocking the vehicle (Digital Vehicle Key)..... 75
  - Starting the vehicle (Digital Vehicle Key)..... 167
- Neutral**..... 190
- Non-operational time**
  - Activating/deactivating standby mode... 221
- Notes on breaking in a new vehicle**..... 169
- O**
- Objects in the vehicle interior**
  - Limited protection..... 51
- Occupant presence reminder**
  - Activating/deactivating..... 70
  - Function..... 70
- Occupant safety**
  - Air bag..... 55
  - Basic information..... 39
  - Child seat..... 56
  - Information on the child restraint system..... 46
  - Information on the correct seat position... 40
  - Occupant presence reminder..... 70
  - Pets in the vehicle..... 51
  - PRE-SAFE®..... 47
- Off-road ABS**..... 224
- Off-road driving**..... 175, 454
- Off-road menu**
  - Overview..... 339
  - Setting..... 339
- On-board diagnostics interface**..... 30
- On-board electronics**
  - Two-way radios..... 443
- On-demand feature**..... 24
- Online services**..... 36
- Open Source Software**..... 38
- Opening angle**
  - Limiting (tailgate)..... 86
- Opening the tailgate using your foot**
  - HANDS-FREE ACCESS..... 84
- Opening/closing a door**..... 217
- Opening/closing a garage door**..... 217
- Operating fluids**
  - Additives..... 449
  - Brake fluid..... 451
  - coolant..... 451
  - Engine oil..... 450
  - Fuel (gasoline)..... 449
  - Notes..... 447
  - Refrigerant (air conditioning system)..... 453
  - Windshield washer fluid..... 452
- Operating safety**
  - 48 V on-board electrical system..... 25

- High-voltage on-board electrical system... 25
- Operator's manual**..... 23
- Operator's Manual digital**..... 20
- Outside mirrors**
- Automatic anti-glare mode..... 148
  - Automatic mirror folding function..... 150
  - Blind Spot Assist / Active Blind Spot Assist..... 261
  - Folding in/out..... 147
  - Memory function..... 112
  - Setting..... 147
  - Warning lamp..... 261
- Overhead control panel**..... 14
- P**
- Paddle shifters**
- Steering wheel paddle shifters..... 191
- Paint code**..... 445
- Panic alarm, Alarm**
- Activating/deactivating..... 72
- Park position**
- DIRECT SELECT lever..... 189
- Parking**
- Active Parking Assist..... 280
  - PARKTRONIC..... 276
- Parking Assist**
- Active Parking Assist..... 280
  - Memory Parking Assist..... 288
  - PARKTRONIC..... 276
- Parking Assist PARKTRONIC**
- Activating/deactivating..... 279
  - Adjusting warning tones..... 279
  - Function..... 276
- Parking assistance systems**
- Active Parking Assist..... 280
  - Drive Away Assist..... 285
  - Maneuvering brake function..... 287
  - Memory Parking Assist..... 288
  - PARKTRONIC..... 276
- Parking brake**..... 217
- Parking for an extended period**..... 221
- Parking lamps**..... 133
- Parking lights**..... 133
- Parking position**
- Exterior mirrors..... 149
  - Storing the position of the front-passenger outside mirror using reverse gear..... 149
- PARKTRONIC**..... 276
- PASSENGER AIR BAG**
- Status display, front passenger air bag..... 44
- Payload**
- Calculation example..... 422
  - Determining the maximum..... 421
- Permitted towing methods**
- Overview..... 404
- Personalization**..... 325
- Pets in the vehicle**..... 51
- Plug-in hybrid operation**
- Charging cable control panel..... 203
  - Charging the high-voltage battery at a rapid charging station (mode 4)..... 201
  - Ending the charging process (alternating current, mode 2/3)..... 208
  - Ending the charging process (direct current, mode 4)..... 211
  - Function of the recuperative brake system..... 181
  - Functions of the energy flow display..... 339



- Haptic accelerator pedal..... 184  
Indicator lamps on vehicle socket..... 204  
Manually disconnecting the high-voltage on-board electrical system..... 164  
Maximum charging current (mains socket)..... 202  
Notes on charging (charging station, mode 3)..... 201  
Notes on charging (mains socket, mode 2)..... 200  
Notes on charging (wallbox, mode 3)..... 201  
Notes on plug-in hybrid operation..... 162  
Operating safety..... 25  
Power meter..... 306  
Route-based operating-mode strategy.... 184  
Sets recuperation..... 181  
Starting the charging process (alternating current, mode 2/3)..... 205  
Starting the charging process (direct current, mode 4)..... 209  
Stowing the charging cable..... 198
- Post-collision brake**..... 49
- Power supply**  
Start/stop button..... 165  
Switching on (start/stop button)..... 165
- Power washer**..... 381
- Pre-entry climate control**  
activating/deactivating for departure time..... 159  
At time of departure..... 158  
For departure time..... 159  
immediate..... 159  
When vehicle is unlocked..... 157
- Pre-heating**..... 157
- PRE-SAFE<sup>®</sup>, Anticipatory occupant protection**  
Function..... 47  
PRE-SAFE<sup>®</sup> Sound..... 47  
Reverting measures..... 48
- PRE-SAFE<sup>®</sup> Impulse Side**  
Function..... 48  
Inflating..... 50
- PRE-SAFE<sup>®</sup> PLUS**  
Backing up measures..... 48  
Function..... 48
- Preventative occupant protection system**..... 47, 48
- Profile**..... 325
- Programs**..... 185
- Protection**  
Limited..... 51
- Protection against collision**  
Maneuvering brake function..... 287
- Protection of the environment**  
Driving style..... 21
- Pulling away**  
Drive Away Assist..... 285  
Hill Start Assist..... 228  
Optimized acceleration..... 170
- Q**
- QR code rescue card**..... 33
- Qualified specialist workshop**..... 31
- R**
- Radar and ultrasonic sensors**..... 222
- Radio**  
MBUX voice commands..... 312
- Radio regulations**  
Regulatory radio identification..... 445
- Rain closing function**  
Sliding sunroof..... 93

- Rain sensor**  
Sliding sunroof..... 93  
Windshield wipers..... 144
- Reading lamp**  
Interior lighting..... 142
- Rear axle steering**..... 174
- Rear door (child safety lock)**  
Securing..... 68
- Rear fog light**..... 134
- Rear passenger compartment climate control**..... 155
- Rear passenger compartment seat belt**  
Status display..... 43
- Rear view camera**  
360° Camera..... 267  
Function..... 267  
Opening the camera cover..... 276
- Rear window defroster**..... 151
- Rear window heating**..... 152
- Rearview mirror**  
Automatic anti-glare mode..... 148
- Rearward-facing child seat**  
Information..... 62
- Recuperation**  
Function..... 181  
Setting..... 181
- Reflective safety vest**..... 389
- Refrigerant**..... 453
- Refueling**  
depressurize the fuel tank (plug-in hybrid with gasoline engine)..... 196  
Fuel..... 193  
Refueling the vehicle..... 193
- Regulatory radio information**  
Specific absorption rate..... 445
- Remote Online**  
Charging the starter battery..... 168  
Cooling/heating the vehicle interior..... 168  
Starting the vehicle..... 169
- Replacement key**..... 75
- Reporting safety defects**..... 32
- Reserve**  
Fuel..... 450
- Resetting**  
MBUX reset function..... 332
- Residual heat**..... 156
- Responsibility**  
Driving safety systems..... 221
- Restraint system**  
Basic information..... 39  
Basic instructions for children..... 56  
Deployment situations..... 50  
Functionality..... 42  
Information on function..... 50  
Information on the correct seat position... 40  
Limited protection..... 51  
Malfunction..... 42  
Protection..... 40  
Self-test..... 42  
Warning lamp..... 42
- Reverse gear**  
DIRECT SELECT lever..... 189
- Reversing camera**  
Activating via GPS..... 275  
Managing activation points..... 275
- Roadside Assistance (breakdown)**..... 25
- Roll away protection**..... 227

- Roller sunblind**  
 Sliding sunroof..... 90
- Roof load display**  
 Information..... 186
- Roof luggage rack**  
 Loading..... 125  
 Securing..... 125
- Route**  
 Alternative route..... 344  
 Calculating..... 344  
 Commuter route..... 344  
 Navigation..... 341  
 Selecting a type..... 344
- Route guidance with augmented reality**  
 Activating..... 344  
 Activating/deactivating the traffic  
 light view..... 260  
 Displaying road names/house num-  
 bers..... 344  
 Switching video on or off..... 344
- Route-based operating-mode strategy**  
 Function..... 184
- Route-based speed adaptation**  
 Function..... 239
- Setting..... 240
- Running boards**  
 Care..... 383  
 Notes..... 81
- S**
- Safety system**..... 223
- Satellite radio**  
 Logging in..... 368  
 Setting music and sport alerts..... 369
- Seat, Through-loading feature**  
 Adjusting (Seat Comfort)..... 99  
 Adjusting electrically..... 101  
 Automatic adjustment..... 104  
 Configuring settings..... 104  
 Correct driver's seat position..... 98  
 Folding back the backrest (rear  
 passenger compartment)..... 119  
 Folding backrest forward (rear)..... 118  
 Locking the backrest (rear passenger  
 compartment)..... 120  
 Lumbar support..... 102  
 Massage programs..... 105  
 Memory function..... 112
- Resetting settings (massage programs).. 106  
 Settings..... 16  
 Side impact air bag..... 55  
 Workout programs..... 105
- Seat belt**  
 Automatic tightening..... 49  
 Rear passenger compartment seat  
 belt status display..... 43  
 Warning lamp..... 43
- Seat belt adjustment**  
 Activating/deactivating..... 49  
 Function..... 49
- Seat belt warning**..... 43
- Seat belts**  
 Activating/deactivating seat belt  
 adjustment..... 49  
 Care..... 385  
 Fastening..... 41  
 Notes on wearing correctly..... 41  
 Releasing..... 55  
 To adjust the height..... 41
- Seat heating**  
 Activating/deactivating..... 106

- Seat ventilation**  
 Activating/deactivating..... 107
- Selecting a gear**..... 191
- Selector lever**..... 189
- Self-test**  
 Automatic front passenger air bag shut-off..... 44  
 Restraint system..... 42
- Sensors**  
 Cleaning..... 383  
 Information..... 222
- Service**..... 371
- Service center**..... 31
- Service due date**..... 371
- Service interval display**..... 371
- Shifting**  
 Automatic transmission..... 191  
 Gearshift recommendation..... 192  
 Manual..... 191  
 Steering wheel paddle shifters..... 191
- Shortening the braking distance**  
 Brake Assist System..... 224
- Shunting assistant**..... 292
- Side impact air bag**..... 55
- Side windows**  
 Child safety lock (rear passenger compartment)..... 69  
 Closing with SmartKey..... 89  
 Convenience closing feature..... 89  
 Convenience opening..... 89  
 Opening with the SmartKey..... 89  
 Opening/closing..... 87  
 Problem..... 90
- Size designation**  
 Tires..... 427
- Skid chains**..... 414
- Sliding sunroof, Panorama roof with power tilt/sliding panel**  
 Automatic functions..... 93  
 Closing with SmartKey..... 89  
 Opening with the SmartKey..... 89  
 Opening/closing..... 90  
 Problem..... 93  
 Rain closing function..... 93
- SmartKey**  
 Acoustic locking verification signal..... 72
- Battery**..... 73  
 Deactivating a function..... 72  
 Function..... 71  
 Key ring attachment..... 73  
 Mechanical key..... 73  
 Panic alarm..... 72  
 Power consumption..... 72  
 Unlocking setting..... 72
- Smartphone Integration, iPhone®**  
 Android Auto..... 360  
 Apple CarPlay®..... 360
- Snow chain mode**..... 414
- Snow chains**..... 414
- Socket**  
 12 V..... 128
- Socket flap**..... 196
- Software update**..... 329
- SOS button**..... 354
- Sound**  
 Menu..... 369  
 PRE-SAFE® Sound..... 47  
 Wheels/tires..... 413
- Sound settings**..... 369

- Spare parts..... 22
- Spare wheel, Emergency spare wheel..... 441
- Special seat belt retractor..... 64
- Specialist workshop..... 31
- Specific absorption rate (SAR)..... 445
- Speed
  - Save, cruise control..... 236
  - Save, DISTRONIC..... 236
- Speed adaptation, Route-based..... 239
- Speed control
  - Active Distance Assist DISTRONIC..... 233
  - Cruise control..... 231
- Speed rating
  - Tires..... 427
- Start-off assist
  - Drive Away Assist..... 285
  - Hill Start Assist..... 228
  - Optimized acceleration..... 170
- Start/stop button
  - Parking the vehicle..... 213
  - Starting the vehicle..... 166
  - Switching on the power supply / vehicle..... 165
- Start/stop function..... 177
- Starter battery
  - charging, Remote Online..... 168
- Starting
  - Remote Online..... 169
  - Start/stop button..... 166
- Starting assistance..... 401
- Starting the engine
  - Emergency operation mode..... 167
  - Remote Online..... 169
  - Start/stop button..... 166
- Starting-off aid
  - Drive Away Assist..... 285
  - Hill Start Assist..... 228
  - Optimized acceleration..... 170
- Status display
  - Front passenger air bag..... 44
  - Rear passenger compartment seat belt... 43
- Steer Assist
  - Active Steering Assist..... 242
  - STEER CONTROL..... 227
- STEER CONTROL..... 227
- Steering
  - Rear axle steering..... 174
- Steering wheel
  - Adjusting electrically..... 108
  - Driver's air bag..... 55
  - Manually adjusting..... 107
  - Memory function..... 112
- Steering wheel adjustments..... 108
- Steering wheel heating
  - Decoupling from the seat heating..... 109
- Steering wheel paddle shifters..... 191
- Step..... 81
- Stop and go
  - ECO start/stop function..... 178
- Stopping
  - Parking the vehicle..... 213
- Stowage areas..... 116
- Stowage spaces
  - Armrest (front)..... 116
  - Center console (front)..... 116
  - Door..... 116
  - Glove box..... 116
- Substances hazardous to health..... 25

- Sulfur content**..... 449
- Switch-off delay time**  
 Exterior..... 142  
 Interior..... 144
- Switching air-recirculation mode on/off**..... 156
- System settings**  
 MBUX reset function..... 332  
 Overview..... 328
- T**
- Tailgate, Trunk lid**  
 Closing..... 82  
 Emergency key..... 87  
 HANDS-FREE ACCESS..... 84  
 Limiting the opening angle..... 86  
 Opening..... 81
- Tank capacity**  
 Fuel..... 450  
 Reserve..... 450
- Tank filler cap / flap**..... 193
- Technical data**  
 Axle load (trailer operation)..... 456  
 Fastening points of the trailer hitch..... 455
- Information..... 443  
 Mounting dimensions of a trailer hitch.... 455  
 Overhang dimension of the trailer hitch.. 455  
 Radio frequencies..... 444  
 Radio regulations..... 445  
 Specific absorption rate (SAR)..... 445  
 Tongue weight..... 456  
 Towing capacity..... 455  
 Vehicle dimensions..... 454
- Telediagnosis**  
 Diagnostic data..... 372
- Telediagnosics**  
 Transferred data..... 373
- Telemetry display**..... 336
- Telephone, Smartphone**  
 Bluetooth®..... 353  
 Connecting a mobile phone..... 353  
 MBUX voice commands..... 312  
 Menu..... 353  
 Notes..... 351  
 Notes on wireless charging (mobile phone)..... 129  
 Operating modes..... 353  
 Secure Simple Pairing..... 353
- Telephone menu overview..... 353  
 Wirelessly charging a (mobile phone, front)..... 130
- Telephony operating modes**  
 Bluetooth® telephony..... 353
- Television, Digital TV**  
 MBUX voice commands..... 312
- Temperature**  
 Adjusting..... 152  
 Setting..... 151
- Temperature grade**..... 424
- Text messages**..... 312
- THERMATIC**  
 Air conditioning control panel..... 151
- THERMOTRONIC**  
 Air conditioning control panel..... 152
- Tie-down eyes**..... 123
- TIN (Tire Identification Number)**..... 425
- Tire and Loading Information placard**..... 420
- Tire characteristics**..... 427
- Tire information table**..... 420

- Tire labeling**
  - Characteristics..... 427
  - DOT, Tire Identification Number (TIN)..... 425
  - Load index..... 427
  - Load-bearing capacity..... 427
  - Maximum tire load..... 426
  - Maximum tire pressure..... 426
  - Size designation..... 427
  - Speed rating..... 427
  - Temperature grade..... 424
  - Tire Quality Grading..... 424
  - Traction grade..... 424
  - Tread wear grade..... 424
- Tire pressure**
  - Checking..... 418
  - Checking manually..... 417
  - Maximum..... 426
  - Notes..... 414
  - Tire pressure table..... 416
  - TIREFIT kit..... 392
- Tire pressure monitor**
  - Function..... 417
- Tire pressure monitoring system**
  - Restarting..... 419
- Tire pressure table**..... 416
- Tire Quality Grading**..... 424
- Tire sealant**..... 392
- Tire tread**..... 413
- Tire-change tool**..... 435
- Tire-change tool kit**..... 435
- TIREFIT kit, Tire inflation compressor**
  - Storage location..... 391
- Tires**
  - Breakdown..... 390
  - Characteristics..... 427
  - Checking..... 413
  - Checking the tire pressure manually..... 417
  - Definitions..... 429
  - DOT, Tire Identification Number (TIN)..... 425
  - Installing..... 439
  - Labeling..... 424
  - Load index..... 427
  - Load-bearing capacity..... 427
  - Maximum pressure..... 426
  - Maximum tire load..... 426
  - Noise..... 413
  - Notes on installing..... 431
  - Removing..... 439
- Removing/installing hub cap..... 436
- Replacing..... 431, 436
- Rotating..... 434
- Selecting..... 431
- Size designation..... 427
- Snow chains..... 414
- Speed rating..... 427
- Storing..... 435
- Temperature grade..... 424
- Tire and Loading Information placard..... 420
- Tire pressure table..... 416
- Tire Quality Grading..... 424
- TIREFIT kit..... 392
- Traction grade..... 424
- Tread wear grade..... 424
- Unusual handling characteristics..... 413
- Toll system**
  - Debiting toll fees..... 341
- Tongue weight**..... 456
- Top Tether**..... 66
- Topographical compensation, Predictive**
  - headlamp range control..... 136
- Torque (driver's display)**..... 303

<b>Touch Control</b>			
Driver's display.....	301		
MBUX.....	322		
<b>Touch-sensitive controls</b> .....	23		
<b>Touchscreen</b> .....	322		
<b>Tow bar system</b>			
Towing away.....	299		
<b>Tow-away protection</b> .....	96		
<b>Tow-starting</b> .....	409		
<b>Towing</b>			
Towing methods.....	404		
<b>Towing a trailer</b>			
Active Lane Keeping Assist.....	264		
Axle load.....	456		
Notes.....	296		
<b>Towing eye</b>			
Storage location.....	408		
<b>Towing methods</b>			
Both axles on the ground.....	405		
Overview.....	404		
<b>Track Race</b> .....	333		
<b>Traction grade</b> .....	424		
<b>Traffic information</b> .....	347		
Using.....	294		
<b>Traffic Jam Assistant</b> .....	240		
<b>Traffic light view</b>			
Activating/deactivating.....	260		
Information.....	260		
<b>Traffic light warning/display</b> .....	256		
<b>Traffic Sign Assist</b>			
Function.....	256		
Setting.....	260		
<b>Trailer drawbar, Pulling/towing</b> .....	299		
<b>Trailer hitch</b>			
Attaching the ball neck.....	297		
Axle load.....	456		
Care.....	383		
Coupling up/uncoupling a trailer.....	298		
Fastening points.....	455		
General notes.....	455		
Mounting dimensions.....	455		
Overhang dimension.....	455		
Tongue weight.....	456		
Towing capacity.....	455		
Trailer Maneuvering Assist.....	292		
<b>Trailer Maneuvering Assist</b>			
Function.....	292		
<b>Trailer operation</b>			
Active Blind Spot Assist.....	263		
Attaching the ball neck.....	297		
Coupling up/uncoupling a trailer.....	298		
Setting.....	299		
<b>Trailer stabilization</b> .....	226		
<b>Transmission position display</b> .....	189		
<b>Transmission positions</b>			
DIRECT SELECT lever.....	189		
<b>Transporting</b>			
Vehicle.....	407		
<b>Tread wear grade</b> .....	424		
<b>Turn signal indicator</b> .....	134		
<b>Turn signals</b> .....	134		
<b>TV</b>			
MBUX voice commands.....	312		
<b>Two-way radios</b>			
Frequencies.....	444		
Installation.....	443		
Transmission output.....	444		



**U**



















<b>Unfastening</b> .....	55
<b>Unlocking setting</b> .....	72
<b>Updates</b> .....	329
<b>USB port</b>	
Rear passenger compartment.....	129
Storage compartments (front).....	116
<b>User profiles</b>	
Adding a user.....	326
Note.....	325
Selecting options.....	326

















**V**

<b>Valet service mode</b>	
Activating/deactivating.....	229
Function.....	229
<b>Vehicle, Switching on the ignition</b>	
48 V on-board electrical system.....	25
Activating, Remote Online.....	169
Activating/deactivating standby mode...	221
Correct use.....	31
Data storage.....	34
Diagnostics connection.....	30

Emergency key.....	80
Equipment.....	23
High-voltage on-board electrical system...	25
KEYLESS-GO.....	78
Limited Warranty.....	33
lock automatically (MMS).....	80
Locking/unlocking (Digital Vehicle Key)....	75
Locking/unlocking (emergency key).....	80
Locking/unlocking (from inside).....	78
Lowering.....	440
Maintenance.....	24
Medical aids.....	31
Parking.....	213
Parking for an extended period.....	221
Problem notification.....	32
Pulling.....	299
QR code rescue card.....	33
Raising.....	437
Set collision detection.....	219, 220
Standby mode function.....	221
Starting (Digital Vehicle Key).....	167
Starting (start/stop button).....	166
starting, emergency operation mode.....	167
Stopping.....	213
Switching off (start/stop button).....	213
Switching on (start/stop button).....	165

Towing away.....	404
Transporting.....	407
Ventilating / comfort opening.....	89
Voice commands for MBUX voice assistant.....	313
<b>Vehicle cameras</b> .....	222
<b>Vehicle data</b>	
Angle of approach/departure.....	454
Display, MBUX.....	188
Displaying, DYNAMIC SELECT.....	188
Fording water.....	454
Turning circle.....	454
Vehicle height.....	454
Vehicle length.....	454
Vehicle width.....	454
Wheelbase.....	454
<b>Vehicle dimensions</b> .....	454
<b>Vehicle emergency start</b> .....	409
<b>Vehicle equipment</b> .....	23
<b>Vehicle identification number</b> .....	445
<b>Vehicle identification plate</b>	
Model type.....	445
Paint code.....	445
VIN.....	445

- Vehicle interior**  
Cooling/heating (Remote Online)..... 168
- Vehicle key**..... 71
- Vehicle operation outside the USA or Canada**..... 24
- Vehicle sensors**..... 222
- Vehicle socket**  
Care..... 383  
Emergency release of the socket flap..... 211  
Indicator lamps..... 204
- Vehicle start**  
Emergency operation mode..... 167  
Remote Online..... 169  
Start/stop button..... 166
- Vehicle tool kit**  
TIREFIT kit..... 391  
Towing eye..... 408
- Ventilating**..... 89
- Ventilation**..... 160
- Vents**  
Air vents..... 160
- VIN**  
Engine compartment..... 445
- Identification plate..... 445  
Seat..... 445
- Vision**  
Defrosting windows..... 156
- Voice assistant**  
Voice prompting..... 308, 324
- W**
- Warning system**..... 94
- Warning triangle**..... 390
- Warning/indicator lamp**  
 ABS warning lamp..... 545  
 Active Brake Assist warning lamp..... 548  
 ATTENTION ASSIST warning lamp..... 547  
 Brakes warning lamp (Canada only)..... 544  
 Brakes warning lamp (USA only)... 544  
 Brakes warning lamp (yellow) (Canada only)..... 543
-  Check Engine warning lamp..... 540  
 Coolant warning lamp (red)..... 538  
 Coolant warning lamp (yellow)..... 539  
 Distance warning lamp..... 547  
 Electric parking brake indicator lamp (red) (Canada only)..... 542  
 Electric parking brake indicator lamp (red) (USA only)..... 542  
 Electric parking brake indicator lamp (yellow)..... 542  
 Electrical malfunction warning lamp..... 536, 540  
 Engine operating temperature warning lamp..... 540  
 ESP® OFF warning lamp..... 546  
 ESP® warning lamp flashes..... 545  
 ESP® warning lamp lights up..... 546  
 Fuel reserve warning lamp flashes..... 541

-  Fuel reserve warning lamp lights up..... 541
  -  Mercedes-Benz emergency call system warning lamp..... 549
  -  Occupant presence reminder warning lamp (white)..... 534
  -  Occupant presence reminder warning lamp (yellow)..... 535
  -  Power steering warning lamp (red)..... 536
  -  Power steering warning lamp (yellow)..... 536
  -  RBS warning lamp (USA only)..... 543
  -  Rear axle steering warning lamp (red)..... 537
  -  Rear axle steering warning lamp (yellow)..... 537
  -  Reduced warning lamp power..... 535
  -  Restraint system warning lamp..... 533
  -  Seat belt warning lamp flashes..... 534
  -  Seat belt warning lamp lights up... 534
  -  System malfunction warning lamp..... 535
  -  Tire pressure monitoring system warning lamp flashes..... 549
  -  Tire pressure monitoring system warning lamp lights up..... 550
  -  Traffic Sign Assist warning lamp... 547
- Warning/indicator lamps**
- Driver's display..... 531
  - PASSENGER AIR BAG..... 44
- Washer fluid**
- Topping up..... 378
  - Windshield washer fluid..... 452
- Washing by hand**..... 382
- Water tank**..... 379
- Wear**
- Limited protection..... 51
- Weather information**..... 347
- Web browser**..... 360
- Weight information**..... 445
- Wheel change**
- Installing a new wheel..... 439
  - Lowering the vehicle..... 440
  - Removing a wheel..... 439
  - Removing/installing hub caps..... 436
- Wheel rotation**..... 434
- Wheels**
- Breakdown..... 390
  - Care..... 383
  - Checking..... 413
  - Checking the tire pressure manually..... 417
  - Definitions..... 429
  - DOT, Tire Identification Number (TIN)..... 425
  - Installing..... 439
  - Load index..... 427
  - Load-bearing capacity..... 427
  - Maximum tire load..... 426
  - Maximum tire pressure..... 426
  - Noise..... 413
  - Notes on installing..... 431
  - Removing..... 439
  - Removing/installing hub cap..... 436
  - Replacing..... 431, 436
  - Rotating..... 434
  - Selecting..... 431

- Size designation..... 427
  - Snow chains..... 414
  - Speed rating..... 427
  - Storing..... 435
  - Temperature grade..... 424
  - Tire and Loading Information placard..... 420
  - Tire characteristics..... 427
  - Tire labeling..... 424
  - Tire pressure..... 414
  - Tire pressure monitor..... 417
  - Tire Quality Grading..... 424
  - TIREFIT kit..... 392
  - Traction grade..... 424
  - Tread wear grade..... 424
  - Unusual handling characteristics..... 413
  - Wi-Fi**
    - Setting up a hotspot..... 330
  - Window curtain air bag**..... 55
  - Windows**
    - Care..... 383
    - Convenience opening..... 89
    - De-icing..... 154
    - Opening with the SmartKey..... 89
    - Opening/closing..... 87
    - Removing mist..... 156
  - Windshield**
    - De-icing..... 154
    - Defrosting..... 151
    - Demisting..... 152
  - Windshield washer fluid**..... 452
  - Windshield washer system**..... 378
  - Windshield wipers**
    - Activating/deactivating..... 144
    - Replacing the wiper blades..... 144
    - Replacing the wiper blades (windshield)..... 144
  - Winter operation**
    - Activating/deactivating snow chain mode..... 414
    - Snow chains..... 414
  - Wiper blades**
    - Care..... 383
    - Replacing (windshield)..... 144
  - Wipers**..... 144
  - Wireless charging**
    - Mobile phone (front)..... 130
    - Notes..... 129
  - Workout programs**..... 105
  - Workshop**..... 31
- Z**
- Zero layer**
    - Function..... 317
    - Overview..... 318



